



PHOTOS EXHIBIT

Report Number: R13916296-EP1

Applicant : Ademco Inc.
251 Little Falls Drive
Wilmington, DE, 19808, USA

Model : ADTZWMX

FCC ID : CFS8DLWFZWX

IC : 573F-WFZWX

EUT Description : Radio Module

Test Standard(s) : FCC 47 CFR PART 15 SUBPART C: 2021
ISED RSS-247 ISSUE 2: 2017
ISED RSS-210 Issue 10: 2019
ISED RSS-GEN ISSUE 5 + Amendment 2: 2021

Date Of Issue:
2021-08-31

Prepared by:
UL LLC
12 Laboratory Dr.
Research Triangle Park, NC 27709 U.S.A.
TEL: (919) 549-1400



REPORT REVISION HISTORY

Rev.	Issue Date	Revisions	Revised By
V1	2021-08-31	Initial Issue	Haley Ackun
			-
			-

TABLE OF CONTENTS

REPORT REVISION HISTORY.....	2
TABLE OF CONTENTS.....	3
1. SETUP DIAGRAM	4
2. SETUP PHOTOS	5
END OF PHOTOS EXHIBIT.....	11

1. SETUP DIAGRAM

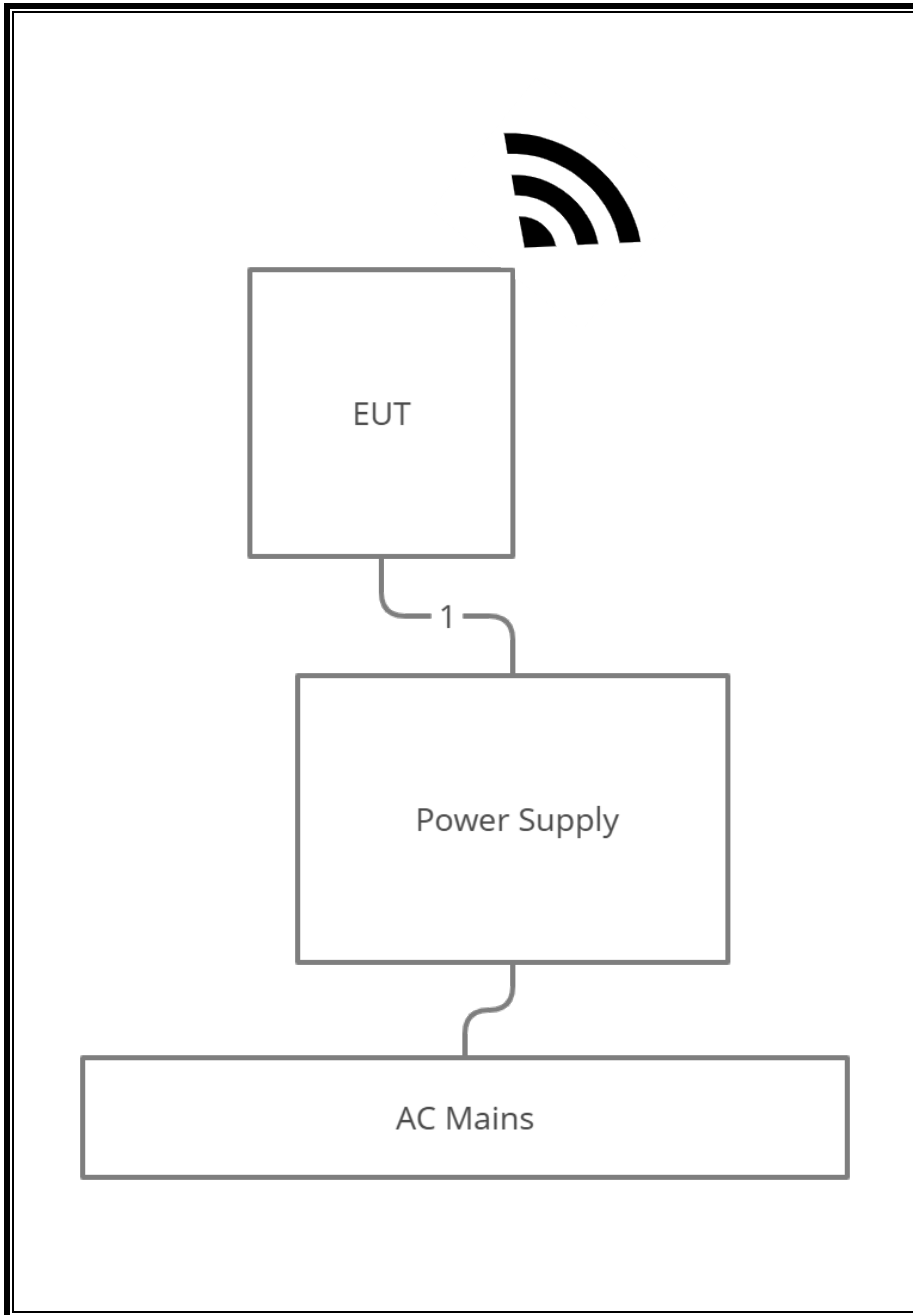

2. SETUP PHOTOS

RADIATED RF MEASUREMENT SETUP

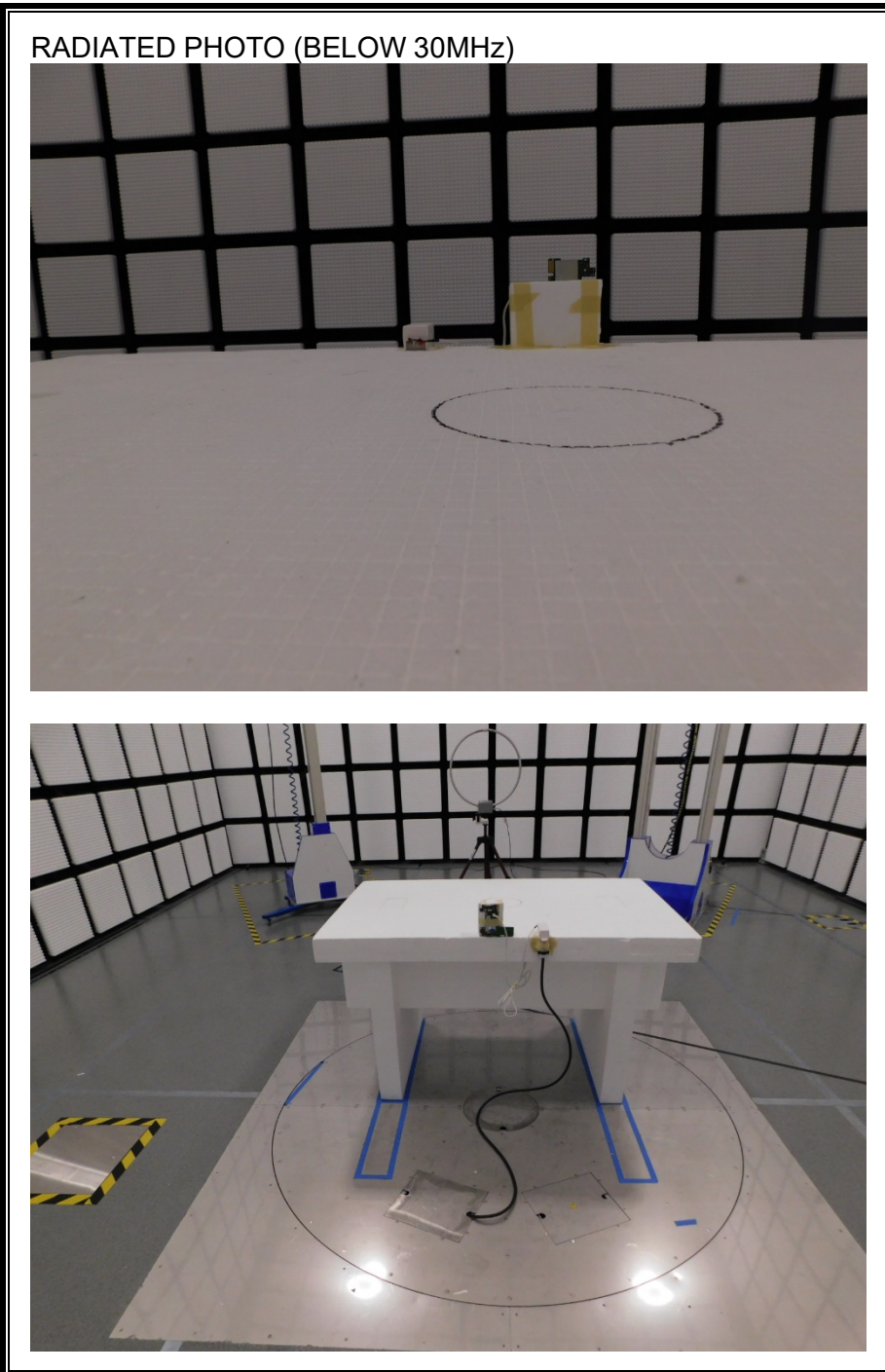

RADIATED PHOTO (BELOW 30MHz)

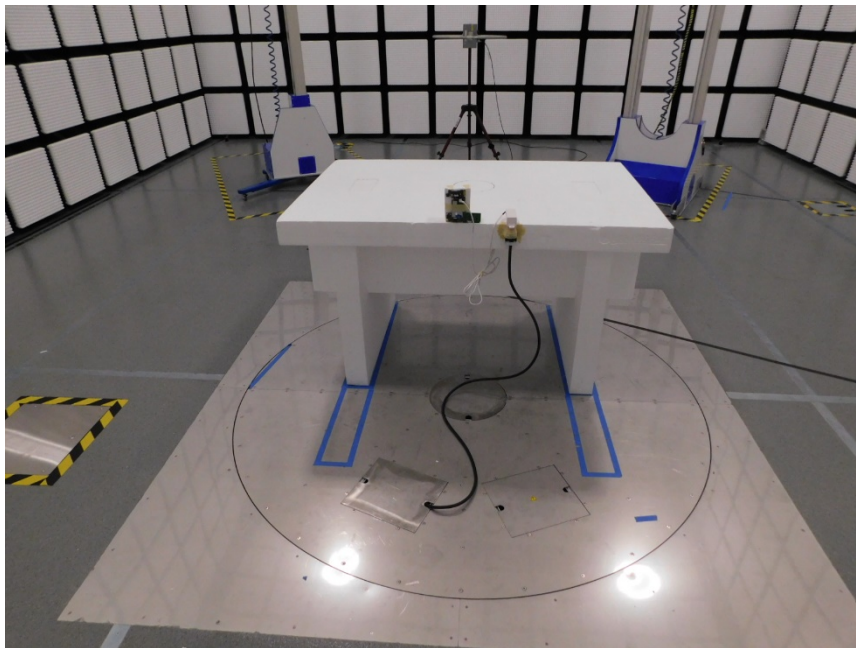
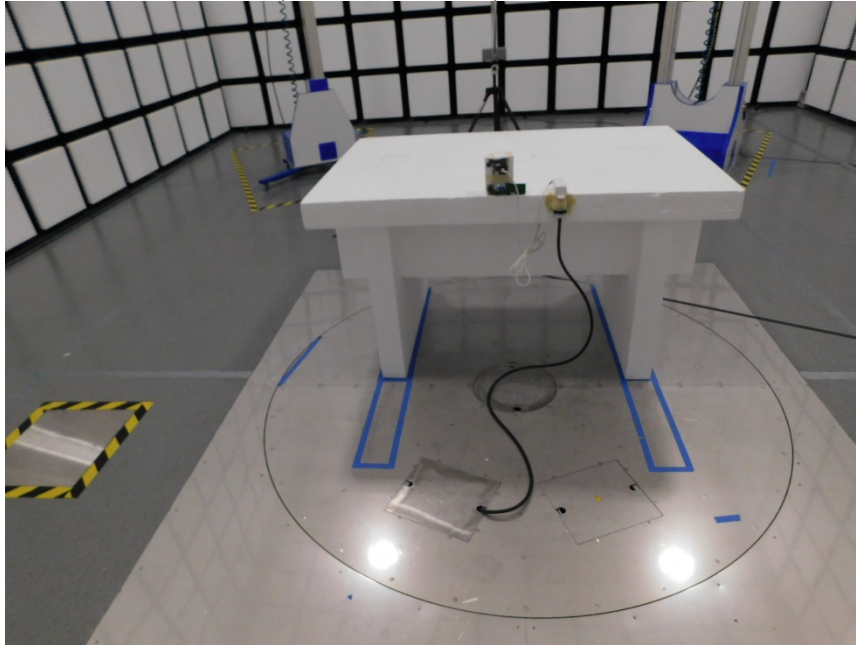

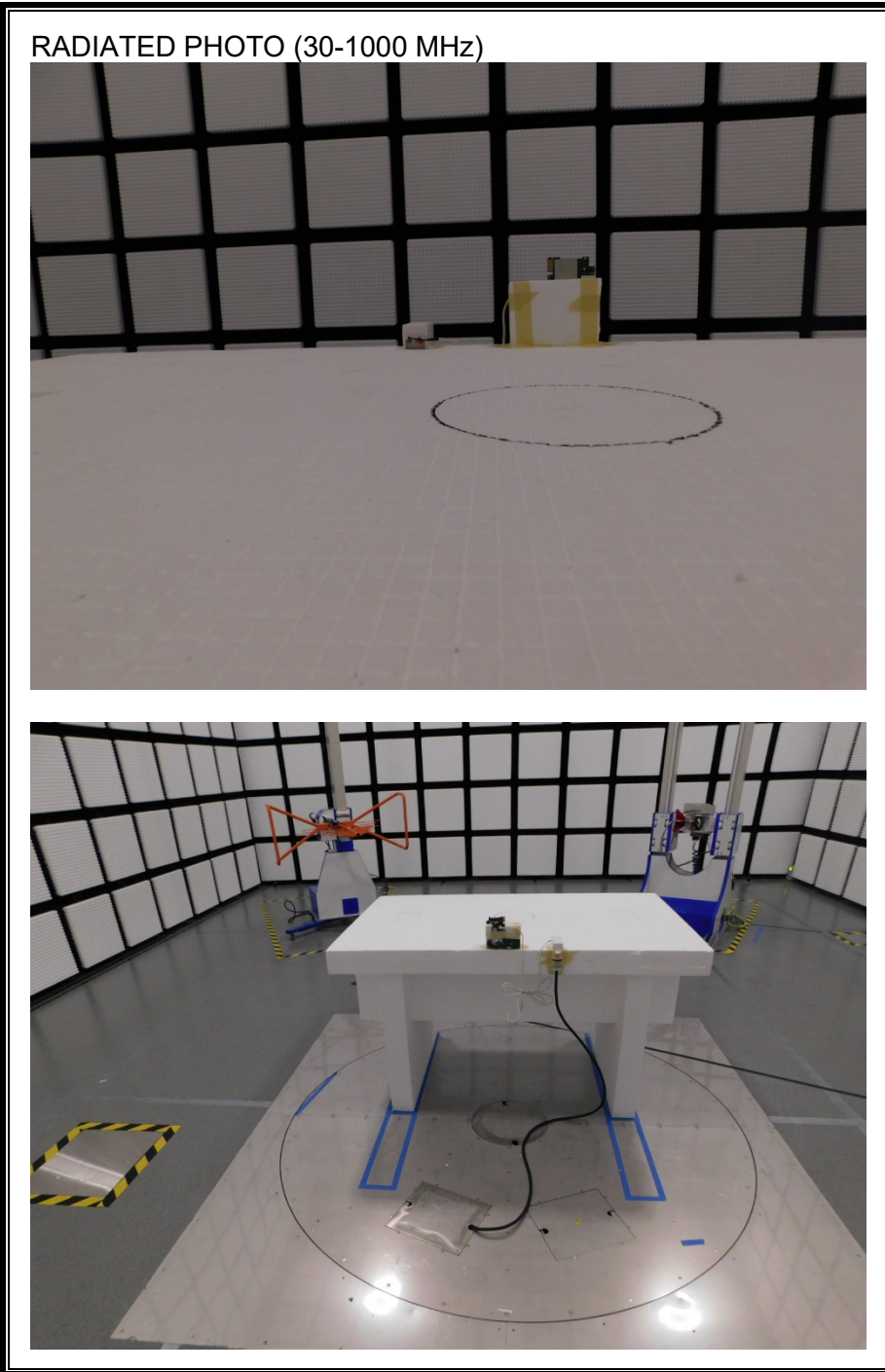

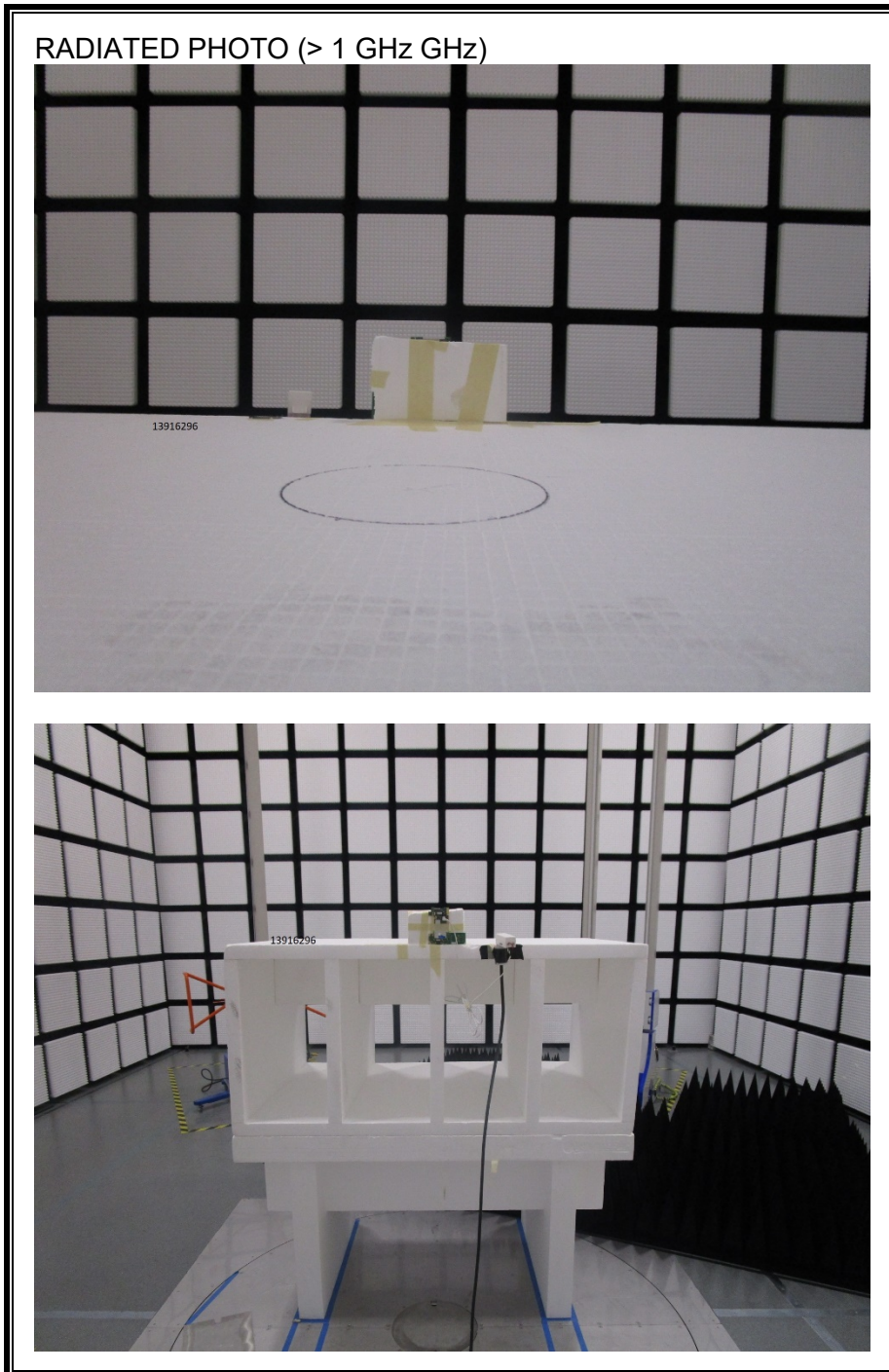

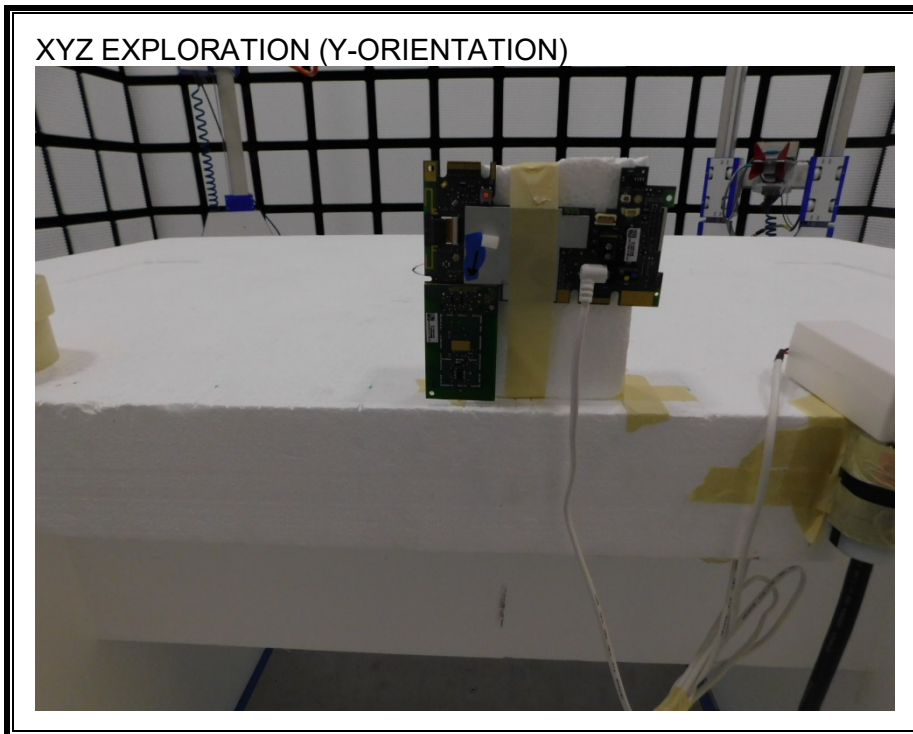
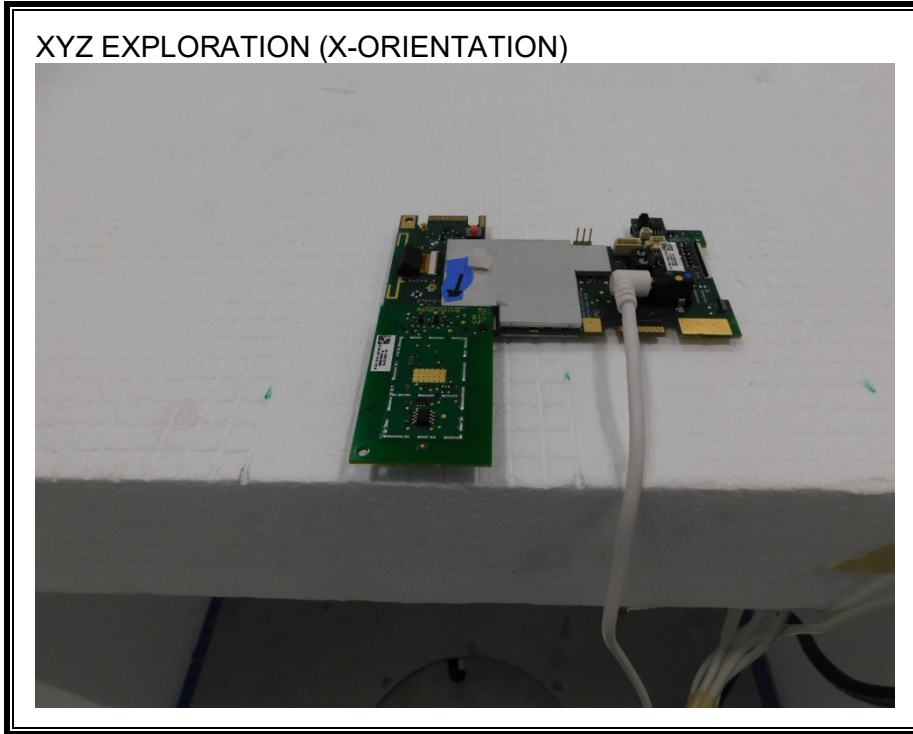

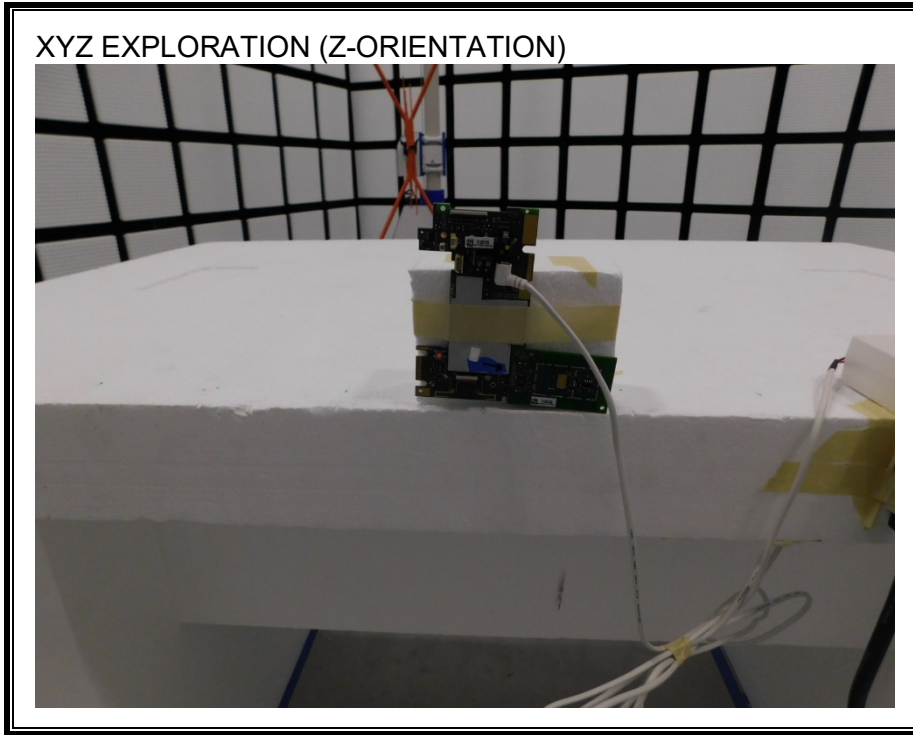

AC LINE CONDUCTED PHOTOS

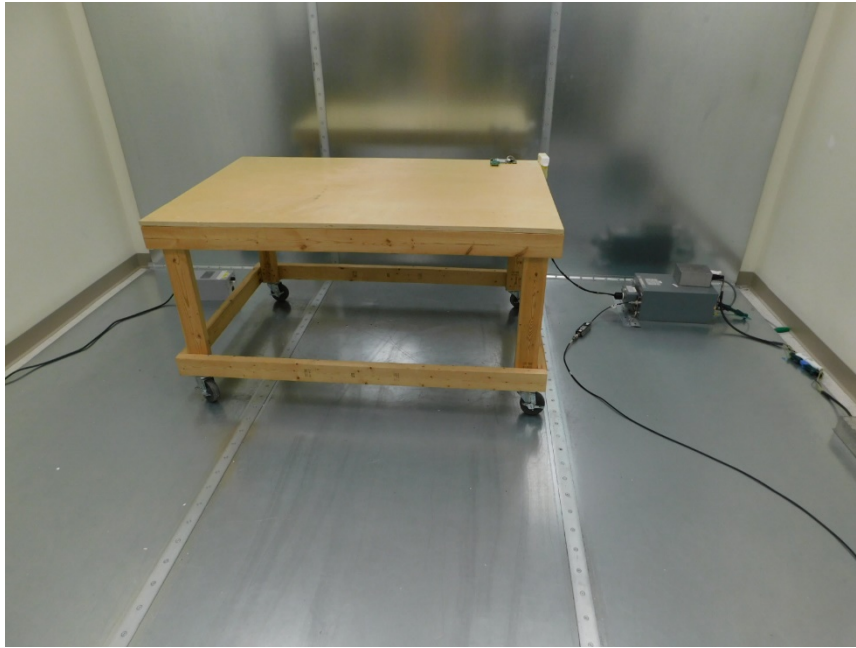

END OF PHOTOS EXHIBIT