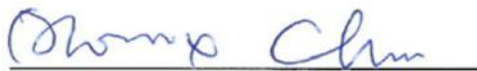

# FCC Test Report

**Equipment** : HD Wi-Fi Outdoor Camera  
**Brand Name** : Honeywell  
**Model No.** : IPCAM-WOC1  
**FCC ID** : CFS8DLIPCAMWOC1  
**Standard** : 47 CFR FCC Part 15.247  
**Frequency** : 2400 MHz – 2483.5 MHz  
**Function** :  Point-to-multipoint;  Point-to-point  
**Applicant** : Honeywell International Inc.  
2 Corporate Center Drive, Melville New York 11747  
United States  
**Manufacturer** : EDIMAX TECHNOLOGY CO., LTD.  
No.278, Xinhua 1st Rd., Neihu Dist., Taipei City, Taiwan

The product sample received on Aug. 29, 2017 and completely tested on Sep. 13, 2017. We, SPORTON, would like to declare that the tested sample has been evaluated in accordance with the procedures given in ANSI C63.10-2013 and shown compliance with the applicable technical standards.

The test results in this report apply exclusively to the tested model / sample. Without written approval of SPORTON INTERNATIONAL INC., the test report shall not be reproduced except in full.

  
Phoenix Chen / Assistant Manager





# Table of Contents

- 1 GENERAL DESCRIPTION .....5**
- 1.1 Information.....5
- 1.2 Testing Applied Standards .....6
- 1.3 Testing Location Information .....6
- 1.4 Measurement Uncertainty .....6
- 2 TEST CONFIGURATION OF EUT.....7**
- 2.1 Test Condition .....7
- 2.2 Test Channel Mode .....7
- 2.3 The Worst Case Measurement Configuration.....8
- 2.4 Accessories .....9
- 2.5 Support Equipment.....9
- 2.6 Test Setup Diagram .....10
- 3 TRANSMITTER TEST RESULT .....12**
- 3.1 AC Power-line Conducted Emissions .....12
- 3.2 DTS Bandwidth.....13
- 3.3 Maximum Conducted Output Power .....14
- 3.4 Power Spectral Density .....16
- 3.5 Emissions in Non-restricted Frequency Bands .....17
- 3.6 Emissions in Restricted Frequency Bands.....18
- 4 TEST EQUIPMENT AND CALIBRATION DATA .....22**

**APPENDIX A. TEST RESULTS OF AC POWER-LINE CONDUCTED EMISSIONS**

**APPENDIX B. TEST RESULTS OF DTS BANDWIDTH**

**APPENDIX C. TEST RESULTS OF MAXIMUM CONDUCTED OUTPUT POWER**

**APPENDIX D. TEST RESULTS OF POWER SPECTRAL DENSITY**

**APPENDIX E. TEST RESULTS OF EMISSIONS IN NON-RESTRICTED FREQUENCY BANDS**

**APPENDIX F. TEST RESULTS OF EMISSIONS IN RESTRICTED FREQUENCY BANDS**

**APPENDIX G. TEST PHOTOS**

**PHOTOGRAPHS OF EUT V01**



### Summary of Test Result

Conformance Test Specifications				
Report Clause	Ref. Std. Clause	Description	Limit	Result
1.1.2	15.203	Antenna Requirement	FCC 15.203	Complied
3.1	15.207	AC Power-line Conducted Emissions	FCC 15.207	Complied
3.2	15.247(a)	DTS Bandwidth	≥500kHz	Complied
3.3	15.247(b)	Maximum Conducted Output Power	Power [dBm]:30	Complied
3.4	15.247(e)	Power Spectral Density	PSD [dBm/3kHz]:8	Complied
3.5	15.247(d)	Emissions in Non-restricted Frequency Bands	Non-Restricted Bands: >30 dBc	Complied
3.6	15.247(d)	Emissions in Restricted Frequency Bands	Restricted Bands: FCC 15.209	Complied



### Revision History

Report No.	Version	Description	Issued Date
FR782811AL	Rev. 01	Initial issue of report	Nov. 07, 2017



# 1 General Description

## 1.1 Information

### 1.1.1 RF General Information

Frequency Range (MHz)	Bluetooth Mode	Ch. Frequency (MHz)	Channel Number
2400-2483.5	LE	2402-2480	0-39 [40]

Band	Mode	BWch (MHz)	Nant
2.4-2.4835GHz	BT-LE(1Mbps)	1	1TX

Note:

- ♦ Bluetooth LE uses a GFSK (1Mbps) modulation for DSSS.
- ♦ BWch is the nominal channel bandwidth.

### 1.1.2 Antenna Information

Ant.	Port	Brand	Model Name	Antenna Type	Connector	Gain (dBi)
1	1	ATL	11PCB0-130245	PCB	I-PEX	2

### 1.1.3 EUT Information

Operational Condition	
EUT Power Type	From AC Adapter
Type of EUT	
<input checked="" type="checkbox"/>	Stand-alone
<input type="checkbox"/>	Combined (EUT where the radio part is fully integrated within another device)
	Combined Equipment - Brand Name / Model No.: ...
<input type="checkbox"/>	Plug-in radio (EUT intended for a variety of host systems)
	Host System - Brand Name / Model No.: ...
<input type="checkbox"/>	Other:

### 1.1.4 Mode Test Duty Cycle

Mode	DC	DCF(dB)	T(s)	VBW(Hz) ≥ 1/T
BT-LE(1Mbps)	0.642	1.925	401.25u	3k

## 1.2 Testing Applied Standards

According to the specifications of the manufacturer, the EUT must comply with the requirements of the following standards:

- ◆ 47 CFR FCC Part 15
- ◆ ANSI C63.10-2013
- ◆ KDB 558074 D01 v04

## 1.3 Testing Location Information

Testing Location		
<input checked="" type="checkbox"/>	HWA YA	ADD : No. 52, Huaya 1st Rd., Guishan Dist., Taoyuan City, Taiwan (R.O.C.) TEL : 886-3-327-3456      FAX : 886-3-327-0973
Test site Designation No. TW1190 with FCC.		
<input type="checkbox"/>	JHUBEI	ADD : No.8, Ln. 724, Bo'ai St., Zhubei City, Hsinchu County, Taiwan (R.O.C.) TEL : 886-3-656-9065      FAX : 886-3-656-9085
Test site Designation No. TW0006 with FCC.		

Test Condition	Test Site No.	Test Engineer	Test Environment	Test Date
RF Conducted	TH01-HY	Lisa	24.5°C / 63.5%	08/Jun/2017
Radiated	03CH03-HY	Jeff	23.5°C / 65%	13/Sep/2017
AC Conduction	CO04-HY	Bear	24.1°C / 54%	13/Sep/2017

## 1.4 Measurement Uncertainty

ISO/IEC 17025 requires that an estimate of the measurement uncertainties associated with the emissions test results be included in the report. The measurement uncertainties given below are based on a 95% confidence level (based on a coverage factor (k=2))

Test Items	Uncertainty	Remark
Conducted Emission (150kHz ~ 30MHz)	3.6 dB	Confidence levels of 95%
Radiated Emission (30MHz ~ 1,000MHz)	2.1 dB	Confidence levels of 95%
Radiated Emission (1GHz ~ 18GHz)	2.6 dB	Confidence levels of 95%
Radiated Emission (18GHz ~ 40GHz)	2.9 dB	Confidence levels of 95%
Conducted Emission	1.3 dB	Confidence levels of 95%



## 2 Test Configuration of EUT

### 2.1 Test Condition

RF Conducted	Abbreviation	Remark
TnomVnom	Tnom	20°C
-	Vnom	120V

### 2.2 Test Channel Mode

Test Software	RTLBTAPP
---------------	----------

Mode	Power Setting
BT-LE(1Mbps)	-
2402MHz	7
2440MHz	7
2480MHz	7

### 2.3 The Worst Case Measurement Configuration

The Worst Case Mode for Following Conformance Tests	
Tests Item	AC power-line conducted emissions
Condition	AC power-line conducted measurement for line and neutral
Operating Mode	CTX
1	Adapter mode

The Worst Case Mode for Following Conformance Tests	
Tests Item	DTS Bandwidth Maximum Conducted Output Power Power Spectral Density Emissions in Non-restricted Frequency Bands
Test Condition	Conducted measurement at transmit chains

The Worst Case Mode for Following Conformance Tests	
Tests Item	Emissions in Restricted Frequency Bands
Test Condition	Radiated measurement If EUT consist of multiple antenna assembly (multiple antenna are used in EUT regardless of spatial multiplexing MIMO configuration), the radiated test should be performed with highest antenna gain of each antenna type.
Operating Mode < 1GHz	CTX
1	Adapter mode
Operating Mode > 1GHz	CTX
Orthogonal Planes of EUT	<b>Z Plane</b>
	
Worst Planes of EUT	V





## 2.4 Accessories

Accessories				
AC Adapter	Brand Name	DVE	Model Name	DSA-24PFM-12 FUS
	Power Rating	I/P: 100- 240 Vac, 0.8 A, O/P: 12 Vdc, 2 A		
	Power Cord	2.4 meter, non-shielded cable, w/o ferrite core		
Extend cable for Adapter	Cable	2.45 meter, non-shielded cable, w/o ferrite core		
Extend cable(for DC 12V)	Cable	0.13 meter, non-shielded cable, w/o ferrite core		

## 2.5 Support Equipment

Support Equipment - RF Conducted				
No.	Equipment	Brand Name	Model Name	FCC ID
1	Notebook	DELL	E5410	DOC
2	Adapter for NB	DELL	HA65NM130	DOC

## 2.6 Test Setup Diagram

Test Setup Diagram – AC Line Conducted Emission Test

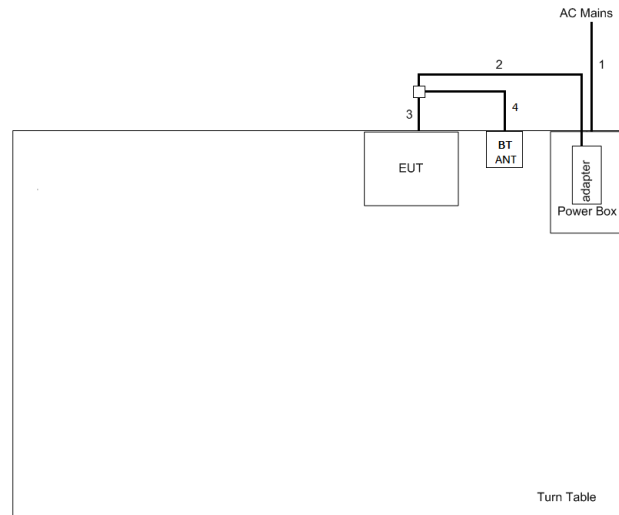

Item	Connection	Shielded	Length(m)	Remark
1	AC Power Line	No	1.8	-
2	DC Power Line	No	2.4	-
3	RF cable	No	0.5	-
4	ANT cable	No	0.2	-

Test Setup Diagram - Radiated Test

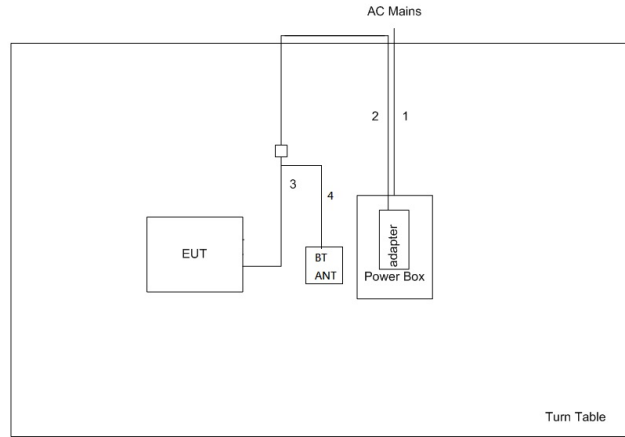

Item	Connection	Shielded	Length(m)	Remark
1	AC Power Line	No	1.8	-
2	DC Power Line	No	2.4	-
3	RF cable	No	0.5	-
4	ANT cable	No	0.2	-

### 3 Transmitter Test Result

#### 3.1 AC Power-line Conducted Emissions

##### 3.1.1 AC Power-line Conducted Emissions Limit

AC Power-line Conducted Emissions Limit		
Frequency Emission (MHz)	Quasi-Peak	Average
0.15-0.5	66 - 56 *	56 - 46 *
0.5-5	56	46
5-30	60	50

Note 1: \* Decreases with the logarithm of the frequency.

##### 3.1.2 Measuring Instruments

Refer a test equipment and calibration data table in this test report.

##### 3.1.3 Test Procedures

Test Method
<ul style="list-style-type: none"> <li>Refer as ANSI C63.10-2013, clause 6.2 foray power-line conducted emissions.</li> </ul>

##### 3.1.4 Test Setup

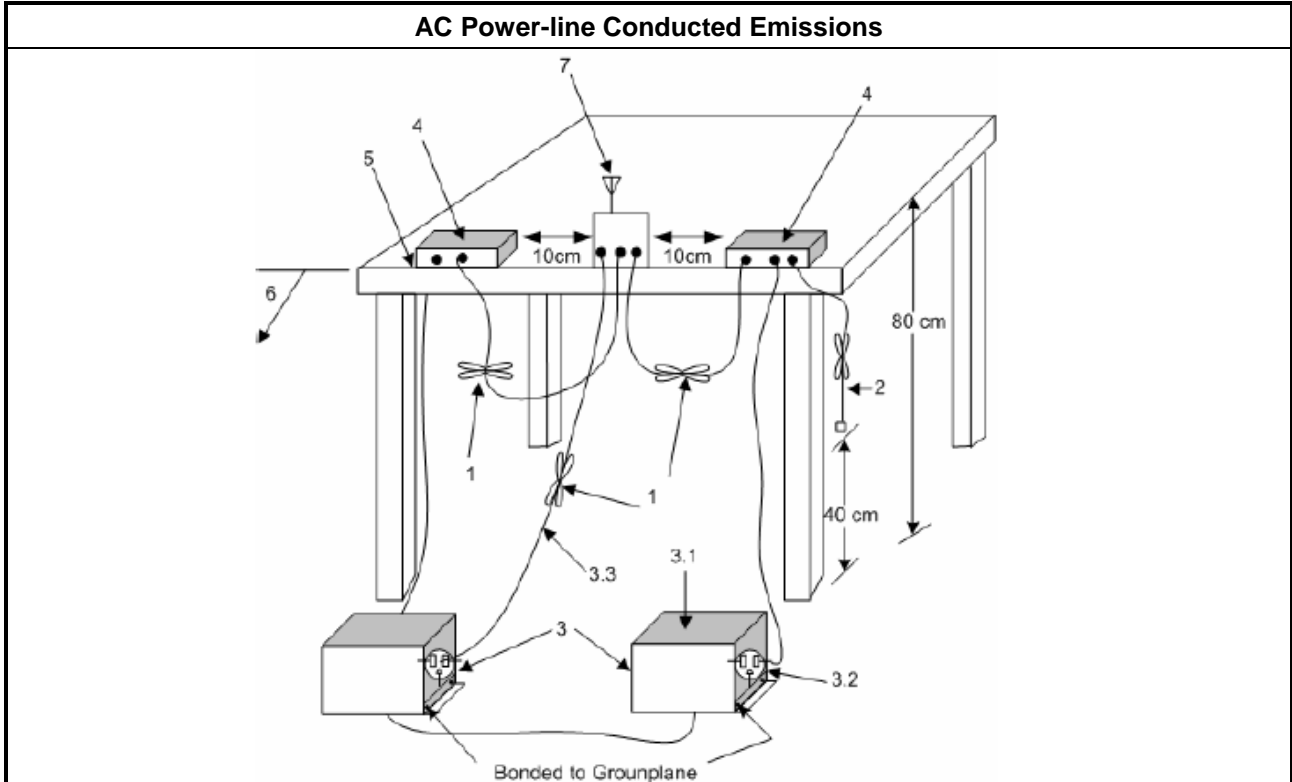

##### 3.1.5 Test Result of AC Power-line Conducted Emissions

Refer as Appendix A

### 3.2 DTS Bandwidth

#### 3.2.1 6dB Bandwidth Limit

6dB Bandwidth Limit	
Systems using digital modulation techniques:	
<ul style="list-style-type: none"> <li>▪ 6 dB bandwidth <math>\geq</math> 500 kHz.</li> </ul>	

#### 3.2.2 Measuring Instruments

Refer a test equipment and calibration data table in this test report.

#### 3.2.3 Test Procedures

Test Method	
▪	For the emission bandwidth shall be measured using one of the options below:
<input checked="" type="checkbox"/>	Refer as KDB 558074, clause 8.1 Option 1 for 6 dB bandwidth measurement.
<input type="checkbox"/>	Refer as KDB 558074, clause 8.2 Option 2 for 6 dB bandwidth measurement.
<input type="checkbox"/>	Refer as ANSI C63.10, clause 6.9.3 for occupied bandwidth testing.

#### 3.2.4 Test Setup

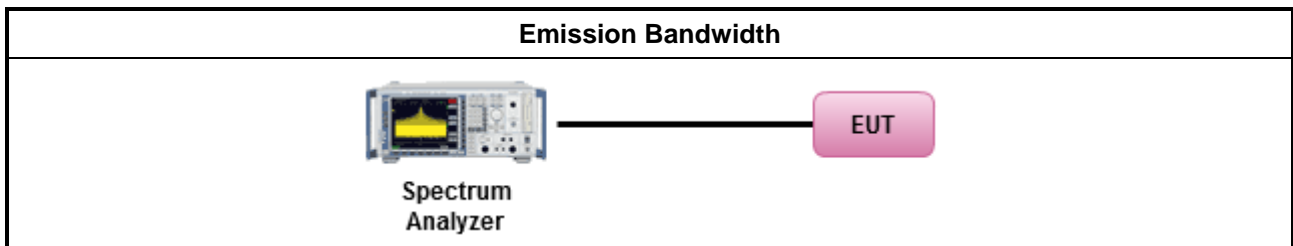

#### 3.2.5 Test Result of Emission Bandwidth

Refer as Appendix B

### 3.3 Maximum Conducted Output Power

#### 3.3.1 Maximum Conducted Output Power Limit

Maximum Conducted Output Power Limit	
	<ul style="list-style-type: none"> <li>▪ If <math>G_{TX} \leq 6</math> dBi, then <math>P_{Out} \leq 30</math> dBm (1 W)</li> </ul>
	<ul style="list-style-type: none"> <li>▪ Point-to-multipoint systems (P2M): If <math>G_{TX} &gt; 6</math> dBi, then <math>P_{Out} = 30 - (G_{TX} - 6)</math> dBm</li> </ul>
	<ul style="list-style-type: none"> <li>▪ Point-to-point systems (P2P): If <math>G_{TX} &gt; 6</math> dBi, then <math>P_{Out} = 30 - (G_{TX} - 6)/3</math> dBm</li> </ul>
	<ul style="list-style-type: none"> <li>▪ Smart antenna system (SAS):</li> </ul>
	<ul style="list-style-type: none"> <li>- Single beam: If <math>G_{TX} &gt; 6</math> dBi, then <math>P_{Out} = 30 - (G_{TX} - 6)/3</math> dBm</li> </ul>
	<ul style="list-style-type: none"> <li>- Overlap beam: If <math>G_{TX} &gt; 6</math> dBi, then <math>P_{Out} = 30 - (G_{TX} - 6)/3</math> dBm</li> </ul>
	<ul style="list-style-type: none"> <li>- Aggregate power on all beams: If <math>G_{TX} &gt; 6</math> dBi, then <math>P_{Out} = 30 - (G_{TX} - 6)/3 + 8</math> dBm</li> </ul>
e.i.r.p. Power Limit:	
	<ul style="list-style-type: none"> <li>▪ 2400-2483.5 MHz Band</li> </ul>
	<ul style="list-style-type: none"> <li>▪ Point-to-multipoint systems (P2M): <math>P_{eirp} \leq 36</math> dBm (4 W)</li> </ul>
	<ul style="list-style-type: none"> <li>▪ Point-to-point systems (P2P): <math>P_{eirp} \leq \text{MAX}(36, [P_{Out} + G_{TX}])</math> dBm</li> </ul>
	<ul style="list-style-type: none"> <li>▪ Smart antenna system (SAS)</li> </ul>
	<ul style="list-style-type: none"> <li>- Single beam: <math>P_{eirp} \leq \text{MAX}(36, P_{Out} + G_{TX})</math> dBm</li> </ul>
	<ul style="list-style-type: none"> <li>- Overlap beam: <math>P_{eirp} \leq \text{MAX}(36, P_{Out} + G_{TX})</math> dBm</li> </ul>
	<ul style="list-style-type: none"> <li>- Aggregate power on all beams: <math>P_{eirp} \leq \text{MAX}(36, [P_{Out} + G_{TX} + 8])</math> dBm</li> </ul>
$P_{Out}$ = maximum peak conducted output power or maximum conducted output power in dBm, $G_{TX}$ = the maximum transmitting antenna directional gain in dBi.	

#### 3.3.2 Measuring Instruments

Refer a test equipment and calibration data table in this test report.

### 3.3.3 Test Procedures

Test Method	
<ul style="list-style-type: none"> <li>▪ Maximum Peak Conducted Output Power</li> </ul>	
<input type="checkbox"/>	Refer as KDB 558074, clause 9.1.1 Option 1 (RBW ≥ EBW method).
<input type="checkbox"/>	Refer as KDB 558074, clause 9.1.2 Option 2 (integrated band power method)
<input type="checkbox"/>	Refer as KDB 558074, clause 9.1.3 Option 3 (peak power meter for VBW ≥ DTS BW)
<ul style="list-style-type: none"> <li>▪ Maximum Average Conducted Output Power</li> </ul>	
Duty cycle ≥ 98%	
<input type="checkbox"/>	Refer as KDB 558074, clause 9.2.2.4 Method AVGSA-2 (spectral trace averaging).
Duty cycle < 98%	
<input type="checkbox"/>	Refer as KDB 558074, clause 9.2.2.5 Method AVGSA-2 Alt. (slow sweep speed)
RF power meter and average over on/off periods with duty factor or gated trigger	
<input checked="" type="checkbox"/>	Refer as KDB 558074, clause 9.2.3.1 Method AVGPM (using an RF average power meter).
<ul style="list-style-type: none"> <li>▪ For conducted measurement.</li> </ul>	
<ul style="list-style-type: none"> <li>▪ If the EUT supports multiple transmit chains using options given below: Refer as KDB 662911, In-band power measurements. Using the measure-and-sum approach, measured all transmit ports individually. Sum the power (in linear power units e.g., mW) of all ports for each individual sample and save them.</li> </ul>	
<ul style="list-style-type: none"> <li>▪ If multiple transmit chains, EIRP calculation could be following as methods:  <math>P_{total} = P_1 + P_2 + \dots + P_n</math>                      (calculated in linear unit [mW] and transfer to log unit [dBm])  <math>EIRP_{total} = P_{total} + DG</math> </li> </ul>	

### 3.3.4 Test Setup

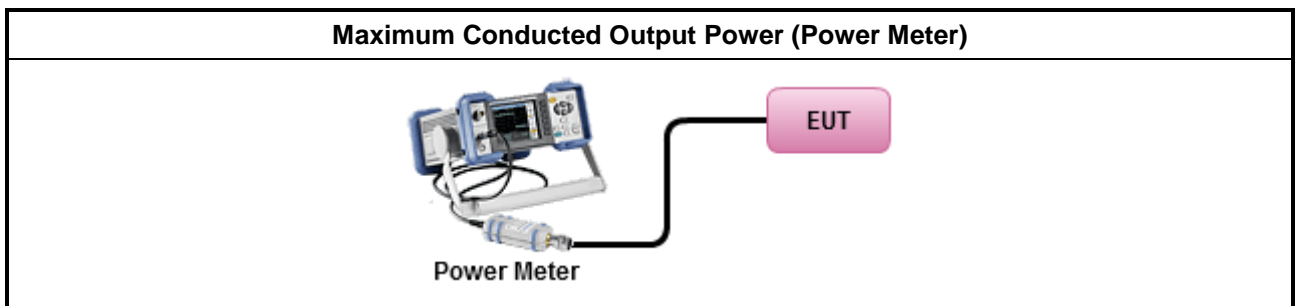

### 3.3.5 Test Result of Maximum Conducted Output Power

Refer as Appendix C

### 3.4 Power Spectral Density

#### 3.4.1 Power Spectral Density Limit

Power Spectral Density Limit
<ul style="list-style-type: none"> <li>Power Spectral Density (PSD) ≤ 8 dBm/3kHz</li> </ul>

#### 3.4.2 Measuring Instruments

Refer a test equipment and calibration data table in this test report.

#### 3.4.3 Test Procedures

Test Method	
	<ul style="list-style-type: none"> <li>Peak power spectral density procedures that the same method as used to determine the conducted output power. If maximum peak conducted output power was measured to demonstrate compliance to the output power limit, then the peak PSD procedure below (Method PKPSD) shall be used. If maximum conducted output power was measured to demonstrate compliance to the output power limit, then one of the average PSD procedures shall be used, as applicable based on the following criteria (the peak PSD procedure is also an acceptable option).</li> </ul>
<input checked="" type="checkbox"/>	Refer as KDB 558074, clause 10.2 Method PKPSD (RBW=3-100kHz; Detector=peak).
	<ul style="list-style-type: none"> <li>For conducted measurement.</li> </ul>
	<ul style="list-style-type: none"> <li>If The EUT supports multiple transmit chains using options given below:</li> </ul>
	<ul style="list-style-type: none"> <li>Measure and sum the spectra across the outputs. Refer as KDB 662911, In-band power spectral density (PSD). Sample all transmit ports simultaneously using a spectrum analyzer for each transmit port. Where the trace bin-by-bin of each transmit port summing can be performed. (i.e., in the first spectral bin of output 1 is summed with that in the first spectral bin of output 2 and that from the first spectral bin of output 3, and so on up to the NTX output to obtain the value for the first frequency bin of the summed spectrum.). Add up the amplitude (power) values for the different transmit chains and use this as the new data trace.</li> </ul>

#### 3.4.4 Test Setup

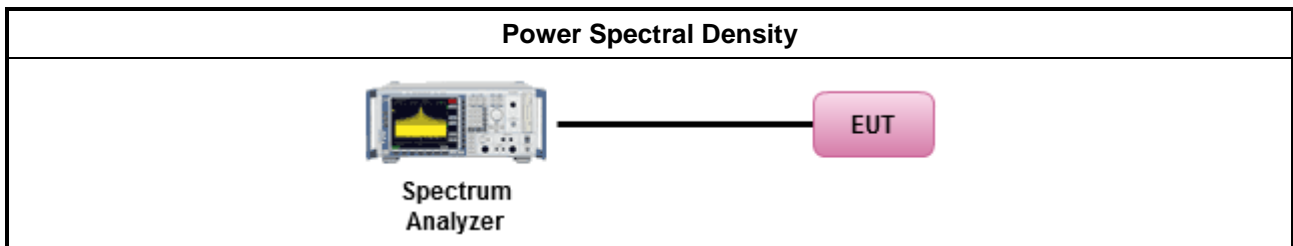

#### 3.4.5 Test Result of Power Spectral Density

Refer as Appendix D



### 3.5 Emissions in Non-restricted Frequency Bands

#### 3.5.1 Emissions in Non-restricted Frequency Bands Limit

Un-restricted Band Emissions Limit	
RF output power procedure	Limit (dB)
Peak output power procedure	20
Average output power procedure	30

Note 1: If the peak output power procedure is used to measure the fundamental emission power to demonstrate compliance to requirements, then the peak conducted output power measured within any 100 kHz outside the authorized frequency band shall be attenuated by at least 20 dB relative to the maximum measured in-band peak PSD level.

Note 2: If the average output power procedure is used to measure the fundamental emission power to demonstrate compliance to requirements, then the power in any 100 kHz outside of the authorized frequency band shall be attenuated by at least 30 dB relative to the maximum measured in-band average PSD level.

#### 3.5.2 Measuring Instruments

Refer a test equipment and calibration data table in this test report.

#### 3.5.3 Test Procedures

Test Method
<ul style="list-style-type: none"> <li>Refer as KDB 558074, clause 11 for unwanted emissions into non-restricted bands.</li> </ul>

#### 3.5.4 Test Setup

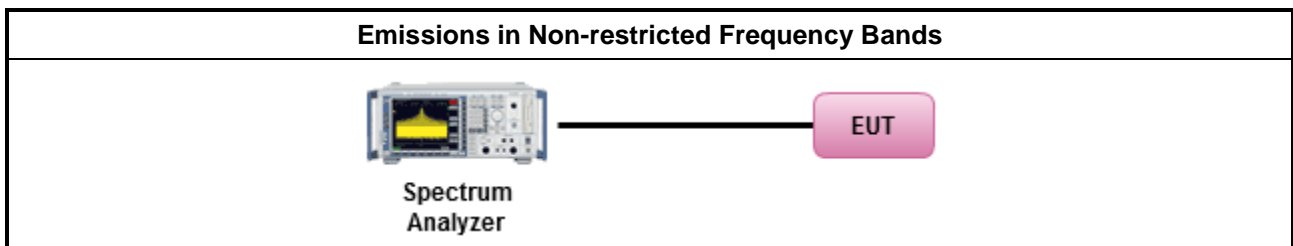

#### 3.5.5 Test Result of Emissions in Non-restricted Frequency Bands

Refer as Appendix E



### 3.6 Emissions in Restricted Frequency Bands

#### 3.6.1 Emissions in Restricted Frequency Bands Limit

Restricted Band Emissions Limit			
Frequency Range (MHz)	Field Strength (uV/m)	Field Strength (dBuV/m)	Measure Distance (m)
0.009~0.490	2400/F(kHz)	48.5 - 13.8	300
0.490~1.705	24000/F(kHz)	33.8 - 23	30
1.705~30.0	30	29	30
30~88	100	40	3
88~216	150	43.5	3
216~960	200	46	3
Above 960	500	54	3

Note 1: Test distance for frequencies at or above 30 MHz, measurements may be performed at a distance other than the limit distance provided they are not performed in the near field and the emissions to be measured can be detected by the measurement equipment. When performing measurements at a distance other than that specified, the results shall be extrapolated to the specified distance using an extrapolation factor of 20 dB/decade (inverse of linear distance for field-strength measurements, inverse of linear distance-squared for power-density measurements).

Note 2: Test distance for frequencies at below 30 MHz, measurements may be performed at a distance closer than the EUT limit distance; however, an attempt should be made to avoid making measurements in the near field. When performing measurements below 30 MHz at a closer distance than the limit distance, the results shall be extrapolated to the specified distance by either making measurements at a minimum of two or more distances on at least one radial to determine the proper extrapolation factor or by using the square of an inverse linear distance extrapolation factor (40 dB / decade). The test report shall specify the extrapolation method used to determine compliance of the EUT.

#### 3.6.2 Measuring Instruments

Refer a test equipment and calibration data table in this test report.



3.6.3 Test Procedures

Test Method	
<ul style="list-style-type: none"> <li>▪ The average emission levels shall be measured in [duty cycle <math>\geq</math> 98 or duty factor].</li> </ul>	
<ul style="list-style-type: none"> <li>▪ Refer as ANSI C63.10, clause 6.10.3 band-edge testing shall be performed at the lowest frequency channel and highest frequency channel within the allowed operating band.</li> </ul>	
<ul style="list-style-type: none"> <li>▪ For the transmitter unwanted emissions shall be measured using following options below:</li> </ul>	
	<ul style="list-style-type: none"> <li>▪ Refer as KDB 558074, clause 12 for unwanted emissions into restricted bands.</li> </ul>
<input checked="" type="checkbox"/>	Refer as KDB 558074, clause 12.2.5.3 (ANSI C63.10, clause 4.1.4.2.3), Reduced VBW $\geq$ 1/T.
<input checked="" type="checkbox"/>	Refer as KDB 558074, clause 12.2.4 measurement procedure peak limit.
<ul style="list-style-type: none"> <li>▪ For the transmitter band-edge emissions shall be measured using following options below:</li> </ul>	
	<ul style="list-style-type: none"> <li>▪ Refer as KDB 558074 clause 13.1, When the performing peak or average radiated measurements, emissions within 2 MHz of the authorized band edge may be measured using the marker-delta method described below.</li> </ul>
	<ul style="list-style-type: none"> <li>▪ Refer as KDB 558074, clause 13.2 (ANSI C63.10, clause 6.10.6) for marker-delta method for band-edge measurements.</li> </ul>
	<ul style="list-style-type: none"> <li>▪ Refer as KDB 558074, clause 13.3 for narrower resolution bandwidth (100kHz) using the band power and summing the spectral levels (i.e., 1 MHz).</li> </ul>
<ul style="list-style-type: none"> <li>▪ For conducted and cabinet radiation measurement, refer as KDB 558074, clause 12.2.2.</li> </ul>	
	<ul style="list-style-type: none"> <li>▪ For conducted unwanted emissions into restricted bands (absolute emission limits). Devices with multiple transmit chains using options given below: (1) Measure and sum the spectra across the outputs or (2) Measure and add 10 log(N) dB</li> </ul>
	<ul style="list-style-type: none"> <li>▪ For KDB 662911 The methodology described here may overestimate array gain, thereby resulting in apparent failures to satisfy the out-of-band limits even if the device is actually compliant. In such cases, compliance may be demonstrated by performing radiated tests around the frequencies at which the apparent failures occurred.</li> </ul>

### 3.6.4 Test Setup

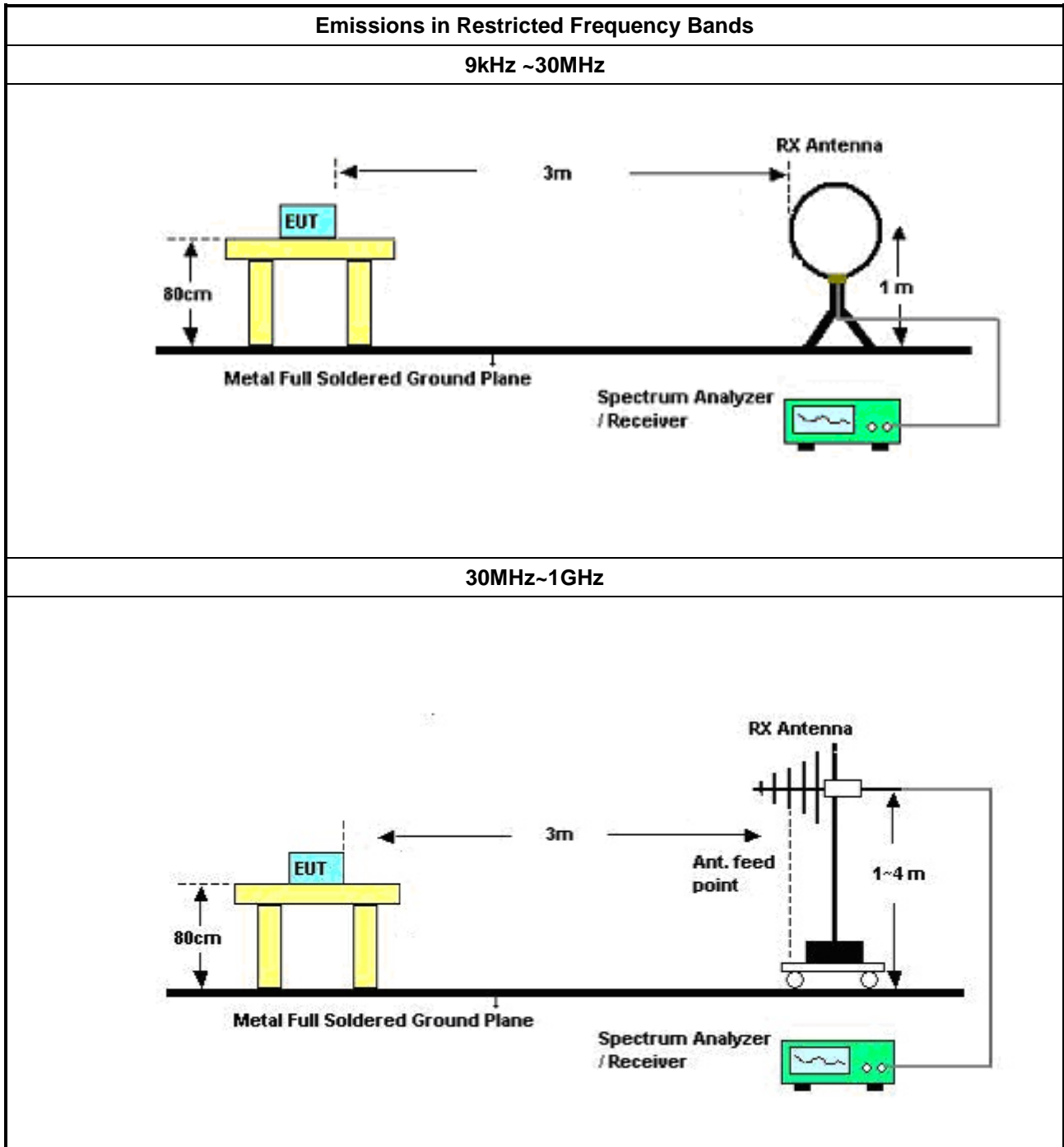

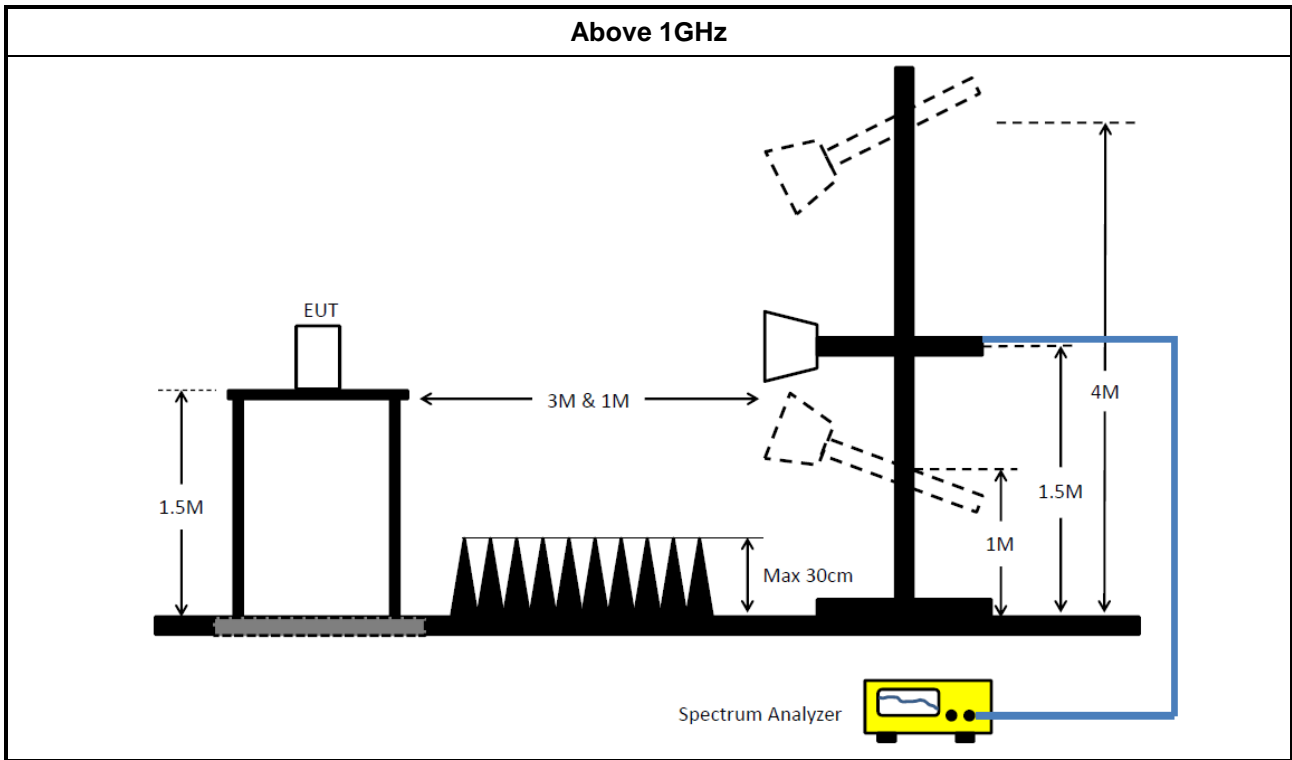

### 3.6.5 Test Result of Emissions in Restricted Frequency Bands (Below 30MHz)

The amplitude of spurious emissions which are attenuated by more than 20dB below the permissible value has no need to be reported. All amplitude of spurious emissions that are attenuated by more than 20 dB below the permissible value has no need to be reported.

### 3.6.6 Test Result of Emissions in Restricted Frequency Bands

Refer as Appendix F



## 4 Test Equipment and Calibration Data

### Instrument for AC Conduction

Instrument	Manufacturer	Model No.	Serial No.	Spec.	Calibration Date	Calibration Due Date
EMC Receiver	R&S	ESR3	102052	9KHz ~ 3.6GHz	29/Apr/2017	28/Apr/2018
LISN	R&S	ENV216	101295	9kHz ~ 30MHz	15/Nov/2016	14/Nov/2017
RF Cable-CON	HUBER+SUHNER	RG213/U	07611832020001	9kHz ~ 30MHz	24/Oct/2016	23/Oct/2017
AC POWER	APC	AFC-11005G	F310050055	47Hz~63Hz 5~300V	NCR	NCR
Impuls Begrenzer Pulse Limiter	R&S	ESH3-Z2	100921	10 kHz ~ 30 MHz	21/Oct/2016	20/Oct/2017

NCR : Non-Calibration Require

### Instrument for Radiated Test

Instrument	Manufacturer	Model No.	Serial No.	Spec.	Calibration Date	Calibration Due Date
3m Semi Anechoic Chamber	SIDT FRANKONIA	SAC-3M	03CH03-HY	30MHz ~ 1GHz	28/Nov/2016	27/Nov/2017
3m Semi Anechoic Chamber	SIDT FRANKONIA	SAC-3M	03CH03-HY	1GHz ~ 18GHz	16/Dec/2016	15/Dec/2017
Amplifier	HP	8447D	2944A08033	10kHz ~ 1.3GHz	19/Apr/2017	18/Apr/2018
Spectrum	R&S	FSV40	101500	9kHz ~ 40GHz	28/Jun/2017	27/Jun/2018
Bilog Antenna	SCHAFFNER	CBL 6112D	22237	30MHz ~ 1GHz	08/Jul/2017	07/Jul/2018
Horn Antenna	SCHWARZBECK	BBHA 9120D	BBHA 9120D 1531	1GHz ~ 18GHz	25/Apr/2017	24/Apr/2018
Horn Antenna	SCHWARZBECK	BBHA 9170	BBHA 9170221	18GHz ~ 40GHz	06/Feb/2017	05/Feb/2018
Amplifier	Agilent	8449B	3008A02326	1GHz ~ 26.5GHz	17/Jul/2017	16/Jul/2018
Loop Antenna	TESEQ	HLA 6120	24155	9 kHz~30 MHz	02/Mar/2017	01/Mar/2018
RF-Cable-high	SUHNER	SUHNER	CB222	1GHz ~ 40GHz	26/Jan/2017	25/Jan/2018
RF Cable-R03m	Jye Bao	RG142	CB021	9kHz ~ 1GHz	26/Jan/2017	25/Jan/2018
Receiver	R&S	ESU-26	100422/026	20Hz ~ 26.5GHz	21/Sep/2017	20/Sep/2018



Instrument for Conducted Test

Instrument	Manufacturer	Model No.	Serial No.	Spec.	Calibration Date	Calibration Due Date
Spectrum Analyzer	R&S	FSV 40	101013	10Hz~40GHz	30/Dec/2016	29/Dec/2017
Power Sensor	Anritsu	MA2411B	1027452	300MHz ~ 40GHz	24/Feb/2017	23/Feb/2018
Power Meter	Anritsu	ML2495A	1124009	300MHz ~ 40GHz	24/Feb/2017	23/Feb/2018
Signal Generator	R&S	SMR40	100116	10MHz ~ 40GHz	21/Jul/2016	20/Jul/2017
RF Cable-0.2m	HUBER+SUHNER	SUCOFLEX_104	MY677/3	30MHz ~ 26.5GHz	02/Oct/2016	01/Oct/2017
RF Cable-0.2m	HUBER+SUHNER	SUCOFLEX_104	MY678/3	30MHz ~ 26.5GHz	02/Oct/2016	01/Oct/2017
RF Cable-0.5m	HUBER+SUHNER	SUCOFLEX_104	MY10717/4	30MHz ~ 26.5GHz	02/Oct/2016	01/Oct/2017



AC Power-line Conducted Emissions Result																																																																																																																																	
Operating Mode	1	Power Phase	Neutral																																																																																																																														
Operating Function	Adapter Mode (BT LE)																																																																																																																																
<div style="display: flex; justify-content: space-between;"> <div> </div> <div style="text-align: right;">Date: 2017-09-13</div> </div>																																																																																																																																	
<table border="1" style="width: 100%; border-collapse: collapse; margin-top: 10px;"> <thead> <tr> <th></th> <th>Freq</th> <th>Level</th> <th>Over Limit</th> <th>Limit Line</th> <th>Read Level</th> <th>LISN Factor</th> <th>Cable Loss</th> <th>Remark</th> </tr> <tr> <th></th> <th>MHz</th> <th>dBuV</th> <th>dB</th> <th>dBuV</th> <th>dBuV</th> <th>dB</th> <th>dB</th> <th></th> </tr> </thead> <tbody> <tr><td>1</td><td>0.15240</td><td>29.59</td><td>-26.28</td><td>55.87</td><td>19.77</td><td>9.60</td><td>0.22</td><td>Average</td></tr> <tr><td>2</td><td>0.15240</td><td>42.46</td><td>-23.41</td><td>65.87</td><td>32.64</td><td>9.60</td><td>0.22</td><td>QP</td></tr> <tr><td>3</td><td>0.18249</td><td>26.45</td><td>-27.92</td><td>54.37</td><td>16.53</td><td>9.65</td><td>0.27</td><td>Average</td></tr> <tr><td>4</td><td>0.18249</td><td>37.18</td><td>-27.19</td><td>64.37</td><td>27.26</td><td>9.65</td><td>0.27</td><td>QP</td></tr> <tr style="border: 2px solid black;"><td>5 MAX</td><td>0.25888</td><td>35.56</td><td>-15.91</td><td>51.47</td><td>25.67</td><td>9.66</td><td>0.23</td><td>Average</td></tr> <tr><td>6</td><td>0.25888</td><td>42.09</td><td>-19.38</td><td>61.47</td><td>32.20</td><td>9.66</td><td>0.23</td><td>QP</td></tr> <tr><td>7</td><td>0.35201</td><td>24.95</td><td>-23.96</td><td>48.91</td><td>15.17</td><td>9.64</td><td>0.14</td><td>Average</td></tr> <tr><td>8</td><td>0.35201</td><td>33.04</td><td>-25.87</td><td>58.91</td><td>23.26</td><td>9.64</td><td>0.14</td><td>QP</td></tr> <tr><td>9</td><td>1.82885</td><td>30.06</td><td>-15.94</td><td>46.00</td><td>20.15</td><td>9.64</td><td>0.27</td><td>Average</td></tr> <tr><td>10</td><td>1.82885</td><td>35.74</td><td>-20.26</td><td>56.00</td><td>25.83</td><td>9.64</td><td>0.27</td><td>QP</td></tr> <tr><td>11</td><td>2.20147</td><td>29.87</td><td>-16.13</td><td>46.00</td><td>19.94</td><td>9.66</td><td>0.27</td><td>Average</td></tr> <tr><td>12</td><td>2.20147</td><td>36.52</td><td>-19.48</td><td>56.00</td><td>26.59</td><td>9.66</td><td>0.27</td><td>QP</td></tr> </tbody> </table>					Freq	Level	Over Limit	Limit Line	Read Level	LISN Factor	Cable Loss	Remark		MHz	dBuV	dB	dBuV	dBuV	dB	dB		1	0.15240	29.59	-26.28	55.87	19.77	9.60	0.22	Average	2	0.15240	42.46	-23.41	65.87	32.64	9.60	0.22	QP	3	0.18249	26.45	-27.92	54.37	16.53	9.65	0.27	Average	4	0.18249	37.18	-27.19	64.37	27.26	9.65	0.27	QP	5 MAX	0.25888	35.56	-15.91	51.47	25.67	9.66	0.23	Average	6	0.25888	42.09	-19.38	61.47	32.20	9.66	0.23	QP	7	0.35201	24.95	-23.96	48.91	15.17	9.64	0.14	Average	8	0.35201	33.04	-25.87	58.91	23.26	9.64	0.14	QP	9	1.82885	30.06	-15.94	46.00	20.15	9.64	0.27	Average	10	1.82885	35.74	-20.26	56.00	25.83	9.64	0.27	QP	11	2.20147	29.87	-16.13	46.00	19.94	9.66	0.27	Average	12	2.20147	36.52	-19.48	56.00	26.59	9.66	0.27	QP
	Freq	Level	Over Limit	Limit Line	Read Level	LISN Factor	Cable Loss	Remark																																																																																																																									
	MHz	dBuV	dB	dBuV	dBuV	dB	dB																																																																																																																										
1	0.15240	29.59	-26.28	55.87	19.77	9.60	0.22	Average																																																																																																																									
2	0.15240	42.46	-23.41	65.87	32.64	9.60	0.22	QP																																																																																																																									
3	0.18249	26.45	-27.92	54.37	16.53	9.65	0.27	Average																																																																																																																									
4	0.18249	37.18	-27.19	64.37	27.26	9.65	0.27	QP																																																																																																																									
5 MAX	0.25888	35.56	-15.91	51.47	25.67	9.66	0.23	Average																																																																																																																									
6	0.25888	42.09	-19.38	61.47	32.20	9.66	0.23	QP																																																																																																																									
7	0.35201	24.95	-23.96	48.91	15.17	9.64	0.14	Average																																																																																																																									
8	0.35201	33.04	-25.87	58.91	23.26	9.64	0.14	QP																																																																																																																									
9	1.82885	30.06	-15.94	46.00	20.15	9.64	0.27	Average																																																																																																																									
10	1.82885	35.74	-20.26	56.00	25.83	9.64	0.27	QP																																																																																																																									
11	2.20147	29.87	-16.13	46.00	19.94	9.66	0.27	Average																																																																																																																									
12	2.20147	36.52	-19.48	56.00	26.59	9.66	0.27	QP																																																																																																																									
<p>Note 1: "&gt;20dB" means emission levels that exceed the level of 20 dB below the applicable limit.            Note 2: "N/F" means Nothing Found emissions (No emissions were detected.)</p>																																																																																																																																	







**Summary**

Mode	Max-N dB (Hz)	Max-OBW (Hz)	ITU-Code	Min-N dB (Hz)	Min-OBW (Hz)
BT-LE(1Mbps)	-	-	-	-	-
2.4-2.4835GHz	748.75k	1.054M	1M05F1D	723.75k	1.041M

**Max-N dB** = Maximum 6dB down bandwidth; **Max-OBW** = Maximum 99% occupied bandwidth;  
**Min-N dB** = Minimum 6dB down bandwidth; **Min-OBW** = Minimum 99% occupied bandwidth;

**Result**

Mode	Result	Limit (Hz)	Port 1-N dB (Hz)	Port 1-OBW (Hz)
BT-LE(1Mbps)	-	-	-	-
2402MHz	Pass	500k	723.75k	1.051M
2440MHz	Pass	500k	748.75k	1.041M
2480MHz	Pass	500k	745k	1.054M

**Port X-N dB** = Port X 6dB down bandwidth; **Port X-OBW** = Port X 99% occupied bandwidth;

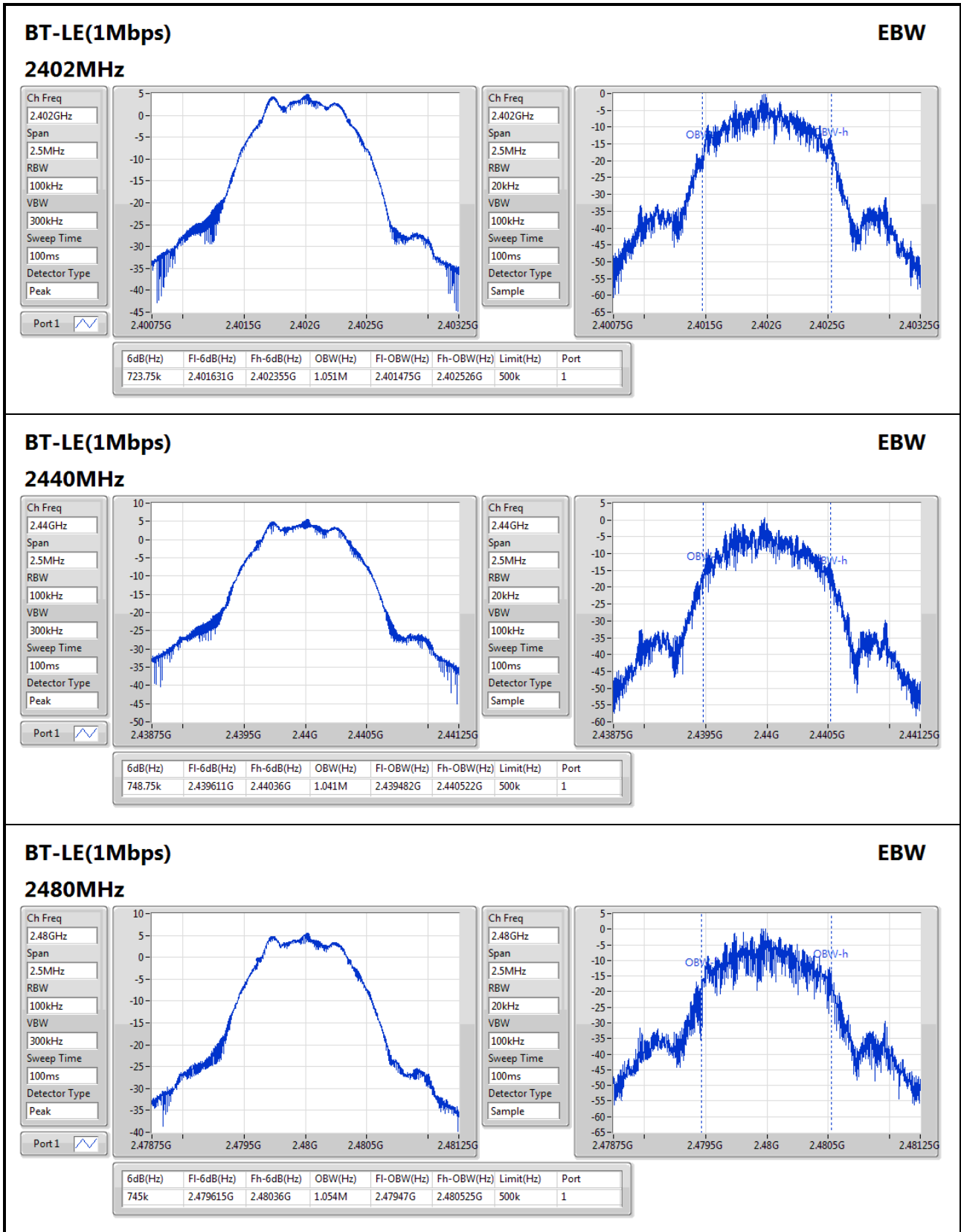



Summary

Mode	Power (dBm)	Power (W)
BT-LE(1Mbps)	-	-
2.4-2.4835GHz	5.51	0.00356

Result

Mode	Result	Gain (dBi)	Power (dBm)	Power Limit (dBm)
BT-LE(1Mbps)	-	-	-	-
2402MHz	Pass	2.00	4.94	30.00
2440MHz	Pass	2.00	5.51	30.00
2480MHz	Pass	2.00	5.49	30.00



**Summary**

Mode	PD (dBm/RBW)
BT-LE(1Mbps)	-
2.4-2.4835GHz	-10.38

RBW=3kHz.

**Result**

Mode	Result	Gain (dBi)	PD (dBm/RBW)	PD Limit (dBm/RBW)
BT-LE(1Mbps)	-	-	-	-
2402MHz	Pass	2.00	-10.38	8.00
2440MHz	Pass	2.00	-10.88	8.00
2480MHz	Pass	2.00	-10.99	8.00

RBW=3kHz.

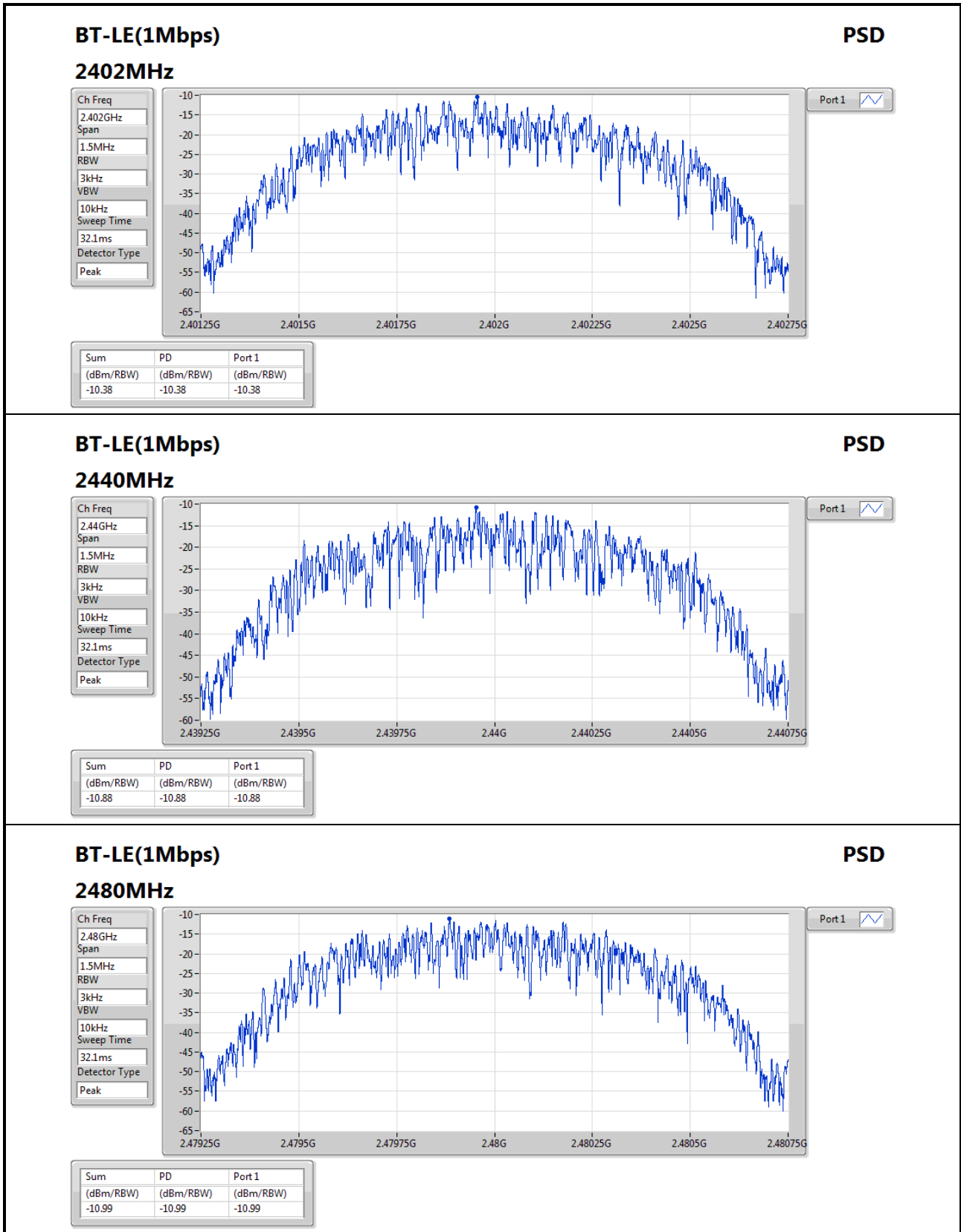



**Summary**

Mode	Result	Ref (Hz)	Ref (dBm)	Limit (dBm)	Freq (Hz)	Level (dBm)	Freq (Hz)	Level (dBm)	Freq (Hz)	Level (dBm)	Freq (Hz)	Level (dBm)	Port
BT-LE(1Mbps)	-	-	-	-	-	-	-	-	-	-	-	-	-
2.4-2.4835GHz	Pass	2.44008G	5.11	-24.89	835.12M	-57.71	2.399996G	-43.22	2.48408G	-55.60	6.504338G	-50.14	1

**Result**

Mode	Result	Ref (Hz)	Ref (dBm)	Limit (dBm)	Freq (Hz)	Level (dBm)	Freq (Hz)	Level (dBm)	Freq (Hz)	Level (dBm)	Freq (Hz)	Level (dBm)	Port
BT-LE(1Mbps)	-	-	-	-	-	-	-	-	-	-	-	-	-
2402MHz	Pass	2.44008G	5.11	-24.89	2.390896G	-57.76	2.399952G	-44.29	2.485184G	-56.90	6.403023G	-51.62	1
2440MHz	Pass	2.44008G	5.11	-24.89	835.12M	-57.71	2.399996G	-43.22	2.48408G	-55.60	6.504338G	-50.14	1
2480MHz	Pass	2.44008G	5.11	-24.89	2.102G	-57.73	2.399732G	-49.79	2.483572G	-52.86	2.519272G	-46.73	1

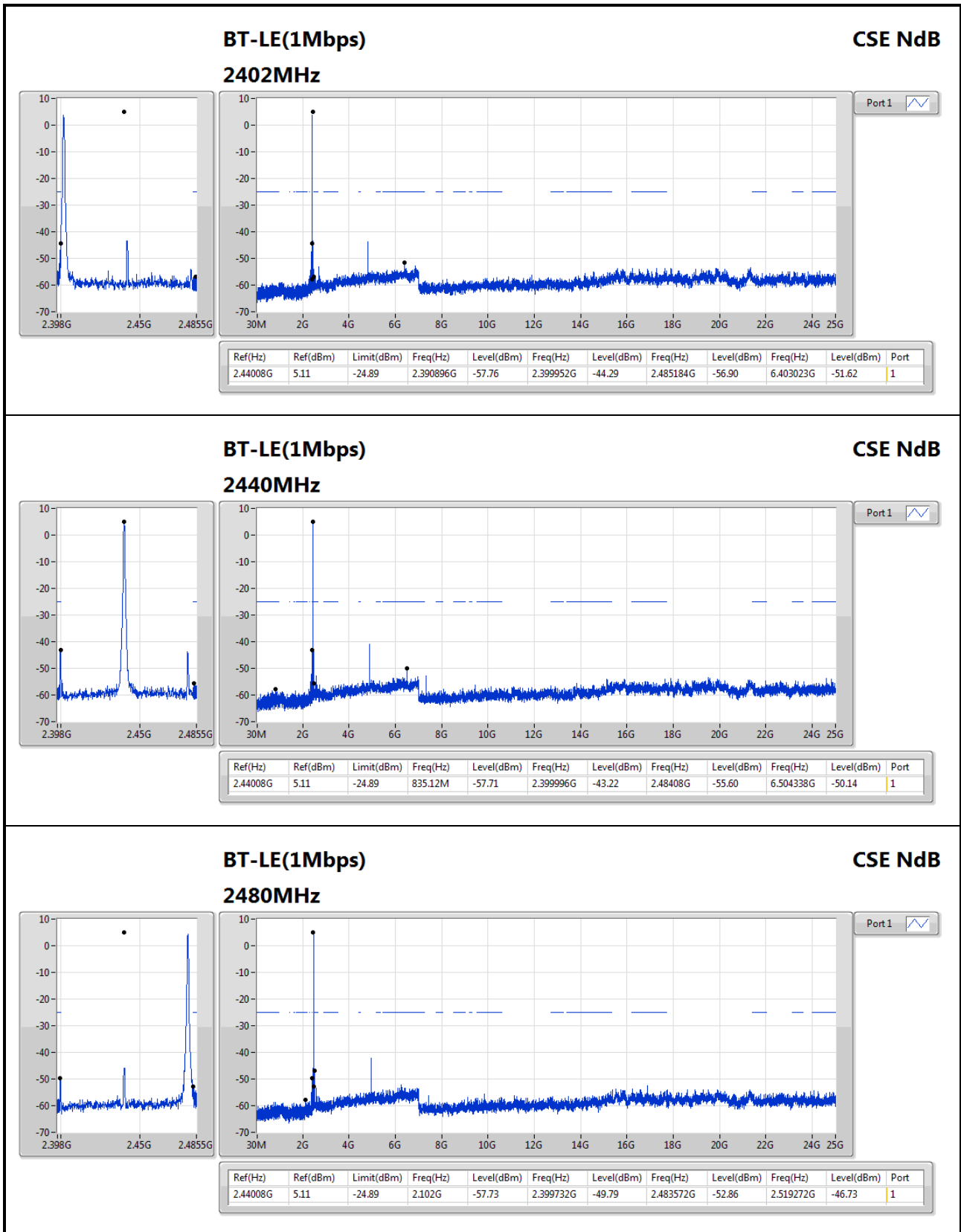





Summary

Mode	Result	Type	Freq (Hz)	Level (dBuV/m)	Limit (dBuV/m)	Margin (dB)	Factor (dB)	Dist (m)	Pol. (H/V)	Azimuth (°)	Height (m)	Comments
BT-LE(1Mbps)	-	-	-	-	-	-	-	-	-	-	-	-
2.4-2.4835GHz	Pass	PK	398.6M	40.58	46.00	-5.42	-3.47	3	H	360	1.00	-



Result

Mode	Result	Type	Freq (Hz)	Level (dBuV/m)	Limit (dBuV/m)	Margin (dB)	Factor (dB)	Dist (m)	Pol. (H/V)	Azimuth (°)	Height (m)	Comments
BT-LE(1Mbps)	-	-	-	-	-	-	-	-	-	-	-	-
2440MHz	Pass	PK	187.14M	30.92	43.50	-12.58	-10.53	3	H	360	1.00	-
2440MHz	Pass	PK	266.68M	36.46	46.00	-9.54	-6.01	3	H	360	1.00	-
2440MHz	Pass	PK	398.6M	40.58	46.00	-5.42	-3.47	3	H	360	1.00	-
2440MHz	Pass	PK	443.22M	32.18	46.00	-13.82	-2.56	3	H	360	1.00	-
2440MHz	Pass	PK	666.32M	30.39	46.00	-15.61	0.19	3	H	360	1.00	-
2440MHz	Pass	QP	249.22M	40.47	46.00	-5.53	-6.60	3	H	351	1.52	-
2440MHz	Pass	PK	41.64M	28.27	40.00	-11.73	-8.86	3	V	0	1.00	-
2440MHz	Pass	PK	154.16M	27.52	43.50	-15.98	-9.79	3	V	0	1.00	-
2440MHz	Pass	PK	249.22M	37.95	46.00	-8.05	-6.60	3	V	0	1.00	-
2440MHz	Pass	PK	398.6M	28.25	46.00	-17.75	-3.47	3	V	0	1.00	-
2440MHz	Pass	PK	447.1M	29.60	46.00	-16.40	-2.47	3	V	0	1.00	-
2440MHz	Pass	PK	551.86M	29.55	46.00	-16.45	-0.38	3	V	0	1.00	-

**BT-LE(1Mbps)**  
**2440MHz\_Adapter**

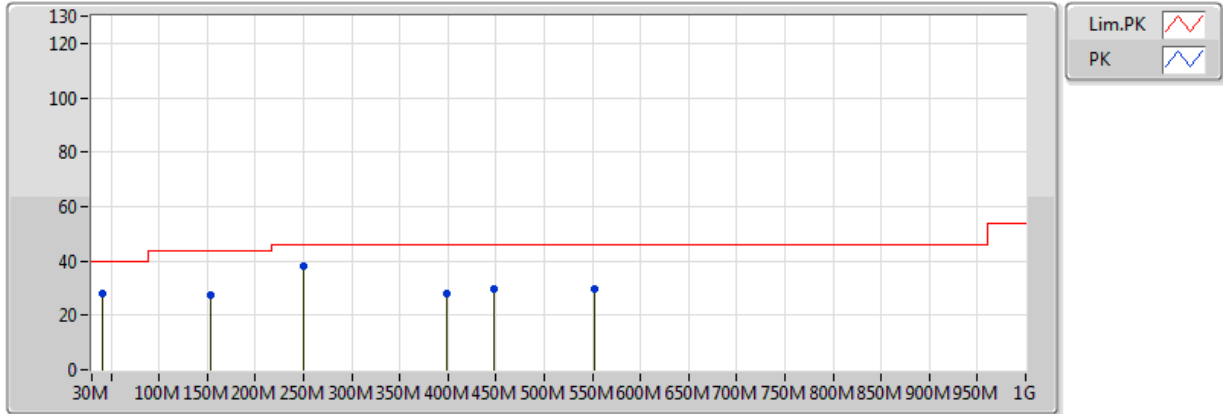

Ant=Z

Type	Freq(Hz)	Level(dBuV/m)	Limit(dBuV/m)	Margin(dB)	Factor(dB)	Dist(m)	Pol.(H/V)	Azimuth(°)	Height(m)	Comments
PK	41.64M	28.27	40.00	-11.73	-8.86	3	V	0	1.00	-
PK	154.16M	27.52	43.50	-15.98	-9.79	3	V	0	1.00	-
PK	249.22M	37.95	46.00	-8.05	-6.60	3	V	0	1.00	-
PK	398.6M	28.25	46.00	-17.75	-3.47	3	V	0	1.00	-
PK	447.1M	29.60	46.00	-16.40	-2.47	3	V	0	1.00	-
PK	551.86M	29.55	46.00	-16.45	-0.38	3	V	0	1.00	-

**BT-LE(1Mbps)**  
**2440MHz\_Adapter**

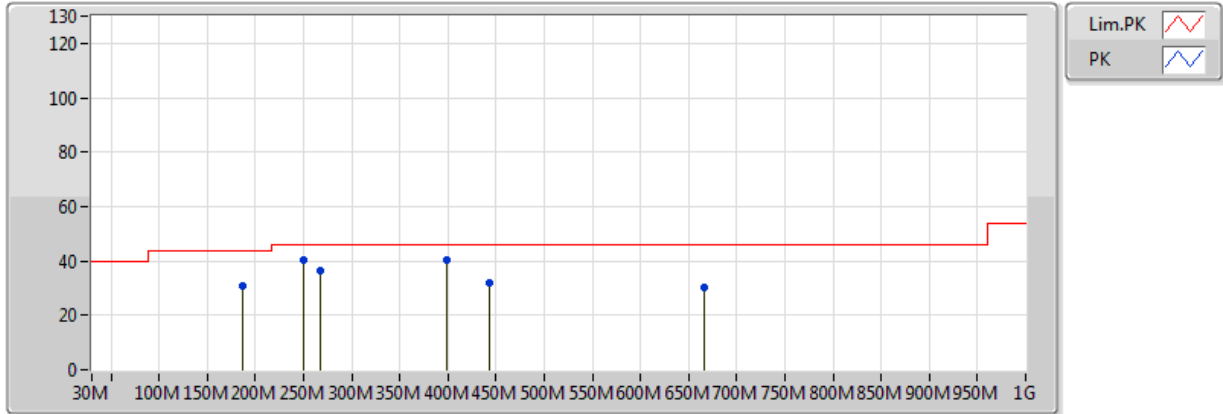

Ant=Z

Type	Freq(Hz)	Level(dBuV/m)	Limit(dBuV/m)	Margin(dB)	Factor(dB)	Dist(m)	Pol.(H/V)	Azimuth(°)	Height(m)	Comments
PK	187.14M	30.92	43.50	-12.58	-10.53	3	H	360	1.00	-
PK	266.68M	36.46	46.00	-9.54	-6.01	3	H	360	1.00	-
PK	398.6M	40.58	46.00	-5.42	-3.47	3	H	360	1.00	-
PK	443.22M	32.18	46.00	-13.82	-2.56	3	H	360	1.00	-
PK	666.32M	30.39	46.00	-15.61	0.19	3	H	360	1.00	-
QP	249.22M	40.47	46.00	-5.53	-6.60	3	H	351	1.52	-



Summary

Mode	Result	Type	Freq (Hz)	Level (dBuV/m)	Limit (dBuV/m)	Margin (dB)	Factor (dB)	Dist (m)	Pol. (H/V)	Azimuth (°)	Height (m)	Comments
BT-LE(1Mbps)	-	-	-	-	-	-	-	-	-	-	-	-
2.4-2.4835GHz	Pass	AV	2.494G	44.08	54.00	-9.92	31.31	3	V	206	1.92	-



Result

Mode	Result	Type	Freq (Hz)	Level (dBuV/m)	Limit (dBuV/m)	Margin (dB)	Factor (dB)	Dist (m)	Pol. (H/V)	Azimuth (°)	Height (m)	Comments
BT-LE(1Mbps)	-	-	-	-	-	-	-	-	-	-	-	-
2402MHz	Pass	AV	2.3894G	43.37	54.00	-10.63	30.93	3	H	204	1.81	-
2402MHz	Pass	AV	2.402G	87.08	Inf	-Inf	30.98	3	H	204	1.81	-
2402MHz	Pass	PK	2.3884G	54.03	74.00	-19.97	30.93	3	H	204	1.81	-
2402MHz	Pass	PK	2.4018G	88.72	Inf	-Inf	30.98	3	H	204	1.81	-
2402MHz	Pass	AV	2.3844G	43.41	54.00	-10.59	30.92	3	V	139	1.00	-
2402MHz	Pass	AV	2.402G	77.37	Inf	-Inf	30.98	3	V	139	1.00	-
2402MHz	Pass	PK	2.3704G	54.28	74.00	-19.72	30.87	3	V	139	1.00	-
2402MHz	Pass	PK	2.4022G	79.19	Inf	-Inf	30.98	3	V	139	1.00	-
2402MHz	Pass	AV	4.804G	35.52	54.00	-18.48	2.10	3	H	173	1.00	-
2402MHz	Pass	PK	4.804G	46.97	74.00	-27.03	2.10	3	H	173	1.00	-
2402MHz	Pass	AV	4.804G	31.25	54.00	-22.75	2.10	3	V	166	2.23	-
2402MHz	Pass	PK	4.804G	43.69	74.00	-30.31	2.13	3	V	166	2.23	-
2440MHz	Pass	AV	2.3812G	43.25	54.00	-10.75	30.90	3	H	225	1.01	-
2440MHz	Pass	AV	2.44G	92.84	Inf	-Inf	31.11	3	H	225	1.01	-
2440MHz	Pass	AV	2.4944G	43.96	54.00	-10.04	31.31	3	H	225	1.01	-
2440MHz	Pass	PK	2.3868G	54.18	74.00	-19.82	30.92	3	H	225	1.01	-
2440MHz	Pass	PK	2.4396G	94.58	Inf	-Inf	31.11	3	H	225	1.01	-
2440MHz	Pass	PK	2.492G	54.15	74.00	-19.85	31.30	3	H	225	1.01	-
2440MHz	Pass	AV	2.3792G	43.39	54.00	-10.61	30.90	3	V	206	1.92	-
2440MHz	Pass	AV	2.44G	85.11	Inf	-Inf	31.11	3	V	206	1.92	-
2440MHz	Pass	AV	2.494G	44.08	54.00	-9.92	31.31	3	V	206	1.92	-
2440MHz	Pass	PK	2.386G	54.19	74.00	-19.81	30.92	3	V	206	1.92	-
2440MHz	Pass	PK	2.4396G	86.77	Inf	-Inf	31.11	3	V	206	1.92	-
2440MHz	Pass	PK	2.484G	54.37	74.00	-19.63	31.27	3	V	206	1.92	-
2440MHz	Pass	AV	4.88G	37.62	54.00	-16.38	2.34	3	H	161	1.03	-
2440MHz	Pass	PK	4.88G	49.34	74.00	-24.66	2.34	3	H	161	1.03	-
2440MHz	Pass	AV	4.88G	35.62	54.00	-18.38	2.34	3	V	188	1.24	-
2440MHz	Pass	PK	4.88G	47.22	74.00	-26.78	2.34	3	V	188	1.24	-
2480MHz	Pass	AV	2.48G	85.44	Inf	-Inf	31.26	3	H	302	1.47	-
2480MHz	Pass	AV	2.486G	44.08	54.00	-9.92	31.28	3	H	302	1.47	-
2480MHz	Pass	PK	2.4796G	87.25	Inf	-Inf	31.26	3	H	302	1.47	-
2480MHz	Pass	PK	2.4918G	55.23	74.00	-18.77	31.30	3	H	302	1.47	-
2480MHz	Pass	AV	2.48G	78.43	Inf	-Inf	31.26	3	V	356	1.26	-
2480MHz	Pass	AV	2.5G	44.07	54.00	-9.93	31.33	3	V	356	1.26	-
2480MHz	Pass	PK	2.4798G	80.31	Inf	-Inf	31.26	3	V	356	1.26	-
2480MHz	Pass	PK	2.489G	55.21	74.00	-18.79	31.29	3	V	356	1.26	-
2480MHz	Pass	AV	4.96G	37.10	54.00	-16.90	2.59	3	H	166	2.79	-
2480MHz	Pass	PK	4.96G	49.43	74.00	-24.57	2.59	3	H	166	2.79	-
2480MHz	Pass	AV	4.96G	36.12	54.00	-17.88	2.59	3	V	208	3.65	-
2480MHz	Pass	PK	4.96G	48.28	74.00	-25.72	2.59	3	V	208	3.65	-

**BT-LE(1Mbps)**

**2402MHz\_TX**

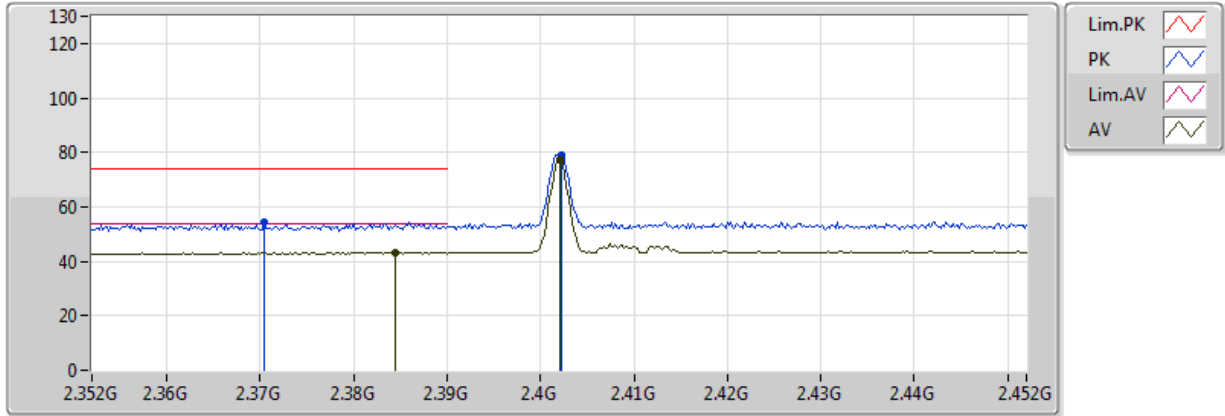

Ant=Z

Type	Freq(Hz)	Level(dBuV/m)	Limit(dBuV/m)	Margin(dB)	Factor(dB)	Dist(m)	Pol.(H/V)	Azimuth(°)	Height(m)	Comments
AV	2.3844G	43.41	54.00	-10.59	30.92	3	V	139	1.00	-
AV	2.402G	77.37	Inf	-Inf	30.98	3	V	139	1.00	-
PK	2.3704G	54.28	74.00	-19.72	30.87	3	V	139	1.00	-
PK	2.4022G	79.19	Inf	-Inf	30.98	3	V	139	1.00	-

### BT-LE(1Mbps)

### 2402MHz\_TX

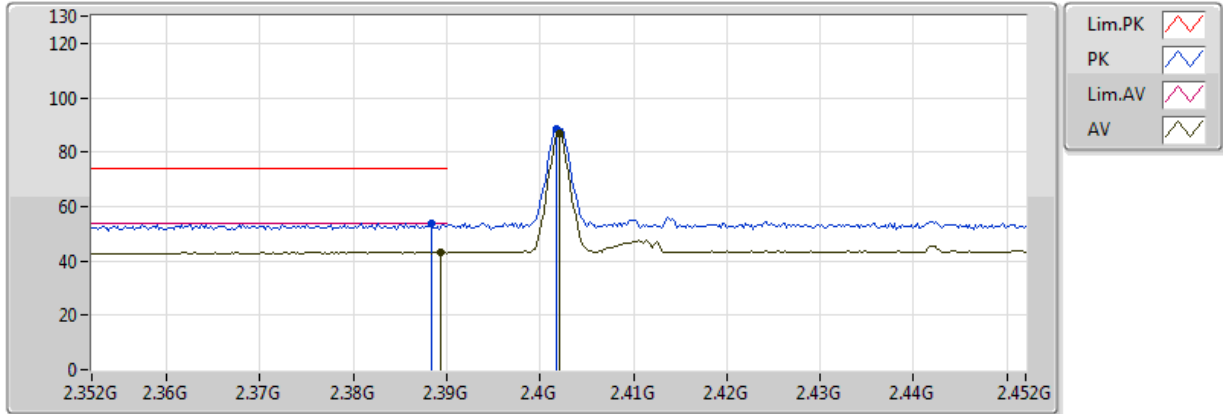

Ant=Z

Type	Freq(Hz)	Level(dBuV/m)	Limit(dBuV/m)	Margin(dB)	Factor(dB)	Dist(m)	Pol.(H/V)	Azimuth(°)	Height(m)	Comments
AV	2.3894G	43.37	54.00	-10.63	30.93	3	H	204	1.81	-
AV	2.402G	87.08	Inf	-Inf	30.98	3	H	204	1.81	-
PK	2.3884G	54.03	74.00	-19.97	30.93	3	H	204	1.81	-
PK	2.4018G	88.72	Inf	-Inf	30.98	3	H	204	1.81	-



### BT-LE(1Mbps)

### 2402MHz\_TX

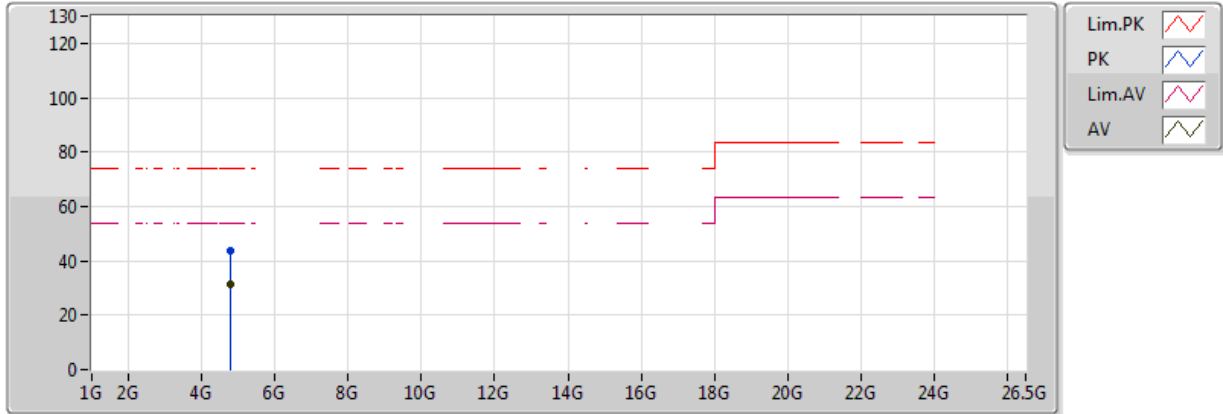

Ant=Z

Type	Freq(Hz)	Level(dBuV/m)	Limit(dBuV/m)	Margin(dB)	Factor(dB)	Dist(m)	Pol.(H/V)	Azimuth(°)	Height(m)	Comments
AV	4.804G	31.25	54.00	-22.75	2.10	3	V	166	2.23	-
PK	4.804G	43.69	74.00	-30.31	2.13	3	V	166	2.23	-

### BT-LE(1Mbps)

### 2402MHz\_TX

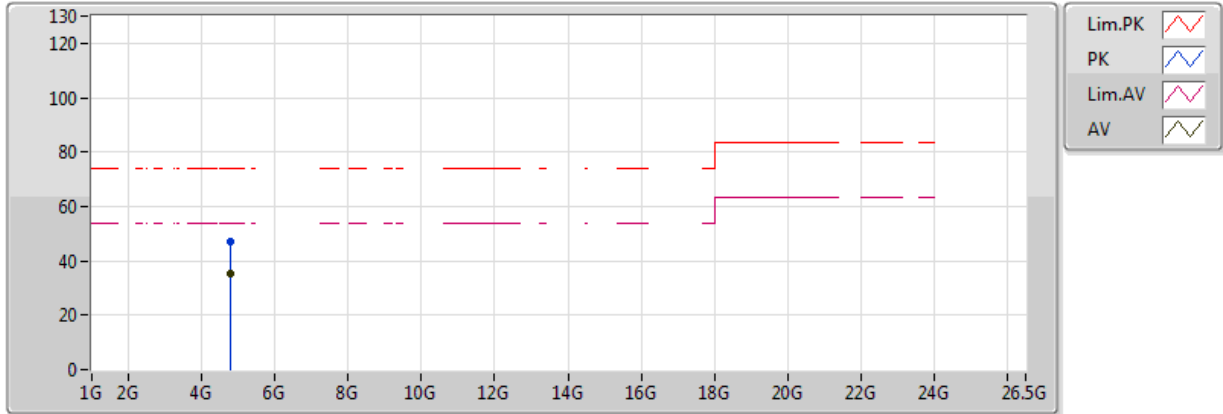

Ant=Z

Type	Freq(Hz)	Level(dBuV/m)	Limit(dBuV/m)	Margin(dB)	Factor(dB)	Dist(m)	Pol.(H/V)	Azimuth(°)	Height(m)	Comments
AV	4.804G	35.52	54.00	-18.48	2.10	3	H	173	1.00	-
PK	4.804G	46.97	74.00	-27.03	2.10	3	H	173	1.00	-

### BT-LE(1Mbps)

### 2440MHz\_TX

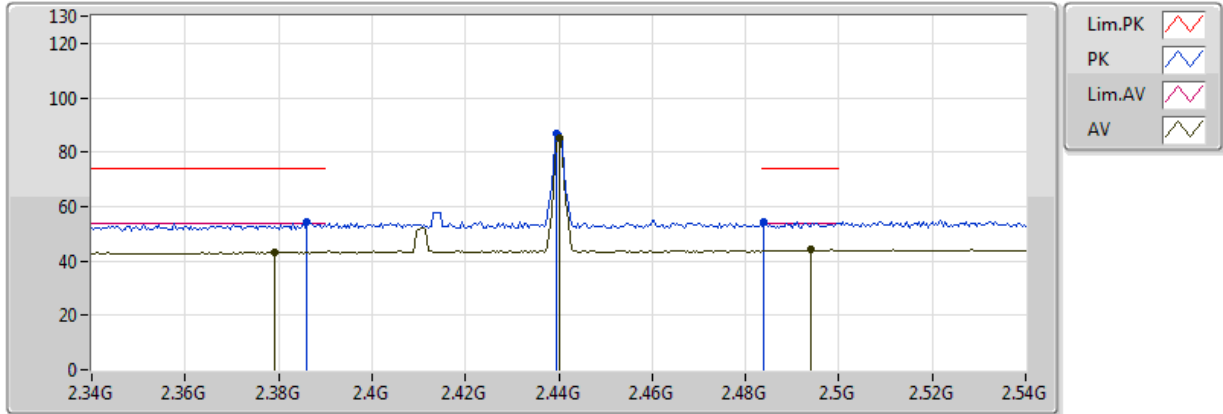

Ant=Z

Type	Freq(Hz)	Level(dBuV/m)	Limit(dBuV/m)	Margin(dB)	Factor(dB)	Dist(m)	Pol.(H/V)	Azimuth(°)	Height(m)	Comments
AV	2.3792G	43.39	54.00	-10.61	30.90	3	V	206	1.92	-
AV	2.44G	85.11	Inf	-Inf	31.11	3	V	206	1.92	-
AV	2.494G	44.08	54.00	-9.92	31.31	3	V	206	1.92	-
PK	2.386G	54.19	74.00	-19.81	30.92	3	V	206	1.92	-
PK	2.4396G	86.77	Inf	-Inf	31.11	3	V	206	1.92	-
PK	2.484G	54.37	74.00	-19.63	31.27	3	V	206	1.92	-

### BT-LE(1Mbps)

### 2440MHz\_TX

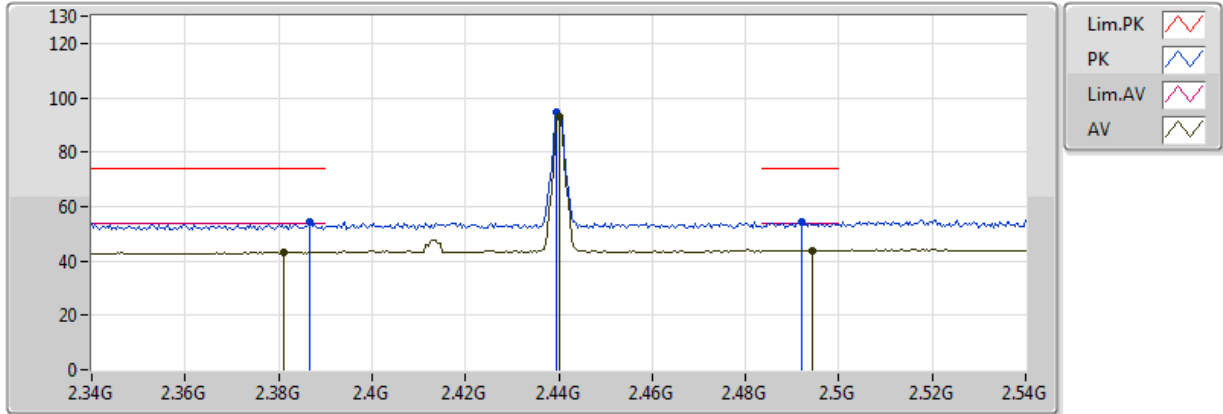

Ant=Z

Type	Freq(Hz)	Level(dBuV/m)	Limit(dBuV/m)	Margin(dB)	Factor(dB)	Dist(m)	Pol.(H/V)	Azimuth(°)	Height(m)	Comments
AV	2.3812G	43.25	54.00	-10.75	30.90	3	H	225	1.01	-
AV	2.44G	92.84	Inf	-Inf	31.11	3	H	225	1.01	-
AV	2.4944G	43.96	54.00	-10.04	31.31	3	H	225	1.01	-
PK	2.3868G	54.18	74.00	-19.82	30.92	3	H	225	1.01	-
PK	2.4396G	94.58	Inf	-Inf	31.11	3	H	225	1.01	-
PK	2.492G	54.15	74.00	-19.85	31.30	3	H	225	1.01	-

### BT-LE(1Mbps)

### 2440MHz\_TX

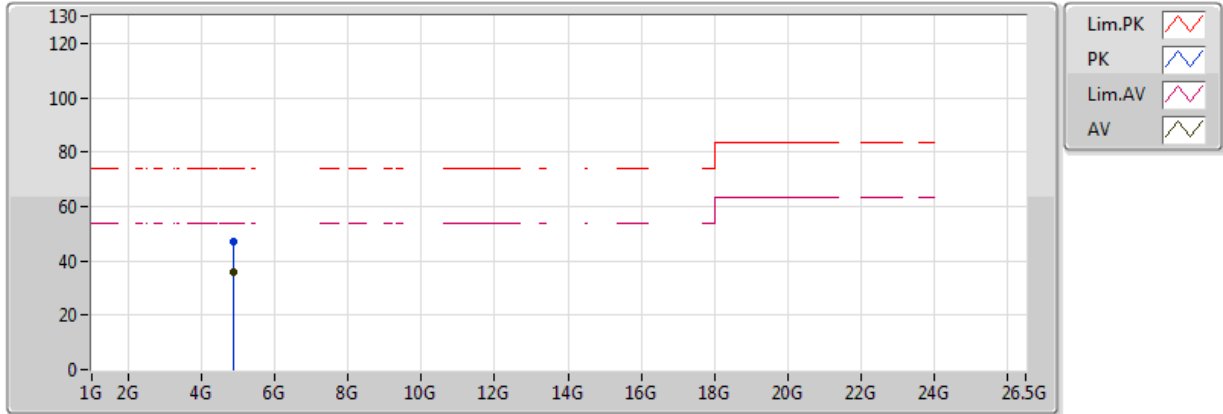

Ant=Z

Type	Freq(Hz)	Level(dBuV/m)	Limit(dBuV/m)	Margin(dB)	Factor(dB)	Dist(m)	Pol.(H/V)	Azimuth(°)	Height(m)	Comments
AV	4.88G	35.62	54.00	-18.38	2.34	3	V	188	1.24	-
PK	4.88G	47.22	74.00	-26.78	2.34	3	V	188	1.24	-

### BT-LE(1Mbps)

### 2440MHz\_TX

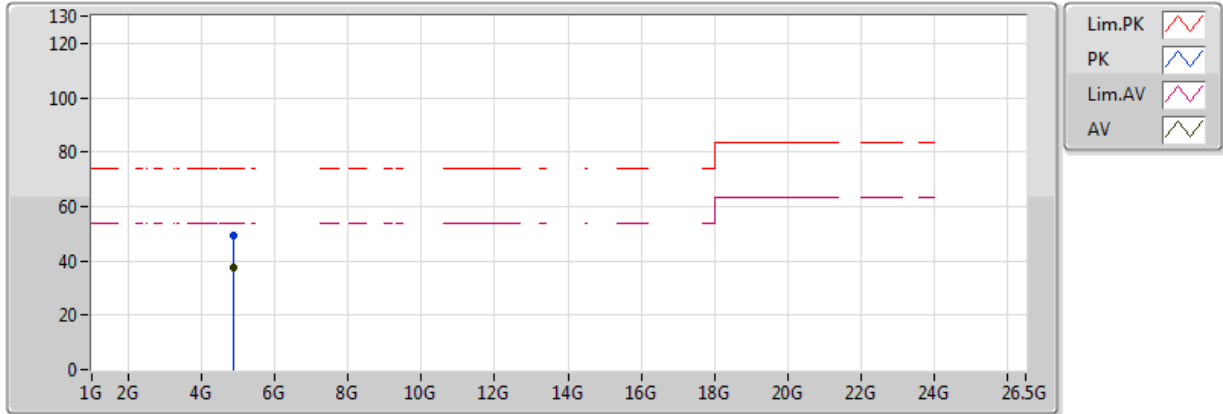

Ant=Z

Type	Freq(Hz)	Level(dBuV/m)	Limit(dBuV/m)	Margin(dB)	Factor(dB)	Dist(m)	Pol.(H/V)	Azimuth(°)	Height(m)	Comments
AV	4.88G	37.62	54.00	-16.38	2.34	3	H	161	1.03	-
PK	4.88G	49.34	74.00	-24.66	2.34	3	H	161	1.03	-

**BT-LE(1Mbps)**

**2480MHz\_TX**

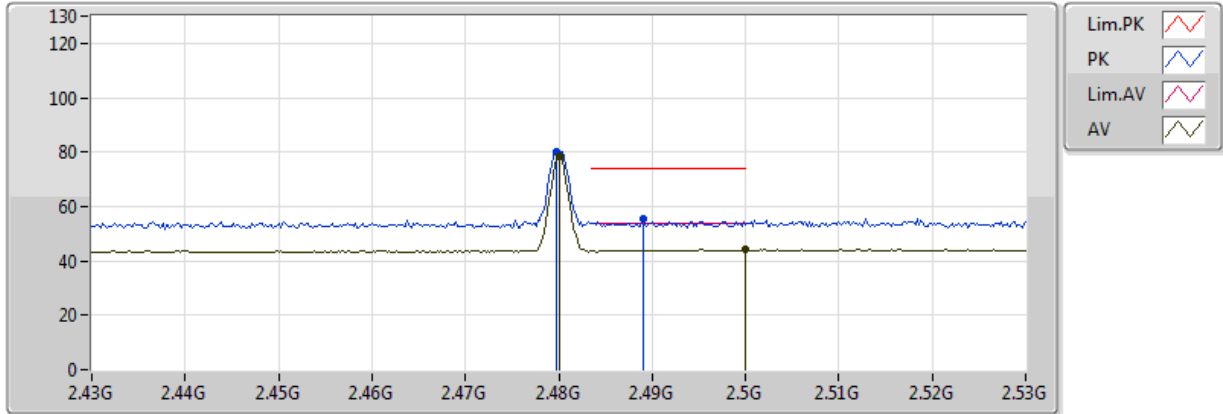

Ant=Z

Type	Freq(Hz)	Level(dBuV/m)	Limit(dBuV/m)	Margin(dB)	Factor(dB)	Dist(m)	Pol.(H/V)	Azimuth(°)	Height(m)	Comments
AV	2.48G	78.43	Inf	-Inf	31.26	3	V	356	1.26	-
AV	2.5G	44.07	54.00	-9.93	31.33	3	V	356	1.26	-
PK	2.4798G	80.31	Inf	-Inf	31.26	3	V	356	1.26	-
PK	2.489G	55.21	74.00	-18.79	31.29	3	V	356	1.26	-

### BT-LE(1Mbps)

### 2480MHz\_TX

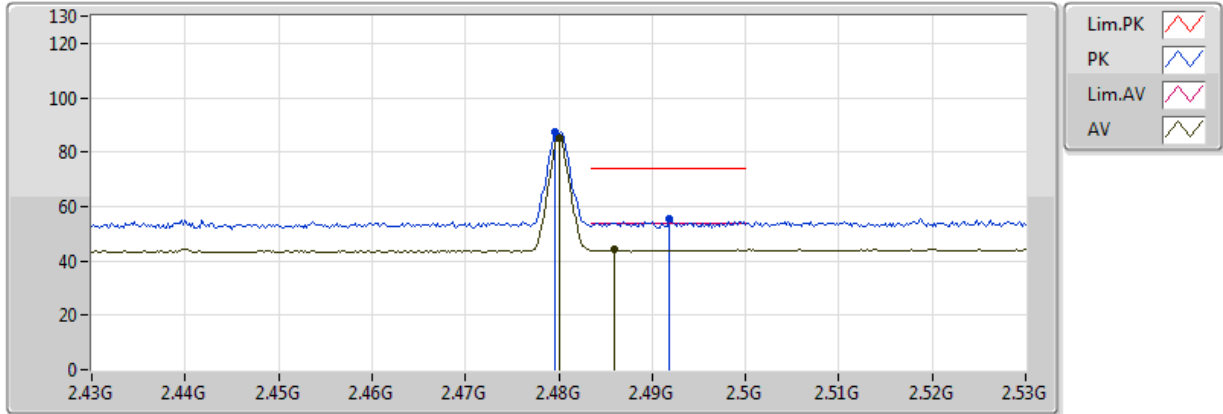

Ant=Z

Type	Freq(Hz)	Level(dBuV/m)	Limit(dBuV/m)	Margin(dB)	Factor(dB)	Dist(m)	Pol.(H/V)	Azimuth(°)	Height(m)	Comments
AV	2.48G	85.44	Inf	-Inf	31.26	3	H	302	1.47	-
AV	2.486G	44.08	54.00	-9.92	31.28	3	H	302	1.47	-
PK	2.4796G	87.25	Inf	-Inf	31.26	3	H	302	1.47	-
PK	2.4918G	55.23	74.00	-18.77	31.30	3	H	302	1.47	-



### BT-LE(1Mbps)

### 2480MHz\_TX

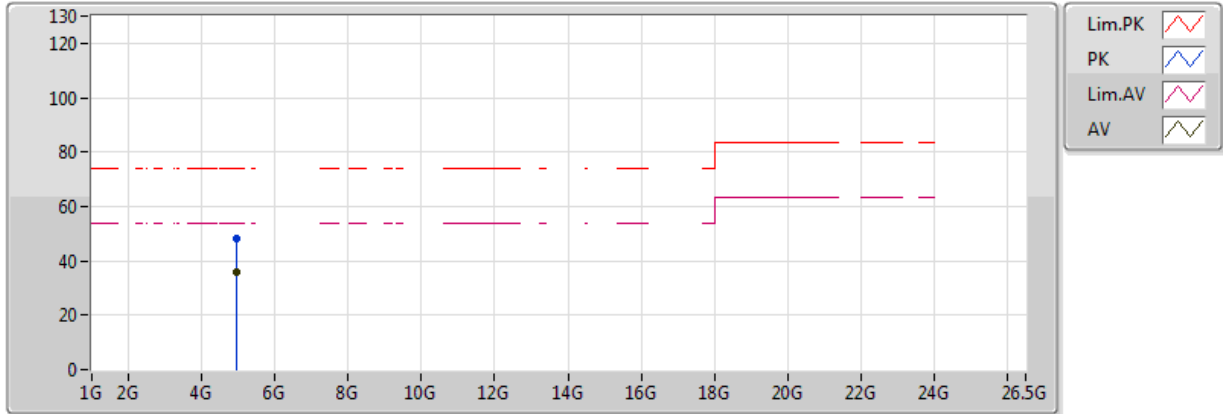

Ant=Z

Type	Freq(Hz)	Level(dBuV/m)	Limit(dBuV/m)	Margin(dB)	Factor(dB)	Dist(m)	Pol.(H/V)	Azimuth(°)	Height(m)	Comments
AV	4.96G	36.12	54.00	-17.88	2.59	3	V	208	3.65	-
PK	4.96G	48.28	74.00	-25.72	2.59	3	V	208	3.65	-

### BT-LE(1Mbps)

### 2480MHz\_TX

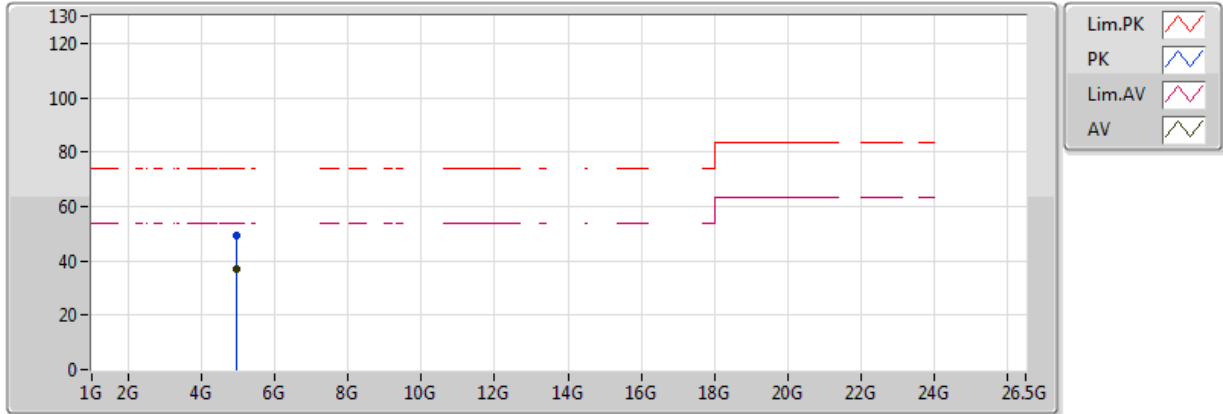

Ant=Z

Type	Freq(Hz)	Level(dBuV/m)	Limit(dBuV/m)	Margin(dB)	Factor(dB)	Dist(m)	Pol.(H/V)	Azimuth(°)	Height(m)	Comments
AV	4.96G	37.10	54.00	-16.90	2.59	3	H	166	2.79	-
PK	4.96G	49.43	74.00	-24.57	2.59	3	H	166	2.79	-