

Antenna specification

Antenna Sample Confirmation From

Name of supplier	ShenZhen Aihui Technology Co. , Ltd				
Customer name	Le Chang				
Sample name	PT26-DT68TX				
model					
Sample size					
Inspection item	Performance test	Visual inspection	Structure	In the news	Test results
Notes					
Quality Audit		Project Audit		Business confirmation	
The following is to be completed by the client					

Shenzhen Aihui Technology Co. , Ltd.

Customer feedback	
Customer signature/seal	date:

Antenna Test Report

Test Unit: Shenzhen Aihui Technology Co. , Ltd.			
Materials	Spring		
Antenna form	Monopole	Polarization mode	Linear
Application scenario			
Working band	315Mhz	VSWR	≤2

Address: 402TEL: 0755-23203435fax: 0755-23203435, Block C, Juxin Science and
Technology Industrial Park, Nanchang community, xixiang, Baoan District, Shenzhen

Shenzhen Aihui Technology Co. , Ltd.

Power	Max: 2W	Impedance	50Ω
dBi	≥-1dBi		
Test Equipment	HPE5071C、Shielding Room、3D automatic turntable		
<p>Antenna Description::</p> <p>1. Grounding processing and picture description: no</p> <p>2. Need to change the motherboard to match: no</p> <ul style="list-style-type: none">● Test voltage: 3.6V, check the antenna contact is good before testing.● The RF cable of the integrated tester is kept in a natural state and can not be curled. <p>Specification:test the specified power level, all indicators must conform to the specifications.</p>			

1. Project Image

2. Test Fixture

3. Antenna matching circuit

4. S11 test

5. Antenna passive efficiency and gain

6. Darkroom test equipment and data

7. Schematic diagram of antenna assembly

8. Antenna environment handling

9. Antenna mass production index

10. Structural drawing

1. Project Image

The final verification antenna performance prototype in our company for at least one year, easy to analyze and solve the problem of antenna mass production, to ensure the quality of antenna shipment

2. Test Fixture

Objective: to test the passive parameters of antenna as accurately as possible. Making Method: the handset is made of a 50 ohm coaxial cable, one end of which is connected to the test point of the back end of the matching circuit of the handset motherboard (front end of the RF test hole) , and the other end is connected to the SMA joint. The diagram is as follows:

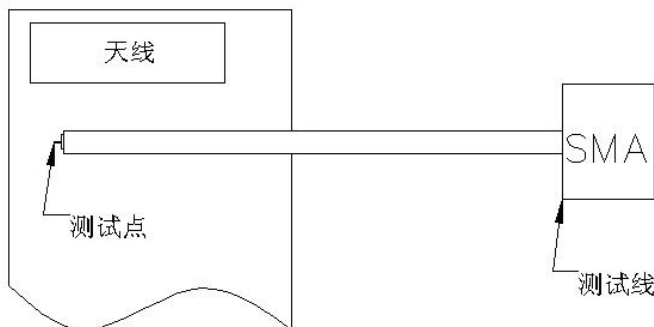

3. Antenna matching circuit

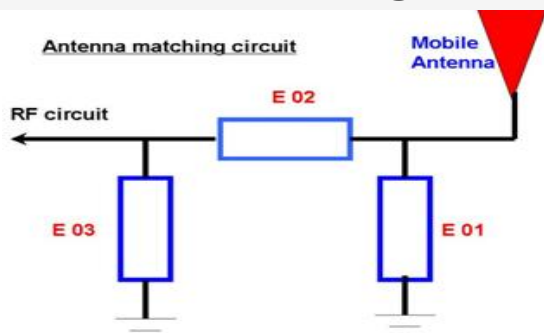

Modify

E01	E02	E03
No	No	No

Note: The match is unmodified.

4.S11 test

4.0 4.0s11 test method description of test equipment: Network Analyzer (E5071C) test method: a 50 ohm CABLE is used to export from the instrument test port. The SMA connector for connecting the handset is calibrated using a calibration piece, record the echo loss and standing wave ratio corresponding to the relevant frequency points. The test schematic is as follows:

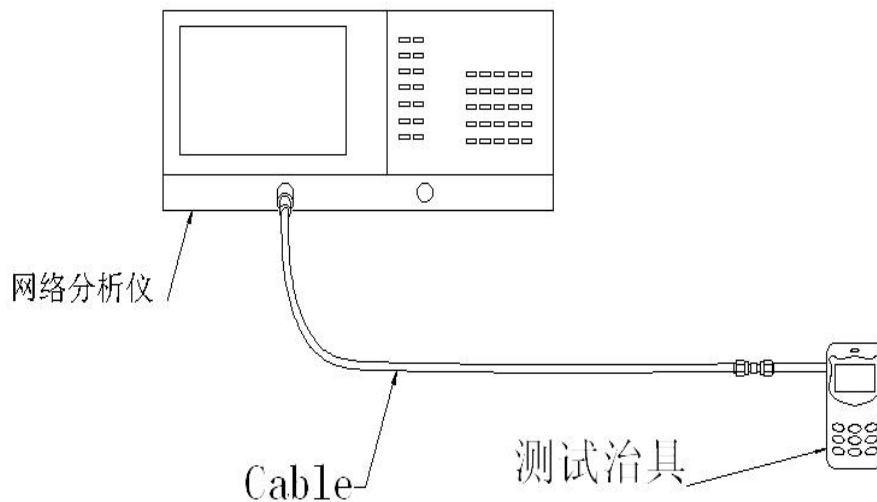

4.1 SWR

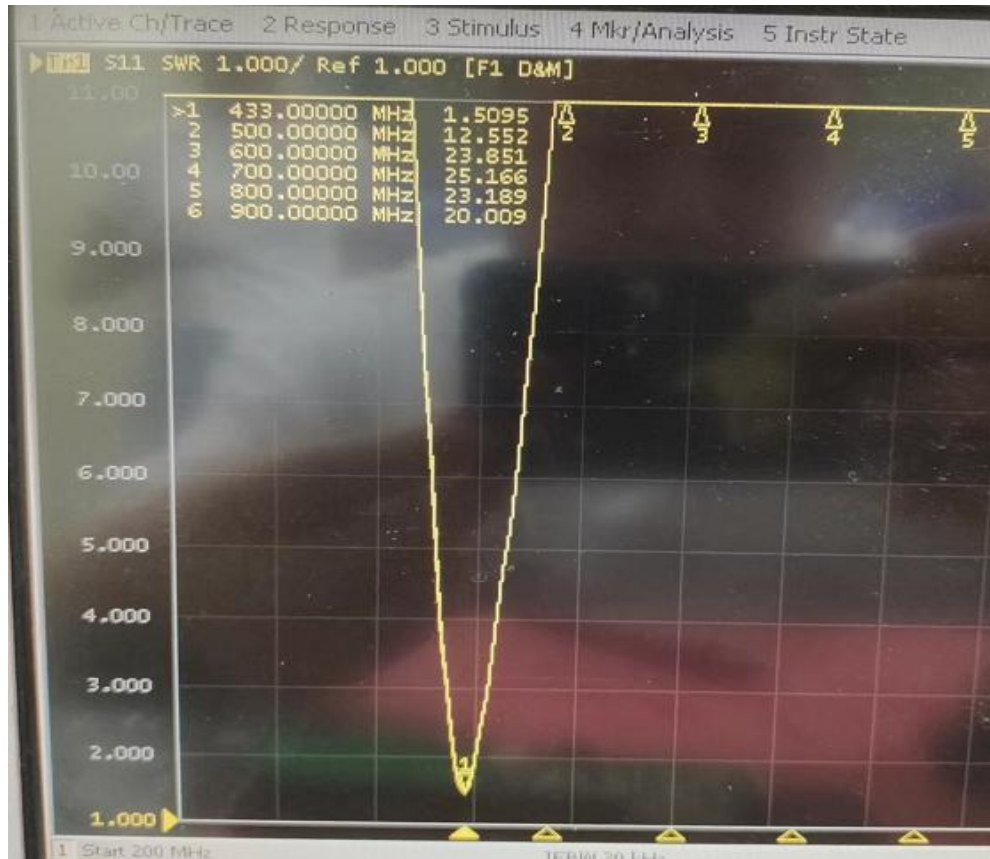

5.Darkroom test equipment and data

6.Test Equipment

Test system: shielded darkroom

The temperature was $22^{\circ}\text{C} \pm 3^{\circ}\text{C}$ and the humidity was $50\% \pm 15\%$

Test equipment: when testing passive data, use the Network analyzer AGILENTE5071C to test active data, use the omnibus CMW500

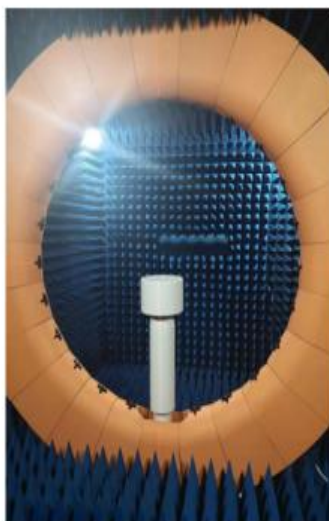

7.Active antenna test data

测试数据:		
433Mhz		
Freq(MHz)	Efficiency (%)	Gain (dBi)
310	30.4	0.23
311	31.2	0.32
312	32.3	0.44
313	33.5	0.53
314	34.3	0.12
315	31.4	0.13
316	32.3	0.25
317	30.2	-0.14
318	29.3	0.13

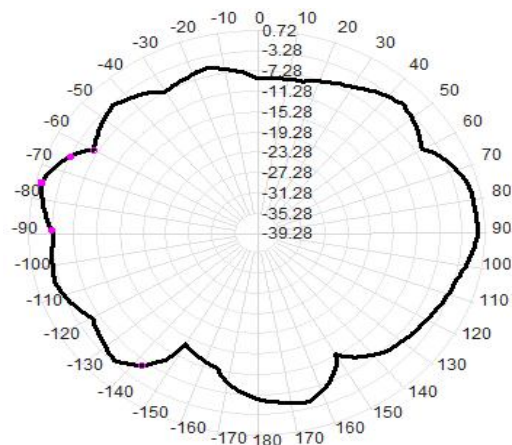
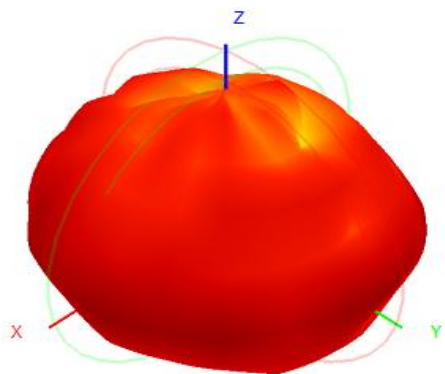

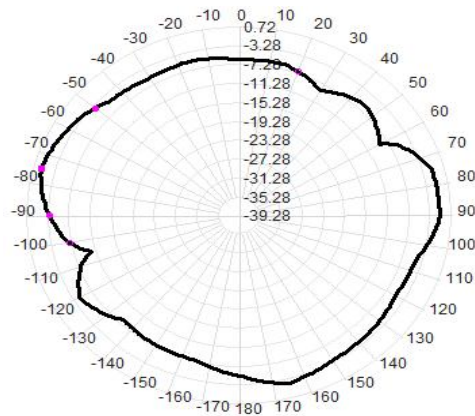
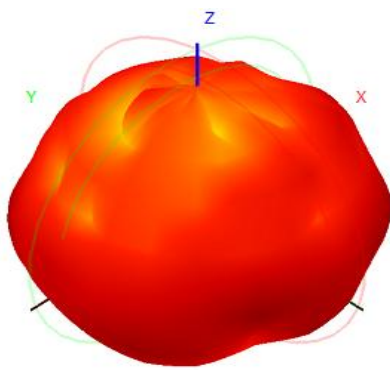

8.Schematic diagram of antenna assembly

9.Antenna environment handling

10.Antenna mass production index

<p>When the antenna is mass-produced, the standing wave ratio is taken as the mass-produced test standard. Based on the differences of the project itself, the following criteria are given:</p>	<p>Standard for volume production</p>
<p>824Mhz-2170Mhz</p>	<p>VSWR (Mass Production performance) & LT;</p>

	VSWR(recognition performance) 0.5
--	-----------------------------------

10.1 Structural drawings

