

EXPEDITION

Owner's Manual

XP106
PORTABLE PA WITH  Bluetooth



SAMSON

Copyright 2013
v1.7
Samson Technologies Corp.
45 Gilpin Avenue
Hauppauge, New York 11788-8816
Phone: 1-800-3-SAMSON (1-800-372-6766)
Fax: 631-784-2201
www.samsontech.com

The *Bluetooth*® word mark and logos are registered trademarks owned by Bluetooth SIG, Inc. and any use of such marks by Samson Technologies is under license. Other trademarks and trade names are those of their respective owners.”

Important Safety Information



AVIS
RISQUE DE CHOC ÉLECTRONIQUE -
NE PAS OUVRIR

WARNING: TO REDUCE THE RISK OF ELECTRIC SHOCK,
DO NOT REMOVE COVER (OR BACK) AS THERE ARE NO
USER-SERVICEABLE PARTS INSIDE. REFER SERVICING
TO QUALIFIED SERVICE PERSONNEL.



This lightning flash with arrowhead symbol within an equilateral triangle is intended to alert the user to the presence of non-insulated “dangerous voltage” within the product’s enclosure that may be of sufficient magnitude to constitute a risk of electric shock.



The exclamation point within an equilateral triangle is intended to alert the user to the presence of important operating and maintenance instructions in the literature accompanying the appliance.



If you want to dispose this product, do not mix it with general household waste. There is a separate collection system for used electronic products in accordance with legislation that requires proper treatment, recovery and recycling.

Private household in the 28 member states of the EU, in Switzerland and Norway may return their used electronic products free of charge to designated collection facilities or to a retailer (if you purchase a similar new one).

For Countries not mentioned above, please contact your local authorities for a correct method of disposal.

By doing so you will ensure that your disposed product undergoes the necessary treatment, recovery and recycling and thus prevent potential negative effects on the environment and human health.

Important Safety Information

1. Read these instructions.
2. Keep these instructions.
3. Heed all warnings.
4. Follow all instructions.
5. Do not use this apparatus near water.
6. Clean only with dry cloth.
7. Do not block any ventilation openings. Install in accordance with the manufacturer's instructions.
8. Do not install near any heat sources such as radiators, heat registers, stoves, or other apparatus (including amplifiers) that produce heat.
9. Do not defeat the safety purpose of the polarized or grounding type plug. A polarized plug has two blades with one wider than the other. A grounding type plug has two blades and a third grounding prong. The wide blade or the third prong are provided for your safety. If the provided plug does not fit into your outlet, consult an electrician for replacement of the obsolete outlet.
10. Protect the power cord from being walked on or pinched particularly at the plugs, convenience receptacles, and at the point where they exit from the apparatus.
11. Only use attachments/accessories specified by the manufacturer.
12. Use only with the cart, stand, tripod, bracket, or table specified by the manufacturer, or sold with the apparatus. When a cart is used, use caution when moving the cart/apparatus combination to avoid injury from tip-over.
13. Unplug the apparatus during lightning storms or when unused for long periods of time.
14. Refer all servicing to qualified personnel. Service is required when the apparatus has been damaged in any way, such as power supply cord or plug is damaged, liquid has been spilled or objects have fallen into the apparatus has been exposed to rain or moisture, does not operate normally, or has been dropped.
15. This appliance shall not be exposed to dripping or splashing water and that no object filled with liquid such as vases shall be placed on the apparatus.
16. Caution-to prevent electrical shock, match wide blade plug wide slot fully insert.
17. Please keep a good ventilation environment around the entire unit.
18. To prevent injury, this apparatus must be securely attached to the stand in accordance with the installation instructions.
19. **WARNING:** The battery (battery or batteries or battery pack) shall not be exposed to excessive heat such as sunshine, fire or the like.
20. **CAUTION:** Danger of explosion if battery is incorrectly replaced. Replace only with the same or equivalent type.



Important Safety Information

FCC Notice

1. This device complies with Part 15 of the FCC Rules. Operation is subject to the following two conditions:
 - (1) This device may not cause harmful interference.
 - (2) This device must accept any interference received, including interference that may cause undesired operation.
2. Changes or modifications not expressly approved by the party responsible for compliance could void the user's authority to operate the equipment.

FCC Statement

This equipment has been tested and found to comply with the limits for a Class B digital device, pursuant to Part 15 of the FCC Rules. These limits are designed to provide reasonable protection against harmful interference in a residential installation.

This equipment generates uses and can radiate radio frequency energy and, if not installed and used in accordance with the instructions, may cause harmful interference to radio communications. However, there is no guarantee that interference will not occur in a particular installation. If this equipment does cause harmful interference to radio or television reception, which can be determined by turning the equipment off and on, the user is encouraged to try to correct the interference by one or more of the following measures:

- Reorient or relocate the receiving antenna.
- Increase the separation between the equipment and receiver.
- Connect the equipment into an outlet on a circuit different from that to which the receiver is connected.
- Consult the dealer or an experienced radio/TV technician for help.

RF Warning Statement

The device has been evaluated to meet general RF exposure requirement. The device can be used in portable exposure condition without restriction.

This device complies with RSS-310 of Industry Canada. Operation is subject to the condition that this device does not cause harmful interference.

CE0700

Table of Contents

Introduction	7
Features	8
Control Panel Features	9
Quick Start	11
Pairing with a <i>Bluetooth</i> ® device	12
Charging the Battery	13
Speaker Placement	14
Avoiding Feedback.	15
Quick Start - Stage XPD1 Wireless System	16
Stage HXD1 Handheld Transmitter Controls	18
Stage RXD1 Receiver Controls	19
Using the LINE IN/OUT Jack	20
Making Connections	21
XP106 Specifications	22

Introduction

Thank you for purchasing the XP106 battery-powered portable sound system, featuring wireless *Bluetooth*[®] connectivity, to stream audio from your smart phone, tablet, or computer. The XP106 is a complete all-in-one solution providing the flexibility of a four-channel mixer (with inputs for a microphone and line level devices), a line output for linking multiple speakers, and a Music/Speech tone switch.

For added flexibility, the XP106 mixer has a USB jack for connecting the Samson Stage XPD1 digital handheld wireless system, creating a completely cordless performance.

Lightweight and compact, the XP106 features 100 watts of power weighing less than 20lbs, makes it an excellent complement to any mobile speaker application. The internal battery provides up to 20 hours of audio on a full charge. The XP106 can also be powered by the included AC adaptor for continuous audio.

Whether you are looking for a sound system for use outdoors, in the classroom, for karaoke, for presentations, or performing live music, the XP106 provides high quality, portable audio in a small self-powered package.

We recommend you keep the following records for reference, as well as a copy of your sales receipt.

Serial number: _____

Date of purchase: _____

Dealer name: _____

With proper care and maintenance, your XP106 will operate trouble-free for many years. Should your speaker ever require servicing, a Return Authorization (RA) number must be obtained before shipping your unit to Samson. Without this number, the unit will not be accepted. Please call Samson at 1-800-3SAMSON (1-800-372-6766) for an RA number prior to shipping your unit. Please retain the original packing materials and, if possible, return the unit in its original carton. If your XP106 was purchased outside of the United States, contact your local distributor for warranty details and service information.

Features



- Lightweight, 100 watt PA system that weighs under 20 pounds
- Bluetooth connectivity to connect wireless music sources
- 2-way speaker enclosure with 6-inch woofer and 1-inch high frequency driver
- Four channel mixer with microphone, line level, and USB wireless receiver inputs.
- Integrated 1 3/8-inch speaker stand mount
- Ergonomic top carry handle
- Internal rechargeable battery for up to 20 hours of continuous use
- System equalization contour switch for music and spoken word applications
- Link output for expanding your sound system

Accessories

- XP106 - Dynamic handheld microphone with XLR cable
- XP106w - Stage XPD1 digital handheld wireless system with USB receiver and handheld transmitter

Control Panel Features

1. **MIC/INST Input** - Use this XLR/¼" input for microphone, instrument with and active preamp or a line signal.

2. **LEVEL (CHANNEL 1)** - Used to control the level of the CHANNEL 1 Mic/Line input.

3. **AUX IN** - Connect a line level device using a 3.5mm audio cable.

4. **LINE Input** - ¼" input used to connect instrument or line level signals.

5. **LEVEL (CHANNEL 2)** - Used to control the level of the MP3 IN and LINE inputs.

6. **2.4GHz WIRELESS Input*** - Connect the Samson Stage XPD1 digital wireless USB receiver to this input. The wireless receiver gets its power from the XP106, so no additional power supply is needed.

7. **LEVEL (WIRELESS)** - Used to control the level of the 2.4GHz WIRELESS input.

8. **LINE OUT** - ¼" output connector to link multiple XP106 systems together

9. **LEVEL (BLUETOOTH®)** - Used to control the level of the *Bluetooth* input.

10. **SPEECH/MUSIC Switch** - This switch is used to change the overall frequency response, or tone contour, for the XP106 sound system. If your application is mainly for music, leave the switch up to select the MUSIC response curve. If your application is mainly for spoken word, press the switch down to select the SPEECH response curve.

11. **Power** - Switches on the main power.

12. **PEAK LED** - The Red LED illuminates at the level where distortion occurs.

13. **Battery Indicator** - Displays the status of the battery charge level.

14. **DC IN** - Connect the supplied power adapter here.

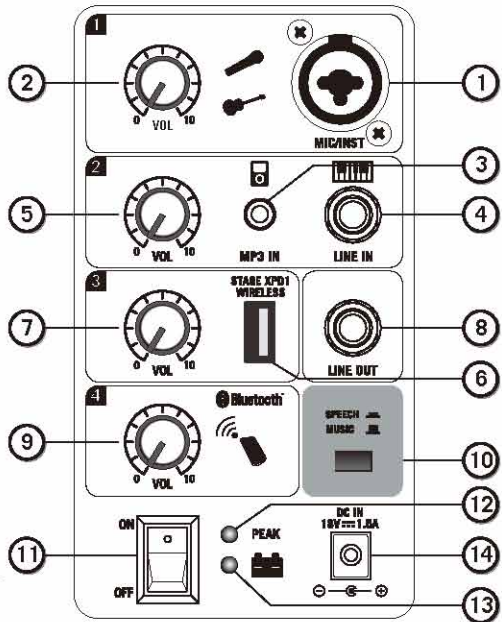

* The USB connector is for the Stage XPD1 receiver only. The connector is not designed to charge smartphones, tablets, or similar devices.

Control Panel Features

- 15. **Pairing Indicator** - Displays the *Bluetooth* status of the XP106 system.
- 16. **Pairing Button** - Press this button to enable pairing mode in order to connect to a *Bluetooth* audio device.

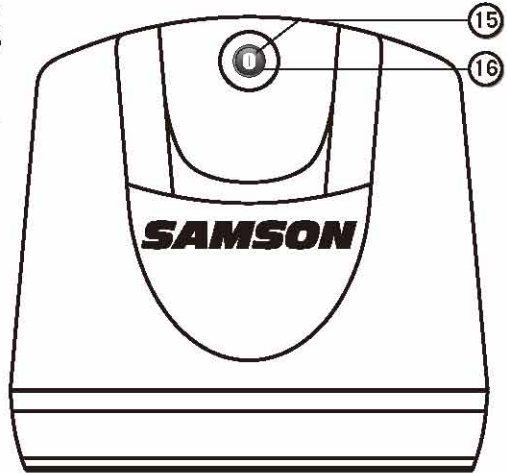

Quick Start

Follow these steps below to quickly get started using your XP106 portable sound system.

- Set the XP106's power switch to the **OFF** position, and fully turn all of the **LEVEL** controls counterclockwise to **0**.
- If an outlet is available, connect the included power adaptor to the **DC IN** of the speaker, and plug it into an AC socket.
- Connect a microphone using a standard XLR cable, line level equipment using a ¼" instrument cable, or portable audio device using a ⅛" cable.
- Switch on the XP106 power.
- While speaking into the microphone or playing music from a line level audio source, slowly raise the channel **LEVEL** until you have reached the desired level.

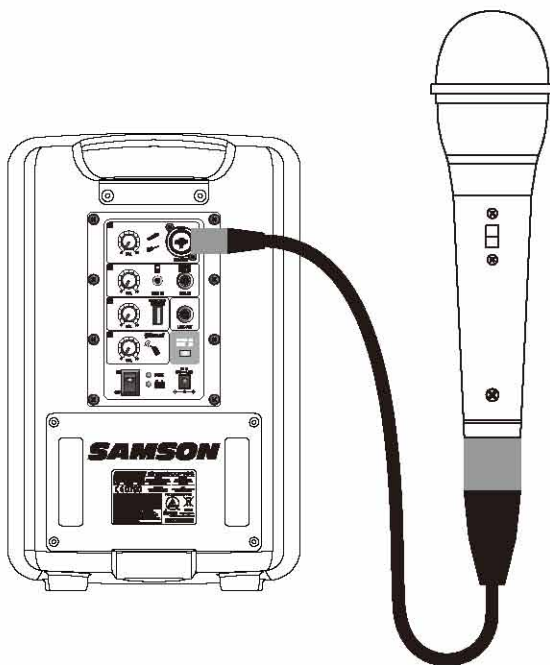

NOTE: If not using the channel 1 input, turn the LEVEL control all the way down to keep out any unwanted noise.

Setting a Good Level

Use the Channel LEVEL controls to set the individual volume of your microphone, line level and *Bluetooth*[®] devices.

The PEAK light illuminates when the signal sending to the internal amplifier begins to reach a level where distortion occurs. If the PEAK lights stay on, your mix is too hot and you need to lower the LEVEL controls. It is okay for the PEAK light to occasionally light, however it should go off quickly and should not constantly stay on.

Pairing with a Bluetooth® device

Bluetooth® is a wireless communication technology that allows for connectivity between a wide range of devices. The XP106 uses *Bluetooth* to stream high quality audio from your *Bluetooth* enabled device without the need for connecting any cables. In order for your device to work with the XP106 it must first be paired.

1. Turn all channel VOL controls down counterclockwise to **0**.
2. With the XP106 and your *Bluetooth* device powered on; press the PAIR button on the top panel of the XP106 speaker to make the speaker discoverable. The *Bluetooth* indicator will slowly flash blue.
3. In the settings of your *Bluetooth* device, set it to “discover” available devices.
4. From the *Bluetooth* device list, select the "Samson XP106" device.
5. If your device asks for a passkey, enter digits 0000 (four zeros) and press OK. Some devices may also ask you to accept the connection.
6. As the XP106 is connecting to your device, the *Bluetooth* indicator will quickly flash blue.
7. The XP106 speaker indicates that pairing is complete when the indicator turns steady blue. You can now stream audio from your device to the XP106 speakers.
8. With the volume control on your *Bluetooth* device turned up, play some music, and slowly raise the XP106 BLUETOOTH channel **VOL** control until you have reached the desired level.



Charging the Battery

The XP106 has an internal, rechargeable battery capable of up to 20 hours of continuous audio on a full charge. Even though the system may have some charge when first taken out of the box, we recommend fully charging your XP106 before first using the system.

To charge the battery:

- Set the power switch to the “OFF” position.
- Connect the XP106 to an AC power outlet using the included power adapter.
- Keep the system plugged in until the Battery indicator changes to green, indicating the battery is fully charged.

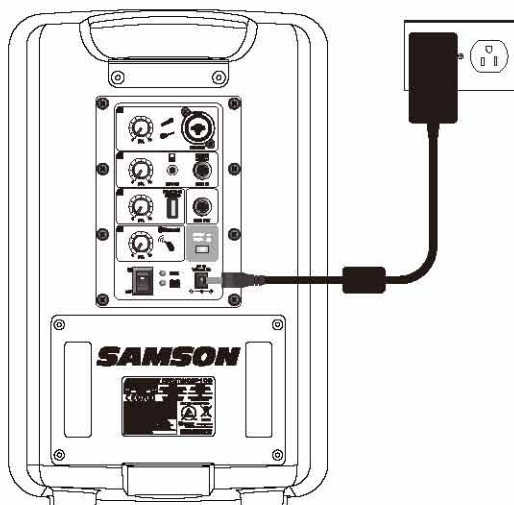

The XP106 utilizes a sealed lead-acid gel cell battery. When not in use, the battery will slowly self-discharge. If you are planning not to use the XP106 for a long period of time, it is advised to fully charge the unit before storing. It is also important to charge the unit every six months when not used. This will ensure a healthy battery and extend its life. If the battery is left with a very low charge for an extended period of time, it is possible to recharge the battery to working condition, but the charge time can take over 24 hours.

If you find that the operation time of the XP106 becomes noticeably decreased, even after fully charging, the battery should be replaced. Contact Samson customer service or your local distributor for a replacement battery.

Speaker Placement

The XP106 provides three different placement options for your specific situation.

For maximum sound coverage the XP106 can be used with a standard 1 $\frac{3}{8}$ " speaker stand. The speaker should be raised above the heads of the listening audience. Take care when placing the speaker on a stand, to ensure that it is on a level, steady surface and will not tip over.



Take care when placing the XP106 in direct sunlight for long periods of time, as this may discolor or damage the unit.

Do not place the speaker on wet surfaces, as it can cause malfunction. If you notice condensation on the unit, dry the speaker before using or storing.

Avoiding Feedback

Feedback is the annoying *howling* and squealing that can heard when the microphone picks up sound from the speaker. The sound is then re-amplified back through the speaker again, creating a feedback loop. Follow these steps to minimize the likelihood of feedback:

- Avoid pointing the microphone directly at the speaker. In general it is recommended that the microphone be positioned behind the speaker enclosure. This uses the directional characteristics of the speaker and microphone to your advantage.
- Keep the microphone as far from the speaker as possible. This will help achieve isolation between the speaker and the microphone, and allow you to increase the output of the XP106.
- Position the microphone as close to the sound source as possible. This will enable the microphone to pick up more direct sound, and allow you to reduce the microphone input gain control.
- Reduce the overall level of the speaker.

Quick Start - Stage XPD1 Wireless System

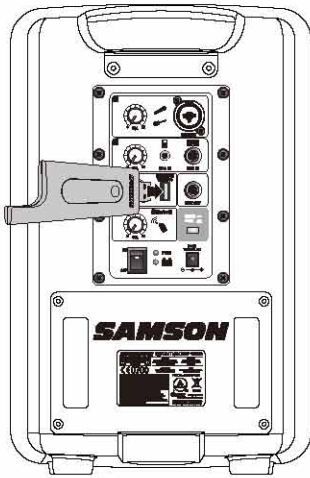

Plug the RXD1 USB receiver into the USB jack labeled 2.4GHz WIRELESS.

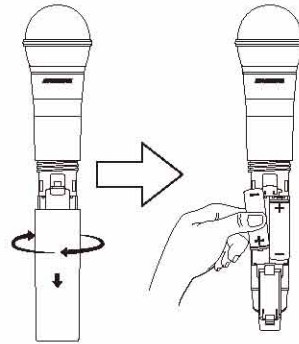

On the wireless handheld transmitter, unscrew the bottom section of the microphone by turning it counterclockwise and then slide it off. Place a fresh set of AA (LR6) batteries in the transmitter battery holder, taking care to observe the polarity markings, then replace the cover.

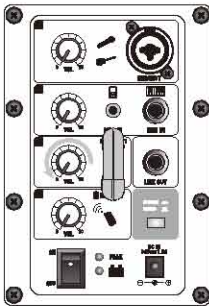

Turn the WIRELESS LEVEL knob on the XP106 completely counterclockwise to 0, then turn the POWER switch on the XP106 to the ON position.

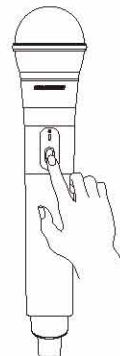

Turn on the power to the transmitter by pressing and holding Power switch; the indicator LED will light amber.

Quick Start - Stage XPD1 Wireless System

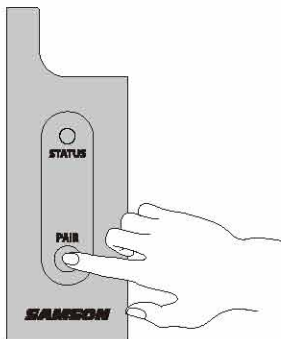

If the handheld transmitter and receiver have not been previously paired, press and hold the button on the RXD1 receiver for >5 seconds, until it begins to flash.

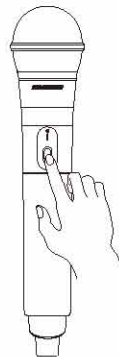

Press and hold the Power button on the handheld transmitter >5 seconds. This will put both components into pairing modes. Once the receiver and transmitter communicate and sync, the LEDs on both units will light steady and will be ready for operation.

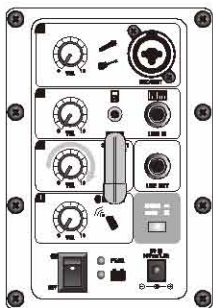

Speak or sing into the mic at a normal performance level and raise the WIRELESS LEVEL control until the desired level is reached.

If you hear distortion check the rear panel PEAK LED. If it is lit red, turn down the WIRELESS LEVEL on the XP106 until it lights only occasionally during loud sounds. If you still hear distortion, unscrew the microphone body and use the supplied plastic screwdriver to turn the Gain control in the HXD1 transmitter slowly counterclockwise until the distortion disappears.

Conversely, if you hear a weak, noisy signal at the desired volume level (and with the WIRELESS control of the XP106 turned fully clockwise), use the supplied plastic screwdriver to turn the Gain control in the HXD1 transmitter slowly clockwise until the signal reaches an acceptable level.

Stage HXD1 Handheld Transmitter Controls

1. **Status Indicator** - This LED displays the operation mode:

Amber	Normal Operation
Flashing Amber	Pairing/Low Battery

2. **Power/Pair Switch** - Press <5 seconds to turn the unit on or off. Press >5 seconds to enter pairing mode.
3. **Battery Cover** - Unscrew the battery cover and slide down to open the HXD1 battery compartment.
4. **Battery Holder** - Open the battery holder by pressing the tab and lifting the cover. Insert two standard AA (LR6) batteries here, being sure to observe the plus and minus polarity markings shown. Although rechargeable Ni-Cad batteries can be used, they do not supply adequate current for more than four hours. **WARNING:** Do not insert the batteries backwards; doing so can cause severe damage to the HXD1 and will void your warranty.

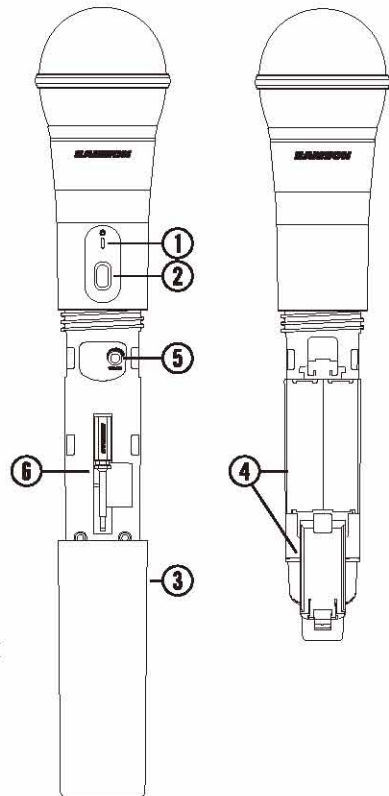

5. **Input GAIN Control** - This control adjusts the transmitter input sensitivity. This input sensitivity control has been factory preset to provide optimum level for the particular microphone capsule provided with the Stage XPD1 system and so we recommend that this not be adjusted manually. If necessary, however, you can use the supplied plastic screwdriver to raise or lower the input level.

Stage RXD1 Receiver Controls

1. **USB Connector** - Plugs into the USB 2.4GHz Wireless jack on the rear panel of the XP106. The receiver can also plug directly into a computer USB port and will be recognized as a USB audio device. The unit passes audio to the device and receives power from the device through this connector.
2. **PAIR Switch** - Press >5 seconds to enter pairing mode.
3. **STATUS Indicator** - This LED displays the operation mode:

Amber	Normal Operation
Flashing Amber	Pairing
No Light	Not Paired; Transmitter Out Of Range; No Power

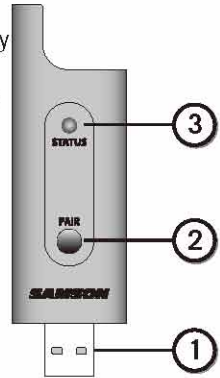

Using the LINE OUT Jack

The XP106 LINE OUT jack allows you to connect the XP106 with any powered speaker to expand your system or link two XP106 systems together and share all inputs between the two units. You can also use the jack to receive audio from another speaker without using an input channel.

Daisy Chain Speaker

Using a standard shielded $\frac{1}{4}$ " instrument cable, connect the LINE OUT on the XP106 to a line level input of second powered speaker. The XP106 will send a mix of all inputs, including Bluetooth® audio. Each channel LEVEL will control corresponding output level to the LINE OUT jack.

Linking Two XP106 Systems

To use two XP106's as one system is simple. Just connect each side using a standard $\frac{1}{4}$ " Shielded instrument cable to the LINE OUT jack located on each XP106 rear panel. Both mixers and the microphones or instruments connected to each of the individual XP106 systems will be heard in both speakers.

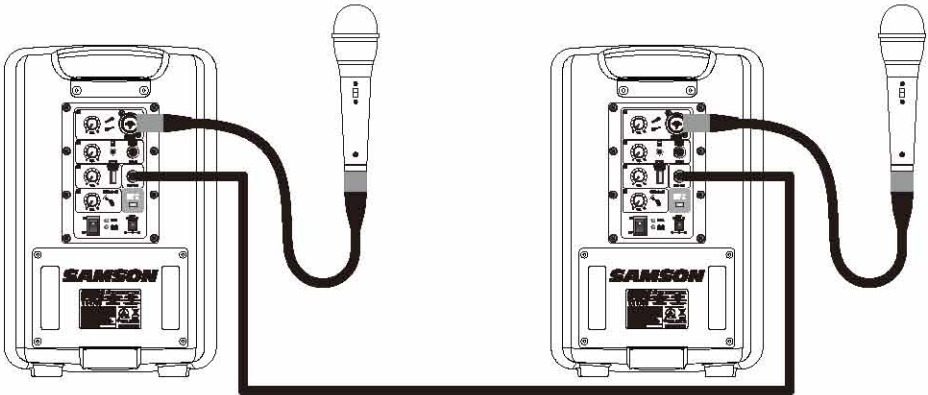

Auxiliary Line Input

The LINE OUT jack can be used to accept any line level input source. This input does not have a level control, so you must utilize the output level of the connected device to control the level of the audio in the XP106.

Making Connections

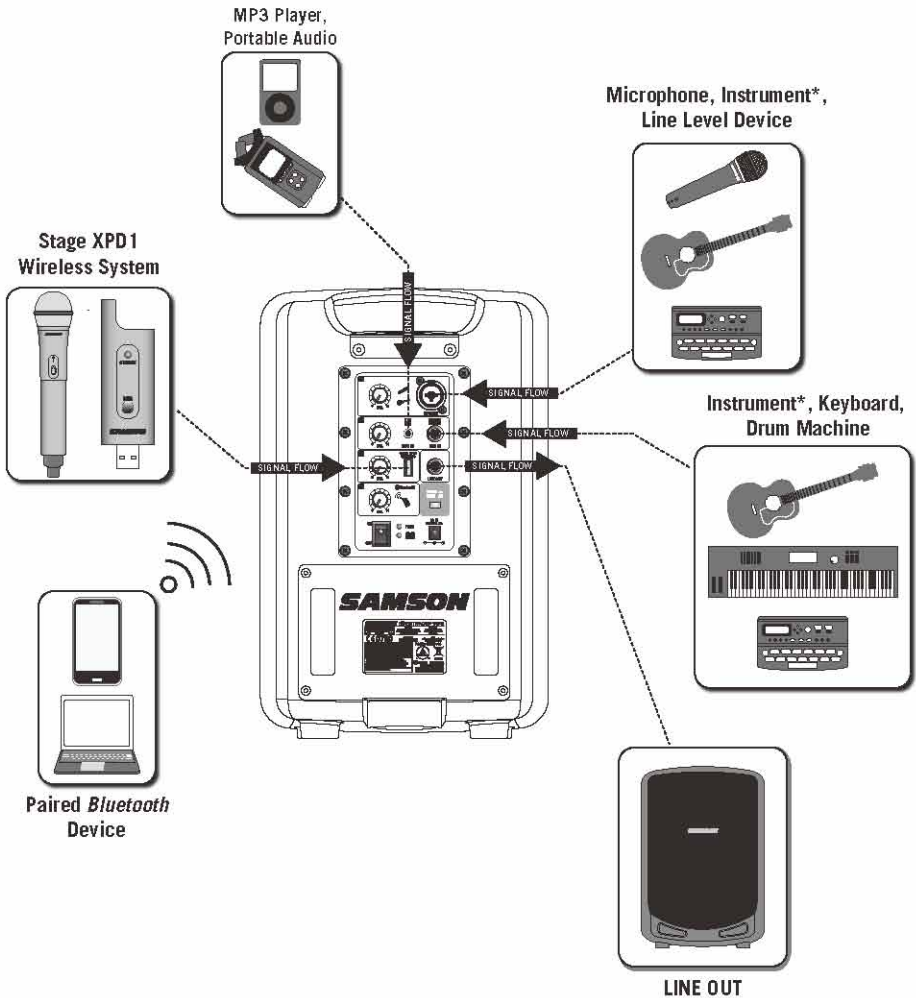

** An active preamp is needed in order to use acoustic instruments with the XP106.*

XPI06 Specifications

Power Output	100 watts
Frequency Response	75 Hz to 15kHz +/-3dB
Mic/Instrument Input	XLR / ¼" combo connector
Line Input	¼"
Aux Input	⅛"
Wireless Input	USB
LEVEL Controls	Mic/Inst, Line/Aux, Wireless, Bluetooth
Tone Control	Speech/Music switch
Line Input/Output	¼" TS
Bluetooth	Bluetooth 3.0, A2DP
Speakers.	6" Woofer + 1" HF Driver
Built-in Battery.	12V / 8AH, Rechargeable & Sealed
Operation	Up to 20 hours subject to operating conditions
Battery Charging	Approx. 4-8 hours for a single charge
AC/DC Adapter	SMPS AC100~240V, 50~60Hz/ DC18V-1.5A
Construction	Polypropylene, internally ribbed
Grill	Perforated Steel Grill, powder coated
Mounting	Integral 1 3/8-inch Pole Mount Receptacle
Operating Temperature	-10°C ~ +40°C
Dimensions (LxDxH)	9.5" x 9" x 14.2" 240 mm x 230 mm x 360 mm
Weight.	16.3 lb 7.4 kg

Stage XPD1 Specifications

Simultaneous Systems	2
Working Range	100' line of sight
Working Frequency	2.404~2.476GHZ
Modulation type	GFSK
Audio Frequency Response	20HZ - 16KHZ
T.H.D	<0.1% (at 1KHz, -10dBu)
Signal to Noise.	>85 dB
Operating Temperature	-10°C ~ +40°C

Stage HXD1

Microphone Element	Q6 Dynamic
RF Power	<10 mW EIRP
Power Requirements	Two AA (LR6) alkaline batteries
Battery Life	20 hours
Dimensions	10.2" x ø2.1" 260 mm x ø54 mm
Weight.	0.5 lb 218 g

Stage RXD1

Max. Analog Audio Output Level.	0 dBu
Audio Output Impedance	100 Kohms
USB audio sample rate	32 KHZ
USB audio support	Vista, Win7, Win8, Mac OSX without driver
Operating Voltage	5V DC
Dimensions (LxDxH)	3.5" x 0.9" x .31" 89 mm x 23 mm x 8 mm
Weight.	0.35 oz 10 g

Samson Technologies Corp.
45 Gilpin Avenue
Hauppauge, New York 11788-8816
Phone: 1-800-3-SAMSON (1-800-372-6766)
Fax: 631-784-2201
www.samsontech.com