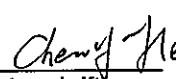
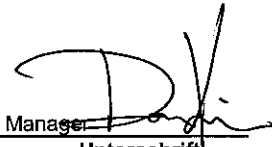

<b>Prüfbericht - Nr.:</b> 16016703 001		<b>Seite 1 von 27</b>			
<i>Test Report No.:</i>		<i>Page 1 of 27</i>			
<b>Auftraggeber:</b> <i>Client:</i>	Sam Ash Music Corporation 262 Duffy Avenue Hicksville NY, 11801 Unite States				
<b>Gegenstand der Prüfung:</b> <i>Test item:</i>	Wireless Microphone Receiver				
<b>Bezeichnung:</b> <i>Identification:</i>	UM1	<b>FCC ID:</b> <i>FCC ID</i>	CCR-UM1		
<b>Wareneingangs-Nr.:</b> <i>Receipt No.:</i>	173043551	<b>Eingangsdatum:</b> <i>Date of receipt:</i>	19.Mar.2009		
<b>Prüfört:</b> <i>Testing location:</i>	TÜV Rheinland (Guangdong) Ltd. EMC Laboratory  Guangzhou Auto Market, Yuan Gang Section of Guangshan Road, Guangzhou 510650,  P. R. China		Listed test laboratory according to FCC rules section 2.948 for measuring devices under Parts 15		
<b>Prüfgrundlage:</b> <i>Test specification:</i>	ANSI C63.4:2003 FCC Part 15: 20, Sep. 2007 Subpart B section 15.107, 15.109				
<b>Prüfergebnis:</b> <i>Test Result:</i>	Der Prüfgegenstand entspricht oben genannter Prüfgrundlage(n). <i>The test item passed the test specification(s).</i>				
<b>Prüflaboratorium:</b> <i>Testing Laboratory:</i>	TÜV Rheinland (Guangdong) Ltd.				
<b>geprüft/ tested by:</b>	<b>kontrolliert/ reviewed by:</b>				
11. May 2009 Cherry He/Project Manager 		11. May 2009 Liangdong Xie/Project Manager 			
<i>Datum</i> Date	<i>Name/Stellung</i> Name/Position	<i>Unterschrift</i> Signature	<i>Datum</i> Date		
			<i>Name/Stellung</i> Name/Position		
			<i>Unterschrift</i> Signature		
<b>Sonstiges/ Other Aspects:</b>					
<table style="width:100%; border: none;"> <tr> <td style="width: 50%; vertical-align: top;"> <b>Abkürzungen:</b>                  P(ass) = entspricht Prüfgrundlage                  F(ail) = entspricht nicht Prüfgrundlage                  N/A = nicht anwendbar                  N/T = nicht getestet             </td> <td style="width: 50%; vertical-align: top;"> <b>Abbreviations:</b>                  P(ass) = passed                  F(ail) = failed                  N/A = not applicable                  N/T = not tested             </td> </tr> </table>				<b>Abkürzungen:</b> P(ass) = entspricht Prüfgrundlage F(ail) = entspricht nicht Prüfgrundlage N/A = nicht anwendbar N/T = nicht getestet	<b>Abbreviations:</b> P(ass) = passed F(ail) = failed N/A = not applicable N/T = not tested
<b>Abkürzungen:</b> P(ass) = entspricht Prüfgrundlage F(ail) = entspricht nicht Prüfgrundlage N/A = nicht anwendbar N/T = nicht getestet	<b>Abbreviations:</b> P(ass) = passed F(ail) = failed N/A = not applicable N/T = not tested				
Dieser Prüfbericht bezieht sich nur auf das o.g. Prüfmuster und darf ohne Genehmigung der Prüfstelle nicht auszugsweise vervielfältigt werden. Dieser Bericht berechtigt nicht zur Verwendung eines Prüfzeichens. This test report relates to the a. m. test sample. Without permission of the test center this test report is not permitted to be duplicated in extracts. This test report does not entitle to carry any safety mark on this or similar products.					

Prüfbericht - Nr.: **16016703 001**  
Test Report No.:

Seite 2 von 27  
Page 2 of 27

## TEST SUMMARY

**5.1 CONDUCTED EMISSION FOR FCC PART 15 PER SECTION 15.107(A)**

RESULT: *Pass*

**5.2 RADIATED EMISSION FOR FCC PART 15 PER SECTION 15.109(A)**

RESULT: *Pass*

## Contents

<b>1</b>	<b>GENERAL REMARKS.....</b>	<b>4</b>
<b>1.1</b>	<b>COMPLEMENTARY MATERIALS .....</b>	<b>4</b>
<b>2</b>	<b>TEST SITES.....</b>	<b>4</b>
<b>2.1</b>	<b>TEST FACILITIES .....</b>	<b>4</b>
<b>2.2</b>	<b>LIST OF TEST AND MEASUREMENT INSTRUMENTS .....</b>	<b>5</b>
<b>2.3</b>	<b>TRACE ABILITY .....</b>	<b>5</b>
<b>2.4</b>	<b>CALIBRATION .....</b>	<b>6</b>
<b>2.5</b>	<b>MEASUREMENT UNCERTAINTY .....</b>	<b>6</b>
<b>2.6</b>	<b>LOCATION OF ORIGINAL DATA.....</b>	<b>6</b>
<b>2.7</b>	<b>STATUS OF FACILITY USED FOR TESTING.....</b>	<b>6</b>
<b>3</b>	<b>GENERAL PRODUCT INFORMATION.....</b>	<b>7</b>
<b>3.1</b>	<b>PRODUCT FUNCTION AND INTENDED USE .....</b>	<b>7</b>
<b>3.2</b>	<b>RATINGS AND SYSTEM DETAILS .....</b>	<b>7</b>
<b>3.3</b>	<b>INDEPENDENT OPERATION MODES .....</b>	<b>7</b>
<b>3.4</b>	<b>SUBMITTED DOCUMENTS .....</b>	<b>7</b>
<b>4</b>	<b>TEST SET-UP AND OPERATION MODE .....</b>	<b>8</b>
<b>4.1</b>	<b>PRINCIPLE OF CONFIGURATION SELECTION.....</b>	<b>8</b>
<b>4.2</b>	<b>TEST OPERATION AND TEST SOFTWARE.....</b>	<b>8</b>
<b>4.3</b>	<b>SPECIAL ACCESSORIES AND AUXILIARY EQUIPMENT .....</b>	<b>8</b>
<b>4.4</b>	<b>COUNTERMEASURES TO ACHIEVE EMC COMPLIANCE .....</b>	<b>8</b>
<b>4.5</b>	<b>TEST SET-UP.....</b>	<b>9</b>
<b>5</b>	<b>TEST RESULTS EMISSION .....</b>	<b>11</b>
<b>5.1</b>	<b>CONDUCTED EMISSION FOR FCC PART 15 PER SECTION 15.107(A) .....</b>	<b>11</b>
<b>5.2</b>	<b>RADIATED EMISSION FOR FCC PART 15 PER SECTION 15.109(A) .....</b>	<b>14</b>
<b>6</b>	<b>PHOTOGRAPHS OF THE TEST SET-UP .....</b>	<b>24</b>
<b>7</b>	<b>LIST OF TABLES.....</b>	<b>27</b>
<b>8</b>	<b>LIST OF PHOTOGRAPHS.....</b>	<b>27</b>

Prüfbericht - Nr.: **16016703 001**  
Test Report No.:

Seite 4 von 27  
Page 4 of 27

## **1 General Remarks**

### **1.1 Complementary Materials**

No appendix attached in this report.

## **2 Test Sites**

### **2.1 Test Facilities**

**TÜV Rheinland (Guangdong) Ltd. EMC Laboratory**

Guangzhou Auto Market, Yuan Gang Section of Guangshan Road  
Guangzhou 510650

P. R. China

## 2.2 List of Test and Measurement Instruments

**Table 1: List of Test and Measurement Equipment**

Kind of Equipment	Type	Manufacturer	S/N	Calibrated until	Calibrated Interval
EMI Test Receiver	ESCI	Rohde & Schwarz	100216	26.Nov.2009	1 year
Spectrum Analyzer	FSP30	Rohde & Schwarz	100286	24.Aug.2009	1 year
Trilog-Broadband Antenna	VULB9168	SCHWARZBECK MESS-ELEKTRONIK	210	07.Nov.2009	2 year
Double-Ridged Waveguide Horn Antenna	HF906	Rohde & Schwarz	100385	18.Jul.2009	2 year
Double-Ridged Waveguide Horn Antenna	HF906	Rohde & Schwarz	100407	08.May.2009	2 year
Pre-amplifier	AFS42- 00101800- 25-S-42	MITEQ	1101599	31.Jul.2009	2 year
Band Reject Filter	BRM50702	Micro-Tronics	023	15.Feb.2010	2 year
Standard Gain Horn Antenna	3160-09	EMCO	21642	N/A	2 year
Standard Gain Horn Antenna	3160-09	EMCO	21645	N/A	2 year
Pre-amplifier	AFS33- 18002650- 30-8P-44	MITEQ	1108282	31.Jul.2009	2 year
3m Anechoic Chamber	N/A	Albatross Project GmbH	N/A	16.Apr.2010	2 year
EMI Test Receiver	ESCS30	Rohde & Schwarz	100316	16.Mar.2010	1 year
Two-Line V-Network	ESH3-Z5	Rohde & Schwarz	100308	16.Mar.2010	1 year
Pulse Limiter	ESH3-Z2	Rohde & Schwarz	100701	16.Mar.2010	1 year

## 2.3 Trace ability

All measurement equipment calibrations are traceable to NIST or where calibration is performed outside the United States, to equivalent nationally recognized standards organizations

## 2.4 Calibration

Equipment requiring calibration is calibrated periodically by the manufacturer or according to manufacturer's specifications. Additionally all equipment is verified for proper performance on a regular basis using in house standards or comparisons.

## 2.5 Measurement Uncertainty

Uncertainty for conducted emissions measurements is  $\pm 2.51$ dB.

Uncertainty for radiated emissions measurements is  $\pm 4.94$ dB (30MHz-1GHz),  $\pm 4.84$ dB (>1GHz).

The reported expanded uncertainty is based on a standard uncertainty multiply by a coverage factor  $k=2$ , providing a level of confidence of approximately 95%.

## 2.6 Location of original data

The original copies of all test data taken during actual testing were attached on Page 12-13, 15-22 of this report and delivered to the applicant. A copy has been retained in the TUV Rheinland (Guangzhou) file for certification follow-up purposes.

## 2.7 Status of facility used for testing

TÜV Rheinland (Guangdong) Ltd. EMC Laboratory; Guangzhou Auto Market, Yuan Gang Section of Guangshan Road, Guangzhou 510650, P. R. China is listed on the US Federal Communications Commission list of facilities approved to perform measurements, the register no. 833845

Prüfbericht - Nr.: **16016703 001**  
Test Report No.:

Seite 7 von 27  
Page 7 of 27

### 3 General Product Information

The submitted sample UM1 is a wireless microphones receiver operating within the frequency range of 642.375 MHz to 645.750 MHz.

#### 3.1 Product Function and Intended Use

For details, refer to User Manual.

#### 3.2 Ratings and System Details

Frequency range	642.375 MHz - 645.750 MHz.	
Type of antenna	1/4 wavelength rod	
FCC ID:	CCRUM1	
Power consumption	DC 6-13V, 60mA Power by external AC/DC adaptor	9V battery
Ports	DC input, audio output	
Protection Class	III	

Refer to the technical document and user manual for further information.

#### 3.3 Independent Operation Modes

The basic operation modes are:

Receiving at a fixed frequency within the band 642.375 MHz to 645.750 MHz and not being changed by end user.

For further information refer to User Manual

#### 3.4 Submitted Documents

Block Diagram  
Circuit Diagram  
PCB Layout  
FCC Label  
User Manual  
Photo Document

## 4 Test Set-up and Operation Mode

### 4.1 Principle of Configuration Selection

**Emission:** The equipment under test (EUT) was configured to measure its highest possible radiation level. The test modes were adapted accordingly in reference to the instructions for use.

### 4.2 Test Operation and Test Software

Refer to Test set-up in chapter 5.

### 4.3 Special Accessories and Auxiliary Equipment

The product has been tested together with the following linear AC/DC adaptor:

Input : AC 120V, 60Hz  
Output : DC 12V / 500mA  
Protection class : II

### 4.4 Countermeasures to achieve EMC Compliance

The test sample, which has been tested, contained the noise suppression parts as described in the Constructional Data Form or the Technical document. No additional measures were employed to achieve compliance.



## 4.5 Test set-up

### Diagram 1 of Configuration for Testing Radiated Emission below 1 GHz

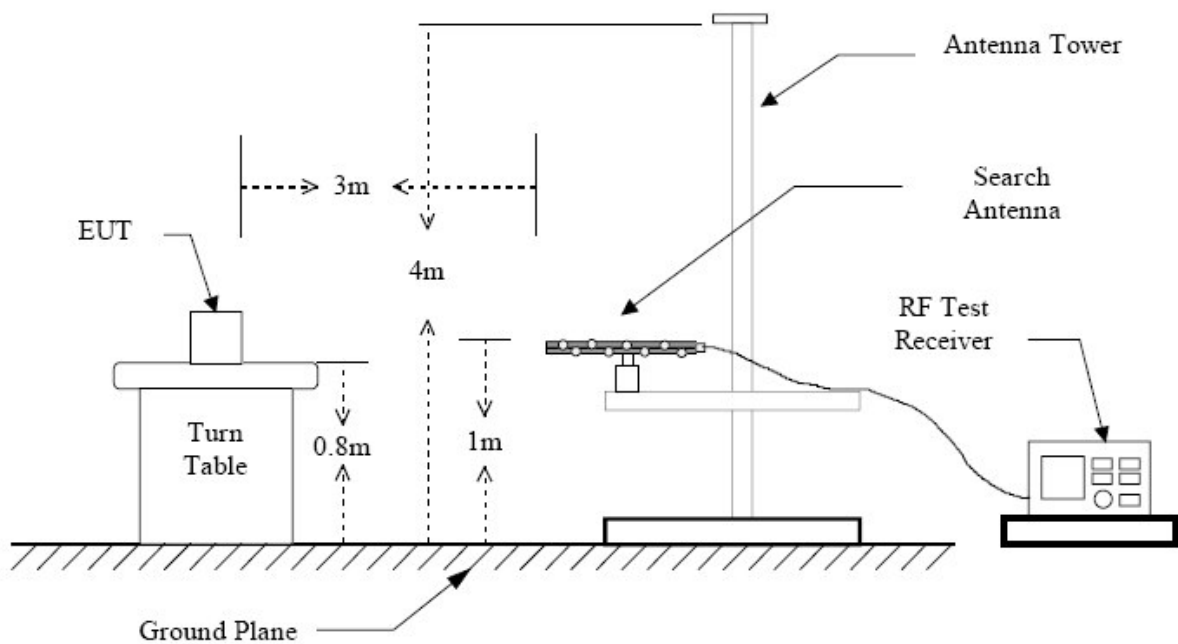

### Diagram 2 of Configuration for Testing Radiated Emission above 1 GHz

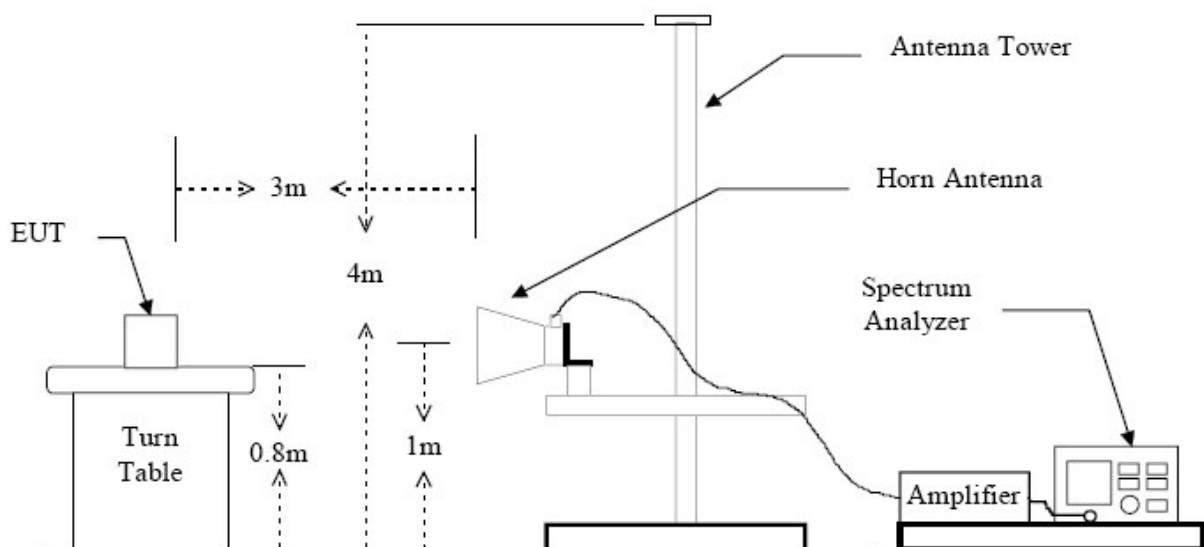

**Diagram 3 of Equipment Configuration for Testing Conducted Emission**

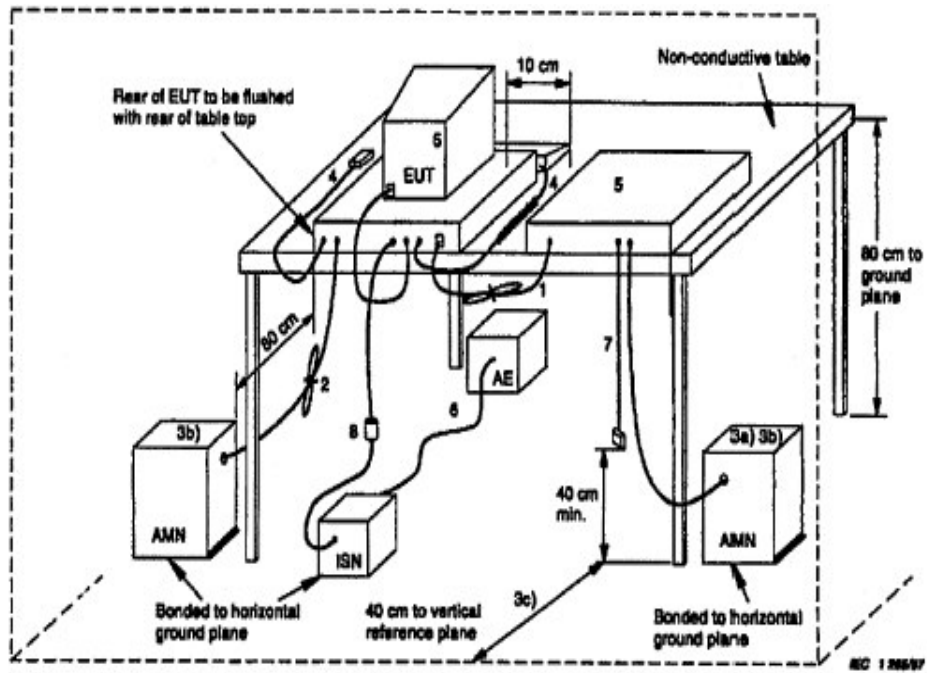

## 5 Test Results EMISSION

### 5.1 Conducted Emission for FCC Part 15 Per Section 15.107(a)

**RESULT:**

**Pass**

Date of testing	:	22.Apr.2009
Test specification	:	FCC Part 15 Per Section 15.107(a)
Limits	:	FCC Part 15 Per Section 15.107(a)
Test procedure	:	Procedure specified in ANSI C63.4 were followed
Deviations from Standard Test procedures	:	None
Kind of test site	:	Shielded room
Operation mode	:	Receiving (powered by linear AC/DC adaptor)
Temperature	:	23°C
Humidity	:	50%

**Test procedure:**

1. Place the EUT as specified in ANSI C63.4 Clause 7.2.1
2. Plug the LISN to a correct power source (pay attention to: AC/DC, voltage, frequency).
4. Connect the EUT to LISN.
5. Connect ESCS30 and LISN via a 50-ohm coaxial cable and a pulse limiter then begin exploratory measurement as specified in ANSI C63.4 Clause 7.2.3
6. Make final measurement as specified in ANSI C63.4 Clause 7.2.4 at L1 and N on the LISN.

If the result of the measurement with the Quasi Peak detector is below the Average limit, the measurement with Average Detector may be omitted.

The spectral diagrams in Appendix 1 display the exploratory measurement of un-weighted peak values and average values.

Disturbances other than those mentioned below are small or not detectable.

Prüfbericht - Nr.: **16016703 001**  
Test Report No.:

Seite 12 von 27  
Page 12 of 27

### Test Information

EUT Name: Wireless Receiver  
Model/Type: UM1  
Operating Conditions: Receiving  
Comment: AC 120V, 60Hz

Hardware Setup: 1phase LISN ESH3-Z5 to ESCS30  
Level Unit: dB  $\mu$  V

Subrange	Detectors	IF Bandwidth	Step Size	Meas. Time	Receiver
150kHz - 30MHz	Peak; Average	9kHz	4.5kHz	10ms	ESCS 30

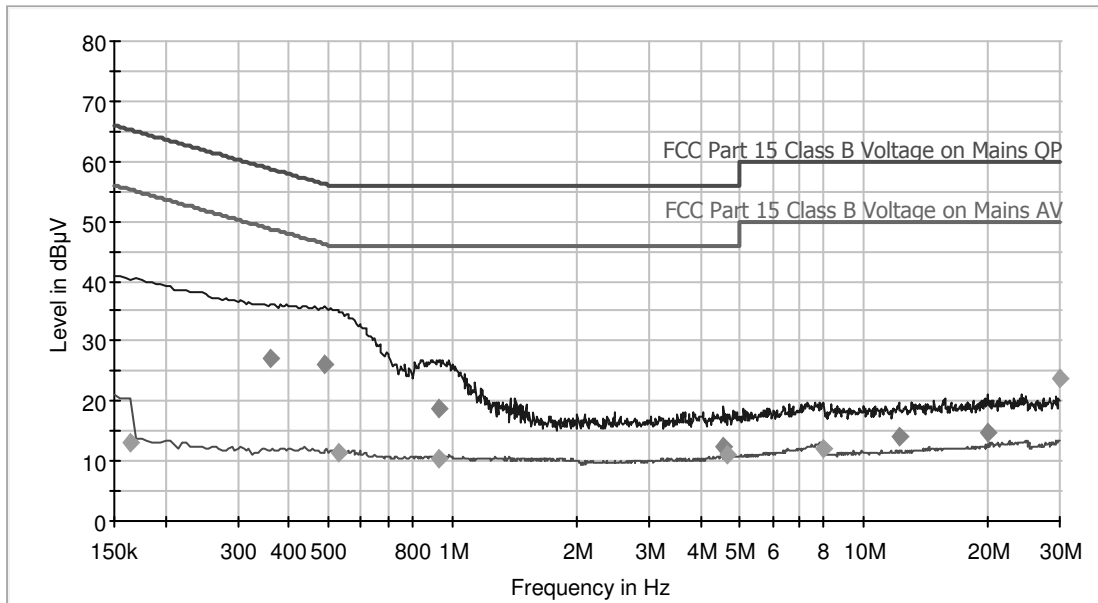

**Table 2: Disturbance Voltage on AC Mains**

**Final Measurement Detector 2**

Frequency (MHz)	Average (dB $\mu$ V)	Meas. Time (ms)	Bandwidth (kHz)	PE	Line
0.165000	13.0	1000.000	9.000	GND	N
0.530000	11.4	1000.000	9.000	GND	N
0.920000	10.5	1000.000	9.000	GND	N
4.679500	11.0	1000.000	9.000	GND	L1
8.021410	12.0	1000.000	9.000	GND	N
30.000000	23.9	1000.000	9.000	GND	L1

(continuation of the "Final Measurement Detector 2" table from column 6 ...)

Frequency (MHz)	Corr. (dB)	Margin (dB)	Limit (dB $\mu$ V)	Comment
0.165000	10.0	42.2	55.2	
0.530000	10.1	34.6	46.0	
0.920000	10.1	35.5	46.0	
4.679500	10.5	35.0	46.0	
8.021410	10.5	38.0	50.0	
30.000000	11.4	26.1	50.0	

**Final Measurement Detector 1**

Frequency (MHz)	QuasiPeak (dB $\mu$ V)	Meas. Time (ms)	Bandwidth (kHz)	PE	Line
0.360000	27.2	1000.000	9.000	GND	N
0.490000	26.1	1000.000	9.000	GND	N
0.925000	18.8	1000.000	9.000	GND	N
4.568750	12.4	1000.000	9.000	GND	N
12.198050	14.1	1000.000	9.000	GND	N
20.011100	14.8	1000.000	9.000	GND	L1

(continuation of the "Final Measurement Detector 1" table from column 6 ...)

Frequency (MHz)	Corr. (dB)	Margin (dB)	Limit (dB $\mu$ V)	Comment
0.360000	10.0	31.5	58.7	
0.490000	10.1	30.1	56.2	
0.925000	10.1	37.2	56.0	
4.568750	10.2	43.6	56.0	
12.198050	10.5	45.9	60.0	
20.011100	11.1	45.2	60.0	

Prüfbericht - Nr.: **16016703 001**  
Test Report No.:

Seite 14 von 27  
Page 14 of 27

## 5.2 Radiated Emission for FCC Part 15 Per Section 15.109(a)

### RESULT:

Pass

Date of testing	:	23.Apr.2009
Test specification	:	FCC Part 15 Per Section 15.109(a)
Limits	:	FCC Part 15 Per Section 15.109(a)
Test procedure	:	Procedure specified in ANSI C63.4 were followed
Deviations from Standard Test procedures	:	None
Kind of test site	:	3m Semi-anechoic chamber
Operation mode	:	Receiving at high and low channels
Temperature	:	23°C
Humidity	:	50%

### Test procedure:

1. The EUT was turned on and placed on the top of a rotatable table 0.8 meters above the ground with 3-orthogonal XYZ direction and be kept close enough to the measurement receiving antenna (especially for the measurement frequency range above 1 GHz). The table was then rotated 360 degrees to detect the suspected emission frequency points. The position of the worst radiation case with both horizontal and vertical receiving antenna polarization was then recorded together with the suspected emission frequency points above-mentioned.
2. The EUT was then set 3 meters away from the receiving antenna, which was mounted on a variable-height antenna tower.
3. For each suspected emission frequency point recorded in step 1, the EUT was arranged to its worst case that the antenna was tuned to heights from 1 meter to 4 meters and the rotatable table was turned from 0 degrees to 360 degrees to read the maximum emission.

### Remark:

Quick scans were performed for EUT with DC power, battery and AC-DC adaptor, and found the EUT with AC-DC adaptor emitted the maximum disturbance; therefore the final measurement was done with AC-DC adaptor.

The external knobs of EUT were adjusted to emit the maximum disturbance; only the worst test data was recorded and attached in this report.

Prüfbericht - Nr.: **16016703 001**  
Test Report No.:

Seite 15 von 27  
Page 15 of 27

## Test Information

EUT Name: Wireless Receiver  
Model Number: UM1  
Operating Conditions: Receiving at low channel  
Comment: AC 120V, 60Hz; Horizontal

Subrange 1  
Frequency Range: 30MHz - 1GHz  
Receiver: TUV ESCI 3  
Transducer: TUV SAC UVLB 9168 / TUV ESCI3 -TUV SAC UVLB 9168

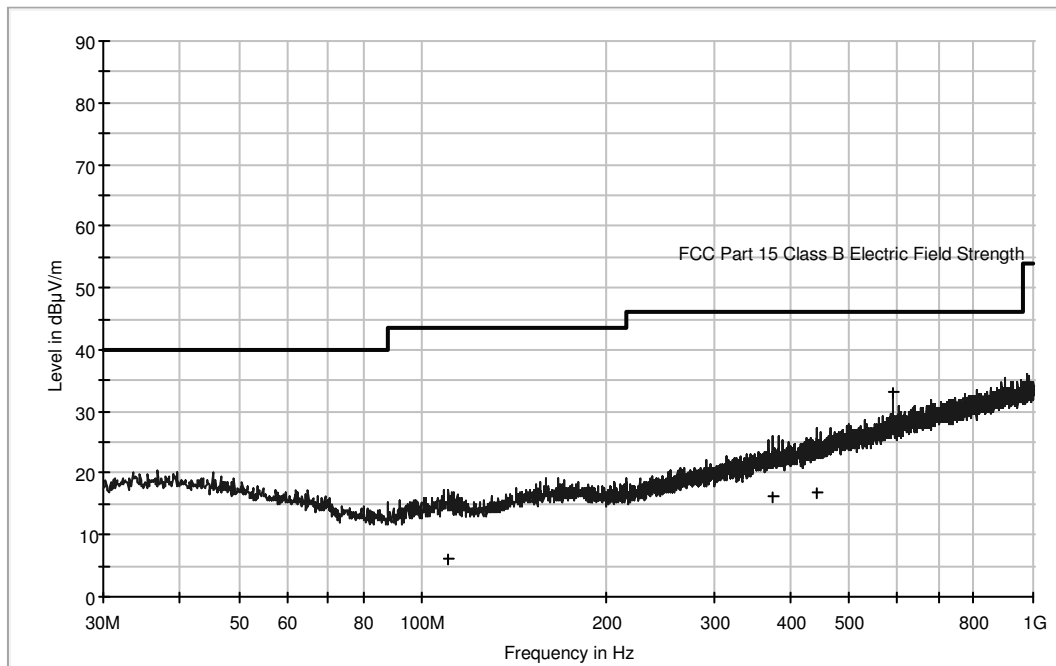

## Limit and Margin

Frequency (MHz)	QuasiPeak (dB µ V/m)	Corr. (dB)	Margin (dB)	Limit (dB µ V/m)	Polarity
110.150000	6.0	9.7	37.5	43.5	H
375.100000	16.3	18.8	29.7	46.0	H
441.400000	16.8	20.2	29.2	46.0	H
590.600000	33.0	23.9	13.0	46.0	H

## Test Information

EUT Name: Wireless Receiver  
 Model Number: UM1  
 Operating Conditions: Receiving at low channel  
 Comment: AC 120V, 60Hz; Vertical

Subrange 1  
 Frequency Range: 30MHz - 1GHz  
 Receiver: TUV ESCI 3  
 Transducer: TUV SAC UVLB 9168 / TUV ESCI3 -TUV SAC UVLB 9168

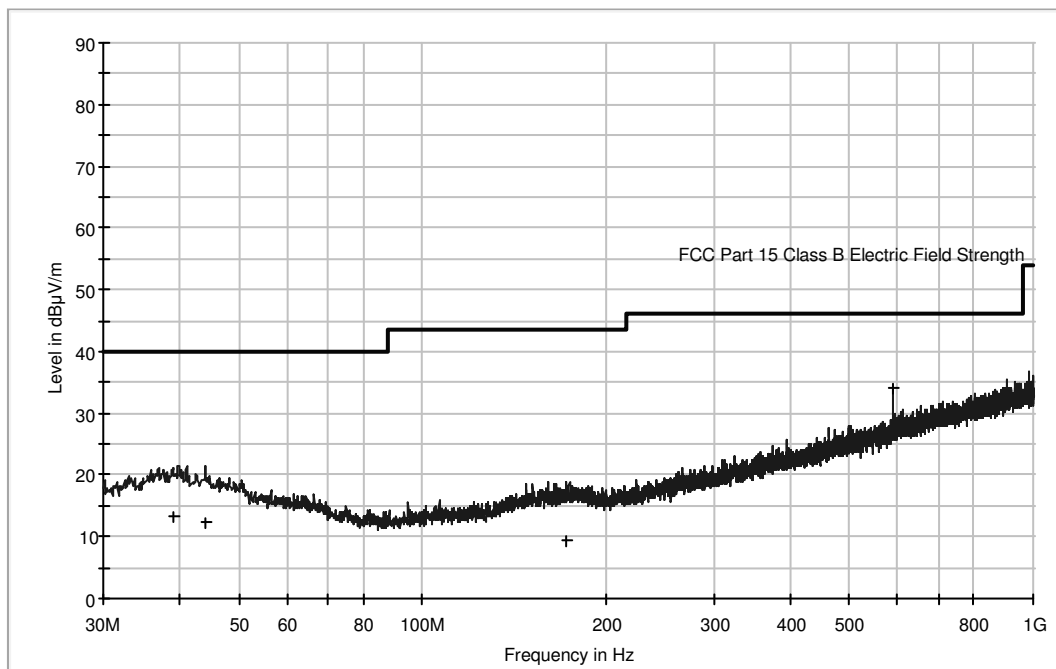

## Limit and Margin

Frequency (MHz)	QuasiPeak (dB µ V/m)	Corr. (dB)	Margin (dB)	Limit (dB µ V/m)	Polarity
39.100000	13.4	14.4	26.6	40.0	V
44.000000	12.3	13.8	27.7	40.0	V
171.400000	9.6	13.3	33.9	43.5	V
590.600000	34.1	23.9	11.9	46.0	V



## Test Information

EUT Name: Wireless Receiver  
 Model Number: UM1  
 Operating Conditions: Receiving at low channel  
 Comment: AC 120V, 60Hz; Horizontal

### Subrange 1

Frequency Range: 1GHz - 5GHz  
 Receiver: TUV FSP 30  
 Transducer: TUV SAC HF906 / TUV FSP 30-TUV SAC HF906

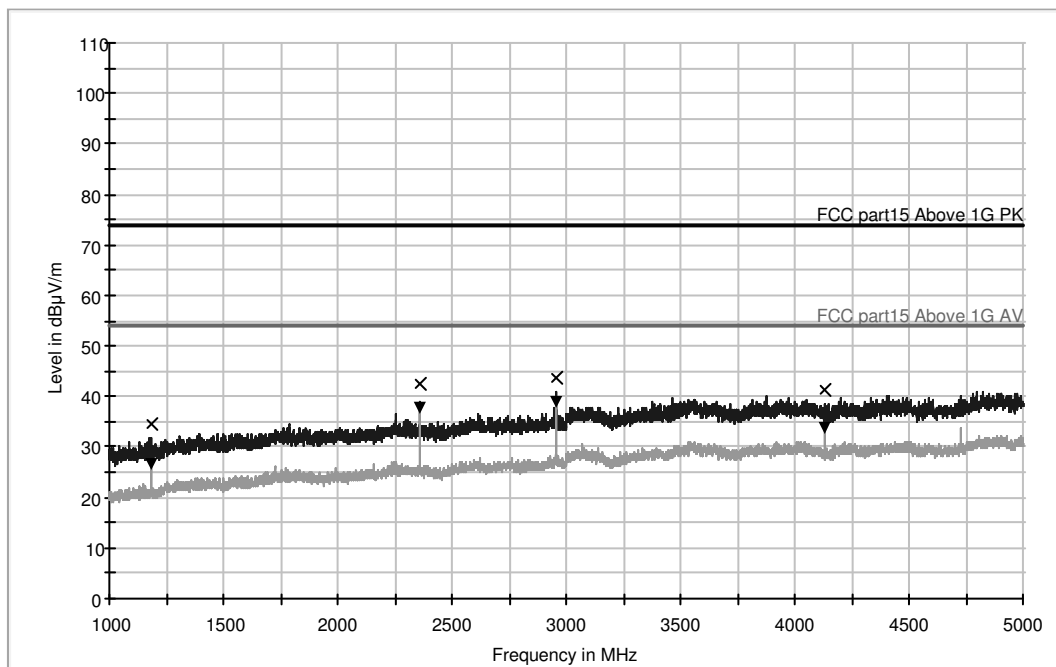

### Limit and Margin PK

Frequency (MHz)	MaxPeak (dB µ V/m)	Margin (dB)	Limit (dB µ V/m)	Polarity	Corr. (dB)
1181.000000	34.7	39.3	74.0	H	-16.8
2362.500000	42.6	31.4	74.0	H	-11.9
2953.000000	43.8	30.2	74.0	H	-10.1
4134.500000	41.4	32.6	74.0	H	-7.9

### Limit and Margin AV

Frequency (MHz)	Average (dB µ V/m)	Margin (dB)	Limit (dB µ V/m)	Polarity	Corr. (dB)
1181.000000	26.6	27.4	54.0	H	-16.8
2362.500000	37.6	16.4	54.0	H	-11.9
2953.000000	39.0	15.0	54.0	H	-10.1
4134.500000	33.9	20.1	54.0	H	-7.9

## Test Information

EUT Name: Wireless Receiver  
Model Number: UM1  
Operating Conditions: Receiving at low channel  
Comment: AC 120V 60Hz; Vertical

### Subrange 1

Frequency Range: 1GHz - 5GHz  
Receiver: TUV FSP 30  
Transducer: TUV SAC HF906 / TUV FSP 30-TUV SAC HF906

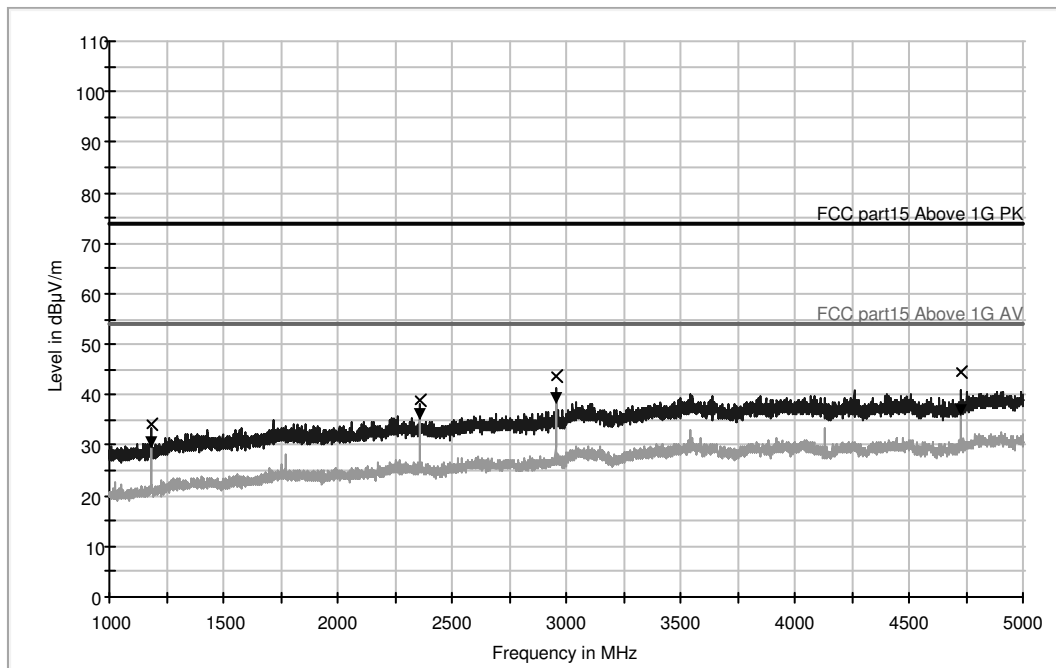

## Limit and Margin PK

Frequency (MHz)	MaxPeak (dB µ V/m)	Margin (dB)	Limit (dB µ V/m)	Polarity	Corr. (dB)
1181.000000	34.3	39.7	74.0	V	-16.8
2362.500000	39.1	34.9	74.0	V	-11.9
2953.000000	43.5	30.5	74.0	V	-10.1
4725.000000	44.3	29.7	74.0	V	-7.3

## Limit and Margin AV

Frequency (MHz)	Average (dB µ V/m)	Margin (dB)	Limit (dB µ V/m)	Polarity	Corr. (dB)
1181.000000	30.4	23.6	54.0	V	-16.8
2362.500000	36.0	18.0	54.0	V	-11.9
2953.000000	39.3	14.7	54.0	V	-10.1
4725.000000	37.0	17.0	54.0	V	-7.3

## Test Information

EUT Name: Wireless Receiver  
 Model Number: UM1  
 Operating Conditions: Receiving at high channel  
 Comment: AC 120V, 60Hz; Horizontal

Subrange 1  
 Frequency Range: 30MHz - 1GHz  
 Receiver: TUV ESCI 3  
 Transducer: TUV SAC UVLB 9168 / TUV ESCI3 -TUV SAC UVLB 9168

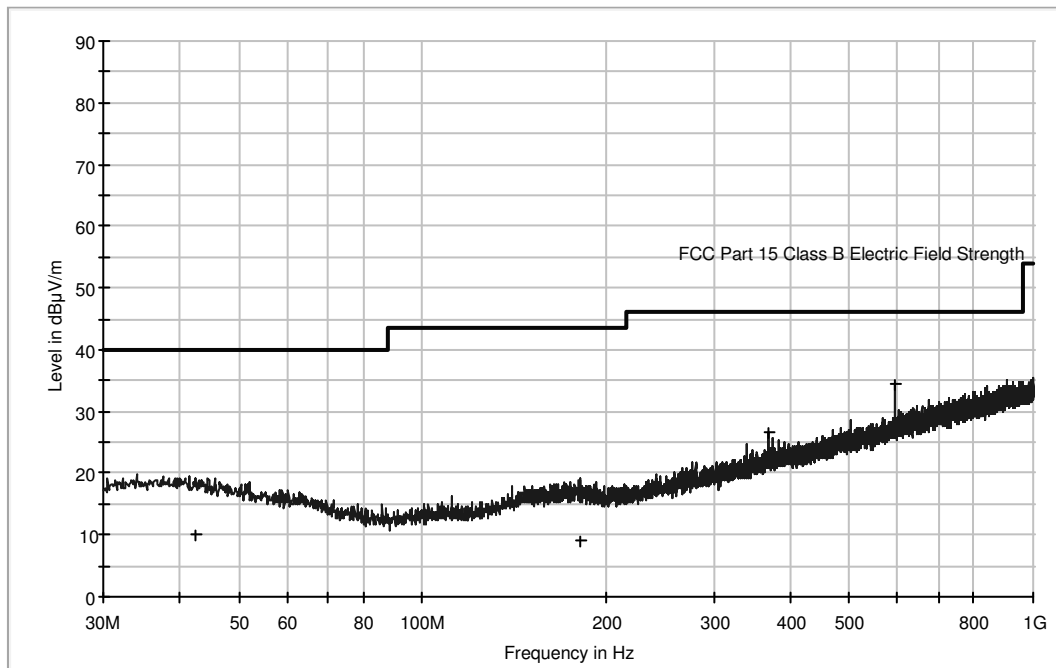

## Limit and Margin

Frequency (MHz)	QuasiPeak (dB µ V/m)	Corr. (dB)	Margin (dB)	Limit (dB µ V/m)	Polarity
42.500000	9.9	14.0	30.1	40.0	H
181.300000	9.2	13.4	34.3	43.5	H
368.200000	26.5	18.6	19.5	46.0	H
594.000000	34.5	23.9	11.5	46.0	H

## Test Information

EUT Name: Wireless Receiver  
 Model Number: UM1  
 Operating Conditions: Receiving at high channel  
 Comment: AC 120V, 60Hz; Vertical

Subrange 1  
 Frequency Range: 30MHz - 1GHz  
 Receiver: TUV ESCI 3  
 Transducer: TUV SAC UVLB 9168 / TUV ESCI3 -TUV SAC UVLB 9168

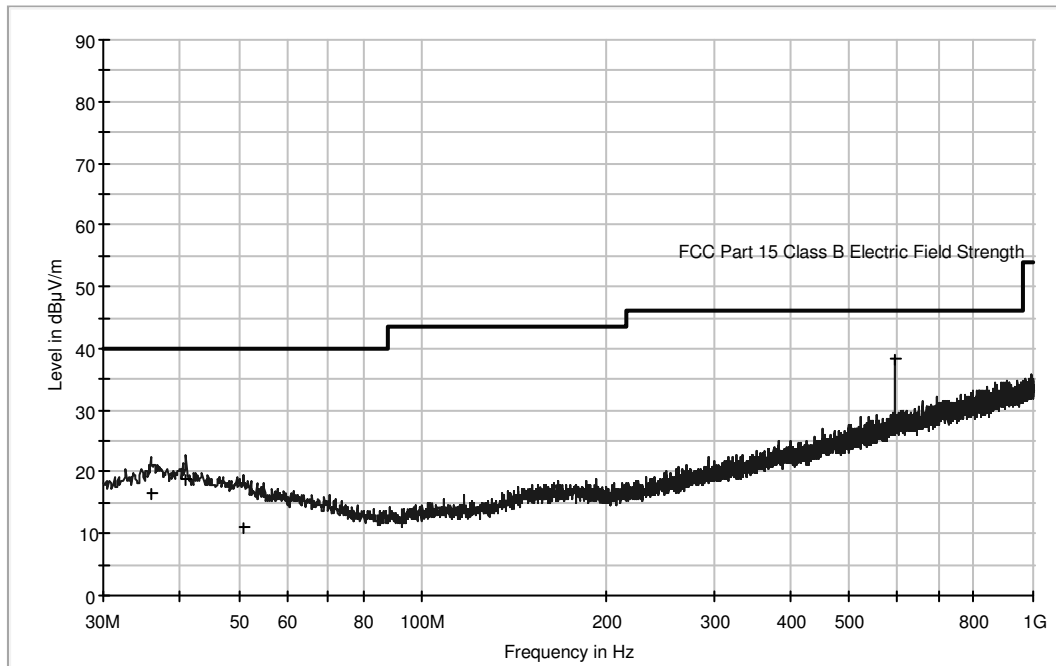

## Limit and Margin

Frequency (MHz)	QuasiPeak (dB µ V/m)	Corr. (dB)	Margin (dB)	Limit (dB µ V/m)	Polarity
36.000000	16.7	14.2	23.3	40.0	V
41.050000	18.9	14.3	21.1	40.0	V
51.000000	11.1	12.8	28.9	40.0	V
594.000000	38.4	23.9	7.6	46.0	V

## Test Information

EUT Name: Wireless Receiver  
Model Number: UM1  
Operating Conditions: Receiving at high channel  
Comment: AC 120V, 60Hz; Horizontal

### Subrange 1

Frequency Range: 1GHz - 5GHz  
Receiver: TUV FSP 30  
Transducer: TUV SAC HF906 / TUV FSP 30-TUV SAC HF906

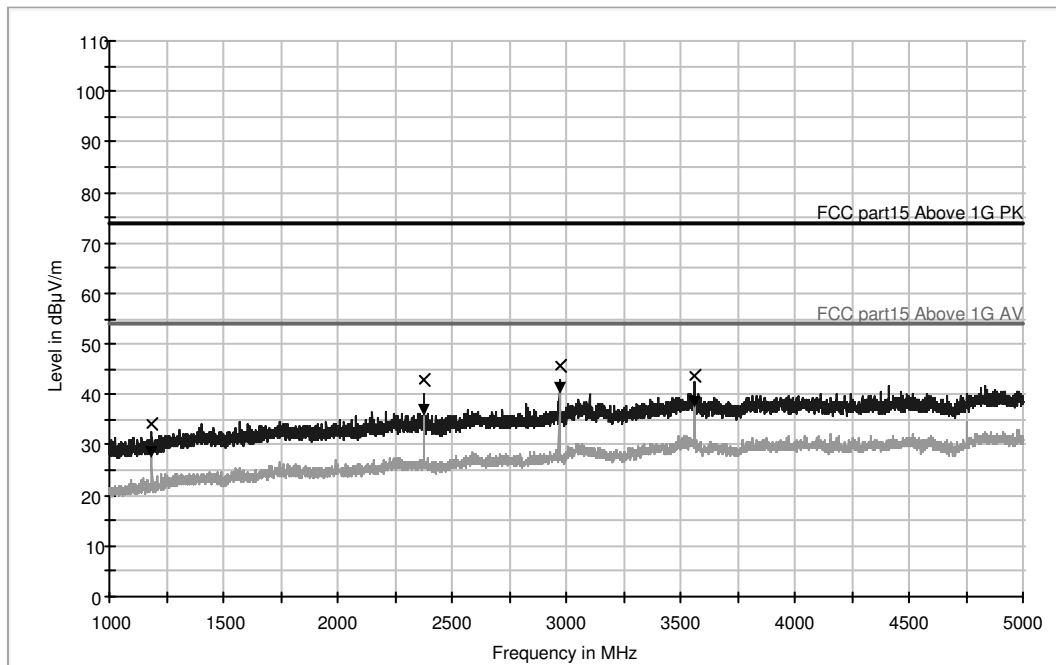

### Limit and Margin PK

Frequency (MHz)	MaxPeak (dB µ V/m)	Margin (dB)	Limit (dB µ V/m)	Polarity	Corr. (dB)
1188.000000	34.2	39.8	74.0	H	-16.8
2376.000000	42.8	31.2	74.0	H	-11.9
2970.000000	45.6	28.4	74.0	H	-10.2
3563.000000	43.5	30.5	74.0	H	-8.1

### Limit and Margin AV

Frequency (MHz)	Average (dB µ V/m)	Margin (dB)	Limit (dB µ V/m)	Polarity	Corr. (dB)
1188.000000	28.7	25.3	54.0	H	-16.8
2376.000000	36.9	17.1	54.0	H	-11.9
2970.000000	41.4	12.6	54.0	H	-10.2
3563.000000	38.6	15.4	54.0	H	-8.1

## Test Information

EUT Name: Wireless Receiver  
Model Number: UM1  
Operating Conditions: Receiving at high channel  
Comment: AC 120V, 60Hz; Vertical

### Subrange 1

Frequency Range: 1GHz - 5GHz  
Receiver: TUV FSP 30  
Transducer: TUV SAC HF906 / TUV FSP 30-TUV SAC HF906

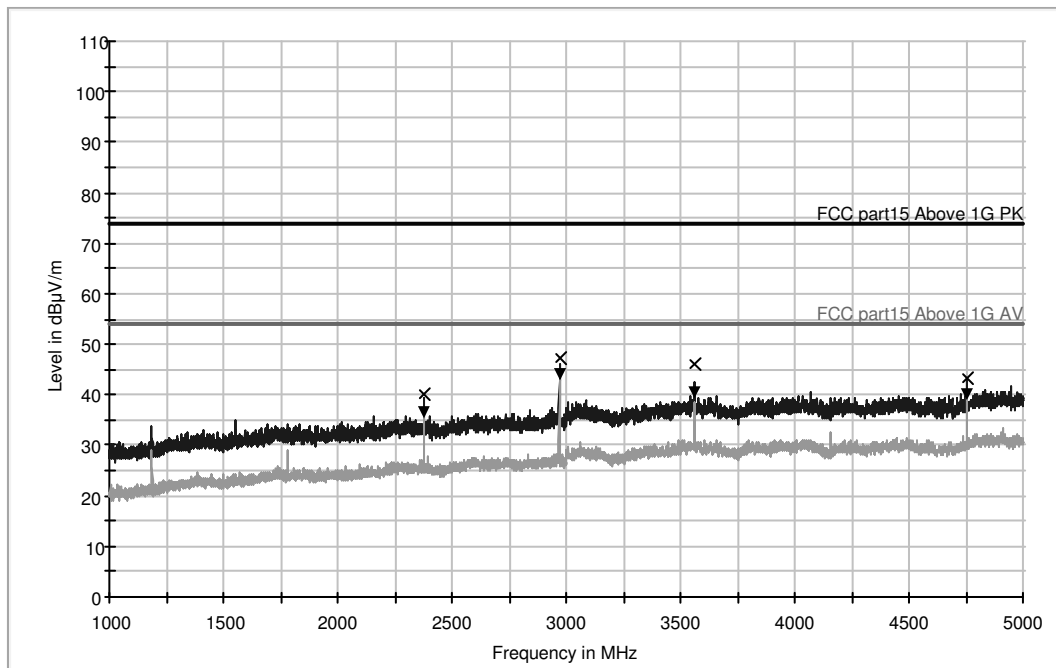

## Limit and Margin PK

Frequency (MHz)	MaxPeak (dB µ V/m)	Margin (dB)	Limit (dB µ V/m)	Polarity	Corr. (dB)
2376.000000	40.3	33.7	74.0	V	-11.9
2970.000000	47.4	26.6	74.0	V	-10.2
3564.000000	45.9	28.1	74.0	V	-8.1
4752.000000	43.2	30.8	74.0	V	-6.9

## Limit and Margin AV

Frequency (MHz)	Average (dB µ V/m)	Margin (dB)	Limit (dB µ V/m)	Polarity	Corr. (dB)
2376.000000	36.5	17.5	54.0	V	-11.9
2970.000000	44.2	9.8	54.0	V	-10.2
3564.000000	40.4	13.6	54.0	V	-8.1
4752.000000	40.3	13.7	54.0	V	-6.9

**Prüfbericht - Nr.: 16016703 001**  
*Test Report No.:*

**Seite 23 von 27**  
*Page 23 of 27*

Disturbances other than those mentioned above are far below the limit or not detectable.

The final measurement for frequencies below 1000MHz is performed with Quasi Peak detector; the final measurement for frequencies above 1000MHz is performed with Average and Peak detector.

The limit on peak radio frequency emissions is 20 dB above the maximum permitted average emission limit applicable to the equipment under test.

The resolution bandwidth and video bandwidth of test receiver/spectrum analyzer is 120 kHz at frequency below 1GHz.

The resolution bandwidth of test receiver/spectrum analyzer is 1 MHz at frequency above 1GHz.

## 6 Photographs of the Test Set-Up

Photograph 1: Set up for Conducted Emission on AC Mains

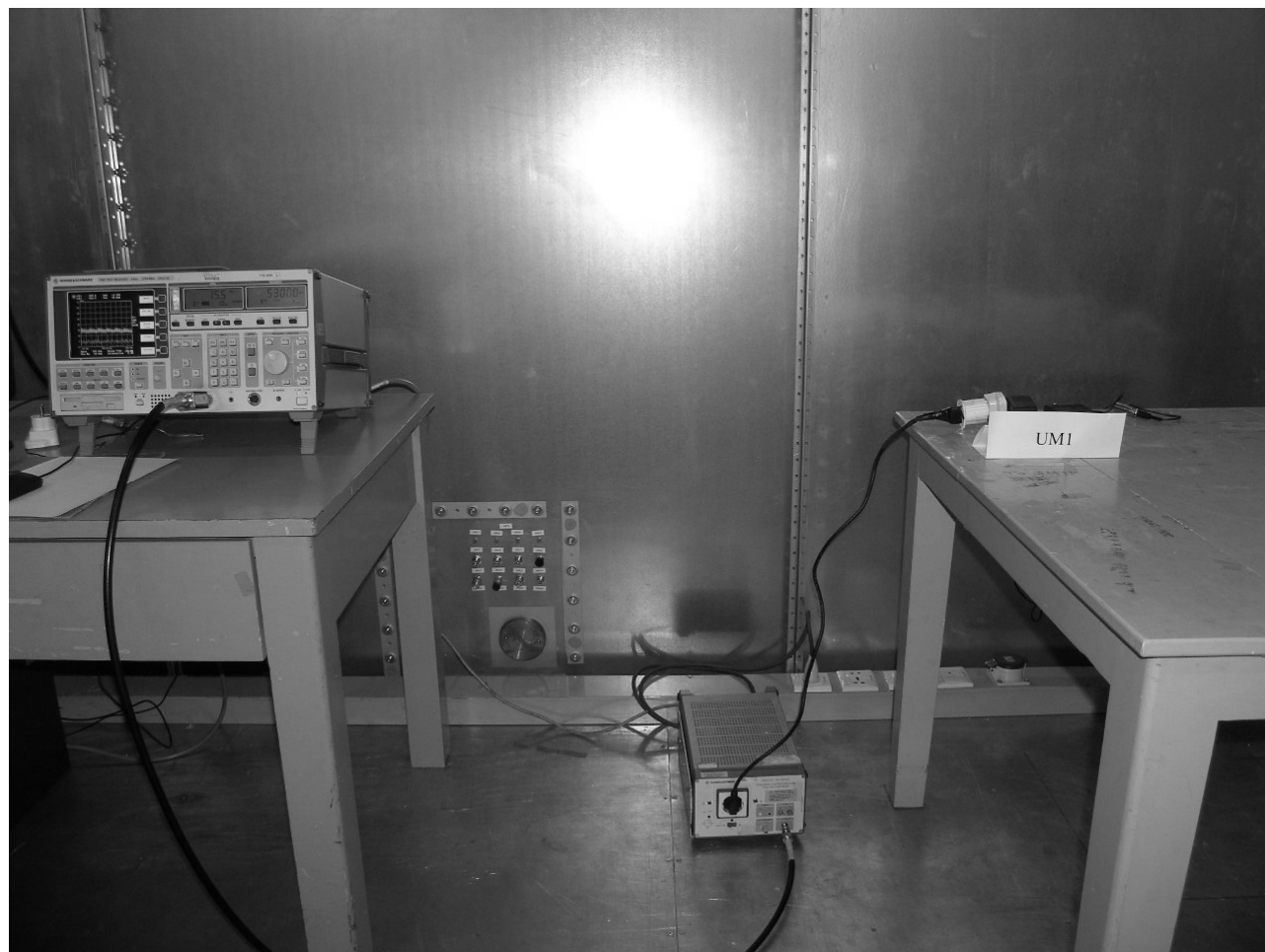



Photograph 2: Set-up for Radiation Measurement below 1GHz

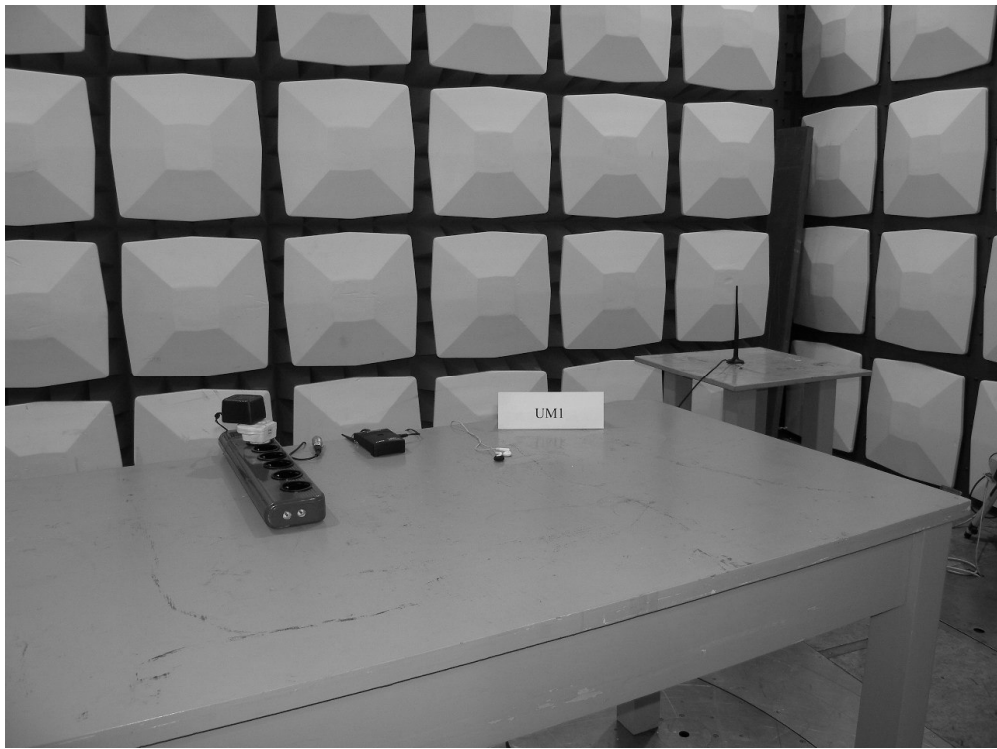

Photograph 3: Set-up for Radiation Measurement above 1GHz

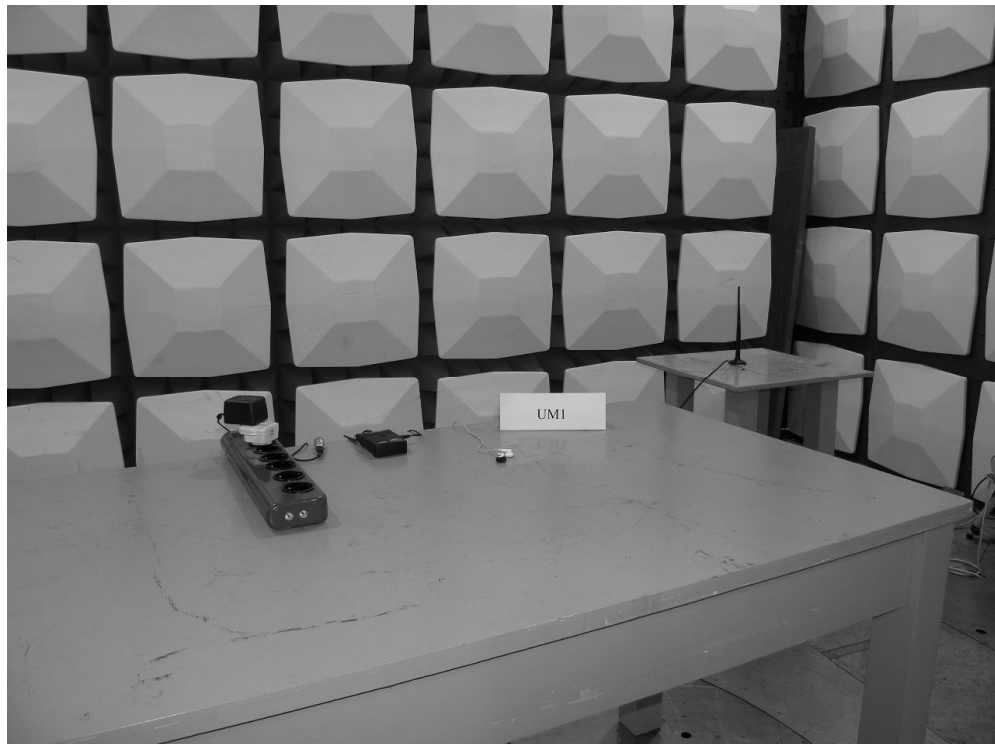

## 7 List of Tables

Table 1: List of Test and Measurement Equipment .....	5
Table 2: Disturbance Voltage on AC Mains .....	13

## 8 List of Photographs

Photograph 1: Set up for Conducted Emission on AC Mains .....	24
Photograph 2: Set-up for Radiation Measurement below 1GHz .....	25
Photograph 3: Set-up for Radiation Measurement above 1GHz .....	26