

FCC RADIO TEST REPORT

The device described below is tested by Dongguan Nore Testing Center Co., Ltd. to determine the maximum emission levels emanating from the device, the severe levels which the device can endure and E.U.T.'s performance criterion. The test results, data evaluation, test procedures, and equipment of configurations shown in this report were made in accordance with the procedures in ANSI C63.10(2013).

Applicant : Sam Ash Music Corporation
Address : 262 Duffy Avenue, Hicksville, NY 11801, United States
Manufacturer/Factory : Sam Ash Music Corporation
Address : 262 Duffy Avenue, Hicksville, NY 11801, United States
E.U.T. : Portable PA System
Brand Name : SAMSON
Model No. : Expedition Express+
FCC ID : CCREXPRESS
Measurement Standard : FCC PART 15.247: 2017
Date of Receiver : April 05, 2019
Date of Test : April 05, 2019 to June 02, 2019
Date of Report : June 02, 2019

This Test Report is Issued Under the Authority of :

Prepared by

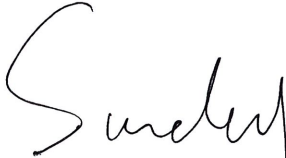

Sundiy jiang / Engineer

Approved & Authorized Signer



Iori Fan / Authorized Signatory

This test report is for the customer shown above and their specific product only. This report applies to above tested sample only and shall not be reproduced in part without written approval of Dongguan Nore Testing Center Co., Ltd.

Table of Contents

1. GENERAL INFORMATION	5
1.1 Product Description for Equipment under Test	5
1.2 Related Submittal(s) / Grant (s)	7
1.3 Test Methodology	7
1.4 Equipment Modifications	7
1.5 Support Device	7
1.6 Test Facility and Location	8
1.7 Summary of Test Results	9
2. SYSTEM TEST CONFIGURATION.....	10
2.1 EUT Configuration.....	10
2.2 Special Accessories	10
2.3 Description of test modes	10
2.4 EUT Exercise	10
3. CONDUCTED EMISSIONS TEST	11
3.1 Test SET-UP (Block Diagram of Configuration)	11
3.2 Test Condition	11
3.3 Measurement Results.....	11
4. RADIATED EMISSION TEST.....	14
4.1 Test SET-UP (Block Diagram of Configuration)	14
4.2 Measurement Procedure	15
4.3 Limit	16
4.4 Measurement Results.....	16
5. CHANNEL SEPARATION TEST	20
5.1 Measurement Procedure	20
5.2 Test SET-UP (Block Diagram of Configuration)	20
5.3 Measurement Results.....	20
6. 20DB BANDWIDTH.....	24
6.1 Measurement Procedure	24
6.2 Test SET-UP (Block Diagram of Configuration)	24
6.3 Measurement Results.....	24
7. HOPPING CHANNEL NUMBER	29
7.1 Measurement Procedure	29
7.2 Test SET-UP (Block Diagram of Configuration)	29
7.3 Measurement Results.....	29



8. TIME OF OCCUPANCY (DWELL TIME)	31
8.1 Measurement Procedure	31
8.2 Measurement Results.....	31
9. MAXIMUM PEAK OUTPUT POWER	35
9.1 Measurement Procedure	35
9.2 Measurement Results.....	35
10. BAND EDGE	39
10.1 Measurement Procedure	39
10.2 Limit	39
10.3 Measurement Results.....	39
11. ANTENNA APPLICATION	44
11.1 Antenna requirement	44
11.2 Measurement Results.....	44
12. CONDUCTED SPURIOUS EMISSIONS	45
12.1 Measurement Procedure	45
12.2 Measurement Results.....	45
13. TEST EQUIPMENT LIST	49

1. GENERAL INFORMATION

1.1 Product Description for Equipment under Test

Product Name	:	Portable PA System
Main Model Name	:	Expedition Express+
Additional Model Name	:	N/A
Model difference	:	N/A
Brand Name	:	SAMSON
Rating	:	AC 100-240V ~50/60Hz DC: 12V(From Built-in battery)
Adapter	:	Manufacturer: GOLDEN PROFIT M/N: GPE072D-220320W Input: AC 100-240V ~50/60Hz, 1.8A Output: DC 22V 3.2A
Test voltage	:	AC 120V/60Hz, AC 240V/60Hz, DC 12V(From Built-in battery) (Only the worst case was recorded in this report)
Cable	:	AC Line: 1.71m unshielded; DC Line: 1.45m unshielded
Hardware version	:	V1.0
Software version	:	V1.0
Remark	:	N/A
Technical parameters		
Bluetooth Version	:	V5.0+EDR
Frequency Range	:	2402-2480MHz
Modulation	:	GFSK, $\pi/4$ -DQPSK
Number of Channel	:	79
Channel space	:	1MHz
Antenna Type	:	PCB Antenna
Antenna Gain	:	0 dBi

Channel List

Channel	Frequency MHz	Channel	Frequency MHz	Channel	Frequency MHz	Channel	Frequency MHz
1	2402	21	2422	41	2442	61	2462
2	2403	22	2423	42	2443	62	2463
3	2404	23	2424	43	2444	63	2464
4	2405	24	2425	44	2445	64	2465
5	2406	25	2426	45	2446	65	2466
6	2407	26	2427	46	2447	66	2467
7	2408	27	2428	47	2448	67	2468
8	2409	28	2429	48	2449	68	2469
9	2410	29	2430	49	2450	69	2470
10	2411	30	2431	50	2451	70	2471
11	2412	31	2432	51	2452	71	2472
12	2413	32	2433	52	2453	72	2473
13	2414	33	2434	53	2454	73	2474
14	2415	34	2435	54	2455	74	2475
15	2416	35	2436	55	2456	75	2476
16	2417	36	2437	56	2457	76	2477
17	2418	37	2438	57	2458	77	2478
18	2419	38	2439	58	2459	78	2479
19	2420	39	2440	59	2460	79	2480
20	2421	40	2441	60	2461		

Note: According to section 15.31(m), regards to the operating frequency range over 10MHz, the Lowest, Middle, and the Highest frequency of channel were selected to perform the test. The selected frequency and test software see below:

Channel	Frequency MHz
1	2402
40	2441
79	2480

Test SW version	FCC Assist 1.5
-----------------	----------------

1.2 Related Submittal(s) / Grant (s)

This submittal(s) (test report) is intended for FCC ID: **CCREXPRESS** filing to comply with Section 15.247 of the FCC Part 15 (2017), Subpart C Rule.

1.3 Test Methodology

Both AC mains line-conducted and radiated emission measurements were performed according to the procedures in ANSI C63.10 (2013). Radiated emission measurement was performed in semi-anechoic chamber and conducted emission measurement was performed in shield room. For radiated emission measurement, preliminary scans were performed in the semi-anechoic chamber only to determine the worst case modes. All radiated tests were performed at an antenna to EUT distance of 3 meters.

1.4 Equipment Modifications

Not available for this EUT intended for grant.

1.5 Support Device

Notebook	Manufacturer: Lenovo Model: TP00067A P/N: SL10G10768 S/N: PF-0DS3YC 15/12
Adapter (For Notebook)	: Manufacturer: Lenovo Model: ADLX65NLC3A I/P: AC 100-240V 50-60Hz, 1.8A O/P: DC 20V 3.25A

1.6 Test Facility and Location

Site Description

EMC Lab : Listed by CNAS, August 13, 2018
The certificate is valid until August 13, 2024
The Laboratory has been assessed and proved to be in compliance with CNAS/CL01
The Certificate Registration Number is L5795.

Listed by A2LA, November 01, 2017
The certificate is valid until December 31, 2019
The Laboratory has been assessed and proved to be in compliance with ISO17025
The Certificate Registration Number is 4429.01

Listed by FCC, November 06, 2017
The Designation Number is CN1214
Test Firm Registration Number: 907417

Listed by Industry Canada, June 08, 2017
The Certificate Registration Number. Is 46405-9743

Name of Firm : Dongguan Nore Testing Center Co., Ltd.
(Dongguan NTC Co., Ltd.)

Site Location : Building D, Gaosheng Science and Technology
Park, Hongtu Road, Nancheng District, Dongguan
City, Guangdong Province, China

1.7 Summary of Test Results

FCC Rules	Description Of Test	Uncertainty	Result
§15.247(a)(1)	Channel Separation test	$\pm 1.42 \times 10^{-4}\%$	Compliant
§15.247(a)(1)	20dB Bandwidth	$\pm 1.42 \times 10^{-4}\%$	Compliant
§15.247(a)(1)(iii)	Hopping Channel Number	$\pm 1.42 \times 10^{-4}\%$	Compliant
§15.247(a)(1)(iii)	Time of Occupancy (Dwell Time)	$\pm 5\%$	Compliant
§15.247(b)	Max Peak output Power test	$\pm 1.06\text{dB}$	Compliant
§15.247(d)	Band edge test	$\pm 1.70\text{dB}$	Compliant
§15.207 (a)	AC Power Conducted Emission	$\pm 1.06\text{dB}$	Compliant
§15.247(d), §15.209, §15.205	Radiated Emission	$\pm 3.70\text{dB}$	Compliant
§15.203	Antenna Requirement	N/A	Compliant
§15.247(d)	Conducted Spurious Emission	$\pm 1.70\text{dB}$	Compliant

2. System Test Configuration

2.1 EUT Configuration

The EUT configuration for testing is installed on RF field strength measurement to meet the Commissions requirement and operating in a manner which intends to maximize its emission characteristics in a continuous normal application.

2.2 Special Accessories

Not available for this EUT intended for grant.

2.3 Description of test modes

The EUT has been tested under operating condition. Test program used to control the EUT for staying in continuous transmitting and normal mode is programmed. The Lowest, middle and highest channel were chosen for testing, and all packets DH1, DH3, DH5, 2DH1, 2DH3, 2DH5 mode in all modulation type GFSK, $\pi/4$ -DQPSK were tested.

2.4 EUT Exercise

The EUT was operated in the engineering mode to fix the Tx frequency that was for the purpose of the measurements.

3. Conducted Emissions Test

3.1 Test SET-UP (Block Diagram of Configuration)

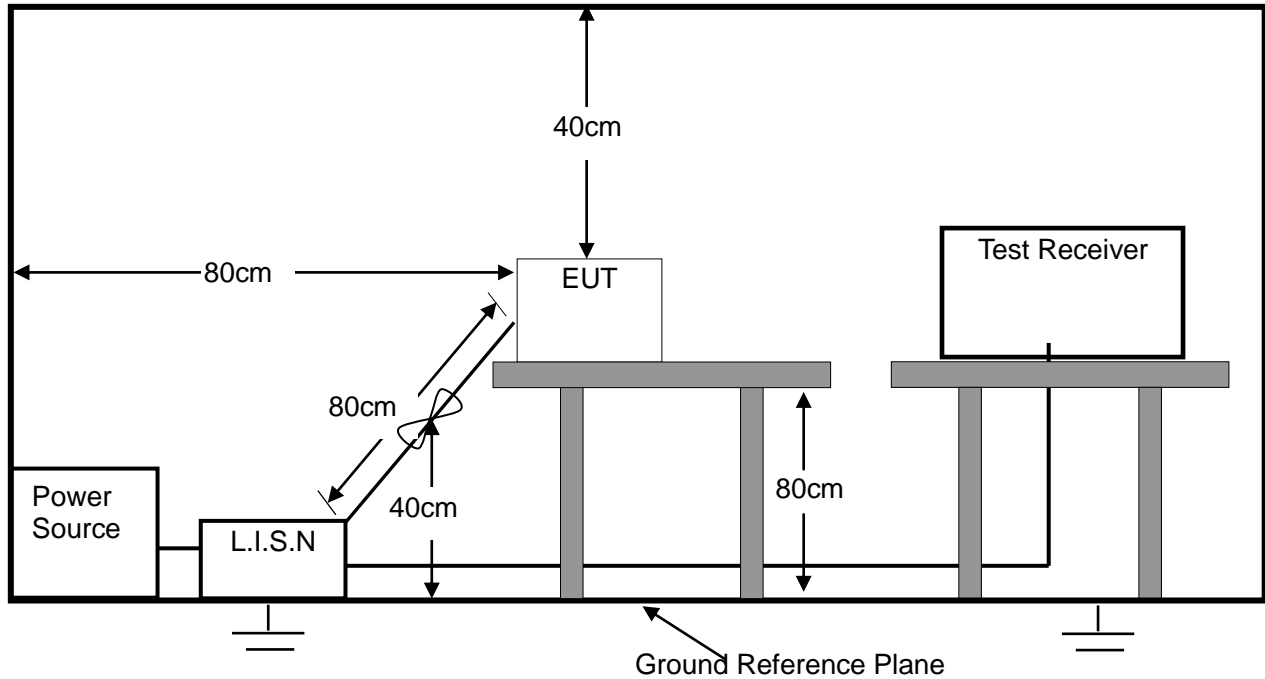

3.2 Test Condition

Test Requirement: FCC Part 15.207

Frequency Range: 150KHz ~ 30MHz

Detector: RBW 9KHz, VBW 30KHz

Operation Mode: TX+ Charging

3.3 Measurement Results

Please refer to following plots of the worst case: $\pi/4$ -DQPSK Low Channel.



Dongguan NTC Co., Ltd.
 Tel: +86-769-22022444 Fax: +86-769-22022799
 Web: [Http://www.ntc-c.com](http://www.ntc-c.com)

Conducted Emission Measurement

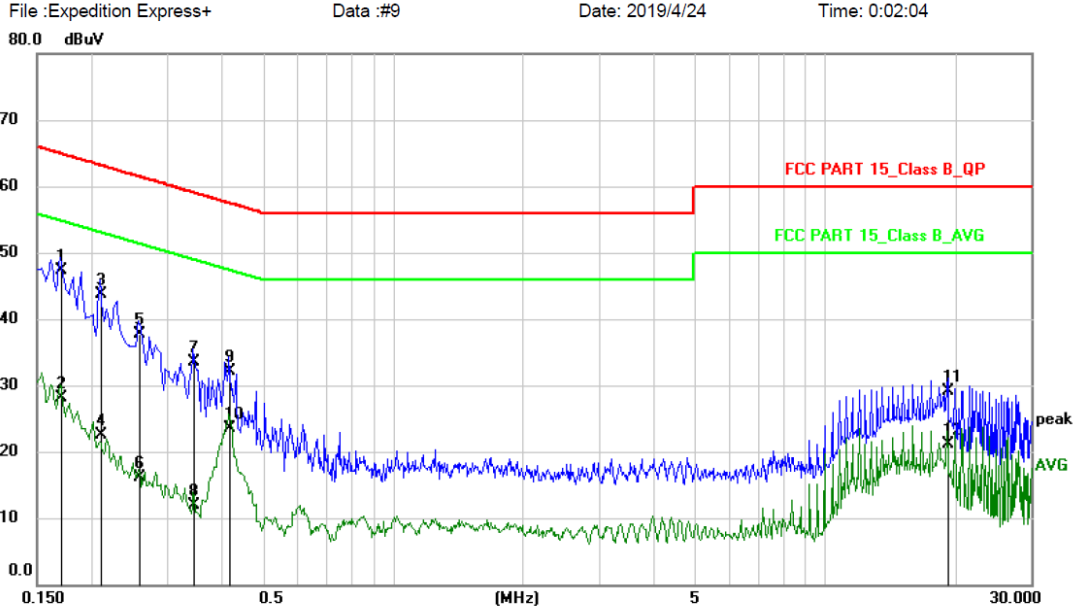

Site: Phase: **L1** Temperature: 26
 Limit: FCC PART 15_Class B_QP Power: AC120V/60Hz Humidity: 60 %
 EUT: Portable PA System
 M/N: Expedition Express+
 Mode: TX+ Charging
 Note:

No.	Mk.	Freq. MHz	Reading Level dBuV	Correct Factor dB	Measure- ment dBuV	Limit dBuV	Over dB	Detector	Comment
1	*	0.1700	36.69	10.61	47.30	64.96	-17.66	QP	
2		0.1700	17.59	10.61	28.20	54.96	-26.76	AVG	
3		0.2100	33.19	10.61	43.80	63.21	-19.41	QP	
4		0.2100	11.89	10.61	22.50	53.21	-30.71	AVG	
5		0.2580	27.09	10.61	37.70	61.50	-23.80	QP	
6		0.2580	5.59	10.61	16.20	51.50	-35.30	AVG	
7		0.3457	22.89	10.61	33.50	59.07	-25.57	QP	
8		0.3457	1.29	10.61	11.90	49.07	-37.17	AVG	
9		0.4178	21.58	10.62	32.20	57.49	-25.29	QP	
10		0.4178	12.98	10.62	23.60	47.49	-23.89	AVG	
11		19.2256	18.53	10.67	29.20	60.00	-30.80	QP	
12		19.2256	10.43	10.67	21.10	50.00	-28.90	AVG	

4. Radiated Emission Test

4.1 Test SET-UP (Block Diagram of Configuration)

4.1.1 Radiated Emission Test Set-Up, Frequency Below 30MHz

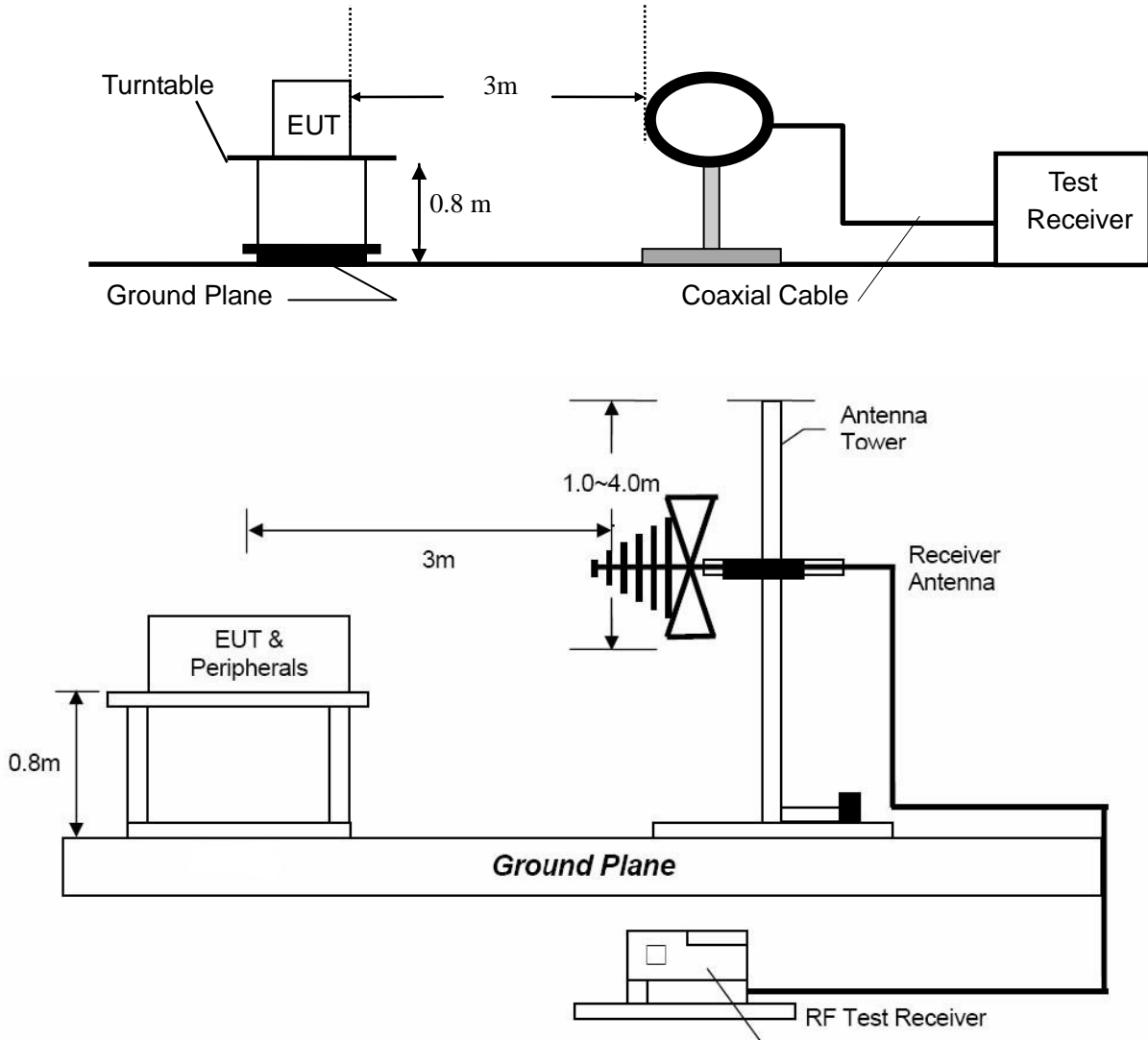

4.1.2 Radiated Emission Test Set-Up, Frequency above 1GHz

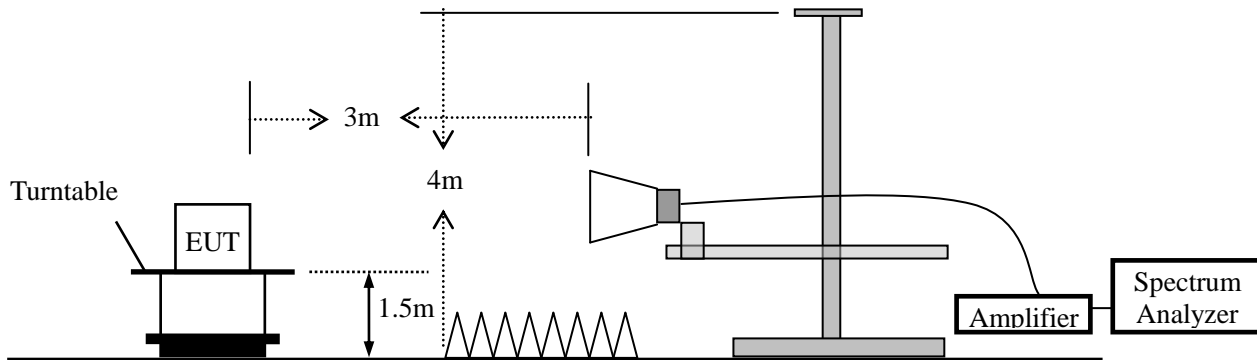

4.2 Measurement Procedure

- a. Blow 1GHz, the EUT was placed on the top of a rotating table 0.8 meters above the ground at a 3 meter semi- anechoic chamber room.
- b. For the radiated emission test above 1GHz:
The EUT was placed on the top of a rotating table 1.5 meters above the ground at a 3 meter full anechoic chamber room. The table was rotated 360 degrees to determine the position of the highest radiation. Place the measurement antenna away from each area of the EUT determined to be a source of emissions at the specified measurement distance, while keeping the measurement antenna aimed at the source of emissions at each frequency of significant emissions, with polarization oriented for maximum response. The measurement antenna may have to be higher or lower than the EUT, depending on the radiation pattern of the emission and staying aimed at the emission source for receiving the maximum signal. The final measurement antenna elevation shall be that which maximizes the emissions. The measurement antenna elevation for maximum emissions shall be restricted to a range of heights of from 1 m to 4 m above the ground or reference ground plane.
- c. The EUT was set 3 meters away from the interference-receiving antenna, which was mounted on the top of a variable-height antenna tower.
- d. The height of antenna is varied from one meter to four meters above the ground to determine the maximum value of the field strength. Both horizontal and vertical polarizations of the antenna are set to make the measurement.
- e. For each suspected emission, the EUT was arranged to its worst case and then the antenna was tuned to heights from 1 meter to 4 meters and the rotatable table was turned from 0 degrees to 360 degrees to find the maximum reading. The test-receiver system was set to peak detect function and specified bandwidth with maximum hold mode.
- f. A Quasi-peak measurement was then made for that frequency point for below 1GHz test. PK and AV for above 1GHz emission test.

During the radiated emission test, the spectrum analyzer was set with the following configurations:

Frequency Band (MHz)	Level	Resolution Bandwidth	Video Bandwidth
30 to 1000	QP	120 kHz	300 kHz
Above 1000	Peak	1 MHz	3 MHz
	Average	1 MHz	10 Hz

4.3 Limit

Frequency range MHz	Distance Meters	Field Strengths Limit (15.209)
		$\mu\text{V/m}$
0.009 ~ 0.490	300	$2400/F(\text{kHz})$
0.490 ~ 1.705	30	$24000/F(\text{kHz})$
1.705 ~ 30	30	30
30 ~ 88	3	100
88 ~ 216	3	150
216 ~ 960	3	200
Above 960	3	500

- Remark :
- (1) Emission level $(\text{dB})\mu\text{V} = 20 \log \text{Emission level } \mu\text{V/m}$
 - (2) The smaller limit shall apply at the cross point between two frequency bands.
 - (3) As shown in 15.35(b), for frequencies above 1000MHz, the field strength limits are based on average detector, however, the peak field strength of any emission shall not exceed the maximum permitted average limits, specified above by more than 20dB under any condition of modulation.
 - (4) The frequency range scanned is from the lowest radio frequency signal generated in the device which is greater than 9 kHz to the tenth harmonic of the highest fundamental frequency or 40 GHz, whichever is lower.

4.4 Measurement Results

Please refer to following plots of the worst case: $\pi/4$ -DQPSK Low Channel.



Dongguan NTC Co., Ltd.
 Tel: +86-769-22022444 Fax: +86-769-22022799
 Web: [Http://www.ntc-c.com](http://www.ntc-c.com)

Radiated Emission Measurement

File : Expedition Express+ Data : #16 Date: 2019/4/24 Time: 1:30:16

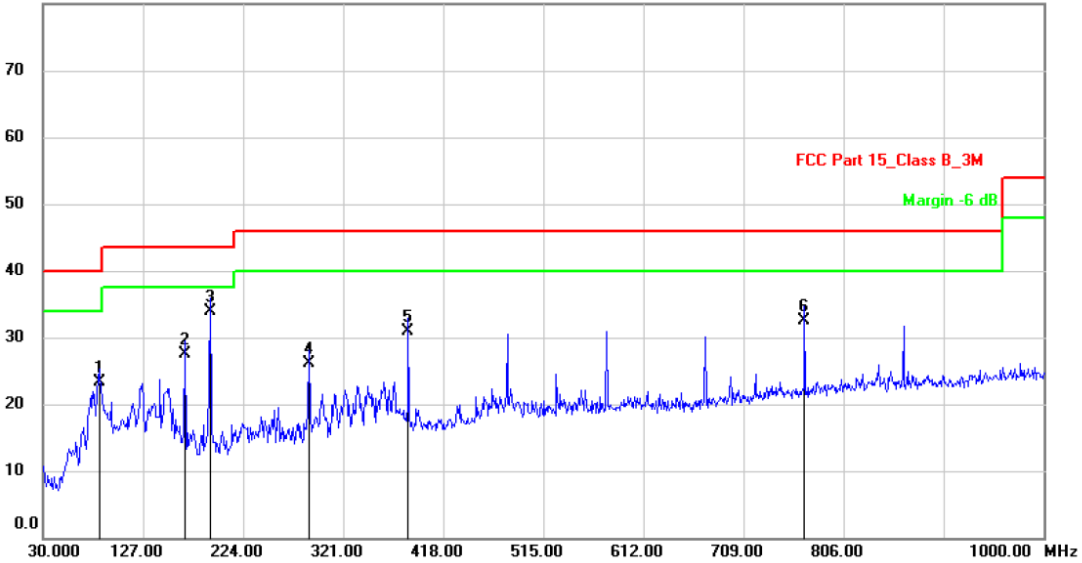

Site: 3m Chamber Polarization: *Horizontal* Temperature: 26
 Limit: FCC Part 15_Class B_3M Power: AC120V/60Hz Humidity: 47 %
 EUT: Portable PA System Distance: 3m
 M/N: Expedition Express+
 Mode: TX+ Charging
 Note:

No.	Mk.	Freq.	Reading Level	Correct Factor	Measurement	Limit	Over	Antenna Height	Table Degree	
		MHz	dBuV	dB/m	dBuV/m	dBuV/m	dB	cm	degree	Comment
1		84.3200	38.71	-15.31	23.40	40.00	-16.60	QP		
2		167.7400	42.39	-14.89	27.50	43.50	-16.00	QP		
3	*	191.9900	47.51	-13.51	34.00	43.50	-9.50	QP		
4		288.0200	36.99	-10.79	26.20	46.00	-19.80	QP		
5		384.0500	40.09	-9.19	30.90	46.00	-15.10	QP		
6		768.1700	34.95	-2.35	32.60	46.00	-13.40	QP		

Note: Below 30MHz, the emissions are lower than 20dB below the allowable limit.



Dongguan NTC Co., Ltd.
 Tel: +86-769-22022444 Fax: +86-769-22022799
 Web: [Http://www.ntc-c.com](http://www.ntc-c.com)

Radiated Emission Measurement

File :Expedition Express+ Data :#15 Date: 2019/4/24 Time: 1:23:44
 80.0 dBuV/m

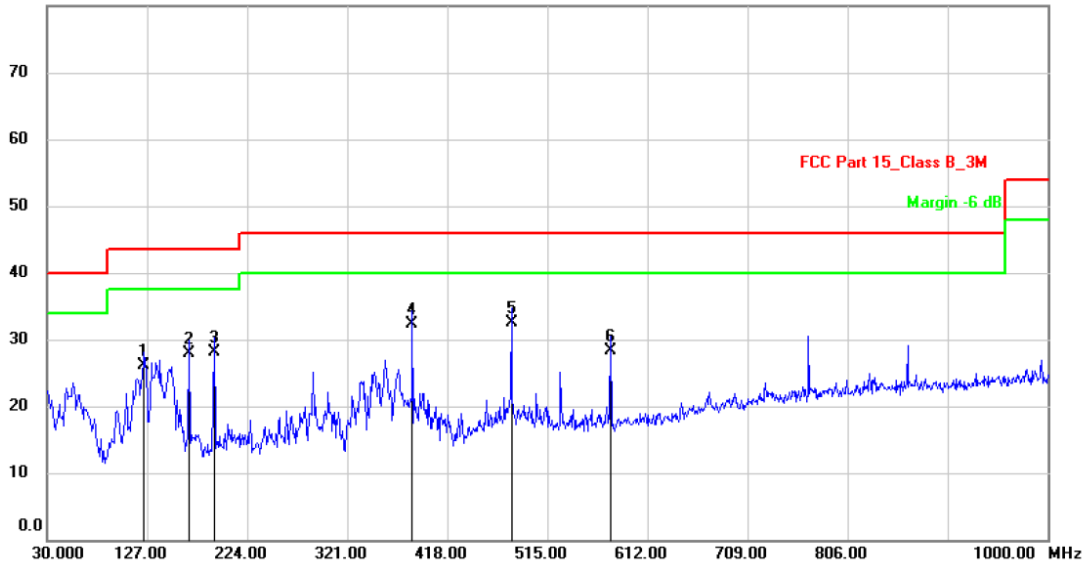

Site: 3m Chamber Polarization: *Vertical* Temperature: 26
 Limit: FCC Part 15_Class B_3M Power: AC120V/60Hz Humidity: 47 %
 EUT: Portable PA System Distance: 3m
 M/N: Expedition Express+
 Mode: TX+ Charging
 Note:

No.	Mk.	Freq.	Reading Level	Correct Factor	Measurement	Limit	Over	Antenna Height	Table Degree	
		MHz	dBuV	dB/m	dBuV/m	dBuV/m	dB	cm	degree	Comment
1		124.0900	43.61	-17.51	26.10	43.50	-17.40	QP		
2		167.7400	45.79	-17.89	27.90	43.50	-15.60	QP		
3		191.9900	44.71	-16.51	28.20	43.50	-15.30	QP		
4		384.0500	43.59	-11.19	32.40	46.00	-13.60	QP		
5	*	480.0800	41.81	-9.21	32.60	46.00	-13.40	QP		
6		576.1100	36.10	-7.70	28.40	46.00	-17.60	QP		

Note: Below 30MHz, the emissions are lower than 20dB below the allowable limit.

Modulation: $\pi/4$ -DQPSK (The Worst Case)
 Frequency Range: 1-25GHz Test Date : April 27, 2019
 Test Result: PASS Temperature : 24 °C
 Measured Distance: 3m Humidity : 47 %
 Test By: Sance

Freq. (MHz)	Ant.Pol. (H/V)	Reading Level(dBuV)		Factor (dB/m)	Emission Level (dBuV)		Limit 3m (dBuV/m)		Margin (dB)	
		PK	AV		PK	AV	PK	AV	PK	AV
Operation Mode: TX Mode (Low)										
4804	V	49.86	37.13	6.30	56.16	43.43	74.00	54.00	-17.84	-10.57
7206	V	46.39	32.78	10.44	56.83	43.22	74.00	54.00	-17.17	-10.78

4804	H	53.50	39.67	6.30	59.80	45.97	74.00	54.00	-14.20	-8.03
7206	H	47.49	31.13	10.44	57.93	41.57	74.00	54.00	-16.07	-12.43

Operation Mode: TX Mode (Mid)										
4882	V	50.18	37.02	6.60	56.78	43.62	74.00	54.00	-17.22	-10.38
7323	V	47.81	34.21	10.55	58.36	44.76	74.00	54.00	-15.64	-9.24

4882	H	55.02	40.57	6.60	61.62	47.17	74.00	54.00	-12.38	-6.83
7323	H	47.86	33.89	10.55	58.41	44.44	74.00	54.00	-15.59	-9.56

Operation Mode: TX Mode (High)										
4960	V	47.71	31.87	6.89	54.60	38.76	74.00	54.00	-19.40	-15.24
7440	V	46.59	33.21	10.60	57.19	43.81	74.00	54.00	-16.81	-10.19

4960	H	51.30	34.54	6.89	58.19	41.43	74.00	54.00	-15.81	-12.57
7440	H	48.49	34.10	10.60	59.09	44.70	74.00	54.00	-14.91	-9.30

- Note:**
- (1) All Readings are Peak Value and AV.
 - (2) Emission Level= Reading Level + Factor
 - (3) Factor= Antenna Gain + Cable Loss – Amplifier Gain
 - (4) Data of measurement within this frequency range shown “ ---” in the table above means the reading of emissions are attenuated more than 10dB below the permissible limits.
 - (5) Measurement uncertainty : ± 3.7 dB.
 - (6) Horn antenna used for the emission over 1000MHz.

5. Channel Separation test

5.1 Measurement Procedure

Minimum Hopping Channel Carrier Frequency Separation, FCC Rule 15.247(a)(1):

Connect EUT antenna terminal to the spectrum analyzer with a low loss cable, and using the MARKER and Max-Hold function to record the separation of two adjacent channels.

5.2 Test SET-UP (Block Diagram of Configuration)

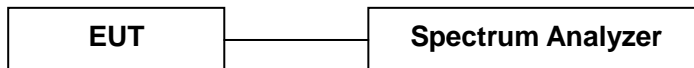

5.3 Measurement Results

Modulation:	GFSK, $\pi/4$ -DQPSK		
RBW:	100KHz	VBW:	300KHz
Packet:	DH5, 2DH5	Spectrum Detector:	PK
Test By:	Sance	Test Date :	April 25, 2019
Temperature :	22 °C	Humidity :	53 %
Test Result:	PASS		

Channel number	Channel frequency (MHz)	Separation Read Value (KHz)	Separation Limit 2/3 20dB Bandwidth (KHz)
GFSK			
Lowest	2402	1002	>632.3
Middle	2441	1002	>634.4
Highest	2480	1002	>631.6
$\pi/4$-DQPSK			
Lowest	2402	1002	>872.7
Middle	2441	1002	>872.7
Highest	2480	1002	>872.7

GFSK Lowest Channel

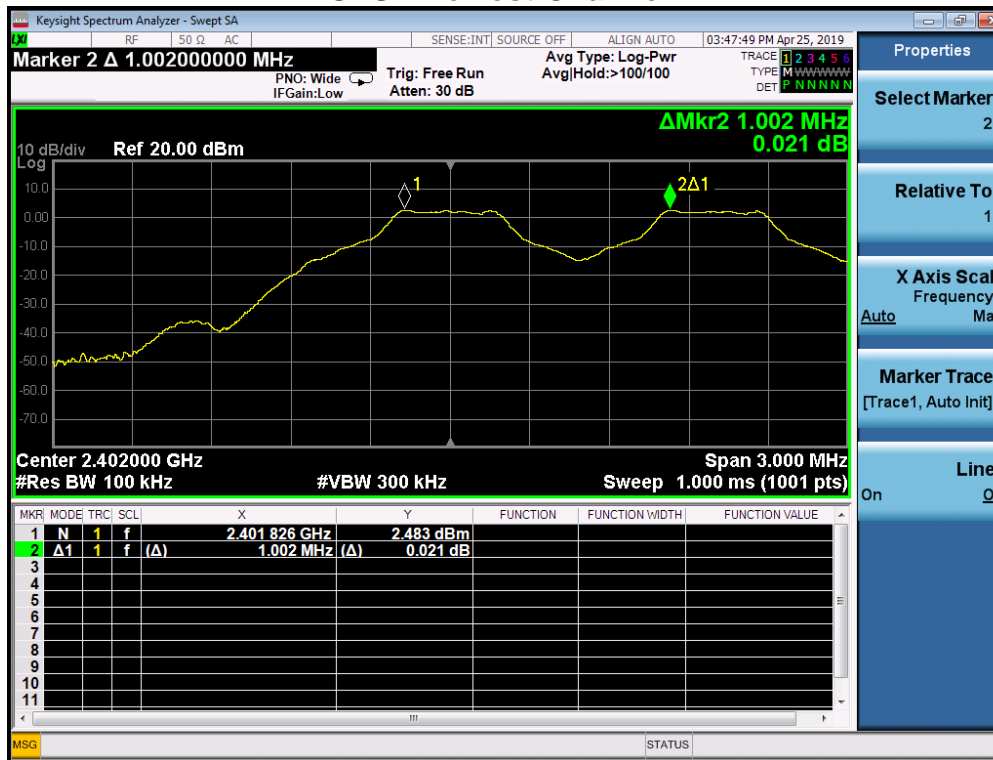

GFSK Middle Channel

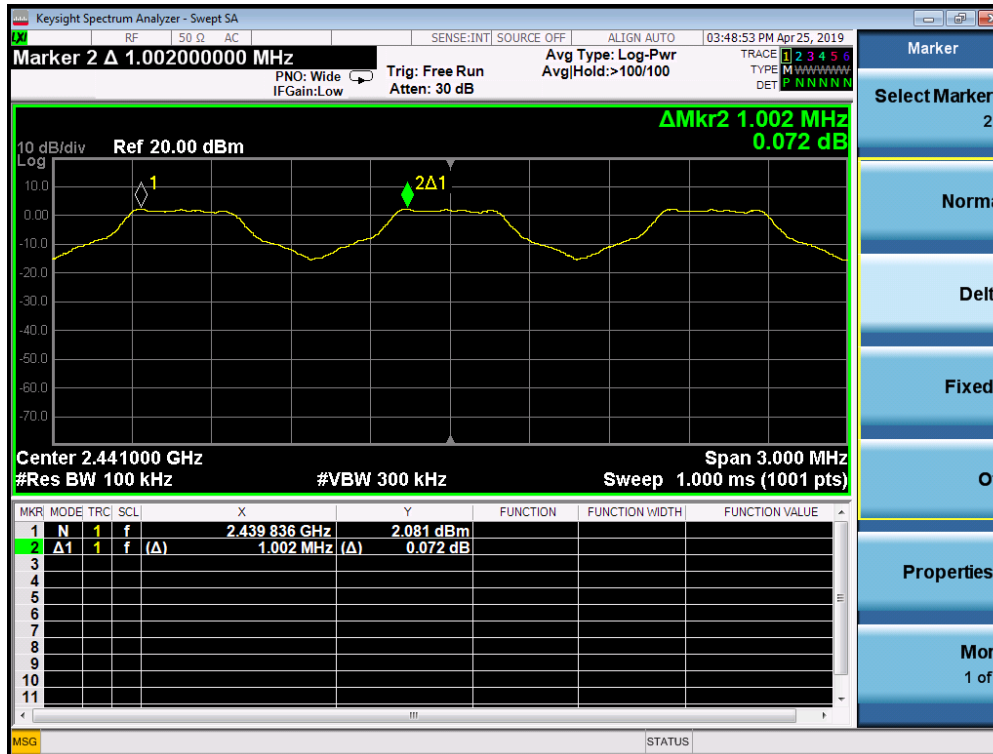

GFSK Highest Channel



$\pi/4$ -DQPSK Lowest Channel

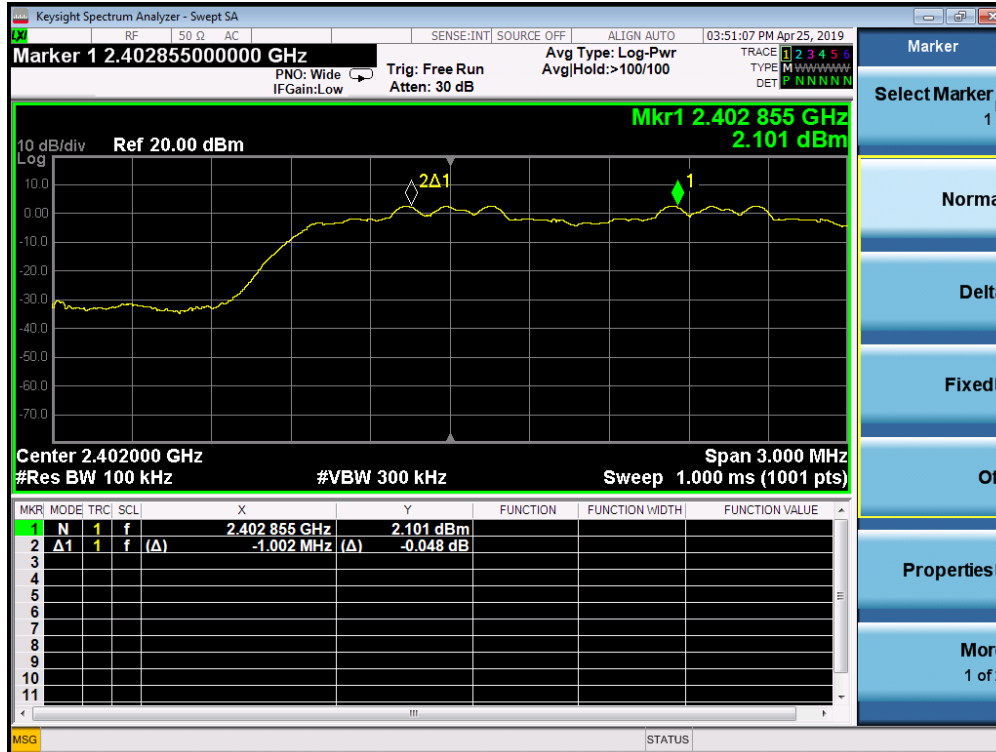

$\pi/4$ -DQPSK Middle Channel

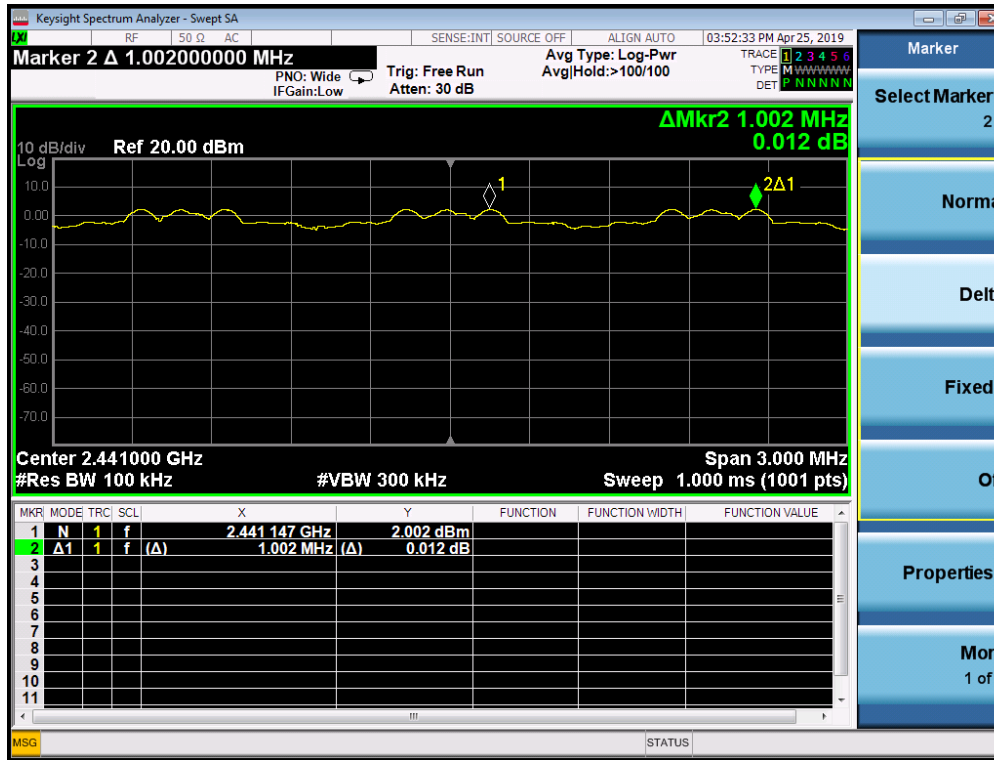

$\pi/4$ -DQPSK Highest Channel

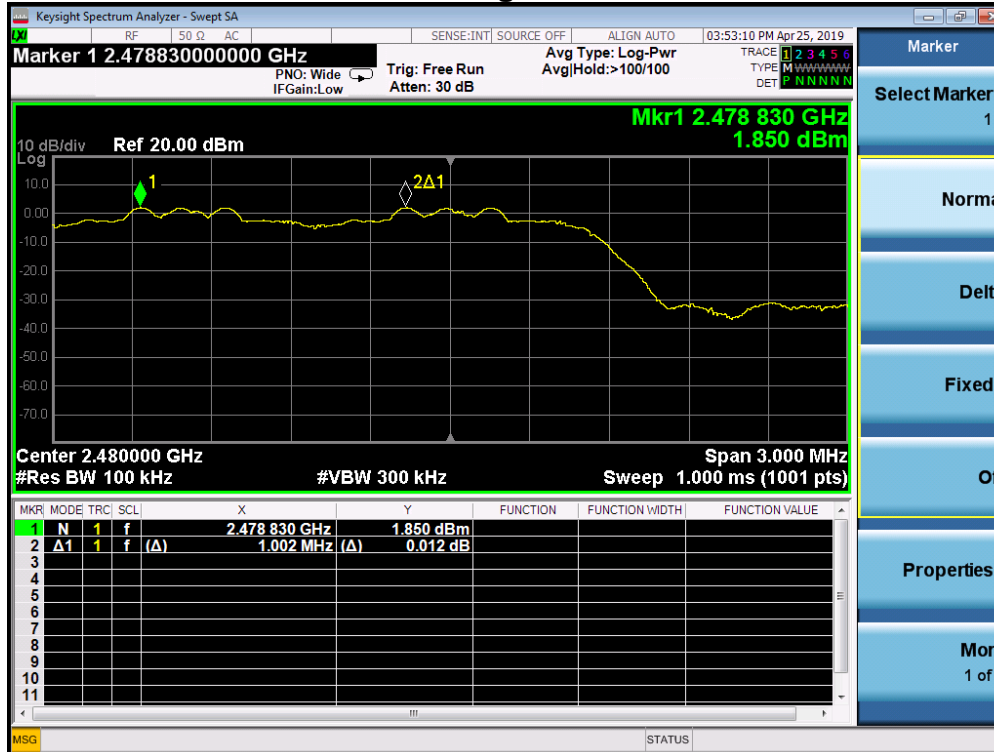

6. 20dB Bandwidth

6.1 Measurement Procedure

Maximum 20dB RF Bandwidth, FCC Rule 15.247(a)(1):

The antenna port of the EUT was connected to the input of a spectrum analyzer. Analyzer RBW was chosen so that the display was a result of the hopping channel modulation. For each RF output channel investigated, the spectrum analyzer center frequency was set to the channel carrier. Use the spectrum 20dB down delta function to measure the bandwidth.

6.2 Test SET-UP (Block Diagram of Configuration)

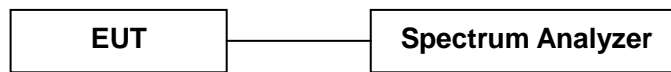

6.3 Measurement Results

Refer to attached data chart.

Modulation: GFSK, π /4-DQPSK
RBW: 30KHz VBW: 100KHz
Packet: DH5, 2DH5 Spectrum Detector: PK
Test By: Sance Test Date : April 25, 2019
Temperature : 22 °C Humidity : 53 %
Test Result: PASS

Channel frequency (MHz)	20dB Down BW(kHz)
GFSK	
2402	948.5
2441	951.6
2480	947.4
π /4-DQPSK	
2402	1309.0
2441	1309.0
2480	1309.0

GFSK Lowest Channel



GFSK Middle Channel

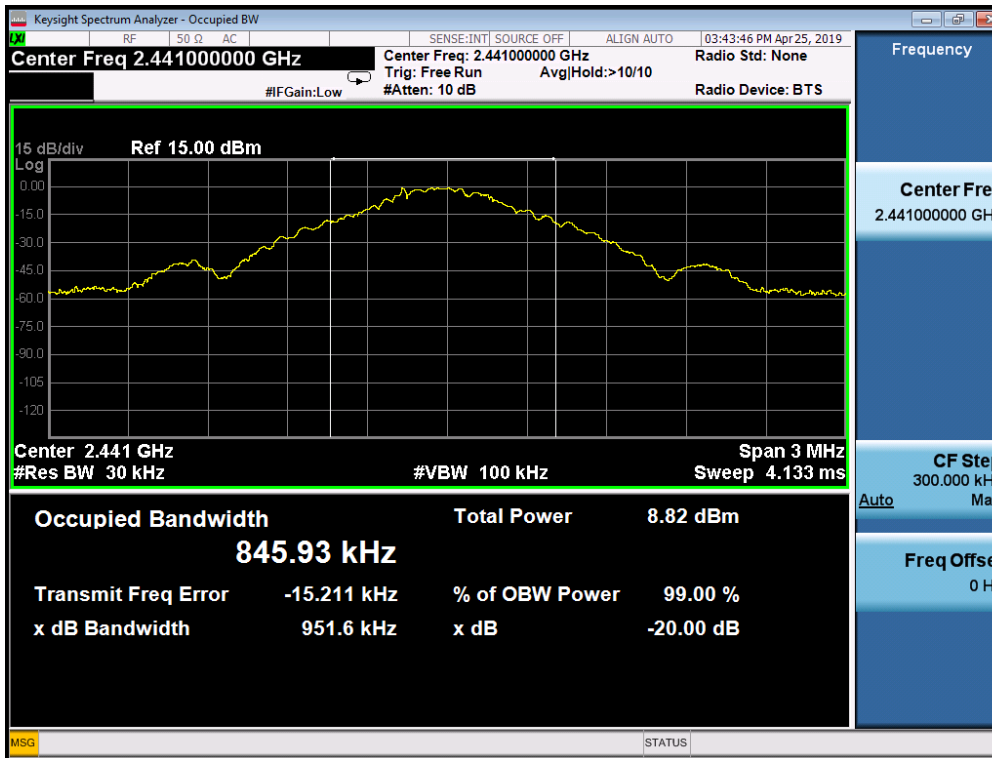

GFSK Highest Channel

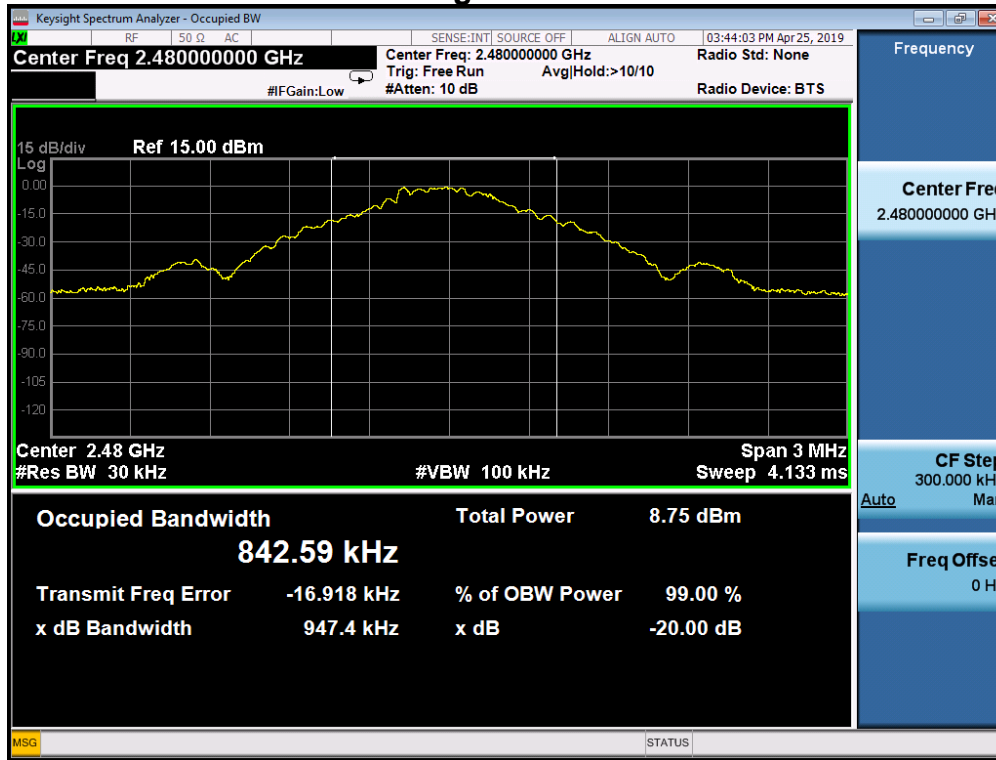

$\pi/4$ -DQPSK Lowest Channel

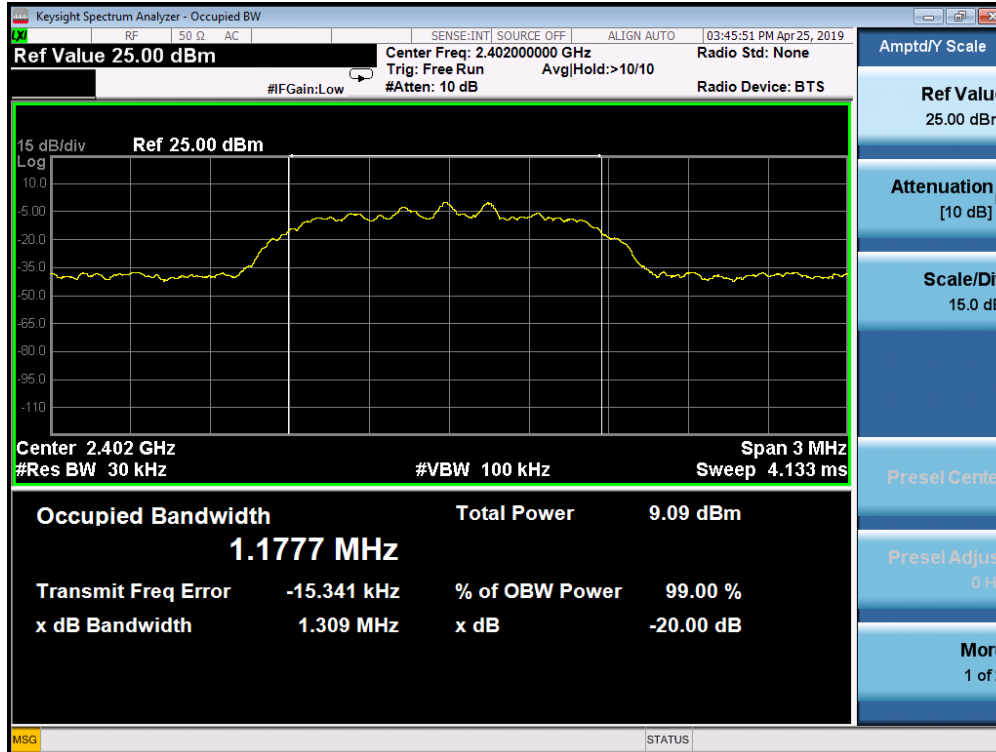

$\pi/4$ -DQPSK Middle Channel

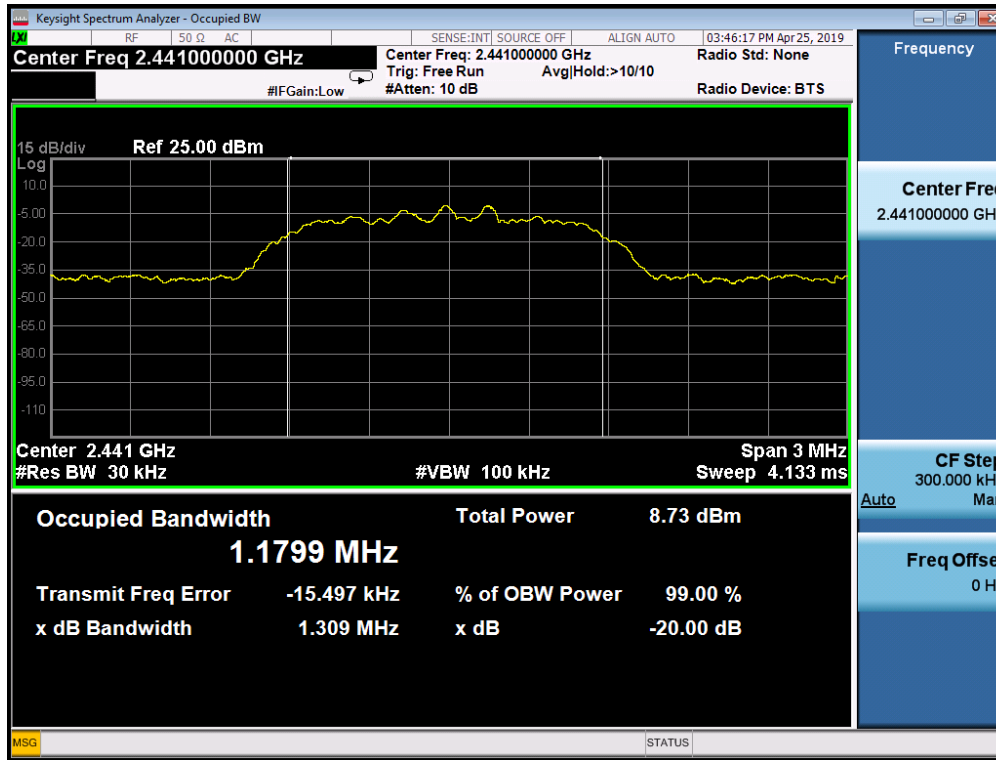

$\pi/4$ -DQPSK Highest Channel

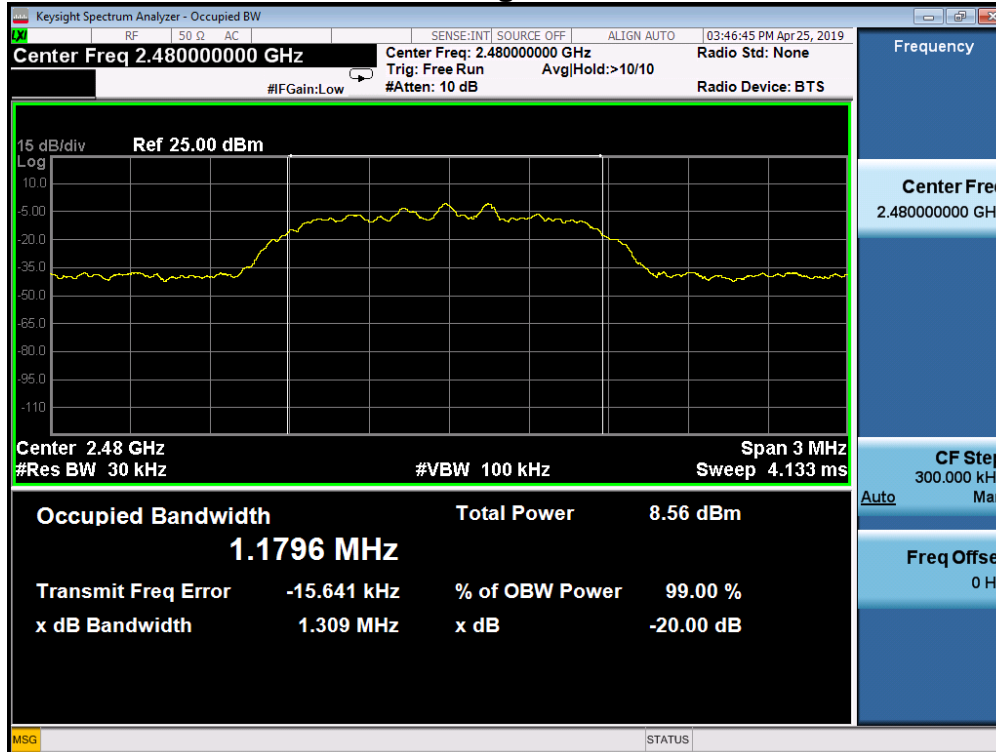

7. Hopping Channel Number

7.1 Measurement Procedure

Minimum Number of Hopping Frequencies, FCC Rule 15.247(a)(1)(iii):

Remove the antenna from the EUT and then connect a low RF cable from the antenna port to the spectrum, and the spectrum analyzer set to MAX HOLD readings were taken for 3-5 minutes. The channel peaks so recorded were added together, and the total number compared to the minimum number of channels required in the regulation.

7.2 Test SET-UP (Block Diagram of Configuration)



7.3 Measurement Results

Modulation	GFSK, π /4-DQPSK		
RBW:	100KHz	VBW:	300KHz
Packet:	DH5	Spectrum Detector:	PK
Test By:	Sance	Test Date :	April 25, 2019
Temperature :	22 °C	Humidity :	53 %
Test Result:	PASS		

Hopping Channel Frequency Range	Number of Hopping Channels	Limit
2402-2480	79	≥15

The worst case: π /4-DQPSK

$\pi/4$ -DQPSK

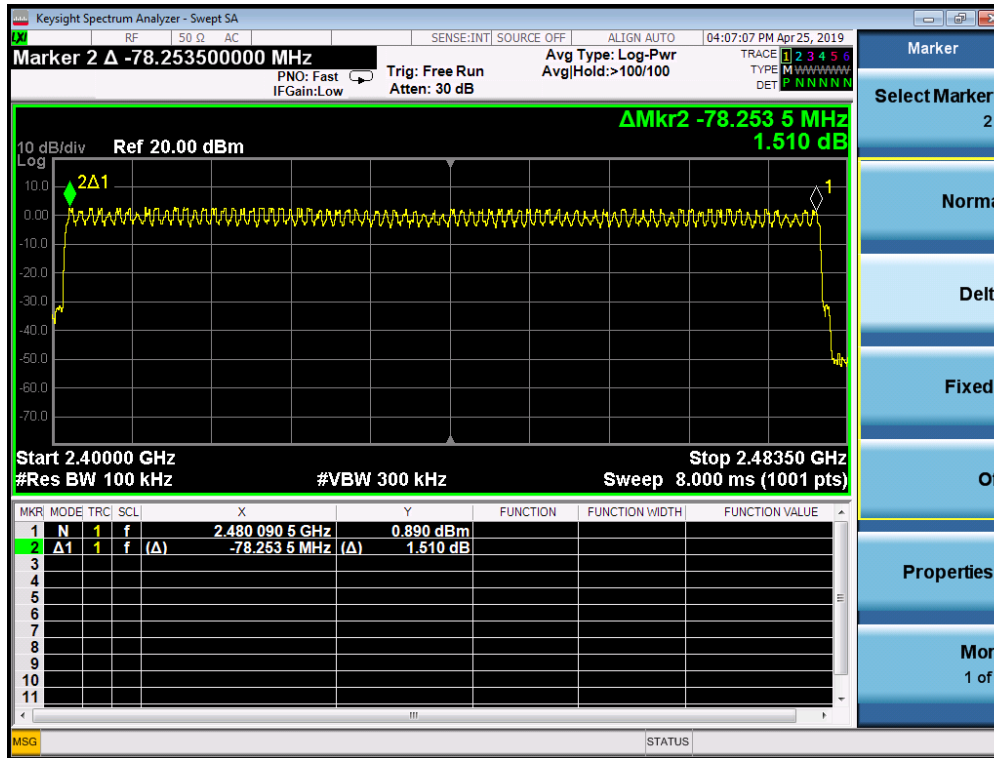

8. Time of Occupancy (Dwell Time)

8.1 Measurement Procedure

Average Channel Occupancy Time, FCC Ref:15.247(a)(1)(iii):

Connect EUT antenna terminal to the spectrum analyzer with a low loss cable.
 The spectrum analyzer center frequency was set to one of the known hopping channels.
 The Sweep was set to 10 ms, the SPAN was set to Zero SPAN. The time duration of the transmissions so captured was measured with the Marker Delta function

8.2 Measurement Results

The maximum number of hopping channels in 31.6s (0.4s/Channel x 79 Channel)

Refer to attached data chart.

Modulation :	GFSK, $\pi/4$ -DQPSK	VBW :	3MHz
RBW :	1MHz	Test By:	Sance
Spectrum Detector:	PK	Temperature :	22°C
Test Date :	April 25, 2019	Humidity :	53 %
Test Result:	PASS		

Packet	Frequency (MHz)	Result (msec)	Limit (msec)
GFSK			
DH1	2441	0.3727 (ms)*(1600/(2*79))*31.6= 119.26	400
DH3	2441	1.6310 (ms)*(1600/(4*79))*31.6= 260.96	400
DH5	2441	2.8720 (ms)*(1600/(6*79))*31.6= 306.35	400
$\pi/4$-DQPSK			
2-DH1	2441	0.3863 (ms)*(1600/(2*79))*31.6= 123.62	400
2-DH3	2441	1.6390 (ms)*(1600/(4*79))*31.6= 262.24	400
2-DH5	2441	2.8860 (ms)*(1600/(6*79))*31.6= 307.84	400

GFSK DH1

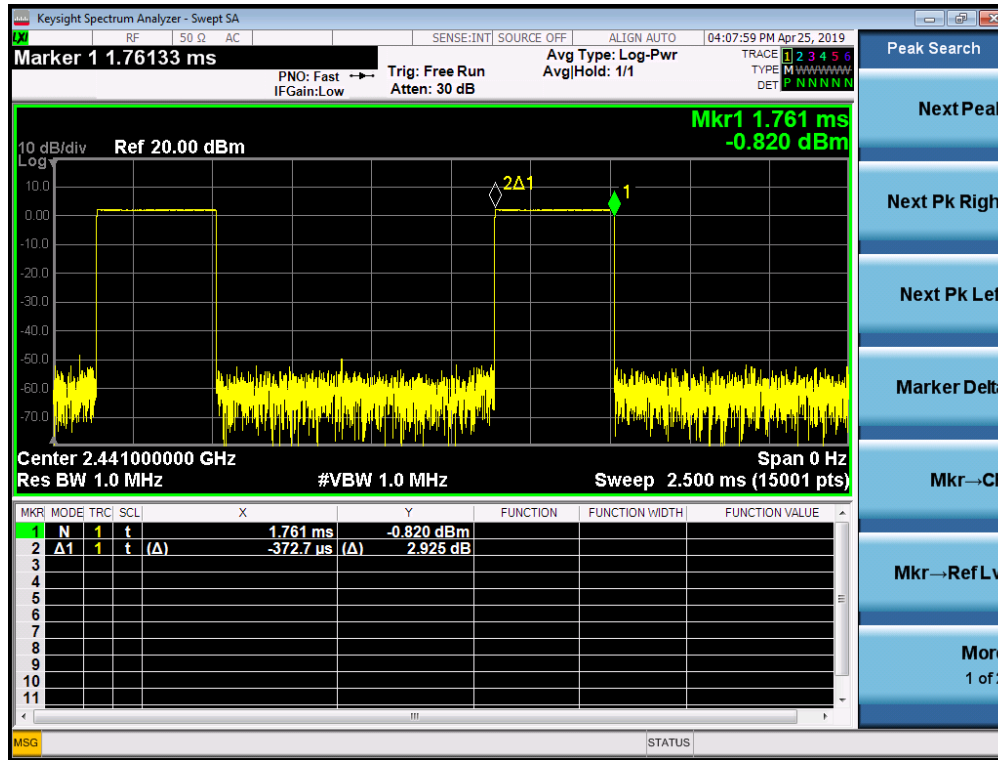

GFSK DH3

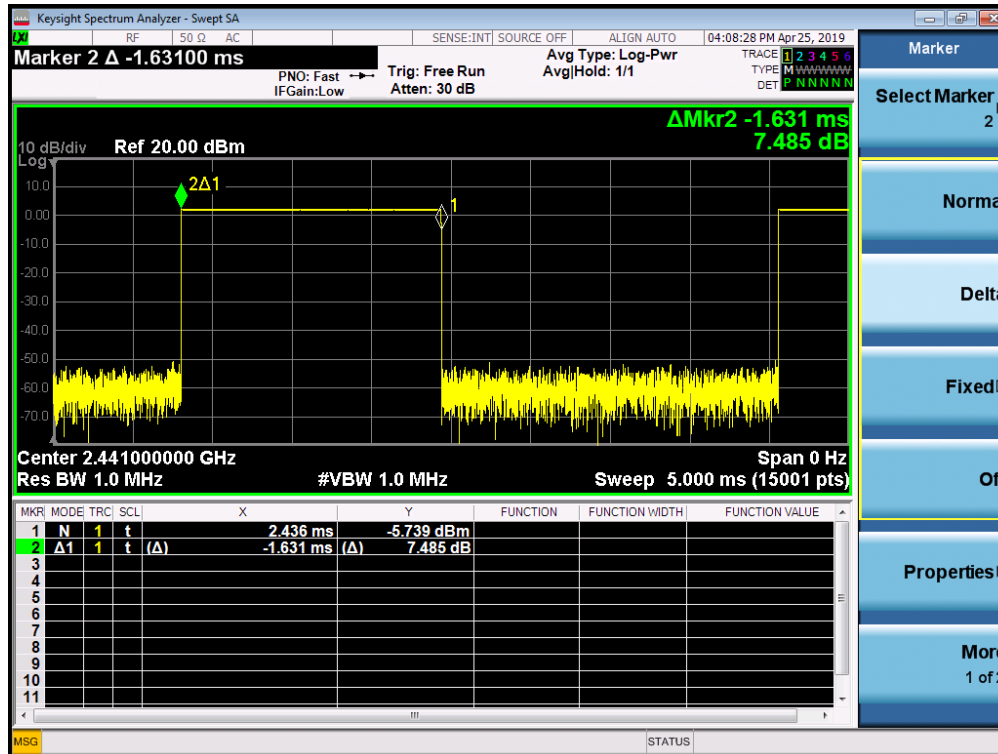

GFSK DH5

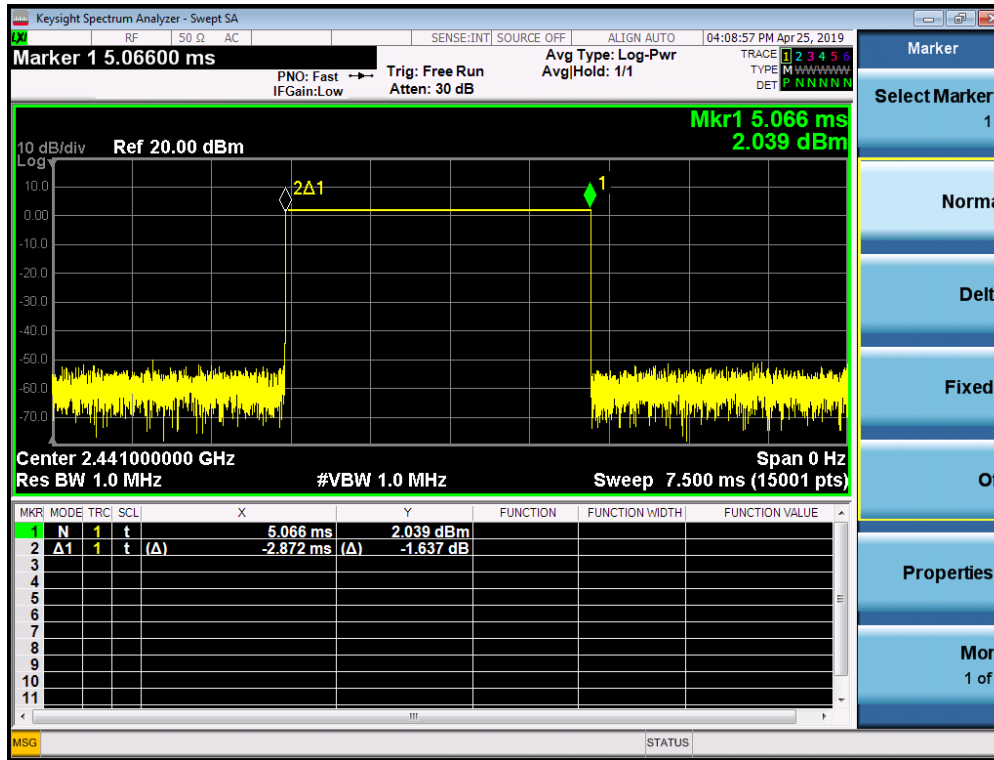

$\pi/4$ -DQPSK 2DH1

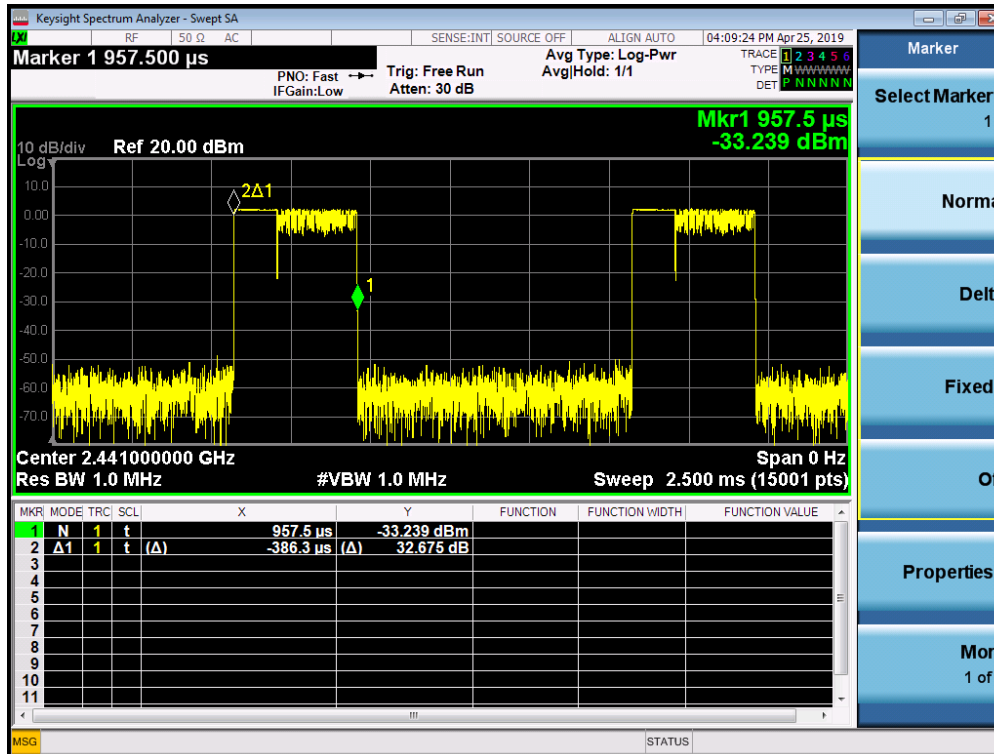

$\pi/4$ -DQPSK 2DH3

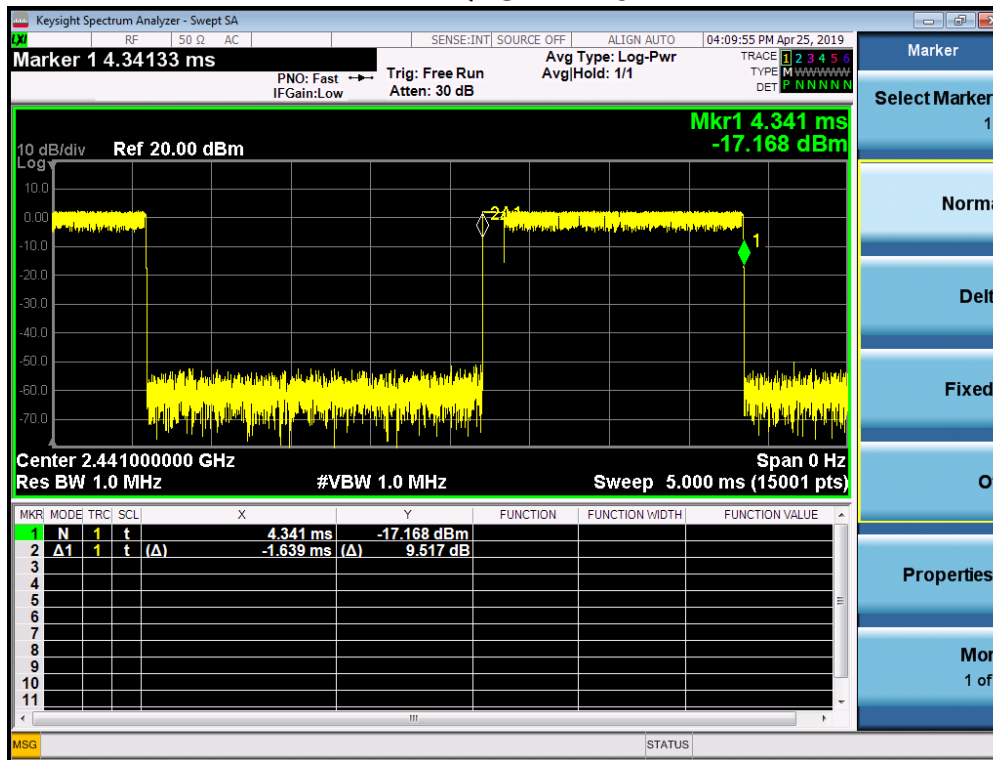

$\pi/4$ -DQPSK 2DH5

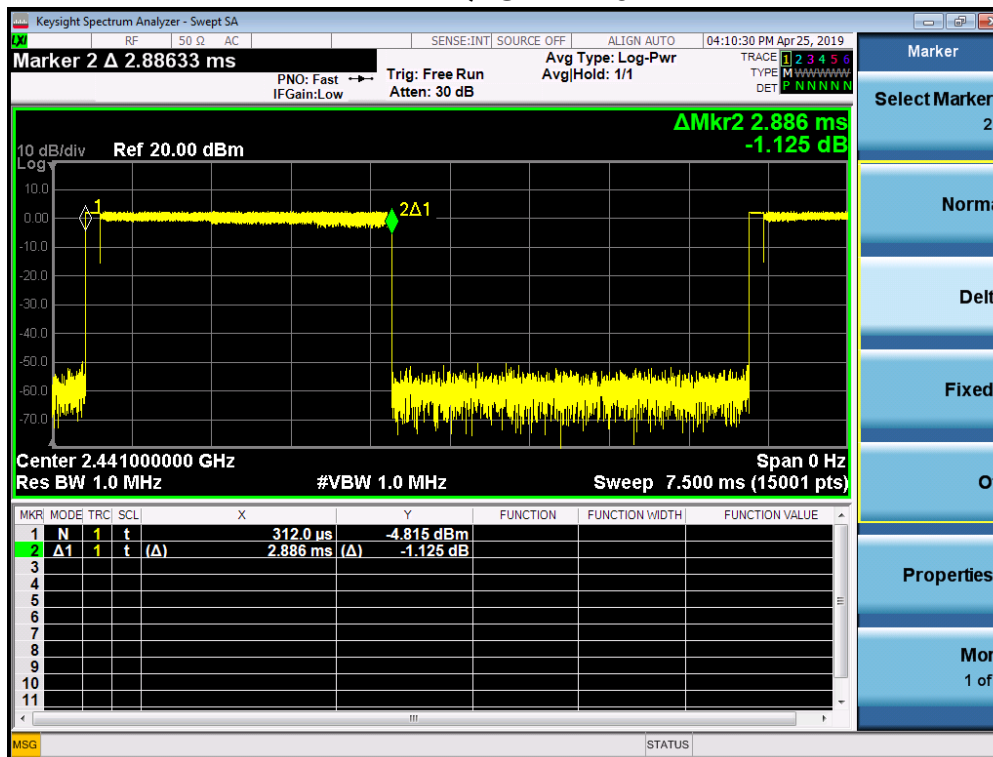

9. MAXIMUM PEAK OUTPUT POWER

9.1 Measurement Procedure

Maximum Conducted Output Power at Antenna Terminals, FCC Rules 15.247(b)(1):

Remove the antenna from the EUT and then connect a low RF cable from the antenna port to the spectrum. The analyzer was set for RBW > 20dB bandwidth and power was read directly in dBm. Cable loss was considered during this measurement.

9.2 Measurement Results

Refer to attached data chart.

Modulation :	GFSK, $\pi/4$ -DQPSK		
RBW :	3MHz	VBW :	3MHz
Spectrum Detector:	PK	Test Date :	April 25, 2019
Test By:	Sance	Temperature :	22 °C
Test Result:	PASS	Humidity :	53 %

Channel Frequency (MHz)	Cable Loss (dB)	Peak Power output (dBm)	Peak Power output (mW)	Peak Power Limit (dBm)	Pass/Fail
GFSK					
2402.00	1.5	2.601	1.820	21	PASS
2441.00	1.5	2.235	1.673	21	PASS
2480.00	1.5	2.043	1.601	21	PASS
$\pi/4$ -DQPSK					
2402.00	1.5	3.331	2.153	21	PASS
2441.00	1.5	2.936	1.966	21	PASS
2480.00	1.5	2.750	1.884	21	PASS

GFSK Lowest Channel

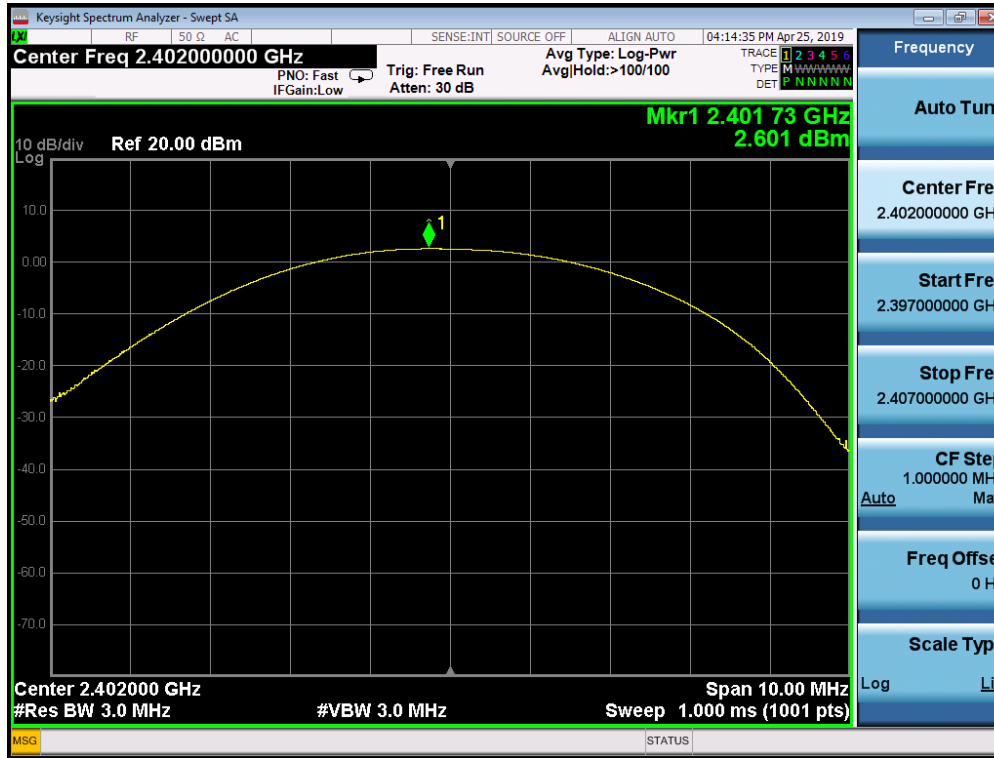

GFSK Middle Channel

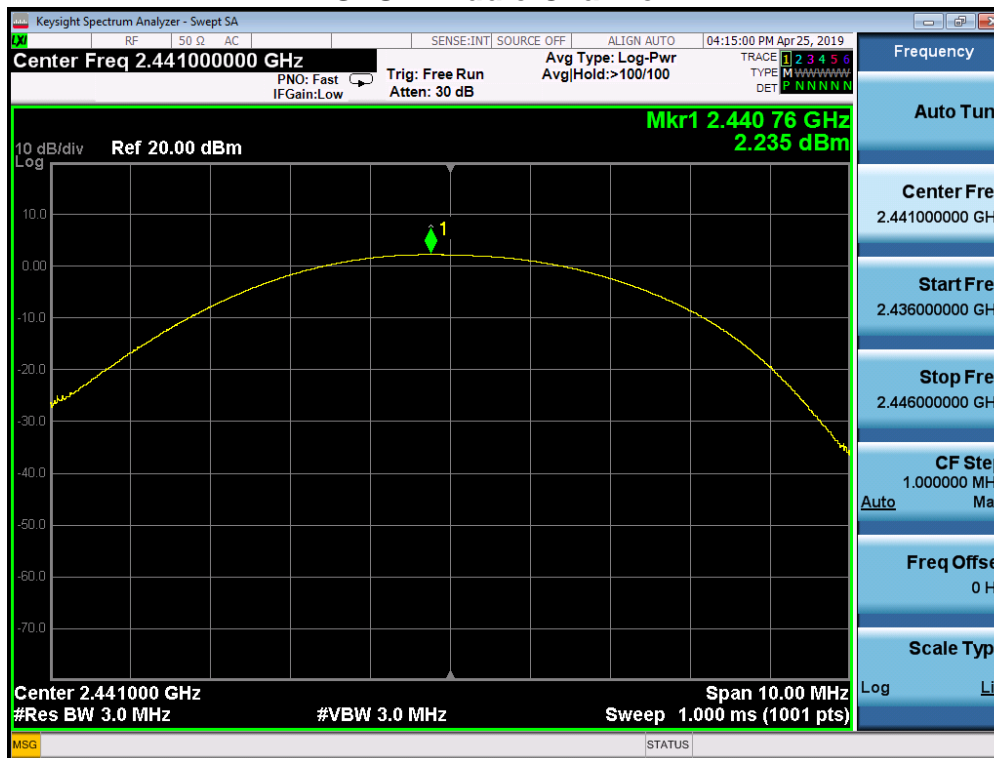

GFSK Highest Channel

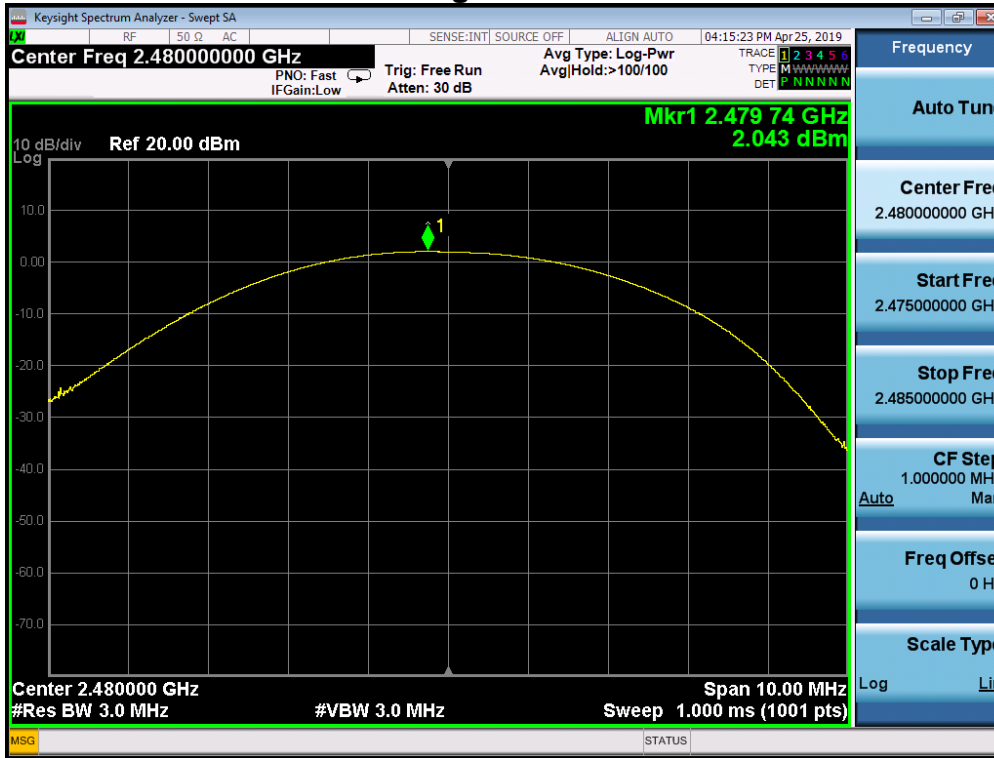

$\pi/4$ -DQPSK Lowest Channel

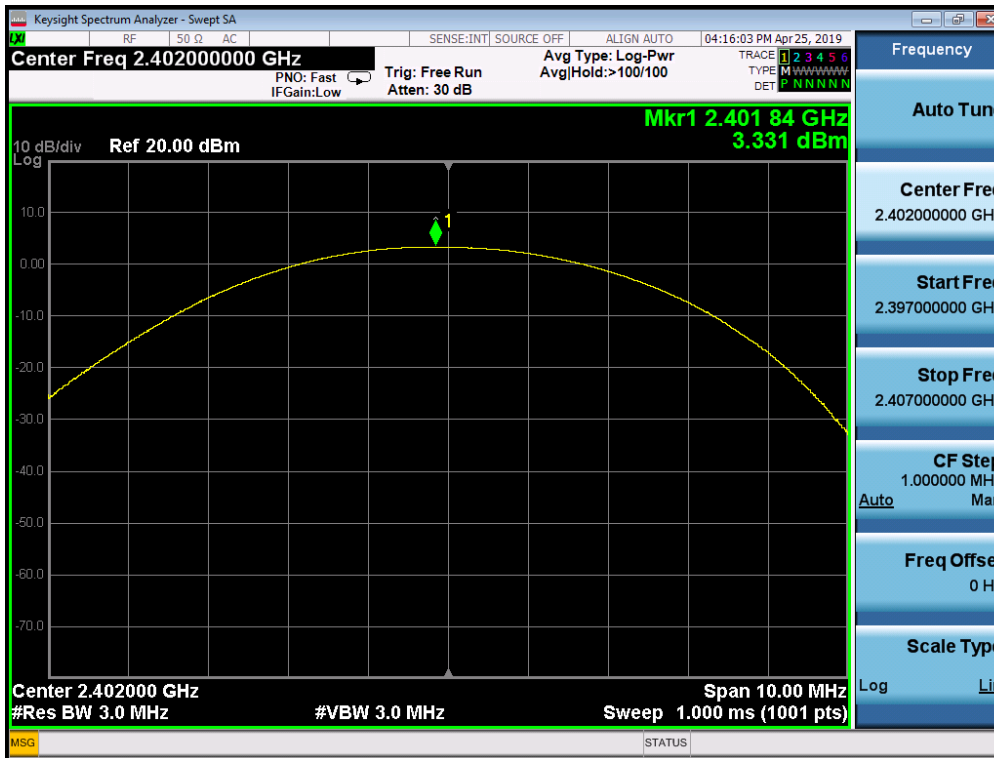

$\pi/4$ -DQPSK Middle Channel



$\pi/4$ -DQPSK Highest Channel

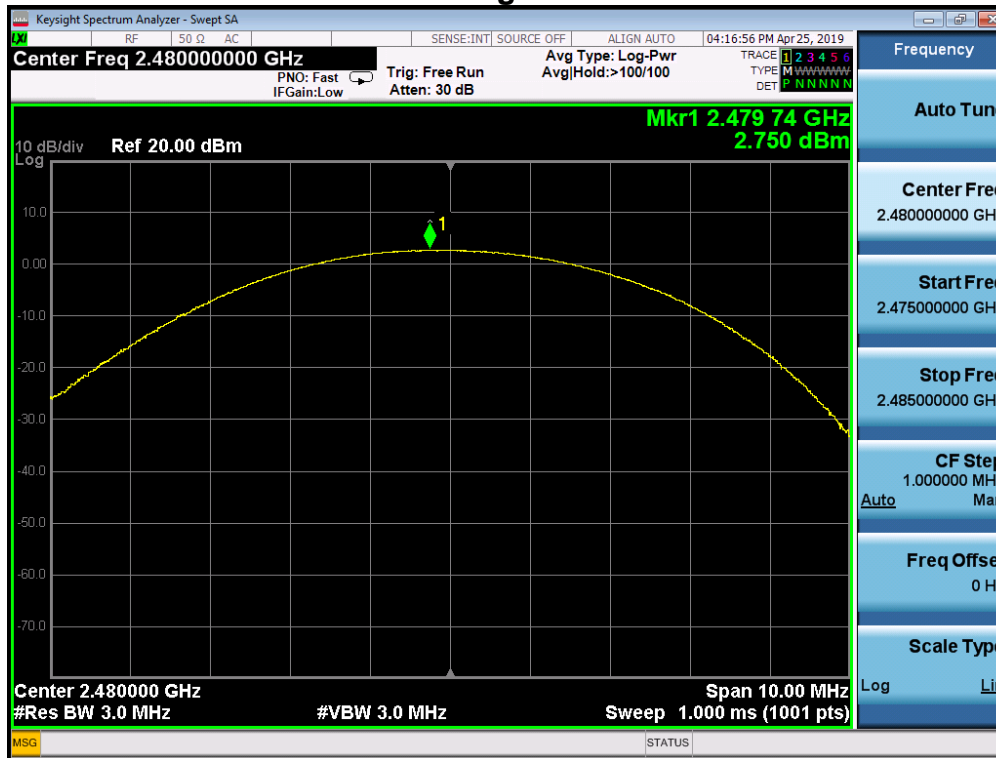

10. Band Edge

10.1 Measurement Procedure

Out of Band Conducted Emissions, FCC Rule 15.247(d):

The transmitter output is connected to spectrum analyzer. The resolution bandwidth is set to 100KHz, and the video bandwidth set to 300KHz.

10.2 Limit

15.247(d) In any 100KHz bandwidth outside the frequency band in which the spread spectrum or digitally modulated intentional radiator is operating, the radio frequency power that is produced by the intentional radiator shall be at least 20dB below that in the 100KHz bandwidth within the band that contains the highest level of the desired power, based on either an RF conducted or a radiated measurement.

10.3 Measurement Results

Please see below test table and plots.

For Radiated Emission

The worst case : π /4-DQPSK

Hopping-on mode

Freq. (MHz)	Ant. Pol. (H/V)	Reading Level(dBuV)		Factor (dB/m)	Emission Level (dBuV)		Limit 3m (dBuV/m)		Margin (dB)	
		PK	AV		PK	AV	PK	AV	PK	AV
2390.000	H	44.42	31.66	0.09	44.51	31.75	74.00	54.00	-29.49	-22.25
2390.000	V	44.43	31.67	0.09	44.52	31.76	74.00	54.00	-29.48	-22.24
2483.500	H	46.21	31.14	0.35	-46.55	-34.48	74.00	54.00	-27.45	-19.52
2483.500	V	45.81	33.22	0.34	46.15	33.56	74.00	54.00	-27.85	-20.44

- Note:**
- (1) Emission Level= Reading Level + Factor
 - (2) Factor= Antenna Gain + Cable Loss – Amplifier Gain
 - (3) Horn antenna used for the emission over 1000MHz.

For RF Conducted

GFSK Lowest Channel

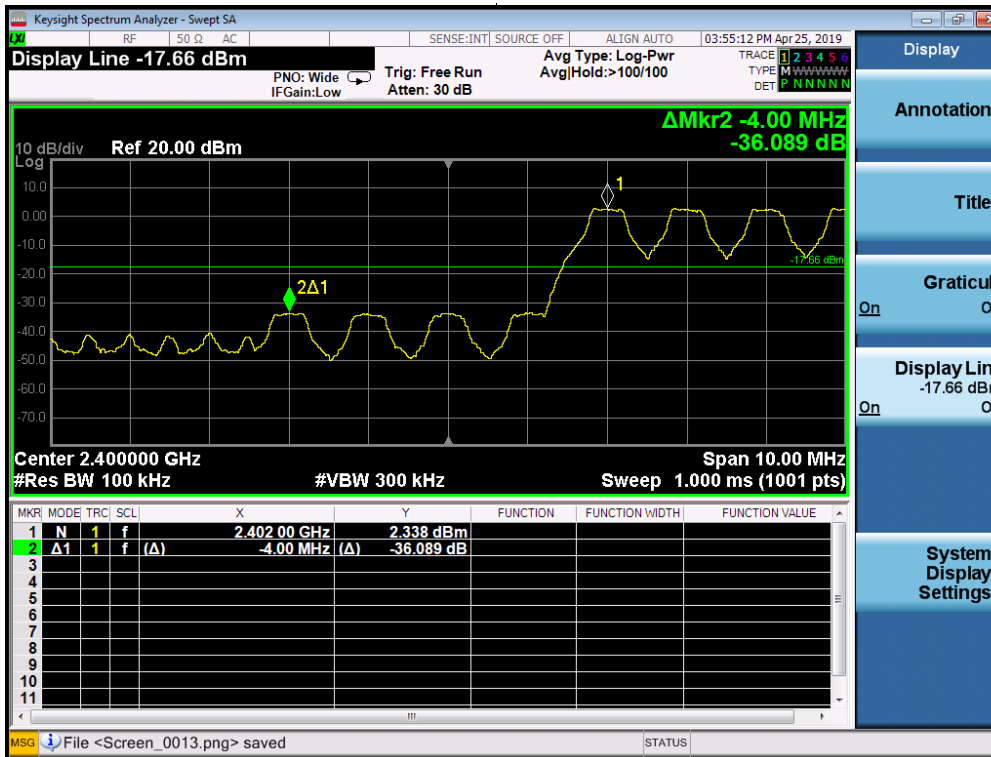
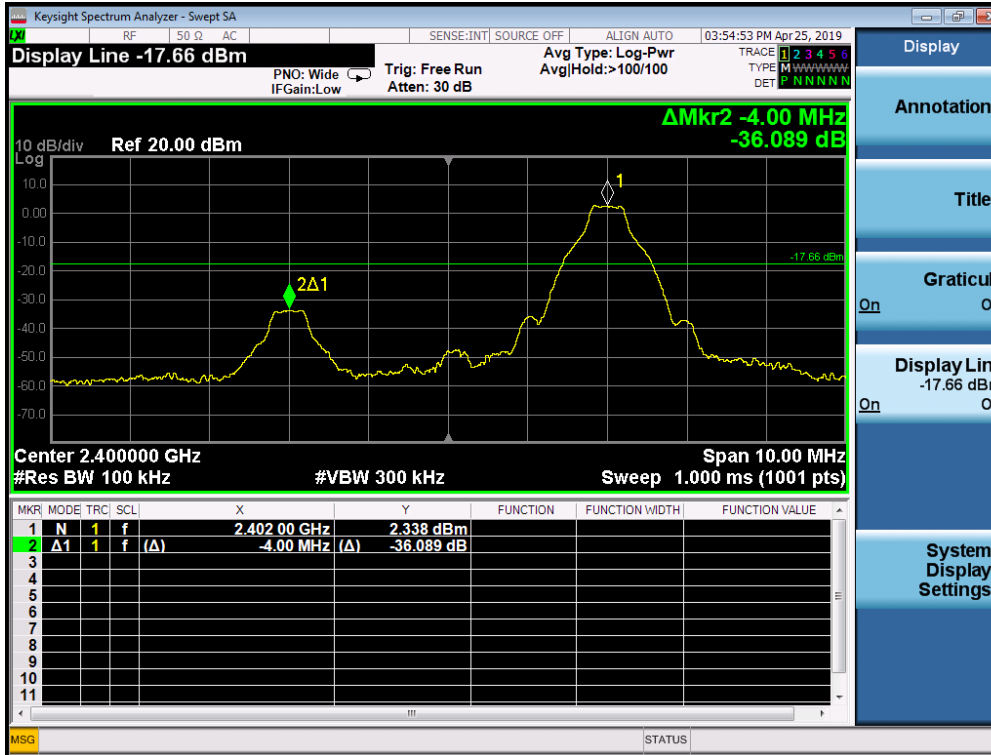

GFSK Highest Channel

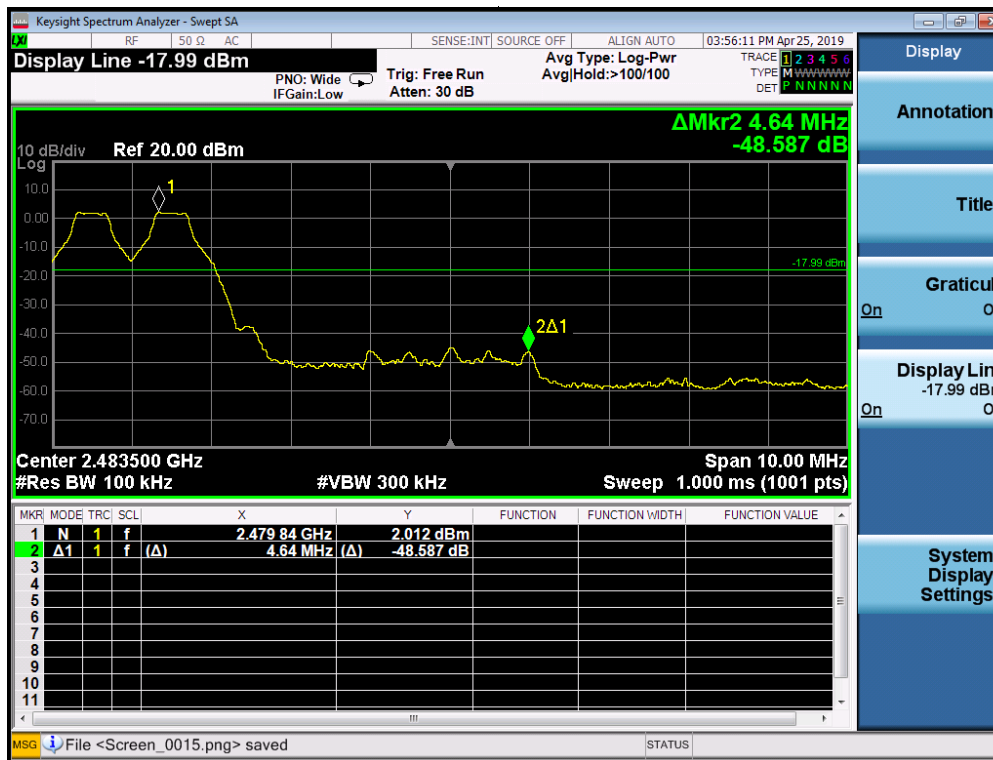
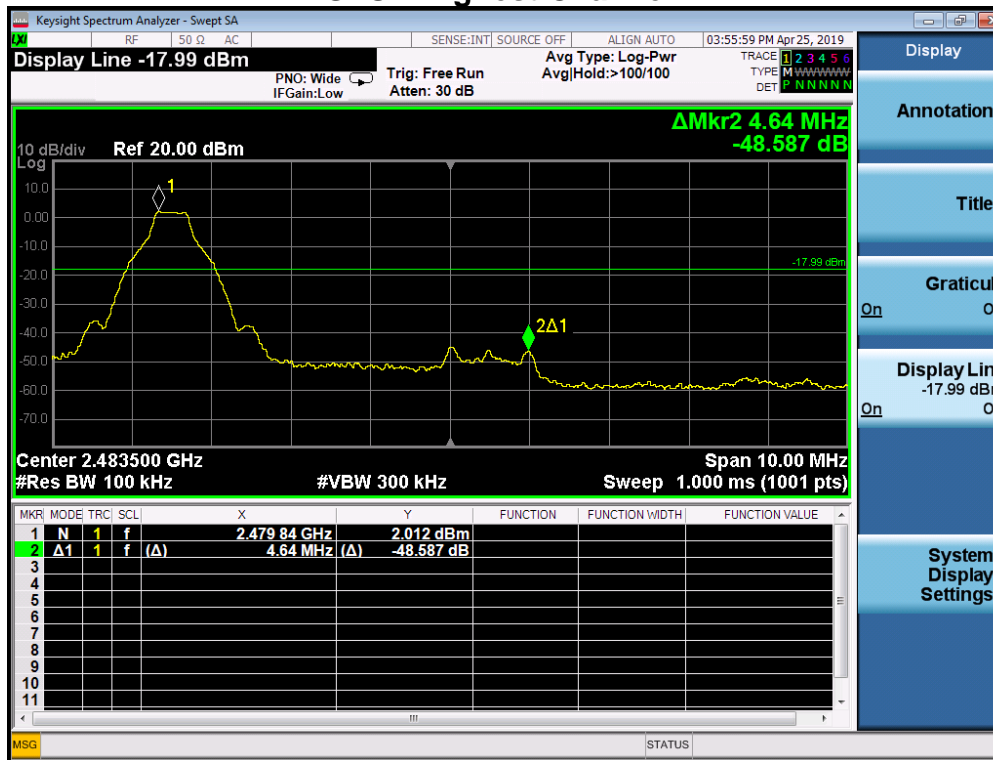

π /4DQPSK Lowest Channel

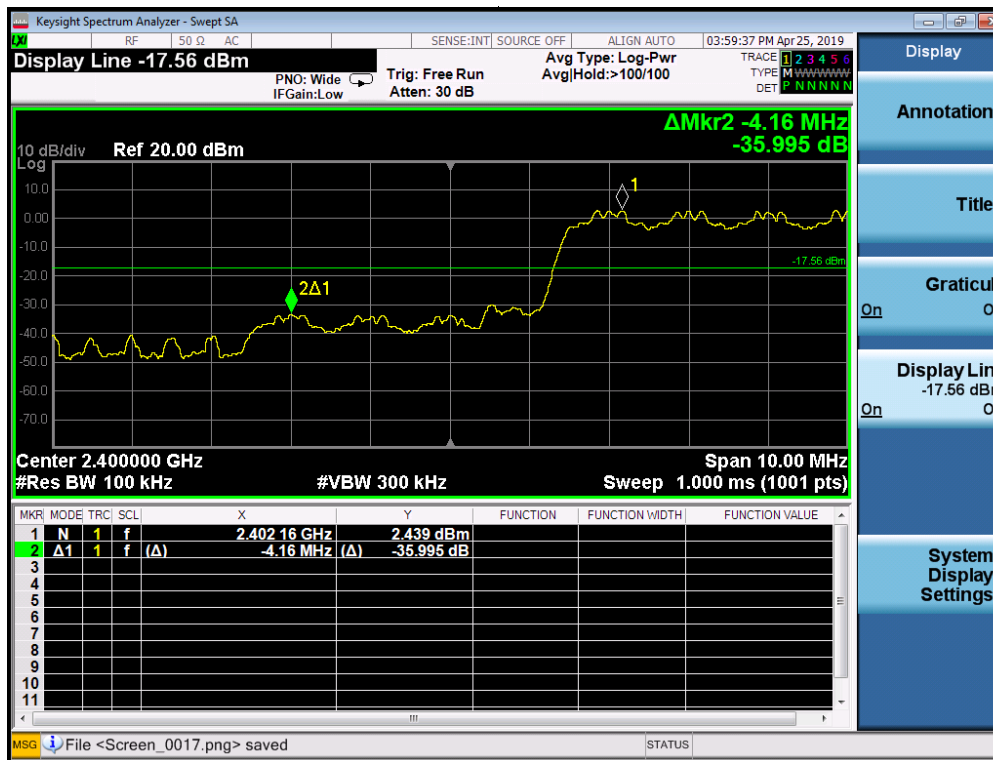
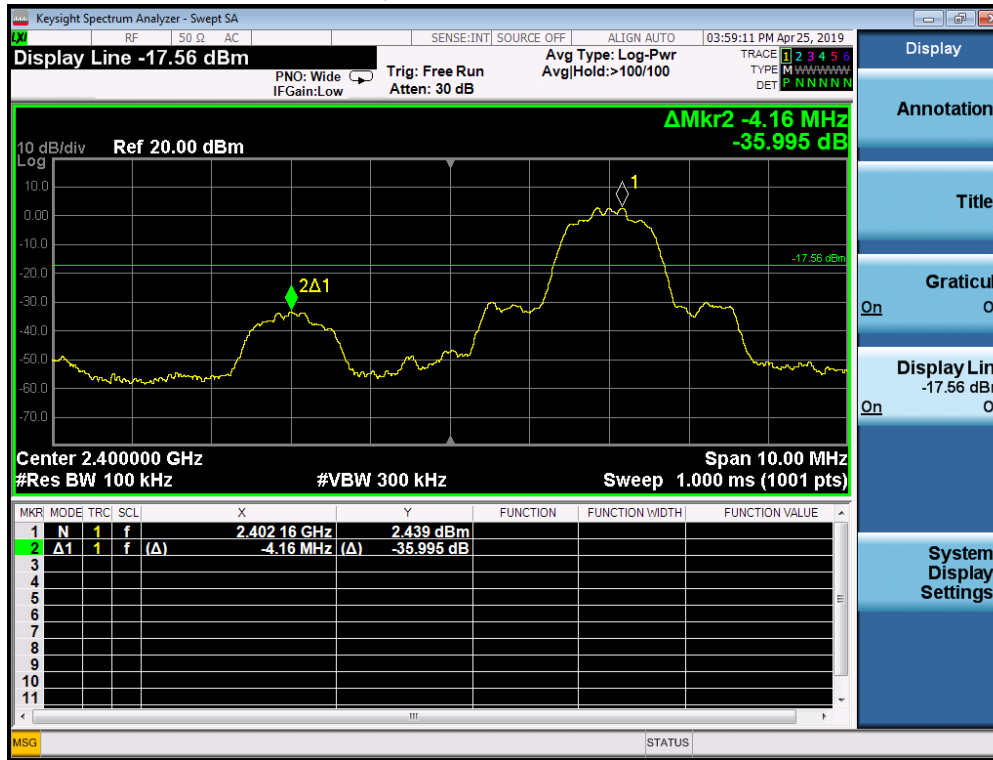

$\pi/4$ DQPSK Highest Channel

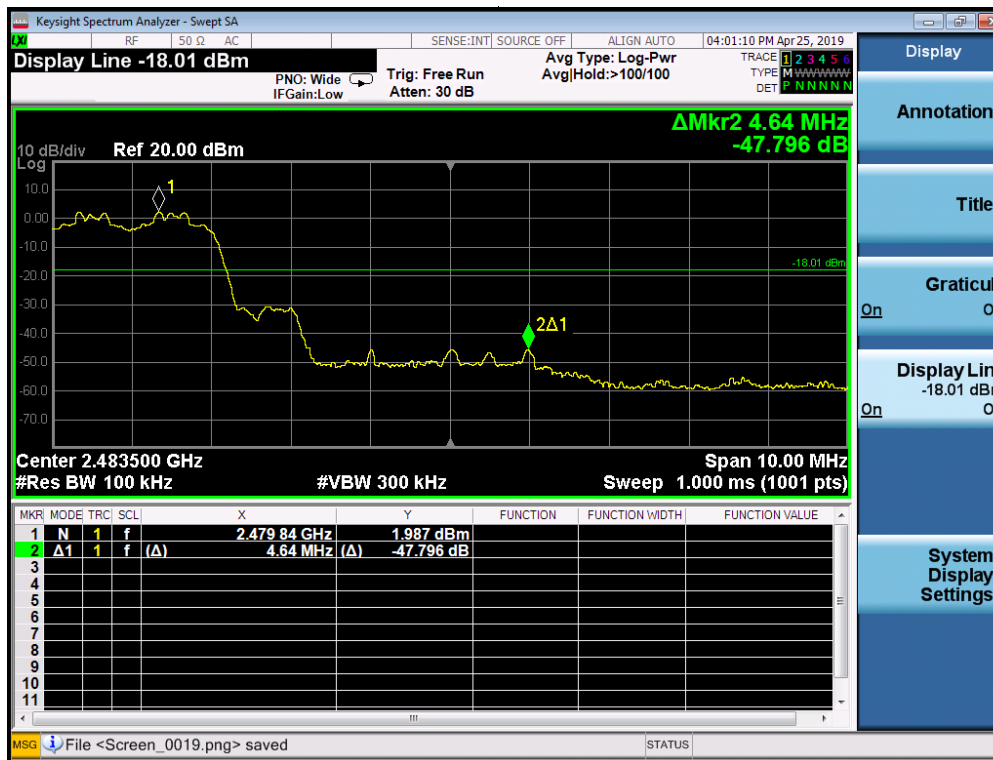
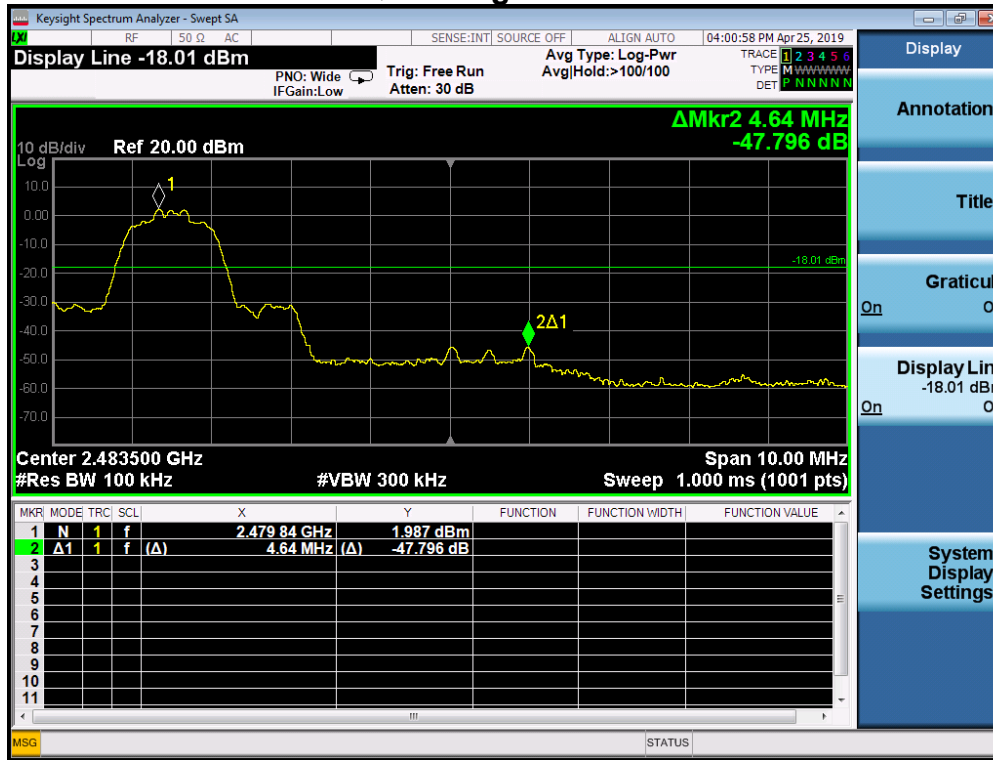

11. Antenna Application

11.1 Antenna requirement

According to of FCC part 15C section 15.203 and 15.240:

An intentional radiator shall be designed to ensure that no antenna other than that furnished by the responsible party shall be used with the device. The use of a permanently attached antenna or of an antenna that uses a unique coupling to the intentional radiator, the manufacturer may design the unit so that a broken antenna can be replaced by the user, but the use of a standard antenna jack or electrical connector is prohibited.

Systems operating in the 2400-2483.5MHz band that are used exclusively for fixed, point-to-point operations may employ transmitting antennas with directional gain greater than 6dBi provided the maximum peak output power of the intentional radiator is reduced by 1dB for every 3dB that the directional gain of the antenna exceeds 6dBi.

11.2 Measurement Results

The antenna is PCB Antenna and no consideration of replacement, and the best case gain of the antenna is 0 dBi. So, the antenna is consider meet the requirement.

12. Conducted Spurious Emissions

12.1 Measurement Procedure

Out of Band Conducted Spurious Emissions, FCC Rule 15.247(d):

The transmitter output is connected to spectrum analyzer. All spurious emission and up to the tenth harmonic was measured and they were found to be at least 20dB below the highest level of the desired power in the passband.

12.2 Measurement Results

Please refer to following plots, the worst case ($\pi/4$ -DQPSK) was shown.

Lowest Channel

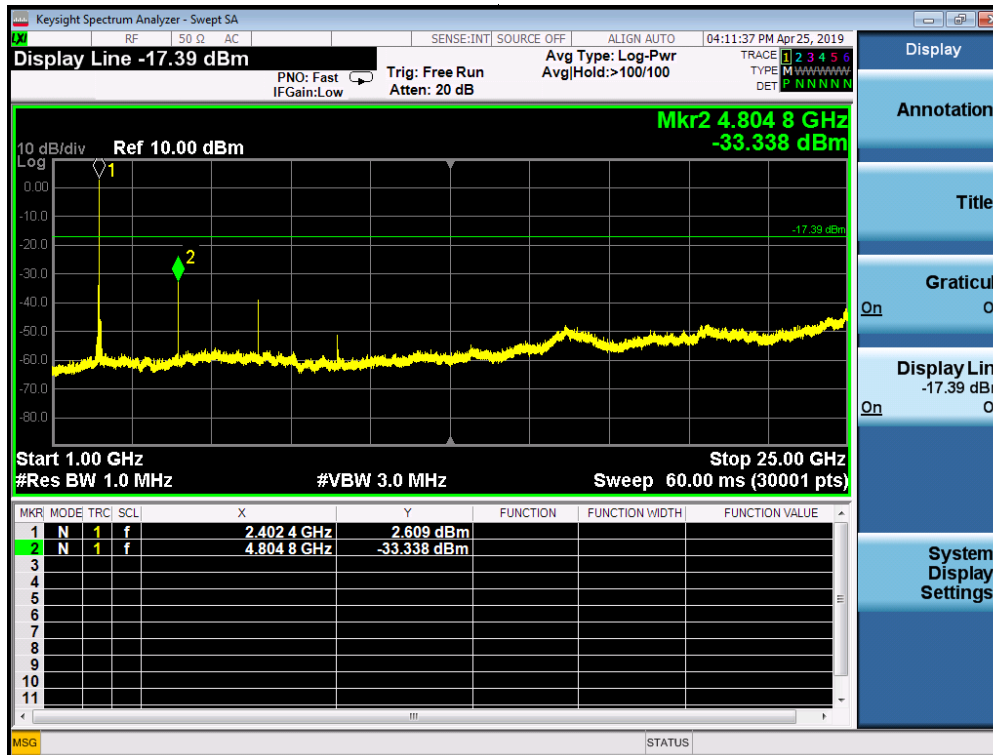
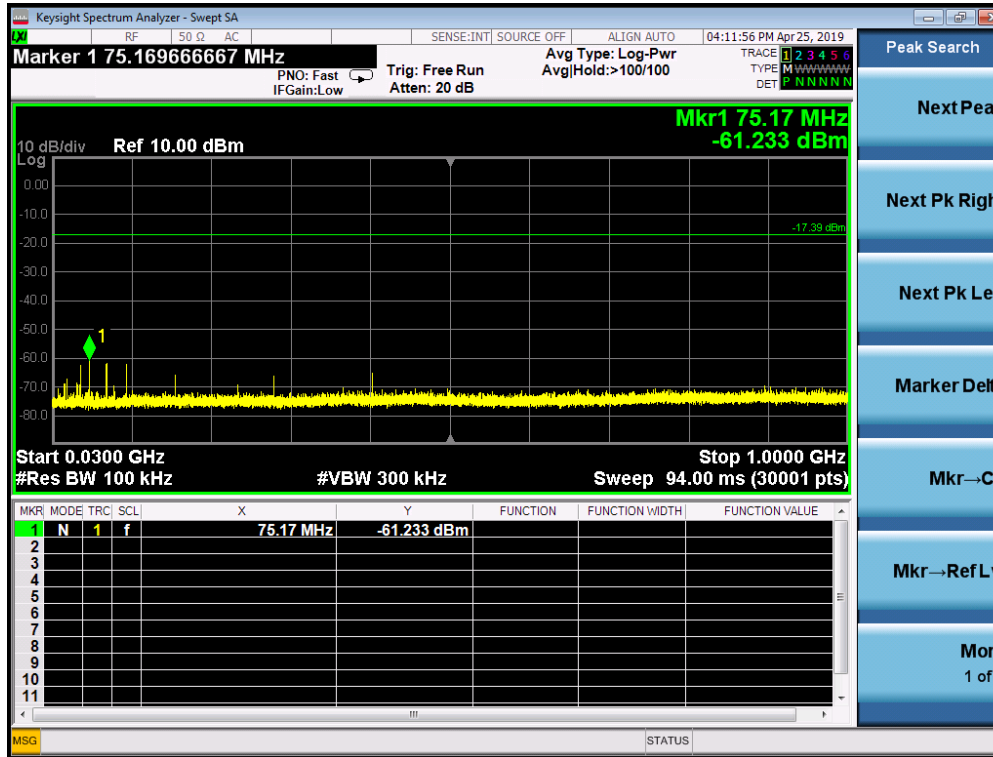

Middle Channel

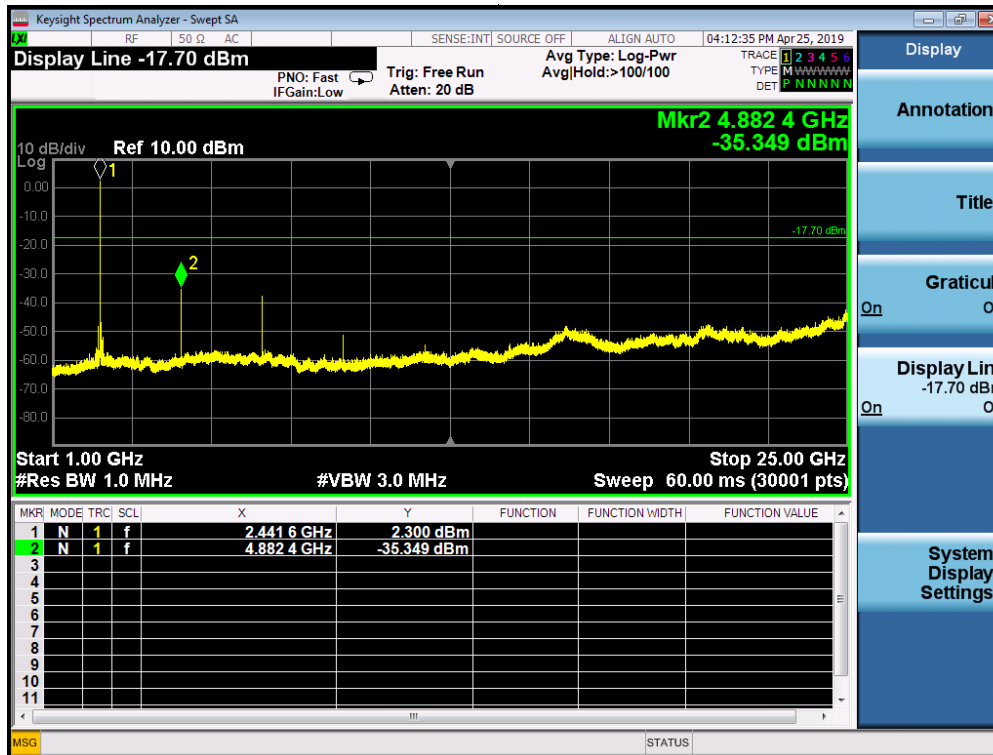
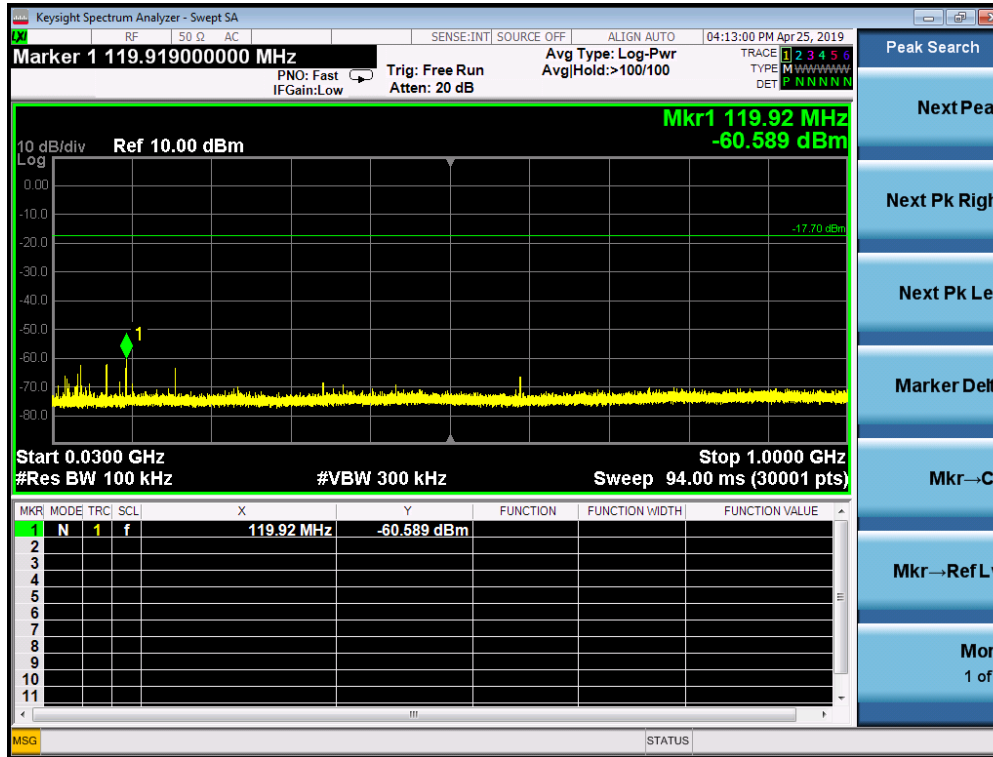

Highest Channel

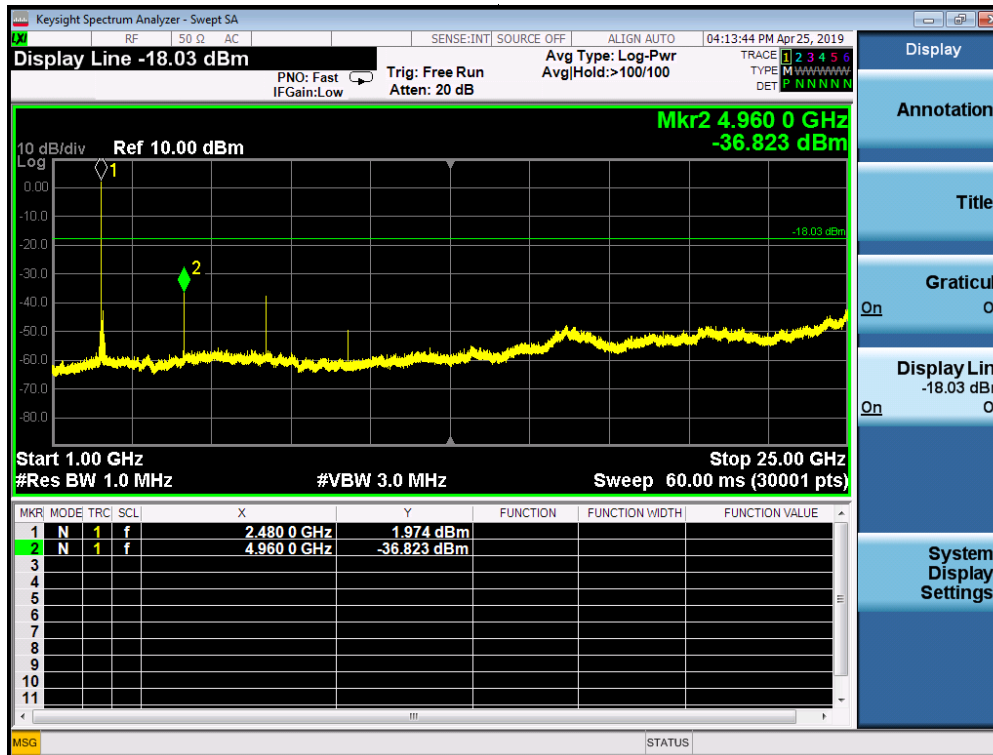
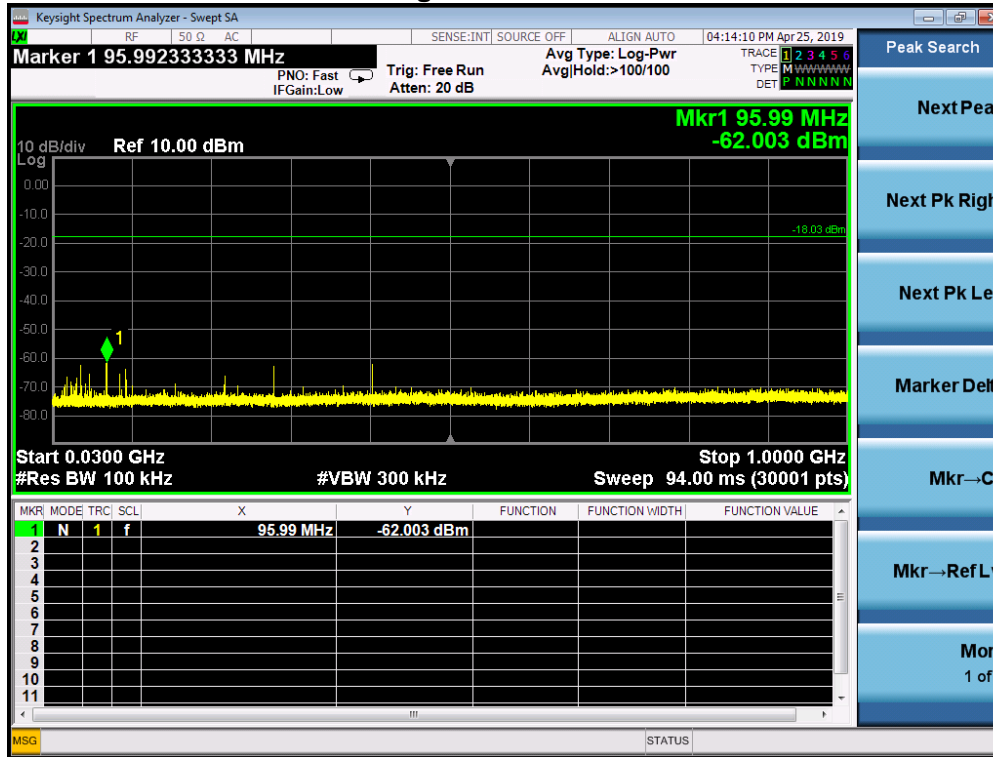

Note: Sweep points=30001pts

13. Test Equipment List

Equipment	Manufacturer	Model No.	Serial No.	Characteristics	Last Cal.	Cal. Interval
Test Receiver	Rohde & Schwarz	ESCI7	100837	9KHz~7GHz	Mar. 13, 2019	1 Year
Antenna	Schwarzbeck	VULB9162	9162-010	30MHz~7GHz	Mar. 22, 2019	1 Year
Spectrum Analyzer	Rohde & Schwarz	FSU26	200409/026	20Hz~26.5GHz	Mar. 13, 2019	1 Year
Spectrum Analyzer	Keysight	N9020A	MY54200831	20Hz~26.5GHz	Apr. 23, 2019	1 Year
Horn Antenna	Schwarzbeck	BBHA9170	9170-372	15GHz~40GHz	Mar. 22, 2019	1 Year
Pre-Amplifier	EMCI	EMC 184045	980102	18GHz~40GHz	Apr. 23, 2019	1 Year
Power Sensor	DARE	RPR3006W	15I00041SNO 64	100MHz~6GHz	Mar. 13, 2019	1 Year
Horn Antenna	COM-Power	AH-118	071078	500MHz~18GHz	Mar. 22, 2019	1 Year
Pre-Amplifier	HP	HP 8449B	3008A00964	1GHz~26.5GHz	Mar. 13, 2019	1 Year
Pre-Amplifier	HP	HP 8447D	1145A00203	100KHz~1.3GHz	Mar. 13, 2019	1 Year
Loop Antenna	Schwarzbeck	FMZB 1513	1513-272	9KHz~30MHz	Apr. 23, 2019	1 Year
Temperature & Humidity Chamber	REMAFEE	SYHR225L	N/A	-40~150°C	Apr. 23, 2019	1 Year
DC Source	MY	MY8811	N/A	0~30V	Mar. 22, 2019	1 Year
Temporary antenna connector	TESCOM	SS402	N/A	9KHz~25GHz	N/A	1 Year
Test Receiver	Rohde & Schwarz	ESCI	101152	9KHz~3GHz	Mar. 13, 2019	1 Year
L.I.S.N	Rohde & Schwarz	ENV 216	101317	N/A	Mar. 13, 2019	1 Year
L.I.S.N	Schwarzbeck	NNLK8129	8129212	N/A	Mar. 06, 2019	1 Year
RF Switching Unit	Compliance Direction Systems Inc.	RSU-M2	38311	N/A	Mar. 13, 2019	1 Year
Test Software	EZ	EZ_EMCC	N/A	N/A	N/A	1 Year

Note: The temporary antenna connector is soldered on the PCB board in order to perform conducted tests and this temporary antenna connector is listed in the equipment list.

---End---