

# 承认书

## SPECIFICATION FOR APPROVAL

(Version: A01)

客户名称

CUSTOMER NAME: 东莞精恒电子有限公司 Dongguan Jingheng Electronics Co., Ltd

产品名称

PRODUCT NAME: 1.9G天线 (1.9G antenna)

产品型号

PRODUCT MODEL: TLB-1900-JWY120

客户料号

CUSTOMER P/N: HF00160

康捷料号

KTECH P/N:

版本日期

VERSION DATE: 2023/12/14

CUSTOMER			
QA CHECKED	ME CHECKED	RF CHECKED	MANAGER CHECKED

Sign (客户确认签字盖章): \_\_\_\_\_

SHENZHEN KTECH TELECOM TECH. CO., LTD			
LISTER	ME CHECKED	RF CHECKED	MANAGER CHECKED
	武 勇 Wu Yong	林建文 Lin Jianwen	



深圳市康捷通讯科技有限公司

SHENZHEN KTECH TELECOM TECH. CO., LTD

地址: 深圳市宝安区燕罗塘下涌雄宇路平泰昌科技园B栋2楼

电话: 0755-29835105 13352999996 传真: 0755-29835007

Http://www.ktech.net.cn

# 目 录

## Index

1. 封面 Cover.....	1
2. 目录 Index.....	2
3. 产品图面 Product Drawing.....	3
4. 产品实物图 Project Chart.....	4
5. 产品主要技术参数 Electrical Performance Index.....	5
6. 测试数据 Reliability test report.....	6-10
6.1 驻波图 Standing Wave Diagram.....	6
6.2 回损图 Return loss figure.....	7
6.3 暗室测试项目-增益、效率、方向图 Microwave Anechoic Chamber Test Project-Gain、Efficiency、Directions.....	8-9
6.4 测试环境及设备 Antenna test environment and equipment.....	10

### 3.产品图面

#### Project Chart

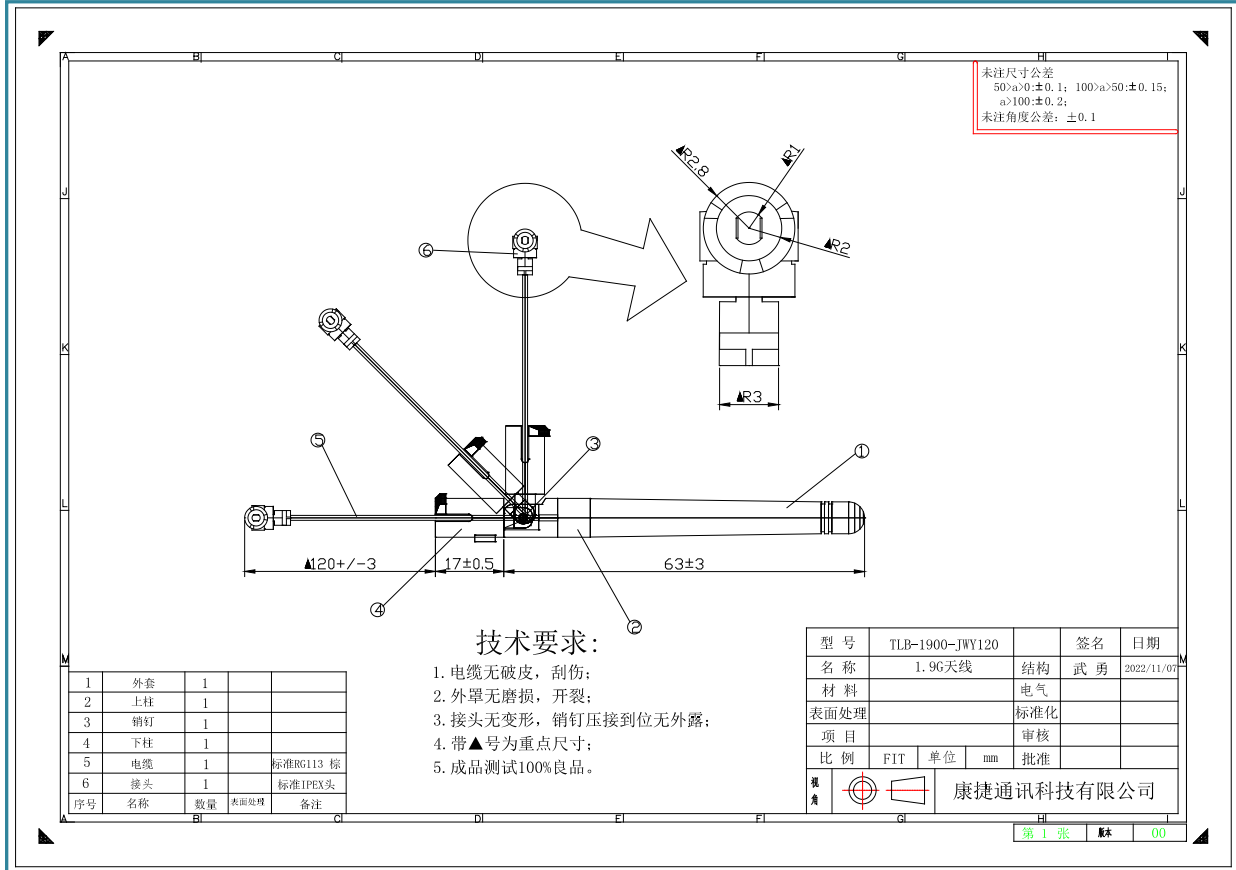

## 4. 产品实物图

Project Chart

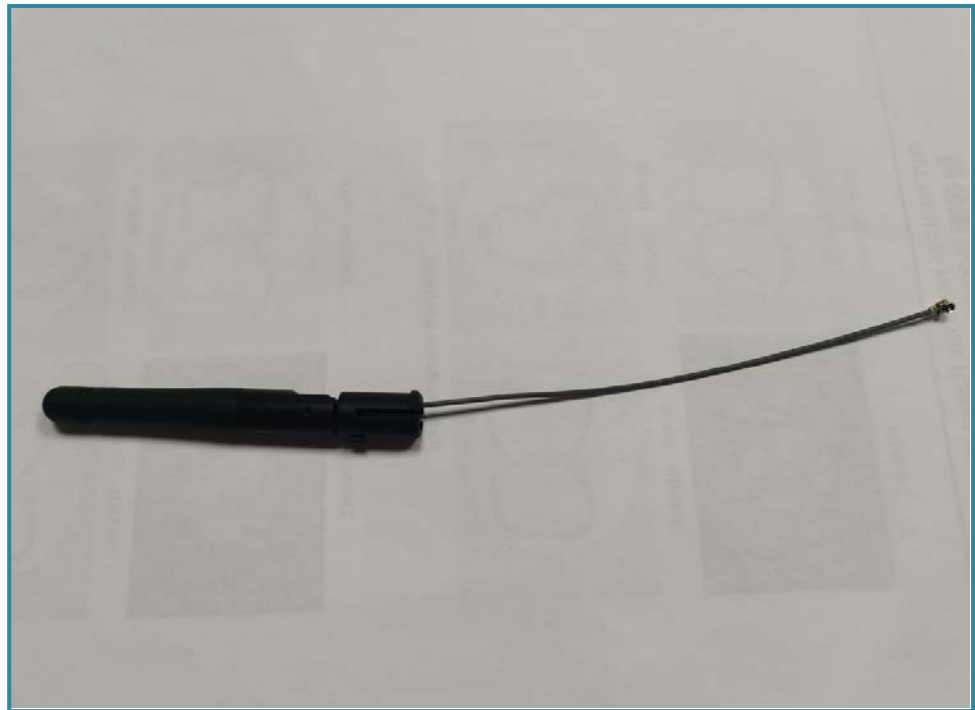
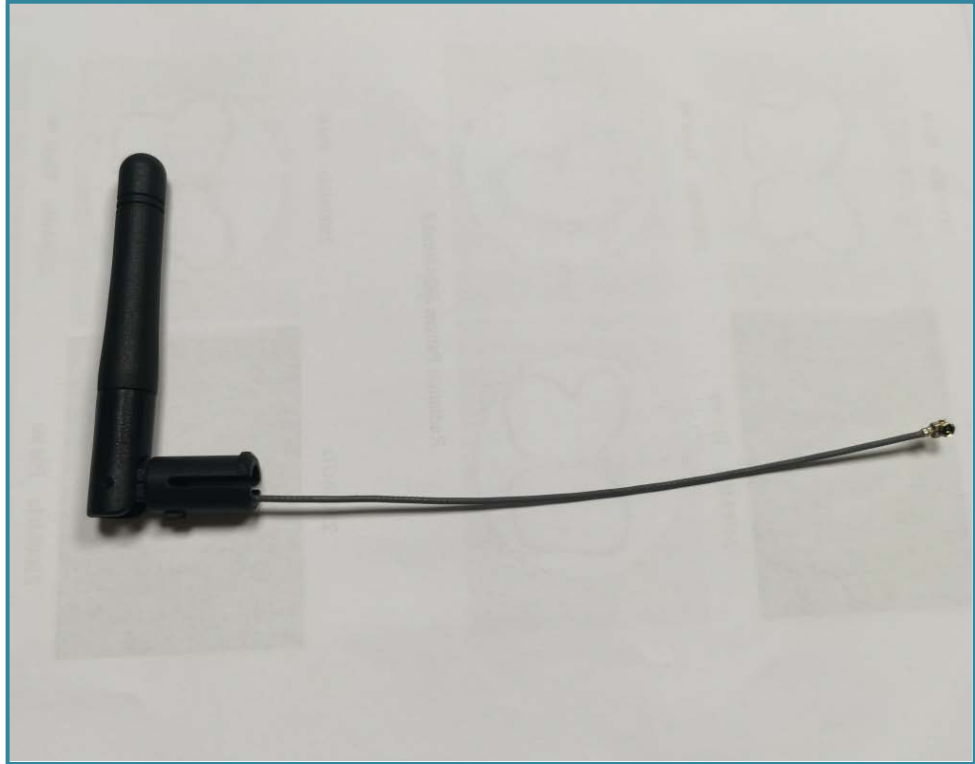

## 5. 产品主要技术参数

### Electrical Performance Index

型 号	TLB-1900-JWY120	Model	TLB-1900-JWY120
主要技术指标		Main Technical Specifications	
射频参数 RF parameters			
频率范围 (MHz)	1880-1930	Frequency Range (MHz)	1880-1930
频带宽度 (MHz)	50	Bandwidth (MHz)	50
电压驻波比	$\leq 2.5$	VSWR	$\leq 2.5$
增益 (dBi)	2	Gain (dBi)	2
最大功率 (W)	50	Max Input power (W)	50
输入阻抗 ( $\Omega$ )	50	Input Impedance ( $\Omega$ )	50
极化形式	垂直极化	Polarization	Vertical
机械参数 Mechanical parameters			
电缆长度 (mm)	120 $\pm$ 3	Length (mm)	120 $\pm$ 3
接口形式	IPEX	Connector Type	IPEX
环境参数 Environmental parameters			
工作温度	-30~60C°	Operation temperature	-30~60C°
储藏温度	-30~75C°	Store temperature	-30~75C°

## 6.测试数据

Reliability test report

### 6.1 驻波图

Standing Wave Diagram

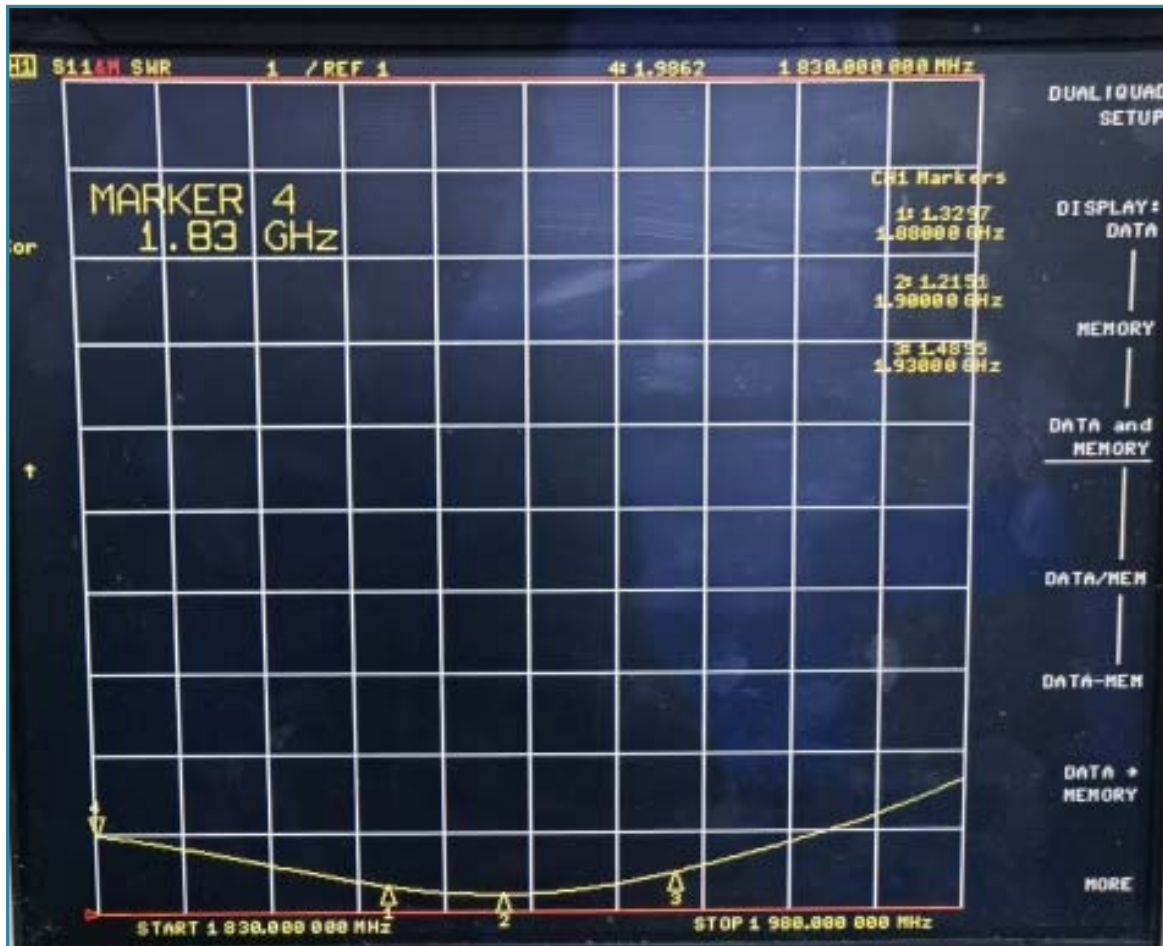

## 6.2 回损图

Return loss figure

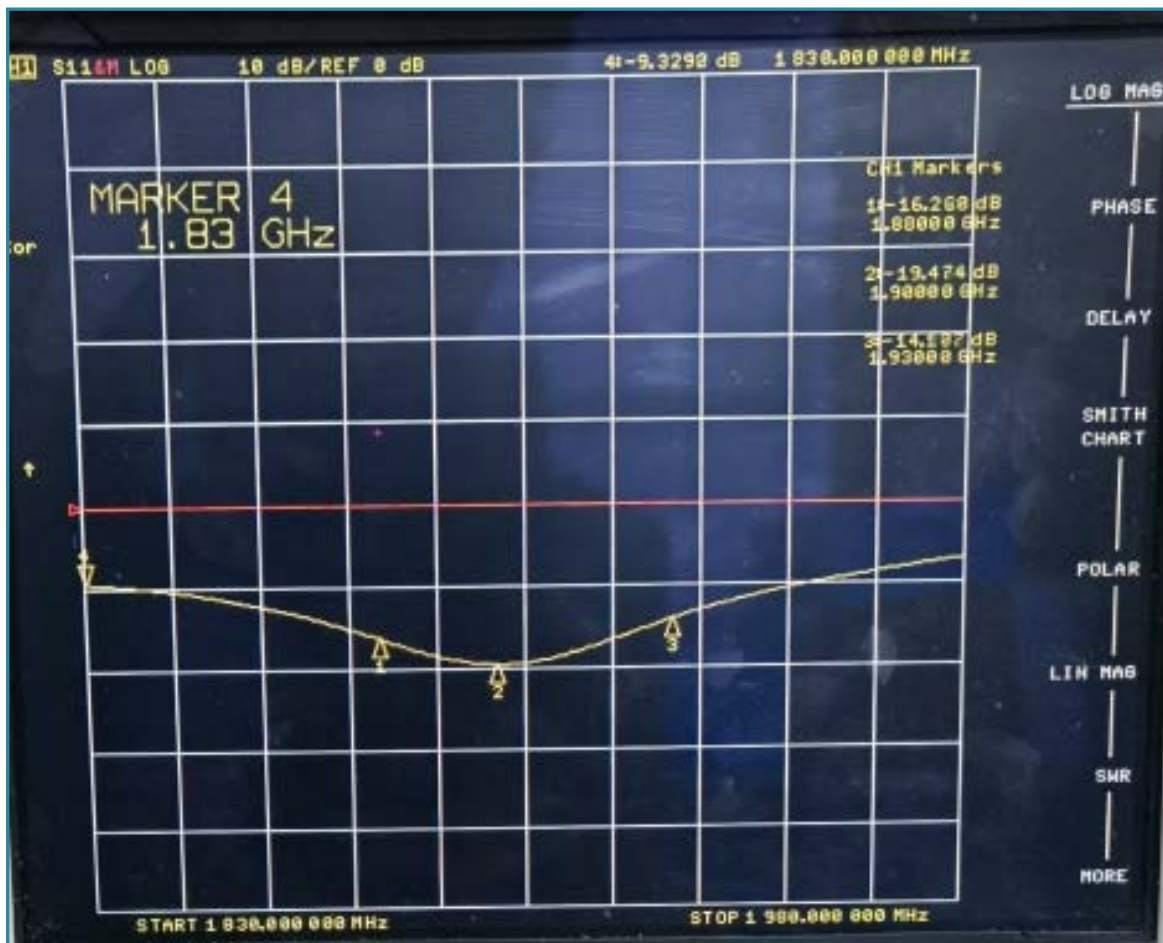

### 6.3 暗室测试项目-增益、效率、方向图

Microwave Anechoic Chamber Test Project-Gain、Efficiency、Directions

Frequency ( MHz )	Directivity ( dBi )	Efficiency ( dB )	Efficiency ( % )	Gain ( dB )
1880	6.21	-6.21	23.93	-0.87
1900	6.33	-6.28	23.55	-0.63
1930	6.45	-6.08	24.66	-0.32

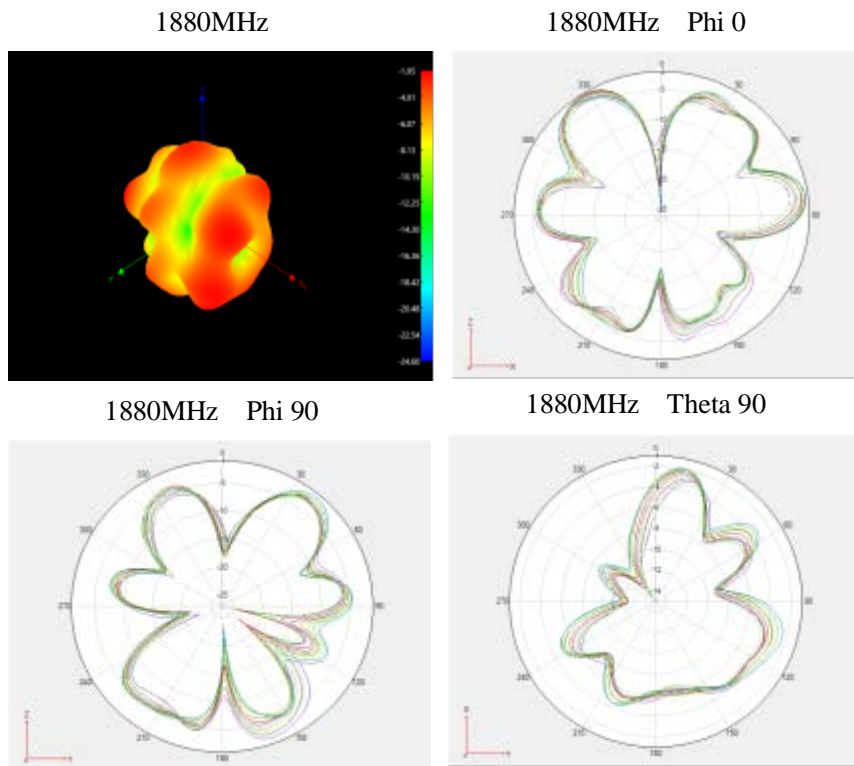

Radiation Pattern @1880mhZ



1900MHz

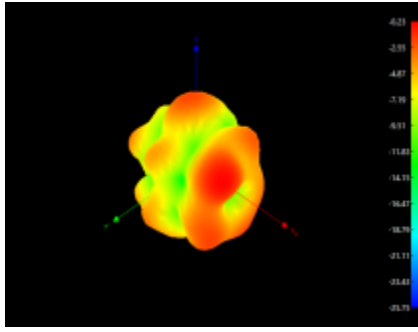

1900MHz Phi 0

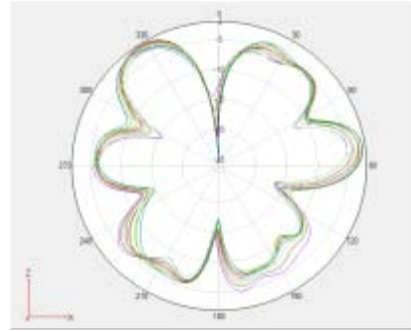

1900MHz Phi 90

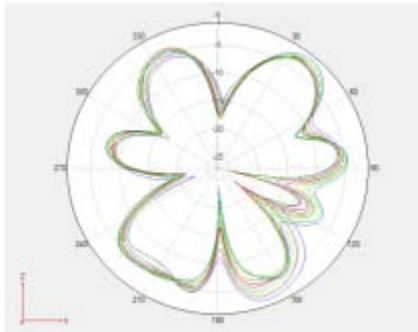

1900MHz Theta 90

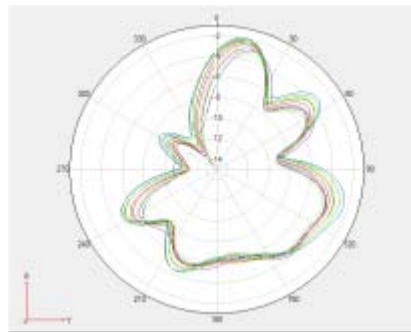

Radiation Pattern @1900mhz

1930MHz

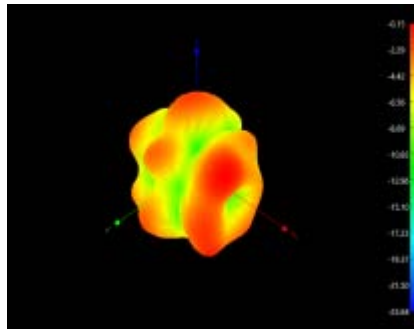

1930MHz Phi 0

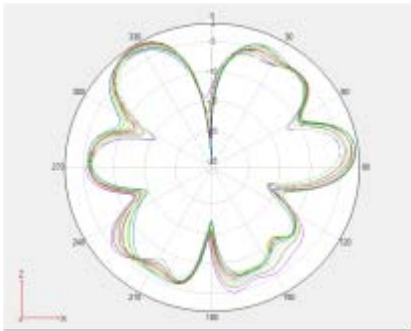

1930MHz Phi 90

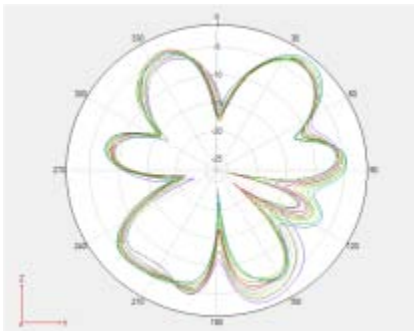

1930MHz Theta 90

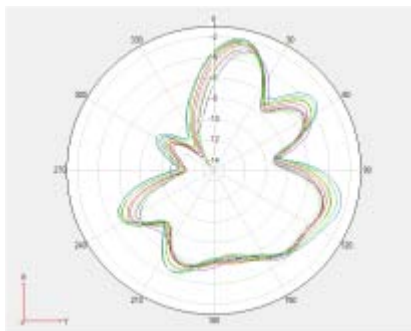

Radiation Pattern @1930mhz

## 6.4 天线测试环境及设备

### Antenna test environment and equipment

