

# Radio Test Report

Report No.: STS2308154W01

Issued for

Sam Ash Music Corporation

262 Duffy Avenue Hicksville New York United States 11801

Product Name: TRANSMITTER

Brand Name: SAMSON

Model Name: CHXD2

Series Model(s): N/A

FCC ID: CCRCHXD2

Test Standards: Title 47 of the CFR, Part 15 Subpart D

Any reproduction of this document must be done in full. No single part of this document may be reproduced without permission from STS, all test data presented in this report is only applicable to presented test sample.



TEST RESULT

Applicant's Name : Sam Ash Music Corporation
Address : 262 Duffy Avenue Hicksville New York United States 11801
Manufacturer's Name : Sam Ash Music Corporation
Address : 262 Duffy Avenue Hicksville New York United States 11801

Product Description

Product Name : TRANSMITTER
Brand Name : SAMSON
Model Name : CHXD2
Series Model : N/A

Test Standards : Title 47 of the CFR, Part 15. Subpart D
Test procedure : ANSI C63.17-2013

This device described above has been tested by STS and the test results show that the equipment under test (EUT) is in compliance with the FCC requirements. And it is applicable only to the tested sample identified in the report.

This report shall not be reproduced except in full, without the written approval of STS, this document only be altered or revised by STS, personal only, and shall be noted in the revision of the document.

Date of Test :
Date of receipt of test item : 28 Aug. 2023
Date of performance of tests : 28 Aug. 2023 ~ 26 Sept. 2023
Date of Issue : 26 Sept. 2023
Test Result : Pass

Testing Engineer : [Signature]
(Lenon Hou)

Technical Manager : [Signature]
(Sean she)

Authorized Signatory : [Signature]
(Chris Chen)





<b>TABLE OF CONTENTS</b>	<b>Page</b>
<b>1 INTRODUCTION</b>	<b>7</b>
1.1 TEST FACTORY	7
1.2 MEASUREMENT UNCERTAINTY	7
<b>2 PRODUCT INFORMATION</b>	<b>8</b>
<b>3 TEST CONFIGURATION OF EQUIPMENT UNDER TEST</b>	<b>9</b>
3.1 DESCRIPTION OF NECESSARY ACCESSORIES AND SUPPORT UNITS	9
3.2 SYSTEM TEST CONFIGURATION	10
<b>4 MEASUREMENT INSTRUMENTS</b>	<b>11</b>
<b>5 TEST ITEMS</b>	<b>12</b>
5.1 ANTENNA REQUIREMENT	12
5.2 MODULATION TECHNIQUES	12
5.3 EMISSION BANDWIDTH	13
5.4 PEAK TRANSMIT POWER	18
5.5 POWER SPECTRAL DENSITY	23
5.6 POWER ADJUSTMENT FOR ANTENNA GAIN	28
5.7 AUTOMATICALLY DISCONTINUE TRANSMISSION	29
5.8 SYSTEM ACKNOWLEDGE-MENT TEST	30
5.9 MONITORING THRESHOLD	31
5.10 DURATION OF TRANSMISSION	32
5.11 SELECTED CHANNEL CONFIRMATION, POWER ACCURACY, SEGMENT OCCUPANCY	34
5.12 RANDOM WAITING	36
5.13 MONITORING REQUIREMENTS	37
5.14 MONITORING ANTENNA	38
5.15 DUPLEX CONNECTIONS	38
5.16 ALTERNATIVE MONITORING INTERVAL FOR CO-LOCATED DEVICES	39
5.17 FAIR ACCESS	39
5.18 SPURIOUS EMISSIONS	40
5.19 FRAME PERIOD	56
5.20 FREQUENCY STABILITY	57
5.21 CONDUCTED EMISSION MEASUREMENT	61
5.22 RADIATED SPURIOUS EMISSION	63



**Revision History**

Rev.	Issue Date	Report No.	Effect Page	Contents
00	26 Sept. 2023	STS2308154W01	ALL	Initial Issue



## SUMMARY OF TEST RESULTS

Test procedures according to the technical standards:

The following tests were conducted on a sample of the equipment for the purpose of demonstrating compliance with Part 15 Subpart D.

Requirement	FCC Part	Test Procedure	Result
Emission Bandwidth	15.323 (a)	6.1.3	Compliant
Labeling Requirements	15.19(a)(3)	--	Compliant
Conducted Emissions	15.315 & 15.207	ANSI C63.4	Not Applicable
Antenna Requirements	15.317 & 15.203	Declaration	Compliant
Use digital modulation	15.319 (b)	6.1.4	Compliant
Peak transmit power	15.319 (c)	6.1.2	Compliant
Power spectral density	15.319 (d)	6.1.5	Compliant
Power adjustment for antenna gain	15.319 (e)	4.3.1	Compliant
Automatically discontinue transmission	15.319 (f)	--	Compliant
Spurious emissions conducted	15.323 (d) (1) & 15.323 (d) (2)	6.1.6	Compliant
RF Exposure	15.319 (i) & 1.1307(b), 2.1091 and 2.1093	ANSI/IEEE C95.1	Compliant (The test data please refer to RF exposure report)
Monitoring time	15.323 (c)(1)	7.3.4	Compliant
Monitoring threshold	15.323 (c)(2)	7.3	Compliant
Duration of transmission	15.323 (c)(3)	8.2.2	Not Applicable
System acknowledgment test	15.323(c)(4)	8.2.1	Compliant
Channel confirmation, Power accuracy, Segment occupancy	15.323 (c)(5)	7.3.3 & 7.3.4	Compliant
Random waiting	15.323 (c)(6)	8.1.3	Not Applicable
Monitoring bandwidth	15.323 (c)(7)	7.4	Compliant



Monitoring reaction time	15.323 (c)(1 )	7.5	Compliant
Monitoring antenna	15.323 (c)(8)	4	Compliant
Monitoring threshold relaxation	15.323 (c)(9)	4	Compliant
Duplex connections	15.323 (c)(10)	8.3	Not Applicable
Alternate monitoring interval	15.323 (c)(11)	8.4	Not Applicable
Fair access	15.323 (c)(12)	Declaration	Not Applicable
Frame period	15.323 (e)	6.2.2 & 6.2.3	Compliant
Frequency stability	15.323 (f)	6.2.1	Compliant
Radiated Out of Band Emissions	15.319 (g), 15.309 (b) & FCC Part 15 Subpart B, 15.109 and 15.209	--	Compliant



## 1 INTRODUCTION

### 1.1 TEST FACTORY

SHENZHEN STS TEST SERVICES CO., LTD

Add. : 101, Building B, Zhuoke Science Park, No.190 Chongqing Road, ZhanChengShequ, Fuhai Sub-District, Bao'an District, Shenzhen, Guang Dong, China

FCC test Firm Registration Number: 625569

IC test Firm Registration Number: 12108A

A2LA Certificate No.: 4338.01

### 1.2 MEASUREMENT UNCERTAINTY

The reported uncertainty of measurement  $y \pm U$ , where expanded uncertainty  $U$  is based on a standard uncertainty multiplied by a coverage factor of  $k=2$ , providing a level of confidence of approximately 95 %.

No.	Item	Uncertainty
1	RF output power, conducted	$\pm 1.197\text{dB}$
2	Unwanted Emissions, conducted	$\pm 2.986\text{dB}$
3	All emissions, radiated 30-1GHz	$\pm 3.94\text{dB}$
4	All emissions, radiated 1G-6GHz	$\pm 4.59\text{dB}$
5	All emissions, radiated >6G	$\pm 5.22\text{dB}$
6	Conducted Emission (9KHz-150KHz)	$\pm 2.14\text{dB}$
7	Conducted Emission (150KHz-30MHz)	$\pm 2.54\text{dB}$



## 2 PRODUCT INFORMATION

Product Name/PMN	TRANSMITTER
Brand Name	SAMSON
Model Name/HVIN	CHXD2
Series Model	N/A
Product Differences	N/A
Hardware version number	1.0
Software version /FVIN	1.0
EUT Frequency Ranges	1921.536-1928.448MHz
Type of Modulations	GFSK
Packet type	PP32Z
Number of Channels	5 CH. Please see Note 2.
Antenna Type	Ant 1: Monopole Ant 2: PCB
Antenna Gain	Ant 1: 0dBi Ant 2: 0dBi
Rating	Input: 2X1.5VAA Battery(not included)
Extreme Temp. Tolerance:	0°C to 45°C

Note: 1. Antenna 1 and Antenna 2 cannot transmit simultaneously.

2. Channel list:

Channel	Frequency (MHz)	Channel	Frequency (MHz)	Channel	Frequency (MHz)
04	1921.536	03	1923.264	02	1924.992
01	1926.720	00	1928.448	--	--





### 3 TEST CONFIGURATION OF EQUIPMENT UNDER TEST

#### 3.1 DESCRIPTION OF NECESSARY ACCESSORIES AND SUPPORT UNITS

The EUT has been tested as an independent unit together with other necessary accessories or support units. The following support units or accessories were used to form a representative test configuration during the tests.

##### Necessary accessories

Item	Equipment	Mfr/Brand	Model/Type No.	Length	Note
N/A	N/A	N/A	N/A	N/A	N/A

##### Support units

Item	Equipment	Mfr/Brand	Model/Type No.	Length	Note
N/A	N/A	N/A	N/A	N/A	N/A

**Note:**

- (1) For detachable type I/O cable should be specified the length in cm in 『Length』 column.

### 3.2 SYSTEM TEST CONFIGURATION

Figure 1:



Figure 2:

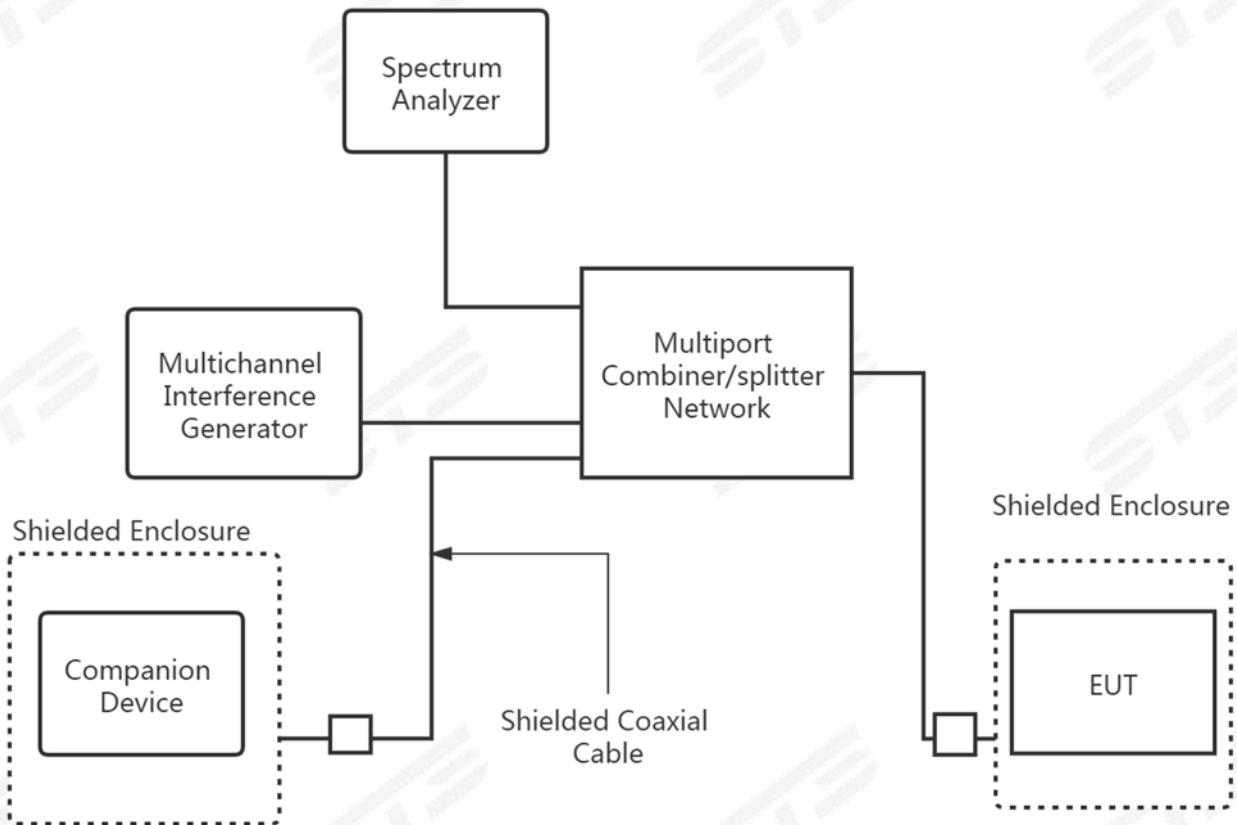



## 4 MEASUREMENT INSTRUMENTS

RF Radiation Test Equipment					
Kind of Equipment	Manufacturer	Type No.	Serial No.	Last Calibration	Calibrated Until
Temperature & Humidity	SW-108	SuWei	N/A	2023.03.03	2024.03.02
Wireless Communications Test Set	R&S	CMW 500	117239	2023.03.01	2024.02.29
Pre-Amplifier(0.1M-3GHz)	EM	EM330	060665	2023.02.28	2024.02.27
Pre-Amplifier (1G-18GHz)	SKET	LNPA-01018G-45	SK2018080901	2022.09.29	2023.09.28
Positioning Controller	MF	MF-7802	MF-780208587	N/A	N/A
Signal Analyzer	R&S	FSV 40-N	101823	2022.09.29	2023.09.28
Switch Control Box	N/A	N/A	N/A	N/A	N/A
Filter Box	BALUN Technology	SU319E	BL-SZ1530051	N/A	N/A
Video Controller	SKET	FCS C-3	N/A	N/A	N/A
Bilog Antenna	TESEQ	CBL6111D	34678	2022.09.30	2024.09.29
Horn Antenna	SCHWARZ-BECK	BBHA 9120D	02014	2021.10.11	2023.10.10
Antenna Mast	MF	MFA-440H	N/A	N/A	N/A
Turn Table	MF	N/A	N/A	N/A	N/A
AC Power Source	APC	KDF-11010G	F214050035	N/A	N/A
DC Power Supply	Zhaoxin	RXN 605D	20R605D11010081	N/A	N/A
Test SW	EMC Test Software	15.2.0.339			
Conduction Test equipment					
Kind of Equipment	Manufacturer	Type No.	Serial No.	Last calibration	Calibrated until
Test Receiver	R&S	ESCI	101427	2022.09.29	2023.09.28
LISN	R&S	ENV216	101242	2022.09.28	2023.09.27
LISN	EMCO	3810/2NM	23625	2022.09.28	2023.09.27
Temperature & Humidity	HH660	Mieo	N/A	2022.09.30	2023.09.29
RF Connected Test Equipment					
Kind of Equipment	Manufacturer	Type No.	Serial No.	Last Calibration	Calibrated Until
Temperature & Humidity	SW-108	SuWei	N/A	2023.03.03	2024.03.02
RF Test Platform For DECT	RTX	RTX 2012 HS	1138-6122	2023.03.08	2024.03.07
Signal Generator	Agilent	N5182A	MY46240556	2022.09.28	2023.09.27
Signal Analyzer	Agilent	N9020A	MY52440124	2023.03.01	2024.02.29
Temperature & Humidity Test Chamber	Safety test	AG80L	171200018	2023.03.01	2024.02.29
Programmable Power Supply	Agilent	E3642A	MY40002025	2022.09.29	2023.09.28
Attenuator	HP	8494B	DC-18G	2023.03.02	2024.03.01
AC Power Source	APC	KDF-11010G	F214050035	N/A	N/A
Test SW	RTX2012	RTX20xx v0.9.61 A			

Equipment with a calibration date of "NCR" shown in this list was not used to make direct calibrated measurements.

## 5 TEST ITEMS

### 5.1 ANTENNA REQUIREMENT

#### TEST OVERVIEW

§ 15.203: An intentional radiator shall be designed to ensure that no antenna other than that furnished by the responsible party shall be used with the device. The use of a permanently attached antenna or of an antenna that uses a unique coupling to the intentional radiator shall be considered sufficient to comply with the provisions of this section. The manufacturer may design the unit so that a broken antenna can be replaced by the user, but the use of a standard antenna jack or electrical connector is prohibited.

The structure and application of the EUT were analyzed to determine compliance with Section 15.203 of the Rules. Section 15.203 states that the subject device must meet at least one of the following criteria:

- a.) Antenna must be permanently attached to the unit.
- b.) Antenna must use a unique type of connector to attach to the EUT.
- c.) Unit must be professionally installed. Installer shall be responsible for verifying that the correct antenna is employed with the unit.

#### TEST RESULT

The EUT as tested is compliant the criteria of §15.203. The antenna is permanently attached to the unit.

### 5.2 MODULATION TECHNIQUES

#### TEST REQUIREMENT

All transmissions must use only digital modulation techniques.

#### TEST PROCEDURES

Attestation of manufacturer supported by reference to relevant DECT specifications.

#### ATTESTATION

This device is compliant with the DECT standards described in European Standards EN 300 175-2 and EN 300 175-3. DECT transmissions are MC/TDMA/TDD (Multi carrier / Time Division Multiple Access / Time Division Duplex) using Digital GFSK modulation. For further details see operational description or relevant portions of the DECT standards.

#### TEST RESULTS

The EUT as tested is compliant the criteria of §15.319(b).



### 5.3 EMISSION BANDWIDTH

#### TEST OVERVIEW

§ 15.323(a): For purposes of this subpart the emission bandwidth shall be determined by measuring the width of the signal between two points, one below the carrier center frequency and one above the carrier center frequency, that are 26 dB down relative to the maximum level of the modulated carrier. Compliance with the emissions limits is based on the use of measurement instrumentation employing a peak detector function with an instrument resolutions bandwidth approximately equal to 1.0 percent of the emission bandwidth of the device under measurement.

#### TEST PROCEDURE

Operation shall be contained within the 1920-1930 MHz band. The emission bandwidth shall be less than 2.5 MHz. The power level shall be as specified in §15.319(c), but in no event shall the emission bandwidth be less than 50 kHz.

#### TEST SETUP

The test setup is shown in section 3.2 figure 1.

#### TEST RESULTS

The Eut was compliant with this requirement.

Antenna 1

Channel	Left frequency	Right frequency	26dB BW(MHz)	Limit
Low	1920.906	1922.141	1.235	50KHz~2.5MHz
Mid	1924.357	1925.592	1.235	
High	1927.813	1929.053	1.240	
AVG	\	\	1.237	

Antenna 2

Channel	Left frequency	Right frequency	26dB BW(MHz)	Limit
Low	1920.891	1922.141	1.25	50KHz~2.5MHz
Mid	1924.362	1925.597	1.235	
High	1927.818	1929.053	1.235	
AVG	\	\	1.240	









Antenna 2

Plot 1. Emission Bandwidth, Channel 4 @ 1921.536 MHz

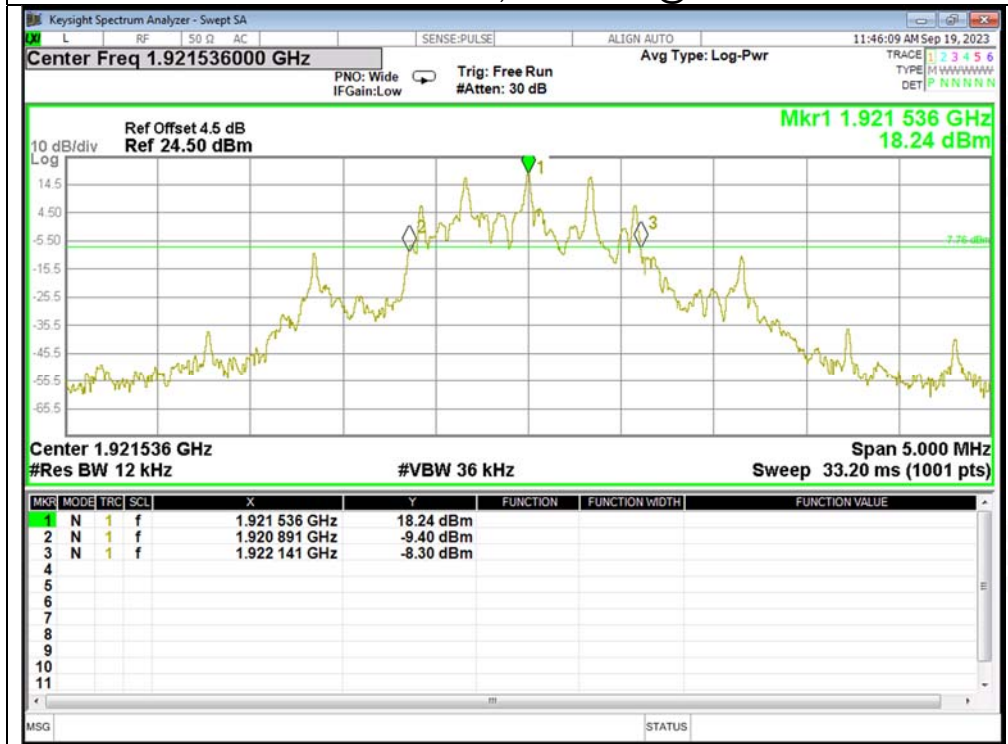

Plot 2. Emission Bandwidth, Channel 2 @ 1924.992 MHz

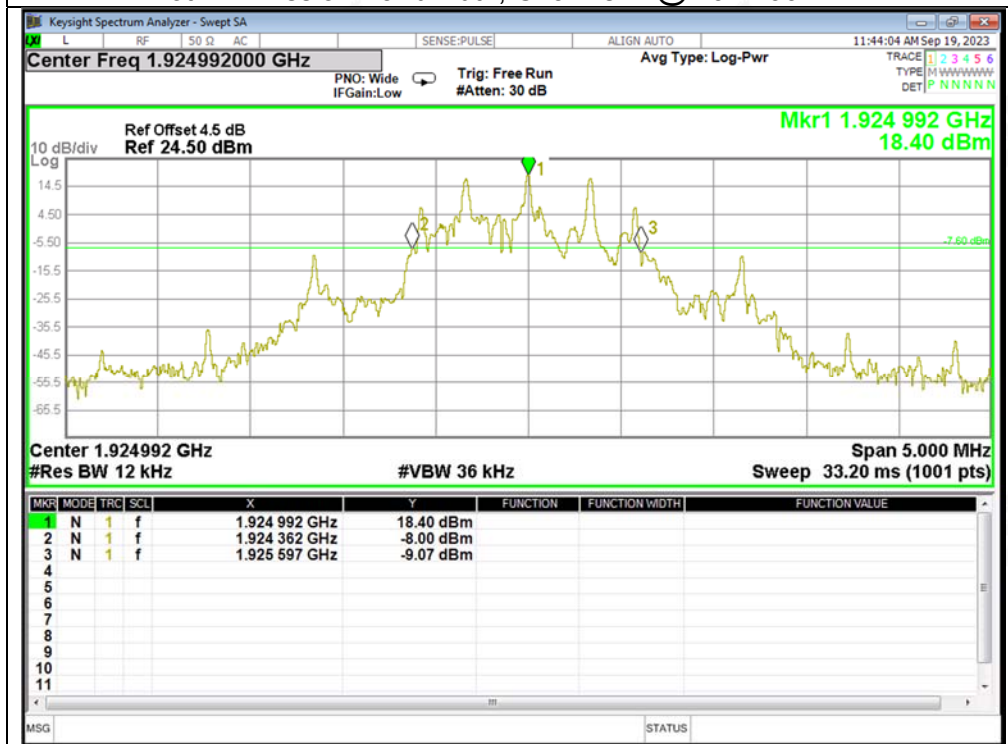







## 5.4 PEAK TRANSMIT POWER

### TEST OVERVIEW

§15.319(c)&RSS 213(5.6): The peak transmit power shall not exceed 100 microwatts multiplied by the square root of the emission bandwidth in hertz. Peak transmit power must be measured over any interval of continuous transmission using instrumentation calibrated in terms of an rms equivalent voltage. The measurement results shall be properly adjusted for any instrument limitations, such as detector response times, limited resolution bandwidth capability when compared to the emission bandwidth, sensitivity, etc., so as to obtain a true peak measurement for the emission in question over the full bandwidth of the channel.

### TEST PROCEDURE

Testing to ANSI C63.17-2013 Clause 6.1.2, which provides the test methodology for this provision. The EUT is controlled from a personal computer and set into continuous transmission mode.

### TEST SETUP

The test setup is shown in section 3.2 figure 1.

### TEST RESULTS

Antenna 1

Carrier Channel	Frequency (MHz)	Measured Peak Output Power (dBm)	Limit(uw)	Limit(dBm)
Low	1921.536	15.99	111131	20.46
Mid	1924.992	15.86	111131	20.46
High	1928.448	15.83	111355	20.47
EBWLow Channel=	1235000			Hz
EBWMid Channel=	1235000			Hz
EBWHigh Channel=	1240000			Hz
Note:Peak Transmitter Power Limit=100(EBW) <sup>1/2</sup> μW				

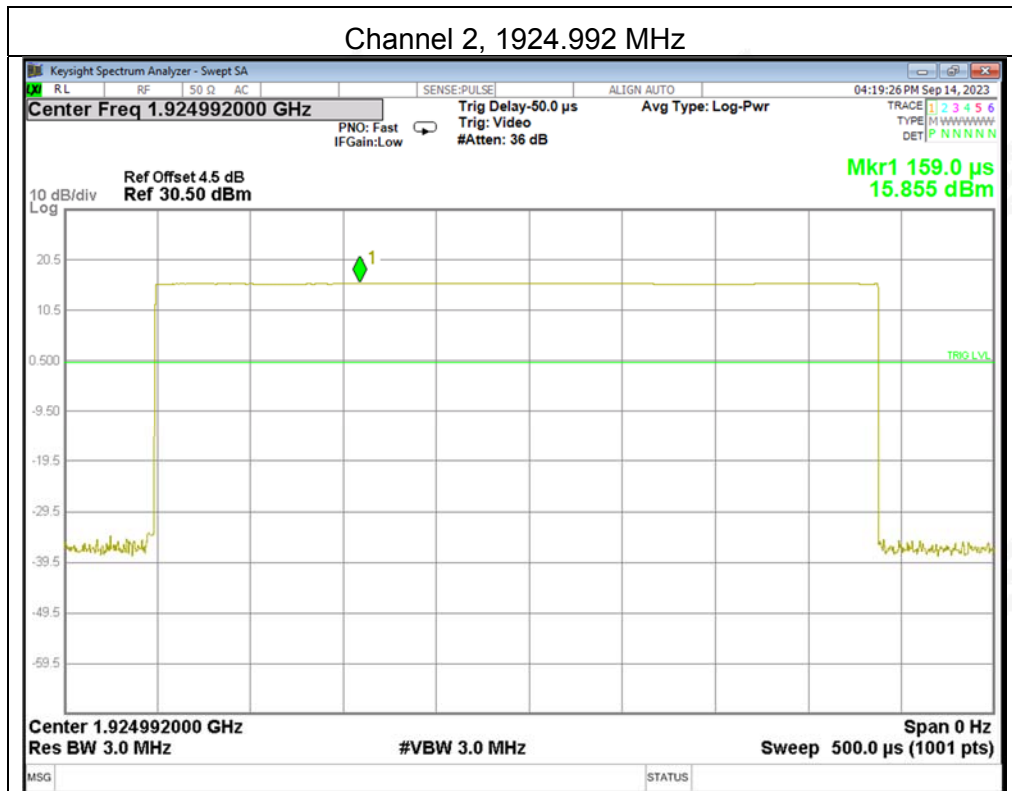
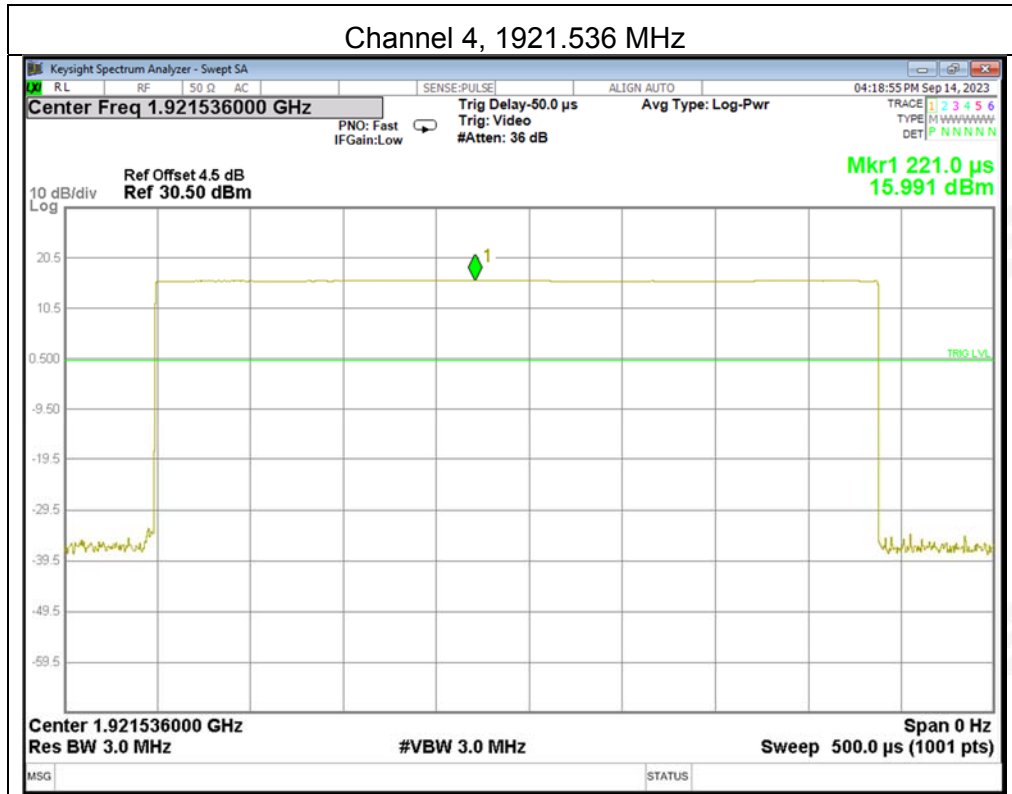

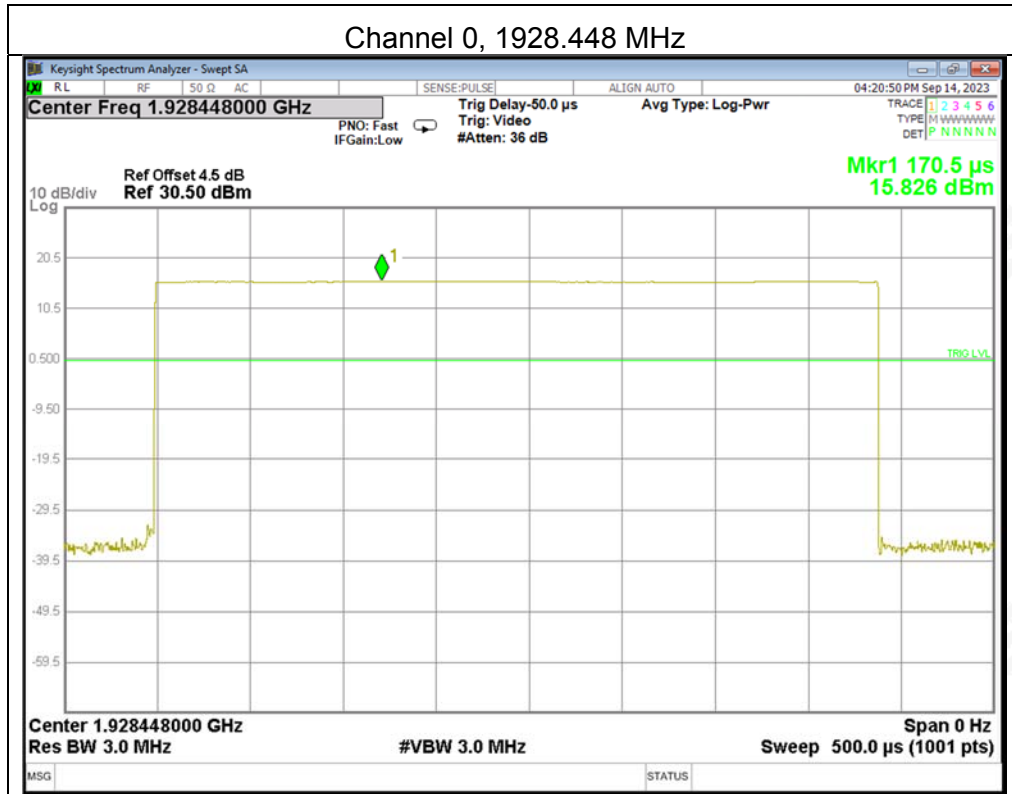



Antenna 2

Carrier Channel	Frequency (MHz)	Measured Peak Output Power (dBm)	Limit(uw)	Limit(dBm)
Low	1921.536	18.53	111803	20.48
Mid	1924.992	17.67	111131	20.46
High	1928.448	18.81	111131	20.46
EBWLow Channel=	1250000			Hz
EBWMid Channel=	1235000			Hz
EBWHigh Channel=	1235000			Hz

Note:Peak Transmitter Power Limit=100(EBW)1/2μW

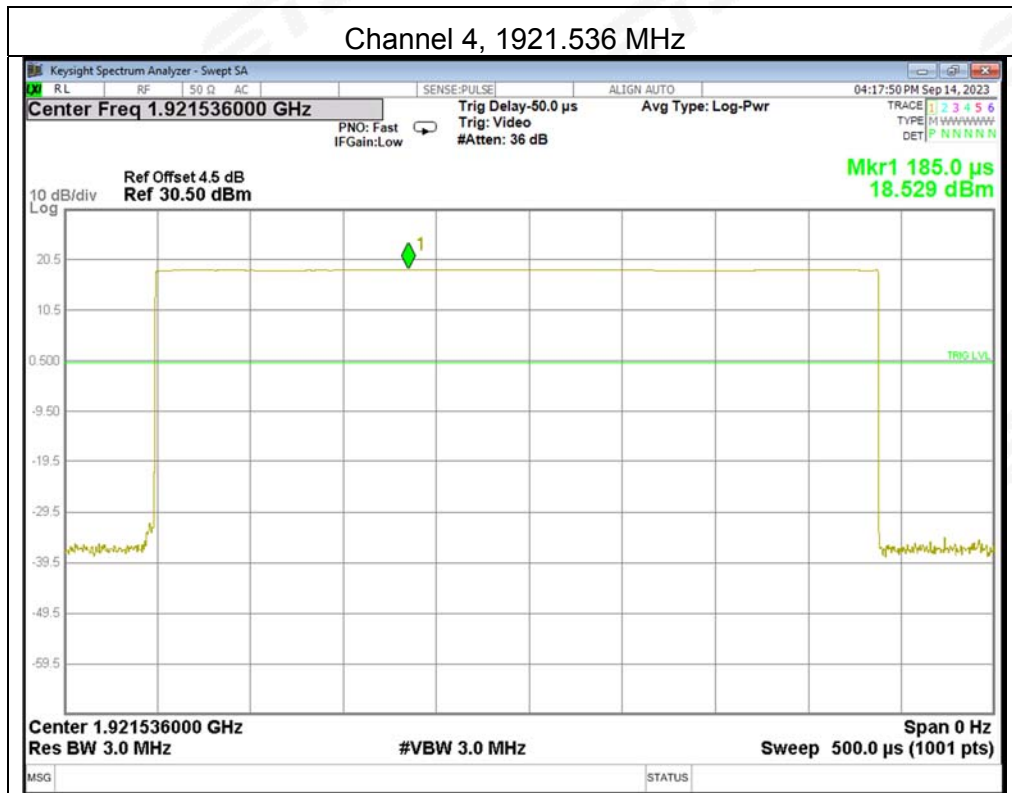

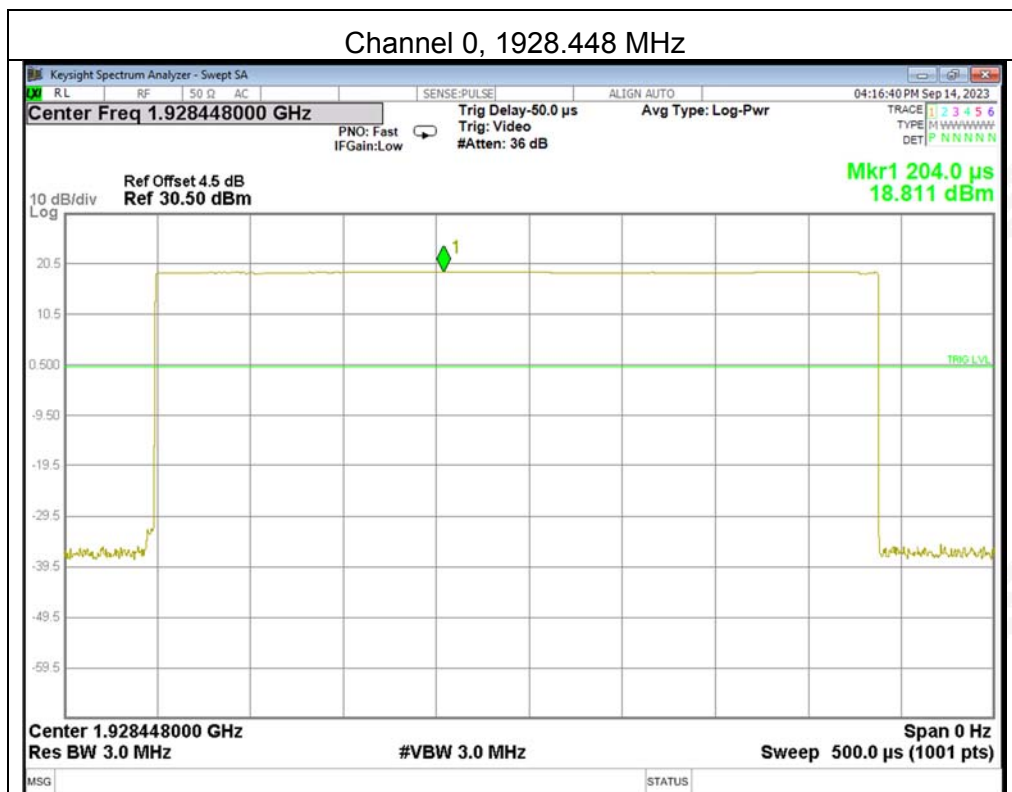
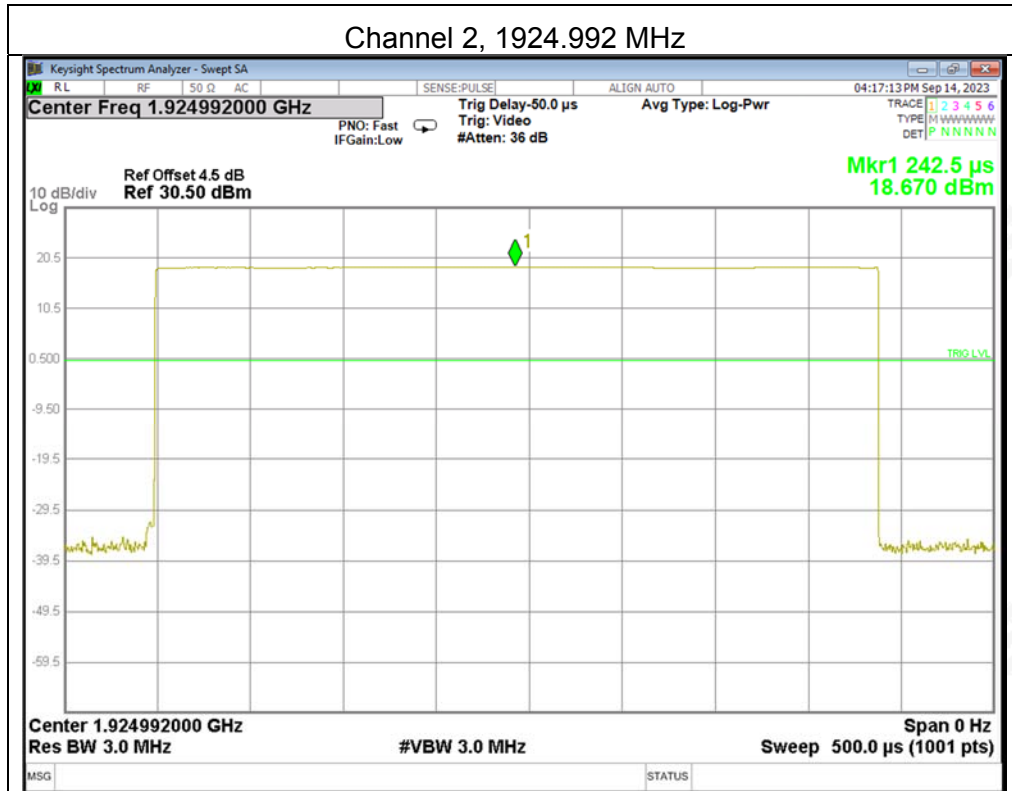



## 5.5 POWER SPECTRAL DENSITY

### TEST OVERVIEW

§15.319(d): Power spectral density shall not exceed 3 milliwatts in any 3 kHz bandwidth as measured with a spectrum analyzer having a resolution bandwidth of 3 kHz.

### TEST PROCEDURE

Testing to ANSI C63.17-2013 Clause 6.1.5, which provides the test methodology for this provision.

### TEST SETUP

The test setup is shown in section 3.2 figure 1.

### TEST RESULTS

Antenna 1				
Carrier Channel	Frequency (MHz)	Measured Peak Power Spectral Density (dBm)	Limit(mw)	Limit(dBm)
Low	1921.536	-7.12	3	4.77
Mid	1924.992	-6.94		
High	1928.448	-6.76		

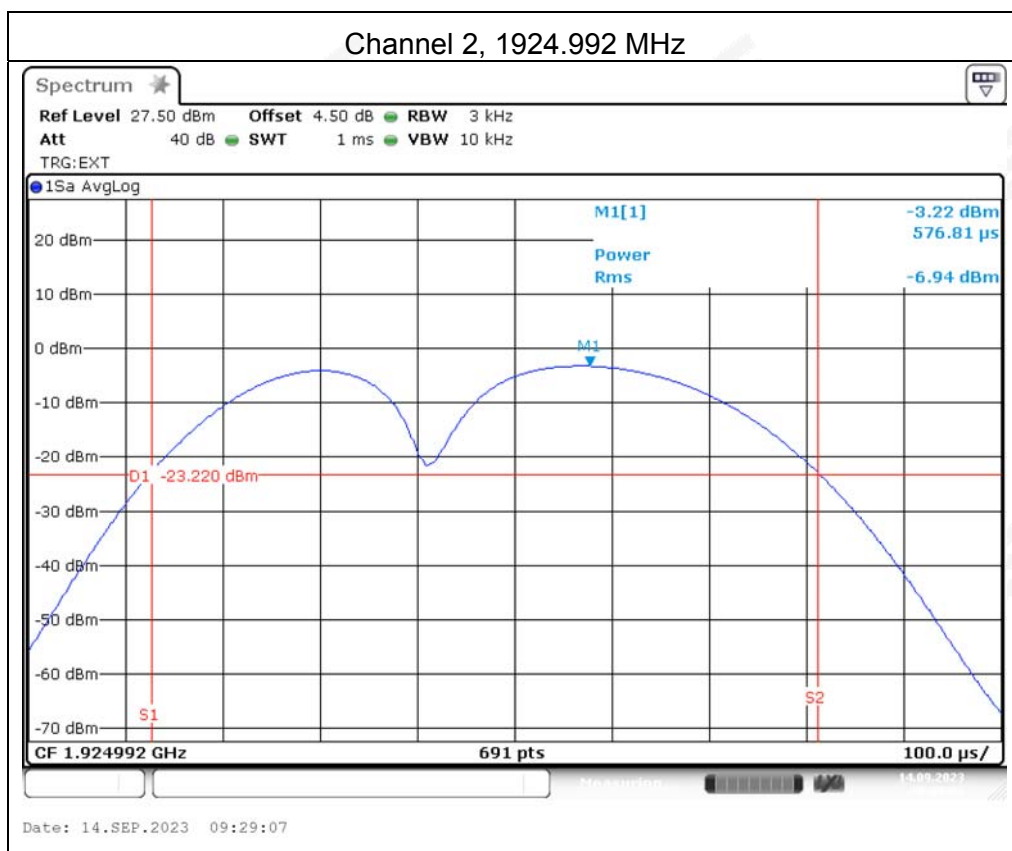
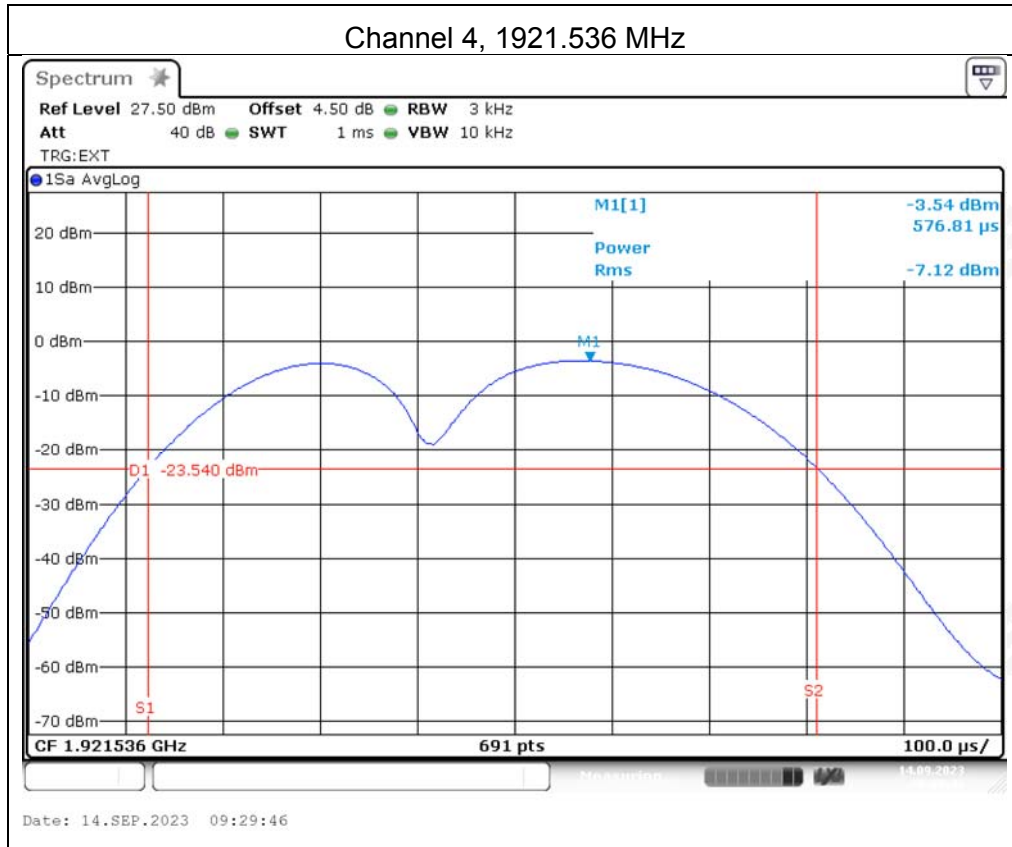



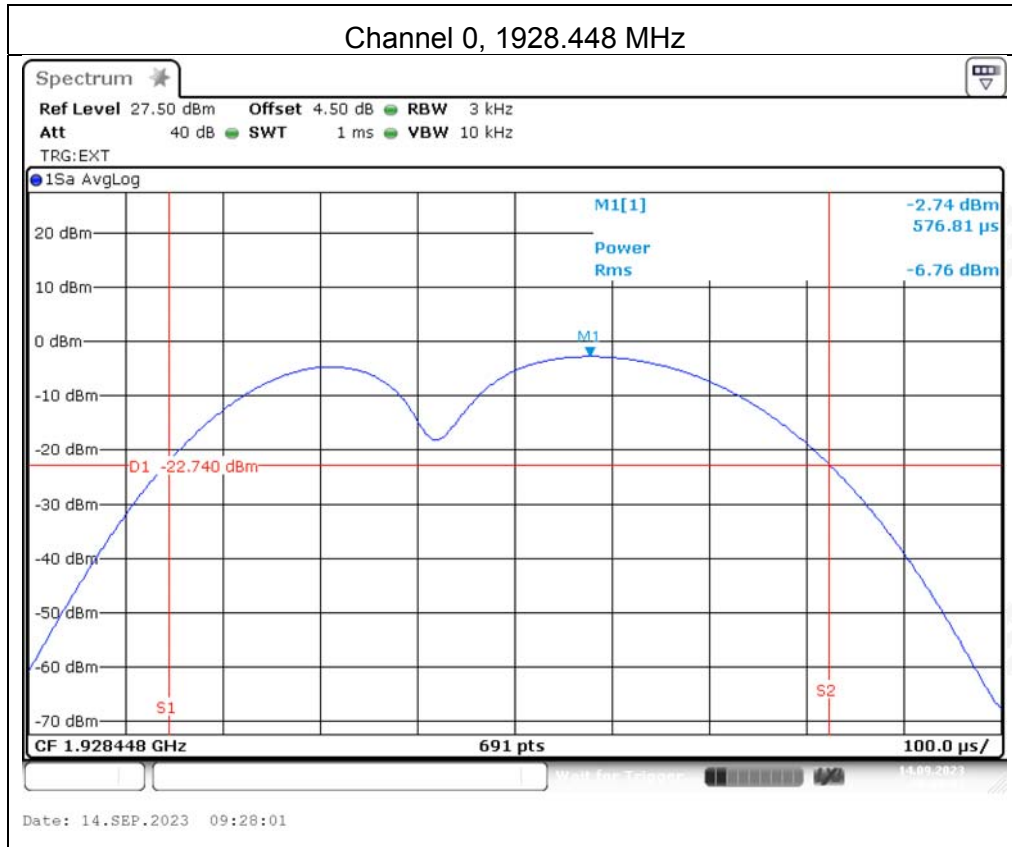



Antenna 2

Carrier Channel	Frequency (MHz)	Measured Peak Power Spectral Density (dBm)	Limit(mw)	Limit(dBm)
Low(4)	1921.536	-3.32	3	4.77
Mid(2)	1924.992	-4.35		
High(0)	1928.448	-4.08		

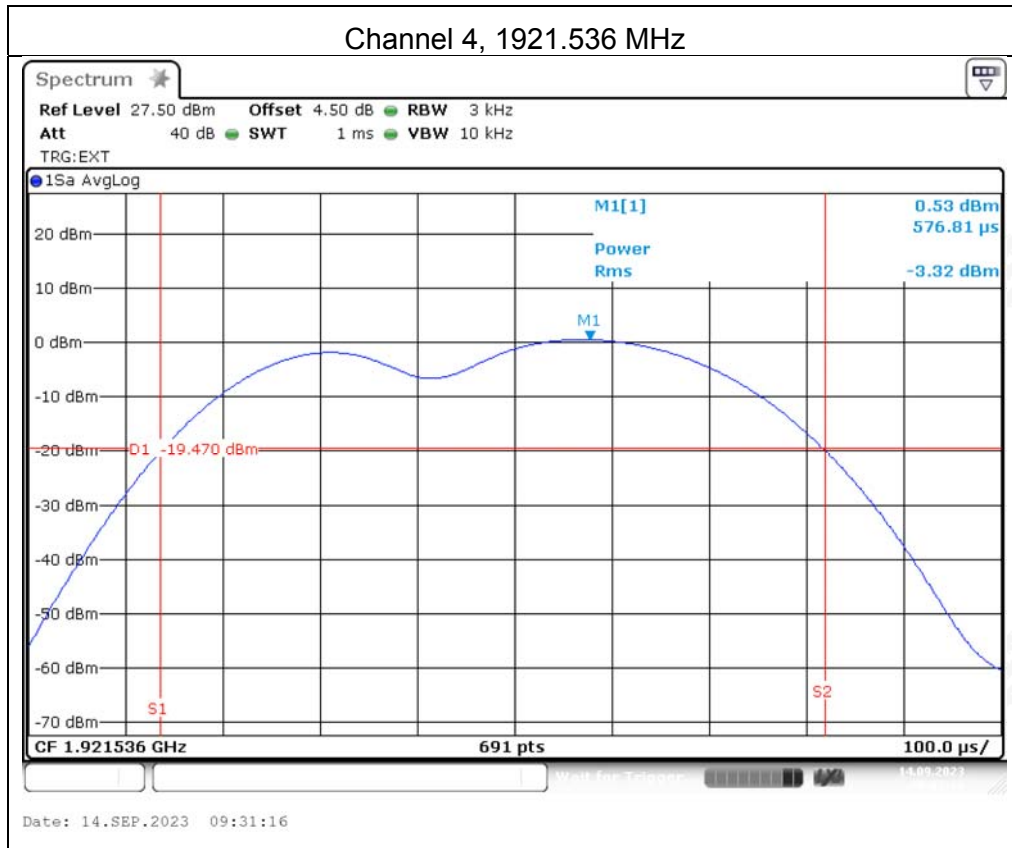

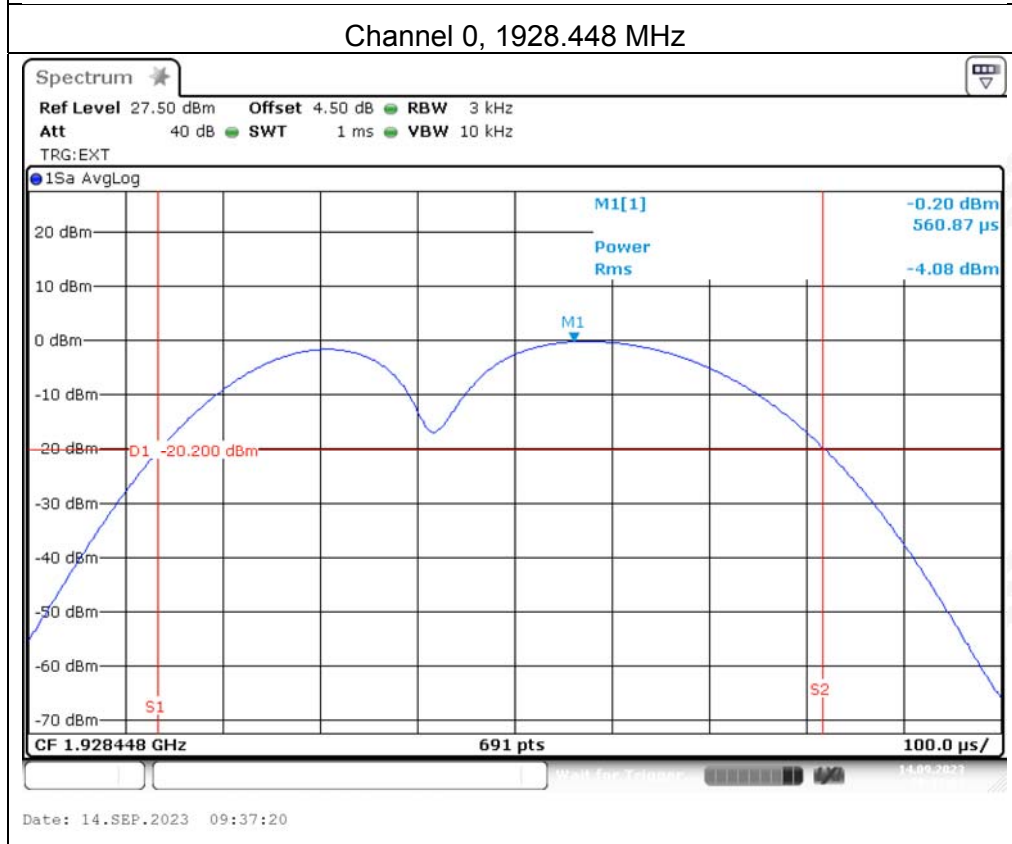
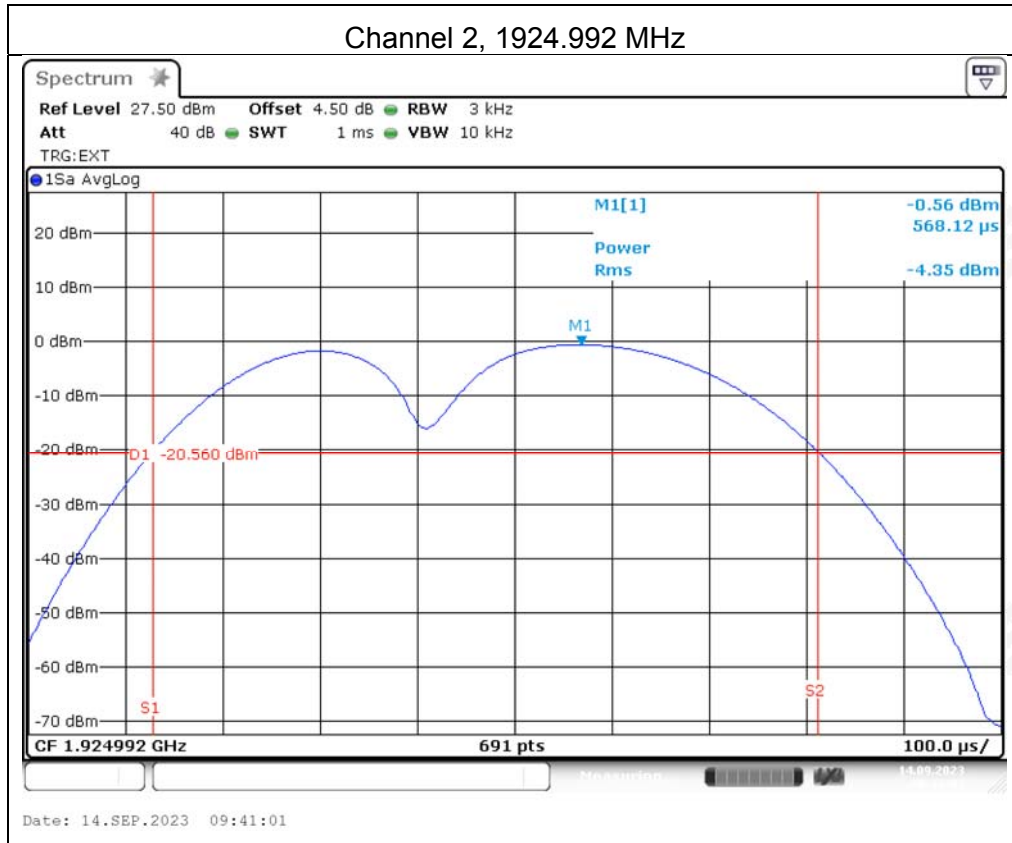



## 5.6 POWER ADJUSTMENT FOR ANTENNA GAIN

### TEST OVERVIEW

§15.319(e): The peak transmit power shall be reduced by the amount in decibels that the maximum directional gain of the antenna exceeds 3 dBi.

### TEST PROCEDURE

Testing to ANSI C63.17-2013 Clause 4.3.1, which provides the test methodology for this provision.

### TEST RESULT

Equipment Employs a 0 dBi Antenna. Max output power allowed with this gain by the EUT is 19.09dBm.

The Max output power does not need to be reduced.

The Output Power complies with the Power Adjustment for Antenna Gain requirements of §15.319(e).



## 5.7 AUTOMATICALLY DISCONTINUE TRANSMISSION

### OVERVIEW

§15.319(f): The device shall automatically discontinue transmission in case of either absence of information to transmit or operational failure. These provisions are not intended to preclude transmission of control and signaling information or use of repetitive codes used by certain digital technologies to complete frame or burst intervals.

### TEST RESULTS

	Test	Reaction of EUT	Result
1	Remove Power from Companion Device	A	Pass
2	Switch off the companion device	A	Pass
3	Terminate call at the companion device	NA1	Pass
4	Switch off the EUT	NA2	Pass
5	Terminate call at the EUT	NA3	Pass

A - Connection was terminated and transmission ceased.

B - Connection was terminated but the EUT transmits control or signaling information.

C - Connection was terminated but the companion device transmits control or signaling information.

NA 1 - Companion Device does not have an on/off switch for terminate call.

NA 2 - EUT does not have an on/off switch.

NA 3 – EUT does not have a switch for terminate call.

5.8 SYSTEM ACKNOWLEDGE-MENT TEST

TEST OVERVIEW

§ 15.323(c)(4): Once access to specific combined time and spectrum windows is obtained an acknowledgment from a system participant must be received by the initiating transmitter within one second or transmission must cease. Periodic acknowledgments must be received at least every 30 seconds or transmission must cease. Channels used exclusively for control and signaling information may transmit continuously for 30 seconds without receiving an acknowledgment, at which time the access criteria must be repeated.

TEST PROCEDURE

Measurement method according to ANSI C63.17 2013 clause 8.2.1

During testing initial transmission without acknowledgement, the signal from the EUT to the companion device is blocked by the circulator.

The test of the transmission time after loss of acknowledgements is performed by cutting off the signal from the companion device by a RF switch and measuring the time until the EUT stops transmitting.

TEST SETUP

The test setup is shown in section 3.2 figure 2.

TEST RESULTS

Antenna 1

Test	Time taken (second)	Limit (second)	Result
Initial Connection acknowledgement	0.41	1	Pass
Change of access criteria for control information	N/A	30	N/A
Transmission cease time after loss of acknowledgement	4.02	30	Pass

Antenna 2

Test	Time taken (second)	Limit (second)	Result
Initial Connection acknowledgement	0.78	1	Pass
Change of access criteria for control information	N/A	30	N/A
Transmission cease time after loss of acknowledgement	4.15	30	Pass



5.9 MONITORING THRESHOLD

TEST OVERVIEW

§15.323 (c)(2). The monitoring threshold must not be more than 30 dB above the thermal noise power for a bandwidth equivalent to the emission bandwidth used by the device.

§15.323 (c)(9). Devices that have a power output lower than the maximum permitted under this subpart may increase their monitoring detection threshold by one decibel for each one decibel that the transmitter power is below the maximum permitted.

TEST PROCEDURE

Testing to ANSI C63.17-2013 Clause 7.3, which provides the test methodology for this provision. The Clause states that the lower threshold is for devices that do not use the LIC procedure. The equation for the lower monitoring threshold is given in ANSI C63.17 Clause 4.3.4.

TEST SETUP

The test setup is shown in section 3.2 figure 2.

TEST RESULTS

Antenna 1

Upper Threshold		
B	1236667	MHz
Mu	50	dB
Peut	15.83	dBm
TU	-58.446	dBm
Lower Threshold		
B	1236667	MHz
MI	30	dB
Peut	15.99	dBm
TL	-78.606	dBm

Antenna 2

Upper Threshold		
B	1240000	MHz
Mu	50	dB
Peut	18.81	dBm
TU	-61.409	dBm
Lower Threshold		
B	1240000	MHz
MI	30	dB
Peut	18.53	dBm
TL	-81.129	dBm

ATTESTATION

The sensor will go into hibernation after a few minutes. It is not possible to keep a connection running very long. Therefore, this requirement is not applicable.



5.10 DURATION OF TRANSMISSION

TEST OVERVIEW

§15.323 (c)(3) If no signal above the threshold level is detected, transmission may commence and continue with the same emission bandwidth in the monitored time and spectrum windows without further monitoring. However, occupation of the same combined time and spectrum windows by a device or group of cooperating devices continuously over a period of time longer than 8 hours is not permitted without repeating the access criteria.

TEST PROCEDURE

Testing to ANSI C63.17-2013 Clause 4, which provides the test methodology for this provision. A communication link is established between BS and MS in a conducted mode and in a room without other US DECT devices to prevent influence from other transmissions. According to FCC Part 15.323(c)(3), the access criteria have to be verified at least every 8 hours. The following test is performed:

TEST SETUP

The test setup is shown in section 3.2 figure 2.

TEST RESULT

Antenna 1

Test ref. to ANSI C63.17:2013 clause 8.2.2	Observation result(H)	Limit(H)	Verdict
Transmission duration on same time and frequency window	0.2750	8	Pass

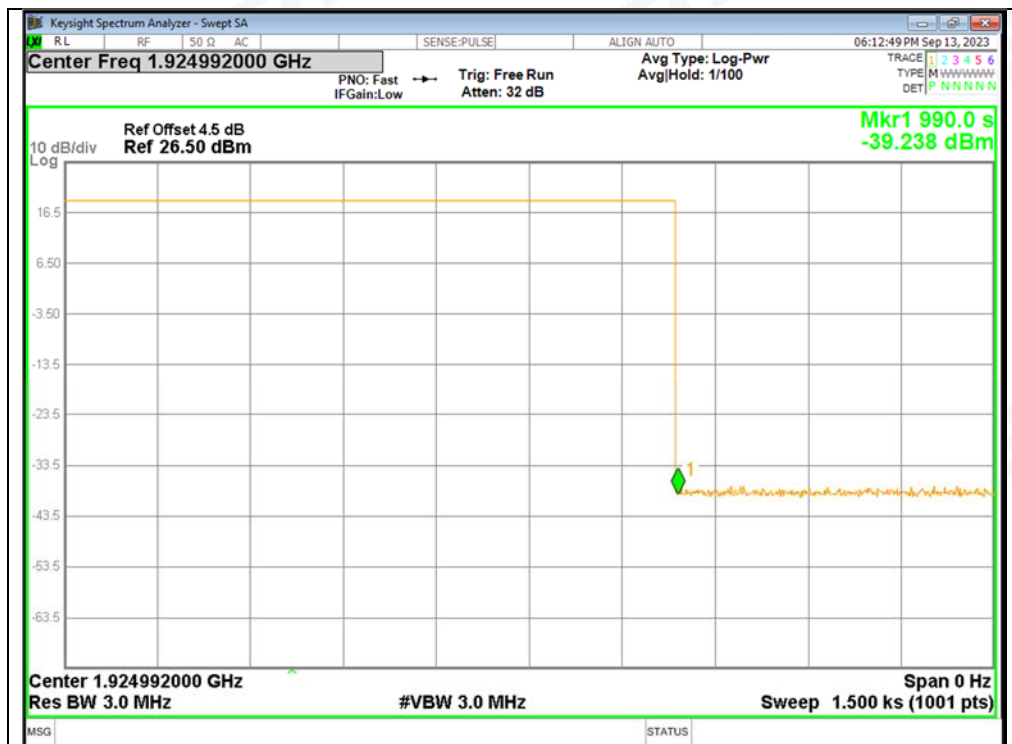





Antenna 2

Test ref. to ANSI C63.17:2013 clause 8.2.2	Observation result(H)	Limit(H)	Verdict
Transmission duration on same time and frequency window	0.2696	8	Pass

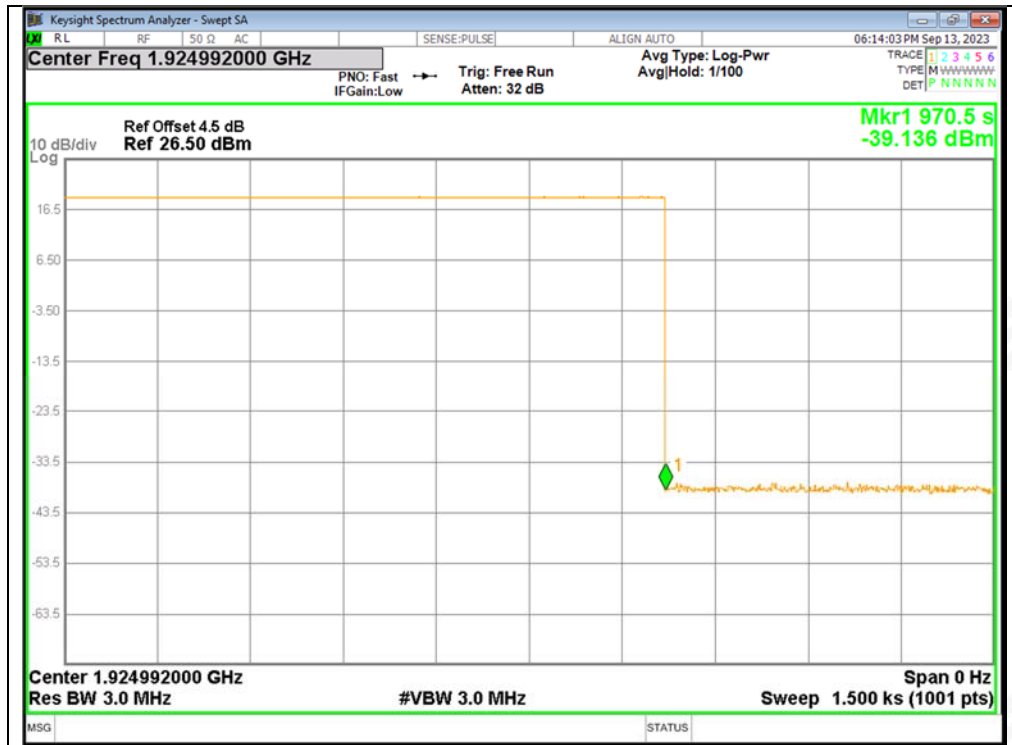



5.11 SELECTED CHANNEL CONFIRMATION, POWER ACCURACY, SEGMENT OCCUPANCY TEST OVERVIEW

§15.323 (c)(5) If access to spectrum is not available as determined by the above, and a minimum of 40 duplex system access channels are defined for the system, the time and spectrum windows with the lowest power level below a monitoring threshold of 50 dB above the thermal noise power determined for the emission bandwidth may be accessed. A device utilizing the provisions of this paragraph must have monitored all access channels defined for its system within the last 10 seconds and must verify, within the 20 milliseconds (40 milliseconds for devices designed to use a 20 milliseconds frame period) immediately preceding actual channel access that the detected power of the selected time and spectrum windows is no higher than the previously detected value. The power measurement resolution for this comparison must be accurate to within 6 dB. No device or group of co-operating devices located within 1 meter of each other shall during any frame period occupy more than 6 MHz of aggregate bandwidth, or alternatively, more than one third of the time and spectrum windows defined by the system.

TEST PROCEDURE

Testing to ANSI C63.17-2013 Clause 7.3.2. & 7.3.3, which provides the test methodology for this provision. The current product offers 12 duplex channels per frequency channel and therefore 12x5=60 duplex channels in total. Hence Part §15.323(c)(5) applies. The equation for the upper monitoring threshold is given in ANSI C63.17 Clause 4.3.3. Max measured interference level (dBm) = -85.02 dBm

TEST SETUP

The test setup is shown in section 3.2 figure 2.

MONITORING LIMIT THRESHOLD

The EUT's monitoring limit threshold power at the monitoring antenna terminals shall be less than a maximum, shown in Equation (3):

T\_L ≤ (-174 + 10logB + M\_L + P\_MAX - P\_EUT) dBm

M\_L is a level specified by the manufacturer and is the maximum amount in decibels by which the limiting threshold may exceed thermal noise for an EUT transmitting the maximum allowed power.

Calculation of monitoring threshold limits for isochroous devices:

Lower threshold: T\_L = -174 + 10log\_10B + M\_L + P\_MAX - P\_EUT (dBm)

Where: B= Emission bandwidth (Hz)

M\_L= dB the threshold may exceed thermal noise (30 for T\_L)

P\_MAX = 5Log\_10B - 10 (dBm)

P\_EUT = Transmitted power (dBm)

Table with 6 columns: Monitor Threshold, B(Hz), M\_L(dB), P\_MAX(dBm), P\_EUT(dBm), Threshold(dBm). Row 1: Lower threshold, 1240000, 30, 50.467, 18.53, -81.129

Note: 1. The upper threshold is applicable as the EUT utilizes more than 20 duplex system channels

**TEST RESULTS**

1) LIC procedure test:

Interference (Refer to ANSI C63.17 clause 7.3.3)	Reaction fo EUT	Results
a) Apply the interference on $f_1$ at level $T_L+U_M+7\text{dB}$ and the interference on $f_2$ at level $T_L+U_M$ . Initiate transmission and verify the transmission only on $f_2$ . Repeat 5 times.	EUT transmits on $f_2$	Pass
b) Apply the interference on $f_1$ at level $T_L+U_M$ and the interference on $f_2$ at level $T_L+U_M+7\text{dB}$ . Initiate transmission and verify the transmission only on $f_1$ . Repeat 5 times.	EUT transmits on $f_1$	Pass
c) Apply the interference on $f_1$ at level $T_L+U_M+1\text{dB}$ and the interference on $f_2$ at level $T_L+U_M-6\text{dB}$ . Initiate transmission and verify the transmission only on $f_2$ . Repeat 5 times.	EUT transmits on $f_2$	Pass
d) Apply the interference on $f_1$ at level $T_L+U_M-6\text{dB}$ and the interference on $f_2$ at level $T_L+U_M+1\text{dB}$ . Initiate transmission and verify the transmission only on $f_2$ . Repeat 5 times.	EUT transmits on $f_1$	Pass

2) Selected channel confirmation:

Interference (Refer to ANSI C63.17 clause 7.3.4)	Reaction fo EUT	Results
a) Apply the interference on $f_1$ at level $T_L+U_M$ and no interference on $f_2$ . Initiate transmission and verify the transmission only on $f_2$ . Then terminate it.	EUT transmits on $f_2$	Pass
b) Apply the interference on $f_2$ at level $T_L+U_M$ and immediately remove all interference from $f_1$ . The EUT should immediately attempt transmission $f_1$ (but at least 20ms after the interference on $f_2$ is applied), verify the transmission only on $f_1$ .	EUT transmits on $f_1$	Pass



## 5.12 RANDOM WAITING

### TEST CRITERIA

§15.323 (c)(6) ) if the selected combined time and spectrum windows are unavailable, the device may either monitor and select different windows or seek to use the same windows after waiting an amount of time, randomly chosen from a uniform random distribution between 10 and 150 milliseconds, commencing when the channel becomes available.

### TEST PROCEDURE

Testing to ANSI C63.17-2013 Clause 8.1.3, which provides the test methodology for this provision.

### ATTESTATION

The Manufacturer declared that this provision is not utilized by the EUT.

5.13 MONITORING REQUIREMENTS

TEST CRITERIA

§15.323 (c)(7) The monitoring system bandwidth must be equal to or greater than the emission bandwidth of the intended transmission and have a maximum reaction time less than  $50 \times \text{SQRT}(1.25/\text{emission bandwidth in MHz})$  microseconds for signals at the applicable threshold level but shall not be required to be less than 50 microseconds. If a signal is detected that is 6 dB or more above the applicable threshold level, the maximum reaction time shall be  $35 \times \text{SQRT}(1.25/\text{emission bandwidth in MHz})$  microseconds but shall not be required to be less than 35 microseconds.

TEST PROCEDURE

Measurement method according to ANXI C63.17 2013 clause 7.5

- a) Restrict the EUT to a single transmit carrier frequency  $f_1$ , and verify that the EUT can establish a connection with no interference applied on  $f_1$ .
- b) Apply time-synchronized, pulsed interference on  $f_1$  at the pulsed level  $T_L+U_M$ , verify that the EUT does not establish a connection when the width of the interference pulse exceeds the largest of  $50\mu\text{s}$  and  $50 \sqrt{1.25 / B} \mu\text{s}$ , where B is the emission bandwidth of the EUT in megahertz.
- c) With the channel interference level 6dB above  $T_L+U_M$ , verify that the EUT does not establish a connection when the width of the interference pulse exceeds the largest of  $35\mu\text{s}$  and  $35\sqrt{1.25/B}\mu\text{s}$ , where B is the emission bandwidth of the EUT in megahertz.

Test pulse width Equation( $\mu\text{s}$ )	B(bandwidth)(MHz)	Pulse width( $\mu\text{s}$ )	Limit(Largest)( $\mu\text{s}$ )
$50(1.25/B)^{1/2}$	1.240	50.201	50
$35(1.25/B)^{1/2}$	1.240	30.121	35

TEST SETUP

The test setup is shown in section 3.2 figure 2.

TEST RESULTS

1) Monitoring Bandwidth:

The antenna of the EUT used for monitoring is the same interior antenna that used for transmission, so the monitoring system bandwidth is equal to the emission bandwidth of the intended transmission.

2) Reaction Time Test:

No.	Interference Pulse width( $\mu\text{s}$ )	Reaction of EUT	Observing time( $\mu\text{s}$ )	Result
1	50 $\mu\text{s}$ with level $T_L+U_m$	No transmission	50	Pass
2	35 $\mu\text{s}$ with level $T_L+U_M +6\text{dB}$	No transmission	35	Pass



#### 5.14 MONITORING ANTENNA

##### TEST CRITERIA

§15.323 (c)(8) Transmission is intended to occupy. The following criteria must be met: (8) The monitoring system shall use the same antenna used for transmission, or an antenna that yields equivalent reception at that location.

##### TEST PROCEDURE

Testing to ANSI C63.17-2013 Clause 4, which provides the test methodology for this provision.

##### ATTESTATION

The EUT uses the same antennas for transmission and reception as for monitoring

#### 5.15 DUPLEX CONNECTIONS

##### TEST CRITERIA

§15.323 (c)(10) An initiating device may attempt to establish a duplex connection by monitoring both its intended transmit and receive time and spectrum windows. If both the intended transmit and receive time and spectrum windows meet the access criteria, then the initiating device can initiate a transmission in the intended transmit time and spectrum window. If the power detected by the responding device can be decoded as a duplex connection signal from the initiating device, then the responding device may immediately begin transmitting on the receive time and spectrum window monitored by the initiating device.

##### TEST PROCEDURE

Testing to ANSI C63.17-2013 Clause 8.3, which provides the test methodology for this provision. The MS is the initiating device and the BS is the companion device.

##### TEST RESULTS

The Manufacturer declares that this provision is not utilized by the EUT.



## 5.16 ALTERNATIVE MONITORING INTERVAL FOR CO-LOCATED DEVICES

### TEST CRITERIA

§15.323 (c)(11) an initiating device that is prevented from monitoring during its intended transmit window due to monitoring system blocking from the transmissions of a co-located (within one meter) transmitter of the same system, may monitor the portions of the time and spectrum windows in which they intend to receive over a period of at least 10 milliseconds. The Monitored time and spectrum window must total at least 50 percent of the 10 millisecond frame interval and the monitored spectrum must be within the 1.25 mhz frequency channel(s) already occupied by that device or co-located co-operating devices. If the access criteria is met for the intended receive time and spectrum window under the above conditions, then transmission in The intended transmit window by the initiating device may commence.

### TEST PROCEDURE

Testing to ANSI C63.17-2013 Clause 8.4, which provides the test methodology for this provision. The MS is initiating device and the BS is the companion device.

### TEST RESULTS

The Manufacturer declares that this provision is not utilized by the EUT.

## 5.17 FAIR ACCESS

### TEST CRITERIA

§15.323 (c)(12) The provisions of (c)(10) or (c)(11) of this section shall not be used to extend the range of spectrum occupied over space or time for the purpose of denying fair access to spectrum to other devices.

### TEST PROCEDURE

The manufacturer supplies an attestation.

### ATTESTATION

The manufacturer declares that the EUT does not work in a mode which denies fair access to spectrum for other devices.



### 5.18 SPURIOUS EMISSIONS

#### TEST CRITERIA

##### §15.323(d)(1): Out of Band Emissions

Emissions shall be attenuated below a reference power of 112 milliwatts as follows: 30 dB between the band edge and 1.25 MHz above or below the band; 50 dB between 1.25 and 2.5 MHz above or below the band; and 60 dB at 2.5 MHz or greater above or below the band.

##### §15.323(d)(2): In-Band Emissions

Emissions inside the band must comply with the following emission mask: In the bands between 1B and 2B measured from the center of the emission bandwidth, the total power emitted by the device shall be at least 30 dB below the transmit power permitted for that device; in the bands between 2B and 3B measured from the center of the emission bandwidth, the total power emitted by an intentional radiator shall be at least 50 dB below the transmit power permitted for that radiator; in the bands between 3B and the band edge, the total power emitted by an intentional radiator in the measurement bandwidth shall be at least 60 dB below the transmit power permitted for that radiator. "B" is defined as the emission bandwidth of the device in hertz. Compliance with the emission limits is based on the use of measurement instrumentation employing peak detector function with an instrument resolution bandwidth approximately equal to 1.0 percent of the emission bandwidth of the device under measurement.

#### TEST PROCEDURE

For both in and out of band emissions the EUT was connected directly to a spectrum analyzer. The RBW of the spectrum analyzer was set to a minimum 1% of the emission band width.

#### TEST SETUP

The test setup is shown in section 3.2 figure 1.

#### TEST RESULTS

Equipment complies with the Spurious Emission limits of § 15.323(d)(1).

##### In-Band Emissions

Antenna 1

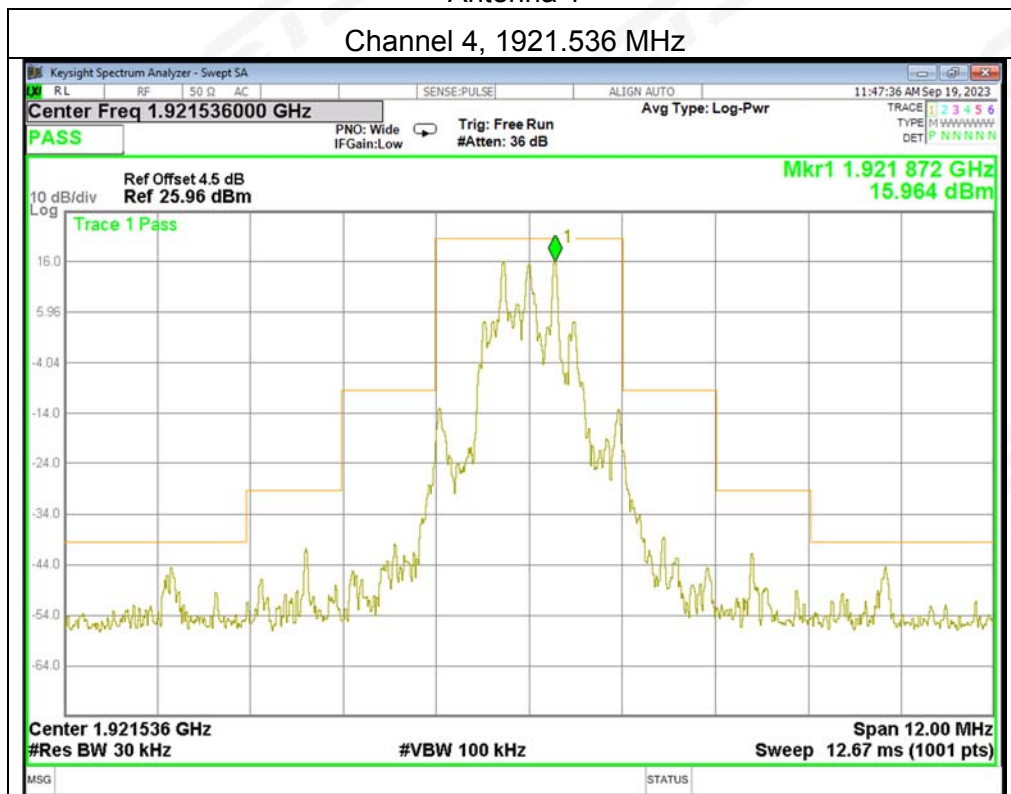



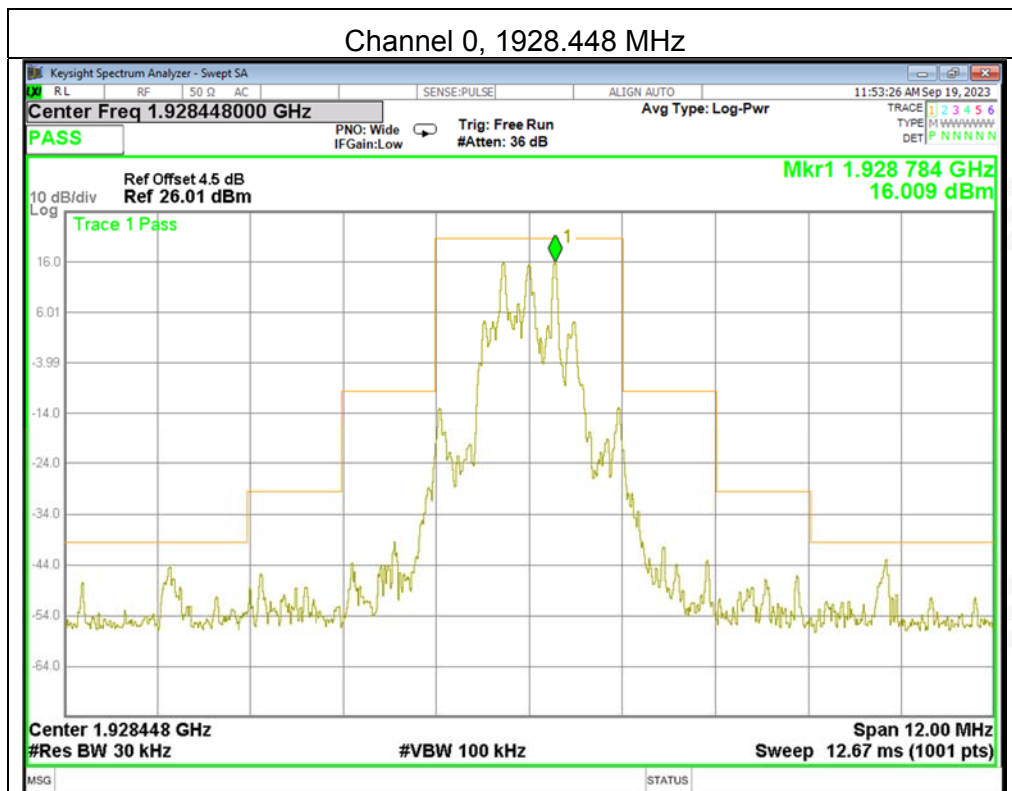
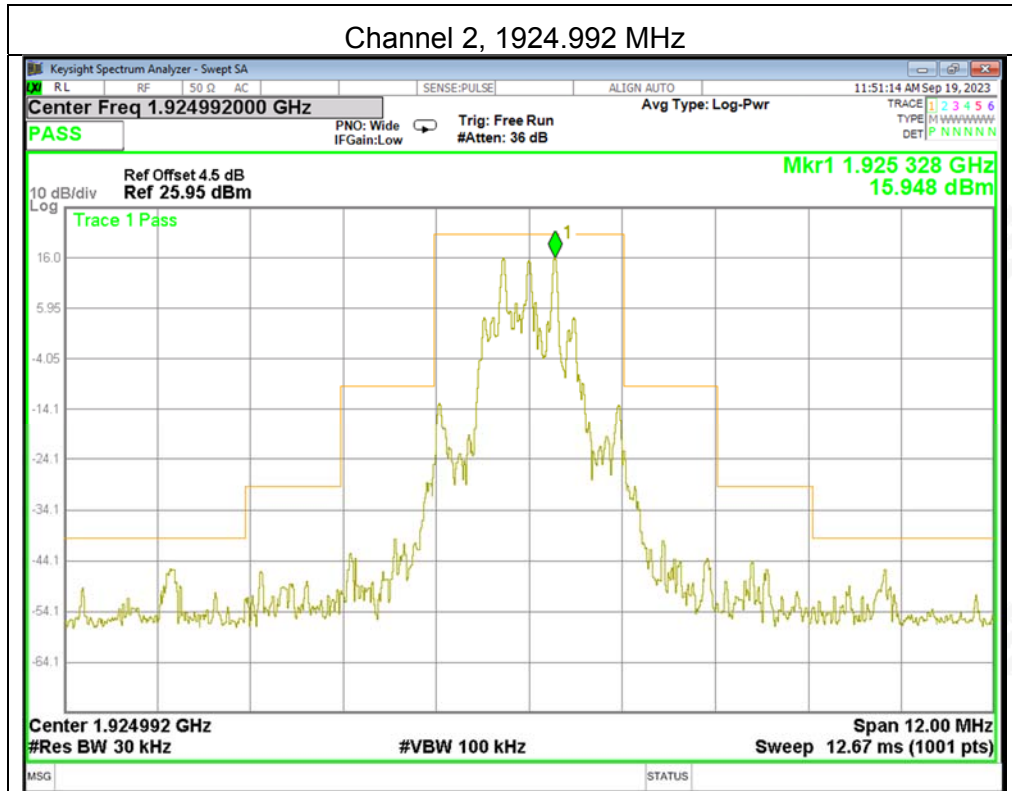



Antenna 2

Channel 4, 1921.536 MHz

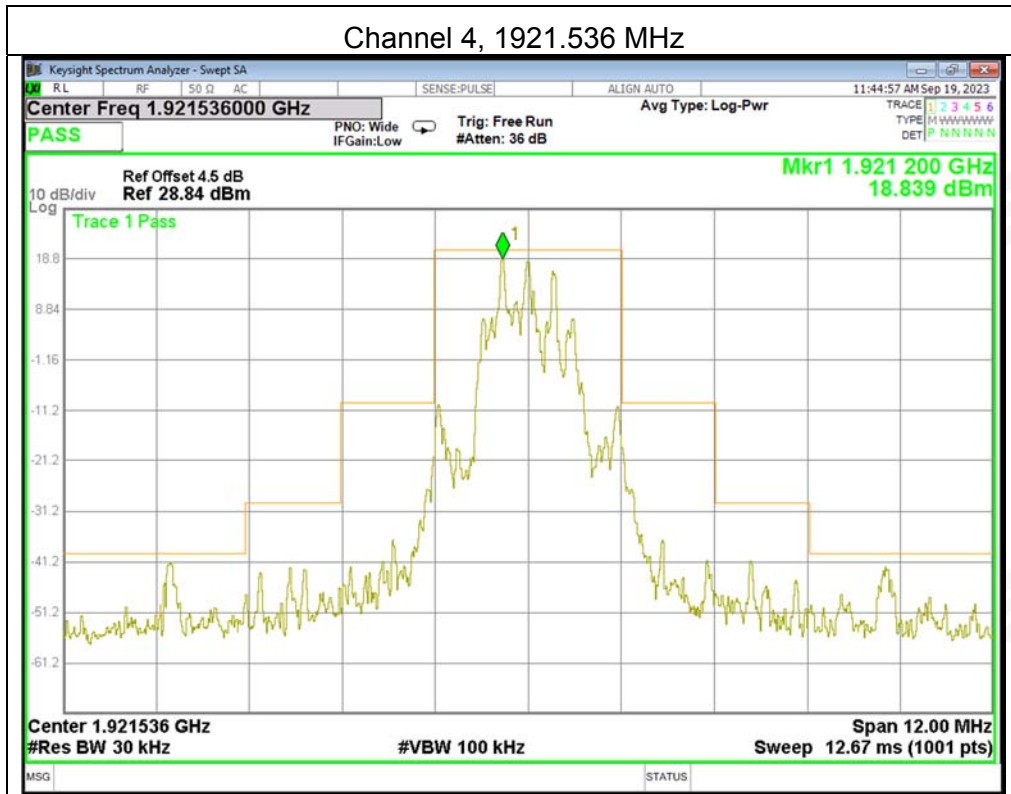

Channel 2, 1924.992 MHz

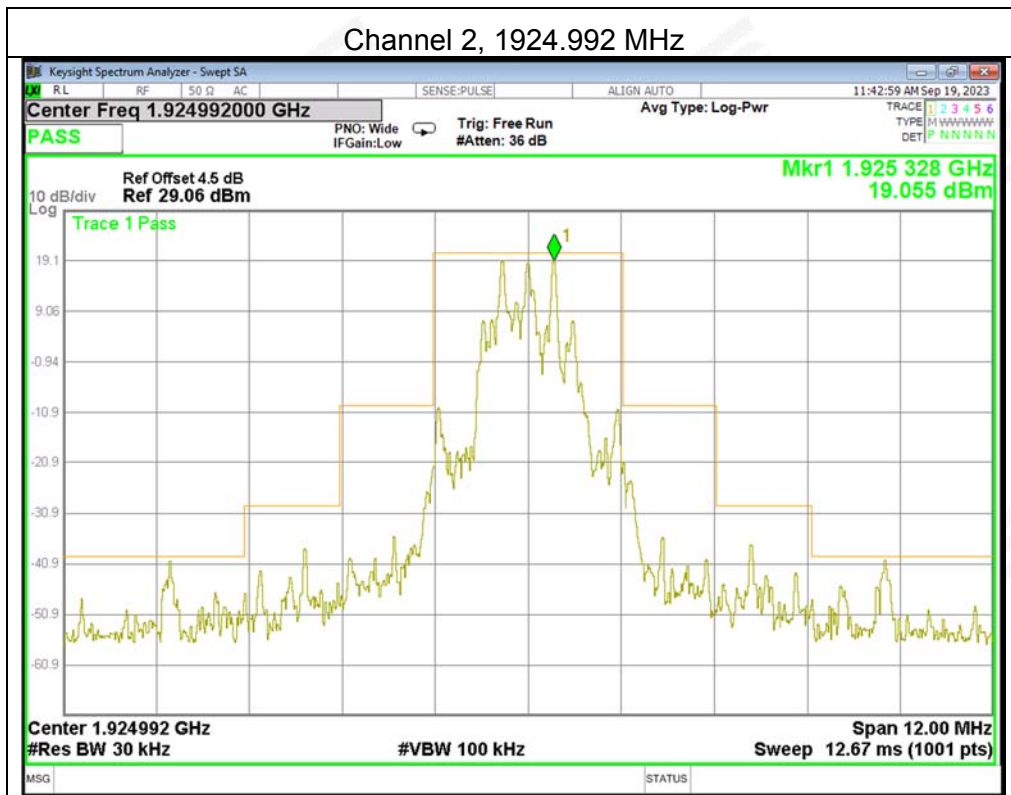

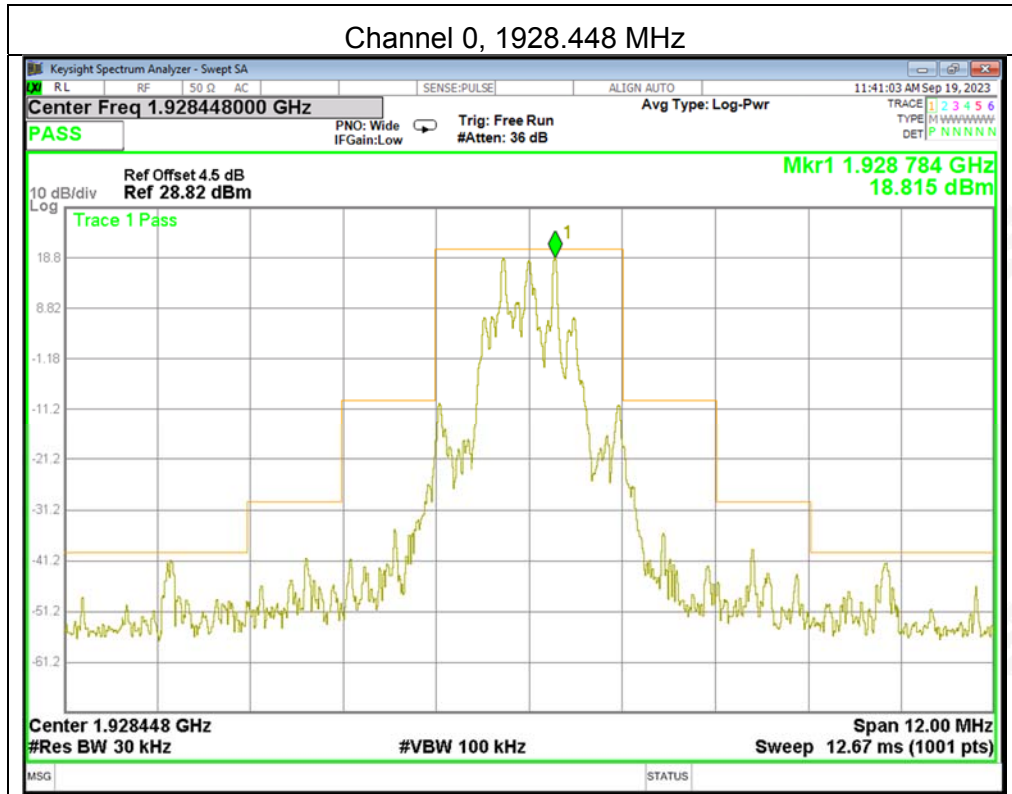



Out of Band Emissions

Antenna 1

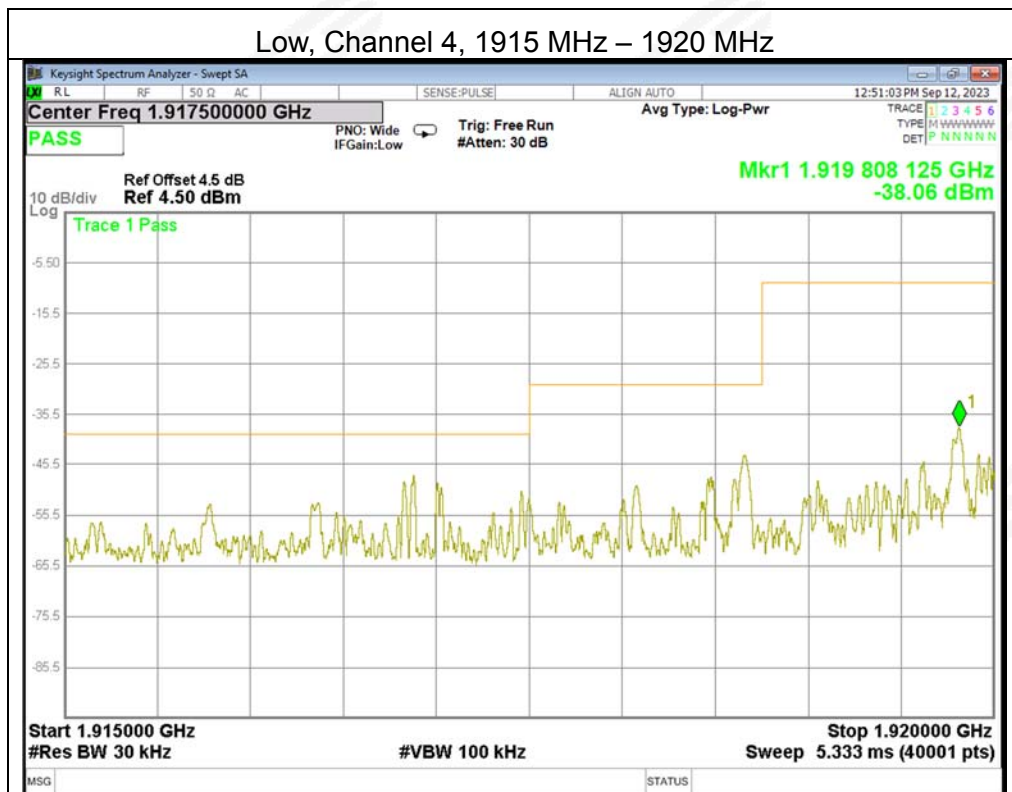
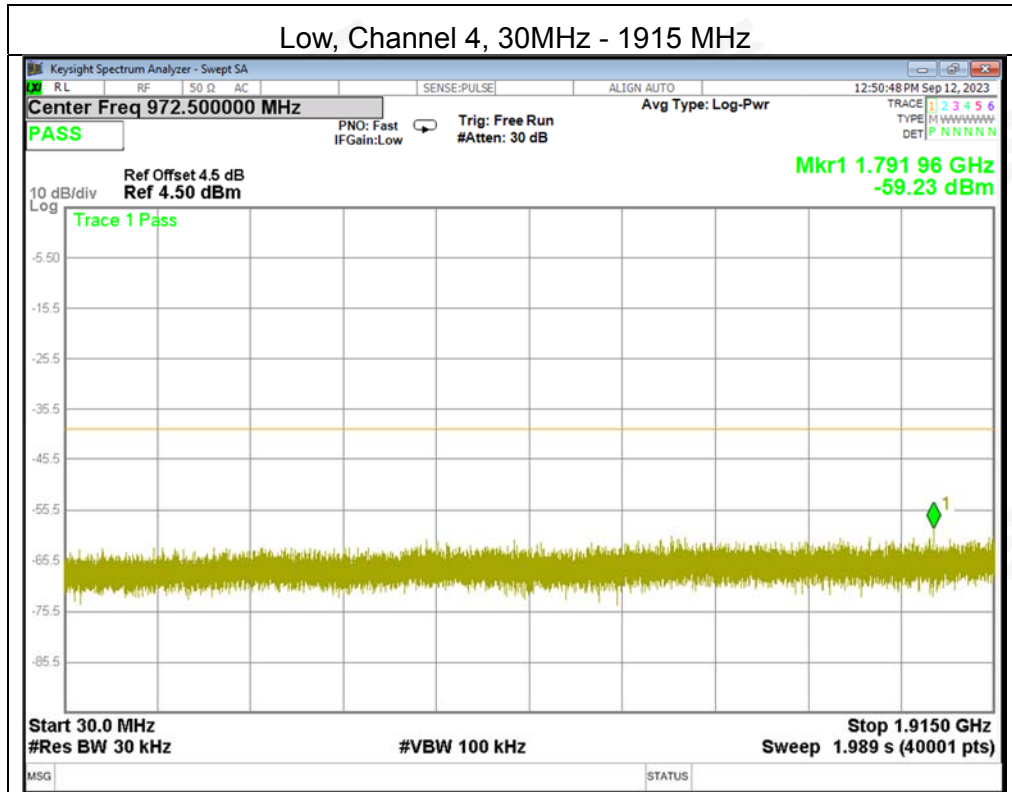

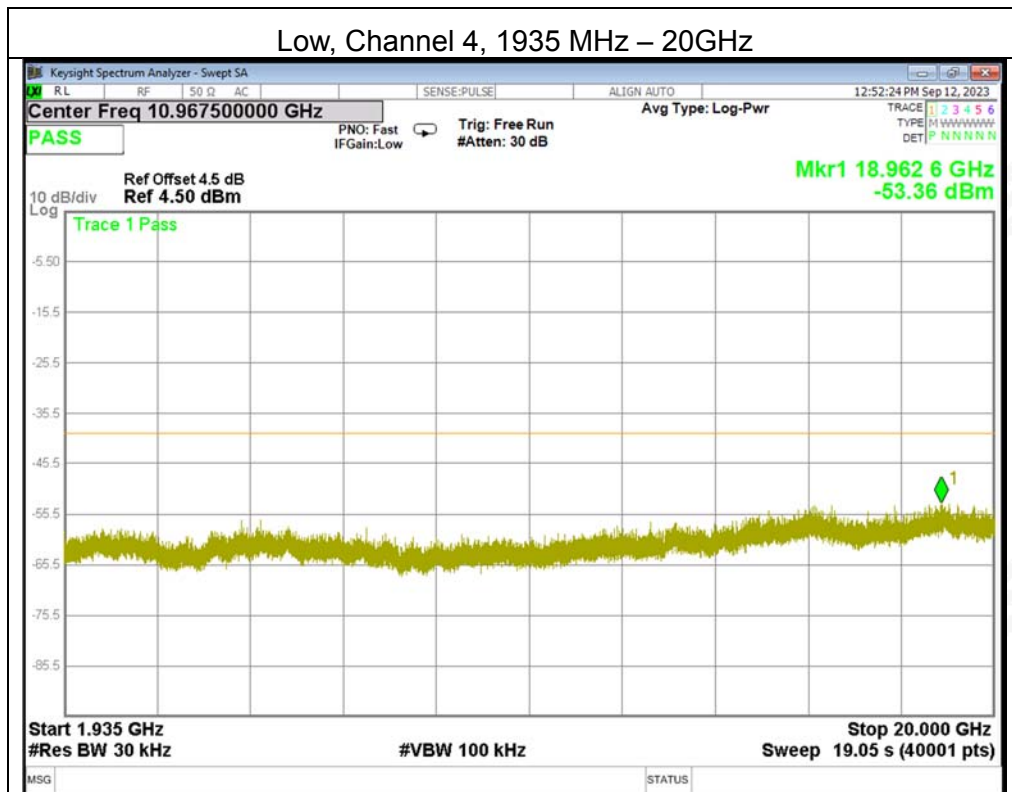
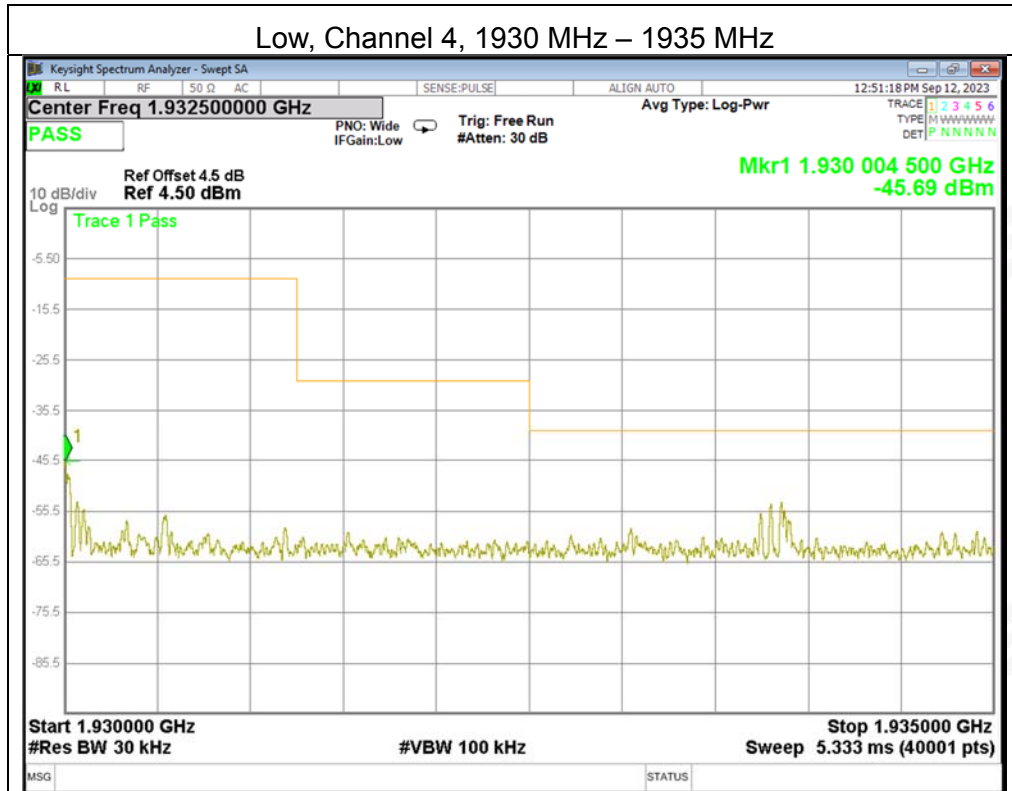

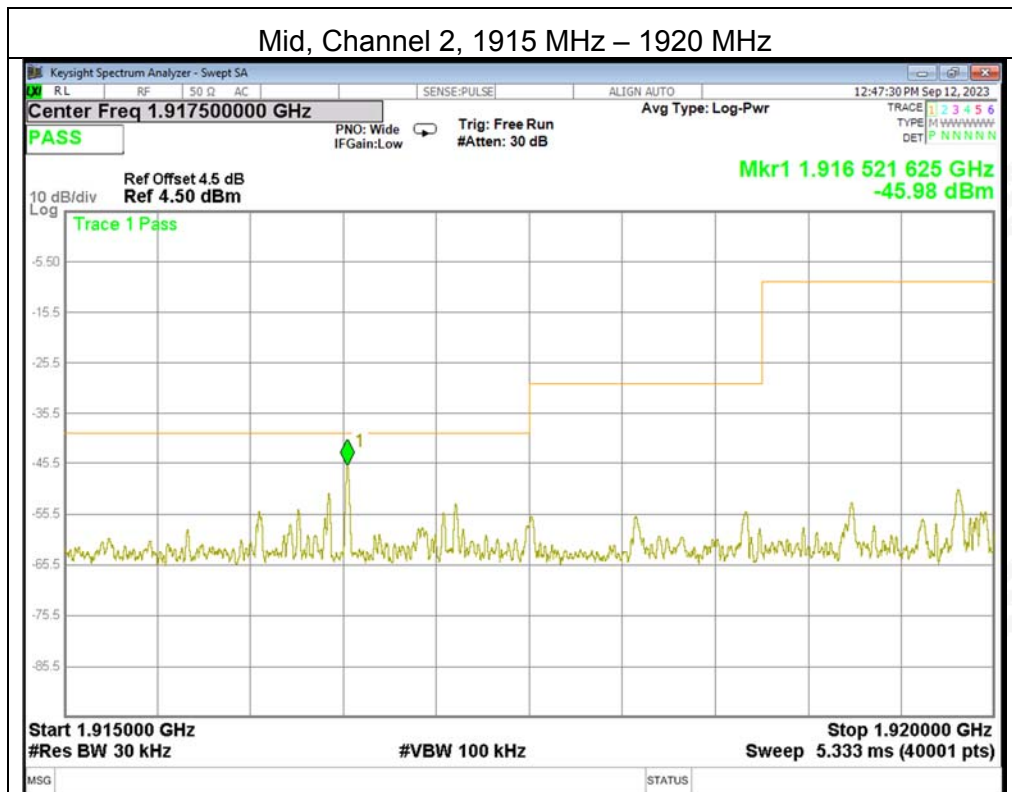
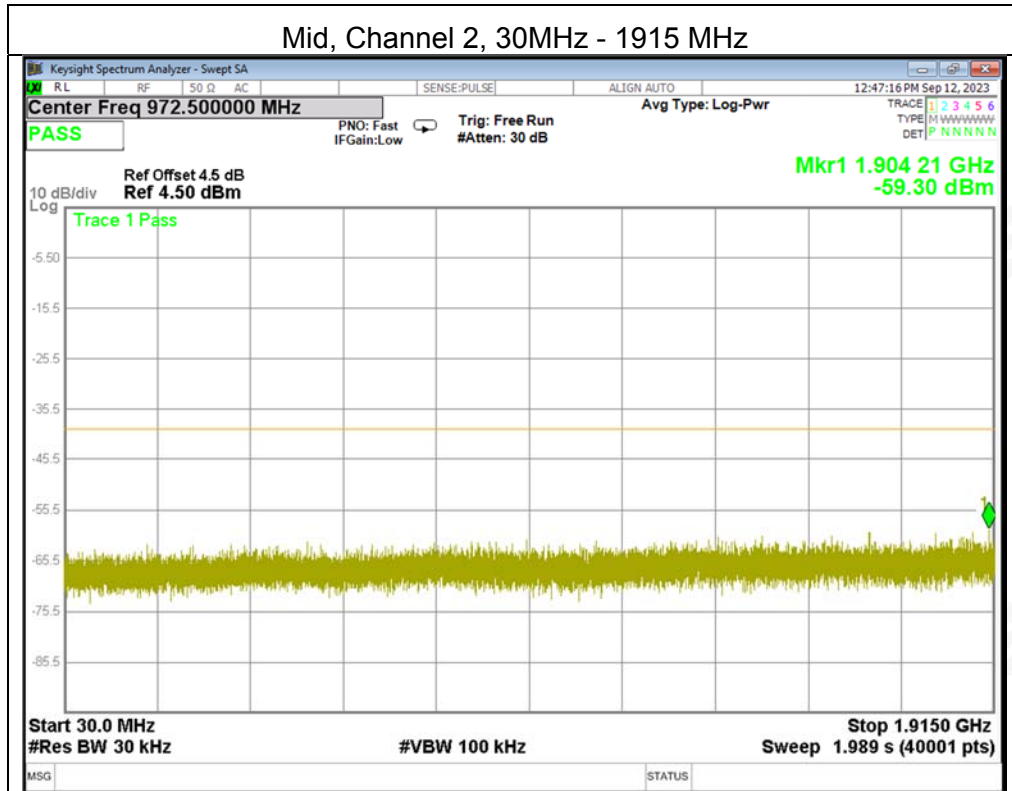





### Mid, Channel 2, 1930 MHz – 1935 MHz

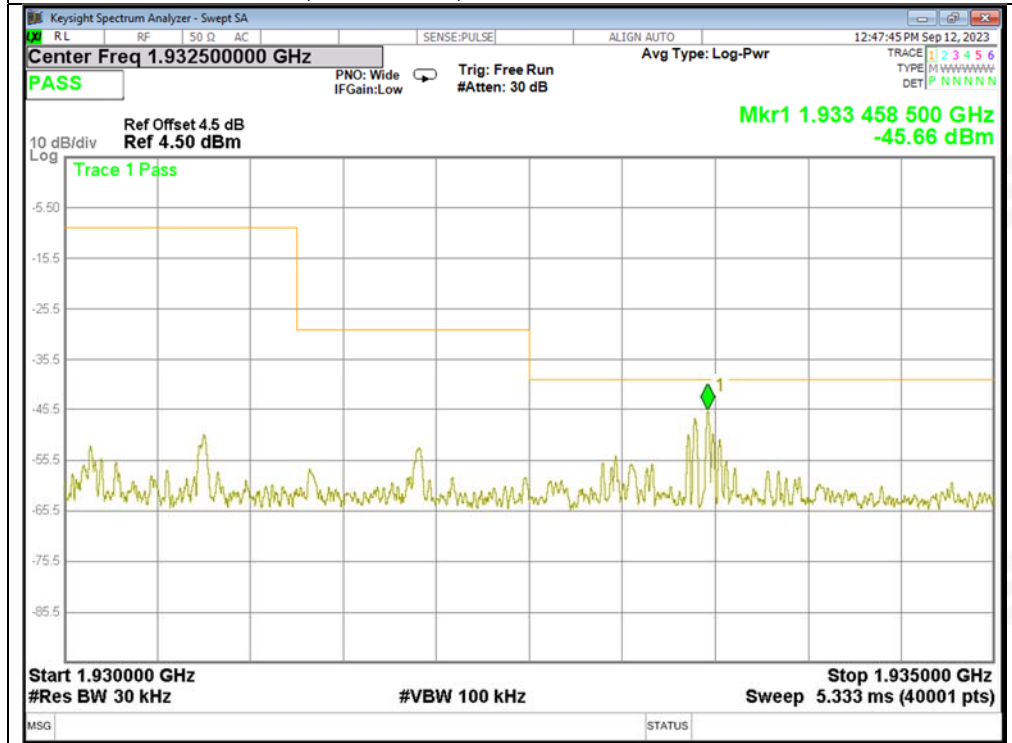

### Mid, Channel 2, 1935 MHz – 20GHz

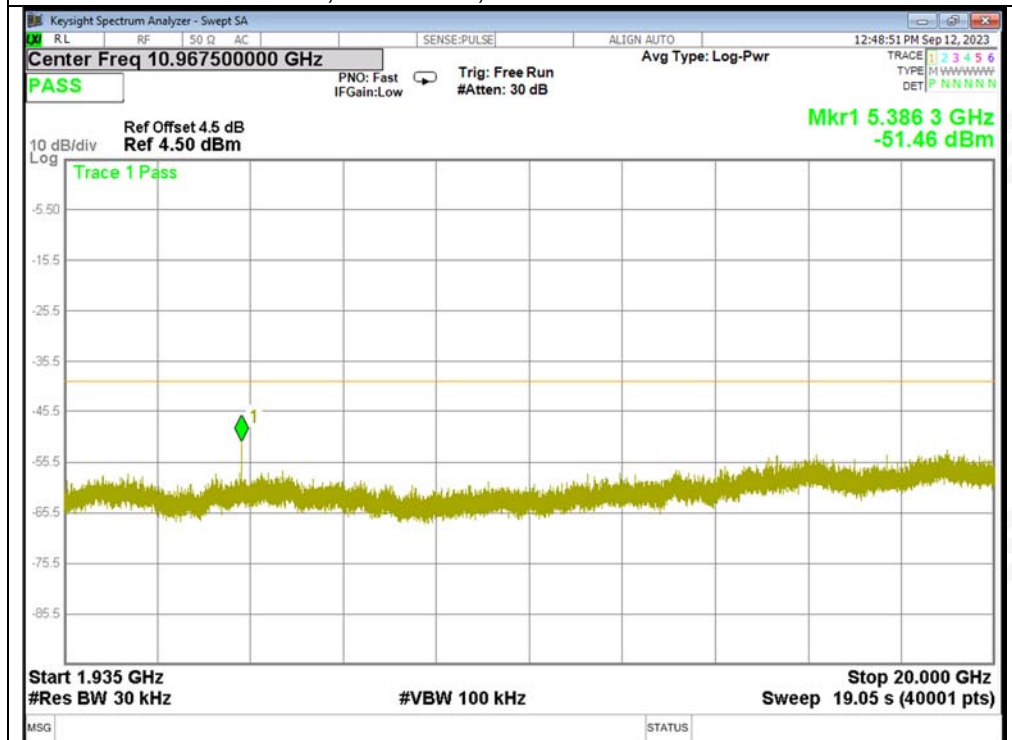

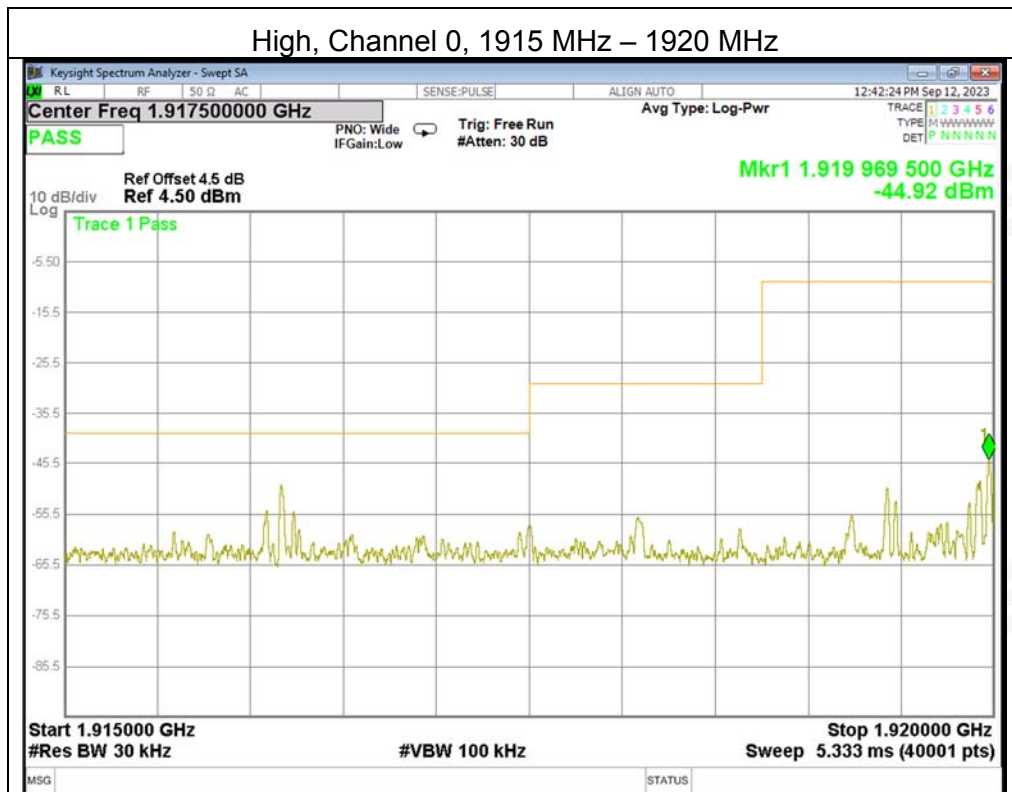
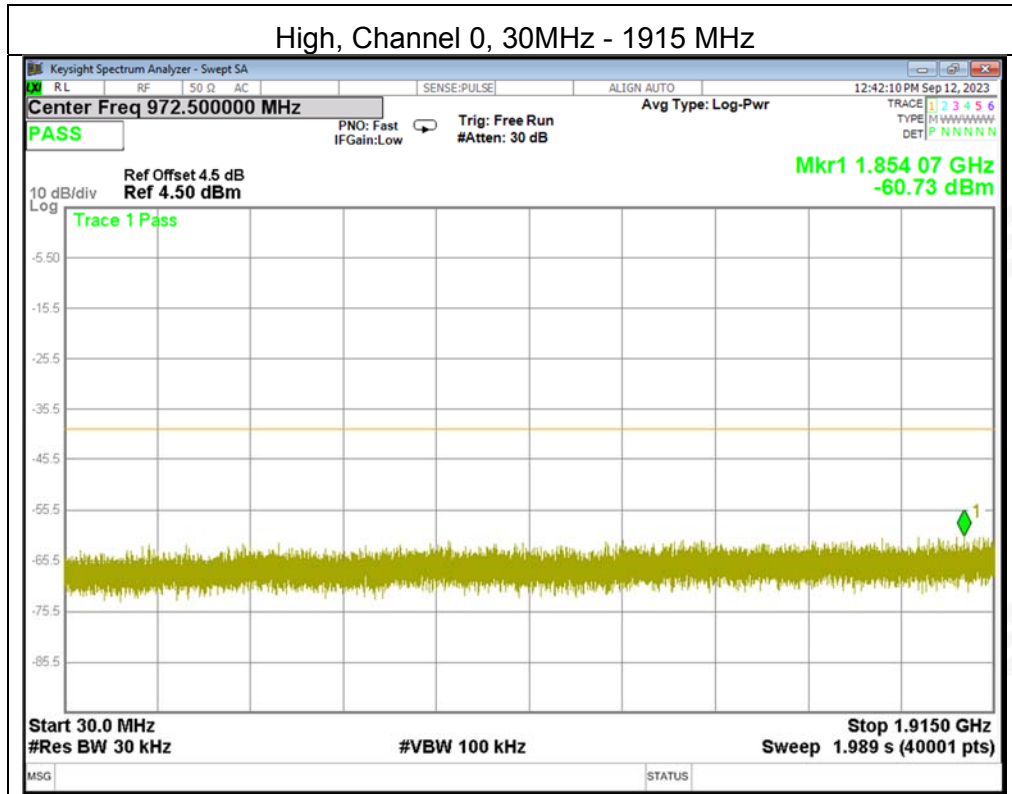



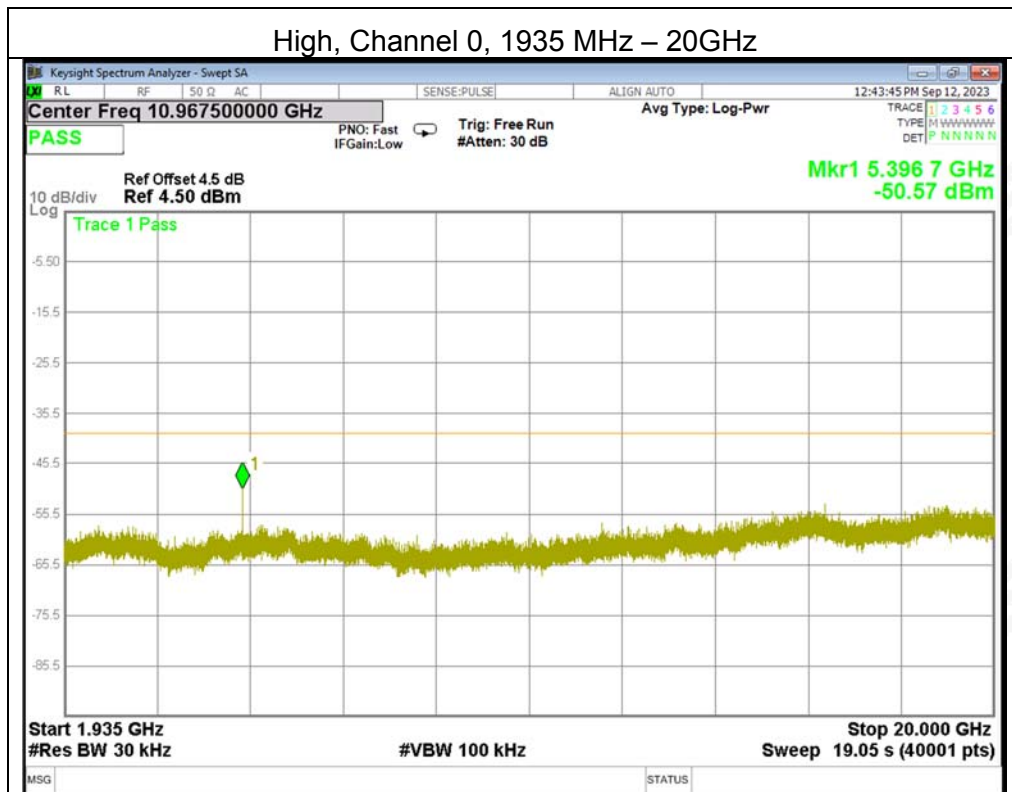
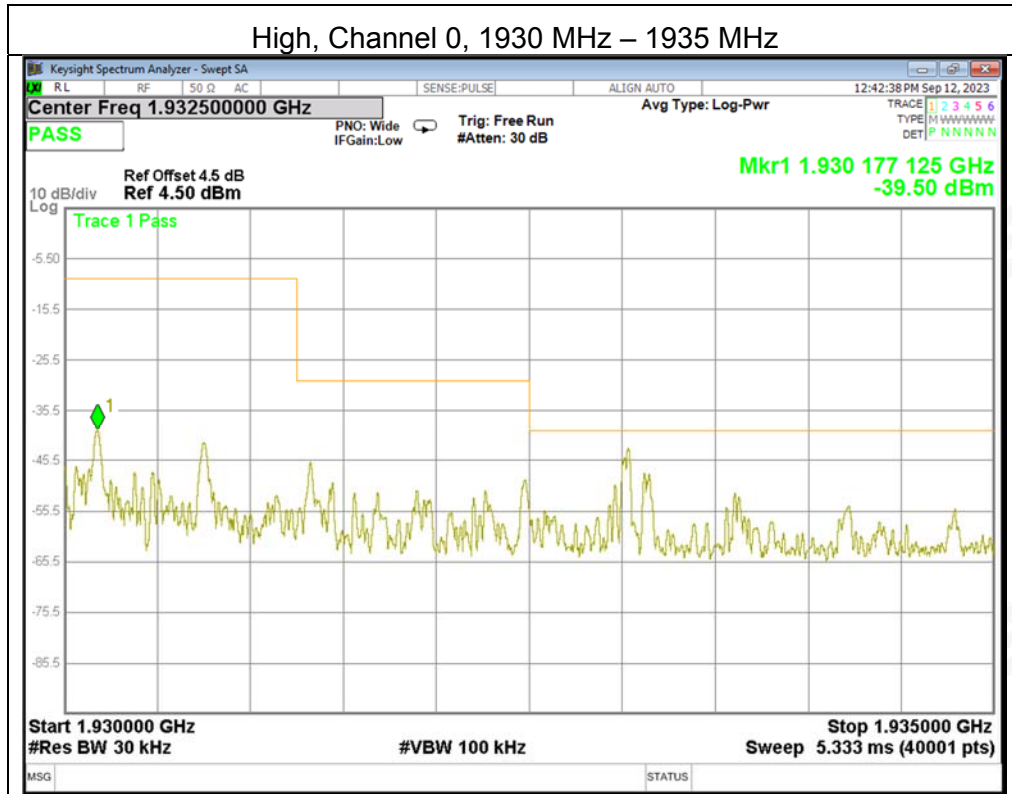



Antenna 2

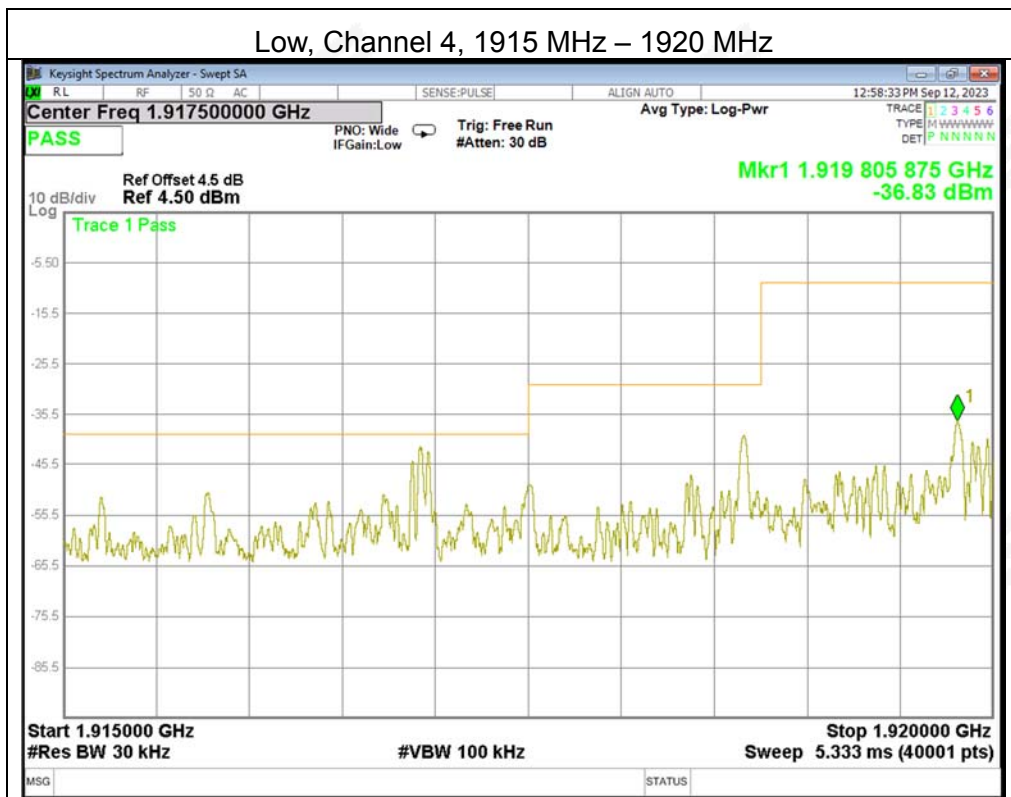
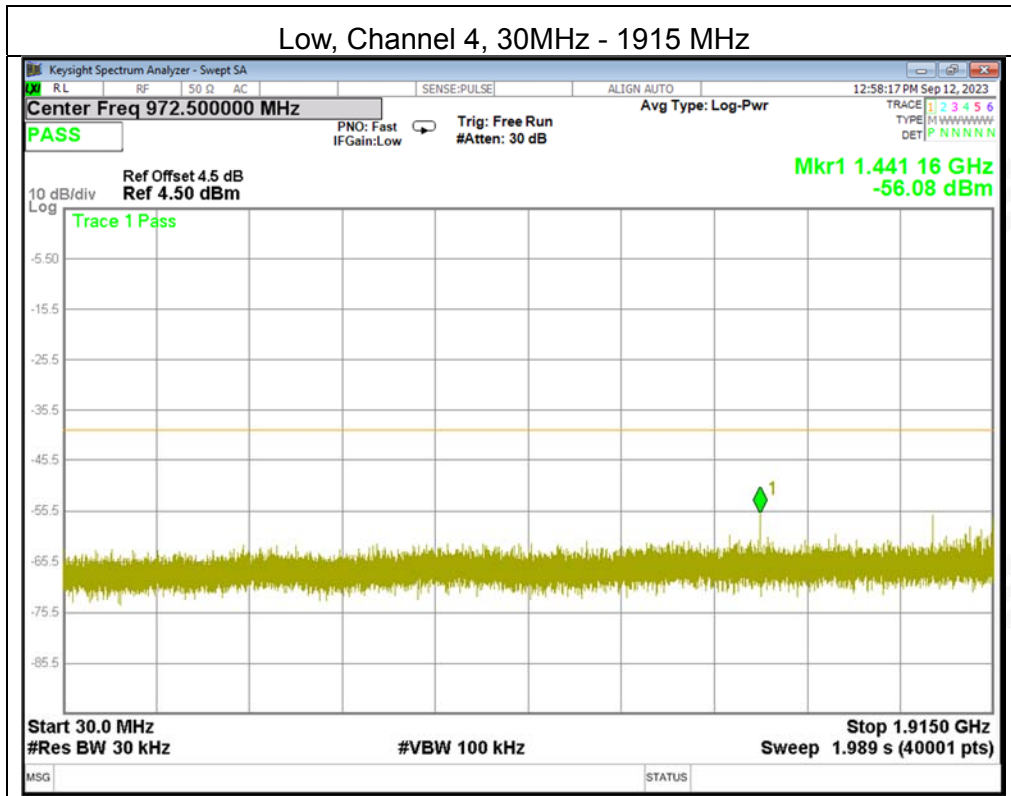

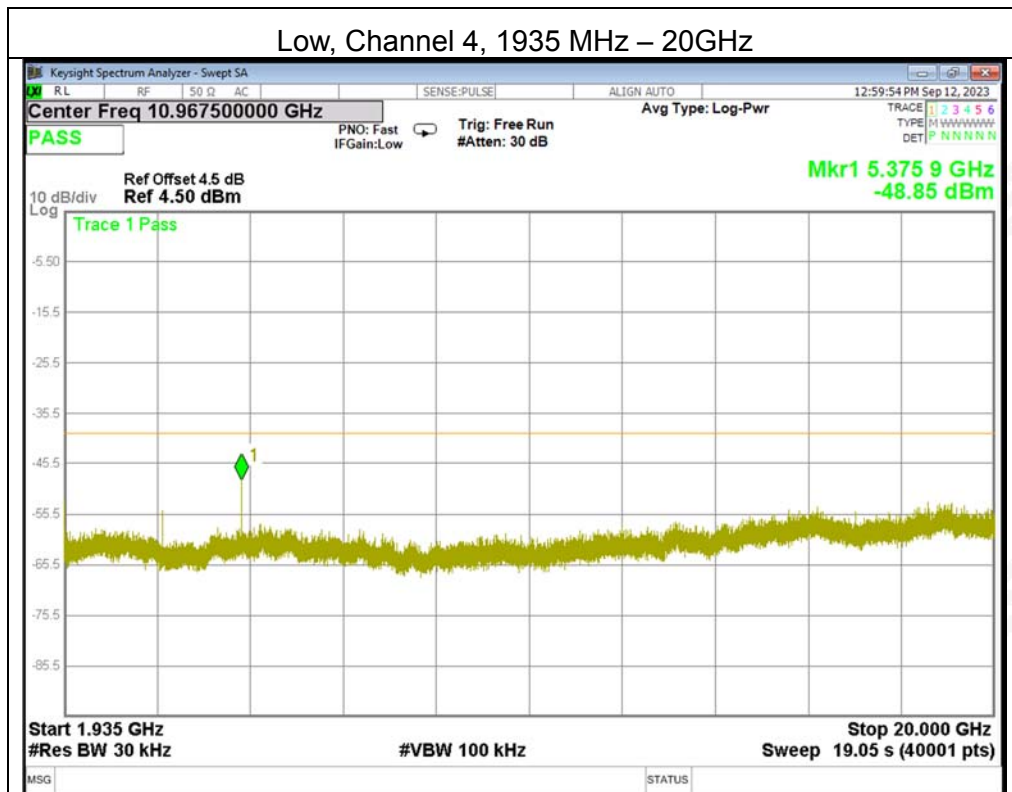
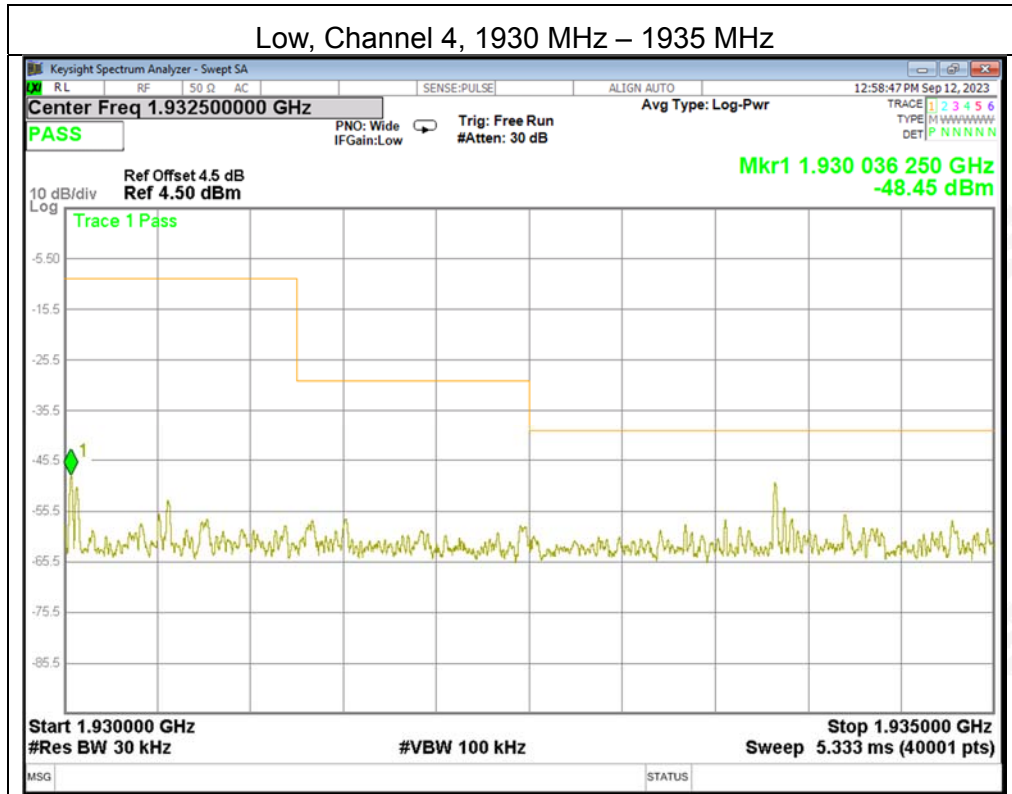

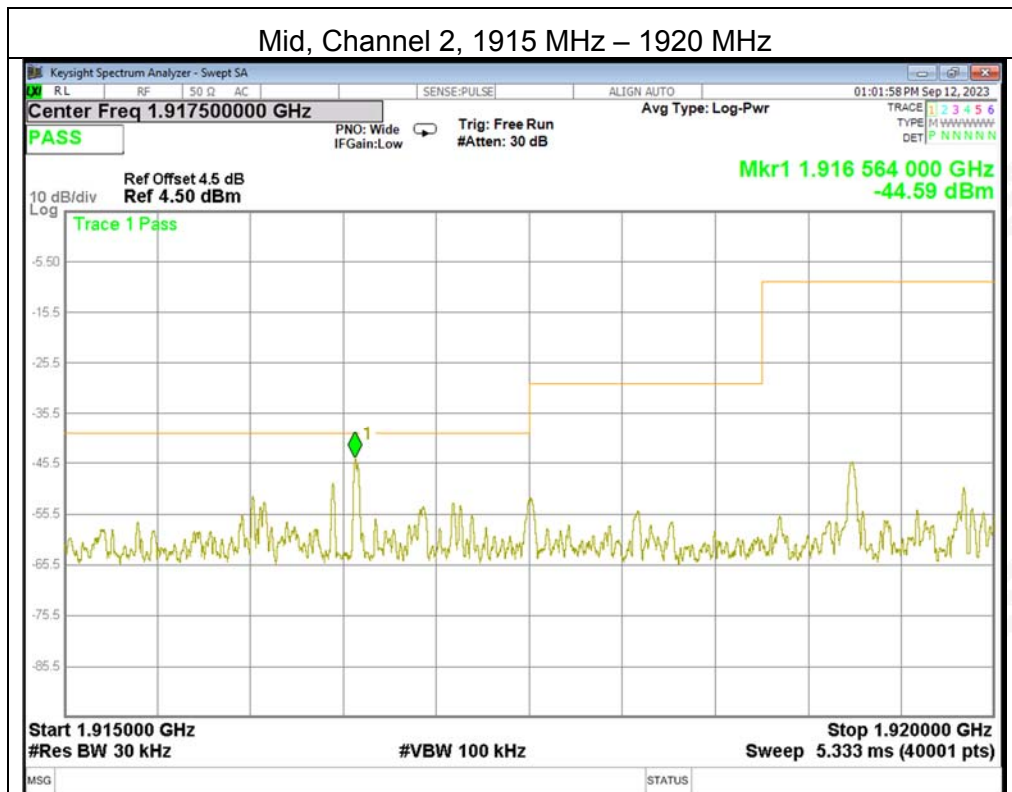
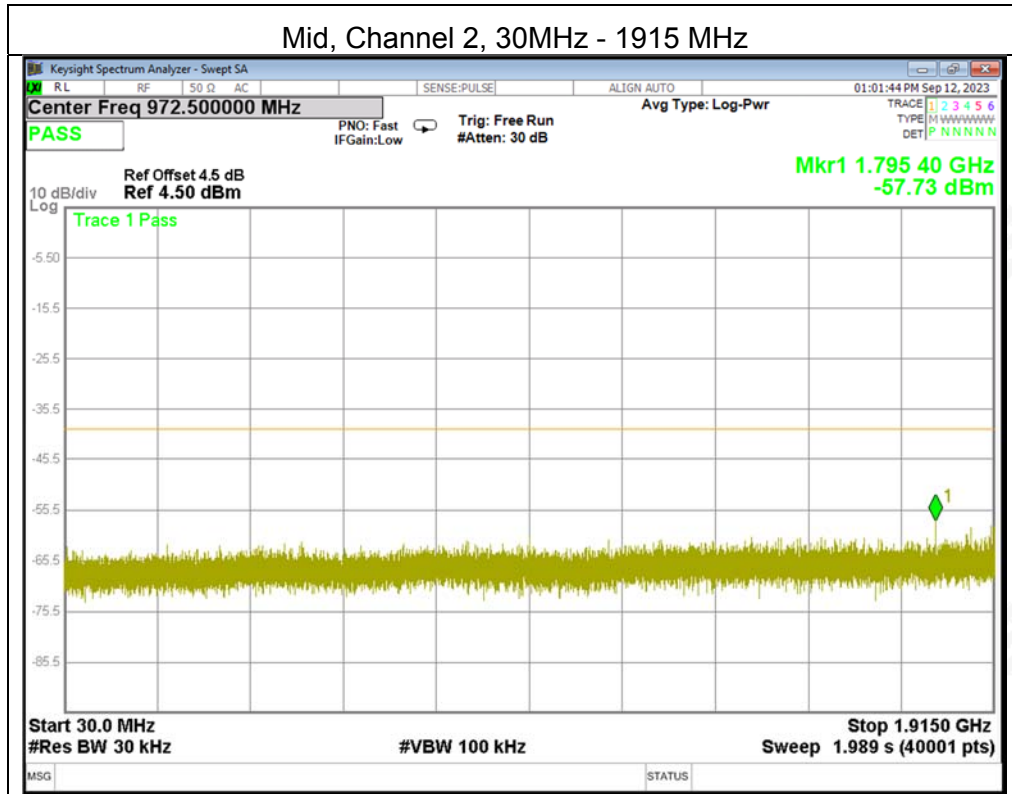



Mid, Channel 2, 1930 MHz – 1935 MHz

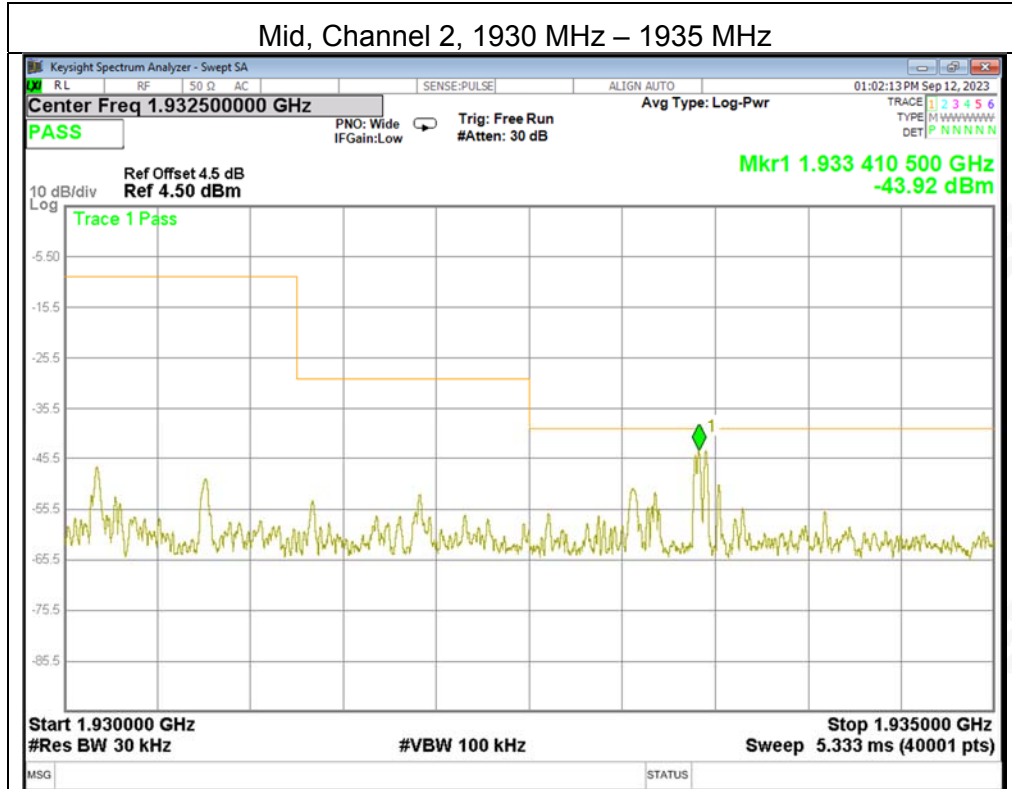

Mid, Channel 2, 1935 MHz – 20GHz

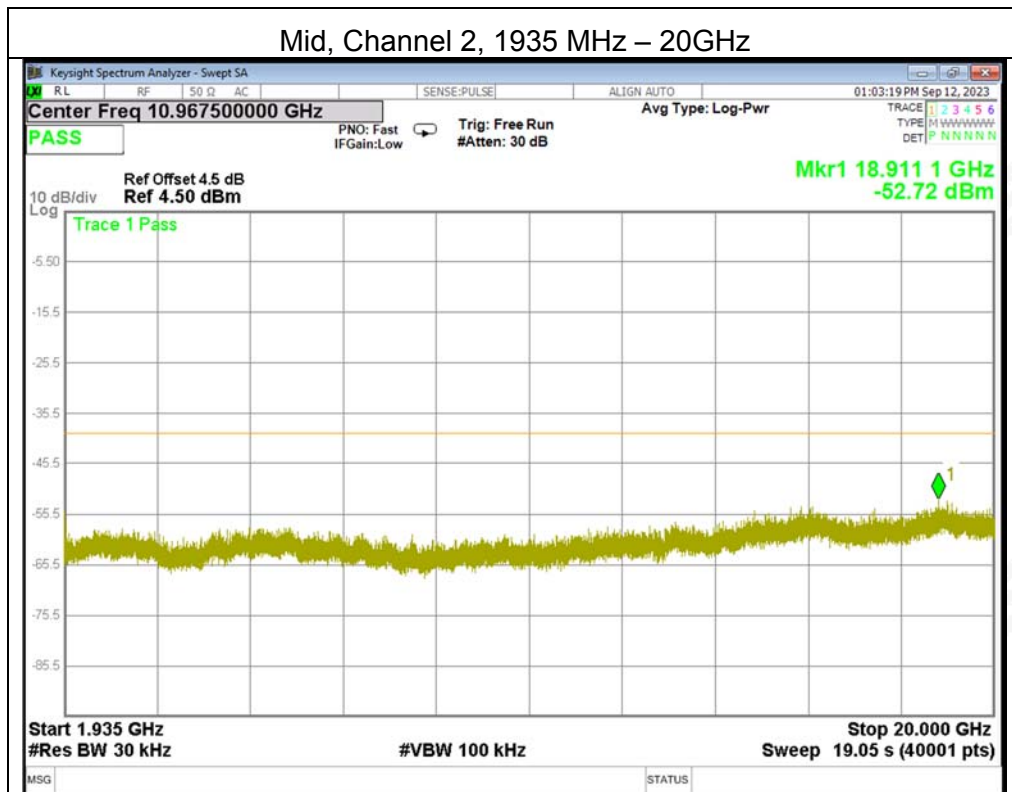

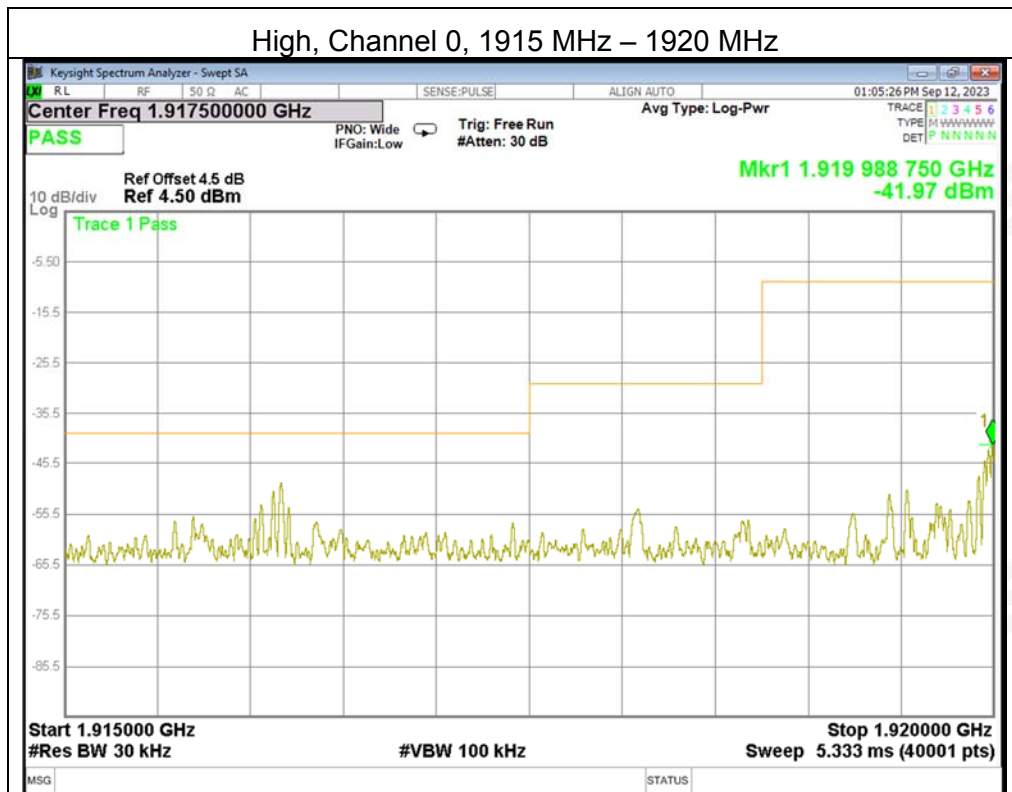
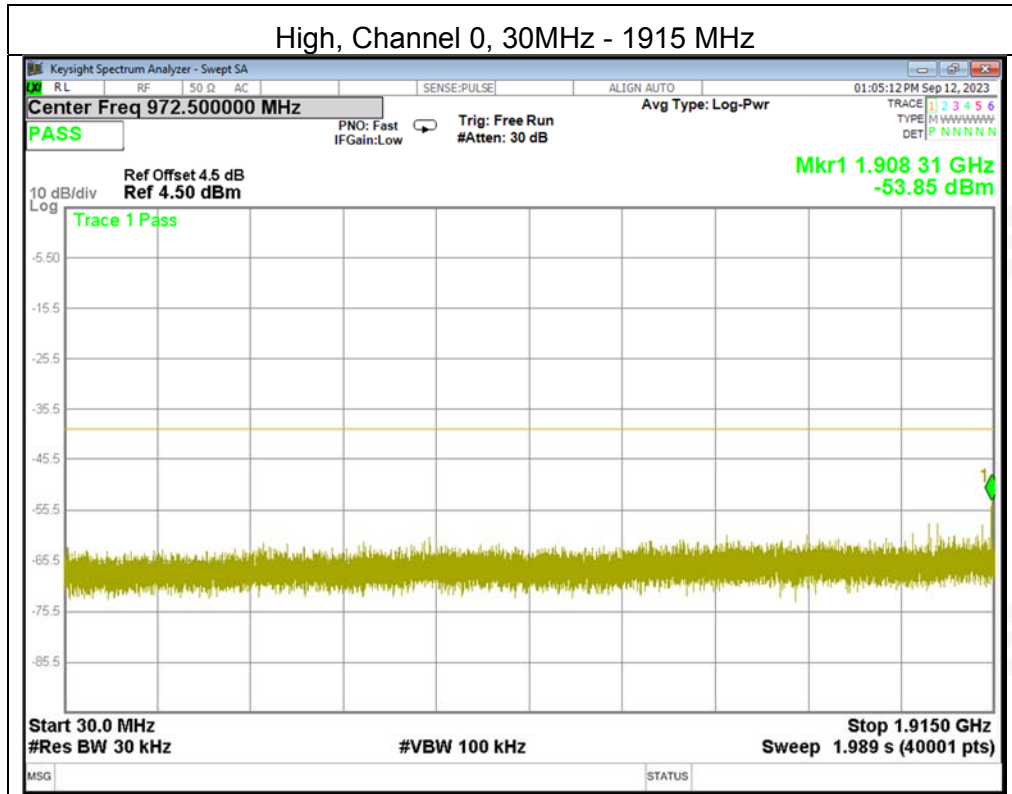



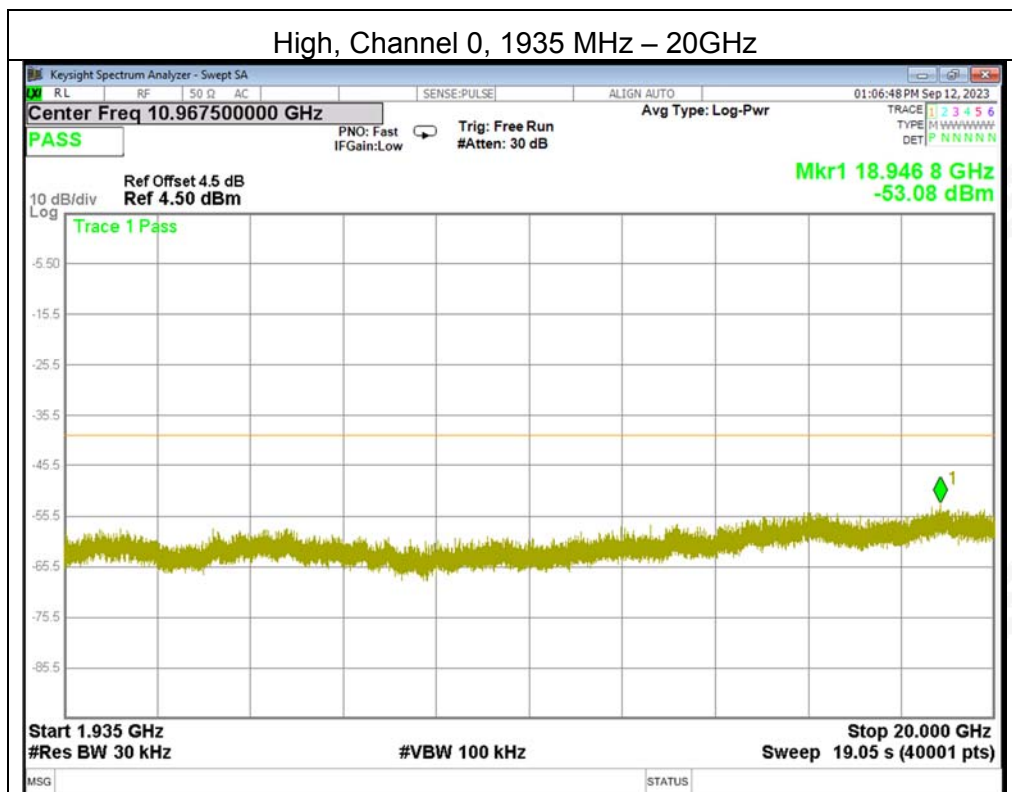
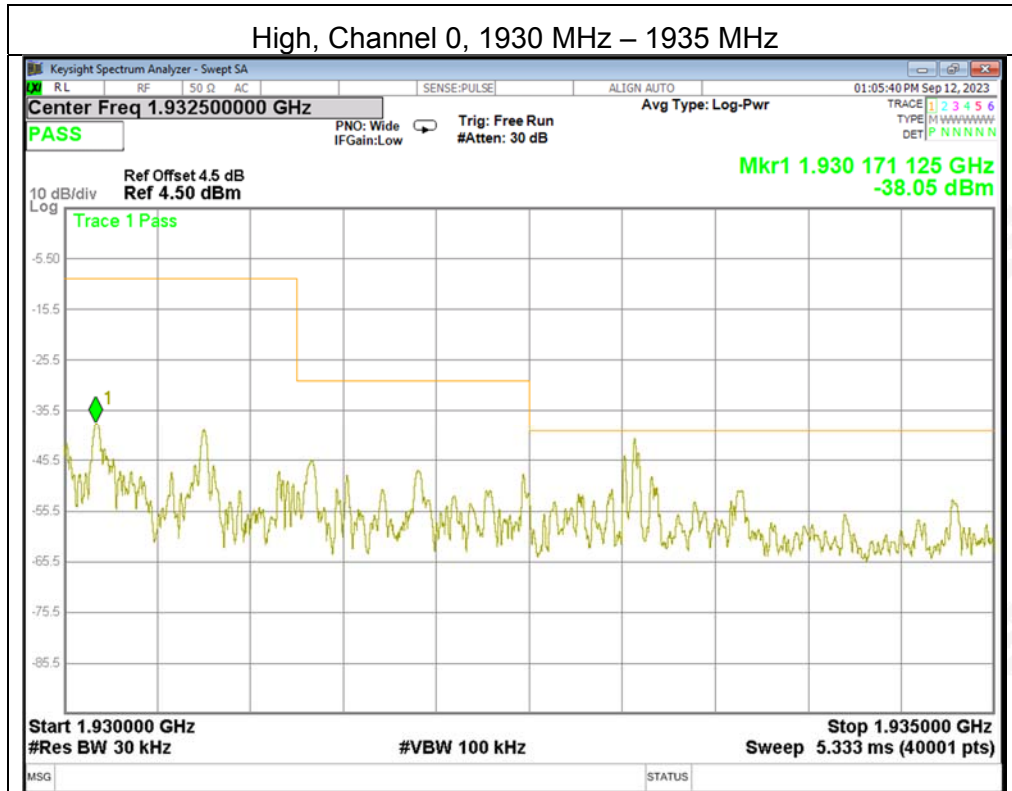

**5.19 FRAME PERIOD****TEST CRITERIA**

§15.323 (e) The frame period (a set of consecutive time slots in which the position of each time slot can be identified by reference to a synchronizing source) of an intentional radiator operating in these sub-bands shall be 20 milliseconds or 10 milliseconds/X where X is a positive whole number. Each device that implements time division for the purposes of maintaining a duplex connection on a given frequency carrier shall maintain a frame repetition rate with a frequency stability of at least 50 parts per million (ppm). Each device which further divides access in time in order to support multiple communication links on a given frequency carrier shall maintain a frame repetition rate with a frequency stability of at least 10 ppm.

**Timing Jitter**

§ 15.323 (e) Specific requirements for isochronous devices operating in the 1920–1930 MHz sub-band. The jitter (time-related, abrupt, spurious variations in the duration of the frame interval) introduced at the two ends of such a communication link shall not exceed 25 microseconds for any two consecutive transmissions. Transmissions shall be continuous in every time and spectrum window during the frame period defined for the device.

**TEST LIMIT**

Frame Period	20 or 10ms
Max Jitter	25µs
3 times St.Dev of Jitter	12.5µs

**TEST SETUP**

The test setup is shown in section 3.2 figure 2.

**TEST PROCEDURE**

The manufacturer supplies an attestation

**TEST RESULTS**

The Frame Repetition Stability is measured with the RF Test Platform for DECT. The Frame Repetition Stability is 3 times the standard deviation.

Channel	Standard Deviation(ppm)	Frame Repetition	The limit of Frame Repetition Stability(ppm)	Verdict
Middle	0.3484	1.0452	±10	Pass

Channel	Frame Period(ms)	Max Jitter(µs)	3xStandard Deviation of Jitter(µs)	Limit(µs)		Verdict
				Max Jitter	3 times St.Dev.of Jitter	
Middle	10.0000	-0.5000	1.0452	25	12.5	Pass

Max Jitter=  $(1/(\text{Frame Period} + \text{Pk-Pk})/2) - (1/\text{Frame Period})$ . When Pk-Pk and Frame period are in Hz.

3x St.Dev. Jitter  $3 \times (1/(\text{Frame Period} + \text{St. Dev})) - (1/\text{St.Dev}) \times 10^6$





## 5.20 FREQUENCY STABILITY

TEST CRITERIA

§15.323 (f) The frequency stability of the carrier frequency of the intentional radiator shall be maintained within  $\pm 10$ ppm over 1 hour or the interval between channel access monitoring, whichever is shorter. The frequency stability shall be maintained over a temperature variation of  $-20^{\circ}$  to  $+50^{\circ}$  C at normal supply voltage and over a variation in the primary supply voltage of 85% to 115% of the rated supply voltage at a temperature of 20 C. For equipment that is capable only of operating from a battery, the frequency stability tests shall be performed using a new battery without any further requirement to vary supply voltage.

TEST PROCEDURE

The EUT was placed in the Environmental Chamber and support equipment are outside the chamber on a table. A CW signal was injected into the EUT at the appropriate RF level. The frequency counter option on the Spectrum Analyzer was used to measure frequency deviations.

The frequency drift was investigated for every  $10^{\circ}$  C increment until the unit is stabilized then recorded the reading in tabular format with the temperature range of  $-20^{\circ}$  to  $+50^{\circ}$  C.

Voltage supplied to EUT is DC 3.8V reference temperature was done at  $20^{\circ}$  C. The voltage was varied by  $\pm 15\%$  of nominal

TEST SETUP

The test setup is shown in section 3.2 figure 1.

TEST RESULTS

The EUT was compliant with this requirement

Antenna 1

(Low Channel)					
Reference Frequency (MHz)	Voltage (V)	Temperature ( $^{\circ}$ C)	Frequency (MHz)	Deviation (ppm)	Limit (ppm)
1921.536	3	50	1921.52802	4.15	$\pm 10$
		40	1921.52817	4.07	
		30	1921.52424	6.12	
		20	1921.53733	-0.69	
		10	1921.53746	-0.76	
		0	1921.53636	-0.19	
		-10	1921.54840	-6.45	
		-20	1921.54723	-5.84	
	2.55	20	1921.54634	-5.38	
	3.45	20	1921.54756	-6.02	



(Mid Channel)					
Reference Frequency (MHz)	Voltage (V)	Temperature (°C)	Frequency (MHz)	Deviation (ppm)	Limit (ppm)
1924.992	3	50	1924.99527	-1.70	±10
		40	1924.99941	-3.85	
		30	1924.99300	-0.52	
		20	1924.99837	-3.31	
		10	1925.00286	-5.64	
		0	1925.00072	-4.53	
		-10	1924.98554	3.36	
		-20	1924.98464	3.82	
	2.55	20	1924.98672	2.74	
	3.45	20	1924.98823	1.96	

(High Channel)					
Reference Frequency (MHz)	Voltage (V)	Temperature (°C)	Frequency (MHz)	Deviation (ppm)	Limit (ppm)
1928.448	3	50	1928.44197	3.13	±10
		40	1928.44193	3.15	
		30	1928.44045	3.92	
		20	1928.44171	3.26	
		10	1928.45280	-2.49	
		0	1928.44690	0.57	
		-10	1928.44927	-0.66	
		-20	1928.45249	-2.33	
	2.55	20	1928.45236	-2.26	
	3.45	20	1928.45121	-1.66	



## Antenna 2

(Low Channel)					
Reference Frequency (MHz)	Voltage (V)	Temperature (°C)	Frequency (MHz)	Deviation (ppm)	Limit (ppm)
1921.536	3	50	1921.52546	5.49	±10
		40	1921.52506	5.69	
		30	1921.52704	4.66	
		20	1921.53792	-1.00	
		10	1921.53283	1.65	
		0	1921.54019	-2.18	
		-10	1921.54675	-5.59	
		-20	1921.55062	-7.61	
	2.55	20	1921.54845	-6.48	
	3.45	20	1921.54797	-6.23	

(Mid Channel)					
Reference Frequency (MHz)	Voltage (V)	Temperature (°C)	Frequency (MHz)	Deviation (ppm)	Limit (ppm)
1924.992	3	50	1924.99483	-1.47	±10
		40	1924.99677	-2.48	
		30	1924.99523	-1.68	
		20	1925.00124	-4.80	
		10	1925.00010	-4.21	
		0	1924.99876	-3.51	
		-10	1924.98938	1.36	
		-20	1924.98694	2.63	
	2.55	20	1924.98398	4.17	
	3.45	20	1924.98406	4.12	



(High Channel)					
Reference Frequency (MHz)	Voltage (V)	Temperature (°C)	Frequency (MHz)	Deviation (ppm)	Limit (ppm)
1928.448	3	50	1928.44461	1.76	±10
		40	1928.44584	1.12	
		30	1928.44489	1.61	
		20	1928.44017	4.06	
		10	1928.44678	0.63	
		0	1928.45278	-2.48	
		-10	1928.44504	1.53	
		-20	1928.45480	-3.53	
	2.55	20	1928.45360	-2.90	
	3.45	20	1928.45202	-2.08	

## 5.21 CONDUCTED EMISSION MEASUREMENT

### POWER LINE CONDUCTED EMISSION LIMITS

Operating frequency band. In case the emission fall within the restricted band specified on Part 207(a) limit in the table below has to be followed.

FREQUENCY (MHz)	Conducted Emission limit (dBuV)	
	Quasi-peak	Average
0.15 -0.5	66 - 56 *	56 - 46 *
0.50 -5.0	56.00	46.00
5.0 -30.0	60.00	50.00

Note:

- (1) The tighter limit applies at the band edges.
- (2) The limit of " \* " marked band means the limitation decreases linearly with the logarithm of the frequency in the range.

The following table is the setting of the receiver

Receiver Parameters	Setting
Attenuation	10 dB
Start Frequency	0.15 MHz
Stop Frequency	30 MHz
IF Bandwidth	9 kHz

TEST PROCEDURE

- a. The EUT was 0.8 meters from the horizontal ground plane and 0.4 meters from the vertical ground plane with EUT being connected to the power mains through a line impedance stabilization network (LISN). All other support equipments powered from additional LISN(s). The LISN provide 50 Ohm/ 50uH of coupling impedance for the measuring instrument.
- b. Interconnecting cables that hang closer than 40 cm to the ground plane shall be folded back and forth in the center forming a bundle 30 to 40 cm long.
- c. I/O cables that are not connected to a peripheral shall be bundled in the center. The end of the cable may be terminated, if required, using the correct terminating impedance. The overall length shall not exceed 1 m.
- d. LISN at least 80 cm from nearest part of EUT chassis.
- e. For the actual test configuration, please refer to the related Item –EUT Test Photos.

TEST SETUP

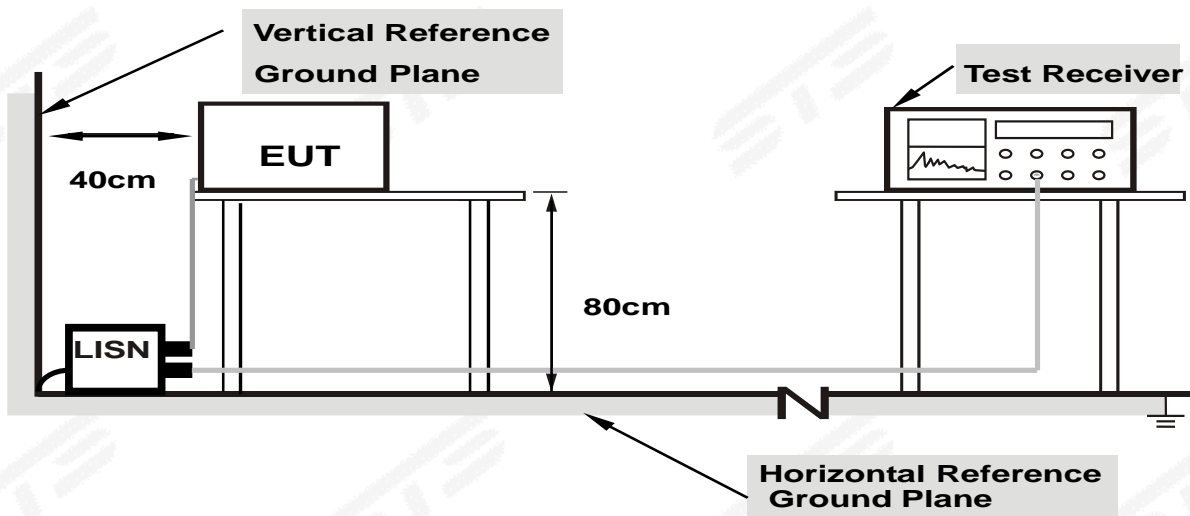

- Note: 1.Support units were connected to second LISN.**  
**2.Both of LISNs (AMN) are 80 cm from EUT and at least 80 cm from other units and other metal planes**

EUT OPERATING CONDITIONS

The EUT was configured for testing in a typical fashion (as a customer would normally use it). The EUT has been programmed to continuously transmit during test. This operating condition was tested and used to collect the included data.

TEST RESULTS

Temperature:	--(C)	Relative Humidity:	N/A
Test Voltage:	N/A	Phase:	N/A
Test Mode:	N/A		

Note: N/A



## 5.22 RADIATED SPURIOUS EMISSION RADIATED EMISSION LIMITS

In any 100 kHz bandwidth outside the operating frequency band. In case the emission fall within the Restricted band specified on Part15.205(a) limit in the table and according to ANSI C63.10-2013 below has to be followed.

### LIMITS OF RADIATED EMISSION MEASUREMENT (Frequency Range 9kHz-1000MHz)

Frequencies (MHz)	Field Strength (micorvolts/meter)	Measurement Distance (meters)
0.009~0.490	2400/F(KHz)	300
0.490~1.705	24000/F(KHz)	30
1.705~30.0	30	30
30~88	100	3
88~216	150	3
216~960	200	3
Above 960	500	3

### LIMITS OF RADIATED EMISSION MEASUREMENT (Above 1000MHz)

FREQUENCY (MHz)	(dBuV/m) (at 3M)	
	PEAK	AVERAGE
Above 1000	74	54

#### Notes:

- (1) The limit for radiated test was performed according to FCC PART 15C.
- (2) The tighter limit applies at the band edges.
- (3) Emission level (dBuV/m)=20log Emission level (uV/m).

#### For Radiated Emission

Spectrum Parameter	Setting
Attenuation	Auto
Detector	Peak/AV
Start Frequency	1000 MHz(Peak/AV)
Stop Frequency	10th carrier hamonic(Peak/AV)
RB / VB (emission in restricted band)	1 MHz / 3 MHz

Receiver Parameter	Setting
Start ~ Stop Frequency	9kHz~90kHz / RB 200Hz for PK & AV
Start ~ Stop Frequency	90kHz~110kHz / RB 200Hz for QP
Start ~ Stop Frequency	110kHz~490kHz / RB 200Hz for PK & AV
Start ~ Stop Frequency	490kHz~30MHz / RB 9kHz for QP
Start ~ Stop Frequency	30MHz~1000MHz / RB 120kHz for QP

## TEST PROCEDURE



- a. The measuring distance of at 3 m shall be used for measurements at frequency 0.009MHz up to 1GHz, and above 1GHz.
- b. The EUT was placed on the top of a rotating table 0.8 meters(above 1GHz is 1.5 m) above the ground at a 3 meter anechoic chamber. The table was rotated 360 degrees to determine the position of the highest radiation.
- c. The height of the equipment shall be 0.8 m(above 1GHz is 1.5 m); the height of the test antenna shall vary between 1 m to 4 m. Horizontal and vertical polarizations of the Antenna 1re set to make the measurement
- d. The initial step in collecting conducted emission data is a spectrum analyzer peak detector mode pre-scanning the measurement frequency range. Significant peaks are then marked and then Quasi Peak detector mode re-measured.
- e. If the Peak Mode measured value compliance with and lower than Quasi Peak Mode Limit, the EUT shall be deemed to meet QP Limits and then no additional QP Mode measurement performed.
- f. For the actual test configuration, please refer to the related Item –EUT Test Photos.

Note:

Both horizontal and vertical antenna polarities were tested and performed pretest to three orthogonal axis. The worst case emissions were reported.



TEST SETUP

(A) Radiated Emission Test-Up Frequency Below 30MHz

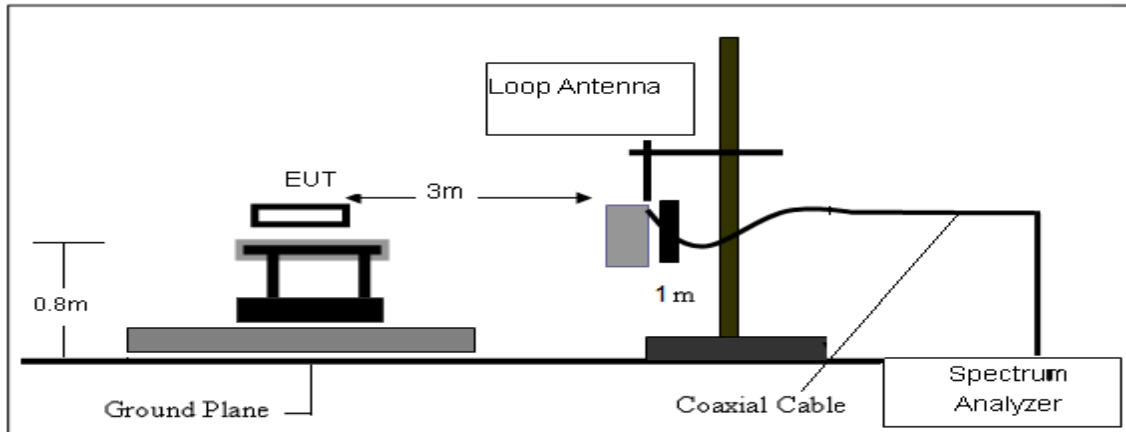

(B) Radiated Emission Test-Up Frequency 30MHz~1GHz

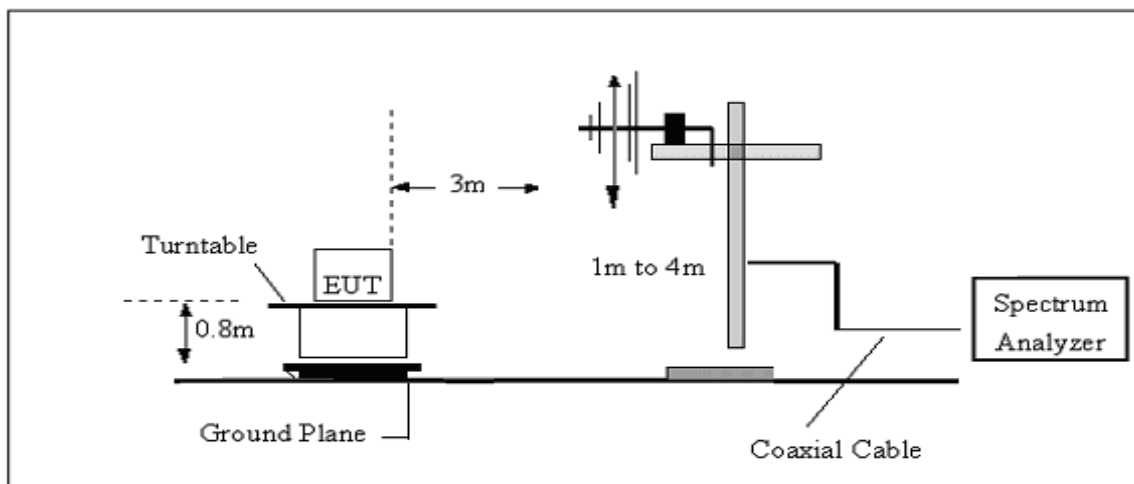

(C) Radiated Emission Test-Up Frequency Above 1GHz

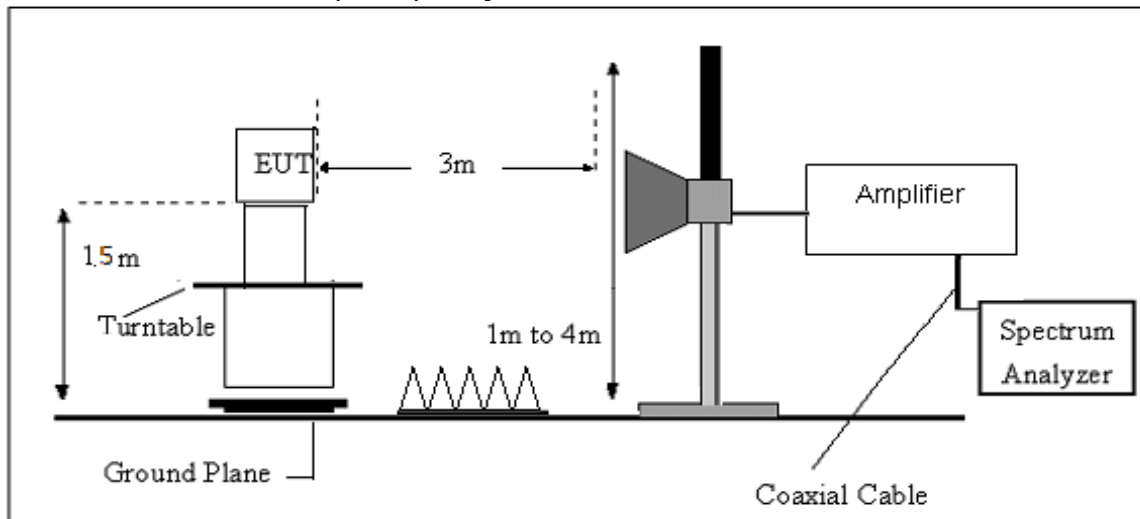

EUT OPERATING CONDITIONS

The EUT tested system was configured as the statements of 2.3 Unless otherwise a special operating condition is specified in the follows during the testing.



FIELD STRENGTH CALCULATION

The field strength is calculated by adding the Antenna Factor and Cable Factor and subtracting the Amplifier Gain and Duty Cycle Correction Factor (if any) from the measured reading. The basic equation with a sample calculation is as follows:

Margin=PL-PK L or AL- AV L; Margin only shown the worst case.

Where

PR = Peak Reading

AR = Average Reading

PL = Peak Level

AL = Average Level

AF = Antenna Factor

PK L = Peak Limit

AV L = AV Limit

For example

Frequency (MHz)	PR (dBμV/m)	AR (dBμV/m)	AF (dB)	PL (dBμV/m)	AL (dBμV/m)	PK L (dBμV/m)	AV L (dBμV/m)	Margin (dB)
2178	40.23	30.31	9.83	50.06	40.14	74.00	54.00	-13.86

Factor=AF+CL-AG



## TEST RESULTS(9KHz– 30MHz)

Temperature:	23.1(C)	Relative Humidity:	60%RH
Test Voltage:	DC 3V	Polarization:	--
Test Mode:	TX Mode		

Freq. (MHz)	Reading (dBuV/m)	Limit (dBuV/m)	Margin (dB)	State P/F
--	--	--	--	PASS
--	--	--	--	PASS

## Note:

The amplitude of spurious emissions which are attenuated by more than 20dB below the permissible value has no need to be reported.

Distance extrapolation factor =  $40 \log(\text{specific distance}/\text{test distance})$ (dB);

Limit line = specific limits(dBuV) + distance extrapolation factor.

TEST RESULTS(30MHz – 1GHz)

Temperature:	23.1(C)	Relative Humidity:	60%RH
Test Voltage:	DC 3V	Phase:	Horizontal
Test Mode:	TX Mode of ANT 1		

80.0 dBuV/m

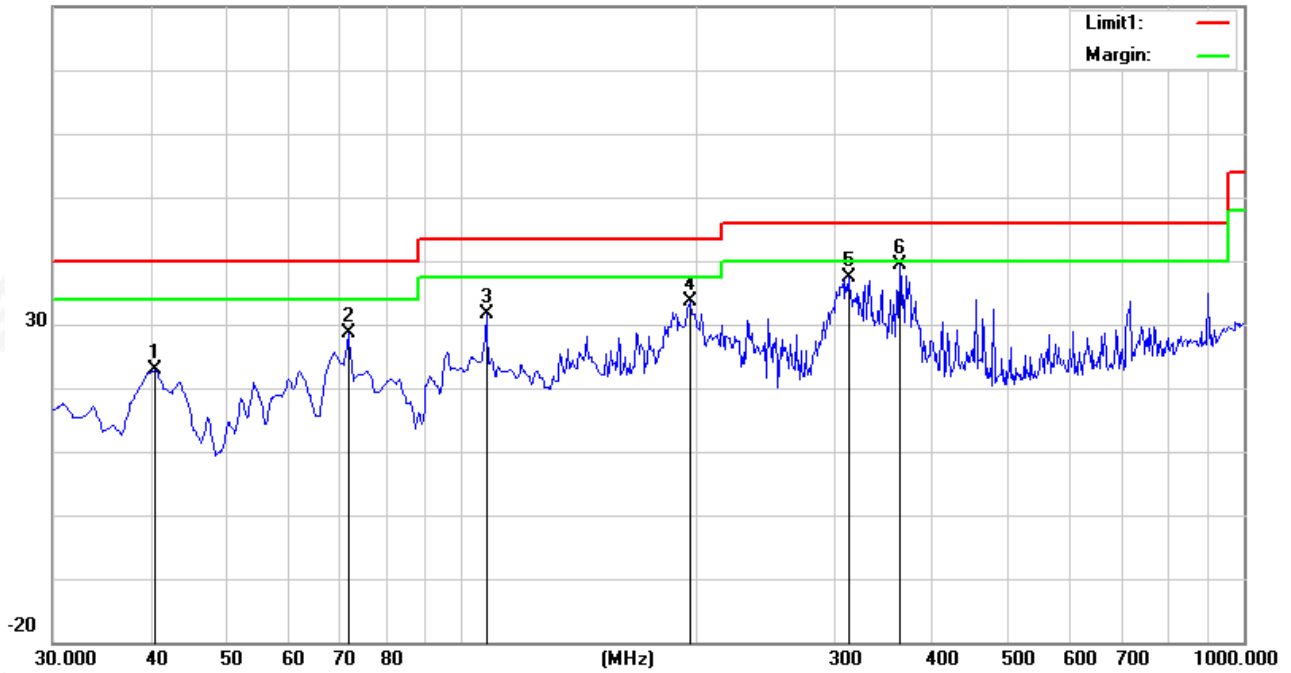

No.	Frequency (MHz)	Reading (dBuV)	Correct Factor(dB/m)	Result (dBuV/m)	Limit (dBuV/m)	Margin (dB)	Remark
1	40.6700	41.18	-18.40	22.78	40.00	-17.22	peak
2	71.7100	53.19	-24.56	28.63	40.00	-11.37	peak
3	107.6000	50.85	-19.32	31.53	43.50	-11.97	peak
4	195.8700	54.80	-21.14	33.66	43.50	-9.84	peak
5	313.2400	51.67	-14.31	37.36	46.00	-8.64	peak
6	363.6800	52.22	-12.73	39.49	46.00	-6.51	peak



Temperature:	23.1(C)	Relative Humidity:	60%RH
Test Voltage:	DC 3V	Phase:	Vertical
Test Mode:	TX Mode of ANT 1		

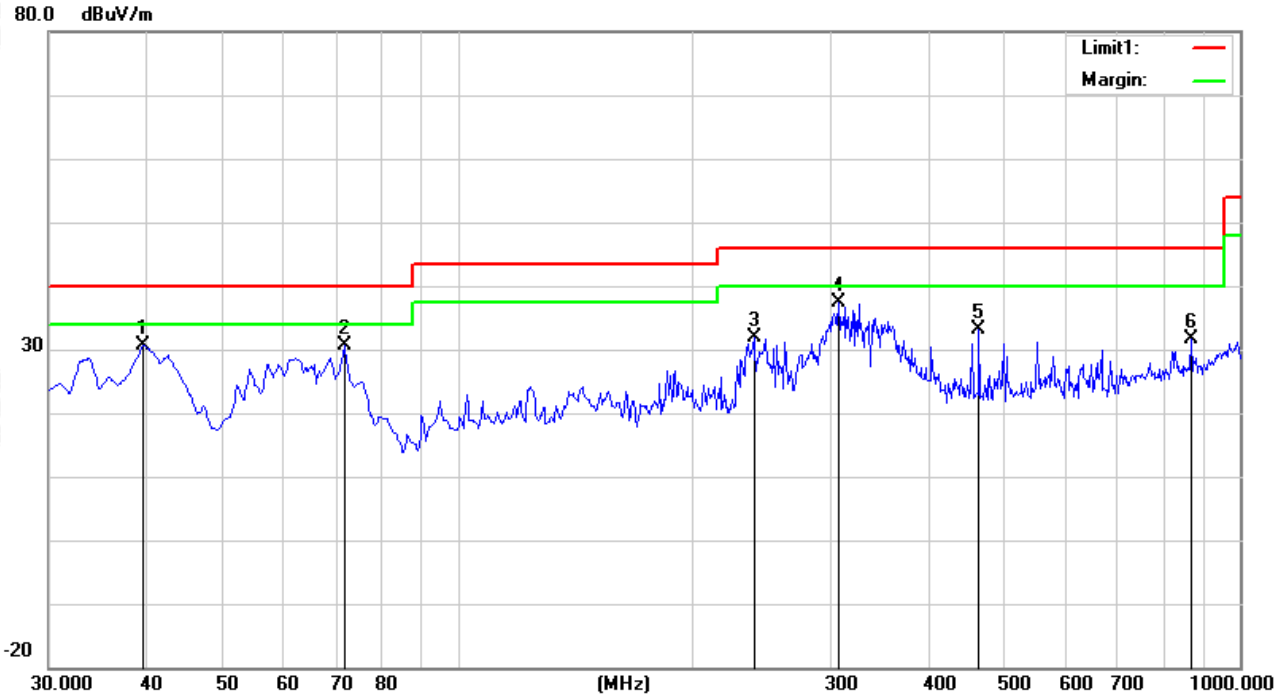

No.	Frequency (MHz)	Reading (dBuV)	Correct Factor(dB/m)	Result (dBuV/m)	Limit (dBuV/m)	Margin (dB)	Remark
1	39.7000	48.60	-17.88	30.72	40.00	-9.28	peak
2	71.7100	55.21	-24.56	30.65	40.00	-9.35	peak
3	239.5200	49.90	-18.10	31.80	46.00	-14.20	peak
4	307.4200	51.86	-14.55	37.31	46.00	-8.69	peak
5	464.5600	42.27	-9.25	33.02	46.00	-12.98	peak
6	869.0500	32.19	-0.52	31.67	46.00	-14.33	peak



Temperature:	23.1(C)	Relative Humidity:	60%RH
Test Voltage:	DC 3V	Phase:	Horizontal
Test Mode:	TX Mode of ANT 2		

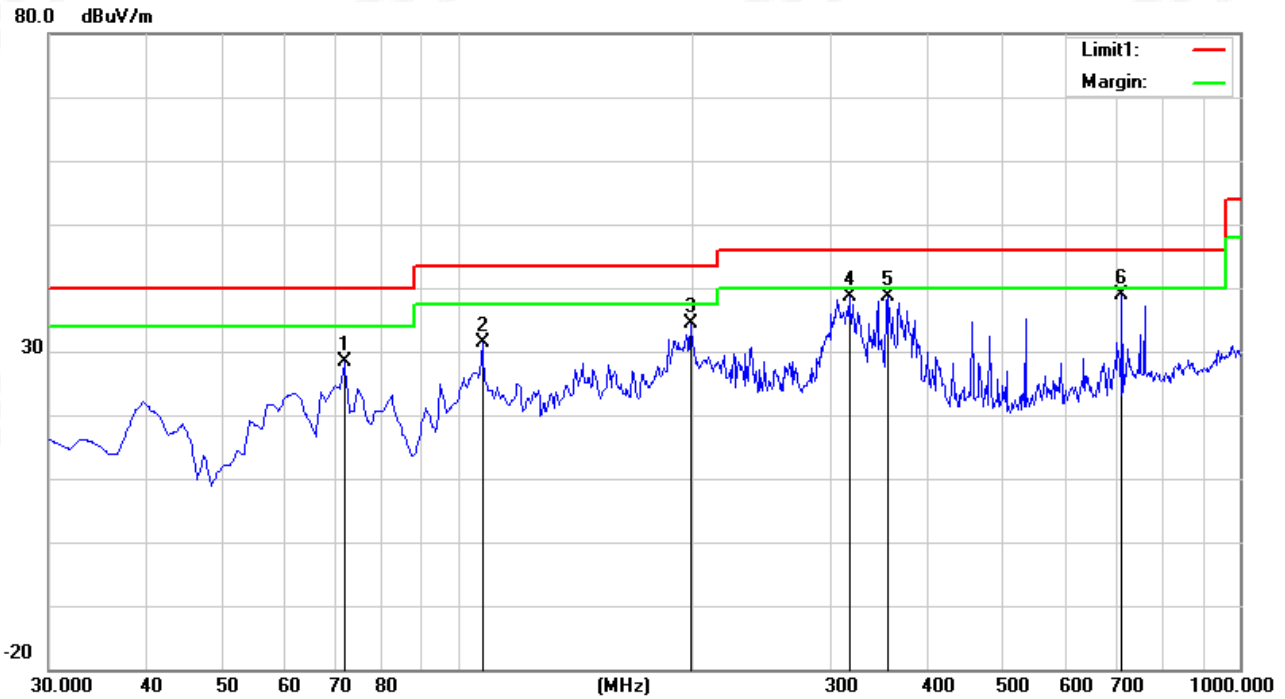

No.	Frequency (MHz)	Reading (dBuV)	Correct Factor(dB/m)	Result (dBuV/m)	Limit (dBuV/m)	Margin (dB)	Remark
1	71.7100	52.90	-24.56	28.34	40.00	-11.66	peak
2	107.6000	50.82	-19.32	31.50	43.50	-12.00	peak
3	198.7800	55.57	-21.12	34.45	43.50	-9.05	peak
4	317.1200	52.89	-14.14	38.75	46.00	-7.25	peak
5	354.9500	51.69	-12.97	38.72	46.00	-7.28	peak
6	707.0600	42.71	-3.94	38.77	46.00	-7.23	peak



Temperature:	23.1(C)	Relative Humidity:	60%RH
Test Voltage:	DC 3V	Phase:	Vertical
Test Mode:	TX Mode of ANT 2		

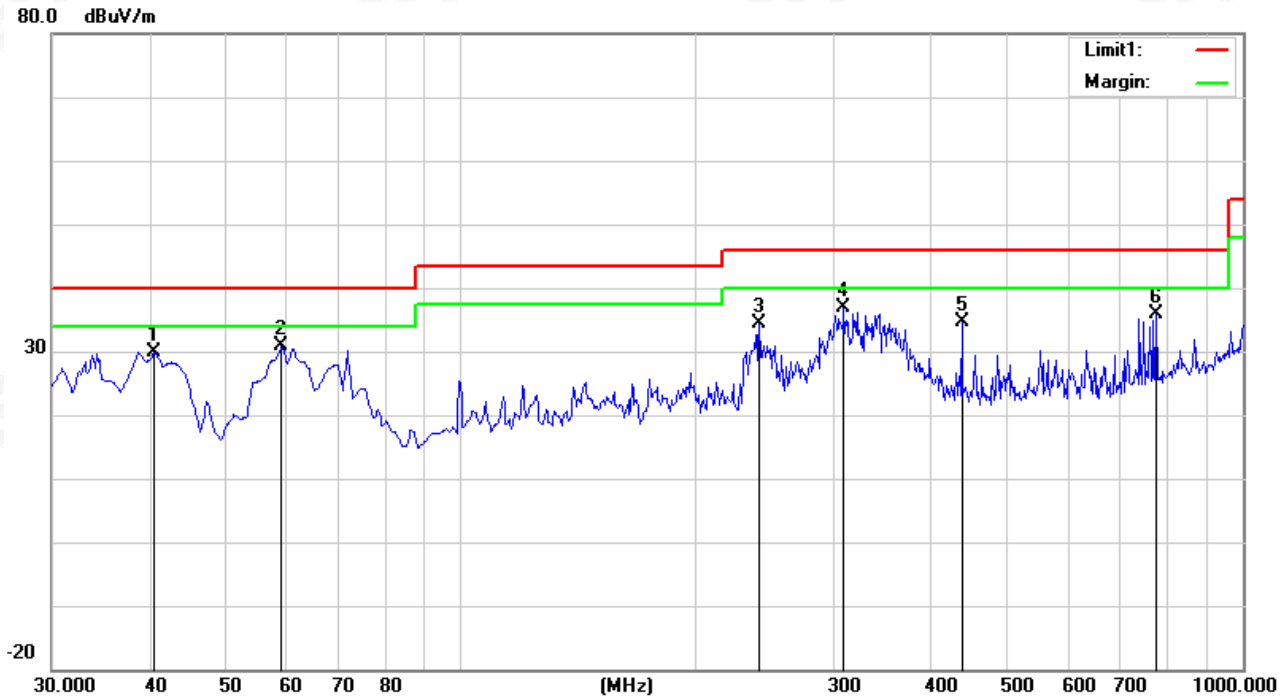

No.	Frequency (MHz)	Reading (dBuV)	Correct Factor(dB/m)	Result (dBuV/m)	Limit (dBuV/m)	Margin (dB)	Remark
1	40.6700	48.24	-18.40	29.84	40.00	-10.16	peak
2	59.1000	56.63	-25.73	30.90	40.00	-9.10	peak
3	241.4600	52.03	-17.73	34.30	46.00	-11.70	peak
4	309.3600	51.41	-14.48	36.93	46.00	-9.07	peak
5	437.4000	44.65	-10.10	34.55	46.00	-11.45	peak
6	774.9600	38.09	-2.28	35.81	46.00	-10.19	peak

TEST RESULTS(Above 1GHz)

**GFSK-Low-ANT 1**

Horizontal

RE\_FCC Test Case\_FCC 15C 1GHz-18GHz

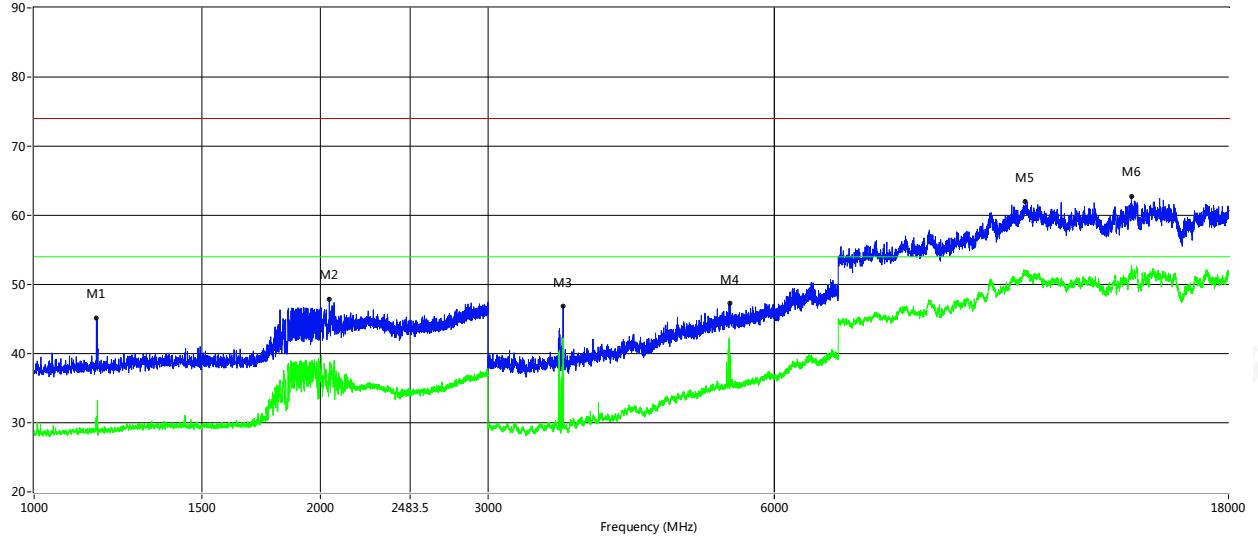

Frequency (MHz)	Peak Level (dBuV/m)	Q-peak Level (dBuV/m)	Average Level (dBuV/m)	Factor (dB)	PK Limit (dBuV/m)	QP Limit (dBuV/m)	AV Limit (dBuV/m)	Over Limit (dB)	ANT	Verdict
1163.000	45.17	--	30.89	-1.34	74.0	--	54.0	-23.11	Horizontal	Pass
2043.000	47.80	--	35.31	2.64	74.0	--	54.0	-18.69	Horizontal	Pass
3598.000	46.88	--	40.52	-12.00	74.0	--	54.0	-13.48	Horizontal	Pass
5386.000	47.28	--	39.83	-4.79	74.0	--	54.0	-14.17	Horizontal	Pass
11012.250	61.98	--	51.92	10.15	74.0	--	54.0	-2.08	Horizontal	Pass
14235.250	62.75	--	52.16	11.33	74.0	--	54.0	-1.84	Horizontal	Pass





Vertical

RE\_FCC Test Case\_FCC 15C 1GHz-18GHz

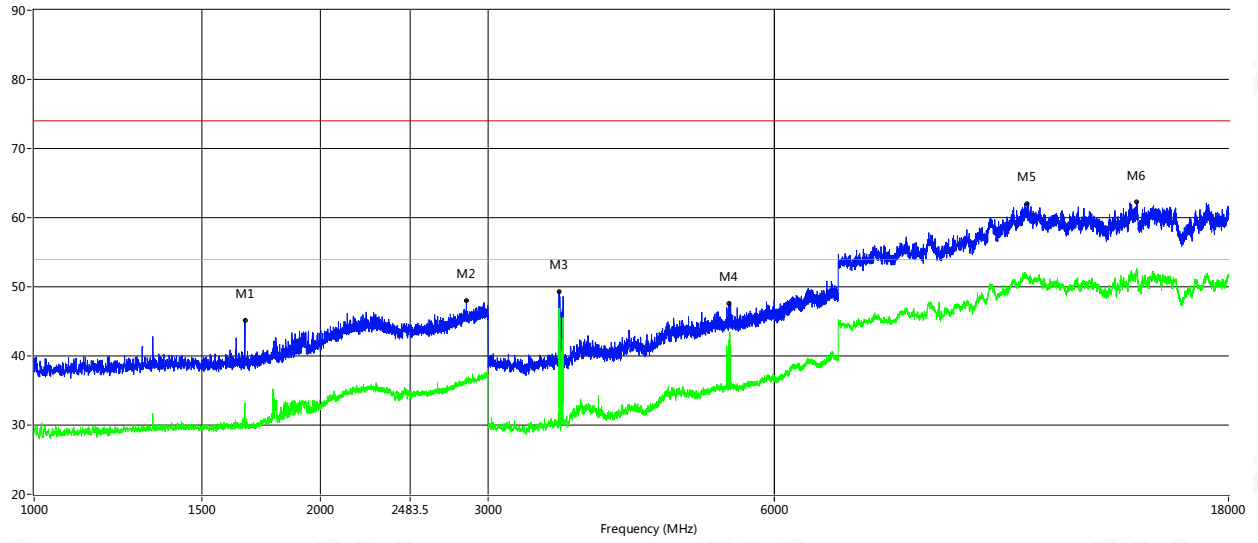

Frequency (MHz)	Peak Level (dBuV/m)	Q-peak Level (dBuV/m)	Average Level (dBuV/m)	Factor (dB)	PK Limit (dBuV/m)	QP Limit (dBuV/m)	AV Limit (dBuV/m)	Over Limit (dB)	ANT	Verdict
1665.500	45.12	--	33.22	-0.49	74.0	--	54.0	-20.78	Vertical	Pass
2847.000	48.05	--	36.58	5.59	74.0	--	54.0	-17.42	Vertical	Pass
3563.000	49.32	--	46.88	-11.79	74.0	--	54.0	-7.12	Vertical	Pass
5376.000	47.51	--	42.35	-4.81	74.0	--	54.0	-11.65	Vertical	Pass
11075.500	62.13	--	51.16	9.81	74.0	--	54.0	-2.84	Vertical	Pass
14411.250	62.24	--	52.11	11.29	74.0	--	54.0	-1.89	Vertical	Pass



**GFSK-Mid-ANT 1**  
Horizontal

RE\_FCC Test Case\_FCC 15C 1GHz-18GHz

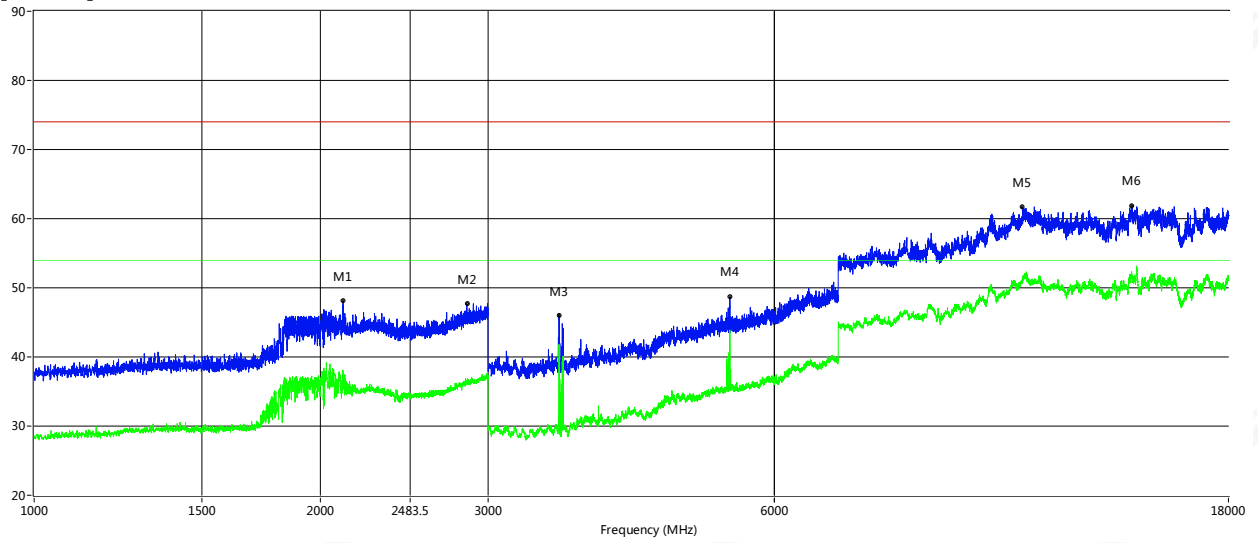

Frequency (MHz)	Peak Level (dBuV/m)	Q-peak Level (dBuV/m)	Average Level (dBuV/m)	Factor (dB)	PK Limit (dBuV/m)	QP Limit (dBuV/m)	AV Limit (dBuV/m)	Over Limit (dB)	ANT	Verdict
2112.500	48.12	--	37.29	4.00	74.0	--	54.0	-16.71	Horizontal	Pass
2850.500	47.71	--	36.46	5.61	74.0	--	54.0	-17.54	Horizontal	Pass
3563.000	46.03	--	41.79	-11.79	74.0	--	54.0	-12.21	Horizontal	Pass
5386.000	48.67	--	43.88	-4.79	74.0	--	54.0	-10.12	Horizontal	Pass
2112.500	48.12	--	37.29	4.00	74.0	--	54.0	-16.71	Horizontal	Pass
2850.500	47.71	--	36.46	5.61	74.0	--	54.0	-17.54	Horizontal	Pass



Vertical

RE\_FCC Test Case\_FCC 15C 1GHz-18GHz

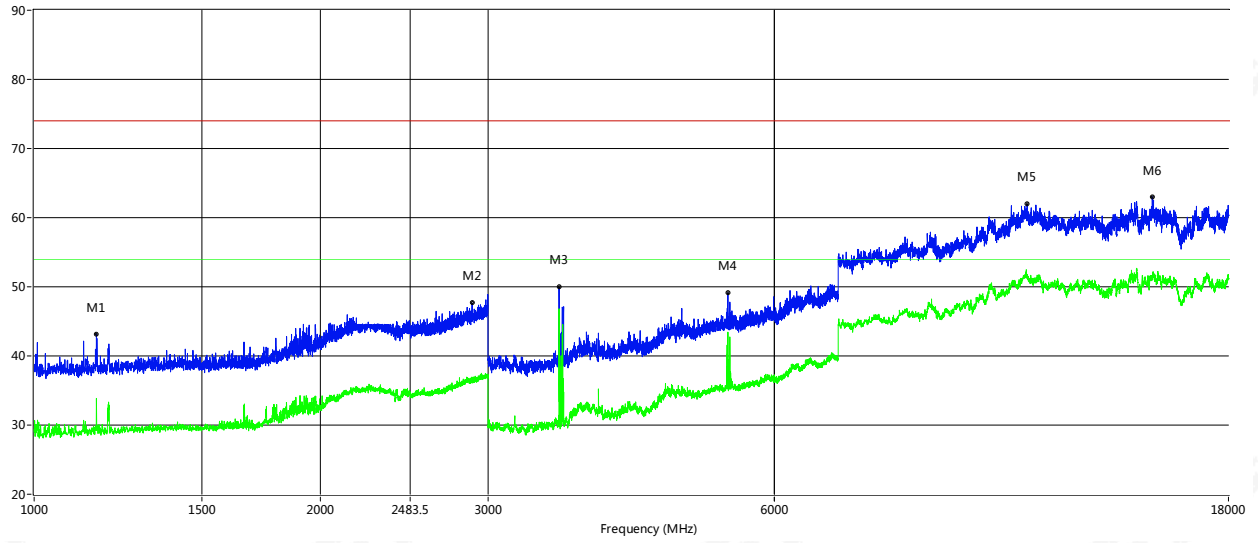

Frequency (MHz)	Peak Level (dBuV/m)	Q-peak Level (dBuV/m)	Average Level (dBuV/m)	Factor (dB)	PK Limit (dBuV/m)	QP Limit (dBuV/m)	AV Limit (dBuV/m)	Over Limit (dB)	ANT	Verdict
1163.000	43.15	--	33.86	-1.34	74.0	--	54.0	-20.14	Vertical	Pass
2886.000	47.65	--	36.23	5.61	74.0	--	54.0	-17.77	Vertical	Pass
3563.000	49.94	--	46.83	-11.79	74.0	--	54.0	-7.17	Vertical	Pass
5360.000	49.14	--	43.44	-4.85	74.0	--	54.0	-10.56	Vertical	Pass
11059.000	61.93	--	51.48	9.90	74.0	--	54.0	-2.52	Vertical	Pass
14972.250	63.02	--	51.56	10.26	74.0	--	54.0	-2.44	Vertical	Pass

**GFSK-High-ANT 1**  
Horizontal

RE\_FCC Test Case\_FCC 15C 1GHz-18GHz

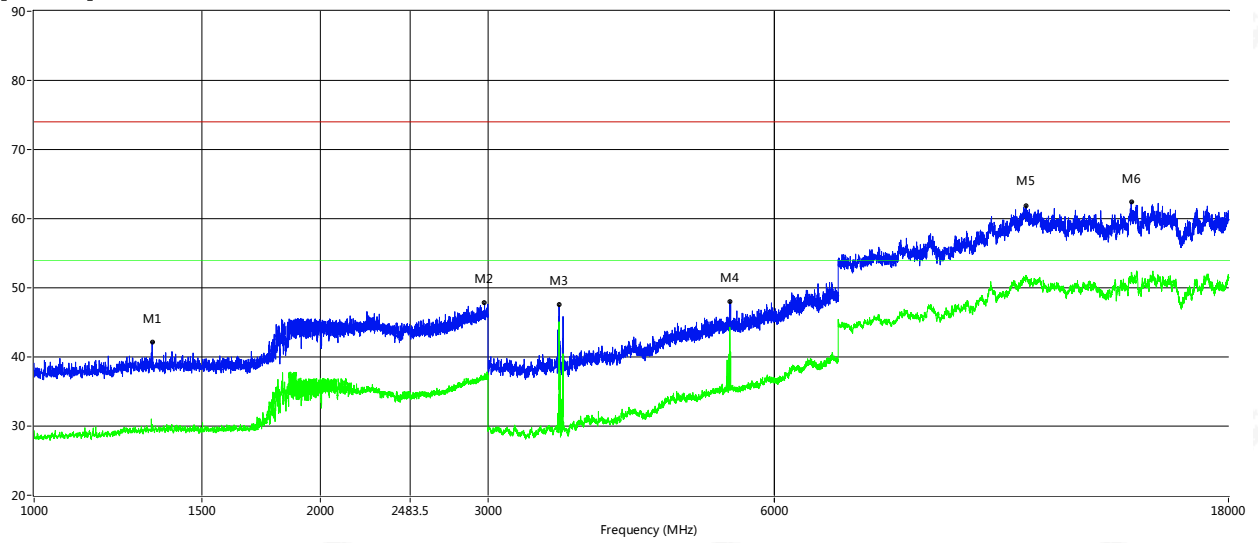

Frequency (MHz)	Peak Level (dBuV/m)	Q-peak Level (dBuV/m)	Average Level (dBuV/m)	Factor (dB)	PK Limit (dBuV/m)	QP Limit (dBuV/m)	AV Limit (dBuV/m)	Over Limit (dB)	ANT	Verdict
1330.500	42.15	--	30.20	-0.85	74.0	--	54.0	-23.80	Horizontal	Pass
2975.000	47.79	--	36.68	6.00	74.0	--	54.0	-17.32	Horizontal	Pass
3563.000	47.51	--	45.08	-11.79	74.0	--	54.0	-8.92	Horizontal	Pass
5386.000	48.06	--	44.28	-4.79	74.0	--	54.0	-9.72	Horizontal	Pass
11031.500	61.88	--	51.77	10.05	74.0	--	54.0	-2.23	Horizontal	Pass
14227.000	62.43	--	51.79	11.39	74.0	--	54.0	-2.21	Horizontal	Pass



Vertical

RE\_FCC Test Case\_FCC 15C 1GHz-18GHz

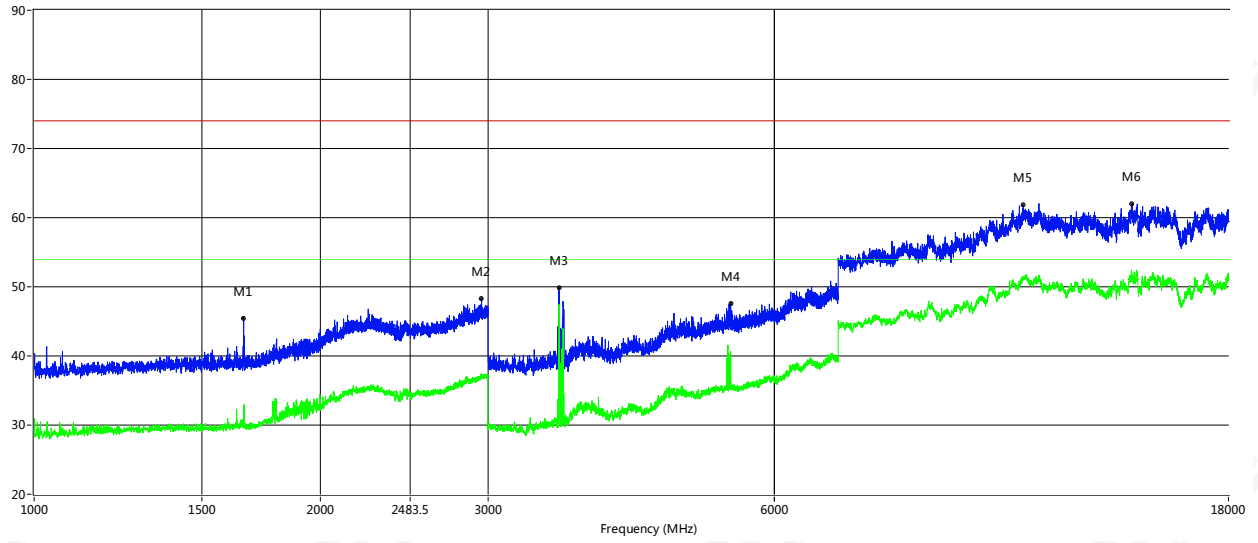

Frequency (MHz)	Peak Level (dBuV/m)	Q-peak Level (dBuV/m)	Average Level (dBuV/m)	Factor (dB)	PK Limit (dBuV/m)	QP Limit (dBuV/m)	AV Limit (dBuV/m)	Over Limit (dB)	ANT	Verdict
1660.500	45.39	--	32.78	-0.49	74.0	--	54.0	-21.22	Vertical	Pass
2954.000	48.27	--	36.70	5.91	74.0	--	54.0	-17.30	Vertical	Pass
3560.000	49.87	--	39.95	-11.77	74.0	--	54.0	-14.05	Vertical	Pass
5397.000	47.60	--	40.68	-4.76	74.0	--	54.0	-13.32	Vertical	Pass
10957.250	61.83	--	51.22	9.89	74.0	--	54.0	-2.78	Vertical	Pass
14260.000	61.99	--	51.70	11.13	74.0	--	54.0	-2.30	Vertical	Pass

**GFSK-Low-ANT 2**  
Horizontal

RE\_FCC Test Case\_FCC 15C 1GHz-18GHz

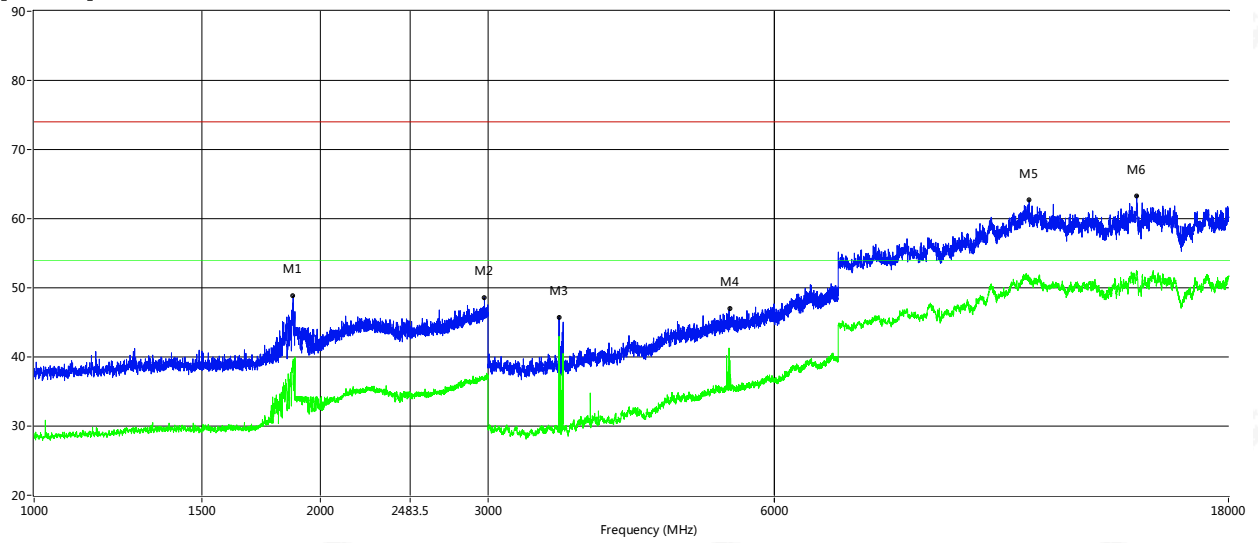

Frequency (MHz)	Peak Level (dBuV/m)	Q-peak Level (dBuV/m)	Average Level (dBuV/m)	Factor (dB)	PK Limit (dBuV/m)	QP Limit (dBuV/m)	AV Limit (dBuV/m)	Over Limit (dB)	ANT	Verdict
1871.500	48.83	--	39.35	0.81	74.0	--	54.0	-14.65	Horizontal	Pass
2974.500	48.60	--	37.06	6.00	74.0	--	54.0	-16.94	Horizontal	Pass
3563.000	45.73	--	42.99	-11.79	74.0	--	54.0	-11.01	Horizontal	Pass
5381.000	46.99	--	39.97	-4.80	74.0	--	54.0	-14.03	Horizontal	Pass
11114.000	62.66	--	51.08	9.67	74.0	--	54.0	-2.92	Horizontal	Pass
14416.750	63.35	--	52.32	11.23	74.0	--	54.0	-1.68	Horizontal	Pass



Vertical

RE\_FCC Test Case\_FCC 15C 1GHz-18GHz

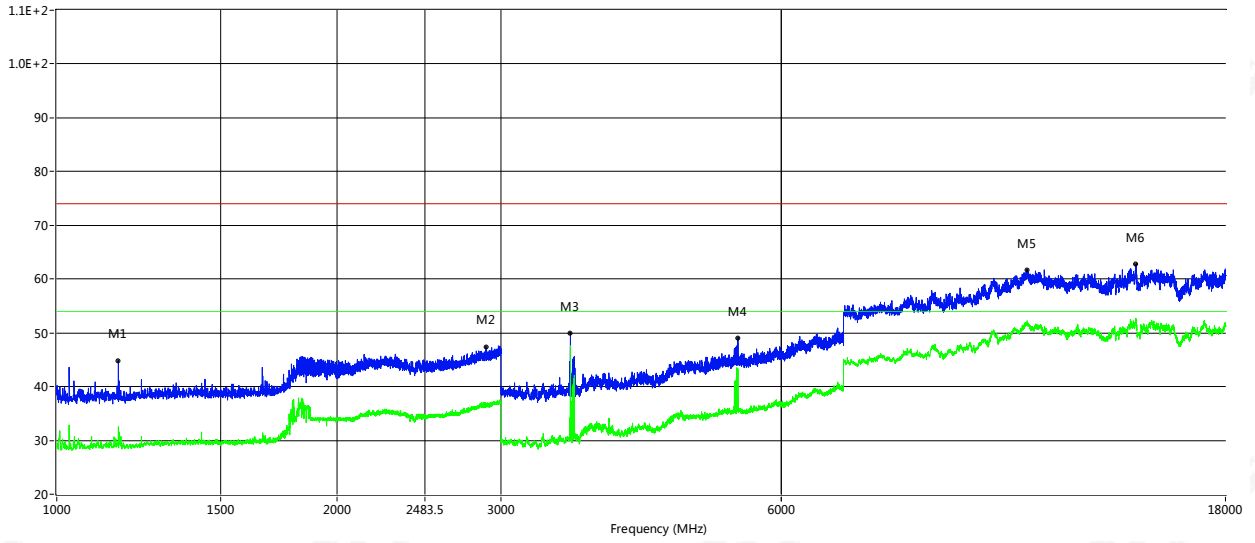

Frequency (MHz)	Peak Level (dBuV/m)	Q-peak Level (dBuV/m)	Average Level (dBuV/m)	Factor (dB)	PK Limit (dBuV/m)	QP Limit (dBuV/m)	AV Limit (dBuV/m)	Over Limit (dB)	ANT	Verdict
1164.500	44.86	--	32.54	-1.33	74.0	--	54.0	-21.46	Vertical	Pass
2892.000	47.31	--	36.31	5.61	74.0	--	54.0	-17.69	Vertical	Pass
3563.000	49.93	--	47.62	-11.79	74.0	--	54.0	-6.38	Vertical	Pass
5391.000	49.05	--	43.36	-4.77	74.0	--	54.0	-10.64	Vertical	Pass
11028.750	61.72	--	52.04	10.06	74.0	--	54.0	-1.96	Vertical	Pass
14416.750	62.71	--	52.66	11.23	74.0	--	54.0	-1.34	Vertical	Pass

**GFSK-Mid-ANT 2**  
Horizontal

RE\_FCC Test Case\_FCC 15C 1GHz-18GHz

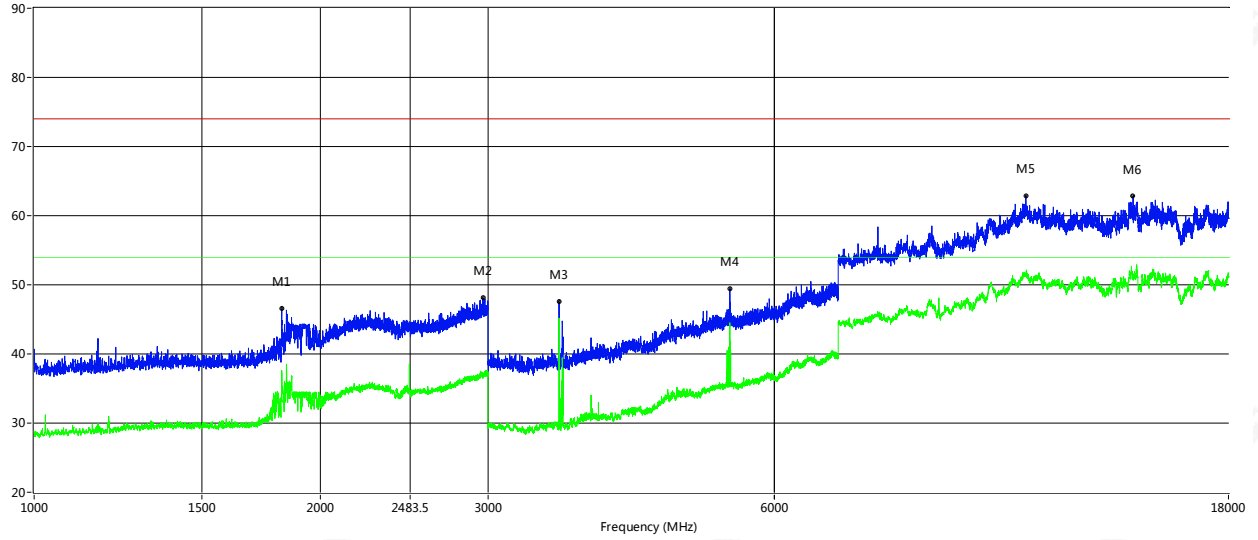

Frequency (MHz)	Peak Level (dBuV/m)	Q-peak Level (dBuV/m)	Average Level (dBuV/m)	Factor (dB)	PK Limit (dBuV/m)	QP Limit (dBuV/m)	AV Limit (dBuV/m)	Over Limit (dB)	ANT	Verdict
1821.000	46.55	--	37.61	0.28	74.0	--	54.0	-16.39	Horizontal	Pass
2963.500	48.09	--	36.70	5.95	74.0	--	54.0	-17.30	Horizontal	Pass
3563.000	47.57	--	45.18	-11.79	74.0	--	54.0	-8.82	Horizontal	Pass
5386.000	49.39	--	44.49	-4.79	74.0	--	54.0	-9.51	Horizontal	Pass
11026.000	62.88	--	51.63	10.08	74.0	--	54.0	-2.37	Horizontal	Pass
14290.250	62.79	--	50.74	10.90	74.0	--	54.0	-3.26	Horizontal	Pass





Vertical

RE\_FCC Test Case\_FCC 15C 1GHz-18GHz

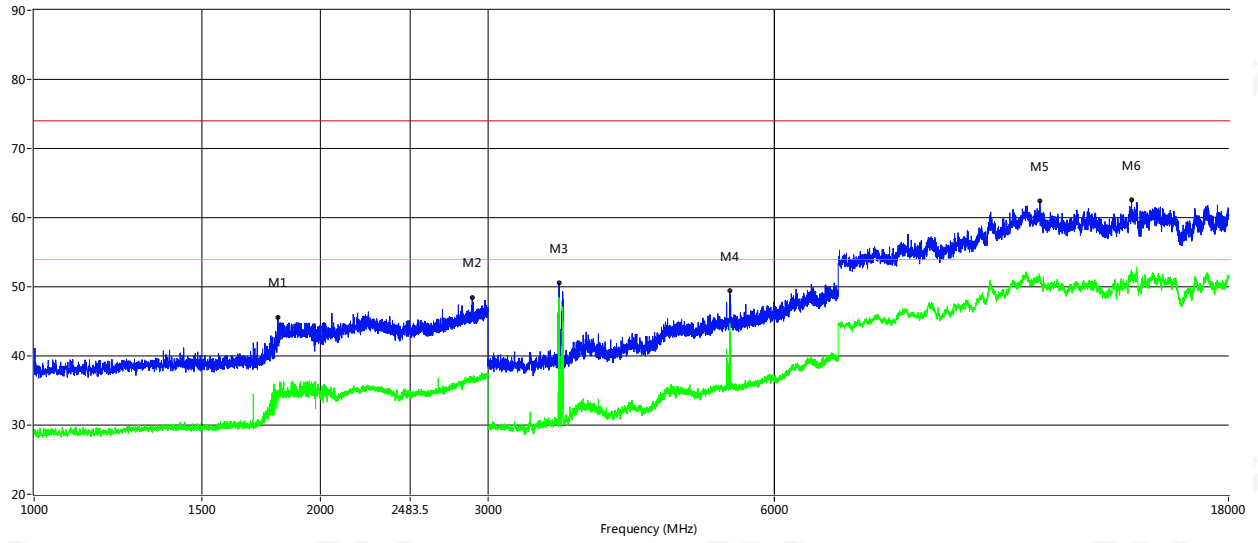

Frequency (MHz)	Peak Level (dBuV/m)	Q-peak Level (dBuV/m)	Average Level (dBuV/m)	Factor (dB)	PK Limit (dBuV/m)	QP Limit (dBuV/m)	AV Limit (dBuV/m)	Over Limit (dB)	ANT	Verdict
1798.500	49.85	--	33.67	-0.09	74.0	--	54.0	-20.33	Vertical	Pass
2887.500	48.41	--	36.92	5.61	74.0	--	54.0	-17.08	Vertical	Pass
3563.000	50.52	--	48.43	-11.79	74.0	--	54.0	-5.57	Vertical	Pass
5386.000	49.38	--	44.66	-4.79	74.0	--	54.0	-9.34	Vertical	Pass
11408.250	62.43	--	50.95	9.76	74.0	--	54.0	-3.05	Vertical	Pass
14240.750	62.58	--	52.16	11.28	74.0	--	54.0	-1.84	Vertical	Pass

**GFSK-High-ANT 2**  
Horizontal

RE\_FCC Test Case\_FCC 15C 1GHz-18GHz

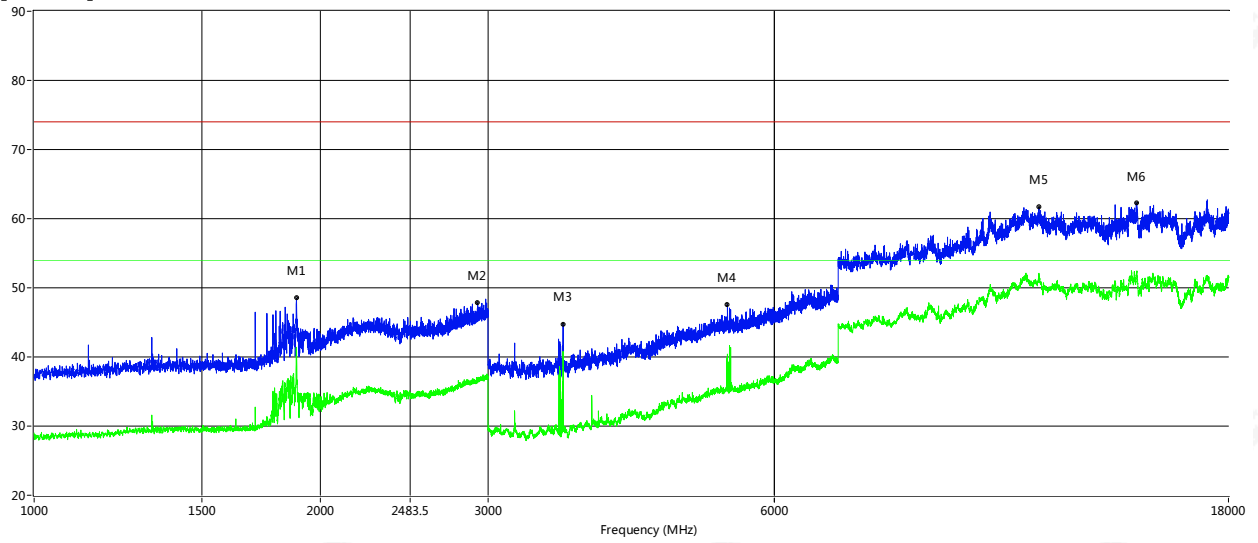

Frequency (MHz)	Peak Level (dBuV/m)	Q-peak Level (dBuV/m)	Average Level (dBuV/m)	Factor (dB)	PK Limit (dBuV/m)	QP Limit (dBuV/m)	AV Limit (dBuV/m)	Over Limit (dB)	ANT	Verdict
1887.000	48.51	--	40.35	0.82	74.0	--	54.0	-13.65	Horizontal	Pass
2925.500	47.84	--	36.29	5.76	74.0	--	54.0	-17.71	Horizontal	Pass
3598.000	44.70	--	39.02	-12.00	74.0	--	54.0	-14.98	Horizontal	Pass
5355.000	47.55	--	40.41	-4.87	74.0	--	54.0	-13.59	Horizontal	Pass
11380.750	61.68	--	52.11	9.70	74.0	--	54.0	-1.89	Horizontal	Pass
14403.000	62.29	--	51.65	11.39	74.0	--	54.0	-2.35	Horizontal	Pass



Vertical

RE\_FCC Test Case\_FCC 15C 1GHz-18GHz

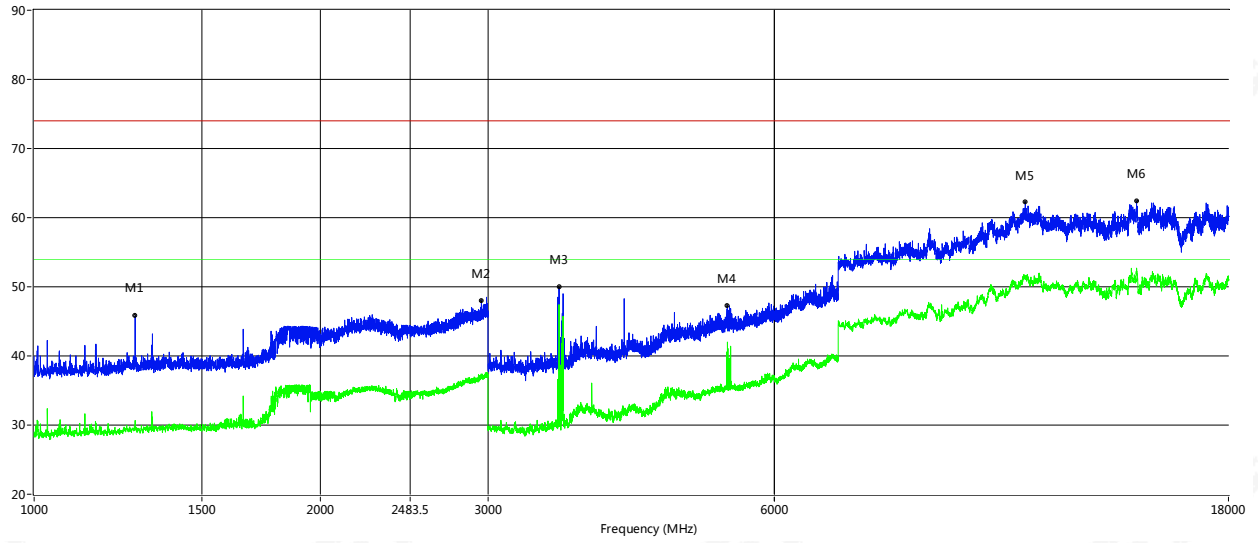

Frequency (MHz)	Peak Level (dBuV/m)	Q-peak Level (dBuV/m)	Average Level (dBuV/m)	Factor (dB)	PK Limit (dBuV/m)	QP Limit (dBuV/m)	AV Limit (dBuV/m)	Over Limit (dB)	ANT	Verdict
1277.000	45.79	--	30.67	-0.92	74.0	--	54.0	-23.33	Vertical	Pass
2952.500	48.02	--	36.79	5.91	74.0	--	54.0	-17.21	Vertical	Pass
3563.000	49.95	--	47.44	-11.79	74.0	--	54.0	-6.56	Vertical	Pass
5355.000	47.30	--	42.01	-4.87	74.0	--	54.0	-11.99	Vertical	Pass
11009.500	62.29	--	51.17	10.17	74.0	--	54.0	-2.83	Vertical	Pass
14411.250	62.44	--	52.22	11.29	74.0	--	54.0	-1.78	Vertical	Pass



**APENDIX BPHOTOS OF TEST SETUP**

Note: See test photos in setup photo document for the actual connections between Product and support equipment.

\*\*\*\*\* END OF THE REPORT \*\*\*\*\*