

AirLine 88

Headset Wireless System



Samson Technologies
45 Gilpin Avenue
Hauppauge, New York 11788-8816
Phone: 1-800-3-SAMSON (1-800-372-6766)
Fax: 631-784-2201
www.samsontech.com

OWNER'S MANUAL

SAMSON®

Important Safety Information



CAUTION: TO REDUCE THE RISK OF ELECTRIC SHOCK, DO NOT REMOVE COVER (OR BACK). NO USER-SERVICEABLE PARTS INSIDE. REFER SERVICING TO QUALIFIED SERVICE PERSONNEL.

ATTENTION
RISQUE D'ÉLECTROCUTION !
NE PAS OUVRIR !



This lightning flash with arrowhead symbol within an equilateral triangle is intended to alert the user to the presence of non-insulated "dangerous voltage" within the product's enclosure that may be of sufficient magnitude to constitute a risk of electric shock.



The exclamation point within an equilateral triangle is intended to alert the user to the presence of important operating and maintenance instructions in the literature accompanying the appliance.

WARNING

TO PREVENT FIRE OR SHOCK HAZARD. DO NOT USE THIS PLUG WITH AN EXTENSION CORD, RECEPTACLE OR OTHER OUTLET UNLESS THE BLADES CAN BE FULLY INSERTED TO PREVENT BLADE EXPOSURE. TO PREVENT FIRE OR SHOCK HAZARD. DO NOT EXPOSE THIS APPLIANCE TO RAIN OR MOISTURE. TO PREVENT ELECTRICAL SHOCK, MATCH WIDE BLADE PLUG TO WIDE SLOT AND FULLY INSERT.

Specifications

System

| | |
|--------------------------|--------------------------------|
| Working Range | 300' (100m) line of sight |
| Audio Frequency Response | 50 Hz - 15 kHz |
| T.H.D. (Overall) | <1% (@AF 1 kHz, RF 46 dBu) |
| Dynamic Range | >100 dB A-weighted |
| Signal to Noise | >90 dB |
| Operating Temperature | -10°C (14°F) to +60°C (+140°F) |
| Tone Key Frequency | 32.768 kHz |

AH8 Headset Microphone Transmitter

| | |
|--------------------------|---|
| Microphone Element | Condenser Mic |
| Microphone Polar Pattern | Unidirectional |
| Input Gain Range | 20dB |
| Power Requirements | 3.6V500mA/h, Lithium Ion rechargeable battery |
| Battery Life | 6 hours |
| Dimensions (LxWxH) | 5.9" x 6.7" x 3.9" 150mm x 170mm x 100mm (Depending on the shape of headset arm and gooseneck mic) |
| Weight | 0.13lb / 60g |

CR88 Receiver

| | |
|-------------------------------------|--|
| Audio Output Level - Unbalanced | +14 dBu |
| Audio Output Level - Balanced | +9 dBu |
| Audio Output Impedance - Unbalanced | 810 Ohms |
| Audio Output Impedance - Balanced | 240 Ohms |
| Sensitivity | -100 dBm / 30 dB sinad |
| Image Rejection | >50 dB |
| Operating Voltage | 15 VDC 200mA |
| Dimensions (LxWxH) | 8.25" x 4.9" x 1.75" 210mm x 125mm x 44mm |
| Weight | 0.85lb / 388g |

At Samson, we are continually improving our products, therefore specifications and images are subject to change without notice.

Channel Plans

| Group K 470-494 MHz | | Group D** 542-566 MHz | | Group G* 863-865 MHz | |
|------------------------|---------|--------------------------|---------|-------------------------|---------|
| Ch | Freq | Ch | Freq | Ch | Freq |
| 0 | 470.125 | 0 | 542.125 | 0 | 863.050 |
| 1 | 471.625 | 1 | 543.625 | 1 | 863.250 |
| 2 | 473.050 | 2 | 545.050 | 2 | 863.550 |
| 3 | 474.425 | 3 | 546.425 | 3 | 863.750 |
| 4 | 474.900 | 4 | 546.900 | 4 | 864.050 |
| 5 | 477.525 | 5 | 549.525 | 5 | 864.250 |
| 6 | 479.100 | 6 | 551.100 | 6 | 864.550 |
| 7 | 480.475 | 7 | 552.475 | 7 | 864.750 |
| 8 | 482.000 | 8 | 554.000 | 8 | 864.950 |
| 9 | 484.075 | 9 | 556.075 | | |
| A | 486.975 | A | 558.975 | | |
| B | 487.975 | B | 559.975 | | |
| C | 489.050 | C | 561.050 | | |
| D | 490.975 | D | 562.975 | | |
| E | 492.425 | E | 564.425 | | |
| F | 493.975 | F | 565.975 | | |

* Not for use in the USA and Canada.

** Not for use in the EU.

For questions regarding available channels in your area contact your local Samson distributor.

Important Safety Information

1. Read these instructions.
2. Keep these instructions.
3. Heed all warnings.
4. Follow all instructions.
5. Do not use this apparatus near water.
6. Clean only with dry cloth.
7. Do not block any ventilation openings. Install in accordance with the manufacturer's instructions.
8. Do not install near any heat sources such as radiators, heat registers, stoves, or other apparatus (including amplifiers) that produce heat.
9. Do not defeat the safety purpose of the polarized or grounding type plug. A polarized plug has two blades with one wider than the other. A grounding type plug has two blades and a third grounding prong. The wide blade or the third prong are provided for your safety. If the provided plug does not fit into your outlet, consult an electrician for replacement of the obsolete outlet.
10. Protect the power cord from being walked on or pinched particularly at the plugs, convenience receptacles, and at the point where they exit from the apparatus.
11. Only use attachments/accessories specified by the manufacturer.
12. Use only with the cart, stand, tripod, bracket, or table specified by the manufacturer, or sold with the apparatus. When a cart is used, use caution when moving the cart/apparatus combination to avoid injury from tip-over.
13. Unplug the apparatus during lightening storms, or when unused for long periods of time.
14. Refer all servicing to qualified personnel. Service is required when the apparatus has been damaged in any way, such as power supply cord or plug is damaged, liquid has been spilled or objects have fallen into the apparatus has been exposed to rain or moisture, does not operate normally, or has been dropped.
15. This appliance shall not be exposed to dripping or splashing water and that no object filled with liquid such as vases shall be placed on the apparatus.
16. Caution-to prevent electrical shock, match wide blade plug wide slot fully insert.
17. Please keep a good ventilation environment around the entire unit.
18. The direct plug-in adapter is used as disconnect device, the disconnect device shall remain readily operable.
19. Batteries (battery pack or batteries installed) shall not be exposed to excessive heat such as sunshine, fire or the like.



If you want to dispose this product, do not mix it with general household waste. There is a separate collection system for used electronic products in accordance with legislation that requires proper treatment, recovery and recycling.

Private household in the 28 member states of the EU, in Switzerland and Norway may return their used electronic products free of charge to designated collection facilities or to a retailer (if you purchase a similar new one).

For Countries not mentioned above, please contact your local authorities for a correct method of disposal.

By doing so you will ensure that your disposed product undergoes the necessary treatment, recovery and recycling and thus prevent potential negative effects on the environment and human health.

Important Safety Information

FCC Rules and Regulations

Samson wireless receivers are certified under FCC Rules part 15 and transmitters are certified under FCC Rules part 74.

Licensing of Samson equipment is the user's responsibility and licensability depends on the user's classification, application and frequency selected.

This device complies with Part 15 of the FCC rules Class B and RSS-210 of Industry & Science Canada.

Operation is subject to the following two conditions:

- (1) This device must not cause harmful interference, and
- (2) This device must accept any interference received including interference that may cause undesired operation. Suitable for home or office use.

NOTE: This equipment has been tested and found to comply with the limits for a Class B digital device, pursuant to Part 15 of the FCC Rules. These limits are designed to provide reasonable protection against harmful interference in a residential installation. This equipment generates, uses and can radiate radio frequency energy and, if not installed and used in accordance with the instructions, may cause harmful interference to radio communications. However, there is no guarantee that interference will not occur in a particular installation. If this equipment does cause harmful interference to radio or television reception, which can be determined by turning the equipment off and on, the user is encouraged to try to correct the interference by one or more of the following measures:

- Reorient or relocate the receiving antenna.
- Increase the separation between the equipment and receiver.
- Connect the equipment into an outlet on a circuit different from that to which the receiver is connected.
- Consult the dealer or an experienced Radio/TV technician for help.

WARNING: Changes or modifications not expressly approved by the party responsible for compliance could void the user's authority to operate the equipment.

This equipment is intended for use in wireless microphone applications.

Equipment is intended for sale in: AT, BE, CH, CY, CZ*, DK, EE, FI*, FR*, DE*, GR*, HU, IE, IS, IT, LV, LT*, LU, MT*, NL, NO*, PL* PT, RO, SK, SI, ES, SE, UK

*Subject to license. Please contact your national frequency authority for information on available legal use in your area. Any changes or modifications not expressly approved by Samson Technologies Corp. could void your authority to operate the equipment.

Hereby, Samson Technologies Corp., declares that this CR88 and AH8 is in compliance with the essential requirements and other relevant provisions of Directive 2014/53/EU. The declaration of conformity may be consulted at:

http://www.samsontech.com/site_media/support/manuals/AirLine88_AH8_DOC.pdf



Rack Mounting

The CR88 receiver can be installed into a standard 19" rack for transport or permanent installation using the included rack ears. Follow the simple steps below to mount the CR88:

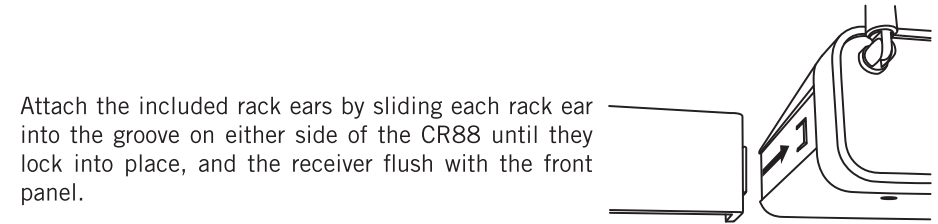

Attach the included rack ears by sliding each rack ear into the groove on either side of the CR88 until they lock into place, and the receiver flush with the front panel.

Position the CR88 receiver into an available rack space and slide in until the rack ears are touching the rails of the rack case and are aligned with the rack rail holes.

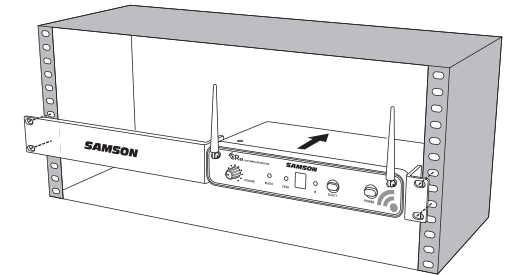

Mount the receiver into the rack using the appropriate size rack screws (not included). To ensure equal tension and balance when installing the receiver, you should secure screws in a crisscross pattern of opposite corners: top left -> bottom right -> top right -> bottom left.

In order to mount two CR88 receivers in one rack space, the system includes a center connection piece. Slide the center connection piece into the groove of each receiver and attach the short rack ears to each receiver. Mount the receivers into the rack using the crisscross pattern described above.

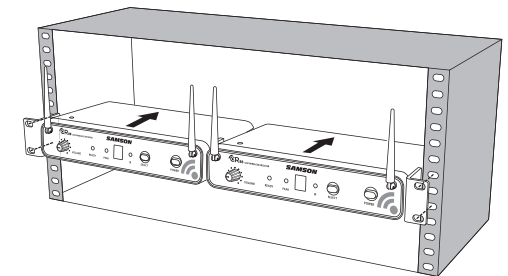

CR88 Receiver Rear Callouts

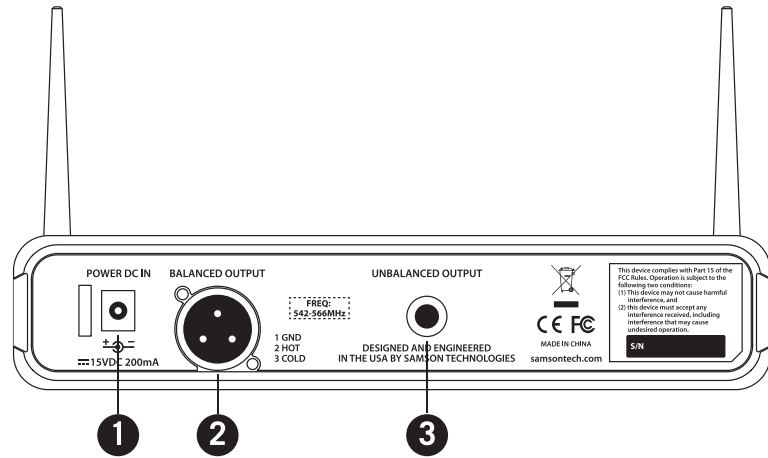

- 1. DC Input** - Connect the supplied power adapter here, using the strain relief as shown in the illustration below. **WARNING:** Do not substitute any other kind of power adapter. Doing so can cause severe damage to the CR88 and will void your warranty.
- 2. BALANCED OUTPUT** - Use this electronically balanced low impedance (600 Ohm) XLR jack when connecting the CR88 to professional (+4dBu) audio equipment. Pin wiring is as follows: Pin 1 ground, Pin 2 high (hot), and Pin 3 low (cold).
- 3. UNBALANCED OUTPUT** - Use this unbalanced high impedance (5K Ohm) 1/4" jack when connecting the CR88 to consumer (-10dBV) audio equipment. Wiring is as follows: tip hot, sleeve ground.

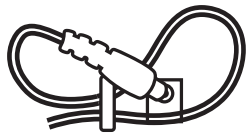

Using the strain relief: Gather up a loop of wire and pass it through the strain relief, then pass the adapter plug through the loop in order to create a knot.

Quick Start

In order for your wireless system to work correctly, both the receiver and transmitter must be set to the same channel. Follow this basic procedure for setting up and using your AirLine 88 Headset wireless system:

Physically place the CR88 receiver where it will be used, and extend the antennas vertically. The general rule of thumb is to maintain “line of sight” between the receiver and transmitter so that the person using or wearing the transmitter can see the receiver.

With the CR88 powered off, connect the included power adapter. Turn the CR88 on momentarily to confirm that the unit is receiving power. You’ll see the LED display light up. Then turn the CR88 power off.

With your amplifier or mixer off and volume control all the way down, connect the CR88 receiver output jack to the mic or line level input of a mixer or amplifier using the balanced XLR output or unbalanced 1/4" line level output. Turn the Level knob on the CR88 completely counterclockwise, then turn its power on.

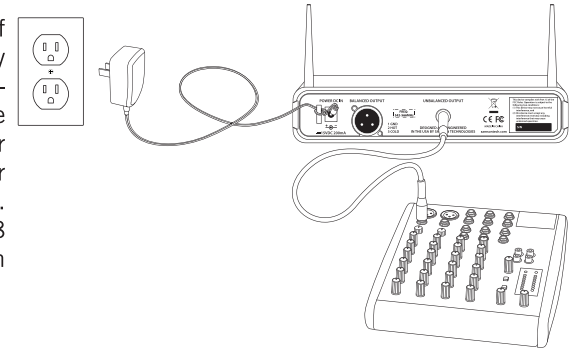

Make sure the AH8 Headset transmitter is fully charged (see section **Charging the AH8 Transmitter**) Turn on the power to the transmitter by pressing and holding Power switch; the indicator LED will light green.

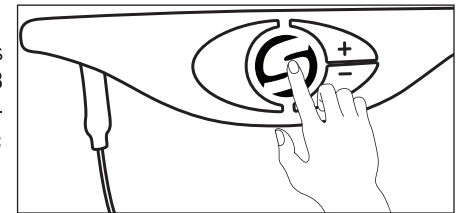

Press the SELECT button on the front of the CR88 receiver to choose an available channel. The channel number will increase by one digit, from 0-9 then A-F. Once the last channel has been reached, the count will cycle back to 0.

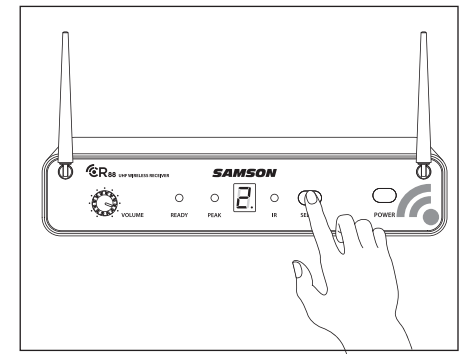

Quick Star

Position the transmitter about 6-12" (15-30 cm) from the front of the CR88 with the transmitter's IR window facing the IR transmitter on the front panel of the CR88 receiver.

Press and hold the CR88 SELECT button to set the transmitter to the same channel as the receiver via infrared transmission

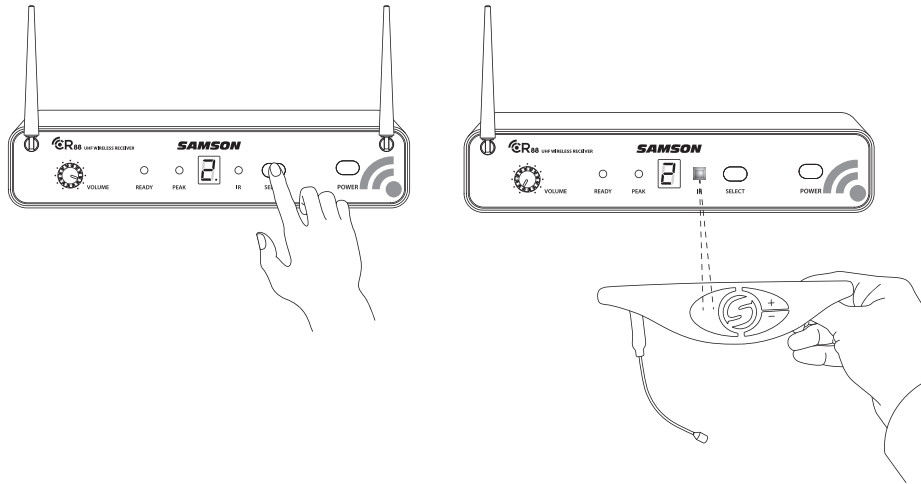

When the transmission is complete, the CR88 will receive RF signal and the tone key from the transmitter. The READY indicator will light on the front panel of the CR88 receiver.

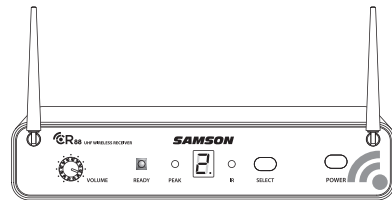

Turn on your connected amplifier or mixer, but keep the volume all the way down. Set the Volume knob on the CR88 fully clockwise (to its "10" setting). This is unity gain.

Speak or sing into the microphone. Slowly raise the volume of your amplifier or mixer until the desired level is reached.

If you find the system has noticeable drop-outs, reduced overall working range, or unexpected noise bursts, change the operating channel of the system using the steps above.

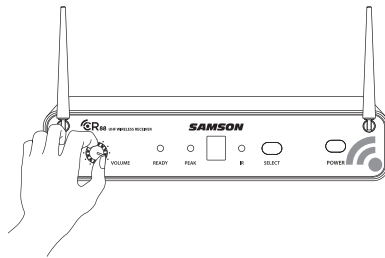

CR88 Receiver Front Callouts

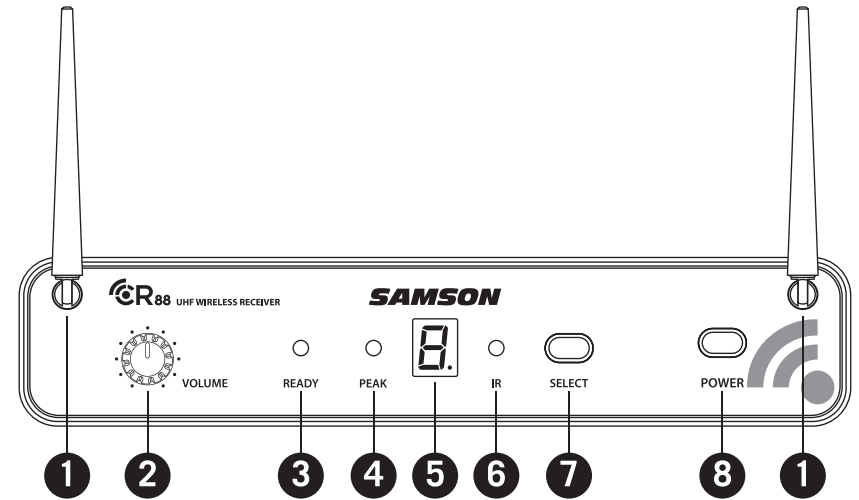

- 1. Antennas** - The antenna mountings allow full rotation for optimum placement. In normal operation, both antennas should be placed in a vertical position. Both antennas can be folded inward for convenience when transporting the CR88.
- 2. VOLUME Control** - This knob sets the level of the audio signal being output through both the balanced and unbalanced output jacks on the rear panel. Reference level is obtained when the knob is turned fully clockwise (to its "10" setting).
- 3. READY Indicator** - This indicator lights green when the CR88 is receiving RF signal and the system is ready to use.
- 4. PEAK Indicator** - This indicator lights red when the transmitted audio signal is overloaded.
- 5. LED Display** - The 7-segment LED display shows the receiver's current operating channel. The CR88 channels are indicated by 0-9 and A-F.
- 6. IR Transmitter** - During "IR SET" an infrared light is used to set the transmitter channel.
- 7. SELECT Button** - Press this button to cycle through the receiver's operating channels. Press and hold this button to send the channel information to the transmitter via infrared transmission.
- 8. POWER Switch** - Use this to turn the CR88 power on and off.

AH8 Headset Transmitter Callouts

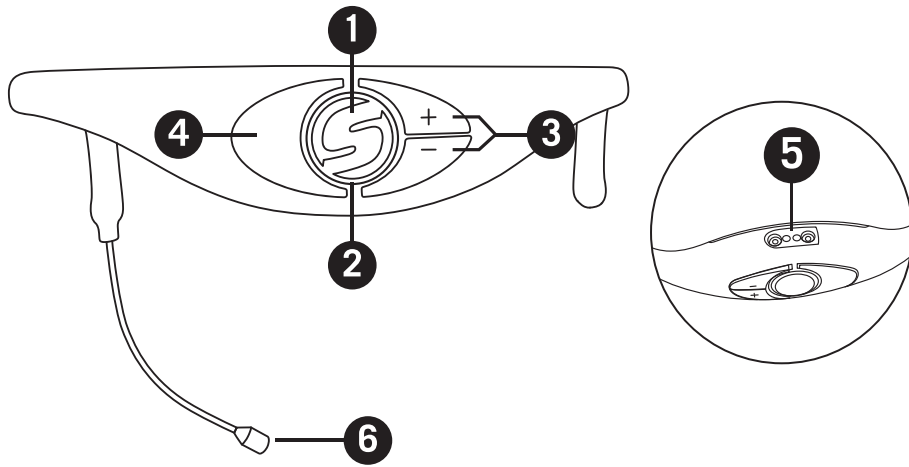

- 1. Power/Mute Button** - Press and hold to turn the unit on or off. A quick press and release will mute or unmute the transmitter when the transmitter is on.
- 2. Status Indicator** - This LED displays the operation mode, low battery and recharge status of the transmitter. The chart defines the LED colors for each function.

| | |
|--------------|------------------|
| GREEN | Normal Operation |
| AMBER | Mute |
| Flashing RED | Low Battery |
| | Charging |
| RED | Fully Charged |

- 3. Volume +/- Buttons** - Press and hold either Volume button to adjust the volume. Pressing the + or – button increases or decrease the level by one step with each push of the button. There is a total 6 volume levels. The Status Indicator light will flash faster for each increased step and slower for each decrease.
- 4. IR Lens** - This window is used to capture the infrared signal sent from the receiver during the IR SET to channelize the transmitter. The IR Lens is only active for the first 10 seconds the transmitter is powered on.
- 5. Charging Connector** - Connect the supplied magnetic charging cable to this sealed, gold contact charging connector to recharge the internal Lithium Ion battery. The AH8 can be recharged by connecting the cable to a USB connector on a computer USB port, or any 5-volt DC adapter that has a USB output. NOTE: The included adapter will charge the AH8 faster than a computer USB port.
- 6. Microphone** - Waterproof, micro-miniature, unidirectional microphone capsule in a marine-grade stainless steel housing.

Quick Start

If you hear distortion at the desired volume level, check to see whether the PEAK Indicator LED on the receiver is lighting RED. If it is not lit, make sure that the gain structure of your audio system is set correctly (consult the owners manual of your mixer and/or amplifier for details). If the Status Indicator is RED, it may be as simple as moving the microphone further from your mouth.

If the level of the microphone needs further adjustment, press and hold the AH8 “+” or “-” level buttons until the indicator starts flashing indicating that the transmitter is in the Volume Adjustment mode. Press the “+” button to raise the level or the “-” button to lower the level. As the level increases the indicator flashes faster. When the level decreases the indicator flashes slower. When the desired level is reached, release the volume buttons. The AH8 will return to normal operation after 10 seconds, and the Status Indicator will be steady GREEN.

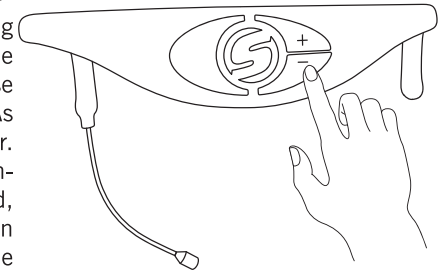

Multiple System Setup

When using multiple systems, each system must be set to a different operating channel. Transmitter and receiver pairs must be on the same channel plan in order to work together.

When setting an additional transmitter, make sure to move all other transmitters away from the receiver to ensure that the transmitter is not accidentally reset.

Charging the AH8 Transmitter

1. Insert the magnetic power cable to the included USB AC plug (or any 5-volt DC adapter that has a USB port). Insert the AC plug into an electrical outlet.
2. Attach the magnetic connector to the gold contact power port on the bottom of the AH8 transmitter. The cable attaches to the port magnetically. Note: The magnetic connector is keyed so it will only connect in one direction.
3. Look at the indicator light on the AH8 transmitter to determine when the transmitter has finished charging. When the light is flashing, the AH8 is charging. When the green light stops flashing it indicates that the AH8 is fully charged.
4. Disconnect the magnetic power cable from the AH8 when the unit is fully charged.

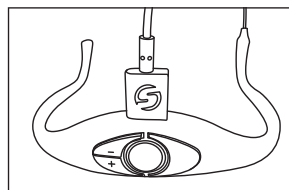
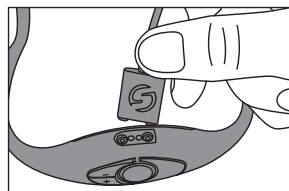
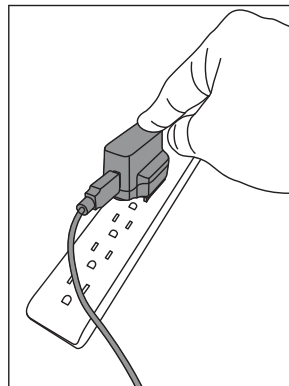

Getting the most out of the rechargeable battery:

- Completely charge the batteries before first use
- Fully charge the battery before it will be used.
- After the battery is charged, unplug the charger from the outlet or remove the battery from the charger.
- The optimal temperature range for using and storing the battery is 50°F - 86°F (30°C - 50°C). The battery performance and operation may decrease in temperatures below 50°F (30°C).

A warning that batteries (battery pack or batteries installed) shall not be exposed to excessive heat such as sunshine, fire or the like. Battery can not be replaced

CAUTION: Danger of explosion if battery is incorrectly replaced. Replace only with the same or equivalent type

Wearing the AH8 Transmitter

The AH8 can be re-sized to fit comfortably on your head. The correct way to wear your AH8 Headset transmitter is over the ears, as you would wear a pair of eyeglasses. Because the AH8 Headset is specially designed to be used up close, be sure to mount the microphone directly in front of your lips. To avoid feedback problems, take care not to cover the mic capsule with your hand.

Position the AH8 over your head so that the body of the transmitter is behind your head.

Adjust the headset so that it fits comfortably on your ears and is secure against your head.

If the AH8 headset is too large, push the sides of the headband in to decrease the width. If the transmitter is too small, pull the sides of the headband out to increase the width.

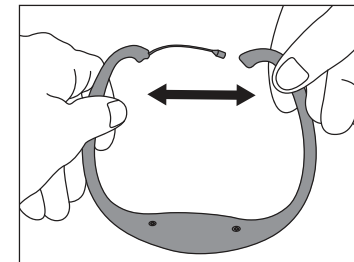

The ear hooks can be adjusted by either bending down or up. This will decrease or increase the length of the headset.

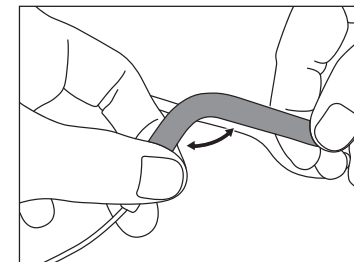

Position the microphone towards the corner of your mouth, approximately 1/2" away from the lips.

To help reduce p-popping, install one of the included windscreens.