



INSTALLATION GUIDE



1101 Series Wireless Universal Transmitter

GET STARTED

The 1101 Series Wireless Universal Transmitters are two-way supervisory wireless transmitters typically used for door and window applications. The 1101E features 128-bit AES encryption.

The transmitter provides a cover tamper, magnetic reed switch, and an onboard terminal block to allow for external contact wiring. Both sets of contacts, internal and external, can be programmed to operate at the same time. This allows two independent zones to operate from one 1101.

The 1101 Series also features Disarm/Disable functionality. When this option is enabled, Zone Tripped messages are disabled when the system is disarmed.

What's Included

- ▶ One 1101 Wireless Universal Transmitter
- ▶ One Magnet with Standard and Commercial Housing
- ▶ One 3.0 V lithium CR123A battery
- ▶ Hardware pack

Compatibility

- ▶ All DMP 1100 Series Wireless Receivers
- ▶ All DMP XT Series and XR Series panels

 **Note:** To enable encryption on 1101E models, Version 183 is required for XT and XR Series panels and Version 300 is required for Wireless Receivers.

Procedure

To install a 1101 transmitter, this guide walks you through these required steps:

1. Program the panel.
2. Install the battery.
3. Use the LED Survey to select a location.
4. Mount the transmitter.
5. Wire external contacts (optional).
6. Test the transmitter.

PCB Layout

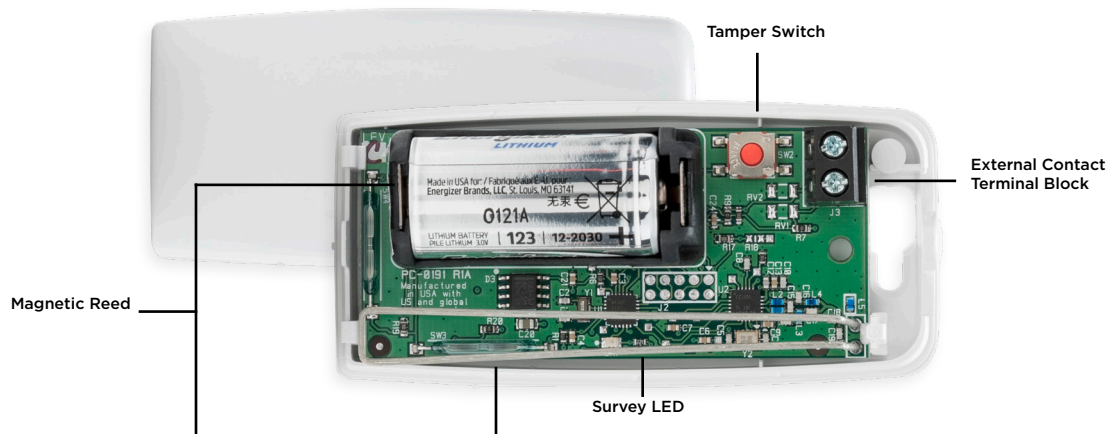



Figure 1: 1101 Layout

INSTALLATION

1 Program the Panel

Refer to the panel programming guide as needed. After completing each of the following steps, press **CMD** to advance to the next prompt.

1. At a keypad, enter **6653** (PROG) to access the Programmer Menu.
 2. For installing an 1101E, use the steps below before continuing to step 3. Otherwise, skip to step 3.
 - ▶ Go to **SYSTEM OPTIONS**. At **1100 ENCRYPTION**, select **ALL** to only add encrypted wireless devices to the system. Select **BOTH** to allow both encrypted and non-encrypted wireless devices to be programmed.
 - ▶ The default passphrase appears at the **ENTER PASSPHRASE** prompt. Press **CMD** to keep the default. Press any select key or area to change the passphrase and enter an 8-character hexadecimal string (0-9, A-F).
 3. At **ZONE INFORMATION**, enter the wireless zone number you would like to use.
 4. At ***UNUSED***, enter the zone name.
 5. At **ZONE TYPE**, press any select key or area and select the zone type.
 6. At the **NEXT ZN?** prompt, select **NO**.
 7. When **WIRELESS?** displays, select **YES**.
 8. At **SERIAL#**, enter the eight-digit device serial number found on device packaging.
 9. At **CONTACT**, select either **INTERNAL** or **EXTERNAL**. Use consecutive zone numbers if using both internal and external contacts.
 10. At **SUPRVSN TIME**, enter a supervision time. Default is **240**.
 11. At **DISARM DISABLE**, select **NO** or **YES**.
-  **Note:** Program the external contact first if using both internal and external contacts with Disarm/Disable functionality.
12. At the **NEXT ZONE** prompt, select **YES** if you are finished programming the zone. Select **NO** if you would like to access additional programming options.
 13. To save panel programming, go to **STOP** and press **CMD**.

2 Install the Battery

Use a 3.0 V lithium battery, a DMP Model CR123A battery, or an equivalent model from Sony or Murata. For listed installations, use either an Energizer® 123 battery or a CR123A battery manufactured by Panasonic or Tekcell.

1. To remove the lid/cover, push the button on the end of the transmitter and separate the two halves.
2. Observing polarity, place the battery in the holder and press it into place. Refer to Figure 1 during installation.

3 Select a Location

The transmitter provides a Survey LED capability to allow one person to confirm communication with the wireless receiver or panel while the cover is removed.

1. With the cover removed, hold the transmitter in the exact desired location.
2. Press the tamper switch to send data to the panel and determine if communication is confirmed or faulty.

✓ **Confirmed:** If communication is confirmed, for each press or release of the tamper switch the LED blinks immediately on and immediately off. Repeat this test to confirm five separate consecutive LED blinks. Any indication otherwise means proper communication has not been established.

✗ **Faulty:** If communication is faulty, the LED remains on for about 8 seconds or flashes multiple times in quick succession. Relocate the transmitter or receiver until the LED confirms clear communication.

4 Mount the Transmitter

Mount the Housing

When mounting the transmitter, refer to Figure 1 and Figure 2 for battery and mounting hole locations.

1. Remove the battery and the PCB.
2. Place the supplied #4 screw into the mounting hole and secure the transmitter housing to the surface.
3. Reinsert the PCB and the battery.
4. Snap the transmitter cover back onto the base.

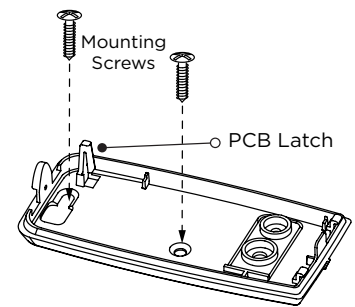

Figure 2: Mounting the Transmitter

Mount the Magnet

For magnet placement options, see Figure 5.

Standard Installation

1. Push the supplied magnet into the magnet cover.
2. Hold the magnet base on the door closest to the magnetic reed switch, no more than 1/2" (1.3 cm) from the transmitter.
3. Use the provided #4 screws to mount the base. See Figure 2.
4. Snap the cover onto the base.

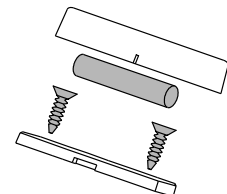

Figure 3: Standard Installation

Commercial Installation

1. Push the supplied magnet into the magnet cover.
2. Place and hold the magnet cover directly on the door closest to the magnetic reed switch, no more than 1/2" (1.3 cm) apart from the transmitter.
3. Use the provided #4 screws to mount the cover. See Figure 4.

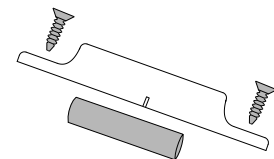

Figure 4: Commercial Installation

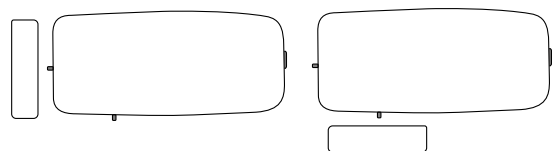

Figure 5: Placement Options

5 Wire the External Contacts (Optional)

The 1101 Universal Transmitter provides internal and external contacts that may be used at the same time to yield two individual reporting zones from one transmitter. This functionality makes the 1101 perfect for applications where any type of normally open or normally closed contact are in close proximity. DMP recommends using 18 or 22 AWG unshielded wire for contact connections.

⚡ Caution: Do not use twisted pair or shielded wire. Refer to Figure 6 when wiring external contacts.

1. Use a flathead screwdriver to loosen the two external contact terminal screws.
2. Insert external contact wiring into the 1101 terminal block and tighten the screws.
3. Connect the other ends of the wires to the external contact as either normally open (N/O) or normally closed (N/C) without an end-of-line resistor.
4. Snap the transmitter cover back onto the base.

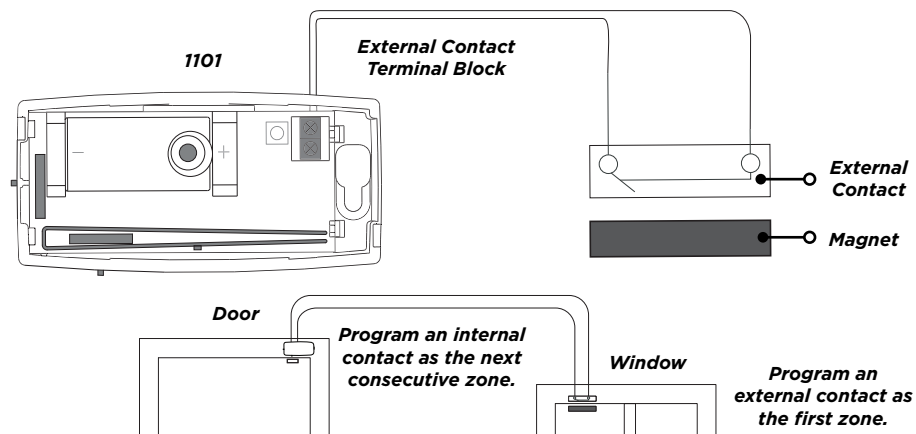

Figure 6: Connect External Contact

6 Test the Transmitter

After the transmitter has been installed, test to confirm that it is communicating reliably with the panel. Use the Tech APP™ to perform a Wireless Check-in Test on the system or perform a Check-in Test from a keypad that is connected to the panel. At the keypad, enter **8144** (WALK) and select WLS.

ADDITIONAL INFORMATION

Supervision Time

When a receiver is installed, powered up, or the panel is reset, the supervision time for transmitters is reset. If the receiver has been powered down for more than one hour, wireless transmitters may take up to an additional hour to send a supervision message unless tripped, tampered, or powered up. This operation extends battery life for transmitters. A missing message may display on the keypad until the transmitter sends a supervision message.

Replace the Battery

1. To remove the lid/cover, push the button on the end of the transmitter and separate the two halves.
2. Remove the old battery, observe polarity, and place the new battery in the holder.
3. Snap the cover back on the transmitter.

Sensor Reset to Clear LOBAT

Once the battery is replaced, a sensor reset is required at the keypad to clear the **LOBAT** message. On an LCD keypad, press and hold 2 for two seconds. On a graphic touchscreen keypad, press **RESET**. Enter your user code, if required. The keypad displays **SENSORS OFF** followed by **SENSORS ON**.

SPECIFICATIONS

Battery

Life Expectancy	5 Years (normal operation)
Type	3.0 V lithium CR123A Frequency

Frequency Range

905-924 MHz

Dimensions

Transmitter Case	3.3 L x 1.6 W x 0.9 H in.
Transmitter Base	3.3 L x 1.6 W x 0.1 H in.
Magnet Housing	1.5 L x 0.5 W x 0.7 H in.
Magnet Spacer	1.5 L x 0.5 W x 0.1 H in.

Housing Material

Flame-retardant ABS

Encryption

- ▶ XT and XR Series Panels Version 183 or higher
- ▶ Wireless Receivers Version 300 or higher

CERTIFICATIONS

- ▶ FCC Part 15 Registration ID CCKPC0191
- ▶ Industry Canada Registration ID 5251A-PC0191

Underwriters Laboratory (UL) Listed

ANSI/UL 1023	Household Burglar Alarm System Units Accessory Magnetically Activated Switch or Door Contact Transmitter
ANSI/UL 634	Connections and Switches for use with Burglar Alarm Systems Accessory

Patents

- ▶ U. S. Patent No. 7,239,236

FCC Information

This device complies with Part 15 of the FCC Rules. Operation is subject to the following two conditions:

1. This device may not cause harmful interference, and
2. This device must accept any interference received, including interference that may cause undesired operation.

Changes or modifications made by the user and not expressly approved by the party responsible for compliance could void the user's authority to operate the equipment.

 **Note:** This equipment has been tested and found to comply with the limits for a Class B digital device, pursuant to part 15 of the FCC Rules. These limits are designed to provide reasonable protection against harmful interference in a residential installation. This equipment generates, uses and can radiate radio frequency energy and, if not installed and used in accordance with the instructions, may cause harmful interference to radio communications. However, there is no guarantee that interference will not occur in a particular installation. If this equipment does cause harmful interference to radio or television reception, which can be determined by turning the equipment off and on, the user is encouraged to try to correct the interference by one or more of the following measures:

- Reorient or relocate the receiving antenna.
- Increase the separation between the equipment and receiver.
- Connect the equipment into an outlet on a circuit different from that to which the receiver is connected.
- Consult the dealer or an experienced radio/TV technician for help.

Industry Canada Information

This device complies with Industry Canada License-exempt RSS standard(s). Operation is subject to the following two conditions:

1. This device may not cause interference, and
2. This device must accept any interference, including interference that may cause undesired operation of the device.

Le présent appareil est conforme aux CNR d'Industrie Canada applicables aux appareils radio exempts de licence. L'exploitation est autorisée aux deux conditions suivantes:

1. l'appareil ne doit pas produire de brouillage, et
2. l'utilisateur de l'appareil doit accepter tout brouillage radioélectrique subi, même si le brouillage est susceptible d'en compromettre le fonctionnement.



Designed, engineered, and
manufactured in Springfield, MO
using U.S. and global components.

LT-0694 1.04 22172

© 2022

INTRUSION • FIRE • ACCESS • NETWORKS

2500 North Partnership Boulevard
Springfield, Missouri 65803-8877

800.641.4282 | DMP.com