



ROGERS LABS, INC.

4405 West 259th Terrace
Louisburg, KS 66053
Phone / Fax (913) 837-3214

Application For Grant of Certification

47 CFR, PART 15C - Intentional Radiators Paragraph 15.247,
Industry Canada RSS-247 Issue 2, and RSS-GEN Issue 5

Model: 1100T
902-928 MHz (FHSS)
Frequency Hopping Spread Spectrum
License Exempt Intentional Radiator

FCC ID: CCKPC0225

IC: 5251A-PC0225

Digital Monitoring Products, Inc.

2500 North Partnership Boulevard
Springfield, MO 65802-6310

FCC Designation: US5305
ISED Registration: 3041A-1
Test Report Number: 201123

Test Date: November 23, 2020

Authorized Signatory: *Scot D Rogers*
Scot D. Rogers

This report shall not be reproduced except in full, without the written approval of the laboratory.
This report must not be used by the client to claim product certification, approval, or
endorsement by NVLAP, NIST, or any agency of the U.S. Government.

Table of Contents

TABLE OF CONTENTS.....	2
REVISIONS.....	4
EXECUTIVE SUMMARY	5
OPINION / INTERPRETATION OF RESULTS	5
EQUIPMENT TESTED.....	8
Equipment Function	8
Equipment Configuration.....	9
APPLICATION FOR CERTIFICATION.....	10
APPLICABLE STANDARDS & TEST PROCEDURES	11
TESTING PROCEDURES	11
AC Line Conducted Emission Test Procedure	11
Radiated Emission Test Procedure.....	11
Antenna Port Conducted Emission Test Procedure.....	12
Diagram 1 Test arrangement for Conducted emissions	13
Diagram 2 Test arrangement for radiated emissions of tabletop equipment.....	14
Diagram 3 Test arrangement for radiated emissions tested on Open Area Test Site (OATS)	15
Diagram 4 Test arrangement for Antenna Port Conducted emissions	16
TEST SITE LOCATIONS	16
UNITS OF MEASUREMENTS	17
ENVIRONMENTAL CONDITIONS.....	17
STATEMENT OF MODIFICATIONS AND DEVIATIONS	17
INTENTIONAL RADIATORS.....	17
Antenna Requirements	17

Restricted Bands of Operation.....18

 Table 1 Radiated Emissions in Restricted Frequency Bands Data 18

Summary of Results for Radiated Emissions in Restricted Bands19

AC Line Conducted EMI Procedure19

 Figure 1 AC Line Conducted emissions of EUT line 120

 Figure 2 AC Line Conducted emissions of EUT line 221

 Table 2 AC Line Conducted Emissions Data L122

 Table 3 AC Line Conducted Emissions Data L2.....22

Summary of Results for AC Line Conducted Emissions Results.....22

General Radiated Emissions Procedure.....23

 Table 6 General Radiated Emissions Data24

Summary of Results for General Radiated Emissions24

Operation in the Band 902-928 MHz.....25

 Figure 3 Plot of Transmitter Operation across 902-928 MHz26

 Figure 4 Plot of Transmitter Emissions 20-dB Occupied Bandwidth.....27

 Figure 5 Plot of Transmitter Emissions 99% Occupied Bandwidth28

 Figure 6 Plot of Number of Hopping Channels29

 Figure 7 Plot of Number of Hopping Channels30

 Figure 8 Plot of Channel Separation.....31

 Figure 9 Plot of Dwell Time on Channel.....32

 Figure 10 Plot of 6 Times on Channel over 10 second period.....33

 Figure 11 Plot of Transmitter Emissions Low Band Edge Channels Hopping.....34

 Figure 12 Plot of Transmitter Emissions High Band Edge Channels Hopping35

Transmitter Emissions Data.....36

 Table 7 Transmitter Radiated Emissions36

 Table 8 Transmitter Antenna Port Data37

Summary of Results for Transmitter Radiated Emissions of Intentional Radiator.....37

ANNEX..... 38

Annex A Measurement Uncertainty Calculations.....39



Annex B Test Equipment.....40

Annex C Rogers Qualifications42

Annex D Laboratory Certificate of Accreditation.....43

Revisions

Revision 1 Issued December 10, 2020

Rogers Labs, Inc.
4405 West 259th Terrace
Louisburg, KS 66053
Phone/Fax: (913) 837-3214
Revision 1

Digital Monitoring Products, Inc.
Model: 1100T
Test: 201123
Test to: CFR47 15C, RSS-Gen RSS-247
File: DMP 1100T FHSS TstRpt 201123

SN's: ENG1 / ENG2
FCC ID: CCKPC0225
IC: 5251A-PC0225
Date: December 10, 2020
Page 4 of 43

Executive Summary

The following information is submitted for consideration in obtaining Grant of Certification for License Exempt Frequency Hopping Spread Spectrum (HSS) Intentional Radiator per 47 CFR Paragraph 15.247, Industry Canada RSS-247 Issue 2 and RSS-GEN Issue 5, FHSS transmitter operations in the 902-928 MHz frequency band.

Name of Applicant: Digital Monitoring Products, Inc.
 2500 North Partnership Boulevard
 Springfield, MO 65802-6310

M/N: 1100T

FCC ID: CCKPC0225

IC: 5251A-PC0225

Operating Frequency Range: 902-928 MHz

Power (dBm)	Power (Watts)	20-dB OBW (kHz)	99% OBW (kHz)
14.0	0.025	68.6	68.6

Opinion / Interpretation of Results

Tests Performed	Margin (dB)	Results
Restricted Bands 47 CFR 15.205, RSS-247 3.3	-9.2	Complies
AC Line Conducted 47 CFR 15.207, RSS-GEN 8.8	-24.2	Complies
Radiated Emissions 47 CFR 15.209, RSS-247 5.5	-6.3	Complies
Harmonic Emissions per 47 CFR 15.247, RSS-247 5.5.	-4.5	Complies

Tests performed include

47CFR

§15.247 Operation within the bands 902-928 MHz, 2400-2483.5 MHz, and 5725-5850 MHz.

(a) Operation under the provisions of this Section is limited to frequency hopping and digitally modulated intentional radiators that comply with the following provisions:

(1) Frequency hopping systems shall have hopping channel carrier frequencies separated by a minimum of 25 kHz or the 20-dB bandwidth of the hopping channel, whichever is greater. Alternatively, frequency hopping systems operating in the 2400-2483.5 MHz band may have hopping channel carrier frequencies that are separated by 25 kHz or two-thirds of the 20-dB bandwidth of the hopping channel, whichever is greater, provided the systems operate with an output power no greater than 125 mW. The system shall hop to channel frequencies that are selected at the system hopping rate from a pseudo randomly ordered list of hopping frequencies. Each frequency must be used equally on the average by each transmitter. The system receivers shall have input bandwidths that match the hopping channel bandwidths of their corresponding transmitters and shall shift frequencies in synchronization with the transmitted signals.

(i) For frequency hopping systems operating in the 902-928 MHz band: if the 20 dB bandwidth of the hopping channel is less than 250 kHz, the system shall use at least 50 hopping frequencies and the average time of occupancy on any frequency shall not be greater than 0.4 seconds within a 20 second period; if the 20 dB bandwidth of the hopping channel is 250 kHz or greater, the system shall use at least 25 hopping frequencies and the average time of occupancy on any frequency shall not be greater than 0.4 seconds within a 10 second period. The maximum allowed 20 dB bandwidth of the hopping channel is 500 kHz.

(b) The maximum peak conducted output power of the intentional radiator shall not exceed the following:

(2) For frequency hopping systems operating in the 902-928 MHz band: 1 watt for systems employing at least 50 hopping channels; and, 0.25 watts for systems employing less than 50 hopping channels, but at least 25 hopping channels, as permitted under paragraph (a)(1)(i) of this section.

(c) Operation with directional antenna gains greater than 6 dBi.

(d) In any 100 kHz bandwidth outside the frequency band in which the spread spectrum or digitally modulated intentional radiator is operating, the radio frequency power that is produced by the intentional radiator shall be at least 20 dB below that in the 100 kHz bandwidth within the band that contains the highest level of the desired power, based on either an RF conducted or a radiated measurement, provided the transmitter demonstrates compliance with the peak conducted power limits. If the transmitter complies with the conducted power limits based on the use of RMS averaging over a time interval, as permitted under paragraph (b)(3) of this section, the attenuation required under this paragraph shall be 30 dB instead of 20 dB. Attenuation below the general limits specified in §15.209(a) is not required. In addition, radiated emissions which fall in the restricted bands, as defined in §15.205(a), must also comply with the radiated emission limits specified in §15.209(a) (see §15.205(c)).

RSS-247 Issue 2

5.1 Frequency hopping systems (FHS)

FHSs employ a spread spectrum technology in which the carrier is modulated with coded information in a conventional manner, causing a conventional spreading of the radio frequency (RF) energy around the carrier frequency. The carrier frequency is not fixed, but changes at fixed intervals under the direction of a coded sequence.

FHSs are not required to employ all available hopping frequencies during each transmission.

However, the system, consisting of both the transmitter and the receiver, must be designed to comply with all of the requirements in this section in case the transmitter is presented with a continuous data (or information) stream. In addition, a system employing short transmission bursts must comply with the definition of frequency hopping equipment and must distribute its transmissions over the minimum number of hopping channels specified in this section.

Incorporation of intelligence into an FHS that enables it to recognize other users of the band and to avoid occupied frequencies is permitted provided that the FHS does it individually and independently chooses or adapts its hopset. The coordination of FHSs in any other manner for the express purpose of avoiding the simultaneous occupancy of individual hopping frequencies by multiple transmitters is not permitted.

The following applies to FHSs in each of the three bands:

a) The bandwidth of a frequency hopping channel is the 20 dB emission bandwidth, measured with the hopping stopped. The system's radio frequency (RF) bandwidth is equal to the channel bandwidth multiplied by the number of channels in the hopset. The system shall hop to channel frequencies that are selected at the system hopping rate from a pseudo randomly ordered list of hopping frequencies. The system receivers shall have input bandwidths that match the hopping channel bandwidths of their corresponding transmitters and shall shift frequencies in synchronization with the transmitted signals.

b) FHSs shall have hopping channel carrier frequencies separated by a minimum of 25 kHz or the 20 dB bandwidth of the hopping channel, whichever is greater. Alternatively, FHSs operating in the band 2400-2483.5 MHz may have hopping channel carrier frequencies that are separated by 25 kHz or two thirds of the 20 dB bandwidth of the hopping channel, whichever is greater, provided that the systems operate with an output power no greater than 0.125 W.

c) For FHSs in the band 902-928 MHz: if the 20 dB bandwidth of the hopping channel is less than 250 kHz, the system shall use at least 50 hopping channels and the average time of occupancy on any channel shall not be greater than 0.4 seconds within a 20-second period. If the 20 dB bandwidth of the hopping channel is 250 kHz or greater, the system shall use at least 25 hopping channels and the average time of occupancy on any channel shall not be greater than 0.4 seconds within a 10-second period. The maximum 20 dB bandwidth of the hopping channel shall be 500 kHz.

d) FHSs operating in the band 2400-2483.5 MHz shall use at least 15 hopping channels. The average time of occupancy on any channel shall not be greater than 0.4 seconds within a period of 0.4 seconds, multiplied by the number of hopping channels employed. Transmissions on particular hopping frequencies may be avoided or suppressed provided that at least 15 hopping channels are used.

e) FHSs operating in the band 5725-5850 MHz shall use at least 75 hopping channels. The maximum 20 dB bandwidth of the hopping channel shall be 1 MHz. The average time of occupancy on any frequency shall not be greater than 0.4 seconds within a 30-second period.

Equipment Tested

Model: 1100T

<u>Equipment</u>	<u>Model</u>	<u>Serial Number</u>
EUT	1100T	ENG1
EUT2	1100T	ENG2
AC Adapter	ST-12500W	14090416573

Test results in this report relate only to the items tested

Firmware Version 106

HVIN: PC-0225-R02

PMN: 1100T

PIFA antenna system 1.5 dBi gain

Test results in this report relate only to the items tested and operating in mode 2. Worst-case configuration data recorded in this report.

Equipment Function

The EUT is a wall mounted 905.6-924.4 MHz frequency hopping spread spectrum transceiver system. Transceiver performs wireless notification to an alarm panel installation of for use in alarm system installations. The design operates from direct current only and offers no provision for connection to utility power systems. The manufacturer supplied an AC/DC adapter for use in conducting AC line conducted emissions testing. This device contains the wireless FHSS transceiver operating in the 902-928 MHz band and incorporates separate receiver capability at 319.5 MHz, 345 MHz, or 433 MHz depending on configuration. The receiver function provides the EUT the ability to accept signals from burglary and fire initiating devices in a receive only mode. Then the EUT may transmit the information on other associated alarm installation equipment. The design utilizes internal fixed antenna systems and offers no provision for antenna replacement or modification. Two samples were provided for testing, one representative of production design, and the other modified for testing purposes replacing the integral antennas with RF connection ports. The test samples were provided with software providing testing personnel the ability to enable transmitter functions on defined functions and channels. The test software enabled near 100% transmit duty cycle for testing purposes on channel.

The EUT was arranged as described by the manufacturer emulating typical user configurations for testing purposes. For testing purposes, the EUT received powered from the manufacturer provided AC/DC power supply and configured to operate in available modes. As requested by the manufacturer and required by regulations, the equipment was tested for compliance using the available configurations with the worst-case data presented. Test results in this report relate only to the products described in this report.

Equipment Configuration

- 1) Integral antenna (EUT) connected to Utility AC power through AC/DC power supply

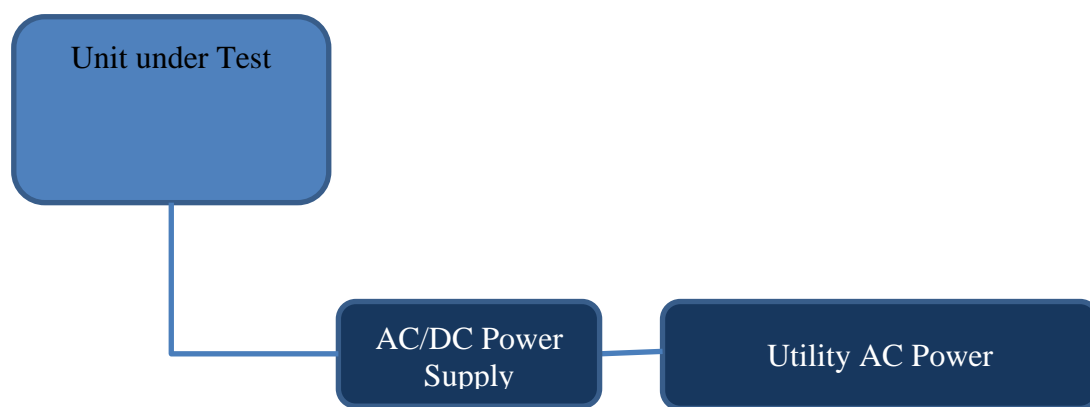

- 2) Antenna Port (EUT2) connected to Utility AC power through AC/DC power supply

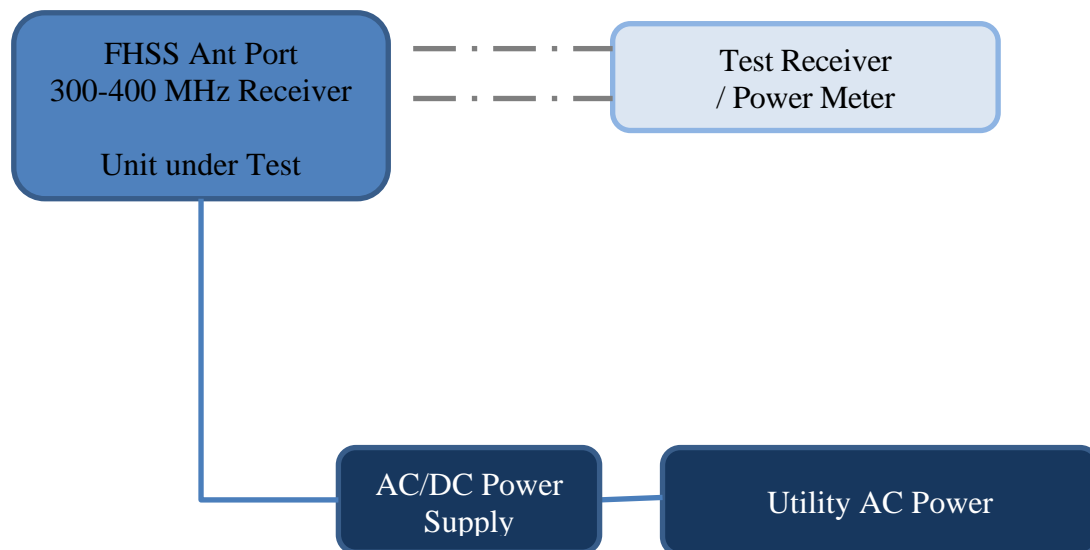

Application for Certification

- (1) Manufacturer: Digital Monitoring Products, Inc.
2500 North Partnership Boulevard
Springfield, MO 65802-6310
- (2) Identification: M/N: 1100T
FCC ID: CCKPC0225 IC: 5251A-PC0225
- (3) Instruction Book:
Refer to Exhibit for Instruction Manual.
- (4) Description of Circuit Functions:
Refer to Exhibit of Operational Description.
- (5) Block Diagram with Frequencies:
Refer to Exhibit of Operational Description.
- (6) Report of Measurements:
Report of measurements follows in this Report.
- (7) Photographs: Construction, Component Placement, etc.:
Refer to Exhibit for photographs of equipment.
- (8) List of Peripheral Equipment Necessary for operation. The equipment operates from direct current power only. An AC/DC Power supply was provided for operation. The EUT offers no other connection ports than those presented in this filing.
- (9) Transition Provisions of 47 CFR 15.37 are not requested.
- (10) Not Applicable. The unit is not a scanning receiver.
- (11) Not Applicable. The EUT does not operate in the 59 – 64 GHz frequency band.
- (12) The equipment is not software defined and this section is not applicable.
- (13) Applications for certification of U-NII devices in the 5.15-5.35 GHz and the 5.47-5.85 GHz bands must include a high-level operational description of the security procedures that control the radio frequency operating parameters and ensure that unauthorized modifications cannot be made. This requirement is not applicable to his DTS device.
- (14) Contain at least one drawing or photograph showing the test set-up for each of the required types of tests applicable to the device for which certification is requested. These drawings or photographs must show enough detail to confirm other information contained in the test report. Any photographs used must be focused originals without glare or dark spots and must clearly show the test configuration used. This information is provided in this report and Test Setup Exhibits provided with the application filing.

Applicable Standards & Test Procedures

In accordance with the e-CFR Code of Federal Regulations Title 47, dated November 23, 2020: Part 2, Subpart J, Paragraphs 2.907, 2.911, 2.913, 2.925, 2.926, 2.1031 through 2.1057, and applicable parts of paragraph 15, Part 15C Paragraph 15.247, Industry Canada RSS-247 Issue 2, and RSS-GEN Issue 5 operation in the 902-928 MHz Frequency band. Test procedures used are the established Methods of Measurement of Radio-Noise Emissions as described in ANSI C63.10-2013.

Testing Procedures

AC Line Conducted Emission Test Procedure

Testing for the AC line-conducted emissions was performed as defined in ANSI C63.10-2013. The test setup, including the EUT, was arranged in the test configurations as presented during testing. The test configuration was placed on a 1 x 1.5-meter bench, 0.8 meters high located in a screen room. The power lines of the system were isolated from the power source using a standard LISN with a 50- μ Hy choke. EMI was coupled to the spectrum analyzer through a 0.1 μ F capacitor internal to the LISN. The LISN was positioned on the floor beneath the wooden bench supporting the EUT. The power lines and cables were draped over the back edge of the table. Refer to diagram 1 showing typical test arrangement and photographs in exhibits for EUT placement used during testing. Refer to photographs in the test setup exhibits for specific EUT placement during testing.

Radiated Emission Test Procedure

Radiated emissions testing was performed as required in 47 CFR 15C, RSS-247 and specified in ANSI C63.10-2013. The EUT was placed on a rotating 0.9 x 1.2-meter platform, elevated as required above the ground plane at a distance of 3 meters from the FSM antenna. EMI energy was maximized by equipment placement permitting orientation in three orthogonal axes, raising and lowering the FSM antenna, changing the antenna polarization, and by rotating the turntable. Each emission was maximized before data was taken and recorded. The frequency spectrum from 9 kHz to 25,000 MHz was searched for emissions during preliminary investigation. Refer to diagrams 2 and 3 showing typical test setup. Refer to photographs in the test setup exhibits for specific EUT placement during testing.

Antenna Port Conducted Emission Test Procedure

The EUT was assembled as required for operation placed on a benchtop. This configuration provided the ability to connect test equipment to the provided test antenna port. Antenna Port conducted emissions testing was performed presented in the regulations and specified in ANSI C63.10-2013. Testing was completed on a laboratory bench in a shielded room. The active antenna port of the device was connected to appropriate attenuation and the spectrum analyzer. Refer to diagram 4 showing typical test setup. Refer to photographs in the test setup exhibits for specific EUT placement during testing.

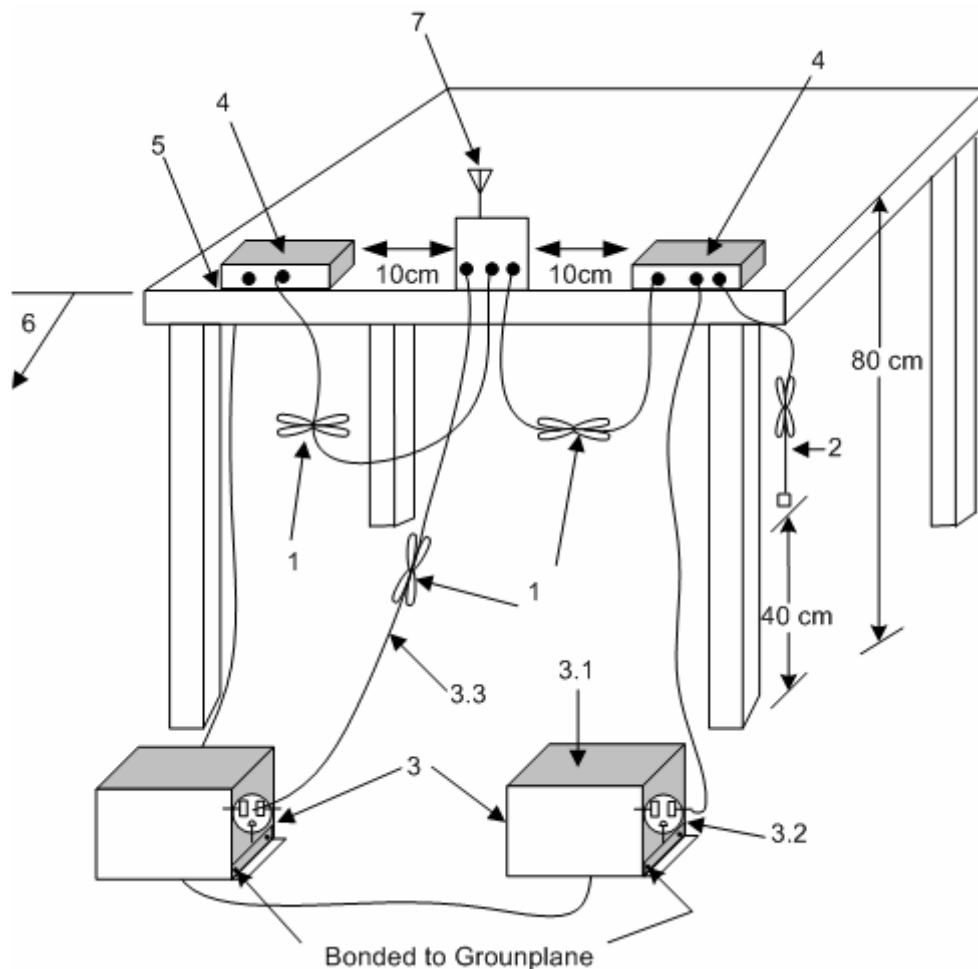

1. Interconnecting cables that hang closer than 40 cm to the ground plane shall be folded back and forth in the center forming a bundle 30 cm to 40 cm long see (see 6.2.3.1).
2. I/O cables that are not connected to an accessory shall be bundled in the center. The end of the cable may be terminated, if required, using the correct terminating impedance. The overall length shall not exceed 1 m (see 6.2.2).
3. EUT connected to one LISN. Unused LISN measuring port connectors shall be terminated in 50 Ω loads. LISN can be placed on top of, or immediately beneath, reference ground plane (see 6.2.2 and 6.2.3).
 - 3.1 All other equipment powered from additional LISN(s).
 - 3.2 Multiple-outlet strip can be used for multiple power cords of non-EUT equipment.
 - 3.3 LISN at least 80 cm from nearest part of EUT chassis.
4. Non-EUT components of EUT system being tested.
5. Rear of EUT, including peripherals, shall all be aligned and flush with rear of tabletop (see 6.2.3.1).
6. Edge of tabletop shall be 40 cm removed from a vertical conducting plane that is bonded to the ground plane (see 6.2.2 for options).
7. Antenna may be integral or detachable. If detachable, the antenna shall be attached for this test.

Diagram 1 Test arrangement for Conducted emissions

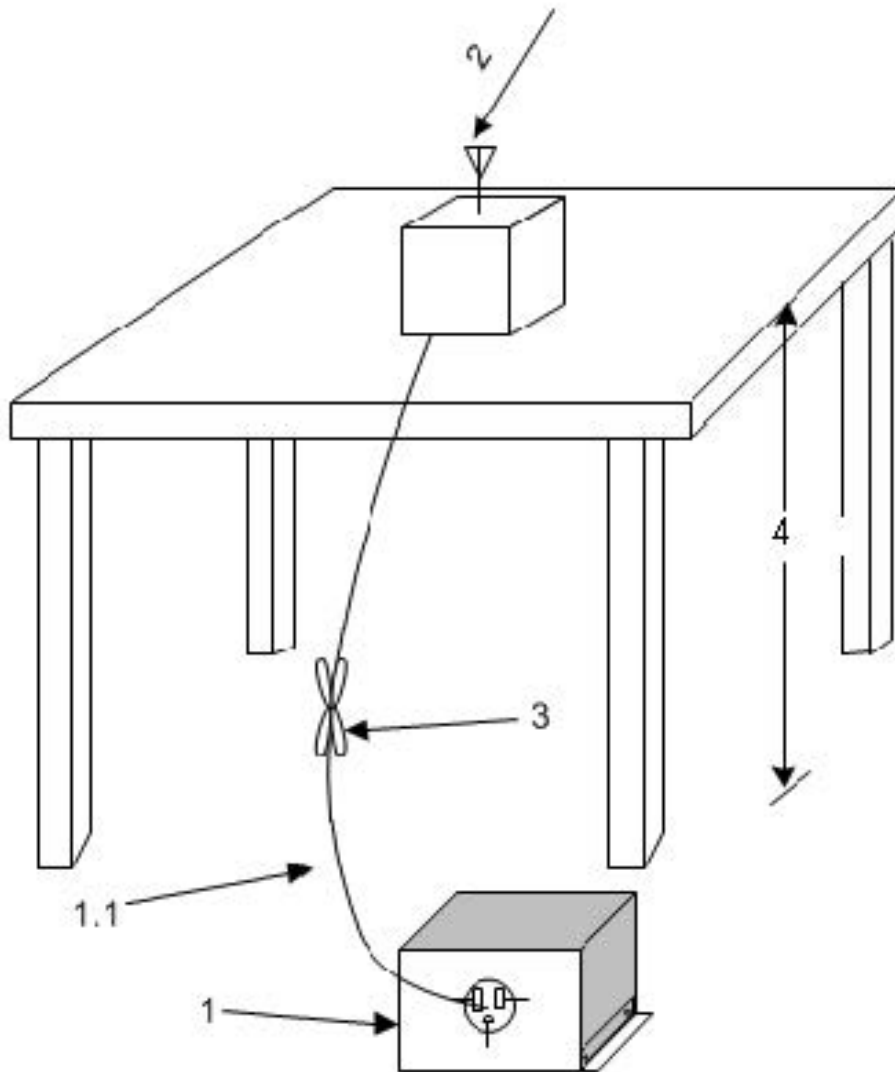

1—A LISN is optional for radiated measurements between 30 MHz and 1000 MHz but not allowed for measurements below 30 MHz and above 1000 MHz (see 6.3.1). If used, then connect EUT to one LISN. Unused LISN measuring port connectors shall be terminated in 50 Ω loads. The LISN may be placed on top of, or immediately beneath, the reference ground plane (see 6.2.2 and 6.2.3.2).

1.1—LISN spaced at least 80 cm from the nearest part of the EUT chassis.

2—Antenna can be integral or detachable, depending on the EUT (see 6.3.1).

3—Interconnecting cables that hang closer than 40 cm to the ground plane shall be folded back and forth in the center forming a bundle 30 cm to 40 cm long (see 6.3.1).

4—For emission measurements at or below 1 GHz, the table height shall be 80 cm. For emission measurements above 1 GHz, the table height shall be 1.5 m for measurements, except as otherwise specified (see 6.3.1 and 6.6.3.1).

Diagram 2 Test arrangement for radiated emissions of tabletop equipment

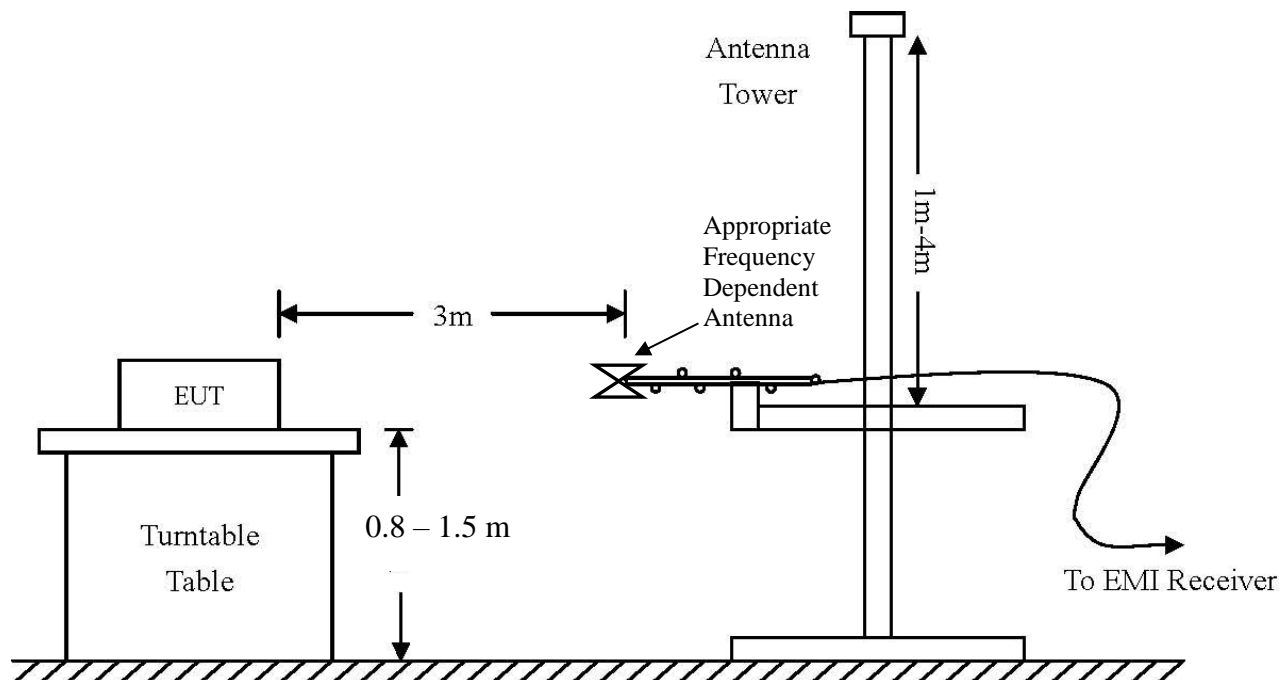

AC Line Conducted Emissions (0.150 -30 MHz)		
RBW	AVG. BW	Detector Function
9 kHz	30 kHz	Peak / Quasi Peak
Emissions (30-1000 MHz)		
RBW	AVG. BW	Detector Function
120 kHz	300 kHz	Peak / Quasi Peak
Emissions (Above 1000 MHz)		
RBW	Video BW	Detector Function
100 kHz	100 kHz	Peak
1 MHz	1 MHz	Peak / Average

Diagram 3 Test arrangement for radiated emissions tested on Open Area Test Site (OATS)

Spectrum Analyzer

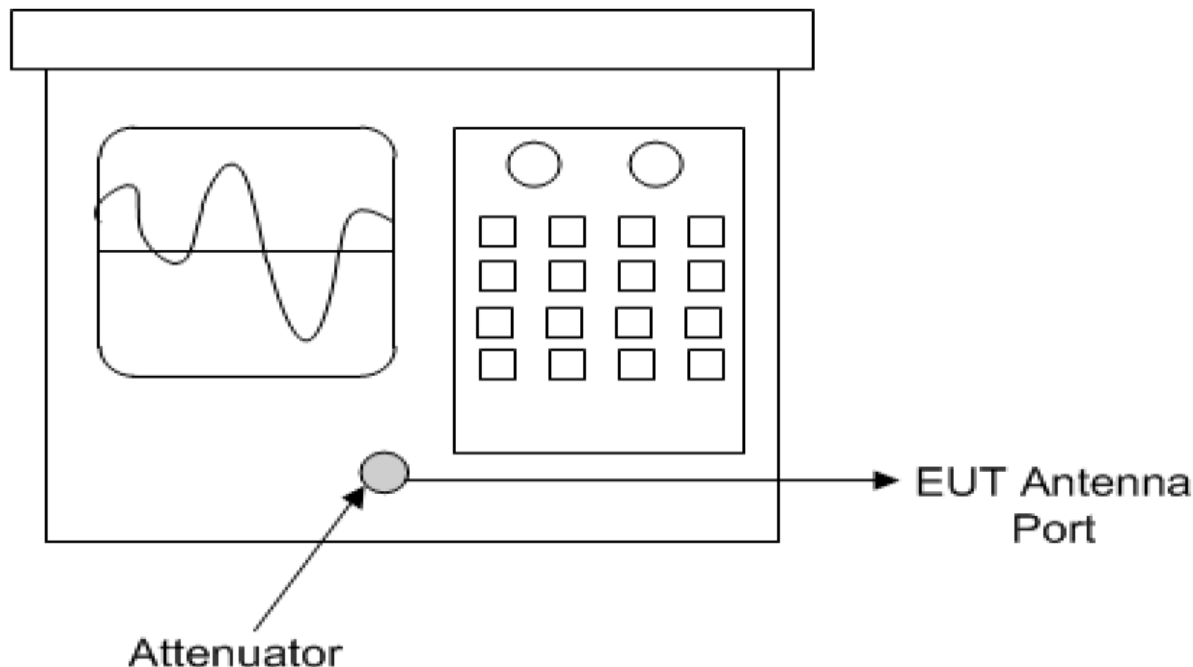

Diagram 4 Test arrangement for Antenna Port Conducted emissions

Test Site Locations

Conducted EMI AC line conducted emissions testing performed in a shielded screen room located at Rogers Labs, Inc., 4405 West 259th Terrace, Louisburg, KS

Antenna port Antenna port conducted emissions testing was performed in a shielded screen room located at Rogers Labs, Inc., 4405 West 259th Terrace, Louisburg, KS

Radiated EMI The radiated emissions tests were performed at the 3 meters, Open Area Test Site (OATS) located at Rogers Labs, Inc., 4405 West 259th Terrace, Louisburg, KS

Registered Site information: FCC Site: US5305, ISED: 3041A, CAB Identifier: US0096

NVLAP Accreditation Lab code 200087-0

Units of Measurements

Conducted EMI Data is in dB μ V; dB referenced to one microvolt

Radiated EMI Data is in dB μ V/m; dB/m referenced to one microvolt per meter

Sample Calculation:

RFS = Radiated Field Strength, FSM = Field Strength Measured

A.F. = Receive antenna factor, Gain = amplification gains and/or cable losses

RFS (dB μ V/m @ 3m) = FSM (dB μ V) + A.F. (dB) - Gain (dB)

Environmental Conditions

Ambient Temperature 20.6° C

Relative Humidity 33%

Atmospheric Pressure 1025.0 mb

Statement of Modifications and Deviations

No modifications to the EUT were required for the equipment to demonstrate compliance with the 47 CFR Part 15C, 15.247, Industry Canada RSS-247 Issue 2, and RSS-GEN Issue 5 emission requirements. There were no deviations to the specifications.

Intentional Radiators

The following information is submitted supporting compliance with the requirements of 47 CFR, Subpart C, paragraph 15.247, Industry Canada RSS-247 Issue 2 and RSS-GEN Issue 5.

Antenna Requirements

The EUT incorporates integral antenna system. Production equipment offers no provision for connection to alternate antenna system. The antenna connection point complies with the unique antenna connection requirements. There are no deviations or exceptions to the specification.

Restricted Bands of Operation

Spurious emissions falling in the restricted frequency bands of operation were measured at the OATS. The EUT utilizes frequency, determining circuitry, which generates harmonics falling in the restricted bands. Emissions were investigated at the OATS, using appropriate antennas or pyramidal horns, amplification stages, and a spectrum analyzer. Peak and average amplitudes of frequencies above 1000 MHz were compared to the required limits with worse-case data presented below. Test procedures of ANSI C63.10-2013 were used during testing. No other significant emission was observed which fell into the restricted bands of operation. Computed emission values take into account the received radiated field strength, receive antenna correction factor, amplifier gain stage, and test system cable losses.

Table 1 Radiated Emissions in Restricted Frequency Bands Data

Frequency in MHz	Horizontal Peak (dBμV/m)	Horizontal Average (dBμV/m)	Vertical Peak (dBμV/m)	Vertical Average (dBμV/m)	Limit @ 3m (dBμV/m)	Horizontal Margin (dB)	Vertical Margin (dB)
2716.8	46.6	44.8	38.3	34.6	54.0	-9.2	-19.4
2745.0	46.4	44.3	42.2	39.7	55.0	-10.7	-15.3
2773.2	46.7	45.1	42.5	39.8	56.0	-10.9	-16.2
3622.4	45.4	43.1	41.2	38.0	57.0	-13.9	-19.0
3660.0	40.8	37.2	36.4	31.2	58.0	-20.8	-26.8
3697.6	39.1	34.7	37.5	31.6	59.0	-24.3	-27.4
4528.0	37.8	32.4	38.4	32.3	60.0	-27.6	-27.7
4575.0	38.8	33.2	38.5	33.3	61.0	-27.8	-27.7
4622.0	39.4	33.9	39.1	33.8	62.0	-28.1	-28.2
5433.6	39.1	33.5	38.7	33.4	63.0	-29.5	-29.6
5490.0	39.9	34.5	39.9	34.5	64.0	-29.5	-29.5
5546.4	39.6	34.6	40.2	34.6	65.0	-30.4	-30.4

Other emissions present had amplitudes at least 20 dB below the limit. Peak and Quasi-Peak amplitude emissions are recorded for frequency below 1000 MHz. Peak and Average amplitude emissions are recorded for frequency range above 1000 MHz.

Summary of Results for Radiated Emissions in Restricted Bands

The EUT demonstrated compliance with the radiated emissions requirements of 47 CFR Part 15C and RSS-247 Intentional Radiator requirements. The EUT demonstrated a worse-case minimum margin of -9.2 dB below the emissions requirements in restricted frequency bands. Peak, Quasi-peak, and average amplitudes were checked for compliance with the regulations. Worse-case emissions are reported with other emissions found in the restricted frequency bands at least 20 dB below the requirements.

AC Line Conducted EMI Procedure

The EUT was arranged in typical equipment configurations operating from AC power adapter. Testing was performed with the EUT placed on a 1 x 1.5-meter wooden bench 80 cm above the conducting ground plane, floor of a screen room. The bench was positioned 40 cm away from the wall of the screen room. The LISN was positioned on the floor of the screen room 80-cm from the rear of the EUT. Testing for the line-conducted emissions were the procedures of ANSI C63.10-2013 paragraph 6. The AC adapter for the EUT was connected to the LISN for line-conducted emissions testing. A second LISN was positioned on the floor of the screen room 80-cm from the rear of the supporting equipment of the EUT. All power cords except the EUT were then powered from the second LISN. EMI was coupled to the spectrum analyzer through a 0.1 μ F capacitor, internal to the LISN. Power line conducted emissions testing was carried out individually for each current carrying conductor of the EUT. The excess length of lead between the system and the LISN receptacle was folded back and forth to form a bundle not exceeding 40 cm in length. The screen room, conducting ground plane, analyzer, and LISN were bonded together to the protective earth ground. Preliminary testing was performed to identify the frequencies of each of the emissions, which demonstrated the highest amplitudes. The cables were repositioned to obtain maximum amplitude of measured EMI level. Once the worst-case configuration was identified, plots were made of the EMI from 0.15 MHz to 30 MHz then data was recorded with maximum conducted emissions levels.

Refer to figures 1 and 2 for plots of the EUT – AC Line conducted emissions.

RBW 9 kHz
 MT 1 s

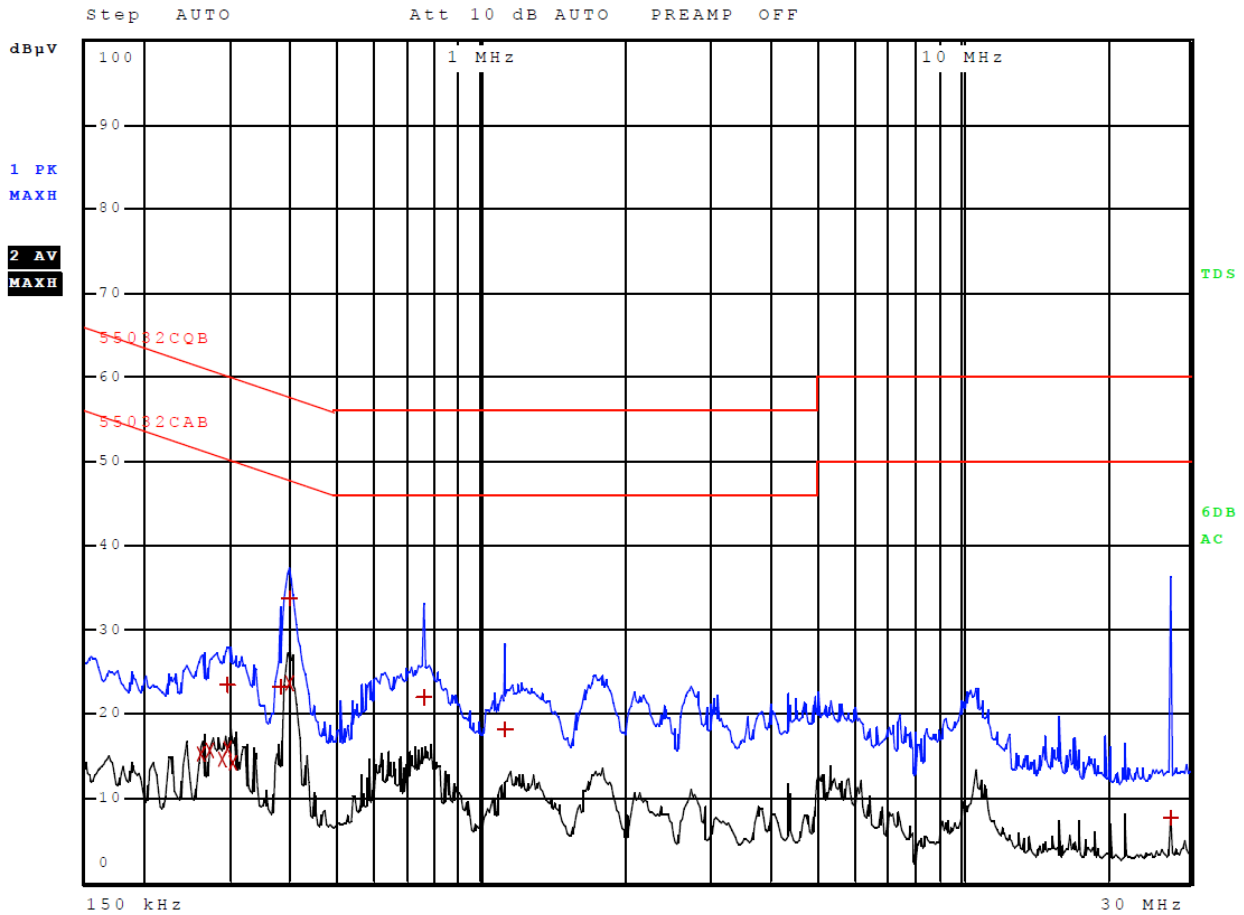

Figure 1 AC Line Conducted emissions of EUT line 1

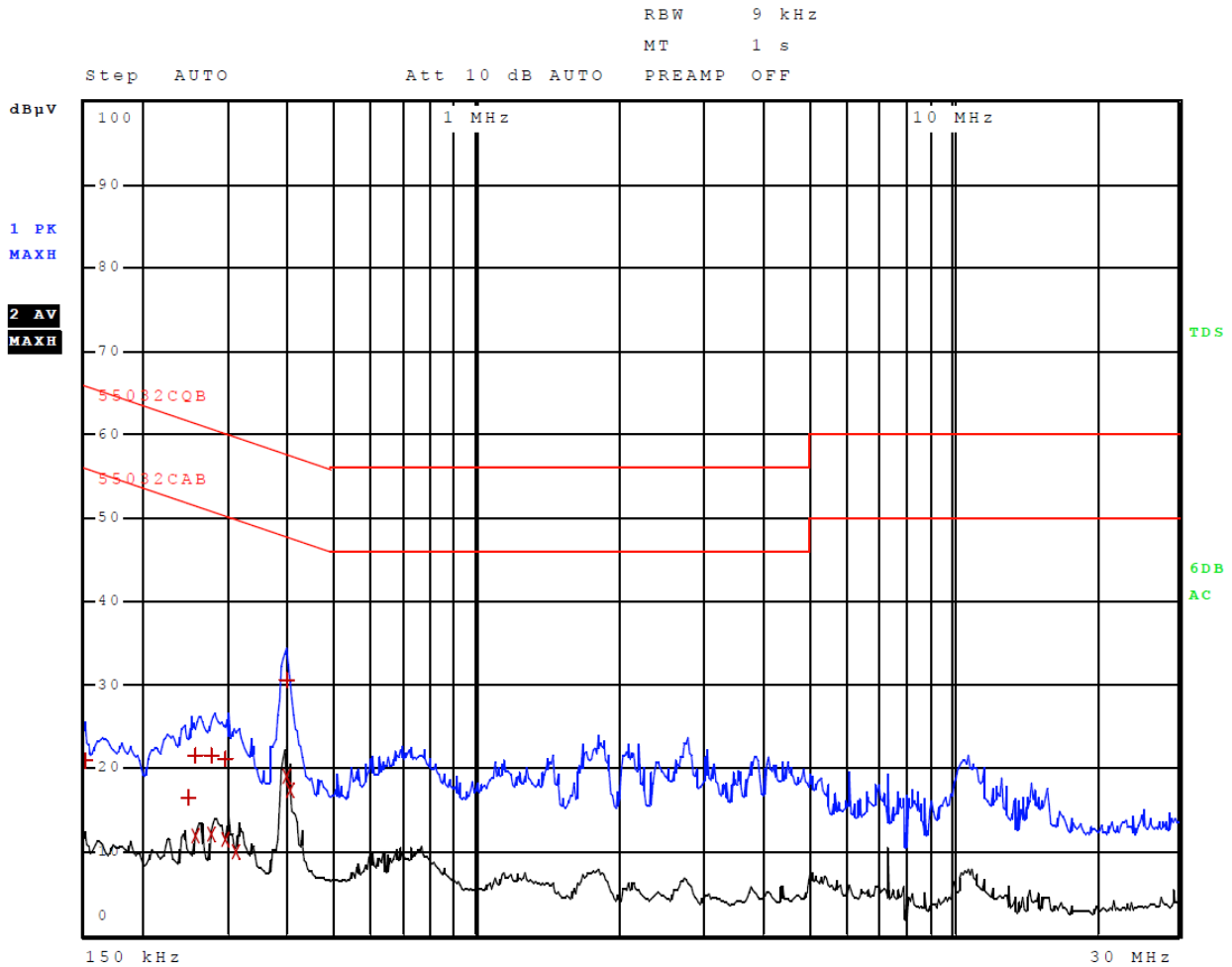

Figure 2 AC Line Conducted emissions of EUT line 2

Table 2 AC Line Conducted Emissions Data L1

Trace	Frequency	Level (dBµV)	Detector	Delta Limit/dB
2	262.000000000 kHz	15.15	Average	-36.22
2	274.000000000 kHz	15.57	Average	-35.42
2	290.000000000 kHz	14.69	Average	-35.83
1	294.000000000 kHz	23.38	Quasi Peak	-37.03
2	298.000000000 kHz	15.83	Average	-34.47
2	306.000000000 kHz	14.18	Average	-35.90
1	378.000000000 kHz	23.31	Quasi Peak	-35.01
2	394.000000000 kHz	23.55	Average	-24.43
1	394.000000000 kHz	33.78	Quasi Peak	-24.20
1	754.000000000 kHz	22.01	Quasi Peak	-33.99
1	1.114000000 MHz	18.17	Quasi Peak	-37.83
1	27.388000000 MHz	7.73	Quasi Peak	-52.27

Other emissions present had amplitudes at least 20 dB below the limit.

Table 3 AC Line Conducted Emissions Data L2

Trace	Frequency	Level (dBµV)	Detector	Delta Limit/dB
1	150.000000000 kHz	20.87	Quasi Peak	-45.13
1	250.000000000 kHz	16.59	Quasi Peak	-45.16
1	258.000000000 kHz	21.53	Quasi Peak	-39.96
2	258.000000000 kHz	11.92	Average	-39.57
2	278.000000000 kHz	12.04	Average	-38.84
1	278.000000000 kHz	21.54	Quasi Peak	-39.34
2	298.000000000 kHz	11.53	Average	-38.77
1	298.000000000 kHz	21.05	Quasi Peak	-39.25
2	314.000000000 kHz	10.04	Average	-39.83
2	394.000000000 kHz	19.04	Average	-28.94
1	394.000000000 kHz	30.50	Quasi Peak	-27.48
2	402.000000000 kHz	17.24	Average	-30.57

Other emissions present had amplitudes at least 20 dB below the limit.

Summary of Results for AC Line Conducted Emissions Results

The EUT demonstrated compliance with the AC Line Conducted Emissions requirements of 47CFR Part 15C and other applicable emissions requirements. The EUT worst-case configuration demonstrated a minimum margin of -24.2 dB below the requirement. Other emissions were present with amplitudes at least 20 dB below the limit and worst-case amplitudes recorded.

General Radiated Emissions Procedure

The EUT was arranged in typical equipment configurations and operated through available modes during testing. Preliminary testing was performed in a screen room with the EUT positioned 1 meter from the FSM. Radiated emissions measurements were performed to identify the frequencies, which produced the highest emissions. Each radiated emission was then maximized at the OATS location before final radiated measurements were performed. Final data was taken with the EUT located at the OATS at a distance of 3 meters between the EUT and the receiving antenna. The frequency spectrum from 9 kHz to 10,000 MHz was searched for general radiated emissions. Measured emission levels were maximized by EUT placement on the table, rotating the turntable through 360 degrees, varying the antenna height between 1 and 4 meters above the ground plane and changing antenna position between horizontal and vertical polarization. Antennas used were Loop from 9 kHz to 30 MHz, Broadband Biconical from 30 to 200 MHz, Biconilog from 30 to 1000 MHz, Log Periodic from 200 MHz to 1 GHz and or double Ridge or pyramidal horns and mixers above 1 GHz, notch filters and appropriate amplifiers and external mixers were utilized.

Table 6 General Radiated Emissions Data

Frequency (MHz)	Horizontal Peak (dB μ V/m)	Horizontal Quasi-Peak (dB μ V/m)	Vertical Peak (dB μ V/m)	Vertical Quasi-Peak (dB μ V/m)	Limit @ 3m (dB μ V/m)	Horizontal Margin (dB)	Vertical Margin (dB)
47.8	34.2	28.7	37.3	33.1	40.0	-11.3	-6.9
49.2	32.6	26.5	38.5	33.7	40.0	-13.5	-6.3
51.1	34.7	27.8	37.6	31.7	40.0	-12.2	-8.3
75.0	32.9	26.3	30.8	26.0	40.0	-13.7	-14.0
78.8	35.6	31.3	29.8	22.4	40.0	-8.7	-17.6
80.8	33.2	26.4	32.0	21.7	40.0	-13.6	-18.3
120.0	26.5	20.8	27.2	21.1	40.0	-19.2	-18.9

Other emissions present had amplitudes at least 20 dB below the limit. Peak and Quasi-Peak amplitude emissions are recorded for frequency range below 1000 MHz. Peak and Average amplitude emissions are recorded for frequency range above 1000 MHz.

Summary of Results for General Radiated Emissions

The EUT demonstrated compliance with the radiated emissions requirements of CFR47 Paragraph 15.209, RSS-247 Issue 2 and RSS-GEN Issue 5 emission requirements. The EUT demonstrated a minimum margin of -6.3 dB below the requirements. Other emissions were present with amplitudes at least 20 dB below the Limits.

Operation in the Band 902-928 MHz

Test procedures of ANSI C63.10-2013 and KDB 558074 D01 15.247 Meas Guidance v05 were used during transmitter testing. The transmitter peak power was measured at the antenna port as described in ANSI C63.10-2013. The 20-dB and 99% emission bandwidths were measured as described in C63.10-2013. The channel separation and the number of hopping channels were measured at the antenna port as described in C63.10-2013. The system utilizes at least 50 channels with average time of occupancy on any channel not exceeding 0.4 seconds within a 20 second period. The transmitter radiated spurious and general emissions were measured on an open area test site @ 3 meters. During radiated emissions measurements the EUT sample #1 was placed on a turntable elevated as required above the ground plane at a distance of 3 meters from the measurement antenna. The amplitude of each emission was then recorded from the measurement results. The test system gains and losses were accounted for in the measurement results presented. The amplitude of each radiated emission was maximized by equipment orientation and placement on the turn table, raising and lowering the FSM (Field Strength Measuring) antenna, changing the FSM antenna polarization, and by rotating the turntable. A Loop antenna was used for measuring emissions from 0.009 to 30 MHz, Biconilog Antenna for 30 to 1000 MHz, Double-Ridge, and/or Pyramidal Horn Antennas from 1 GHz to 10 GHz. Emissions were measured in dB μ V/m @ 3 meters. Antenna port conducted emission data and plots were taken using test sample #2.

Refer to figures 3 through 12 showing plots taken of the 902-928 MHz operation displaying compliance with the specifications.

Requirement: Average occupancy time Requirement:

Average time of occupancy on any channel shall not be greater than 400 mS (0.4 seconds) within a 20 second period.

Time on channel: The design resides on channel 12 times in a 20 second period. Transmitting each time for 30.05 mS which equates to an average time of occupancy of $(30.05\text{mS} * 12)$ 360.6 mS in 20 second period.

The 360 mS average occupancy time demonstrates compliance with requirement of less than 400 mS in 20 second period.

Additional Frequency Hopping detail may be found in the operational description exhibits.

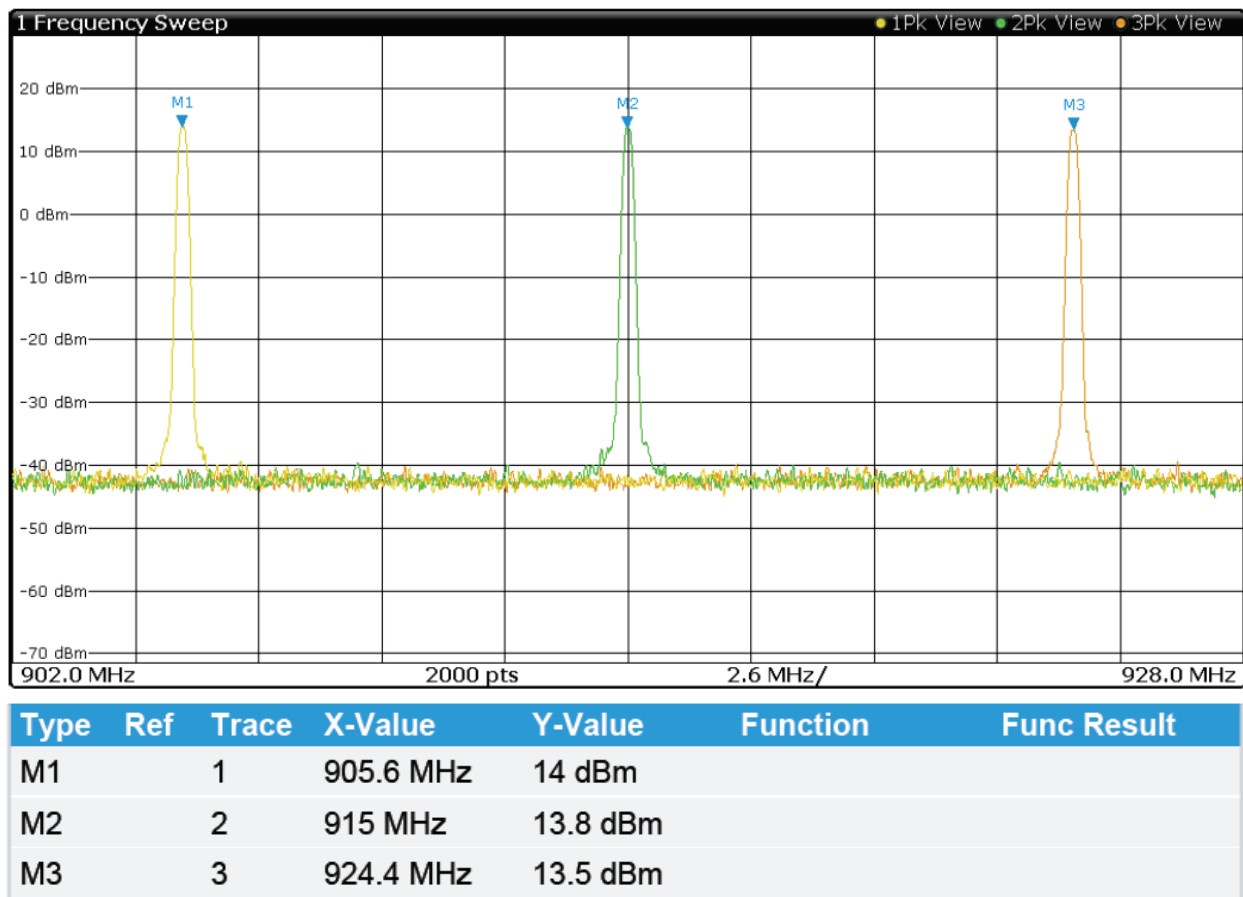

Figure 3 Plot of Transmitter Operation across 902-928 MHz

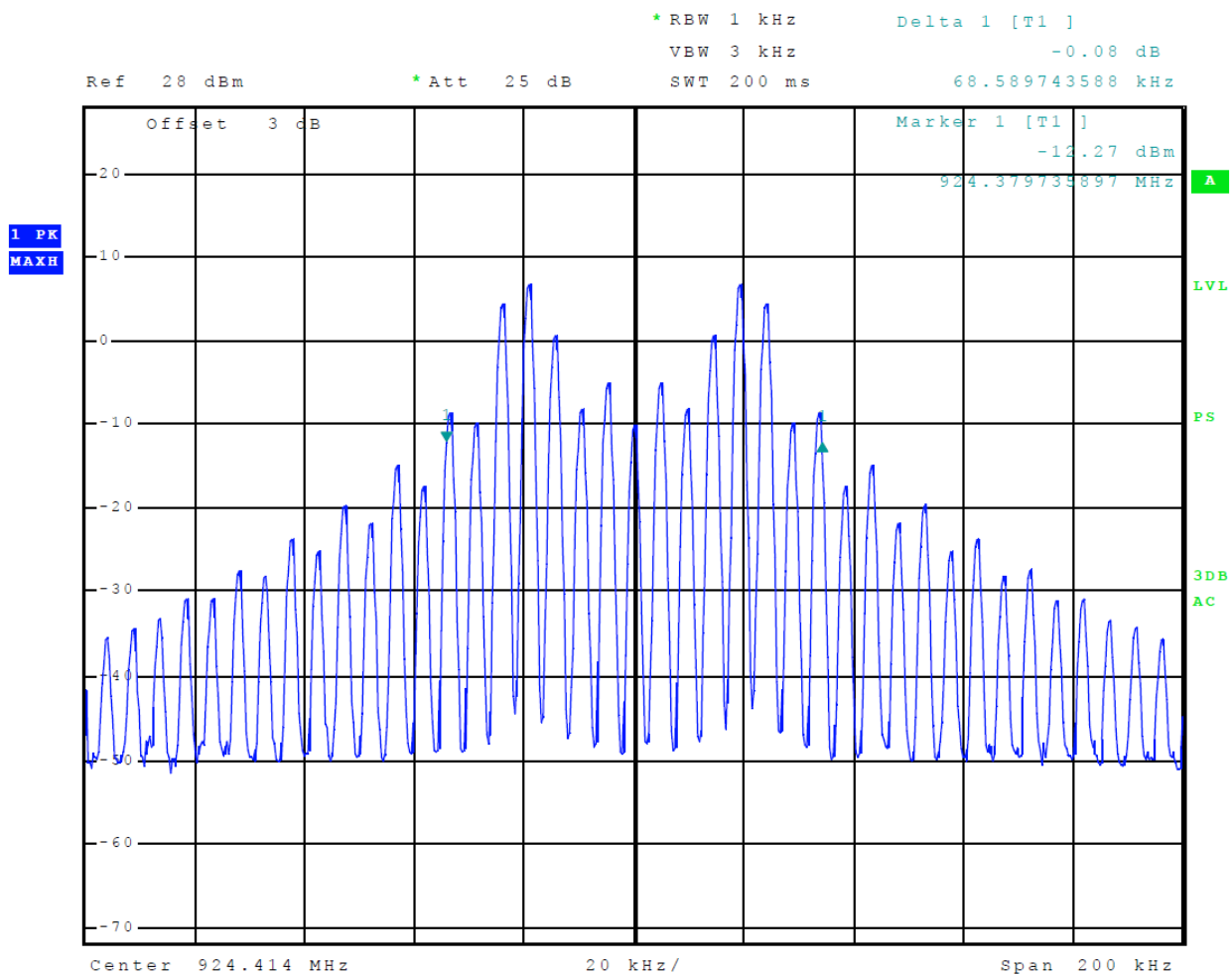

Figure 4 Plot of Transmitter Emissions 20-dB Occupied Bandwidth

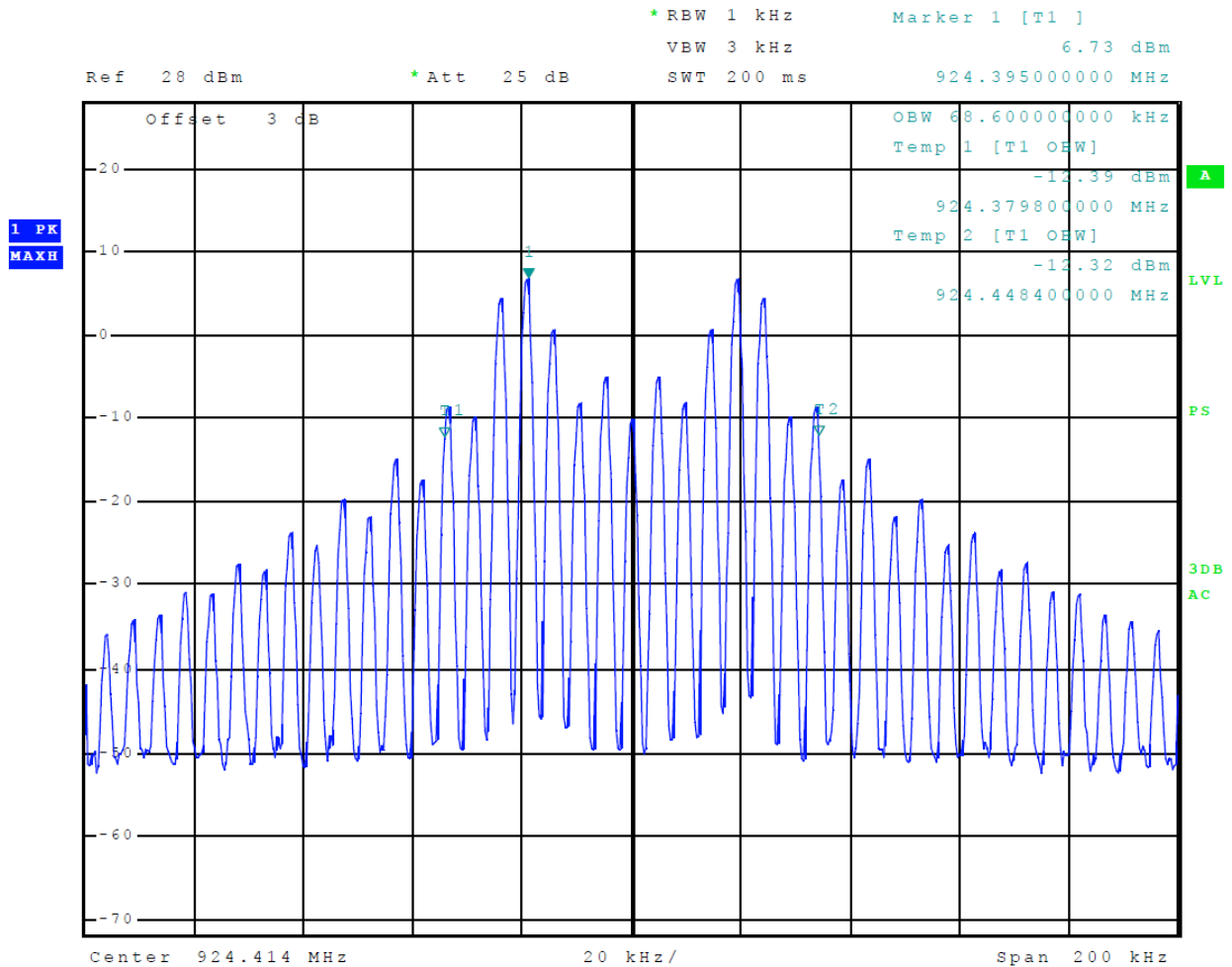

Figure 5 Plot of Transmitter Emissions 99% Occupied Bandwidth

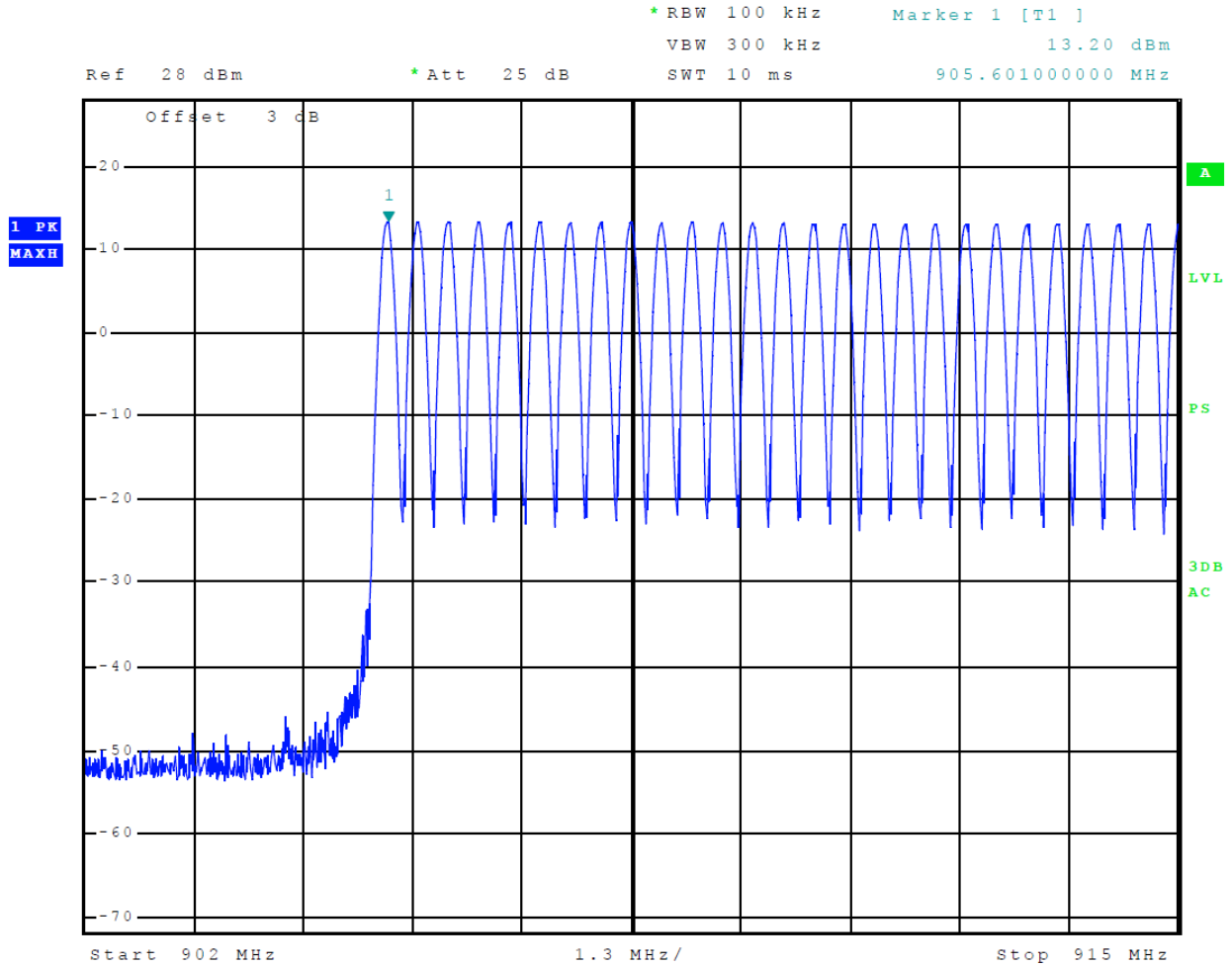

Figure 6 Plot of Number of Hopping Channels

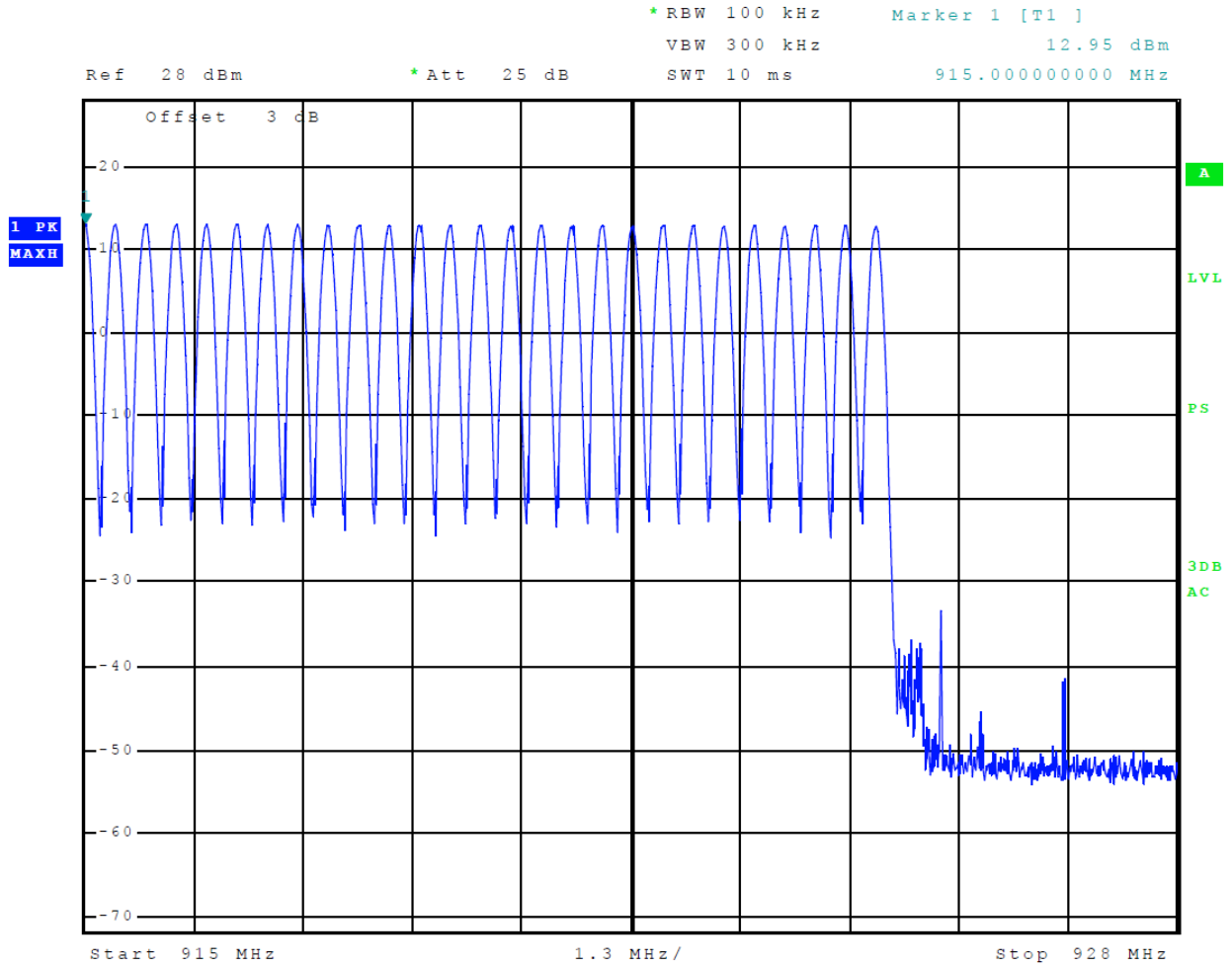

Figure 7 Plot of Number of Hopping Channels

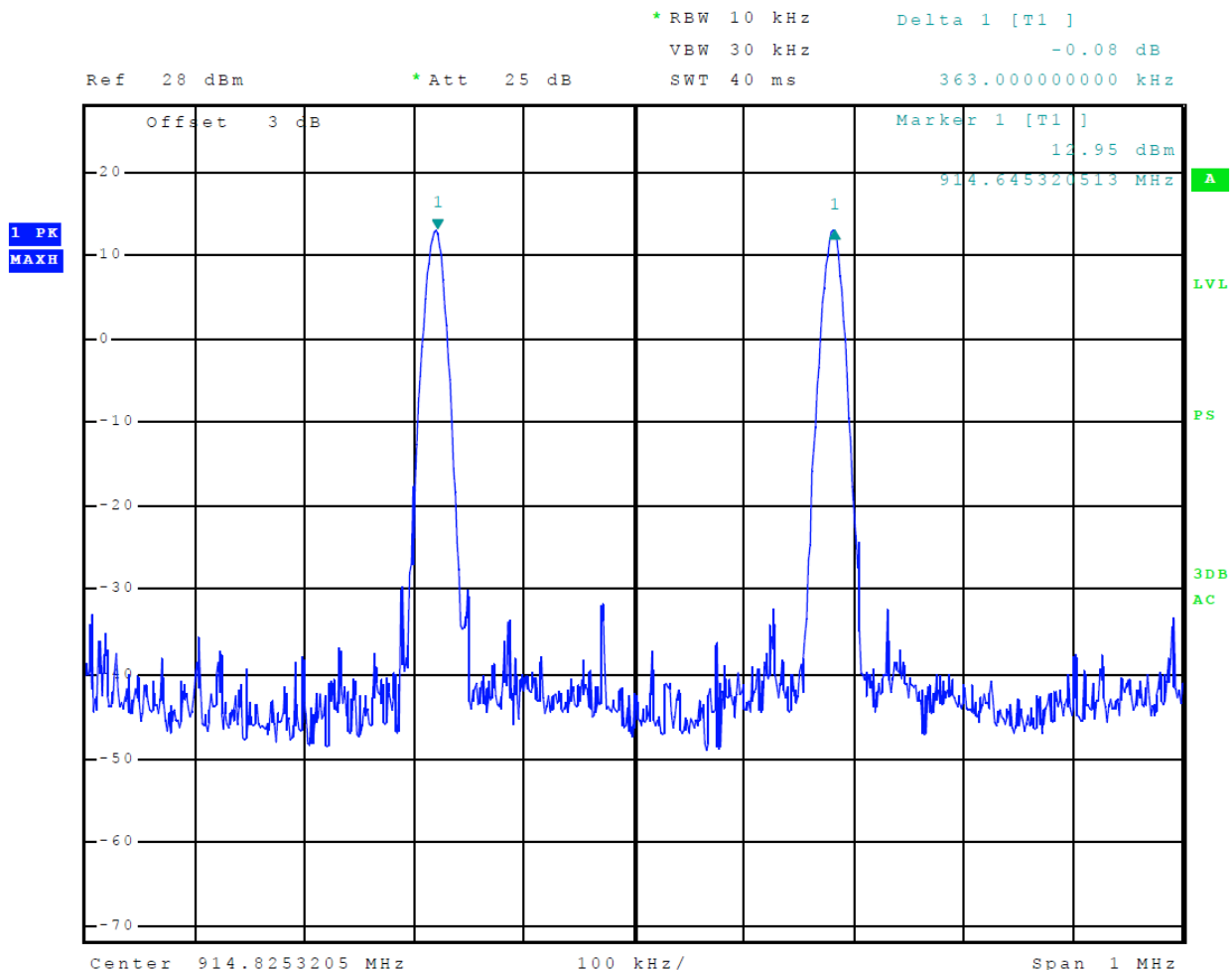

Figure 8 Plot of Channel Separation

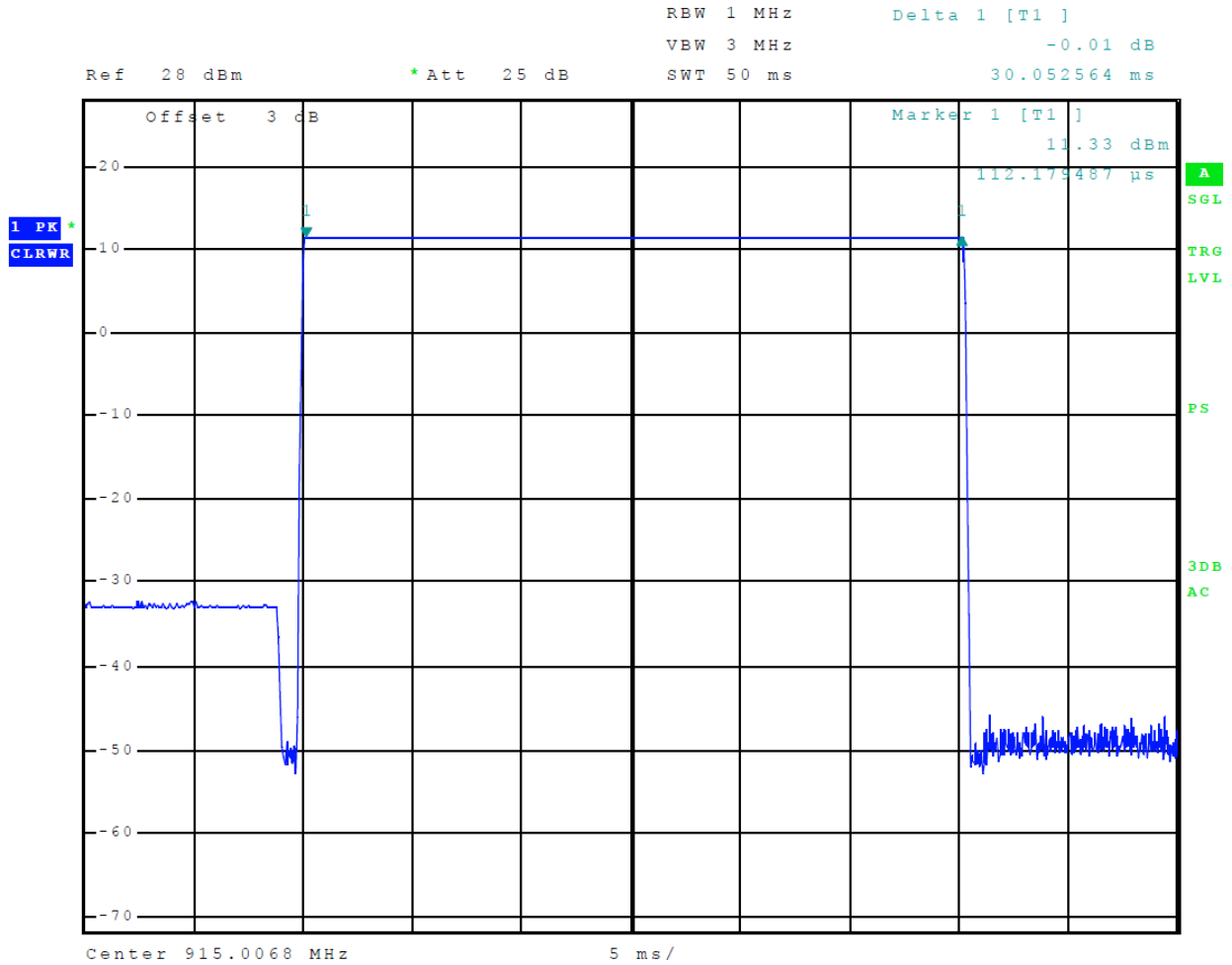

Figure 9 Plot of Dwell Time on Channel

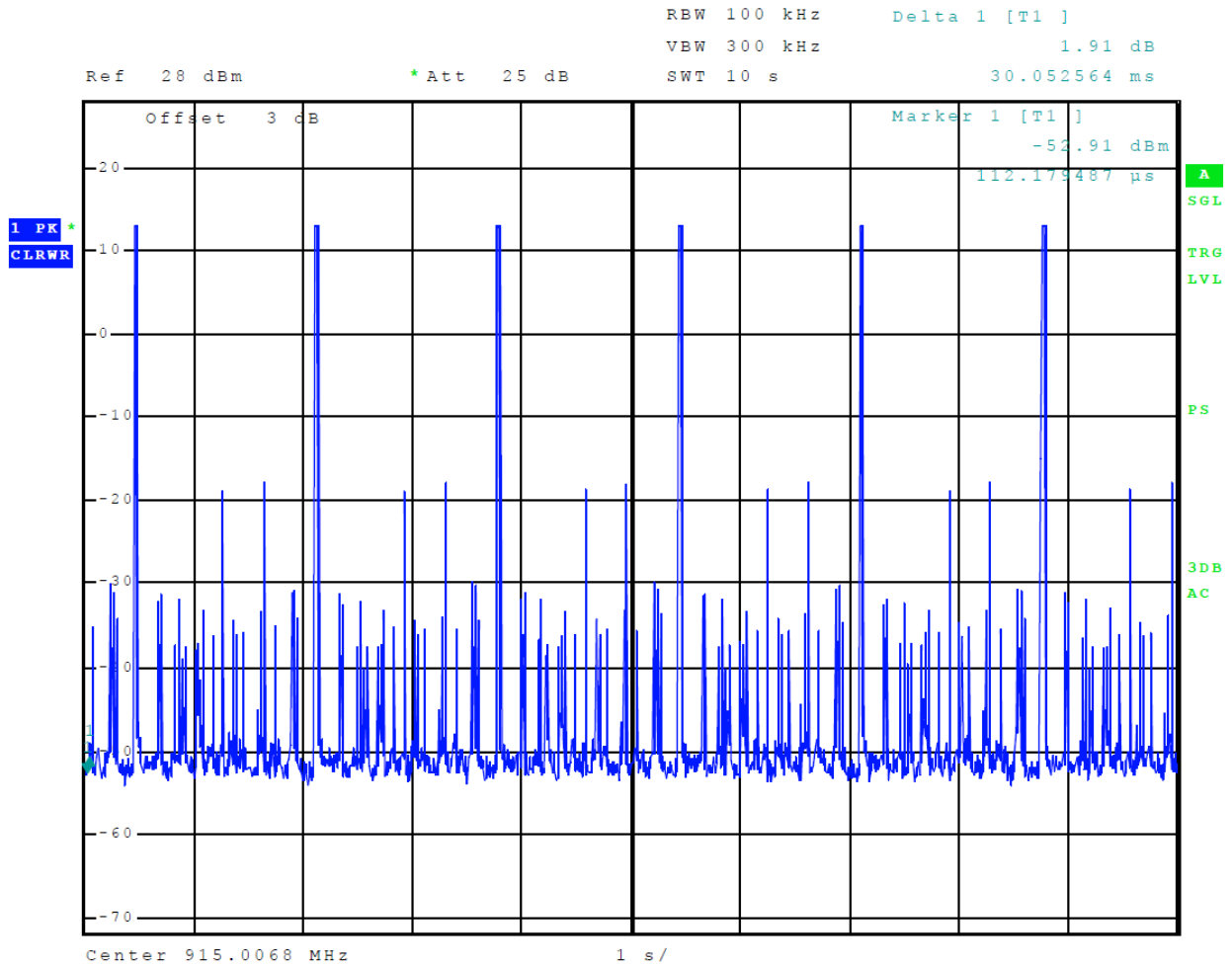

Figure 10 Plot of 6 Times on Channel over 10 second period

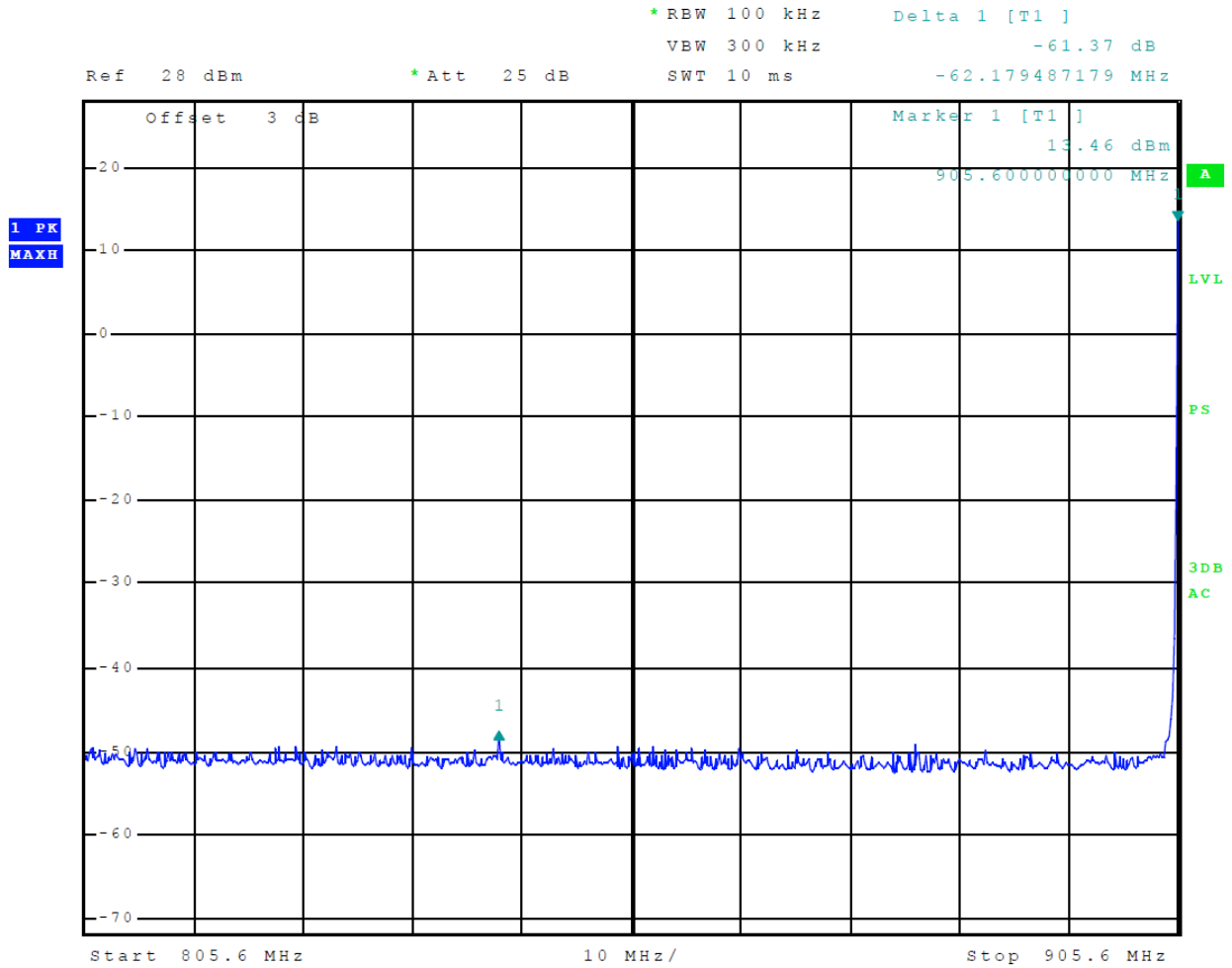

Figure 11 Plot of Transmitter Emissions Low Band Edge Channels Hopping

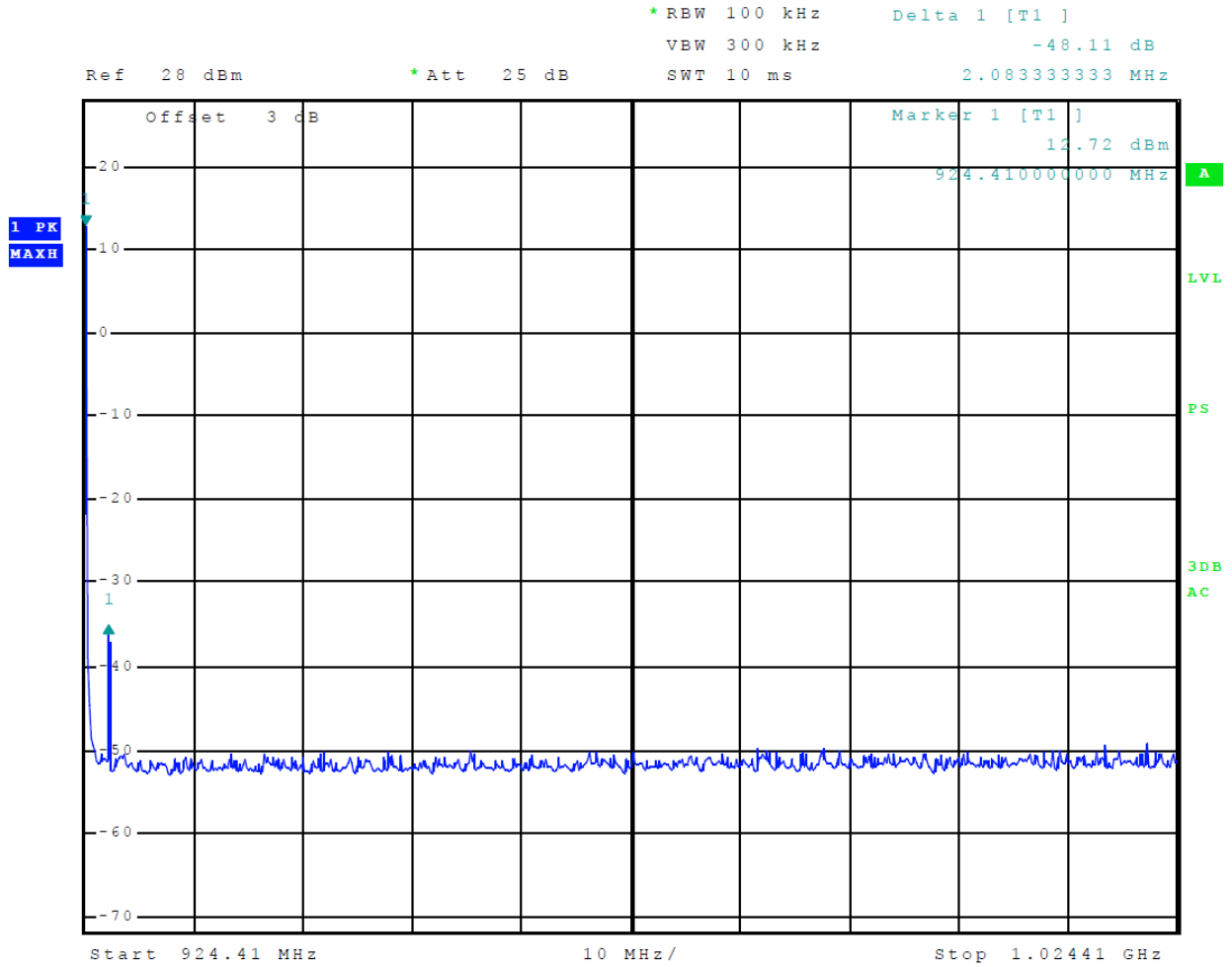

Figure 12 Plot of Transmitter Emissions High Band Edge Channels Hopping

Transmitter Emissions Data

Table 7 Transmitter Radiated Emissions

Frequency (MHz)	Horizontal Peak (dB μ V/m)	Horizontal Average (dB μ V/m)	Vertical Peak (dB μ V/m)	Vertical Average (dB μ V/m)	Limit @ 3m (dB μ V/m)	Horizontal Margin (dB)	Vertical Margin (dB)
905.6	--	--	--	--	--	--	--
1811.2	50.4	49.5	46.9	45.9	54.0	-4.5	-8.1
2716.8	46.6	44.8	38.3	34.6	54.0	-9.2	-19.4
3622.4	45.4	43.1	41.2	38.0	54.0	-10.9	-16.0
4528.0	37.8	32.4	38.4	32.3	54.0	-21.6	-21.7
5433.6	39.1	33.5	38.7	33.4	54.0	-20.5	-20.6
6339.2	43.3	37.1	42.4	37.1	54.0	-16.9	-16.9
915.0	--	--	--	--	--	--	--
1830.0	44.9	43.0	45.1	43.7	54.0	-11.0	-10.3
2745.0	46.4	44.3	42.2	39.7	54.0	-9.7	-14.3
3660.0	40.8	37.2	36.4	31.2	54.0	-16.8	-22.8
4575.0	38.8	33.2	38.5	33.3	54.0	-20.8	-20.7
5490.0	39.9	34.5	39.9	34.5	54.0	-19.5	-19.5
6405.0	42.4	36.7	42.1	36.8	54.0	-17.3	-17.2
924.4	--	--	--	--	--	--	--
1848.8	42.8	40.8	43.3	41.6	54.0	-13.2	-12.4
2773.2	46.7	45.1	42.5	39.8	54.0	-8.9	-14.2
3697.6	39.1	34.7	37.5	31.6	54.0	-19.3	-22.4
4622.0	39.4	33.9	39.1	33.8	54.0	-20.1	-20.2
5546.4	39.6	34.6	40.2	34.6	54.0	-19.4	-19.4
6470.8	43.4	37.0	41.7	36.6	54.0	-17.0	-17.4

Other emissions present had amplitudes at least 20 dB below the limit. Peak and Quasi-Peak amplitude emissions are recorded for frequency range below 1000 MHz. Peak and Average amplitude emissions are recorded for frequency range above 1000 MHz.

Table 8 Transmitter Antenna Port Data

Frequency MHz	Output Power (dBm)	Output Power (Watts)	99% Occupied Bandwidth (kHz)	20-dB Occupied Bandwidth (kHz)
905.6	14.0	0.025	68.6	68.6
915.0	13.8	0.024	68.4	68.6
924.4	13.5	0.022	68.6	68.6

Summary of Results for Transmitter Radiated Emissions of Intentional Radiator

The EUT demonstrated compliance with the regulations and emission requirements of 47 CFR Part 15.247, Industry Canada RSS-247 Issue 2 and RSS-GEN Issue 5. The antenna port conducted output power measured was 0.025 Watts. The unit utilizes 53 hopping channels with the average time of occupancy less than 0.4 seconds over the required time. The EUT worse-case configuration demonstrated minimum radiated harmonic emission margin of -4.5 dB below the limit. No other radiated emissions were found in the restricted bands less than 20 dB below limits than those recorded in this report. Other emissions were present with amplitudes at least 20 dB below the limits.

Annex

- Annex A Measurement Uncertainty Calculations
- Annex B Test Equipment
- Annex C Rogers Qualifications
- Annex D Laboratory Certificate of Accreditation

Annex A Measurement Uncertainty Calculations

The measurement uncertainty was calculated for all measurements listed in this test report according To CISPR 16-4. Result of measurement uncertainty calculations are recorded below. Component and process variability of production devices similar to those tested may result in additional deviations. The manufacturer has the sole responsibility of continued compliance.

Measurement	Expanded Measurement Uncertainty $U_{(lab)}$
3 Meter Horizontal 0.009-1000 MHz Measurements	4.16
3 Meter Vertical 0.009-1000 MHz Measurements	4.33
3 Meter Measurements 1-18 GHz	5.14
3 Meter Measurements 18-40 GHz	5.16
10 Meter Horizontal Measurements 0.009-1000 MHz	4.15
10 Meter Vertical Measurements 0.009-1000 MHz	4.32
AC Line Conducted	1.75
Antenna Port Conducted power	1.17
Frequency Stability	1.00E-11
Temperature	1.6°C
Humidity	3%

Annex B Test Equipment

<u>Equipment</u>	<u>Manufacturer</u>	<u>Model (SN)</u>	<u>Band</u>	<u>Cal Date(m/d/y)</u>	<u>Due</u>
<input checked="" type="checkbox"/> LISN	FCC	FCC-LISN-50-25-10(1PA) (160611)	.15-30MHz	4/21/2020	4/21/2021
<input checked="" type="checkbox"/> LISN	Compliance Design	FCC-LISN-2.Mod.cd,(126)	.15-30MHz	10/14/2020	10/14/2021
<input checked="" type="checkbox"/> Cable	Huber & Suhner Inc.	Sucoflex102ea(L10M)(303073)	9kHz-40 GHz	10/14/2020	10/14/2021
<input type="checkbox"/> Cable	Huber & Suhner Inc.	Sucoflex102ea(1.5M)(303069)	9kHz-40 GHz	10/14/2020	10/14/2021
<input checked="" type="checkbox"/> Cable	Huber & Suhner Inc.	Sucoflex102ea(1.5M)(303070)	9kHz-40 GHz	10/14/2020	10/14/2021
<input checked="" type="checkbox"/> Cable	Belden	RG-58 (L1-CAT3-11509)	9kHz-30 MHz	10/14/2020	10/14/2021
<input checked="" type="checkbox"/> Cable	Belden	RG-58 (L2-CAT3-11509)	9kHz-30 MHz	10/14/2020	10/14/2021
<input checked="" type="checkbox"/> Antenna	Com Power	AL-130 (121055)	.001-30 MHz	10/14/2020	10/14/2021
<input type="checkbox"/> Antenna:	EMCO	6509	.001-30 MHz	10/14/2020	10/14/2022
<input type="checkbox"/> Antenna	ARA	BCD-235-B (169)	20-350MHz	10/14/2020	10/14/2021
<input type="checkbox"/> Antenna:	Schwarzbeck Model	VHBB 9124 (9124-627)		4/21/2020	4/21/2021
<input checked="" type="checkbox"/> Antenna	Sunol	JB-6 (A100709)	30-1000 MHz	10/14/2020	10/14/2021
<input type="checkbox"/> Antenna	ETS-Lindgren	3147 (40582)	200-1000MHz	10/14/2020	10/14/2022
<input type="checkbox"/> Antenna:	Schwarzbeck Model:	VULP 9118 A (VULP 9118 A-534)		4/21/2020	4/21/2021
<input checked="" type="checkbox"/> Antenna	ETS-Lindgren	3117 (200389)	1-18 GHz	4/21/2020	4/21/2022
<input type="checkbox"/> Antenna	Com Power	AH-118 (10110)	1-18 GHz	10/14/2020	10/14/2022
<input type="checkbox"/> Antenna	Com Power	AH-840 (101046)	18-40 GHz	4/21/2020	4/21/2021
<input checked="" type="checkbox"/> Analyzer	Rohde & Schwarz	ESU40 (100108)	20Hz-40GHz	5/15/2020	5/15/2021
<input checked="" type="checkbox"/> Analyzer	Rohde & Schwarz	ESW44 (101534)	20Hz-44GHz	1/27/2020	1/27/2021
<input type="checkbox"/> Analyzer	Rohde & Schwarz	FS-Z60, 90, 140, and 220	40GHz-220GHz	12/22/2017	12/22/2027
<input checked="" type="checkbox"/> Amplifier	Com-Power	PA-010 (171003)	100Hz-30MHz	10/14/2020	10/14/2021
<input checked="" type="checkbox"/> Amplifier	Com-Power	CPPA-102 (01254)	1-1000 MHz	10/14/2020	10/14/2021
<input checked="" type="checkbox"/> Amplifier	Com-Power	PAM-118A (551014)	0.5-18 GHz	10/14/2020	10/14/2021
<input type="checkbox"/> Amplifier	Com-Power	PAM-840A (461328)	18-40 GHz	10/14/2020	10/14/2021
<input checked="" type="checkbox"/> Power Meter	Agilent	N1911A with N1921A	0.05-40 GHz	4/21/2020	4/21/2021
<input type="checkbox"/> Generator	Rohde & Schwarz	SMB100A6 (100150)	20Hz-6 GHz	4/21/2020	4/21/2021
<input type="checkbox"/> Generator	Rohde & Schwarz	SMBV100A6 (260771)	20Hz-6 GHz	4/21/2020	4/21/2021
<input type="checkbox"/> RF Filter	Micro-Tronics	BRC50722 (009).9G notch	30-18000 MHz	4/21/2020	4/21/2021
<input checked="" type="checkbox"/> RF Filter	Micro-Tronics	HPM50114 (017)1.5G HPF	30-18000 MHz	4/21/2020	4/21/2021
<input type="checkbox"/> RF Filter	Micro-Tronics	HPM50117 (063) 3G HPF	30-18000 MHz	4/21/2020	4/21/2021
<input type="checkbox"/> RF Filter	Micro-Tronics	HPM50105 (059) 6G HPF	30-18000 MHz	4/21/2020	4/21/2021
<input type="checkbox"/> RF Filter	Micro-Tronics	BRM50702 (172) 2G notch	30-18000 MHz	4/21/2020	4/21/2021
<input type="checkbox"/> RF Filter	Micro-Tronics	BRC50703 (G102) 5G notch	30-18000 MHz	4/21/2020	4/21/2021
<input type="checkbox"/> RF Filter	Micro-Tronics	BRC50705 (024) 5G notch	30-18000 MHz	4/21/2020	4/21/2021
<input type="checkbox"/> Attenuator	Fairview	SA6NFNF100W-40 (1625)	30-18000 MHz	4/21/2020	4/18/2021
<input checked="" type="checkbox"/> Attenuator	Mini-Circuits	VAT-3W2+ (1436)	30-6000 MHz	4/21/2020	4/21/2021
<input checked="" type="checkbox"/> Attenuator	Mini-Circuits	VAT-3W2+ (1445)	30-6000 MHz	4/21/2020	4/21/2021
<input type="checkbox"/> Attenuator	Mini-Circuits	VAT-3W2+ (1735)	30-6000 MHz	4/21/2020	4/21/2021
<input type="checkbox"/> Attenuator	Mini-Circuits	VAT-6W2+ (1438)	30-6000 MHz	4/21/2020	4/21/2021
<input type="checkbox"/> Attenuator	Mini-Circuits	VAT-6W2+ (1736)	30-6000 MHz	4/21/2020	4/21/2021
<input checked="" type="checkbox"/> Weather station	Davis	6312 (A81120N075)		11/4/2020	11/4/2021

Rogers Labs, Inc.
4405 West 259th Terrace
Louisburg, KS 66053
Phone/Fax: (913) 837-3214
Revision 1

Digital Monitoring Products, Inc.
Model: 1100T
Test: 201123
Test to: CFR47 15C, RSS-Gen RSS-247
File: DMP 1100T FHSS TstRpt 201123

SN's: ENG1 / ENG2
FCC ID: CCKPC0225
IC: 5251A-PC0225
Date: December 10, 2020
Page 40 of 43

List of Test Equipment	Calibration	Date (m/d/y)	Due
<input type="checkbox"/> Frequency Counter: Leader LDC-825 (8060153)		4/21/2020	4/21/2021
<input type="checkbox"/> LISN: Com-Power Model LI-220A		10/14/2020	10/14/2021
<input type="checkbox"/> LISN: Com-Power Model LI-550C		10/14/2020	10/14/2021
<input type="checkbox"/> ISN: Com-Power Model ISN T-8		4/21/2020	4/21/2021
<input type="checkbox"/> LISN: Fischer Custom Communications Model: FCC-LISN-50-16-2-08		4/21/2020	4/21/2021
<input type="checkbox"/> Cable Huber & Suhner Inc. Sucoflex102ea(1.5M)(303072) 9kHz-40 GHz		10/14/2020	10/14/2021
<input type="checkbox"/> Cable Huber & Suhner Inc. Sucoflex102ea(L1M)(281183) 9kHz-40 GHz		10/14/2020	10/14/2021
<input type="checkbox"/> Cable Huber & Suhner Inc. Sucoflex102ea(L4M)(281184) 9kHz-40 GHz		10/14/2020	10/14/2021
<input type="checkbox"/> Cable Huber & Suhner Inc. Sucoflex102ea(L10M)(317546)9kHz-40 GHz		10/14/2020	10/14/2021
<input type="checkbox"/> Cable Time Microwave 4M-750HF290-750 (4M) 9kHz-24 GHz		10/14/2020	10/14/2021
<input type="checkbox"/> RF Filter Micro-Tronics BRC17663 (001) 9.3-9.5 notch 30-1800 MHz		4/21/2020	4/21/2021
<input type="checkbox"/> RF Filter Micro-Tronics BRC19565 (001) 9.2-9.6 notch 30-1800 MHz		10/16/2018	4/21/2021
<input type="checkbox"/> Analyzer HP 8562A (3051A05950) 9kHz-125GHz		4/21/2020	4/21/2021
<input type="checkbox"/> Analyzer HP External Mixers11571, 11970 25GHz-110GHz		4/18/2015	4/18/2025
<input type="checkbox"/> Analyzer HP 8591EM (3628A00871)		4/21/2020	4/21/2021
<input type="checkbox"/> Antenna: Solar 9229-1 & 9230-1		2/22/2020	2/22/2021
<input type="checkbox"/> CDN: Com-Power Model CDN325E		10/14/2020	10/14/2021
<input type="checkbox"/> Injection Clamp Luthi Model EM101		10/14/2020	10/14/2021
<input type="checkbox"/> Oscilloscope Scope: Tektronix MDO 4104		2/22/2020	2/22/2021
<input type="checkbox"/> EMC Transient Generator HVT TR 3000		2/22/2020	2/22/2021
<input type="checkbox"/> AC Power Source (Ametech, California Instruments)		2/22/2020	2/22/2021
<input type="checkbox"/> Field Intensity Meter: EFM-018		2/22/2020	2/22/2021
<input type="checkbox"/> ESD Simulator: MZ-15		2/22/2020	2/22/2021
<input type="checkbox"/> R.F. Power Amp ACS 230-50W			not required
<input type="checkbox"/> R.F. Power Amp EIN Model: A301			not required
<input type="checkbox"/> R.F. Power Amp A.R. Model: 10W 1010M7			not required
<input type="checkbox"/> R.F. Power Amp A.R. Model: 50U1000			not required
<input checked="" type="checkbox"/> Shielded Room			not required

Annex C Rogers Qualifications

Scot D. Rogers, Engineer

Rogers Labs, Inc.

Mr. Rogers has approximately 35 years' experience in the field of electronics. Working experience includes six years working in the automated controls industry and 6 years working with the design, development and testing of radio communications and electronic equipment.

Positions Held:

Systems Engineer: A/C Controls Mfg. Co., Inc. 6 Years

Electrical Engineer: Rogers Consulting Labs, Inc. 5 Years

Electrical Engineer: Rogers Labs, Inc. Current

Educational Background:

Bachelor of Science Degree in Electrical Engineering from Kansas State University

Bachelor of Science Degree in Business Administration Kansas State University

Several Specialized Training courses and seminars pertaining to Microprocessors and Software programming

Annex D Laboratory Certificate of Accreditation

United States Department of Commerce
National Institute of Standards and Technology

NVLAP 

Certificate of Accreditation to ISO/IEC 17025:2017

NVLAP LAB CODE: 200087-0

Rogers Labs, Inc.
Louisburg, KS

*is accredited by the National Voluntary Laboratory Accreditation Program for specific services,
listed on the Scope of Accreditation, for:*

Electromagnetic Compatibility & Telecommunications

*This laboratory is accredited in accordance with the recognized International Standard ISO/IEC 17025:2017.
This accreditation demonstrates technical competence for a defined scope and the operation of a laboratory quality
management system (refer to joint ISO-ILAC-IAF Communiqué dated January 2009).*

2020-02-25 through 2021-03-31
Effective Dates



For the National Voluntary Laboratory Accreditation Program

Rogers Labs, Inc.
4405 West 259th Terrace
Louisburg, KS 66053
Phone/Fax: (913) 837-3214
Revision 1

Digital Monitoring Products, Inc.
Model: 1100T
Test: 201123
Test to: CFR47 15C, RSS-Gen RSS-247
File: DMP 1100T FHSS TstRpt 201123

SN's: ENG1 / ENG2
FCC ID: CCKPC0225
IC: 5251A-PC0225
Date: December 10, 2020
Page 43 of 43