

Application Submittal Report

FOR

FCC And Industry Canada
Grant Of Certification

FOR

Model: 1137
903-927 MHz
Low Power Transmitter

FCC ID: CCKPC0166
IC: 5251A-PC0166

FOR

Digital Monitoring Products, Inc.

2500 North Partnership Boulevard
Springfield, MO 65802-6310

Test Report Number: 150316
IC Test Site Registration: 3041A-1

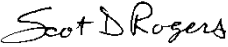
Authorized Signatory: 
Scot D. Rogers

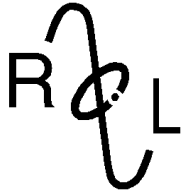

ROGERS LABS, INC.

4405 West 259th Terrace
Louisburg, KS 66053
Phone / Fax (913) 837-3214

Engineering Test Report For Application Submittal for Grant of Certification

FOR
CFR 47, PART 15C - Intentional Radiators Paragraph 15.249 and
Industry Canada, RSS-210
License Exempt Intentional Radiator

For

Digital Monitoring Products, Inc.

2500 North Partnership Boulevard
Springfield, MO 65802-6310

Model: 1137
Low Power Transmitter
Frequency Range 903-927 MHz
FCC ID#: CCKPC0166
IC: 5251A-PC0166

Test Date: March 16, 2015

Certifying Engineer: *Scot D. Rogers*
Scot D. Rogers
Rogers Labs, Inc.
4405 West 259th Terrace
Louisburg, KS 66053
Telephone/Facsimile: (913) 837-3214

This report shall not be reproduced except in full, without the written approval of the laboratory.
This report must not be used by the client to claim product certification, approval, or
endorsement by NVLAP, NIST, or any agency of the Federal Government.



Table Of Contents

TABLE OF CONTENTS..... 3

REVISIONS..... 4

FORWARD 5

OPINION / INTERPRETATION OF RESULTS 5

STATEMENT OF MODIFICATIONS AND DEVIATIONS 5

EQUIPMENT TESTED..... 6

EQUIPMENT FUNCTION AND CONFIGURATION..... 6

 Equipment Configuration.....6

APPLICATION FOR CERTIFICATION..... 7

APPLICABLE STANDARDS & TEST PROCEDURES 8

EQUIPMENT TESTING PROCEDURES 8

 AC Line Conducted Emission Test Procedure8

 Radiated Emission Test Procedure.....8

 Diagram 1 Test arrangement for radiated emissions of tabletop equipment.....9

 Diagram 2 Test arrangement for radiated emissions tested on Open Area Test Site (OATS).....10

TEST SITE LOCATIONS 10

LIST OF TEST EQUIPMENT 11

UNITS OF MEASUREMENTS 12

ENVIRONMENTAL CONDITIONS..... 12

INTENTIONAL RADIATORS..... 12

 Antenna Requirements12

 Restricted Bands of Operation.....12

 Table One Radiated Emissions in Restricted Bands Data13



Summary of Results for Radiated Emissions in Restricted Bands13

AC Line Conducted Emissions Procedure13

General Radiated EMI Testing Procedure14

 Table Two General Radiated Emissions Data (worst-case).....15

Summary of Results for General Radiated Emissions15

Operation in the Band 902 – 928 MHz16

 Figure One Plot of Output Across Operational Band17

 Figure Two Plot of Occupied Bandwidth17

 Figure Three Plot of Low Band Edge18

 Figure Four Plot of High Band Edge18

Transmitter Emissions Data.....19

 Table Five Transmitter Radiated Emission Data19

Summary of Results for Radiated Emissions of Intentional Radiator20

ANNEX..... 21

Annex A Measurement Uncertainty Calculations.....22

Annex B Rogers Labs Test Equipment List.....23

Annex C Rogers Qualifications24

Annex D FCC Site Registration Letter.....25

Annex E Industry Canada Site Registration Letter26

Revisions

Revision 1 Issued April 1, 2015



Forward

The following information is submitted for consideration in obtaining Grant of Certification for License Exempt FHSS Intentional Radiator operating under CFR 47 Paragraph 15.249 and Industry Canada RSS-210.

Name of Applicant: Digital Monitoring Products, Inc.
2500 North Partnership Boulevard
Springfield, MO 65802-6310

Model: 1137

FCC I.D.: CCKPC0166 IC: 5251A-PC0166

Frequency Range: 903-927 MHz

Operating Power: 89.5 average, 89.7 Peak) dBµV/m@3m, Occupied Bandwidth 99.9 kHz

Opinion / Interpretation of Results

Test Performed	Minimum Margin (dB)	Results
Antenna requirement per CFR 47 15.203	N/A	Complies
Restricted Bands (Tx) Emissions as per CFR 47 15.205 and RSS-210	-3.4	Complies
AC Line Conducted Emissions as per CFR 47 15.207	N/A	Complies
Radiated Emissions as per CFR 47 15.209 and RSS-210	-5.6	Complies
Radiated Emissions per CFR 47 15.249 and RSS-210 (harmonics)	-2.5	Complies

Statement of Modifications and Deviations

No modifications to the EUT were required for the unit to demonstrate compliance with the CFR47 Part 15C or RSS-210 emissions requirements. There were no deviations or exceptions to the specifications.

Equipment Tested

<u>Equipment</u>	<u>Model</u>	<u>FCC I.D. #</u>
EUT	1137	CCKPC0166

Test results in this report relate only to the items tested.

Equipment Function and Configuration

The EUT is a 903-927 MHz low power transmitter used to wirelessly interface with compliant equipment in an alarm panel installation. The 1137 Transceiver performs remote switch activation for emergency lighting for use in alarm system installation. The design operates from direct current replaceable battery power only and offers no provision for connection to utility power systems or other interfacing. Test software was used for testing which allowed the unit to transmit at 100% duty cycle on defined channels. The unit typically resides in a low power state conserving battery life thus emission test results are significantly higher than typical operation would allow. New batteries were used to power the EUT during testing. Testing of the 1137 was performed with the EUT orientated in three orthogonal axis during testing with worst case emission presented. As requested by the manufacturer and required by regulations, the equipment was tested for emissions compliance using the available configurations with the worst-case data presented. Test results in this report relate only to the products described in this report.

Equipment Configuration

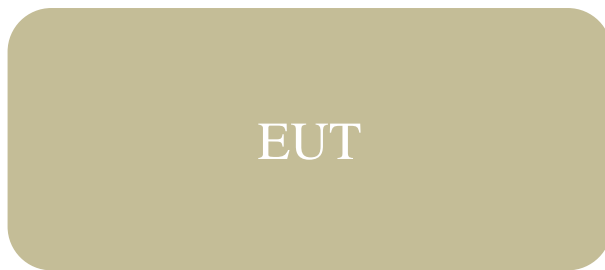

Application for Certification

- (1) Manufacturer: Digital Monitoring Products, Inc.
2500 North Partnership Boulevard
Springfield, MO 65802-6310
- (2) Identification: Model: 1137
FCC I.D.: CCKPC0166
IC: 5251A-PC0166
- (3) Instruction Book:
Refer to Exhibit for Instruction Manual.
- (4) Description of Circuit Functions:
Refer to Exhibit of Operational Description.
- (5) Block Diagram with Frequencies:
Refer to Exhibit of Operational Description.
- (6) Report of Measurements:
Report of measurements follows in this Report.
- (7) Photographs: Construction, Component Placement, etc.:
Refer to Exhibit for photographs of equipment.
- (8) List of Peripheral Equipment Necessary for operation. The equipment operates from direct current power supplied replaceable battery only and offers no other interface provisions.
- (9) Transition Provisions of 15.37 are not being requested.
- (10) Not Applicable. The unit is not a scanning receiver.
- (11) Not Applicable. The EUT does not operate in the 59 – 64 GHz frequency band.
- (12) The equipment is not software defined and this section is not applicable.

Applicable Standards & Test Procedures

In accordance with the Federal Communications Code of Federal Regulations, dated October 1, 2014, Part 2, Subpart J, Paragraphs 2.907, 2.911, 2.913, 2.925, 2.926, 2.1031 through 2.1057, and applicable parts of paragraph 15, Part 15C Paragraph 15.249 and Industry Canada standard RSS-210 Issue 8 the following information is submitted. Test procedures used are the established Methods of Measurement of Radio-Noise Emissions as described in ANSI C63.10-2013.

Equipment Testing Procedures

AC Line Conducted Emission Test Procedure

The EUT operates form direct current power only and has no provision for connection to utility AC power systems. Therefore, no AC power line conducted emissions testing was taken or required.

Radiated Emission Test Procedure

The EUT was placed on a rotating 1 x 1.5-meter wooden platform, 0.8 meters above the ground plane at a distance of 3 meters from the FSM antenna. Radiated emissions testing was performed as required in CFR47 15, RSS-210 and specified in sections 6 and 7 of ANSI C63.10-2013. EMI energy was maximized by equipment placement permitting orientation in three orthogonal axis, raising and lowering the FSM antenna, changing the antenna polarization, and by rotating the turntable. Each emission was maximized before data was taken using a spectrum analyzer. The frequency spectrum from 9 kHz to 25,000 MHz was searched for during preliminary investigation. Refer to diagrams 1 and 2 showing typical test arrangement and photographs in the test setup exhibits for specific EUT placement during testing.

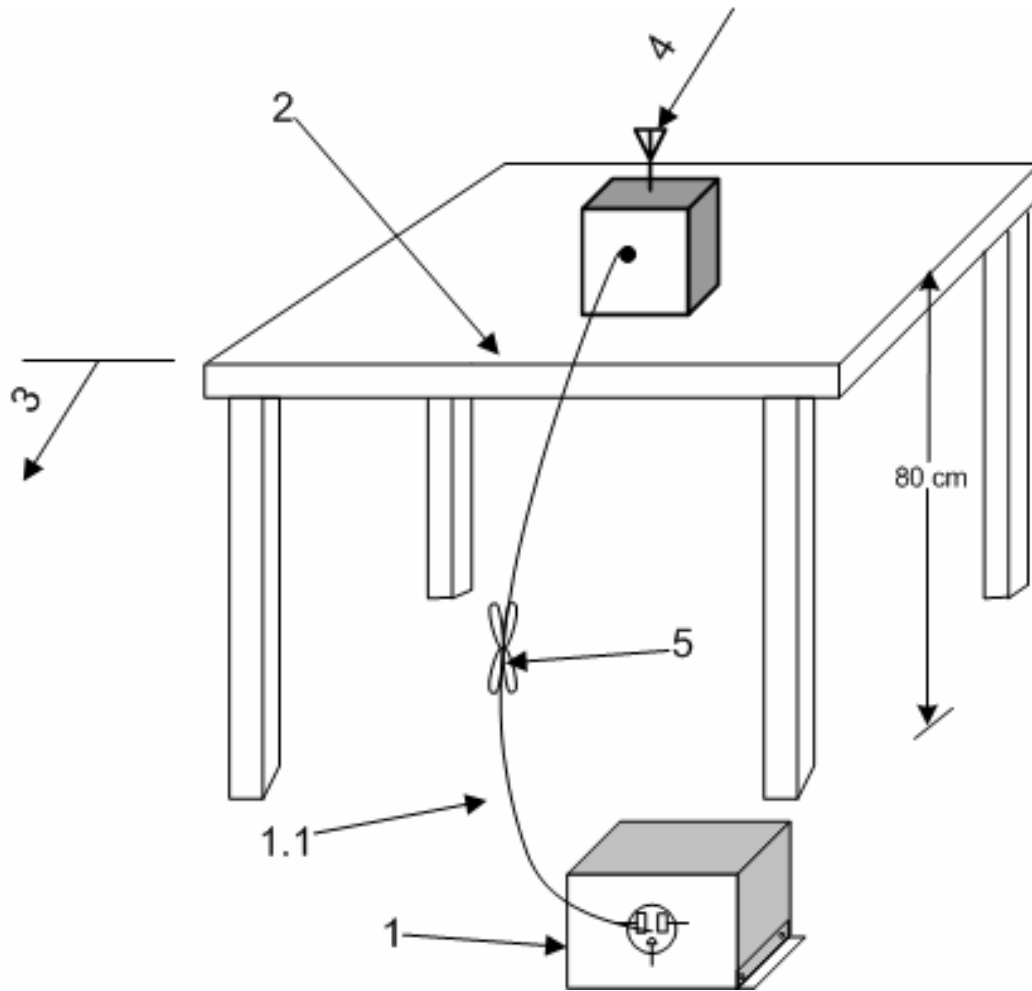

1. A LISN is optional for radiated measurements between 30 MHz to 1000 MHz, but not allowed for measurements below 30 MHz and above 1000 MHz. (See 6.4.3, 6.5.1, and 6.6.3.) If used, connect EUT to one LISN. Unused LISN measuring port connectors shall be terminated in 50Ω. LISN can be placed on top of, or immediately beneath, reference ground plane (see 6.2.2 and 6.2.3.1).
 - 1.1 LISN spaced at least 80 cm from nearest part of EUT chassis.
2. The EUT shall be placed in the center of the table to the extent possible. (See 6.2.3.1 and 6.3.4).
3. A vertical conducting plane, if used for conducted tests per 6.2.2, shall be removed for radiated emission tests.
4. Antenna may be integral or detachable, depending on the EUT.
5. Interconnecting cables that hang closer than 40 cm to the ground plane shall be folded back and forth in the center forming a bundle 30 cm to 40 cm long.

Diagram 1 Test arrangement for radiated emissions of tabletop equipment

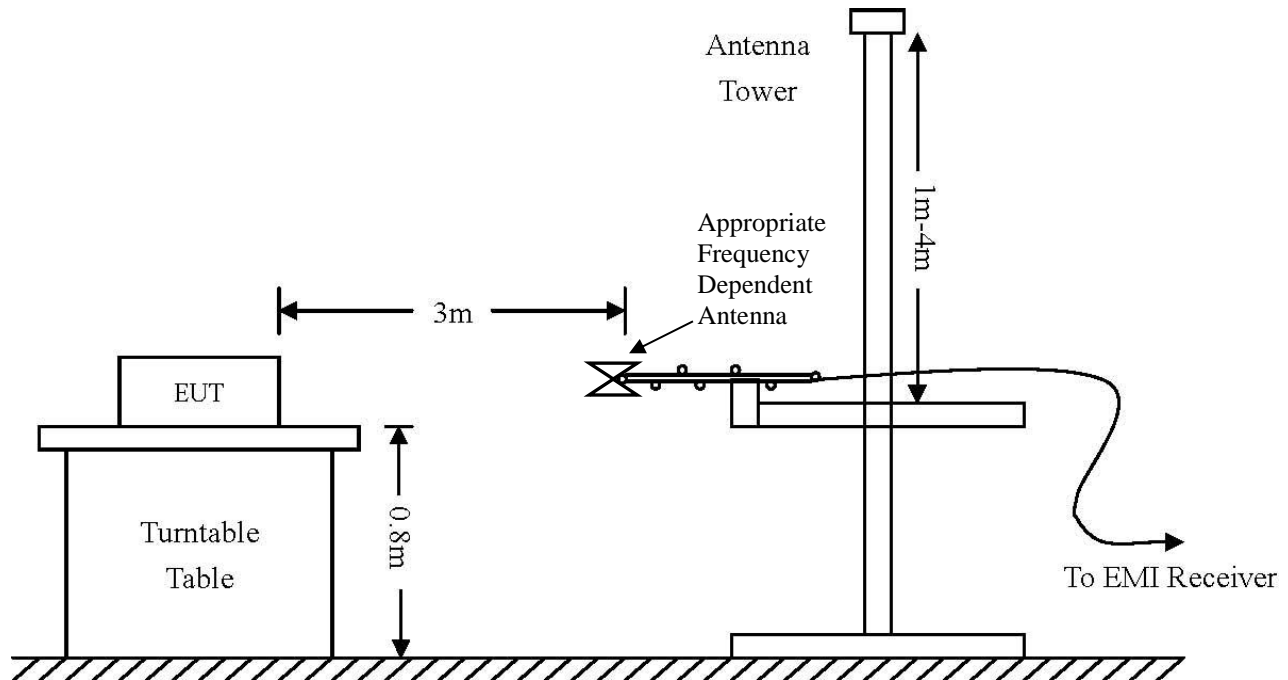

Frequency: 9 kHz-30 MHz	Frequency: 30 MHz- 1 GHz	Frequency: Above 1 GHz
Loop Antenna	Broadband Biconilog	Horn
RBW = 9 kHz	RBW = 120 kHz	RBW = 1 MHz
VBW = 30 kHz	VBW = 120 kHz	VBW = 1 MHz
Sweep time = Auto	Sweep time = Auto	Sweep time = Auto
Detector = PK, QP	Detector = PK, QP	Detector = PK, AV
Antenna Height 1m	Antenna Height 1-4m	Antenna Height 1-4m

Diagram 2 Test arrangement for radiated emissions tested on Open Area Test Site (OATS)

Test Site Locations

Conducted EMI The AC power line conducted emissions testing performed in a shielded screen room located at Rogers Labs, Inc., 4405 W. 259th Terrace, Louisburg, KS

Radiated EMI The radiated emissions tests were performed at the 3 meters, Open Area Test Site (OATS) located at Rogers Labs, Inc., 4405 W. 259th Terrace, Louisburg, KS

Site Registration Refer to Annex for Site Registration Letters (FCC: 90910, IC 3041A-1)

NVLAP Accreditation Lab code 200087-0

List of Test Equipment

A Rohde and Schwarz ESU40 and/or Hewlett Packard 8591EM was used as the measuring device for the emissions testing of frequencies below 1 GHz. A Rohde and Schwarz ESU40 and/or Hewlett Packard 8562A Spectrum Analyzer was used as the measuring device for testing the emissions at frequencies above 1 GHz. The analyzer settings used are described in the following table. Refer to the appendix for a complete list of test equipment.

AC Line Conducted Emissions (0.150 -30 MHz)		
RBW	AVG. BW	Detector Function
9 kHz	30 kHz	Peak / Quasi Peak
Emissions (30-1000 MHz)		
RBW	AVG. BW	Detector Function
120 kHz	300 kHz	Peak / Quasi Peak
Emissions (Above 1000 MHz)		
RBW	Video BW	Detector Function
100 kHz	100 kHz	Peak
1 MHz	1 MHz	Peak / Average

<u>Equipment</u>	<u>Manufacturer</u>	<u>Model (SN)</u>	<u>Band</u>	<u>Cal Date</u>	<u>Due</u>
<input type="checkbox"/> LISN	Comp. Design	FCC-LISN-2-MOD.CD (126)	.15-30MHz	10/14	10/15
<input checked="" type="checkbox"/> Cable	Time Microwave	750HF290-750 (L10M)	9kHz-40 GHz	10/14	10/15
<input type="checkbox"/> Cable	Belden	RG-58 (L1-CAT3-11509)	9kHz-30 MHz	10/14	10/15
<input type="checkbox"/> Cable	Belden	RG-58 (L2-CAT3-11509)	9kHz-30 MHz	10/14	10/15
<input type="checkbox"/> Antenna	ARA	BCD-235-B (169)	20-350MHz	10/14	10/15
<input type="checkbox"/> Antenna	EMCO	3147 (40582)	200-1000MHz	10/14	10/15
<input checked="" type="checkbox"/> Antenna	Com Power	AH-118 (10110)	1-18 GHz	10/14	10/15
<input checked="" type="checkbox"/> Antenna	Com Power	AH-840 (101046)	18-40 GHz	5/14	5/15
<input checked="" type="checkbox"/> Antenna	EMCO	6509 (9502-1374)	.001-30 MHz	10/14	10/15
<input checked="" type="checkbox"/> Antenna	Sunol	JB-6 (A100709)	30-1000 MHz	10/14	10/15
<input checked="" type="checkbox"/> Antenna	Standard	FXRY638A (621786)	10-18 GHz	5/14	5/15
<input type="checkbox"/> Antenna	EMCO	3143 (9607-1277)	20-1200 MHz	5/14	5/15
<input type="checkbox"/> Analyzer	HP	8591EM (3628A00871)	9kHz-1.8GHz	5/14	5/15
<input type="checkbox"/> Analyzer	HP	8562A (3051A05950)	9kHz-110GHz	5/14	5/15
<input checked="" type="checkbox"/> Analyzer	Rohde & Schwarz	ESU40 (100108)	20Hz-40GHz	5/14	5/15
<input checked="" type="checkbox"/> Amplifier	Com-Power	PA-010 (171003)	100Hz-30MHz	10/14	10/15
<input checked="" type="checkbox"/> Amplifier	Com-Power	CPPA-102 (01254)	1-1000 MHz	10/14	10/15
<input checked="" type="checkbox"/> Amplifier	Com-Power	PAM-118A (551014)	0.5-18 GHz	10/14	10/15



Units of Measurements

Conducted EMI Data is in dB μ V; dB referenced to one microvolt

Radiated EMI Data is in dB μ V/m; dB/m referenced to one microvolt per meter

Sample Calculation:

RFS = Radiated Field Strength, FSM = Field Strength Measured

A.F. = Receive antenna factor, Gain = amplification gains and/or cable losses

RFS (dB μ V/m @ 3m) = FSM (dB μ V) + A.F. (dB/m) - Gain (dB)

Environmental Conditions

Ambient Temperature 22.7° C

Relative Humidity 34%

Atmospheric Pressure 1020.8 mb

Intentional Radiators

As per CFR47, Subpart C, paragraph 15.249 and RSS-210 the following information is submitted.

Antenna Requirements

The equipment design contains permanently attached antenna design etched on the printed circuit board. The equipment offers no provision for user service, replacement, or antenna modification. The antenna connection point complies with the unique antenna connection requirements. The requirements are fulfilled and there are no deviations or exceptions to the specification.

Restricted Bands of Operation

The EUT utilizes frequency, determining circuitry, which generates harmonics falling in the restricted bands. Spurious emissions falling in the restricted frequency bands of operation were measured at the OATS. Emissions were investigated using appropriate antennas or pyramidal horns, amplification stages, and a spectrum analyzer. Peak and average amplitudes of frequencies above 1000 MHz were compared to the required limits with worst-case data presented below. Test procedures of ANSI C63.10-2013 paragraph 6 and KDB 558074 paragraph 10.2 were used during testing. No other significant emission was observed which fell into the restricted bands of operation. Computed emission values take into account the received radiated field strength, receive antenna correction factor, amplifier gain stage, and test system cable losses.

Table One Radiated Emissions in Restricted Bands Data

Frequency in MHz	Horizontal Peak (dBµV/m)	Horizontal Quasi-Peak (dBµV/m)	Horizontal Average (dBµV/m)	Vertical Peak (dBµV/m)	Vertical Quasi-Peak (dBµV/m)	Vertical Average (dBµV/m)	Limit @ 3m (dBµV/m)
2709.9	45.8	N/A	42.1	43.6	N/A	38.2	54.0
2745.0	46.5	N/A	43.7	43.9	N/A	39.0	54.0
2780.1	47.9	N/A	45.2	43.7	N/A	38.7	54.0
3613.2	38.4	N/A	26.0	41.1	N/A	28.7	54.0
3660.0	38.8	N/A	25.8	37.2	N/A	25.7	54.0
3706.8	38.5	N/A	25.8	41.1	N/A	27.8	54.0
4516.5	41.2	N/A	28.8	40.1	N/A	28.1	54.0
4575.0	40.6	N/A	28.2	40.0	N/A	28.2	54.0
4633.5	43.0	N/A	29.2	41.6	N/A	29.0	54.0
5419.8	53.0	N/A	50.6	49.5	N/A	45.3	54.0

Other emissions present had amplitudes at least 20 dB below the limit. Quasi-Peak amplitude emissions are recorded above for frequency range of 30-1000 MHz. Average amplitude emissions are recorded above for frequency range above 1000 MHz.

Summary of Results for Radiated Emissions in Restricted Bands

The EUT demonstrated compliance with the radiated emissions requirements of CFR 47 Part 15C and RSS-210 Intentional Radiators. The EUT demonstrated a minimum margin of -3.4 dB below the requirements. Peak, Quasi-peak, and Average amplitudes were checked for compliance with the regulations. Worst-case emissions are reported. Other emissions found in the restricted frequency bands presented at least 20 dB below the requirements.

AC Line Conducted Emissions Procedure

The EUT operates from direct current power only and has no provision for connection to utility AC power systems. Therefore, no AC power line conducted emissions testing was taken or required.



General Radiated EMI Testing Procedure

Preliminary testing was performed in a screen room with the EUT positioned 1 meter from the FSM. Investigations were performed to identify the frequencies, which produced the highest radiated emissions. Radiated emission investigations were performed from 9 kHz to 12,000 MHz with the EUT positioned in three orthogonal axes per regulations. Frequencies of interest were recorded for use during testing on the OATS. Each investigated emission was then maximized at the OATS site before final radiated emissions measurements were performed. Final data was taken with the EUT located at the open area test site at a distance of 3 meters between the EUT and the receiving antenna. Test procedures of ANSI C63.10-2013 were used during radiated emissions testing. Peak and average amplitudes of frequencies above 1000 MHz were compared to the required limits with worst-case data presented below. Measured emission levels were maximized by EUT placement on the table, changing cable location, rotating the turntable through 360 degrees, varying the antenna height between 1 and 4 meters above the ground plane and changing antenna polarization between horizontal and vertical. Antennas used were Loop from 0.09 to 30 MHz, Broadband Biconical from 30 MHz to 200 MHz, Log Periodic from 200 MHz to 1 GHz, and/or Biconilog from 30 MHz to 1000 MHz, Double-Ridge, and/or Pyramidal Horns and appropriate amplification stages above 1 GHz.

Table Two General Radiated Emissions Data (worst-case)

Frequency in MHz	Horizontal Peak (dBµV/m)	Horizontal Quasi-Peak (dBµV/m)	Horizontal Average (dBµV/m)	Vertical Peak (dBµV/m)	Vertical Quasi-Peak (dBµV/m)	Vertical Average (dBµV/m)	Limit @ 3m (dBµV/m)
52.0	25.5	18.6	N/A	35.3	24.8	N/A	40.0
78.0	24.6	19.0	N/A	26.9	20.4	N/A	40.0
104.0	24.1	19.6	N/A	23.4	19.1	N/A	43.5
130.0	33.3	22.4	N/A	20.7	15.2	N/A	43.5
156.0	28.3	19.2	N/A	20.1	12.1	N/A	43.5
182.0	25.7	16.5	N/A	18.4	9.6	N/A	43.5
208.0	23.4	14.0	N/A	20.3	10.8	N/A	43.5
707.0	34.5	33.0	N/A	30.5	28.6	N/A	46.0
759.0	38.5	37.4	N/A	36.4	35.0	N/A	46.0
811.0	41.3	40.4	N/A	35.7	34.5	N/A	46.0

Other emissions present had amplitudes at least 20 dB below the limit.

Quasi-Peak amplitude emissions are recorded above for frequency range of 30-1000 MHz.

Average amplitude emissions are recorded above for frequency range above 1000 MHz.

Summary of Results for General Radiated Emissions

The EUT demonstrated compliance with the general radiated emissions requirements of CFR47 Part 15.249 and RSS-210. The EUT demonstrated a minimum margin of -5.6 dB below general radiated emissions requirements. There are no other significantly measurable emissions in the restricted bands other than those recorded in this report. Other emissions were present with amplitudes at least 20 dB below the requirements.



Operation in the Band 902 – 928 MHz

The power output was measured on an open area test site @ 3 meters. Test procedures of ANSI C63.10-2013 were used during testing. The EUT was placed on a wooden turntable 0.8 meters above the ground plane and at a distance of 3 meters from the FSM antenna. The peak and quasi-peak amplitude of frequencies below 1000 MHz were measured using a spectrum analyzer. The peak and average amplitude of frequencies above 1000 MHz were measured using a spectrum analyzer. The amplitude of each emission was recorded from the analyzer display. Emissions radiated outside of the specified bands, except for harmonics, shall be attenuated by at least 50 dB below the level of the fundamental or to the general radiated emission limits in 15.209, whichever is the lesser attenuation. Refer to figures one through four demonstrating compliance of operation in the 902-928 MHz band. The amplitude of each radiated emission was measured on the OATS at a distance of 3 meters from the FSM antenna. The amplitude of each radiated emission was maximized by varying the FSM antenna height, polarization, and by rotating the turntable.

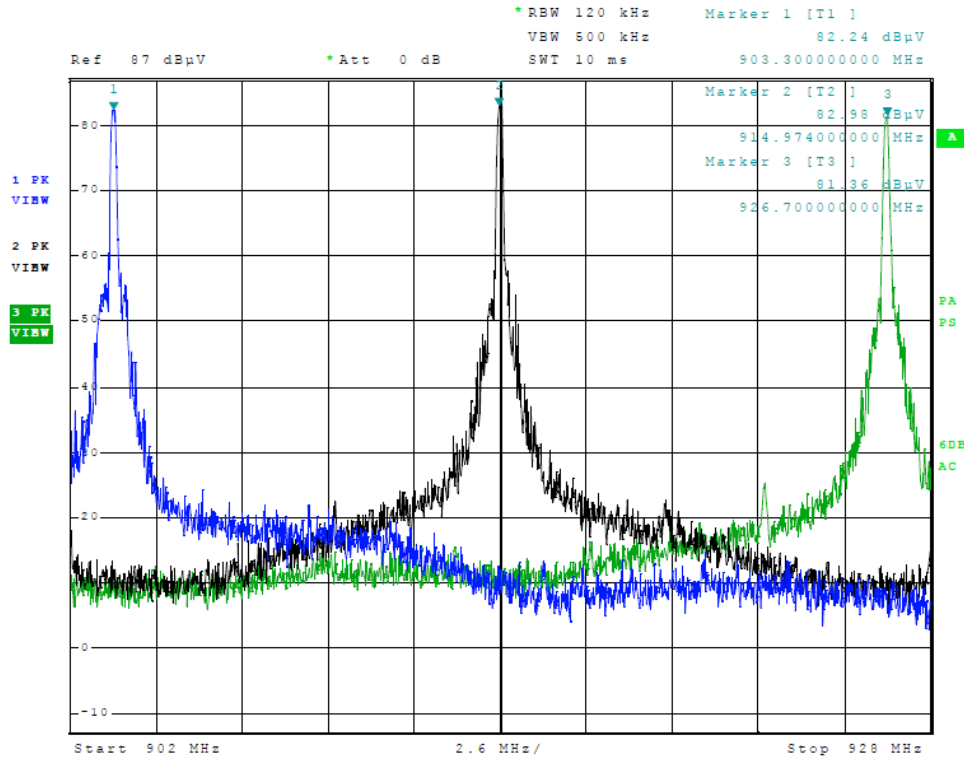

Figure One Plot of Output Across Operational Band

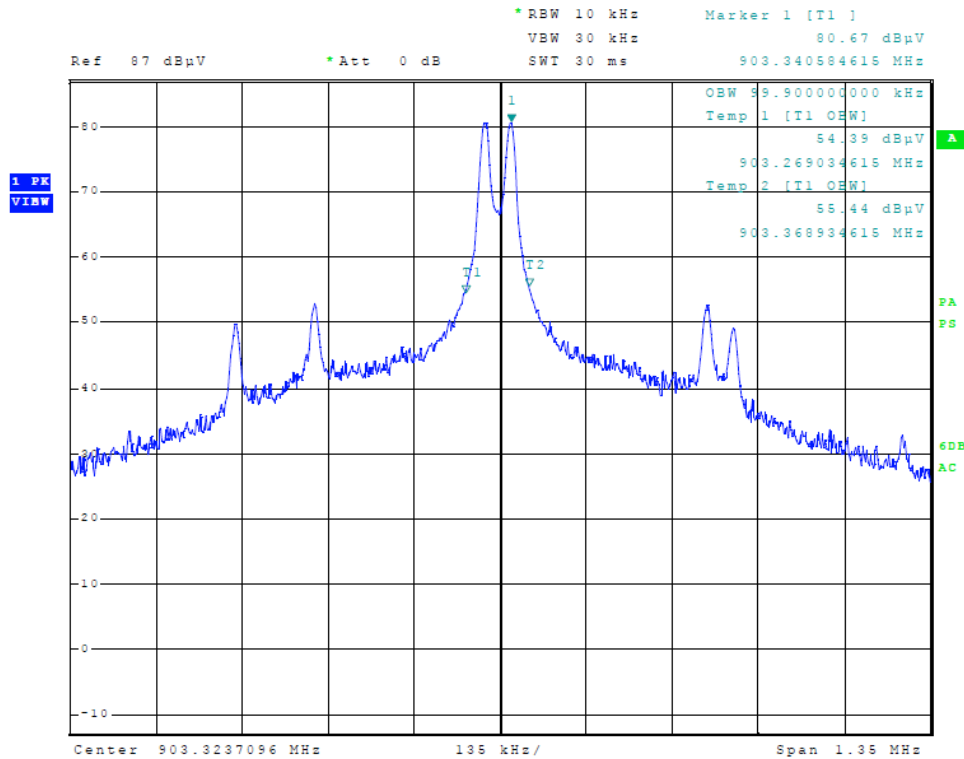

Figure Two Plot of Occupied Bandwidth

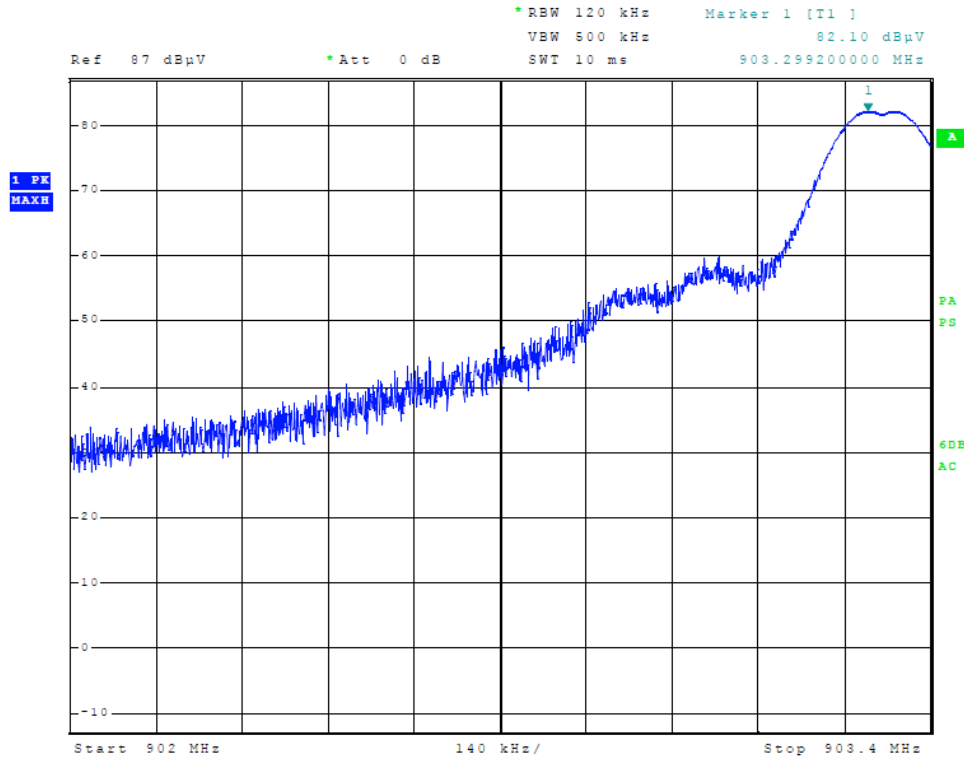

Figure Three Plot of Low Band Edge

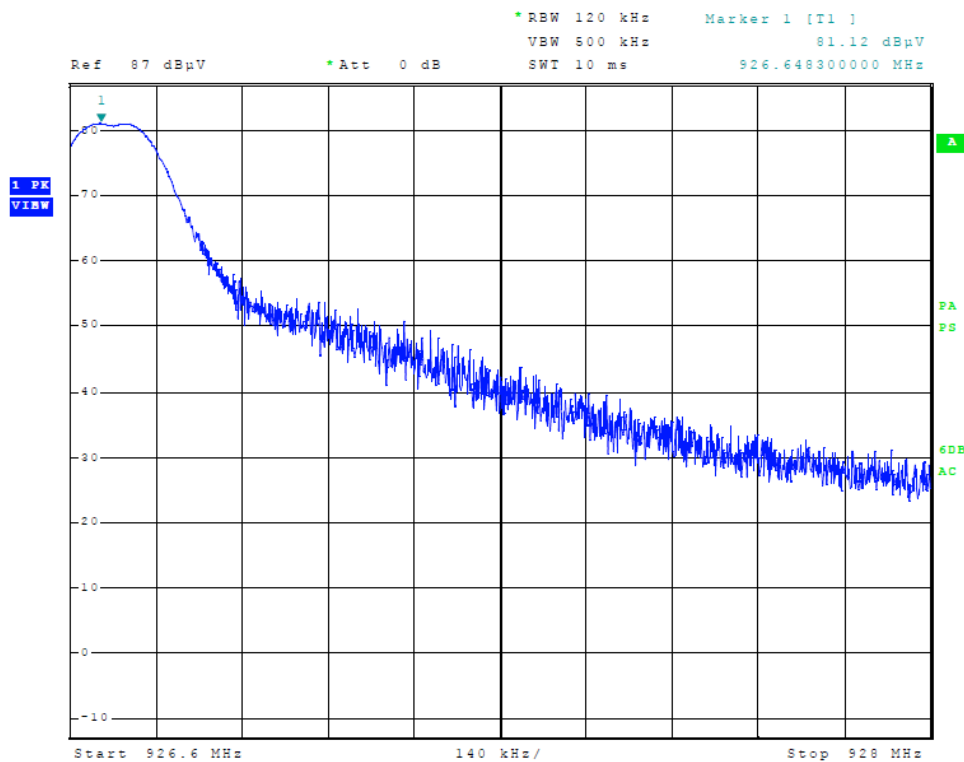

Figure Four Plot of High Band Edge

Transmitter Emissions Data

Table Five Transmitter Radiated Emission Data

Frequency in MHz	Horizontal Peak (dBµV/m)	Horizontal Quasi-Peak (dBµV/m)	Horizontal Average (dBµV/m)	Vertical Peak (dBµV/m)	Vertical Quasi-Peak (dBµV/m)	Vertical Average (dBµV/m)	Limit @ 3m (dBµV/m)
903.3	89.7	85.9	N/A	87.7	87.5	N/A	94
1806.6	43.8	N/A	40.3	46.1	N/A	43.1	54
2709.9	45.8	N/A	42.1	43.6	N/A	38.2	54
3613.2	38.4	N/A	26.0	41.1	N/A	28.7	54
4516.5	41.2	N/A	28.8	40.1	N/A	28.1	54
5419.8	53.0	N/A	50.6	49.5	N/A	45.3	54
6323.1	48.0	N/A	40.4	49.4	N/A	40.1	54
915.0	88.7	87.6	N/A	87.5	87.2	N/A	94
1830.0	43.4	N/A	40.4	45.7	N/A	43.0	54
2745.0	46.5	N/A	43.7	43.9	N/A	39.0	54
3660.0	38.8	N/A	25.8	37.2	N/A	25.7	54
4575.0	40.6	N/A	28.2	40.0	N/A	28.2	54
5490.0	53.0	N/A	50.3	53.8	N/A	51.5	54
6405.0	48.0	N/A	41.3	47.2	N/A	40.9	54
926.7	87.4	87.5	N/A	85.7	85.5	N/A	94
1853.4	41.7	N/A	38.7	45.7	N/A	43.0	54
2780.1	47.9	N/A	45.2	43.7	N/A	38.7	54
3706.8	38.5	N/A	25.8	41.1	N/A	27.8	54
4633.5	43.0	N/A	29.2	41.6	N/A	29.0	54
5560.2	54.8	N/A	51.4	51.3	N/A	47.2	54
6486.9	48.6	N/A	41.8	52.0	N/A	46.7	54

Other emissions present had amplitudes at least 20 dB below the limit.

Quasi-Peak amplitude emissions are recorded above for frequency range of 30-1000 MHz.

Average amplitude emissions are recorded above for frequency range above 1000 MHz.



Summary of Results for Radiated Emissions of Intentional Radiator

The EUT presented compliant with the radiated emissions requirements of CFR47 Part 15.249 and RSS-210 with highest peak radiated emission level measured of 89.7 and average amplitude of 89.5 dB μ V/m at 3-meters. The EUT demonstrated a minimum margin of -2.5 dB below the harmonic emissions requirements. The EUT demonstrated a minimum margin of -3.4 dB below the emissions requirements for restricted bands. There were no other significantly measurable emissions observed in restricted bands other than those recorded in this report. Other emissions were present with amplitudes at least 20 dB below the requirements. The EUT demonstrated compliance with the specifications of CFR47 15.249 and RSS-210. There were no deviations or exceptions to the requirements.



NVLAP Lab Code 200087-0

Annex

- Annex A Measurement Uncertainty Calculations
- Annex B Rogers Labs Test Equipment List
- Annex C Rogers Qualifications
- Annex D FCC Site Registration Letter
- Annex E Industry Canada Site Registration Letter

**Annex A Measurement Uncertainty Calculations**

Measurement uncertainty calculations were made for the laboratory. Result of measurement uncertainty calculations are recorded below for AC line conducted and radiated emission measurements.

Measurement Uncertainty	$U_{(E)}$	$U_{(lab)}$
3 Meter Horizontal 30-200 MHz Measurements	2.08	4.16
3 Meter Vertical 30-200 MHz Measurements	2.16	4.33
3 Meter Vertical Measurements 200-1000 MHz	2.99	5.97
10 Meter Horizontal Measurements 30-200 MHz	2.07	4.15
10 Meter Vertical Measurements 30-200 MHz	2.06	4.13
10 Meter Horizontal Measurements 200-1000 MHz	2.32	4.64
10 Meter Vertical Measurements 200-1000 MHz	2.33	4.66
3 Meter Measurements 1-6 GHz	2.57	5.14
3 Meter Measurements 6-18 GHz	2.58	5.16
AC Line Conducted	1.72	3.43



Annex B Rogers Labs Test Equipment List

List of Test Equipment	Calibration Date
Spectrum Analyzer: Rohde & Schwarz ESU40	5/14
Spectrum Analyzer: HP 8562A, HP Adapters: 11518, 11519, and 11520 Mixers: 11517A, 11970A, 11970K, 11970U, 11970V, 11970W	5/14
Spectrum Analyzer: HP 8591EM	5/14
Antenna: EMCO Biconilog Model: 3143	5/14
Antenna: Sunol Biconilog Model: JB6	10/14
Antenna: EMCO Log Periodic Model: 3147	10/14
Antenna: Com Power Model: AH-118	10/14
Antenna: Com Power Model: AH-840	10/14
Antenna: Antenna Research Biconical Model: BCD 235	10/14
Antenna: EMCO Loop Model: 6509	10/14
Antenna: Schwarzbeck Biconical Model: BBA 9106 (VHBB 9124)	5/14
Antenna: Schwarzbeck Log periodic Model: VULP 9118 A	5/14
LISN: Compliance Design Model: FCC-LISN-2.Mod.cd, 50 µHy/50 ohm/0.1 µf	10/14
R.F. Preamp CPPA-102	10/14
Attenuator: HP Model: HP11509A	10/14
Attenuator: Mini Circuits Model: CAT-3	10/14
Attenuator: Mini Circuits Model: CAT-3	10/14
Cable: Belden RG-58 (L1)	10/14
Cable: Belden RG-58 (L2)	10/14
Cable: Belden 8268 (L3)	10/14
Cable: Time Microwave: 4M-750HF290-750	10/14
Cable: Time Microwave: 10M-750HF290-750	10/14
Frequency Counter: Leader LDC825	2/15
Wattmeter: Bird 43 with Load Bird 8085	2/15
Power Supplies: Sorensen SRL 20-25, SRL 40-25, DCR 150, DCR 140	2/15
R.F. Generators: HP 606A, HP 8614A, HP 8640B	2/15
R.F. Power Amp 65W Model: 470-A-1010	2/15
R.F. Power Amp 50W M185- 10-501	2/15
R.F. Power Amp A.R. Model: 10W 1010M7	2/15
R.F. Power Amp EIN Model: A301	2/15
LISN: Compliance Eng. Model 240/20	2/15
LISN: Fischer Custom Communications Model: FCC-LISN-50-16-2-08	2/15
Antenna: EMCO Dipole Set 3121C	2/15
Antenna: C.D. B-101	2/15
Antenna: Solar 9229-1 & 9230-1	2/15
Audio Oscillator: H.P. 201CD	2/15
ESD Keytek MZ-15 E	2/15
ESD Test Set 2010i	2/15
Fast Transient / Surge Generator system: Transient 3000	2/15
Fast Transient Burst Generator Model: EFT/B-101	2/15
Field Intensity Meter: EFM-018	2/15
Keytek Ecat Surge Generator	2/15



Annex C Rogers Qualifications

Scot D. Rogers, Engineer

Rogers Labs, Inc.

Mr. Rogers has approximately 17 years' experience in the field of electronics. Engineering experience includes six years in the automated controls industry and remaining years working with the design, development and testing of radio communications and electronic equipment.

Positions Held

Systems Engineer: A/C Controls Mfg. Co., Inc. 6 Years

Electrical Engineer: Rogers Consulting Labs, Inc. 5 Years

Electrical Engineer: Rogers Labs, Inc. Current

Educational Background

- 1) Bachelor of Science Degree in Electrical Engineering from Kansas State University.
- 2) Bachelor of Science Degree in Business Administration Kansas State University.
- 3) Several Specialized Training courses and seminars pertaining to Microprocessors and Software programming.

Scot D. Rogers



NVLAP Lab Code 200087-0

Annex D FCC Site Registration Letter

FEDERAL COMMUNICATIONS COMMISSION

**Laboratory Division
7435 Oakland Mills Road
Columbia, MD 21046**

June 28, 2013

Registration Number: 90910

Rogers Labs, Inc.
4405 West 259th Terrace,
Louisburg, KS 66053

Attention: Scot Rogers,

Re: Measurement facility located at Louisburg
3 & 10 meter site
Date of Renewal: June 28, 2013

Dear Sir or Madam:

Your request for renewal of the registration of the subject measurement facility has been received. The information submitted has been placed in your file and the registration has been renewed. The name of your organization will remain on the list of facilities whose measurement data will be accepted in conjunction with applications for Certification under Parts 15 or 18 of the Commission's Rules. Please note that the file must be updated for any changes made to the facility and the registration must be renewed at least every three years.

Measurement facilities that have indicated that they are available to the public to perform measurement services on a fee basis may be found on the FCC website www.fcc.gov under E-Filing, OET Equipment Authorization Electronic Filing, Test Firms.

Sincerely,

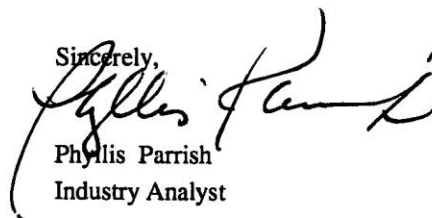

Phyllis Parrish
Industry Analyst

Rogers Labs, Inc.
4405 W. 259th Terrace
Louisburg, KS 66053
Phone/Fax: (913) 837-3214
Revision 1

Digital Monitoring Products, Inc.
Model: 1137 SN: ENG 1
Test #: 150316
Test to: FCC (15.249), RSS-210
File: DMP 1137 TstRpt 150316 d1

FCC ID: CCKPC0166
IC: 5251A-PC0166
Date: April 1, 2015
Page 25 of 26



NVLAP Lab Code 200087-0

Annex E Industry Canada Site Registration Letter

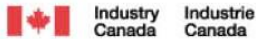

June 19, 2013

OUR FILE: 46405-3041

Submission No: 168037

Rogers Labs Inc.
4405 West 259th Terrace
Louisburg
KS, USA
66053

Attention: Mr. Scot D. Rogers

Dear Sir:

The Bureau has received your application for the renewal of 3/10m OATS. Be advised that the information received was satisfactory to Industry Canada. The following number(s) is now associated to the site(s) for which registration / renewal was sought (**Site# 3041A-1**). Please reference the appropriate site number in the body of test reports containing measurements performed on the site. In addition, please keep for your records the following information;

- The company address code associated to the site(s) located at the above address is: **3041A**

Furthermore, to obtain or renew a unique site number, the applicant shall demonstrate that the site has been accredited to ANSI C63.4-2003 or later. A scope of accreditation indicating the accreditation by a recognized accreditation body to ANSI C63.4-2003 or later shall be accepted. Please indicate in a letter the previous assigned site number if applicable and the type of site (example: 3 metre OATS or 3 metre chamber). If the test facility is not accredited to ANSI C63.4-2003 or later, the test facility shall submit test data demonstrating full compliance with the ANSI standard. The Bureau will evaluate the filing to determine if recognition shall be granted.

The frequency for re-validation of the test site and the information that is required to be filed or retained by the testing party shall comply with the requirements established by the accrediting organization. However, in all cases, test site re-validation shall occur on an interval not to **exceed three years**. There is no fee or form associated with an OATS filing. OATS submissions are encouraged to be submitted electronically to the Bureau using the following URL;

http://strategis.ic.gc.ca/epic/internet/inceb-bhst.nsf/en/h_tt00052e.html.

If you have any questions, you may contact the Bureau by e-mail at certification.bureau@ic.gc.ca Please reference our file and submission number above for all correspondence.

Yours sincerely,

Bill Payn
For: Wireless Laboratory Manager
Certification and Engineering Bureau
3701 Carling Ave., Building 94
P.O. Box 11490, Station "H"
Ottawa, Ontario K2H 8S2
Email: Bill.Payn@ic.gc.ca
Tel. No. (613) 990-3639
Fax. No. (613) 990-4752

Rogers Labs, Inc.
4405 W. 259th Terrace
Louisburg, KS 66053
Phone/Fax: (913) 837-3214
Revision 1

Digital Monitoring Products, Inc.
Model: 1137 SN: ENG 1
Test #: 150316
Test to: FCC (15.249), RSS-210
File: DMP 1137 TstRpt 150316 d1

FCC ID: CCKPC0166
IC: 5251A-PC0166
Date: April 1, 2015
Page 26 of 26