

APPLICATION SUBMITTAL REPORT

FOR
FCC And INDUSTRY CANADA
GRANT OF CERTIFICATION

FOR

Model: CellComC
908 MHz
Low Power Transmitter

FCC ID: CCKPC0159
IC: 5251A-PC0159

FOR

Digital Monitoring Products, Inc.

2500 North Partnership Boulevard
Springfield, MO 65802-6310

Test Report Number: 140403A

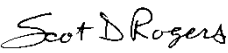
Authorized Signatory: 
Scot D. Rogers

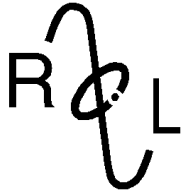

ROGERS LABS, INC.

4405 West 259th Terrace
 Louisburg, KS 66053
 Phone / Fax (913) 837-3214

**Engineering Test Report
 For Application Submittal for
 Grant of Certification**

FOR
 CFR 47, PART 15C - Intentional Radiators Paragraph 15.249 and
 Industry Canada, RSS-210
 License Exempt Intentional Radiator

For

Digital Monitoring Products, Inc.

2500 North Partnership Boulevard
 Springfield, MO 65802-6310

Model: CellComC
 Low Power Transmitter
 Frequency Range 908 MHz
 FCC ID#: CCKPC0159
 IC: 5251A-PC0159

Test Date: April 3, 2014

Certifying Engineer: *Scot D. Rogers*
 Scot D. Rogers
 Rogers Labs, Inc.
 4405 West 259th Terrace
 Louisburg, KS 66053
 Telephone/Facsimile: (913) 837-3214

This report shall not be reproduced except in full, without the written approval of the laboratory.
 This report must not be used by the client to claim product certification, approval, or
 endorsement by NVLAP, NIST, or any agency of the Federal Government.



Table Of Contents

TABLE OF CONTENTS..... 3

REVISIONS..... 4

FORWARD 5

OPINION / INTERPRETATION OF RESULTS 5

STATEMENT OF MODIFICATIONS AND DEVIATIONS 5

EQUIPMENT TESTED..... 6

EQUIPMENT FUNCTION AND CONFIGURATION..... 6

 Equipment Configuration.....6

APPLICATION FOR CERTIFICATION..... 7

APPLICABLE STANDARDS & TEST PROCEDURES 8

 AC Line Conducted Emission Test Procedure8

 Radiated Emission Test Procedure.....8

 Diagram 1 Test arrangement for Conducted emissions9

 Diagram 2 Test arrangement for radiated emissions of tabletop equipment.....10

 Diagram 3 Test arrangement for radiated emissions tested on Open Area Test Site (OATS).....11

TEST SITE LOCATIONS 12

UNITS OF MEASUREMENTS 12

ENVIRONMENTAL CONDITIONS..... 12

LIST OF TEST EQUIPMENT 13

INTENTIONAL RADIATORS..... 14

 Antenna Requirements14

 Restricted Bands of Operation.....14

 Table One Radiated Emissions in Restricted Bands Data14

 Summary of Results for Radiated Emissions in Restricted Bands15



AC Line Conducted Emissions Procedure15

 Figure One AC Line Conducted Emissions Line 116

 Figure Two AC Line Conducted Emissions Line 216

 Table Two AC Line Conducted Emissions Data (Highest Emissions).....17

 Table Three AC Line Conducted Emissions Data (Highest Emissions).....17

Summary of Results for AC Line Conducted Emissions17

General Radiated EMI Testing Procedure18

 Table Four General Radiated Emissions Data (worst-case)19

Summary of Results for General Radiated Emissions19

Operation in the Band 902 – 928 MHz20

 Figure Three Plot of Output Across Operational Band.....21

 Figure Four Plot of Occupied Bandwidth.....21

 Figure Five Plot of Lower Band Edge22

 Figure Six Plot of Higher Band Edge22

Transmitter Emissions Data.....23

 Table Five Transmitter Radiated Emission Data23

Summary of Results for Radiated Emissions of Intentional Radiator23

ANNEX..... 24

Annex A Measurement Uncertainty Calculations.....25

Annex B Rogers Labs Test Equipment List.....26

Annex C Rogers Qualifications27

Annex D FCC Site Registration Letter.....28

Annex E Industry Canada Site Registration Letter29

Revisions

Revision 1, Issued April 21, 2014



Forward

The following information is submitted for consideration in obtaining Grant of Certification for License Exempt FHSS Intentional Radiator operating under CFR 47 Paragraph 15.249 and Industry Canada RSS-210.

Name of Applicant: Digital Monitoring Products, Inc.
2500 North Partnership Boulevard
Springfield, MO 65802-6310

Model: CellComC

FCC I.D.: CCKPC0159 IC: 5251A-PC0159

Frequency Range: 908 MHz

Operating Power: 91.7 dBµV/m@3m, Occupied Bandwidth 117.0 kHz

Opinion / Interpretation of Results

Test Performed	Minimum Margin (dB)	Results
Antenna requirement per CFR 47 15.203	N/A	Complies
Restricted Bands (Tx) Emissions as per CFR 47 15.205 and RSS-210	-15.1	Complies
AC Line Conducted Emissions as per CFR 47 15.207	-18.2	Complies
Radiated Emissions as per CFR 47 15.209 and RSS-210	-11.0	Complies
Radiated Emissions per CFR 47 15.249 and RSS-210 (harmonics)	-15.1	Complies

Statement of Modifications and Deviations

No modifications to the EUT were required for the unit to demonstrate compliance with the CFR47 Part 15C or RSS-210 emissions requirements. There were no deviations or exceptions to the specifications.

Equipment Tested

<u>Equipment</u>	<u>Model</u>	<u>FCC I.D. #</u>
EUT	CellComC	CCKPC0159
AC/DC Adapter	MGT-12500-SPS	N/A

Equipment Function and Configuration

The EUT is a 908 MHz low power transmitter used to wirelessly interface with compliant equipment in an alarm panel installation. The CellComC Transceiver performs wireless monitoring of for use in alarm system. The unit is marketed for use to incorporate a wireless link in an alarm system solution. The design operates from direct current power only and offers no provision for connection to utility power systems. A 12-volt power supply was used to power the EUT during testing. The design incorporates an authorized Cellular communications module (FCC ID: MIVCNN0301) to provide for emergency contact through cellular communications services. Testing of the CellComC was performed with the EUT placed in the manufacturer defined configuration. As requested by the manufacturer and required by regulations, the equipment was tested for emissions compliance using the available configurations with the worst-case data presented. Test results in this report relate only to the products described in this report.

Equipment Configuration

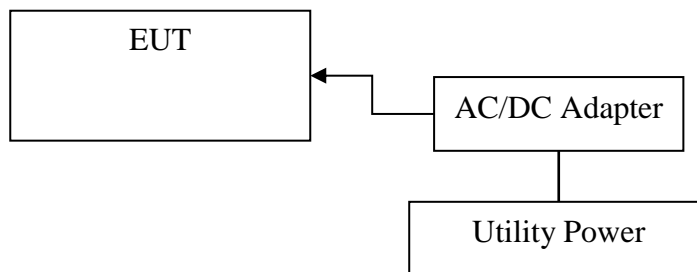



Application for Certification

- (1) Manufacturer: Digital Monitoring Products, Inc.
2500 North Partnership Boulevard
Springfield, MO 65802-6310
- (2) Identification: Model: CellComC
FCC I.D.: CCKPC0159
IC: 5251A-PC0159
- (3) Instruction Book:
Refer to Exhibit for Instruction Manual.
- (4) Description of Circuit Functions:
Refer to Exhibit of Operational Description.
- (5) Block Diagram with Frequencies:
Refer to Exhibit of Operational Description.
- (6) Report of Measurements:
Report of measurements follows in this Report.
- (7) Photographs: Construction, Component Placement, etc.:
Refer to Exhibit for photographs of equipment.
- (8) List of Peripheral Equipment Necessary for operation. The equipment operates from direct current power supplied form installation site, AC/DC adapter, or battery.
- (9) Transition Provisions of 15.37 are not being requested.
- (10) Not Applicable. The unit is not a scanning receiver.
- (11) Not Applicable. The EUT does not operate in the 59 – 64 GHz frequency band.
- (12) The equipment is not software defined and this section is not applicable.

Applicable Standards & Test Procedures

In accordance with the Federal Communications Code of Federal Regulations, dated October 1, 2013, Part 2, Subpart J, Paragraphs 2.907, 2.911, 2.913, 2.925, 2.926, 2.1031 through 2.1057, and applicable parts of paragraph 15, Part 15C Paragraph 15.249 and Industry Canada standard RSS-210 Issue 8 the following information is submitted. Testing for the AC line-conducted emissions were performed as defined in sections 7 and 13.1.3, testing of the radiated emissions was performed as defined in sections 8 and 13.1.4 of ANSI C63.4-2009. Testing of the intentional radiated emissions was performed as defined in section 13 of ANSI C63.4-2009.

AC Line Conducted Emission Test Procedure

The EUT operates from DC power only received from the AC/DC power adapter. For testing purposes, the manufacturer supplied AC/DC power adapter was used to power the EUT. Testing for the AC line-conducted emissions testing was performed as defined in sections 7 and 13.1.3 of ANSI C63.4-2009. The test setup including the EUT was arranged in typical equipment configurations and placed on a 1 x 1.5-meter wooden bench, 0.8 meters high located in a screen room. The power lines of the system were isolated from the power source using a standard LISN with a 50- μ Hy choke. EMI was coupled to the spectrum analyzer through a 0.1 μ F capacitor internal to the LISN. The LISN was positioned on the floor beneath the wooden bench supporting the EUT. The power lines and cables were draped over the back edge of the table. Refer to diagram 1 showing typical test arrangement and photographs in the test setup exhibits for specific EUT placement during testing. Refer to photographs in the test setup exhibits for EUT placement during testing.

Radiated Emission Test Procedure

The EUT was placed on a rotating 1 x 1.5-meter wooden platform, 0.8 meters above the ground plane at a distance of 3 meters from the FSM antenna. Radiated emissions testing was performed as required in CFR47 15, RSS-210 and specified in sections 6 and 7 of ANSI C63.10-2009. EMI energy was maximized by equipment placement, raising and lowering the FSM antenna, changing the antenna polarization, and by rotating the turntable. Each emission was maximized before data was taken using a spectrum analyzer. The frequency spectrum from 9 kHz to 25,000 MHz was searched for during preliminary investigation. Refer to diagrams 2 and 3 showing typical test arrangement and photographs in the test setup exhibits for specific EUT placement during testing.

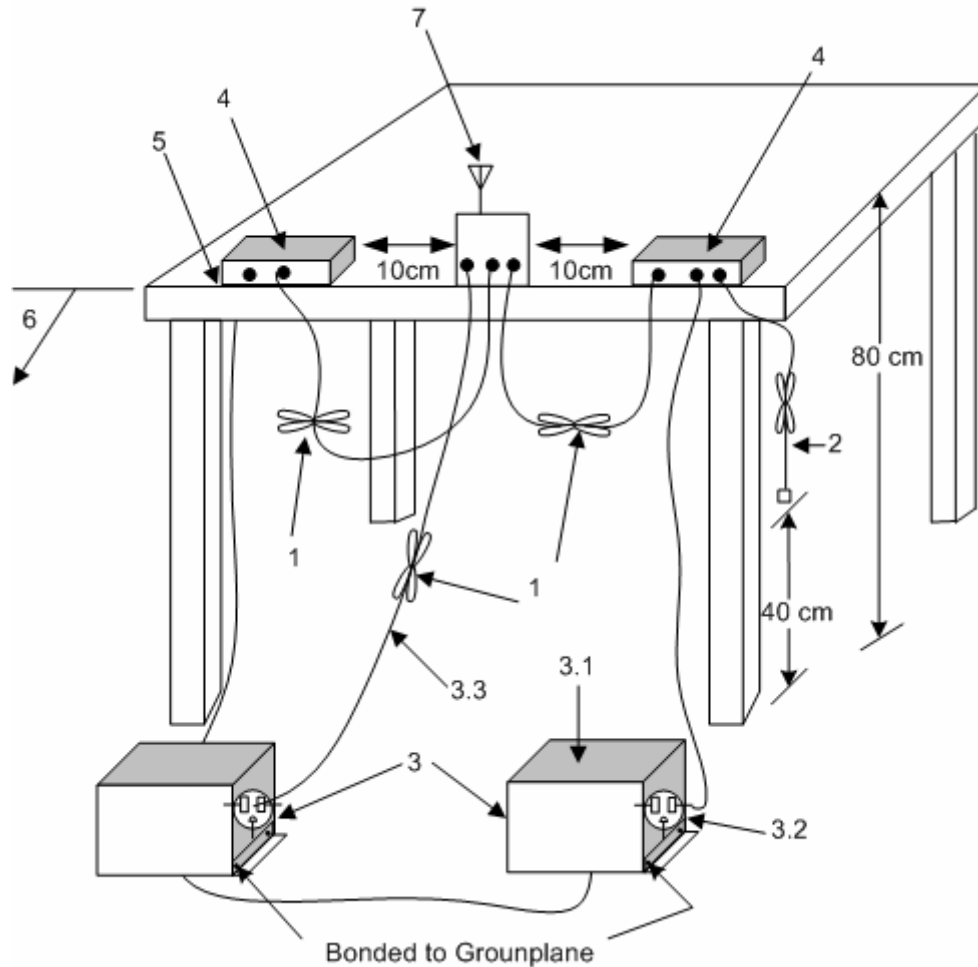

1. Interconnecting cables that hang closer than 40 cm to the ground plane shall be folded back and forth in the center forming a bundle 30 cm to 40 cm long see (see 6.2.3.1).
2. I/O cables that are not connected to an accessory shall be bundled in the center. The end of the cable may be terminated, if required, using the correct terminating impedance. The overall length shall not exceed 1 m (see 6.2.2).
3. EUT connected to one LISN. Unused LISN measuring port connectors shall be terminated in 50 Ω loads. LISN can be placed on top of, or immediately beneath, reference ground plane (see 6.2.2 and 6.2.3).
 - 3.1 All other equipment powered from additional LISN(s).
 - 3.2 Multiple-outlet strip can be used for multiple power cords of non-EUT equipment.
 - 3.3 LISN at least 80 cm from nearest part of EUT chassis.
4. Non-EUT components of EUT system being tested.
5. Rear of EUT, including peripherals, shall all be aligned and flush with rear of tabletop (see 6.2.3.1).
6. Edge of tabletop shall be 40 cm removed from a vertical conducting plane that is bonded to the ground plane (see 6.2.2 for options).
7. Antenna may be integral or detachable. If detachable, the antenna shall be attached for this test.

Diagram 1 Test arrangement for Conducted emissions

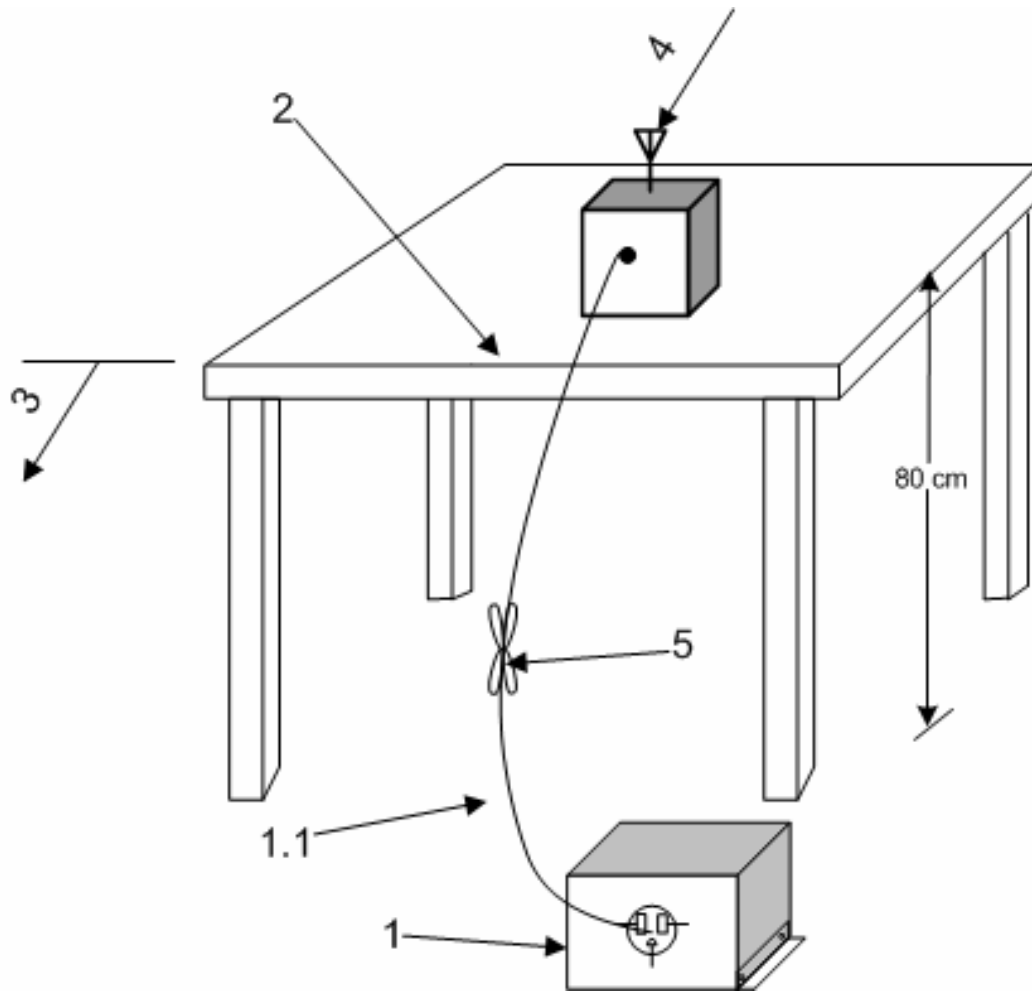

1. A LISN is optional for radiated measurements between 30 MHz to 1000 MHz, but not allowed for measurements below 30 MHz and above 1000 MHz. (See 6.4.3, 6.5.1, and 6.6.3.). If used, connect EUT to one LISN. Unused LISN measuring port connectors shall be terminated in 50Ω. LISN can be placed on top of, or immediately beneath, reference ground plane (see 6.2.2 and 6.2.3.1).
 - 1.1 LISN spaced at least 80 cm from nearest part of EUT chassis.
2. The EUT shall be placed in the center of the table to the extent possible. (See 6.2.3.1 and 6.3.4).
3. A vertical conducting plane, if used for conducted tests per 6.2.2, shall be removed for radiated emission tests.
4. Antenna may be integral or detachable, depending on the EUT.
5. Interconnecting cables that hang closer than 40 cm to the ground plane shall be folded back and forth in the center forming a bundle 30 cm to 40 cm long.

Diagram 2 Test arrangement for radiated emissions of tabletop equipment

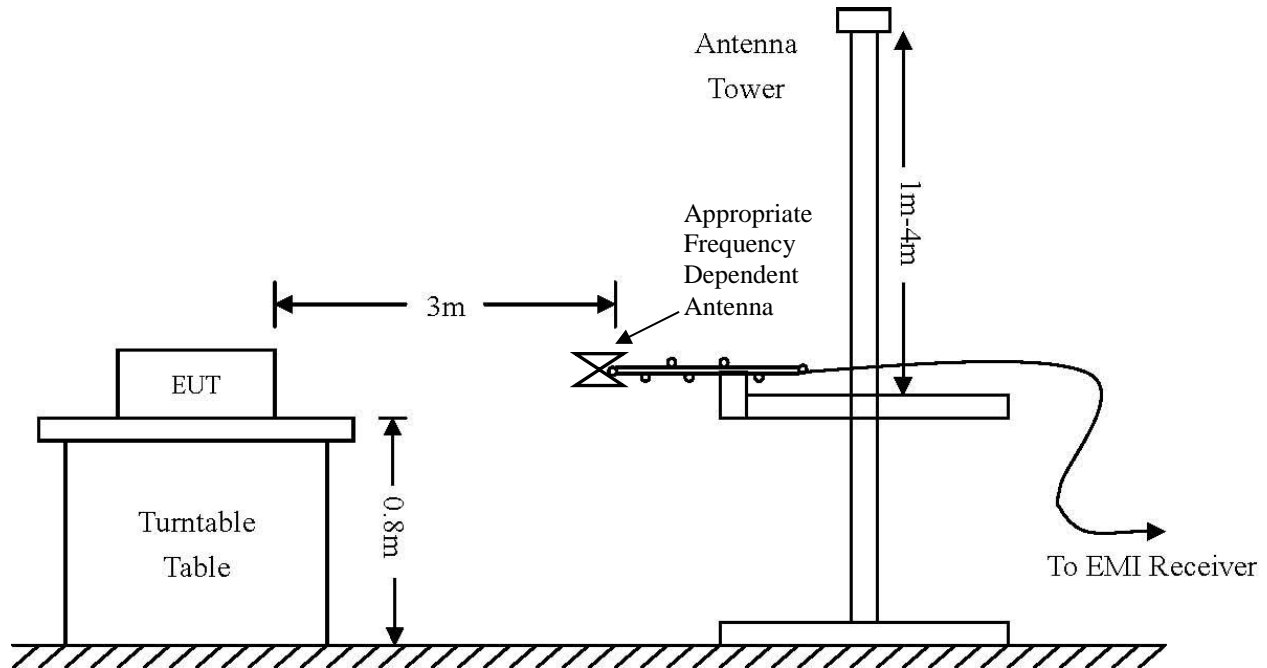

Frequency: 9 kHz-30 MHz	Frequency: 30 MHz- 1 GHZ	Frequency: Above 1 GHz
RBW = 9 kHz	RBW = 120 kHz	RBW = 1 MHz
VBW = 30 kHz	VBW = 120 kHz	VBW = 1 MHz
Sweep time = Auto	Sweep time = Auto	Sweep time = Auto
Detector = PK, QP	Detector = PK, QP	Detector = PK, AV

Diagram 3 Test arrangement for radiated emissions tested on Open Area Test Site (OATS)



Test Site Locations

Conducted EMI	The AC power line conducted emissions testing performed in a shielded screen room located at Rogers Labs, Inc., 4405 W. 259 th Terrace, Louisburg, KS
Radiated EMI	The radiated emissions tests were performed at the 3 meters, Open Area Test Site (OATS) located at Rogers Labs, Inc., 4405 W. 259 th Terrace, Louisburg, KS
Site Registration	Refer to Annex for Site Registration Letters
NVLAP Accreditation	Lab code 200087-0

Units of Measurements

Conducted EMI	Data is in dB μ V; dB referenced to one microvolt
Radiated EMI	Data is in dB μ V/m; dB/m referenced to one microvolt per meter

Sample Calculation:

RFS = Radiated Field Strength, FSM = Field Strength Measured

A.F. = Receive antenna factor, Gain = amplification gains and/or cable losses

$RFS (dB\mu V/m @ 3m) = FSM (dB\mu V) + A.F. (dB/m) - Gain (dB)$

Environmental Conditions

Ambient Temperature	22.4° C
Relative Humidity	33%
Atmospheric Pressure	1006.6 mb

List of Test Equipment

A Rohde and Schwarz ESU40 and/or Hewlett Packard 8591EM was used as the measuring device for the emissions testing of frequencies below 1 GHz. A Rohde and Schwarz ESU40 and/or Hewlett Packard 8562A Spectrum Analyzer was used as the measuring device for testing the emissions at frequencies above 1 GHz. The analyzer settings used are described in the following table. Refer to the appendix for a complete list of test equipment.

AC Line Conducted Emissions (0.150 -30 MHz)		
RBW	AVG. BW	Detector Function
9 kHz	30 kHz	Peak / Quasi Peak
Emissions (30-1000 MHz)		
RBW	AVG. BW	Detector Function
120 kHz	300 kHz	Peak / Quasi Peak
Emissions (Above 1000 MHz)		
RBW	Video BW	Detector Function
100 kHz	100 kHz	Peak
1 MHz	1 MHz	Peak / Average

<u>Equipment</u>	<u>Manufacturer</u>	<u>Model (SN)</u>	<u>Band</u>	<u>Cal Date</u>	<u>Due</u>
<input checked="" type="checkbox"/> LISN	Comp. Design	FCC-LISN-2-MOD.CD (126)	.15-30MHz	10/13	10/14
<input checked="" type="checkbox"/> Cable	Time Microwave	750HF290-750 (L10M)	9kHz-40 GHz	10/13	10/14
<input checked="" type="checkbox"/> Cable	Belden	RG-58 (L1-CAT3-11509)	9kHz-30 MHz	10/13	10/14
<input checked="" type="checkbox"/> Cable	Belden	RG-58 (L2-CAT3-11509)	9kHz-30 MHz	10/13	10/14
<input type="checkbox"/> Antenna	ARA	BCD-235-B (169)	20-350MHz	10/13	10/14
<input type="checkbox"/> Antenna	EMCO	3147 (40582)	200-1000MHz	10/13	10/14
<input checked="" type="checkbox"/> Antenna	Com Power	AH-118 (10110)	1-18 GHz	10/13	10/14
<input checked="" type="checkbox"/> Antenna	Com Power	AH-840 (101046)	18-40 GHz	5/13	5/14
<input checked="" type="checkbox"/> Antenna	EMCO	6509 (9502-1374)	.001-30 MHz	10/13	10/14
<input checked="" type="checkbox"/> Antenna	Sunol	JB-6 (A100709)	30-1000 MHz	10/13	10/14
<input checked="" type="checkbox"/> Antenna	Standard	FXRY638A (621786)	10-18 GHz	5/13	5/14
<input type="checkbox"/> Antenna	EMCO	3143 (9607-1277)	20-1200 MHz	5/13	5/14
<input type="checkbox"/> Analyzer	HP	8591EM (3628A00871)	9kHz-1.8GHz	5/13	5/14
<input type="checkbox"/> Analyzer	HP	8562A (3051A05950)	9kHz-110GHz	5/13	5/14
<input checked="" type="checkbox"/> Analyzer	Rohde & Schwarz	ESU40 (100108)	20Hz-40GHz	5/13	5/14
<input checked="" type="checkbox"/> Amplifier	Com-Power	PA-010 (171003)	100Hz-30MHz	10/13	10/14
<input checked="" type="checkbox"/> Amplifier	Com-Power	CPPA-102 (01254)	1-1000 MHz	10/13	10/14
<input checked="" type="checkbox"/> Amplifier	Com-Power	PAM-118A (551014)	0.5-18 GHz	10/13	10/14

Intentional Radiators

As per CFR47, Subpart C, paragraph 15.249 and RSS-210 the following information is submitted.

Antenna Requirements

The equipment design contains permanently attached antenna design etched on the printed circuit board. The equipment offers no provision for user service, replacement, or antenna modification. The antenna connection point complies with the unique antenna connection requirements. The requirements are fulfilled and there are no deviations or exceptions to the specification.

Restricted Bands of Operation

Spurious emissions falling in the restricted frequency bands of operation were measured at a distance of three meters on the OATS. The EUT utilizes frequency, determining circuitry, which generates harmonics falling in the restricted bands. Emissions were measured at the OATS, using appropriate antennas or pyramidal horns, amplification stages, and a spectrum analyzer. Emissions emanating from the EUT in the restricted bands of operation are presented in Table 1. No other significant emissions were observed which fell into the restricted bands of operation.

Table One Radiated Emissions in Restricted Bands Data

Frequency in MHz	Horizontal Peak (dBµV/m)	Horizontal Quasi-Peak (dBµV/m)	Horizontal Average (dBµV/m)	Vertical Peak (dBµV/m)	Vertical Quasi-Peak (dBµV/m)	Vertical Average (dBµV/m)	Limit @ 3m (dBµV/m)
2725.2	45.4	N/A	38.9	44.3	N/A	36.3	54.0
3633.6	41.7	N/A	28.8	41.5	N/A	28.7	54.0
4542.0	45.3	N/A	32.9	45.9	N/A	33.0	54.0

Other emissions present had amplitudes at least 20 dB below the limit. Quasi-Peak amplitude emissions are recorded above for frequency range of 30-1000 MHz. Average amplitude emissions are recorded above for frequency range above 1000 MHz.

Summary of Results for Radiated Emissions in Restricted Bands

The EUT demonstrated compliance with the radiated emissions requirements of CFR 47 Part 15C and RSS-210 Intentional Radiators. The EUT demonstrated a minimum margin of –15.1 dB below the requirements. Peak, Quasi-peak, and Average amplitudes were checked for compliance with the regulations. Worst-case emissions are reported. Other emissions found in the restricted frequency bands presented at least 20 dB below the requirements.

AC Line Conducted Emissions Procedure

The EUT was arranged in a typical equipment configuration and placed on a 1 x 1.5-meter wooden bench 80 cm above the conducting ground plane, floor of a screen room. The bench was positioned 40 cm away from the wall of the screen room. The LISN was positioned on the floor of the screen room 80-cm from the rear of the EUT. The manufacturer supplied AC/DC adapter for the EUT was connected to the LISN. A second LISN was positioned on the floor of the screen room 80-cm from the rear of the supporting equipment of the EUT. All power cords except the EUT were then powered from the second LISN. EMI was coupled to the spectrum analyzer through a 0.1 µF capacitor, internal to the LISN. Power line conducted emissions testing were carried out individually for each current carrying conductor of the EUT. The excess length of lead between the system and the LISN receptacle was folded back and forth to form a bundle not exceeding 40 cm in length. The screen room, conducting ground plane, analyzer, and LISN were bonded together to the protective earth ground. Preliminary testing was performed to identify the frequency of each radio frequency emission displaying the highest amplitude. The cables were repositioned to obtain maximum amplitude of measured EMI level. Once the worst-case configuration was identified, plots were made of the EMI from 0.15 MHz to 30 MHz then the data was recorded with maximum conducted emissions levels. Refer to figures one and two for plots of the EUT AC Power Line conducted emissions.

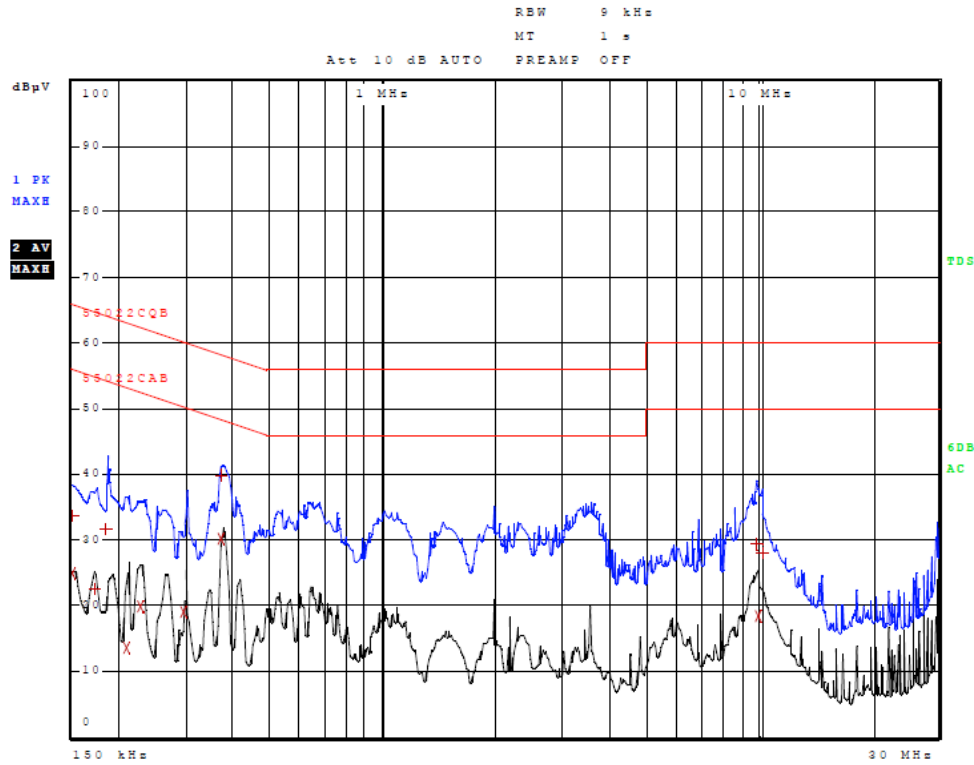

Figure One AC Line Conducted Emissions Line 1

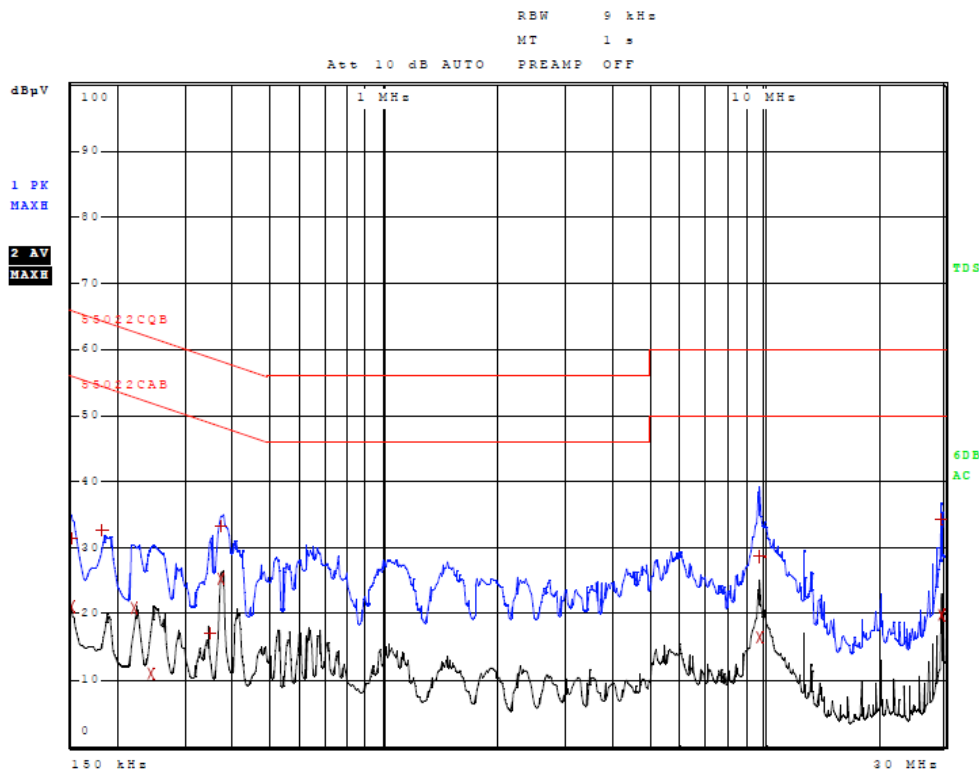

Figure Two AC Line Conducted Emissions Line 2

Table Two AC Line Conducted Emissions Data (Highest Emissions)

Trace	Frequency	Level (dBµV)	Detector	Delta Limit/dB
1	150.000000000 kHz	33.68	Quasi Peak	-32.32
2	150.000000000 kHz	24.85	Average	-31.15
1	174.000000000 kHz	22.60	Quasi Peak	-42.17
1	186.000000000 kHz	31.55	Quasi Peak	-32.66
2	210.000000000 kHz	13.51	Average	-39.69
2	230.000000000 kHz	19.79	Average	-32.66
2	298.000000000 kHz	19.05	Average	-31.25
2	374.000000000 kHz	30.19	Average	-18.22
1	374.000000000 kHz	39.91	Quasi Peak	-18.50
1	9.860000000 MHz	29.36	Quasi Peak	-30.64
2	9.928000000 MHz	18.33	Average	-31.67
1	10.160000000 MHz	28.01	Quasi Peak	-31.99

Other emissions present had amplitudes at least 20 dB below the limit.

Table Three AC Line Conducted Emissions Data (Highest Emissions)

Trace	Frequency	Level (dBµV)	Detector	Delta Limit/dB
1	150.000000000 kHz	31.41	Quasi Peak	-34.59
2	150.000000000 kHz	21.07	Average	-34.93
1	182.000000000 kHz	32.58	Quasi Peak	-31.81
2	222.000000000 kHz	20.85	Average	-31.89
2	246.000000000 kHz	10.99	Average	-40.90
1	350.000000000 kHz	17.20	Quasi Peak	-41.76
2	374.000000000 kHz	25.26	Average	-23.15
1	374.000000000 kHz	33.31	Quasi Peak	-25.10
2	9.780000000 MHz	16.52	Average	-33.48
1	9.780000000 MHz	28.68	Quasi Peak	-31.32
2	29.616000000 MHz	19.83	Average	-30.17
1	29.616000000 MHz	34.30	Quasi Peak	-25.70

Other emissions present had amplitudes at least 20 dB below the limit.

Summary of Results for AC Line Conducted Emissions

The EUT demonstrated compliance with the conducted emissions requirements of CFR47 Part 15C and RSS-210 equipment. The EUT demonstrated minimum margin of -18.2 dB below the limit. Measurements were taken using the peak, quasi peak, and average, measurement function for each emissions amplitude and were below the limits stated in the specification. Other emissions were present with recorded data representing worst-case amplitudes.



General Radiated EMI Testing Procedure

The EUT was arranged in the test fixture emulating worst-case equipment configuration and operated through all available modes with worst-case data recorded. Preliminary testing was performed in a screen room with the EUT positioned 1 meter from the FSM. Investigations were performed to identify the frequencies, which produced the highest radiated emissions. Radiated emission investigations were performed from 9 kHz to 12,000 MHz with the EUT positioned in three orthogonal axes per regulations. Frequencies of interest were recorded for use during testing on the OATS. Each investigated emission was then maximized at the OATS site before final radiated emissions measurements were performed. Final data was taken with the EUT located at the open area test site at a distance of 3 meters between the EUT and the receiving antenna. Test procedures of ANSI C63.4-2009 paragraphs 13.1 and 8.3.1.2 were used during radiated emissions testing. Peak and average amplitudes of frequencies above 1000 MHz were compared to the required limits with worst-case data presented below. Measured emission levels were maximized by EUT placement on the table, changing cable location, rotating the turntable through 360 degrees, varying the antenna height between 1 and 4 meters above the ground plane and changing antenna polarization between horizontal and vertical. Antennas used were Loop from 0.09 to 30 MHz, Broadband Biconical from 30 MHz to 200 MHz, Log Periodic from 200 MHz to 1 GHz, and/or Biconilog from 30 MHz to 1000 MHz, Double-Ridge, and/or Pyramidal Horns and appropriate amplification stages above 1 GHz.

Table Four General Radiated Emissions Data (worst-case)

Frequency in MHz	Horizontal Peak (dBµV/m)	Horizontal Quasi-Peak (dBµV/m)	Horizontal Average (dBµV/m)	Vertical Peak (dBµV/m)	Vertical Quasi-Peak (dBµV/m)	Vertical Average (dBµV/m)	Limit @ 3m (dBµV/m)
77.5	24.3	18.2	N/A	29.6	22.1	N/A	40.0
126.1	28.4	23.5	N/A	29.3	20.3	N/A	43.5
127.6	30.7	26.3	N/A	25.3	20.5	N/A	43.5
211.9	28.5	23.6	N/A	29.2	28.3	N/A	43.5
213.4	26.0	23.2	N/A	30.3	28.5	N/A	43.5
216.5	30.0	22.7	N/A	33.2	28.6	N/A	46.0
322.0	28.2	24.7	N/A	21.8	15.5	N/A	46.0
323.5	30.5	27.5	N/A	25.2	15.7	N/A	46.0
432.1	35.7	31.7	N/A	35.9	35.0	N/A	46.0

Other emissions present had amplitudes at least 20 dB below the limit.

Quasi-Peak amplitude emissions are recorded above for frequency range of 30-1000 MHz.

Average amplitude emissions are recorded above for frequency range above 1000 MHz.

Summary of Results for General Radiated Emissions

The EUT demonstrated compliance with the general radiated emissions requirements of CFR47 Part 15.249 and RSS-210. The EUT demonstrated a minimum margin of -11.0 dB below general radiated emissions requirements. There are no other significantly measurable emissions in the restricted bands other than those recorded in this report. Other emissions were present with amplitudes at least 20 dB below the requirements.



Operation in the Band 902 – 928 MHz

The power output was measured on an open area test site @ 3 meters. Test procedures of ANSI C63.4-2009 paragraphs 13.1 and 8.3.1.2 were used during testing. The EUT was placed on a wooden turntable 0.8 meters above the ground plane and at a distance of 3 meters from the FSM antenna. The peak and quasi-peak amplitude of frequencies below 1000 MHz were measured using a spectrum analyzer. The peak and average amplitude of frequencies above 1000 MHz were measured using a spectrum analyzer. The amplitude of each emission was recorded from the analyzer display. Emissions radiated outside of the specified bands, except for harmonics, shall be attenuated by at least 50 dB below the level of the fundamental or to the general radiated emission limits in 15.209, whichever is the lesser attenuation. Refer to figures three through six demonstrating compliance of operation in the 902-928 MHz band. The amplitude of each radiated emission was measured on the OATS at a distance of 3 meters from the FSM antenna (testing performed on sample representative of production with integral antenna). The amplitude of each radiated emission was maximized by varying the FSM antenna height, polarization, and by rotating the turntable.

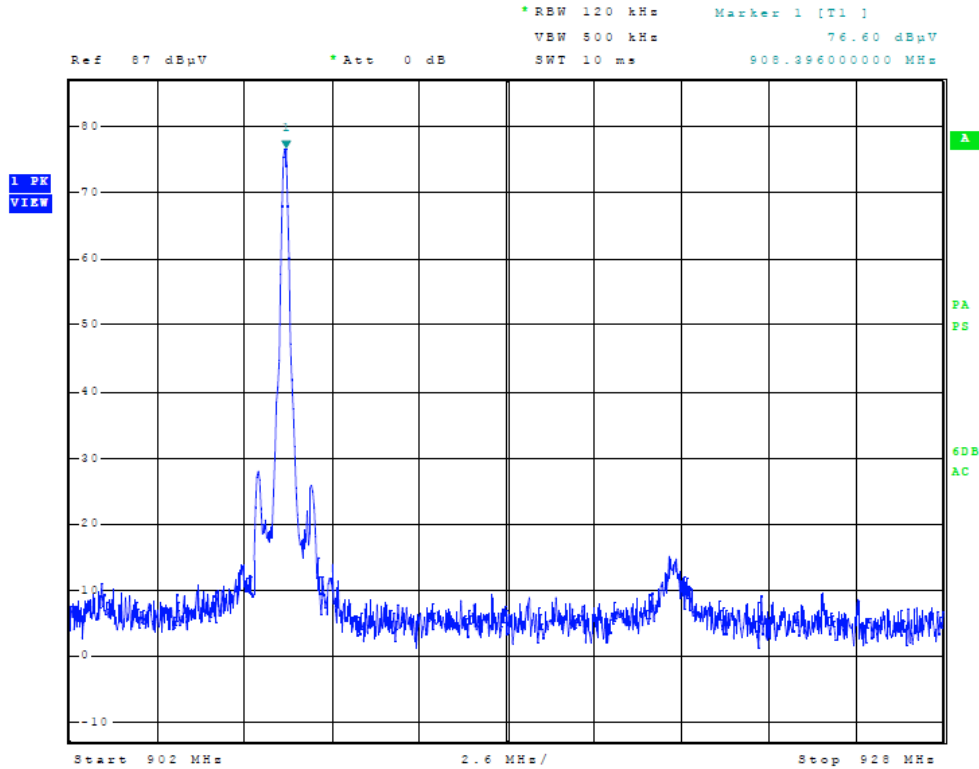

Figure Three Plot of Output Across Operational Band

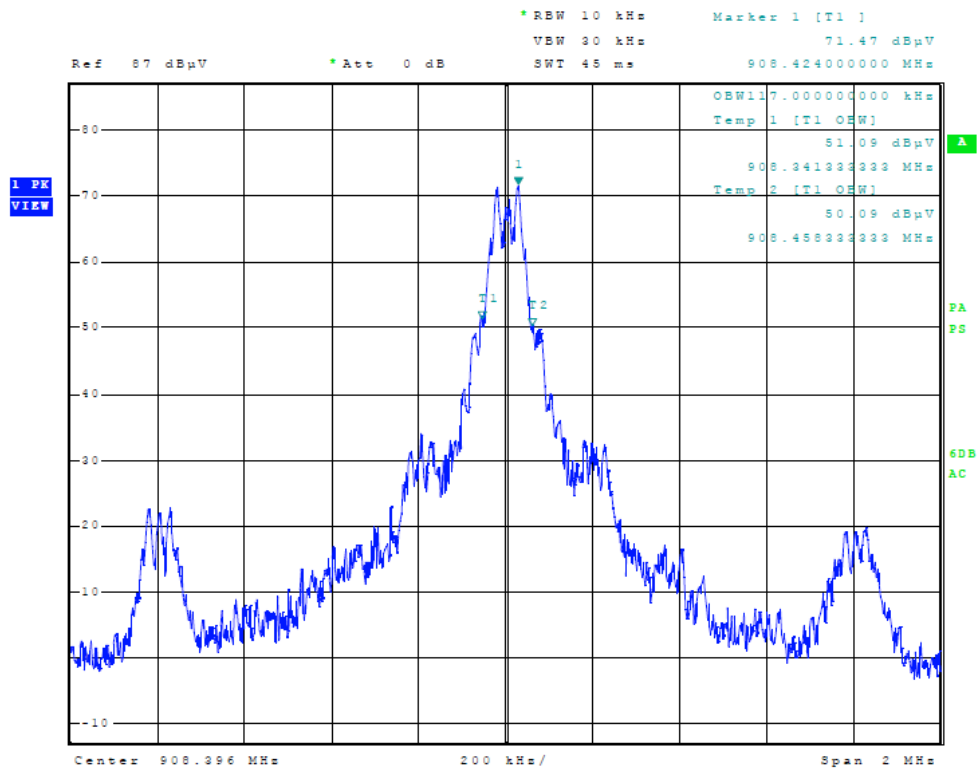

Figure Four Plot of Occupied Bandwidth

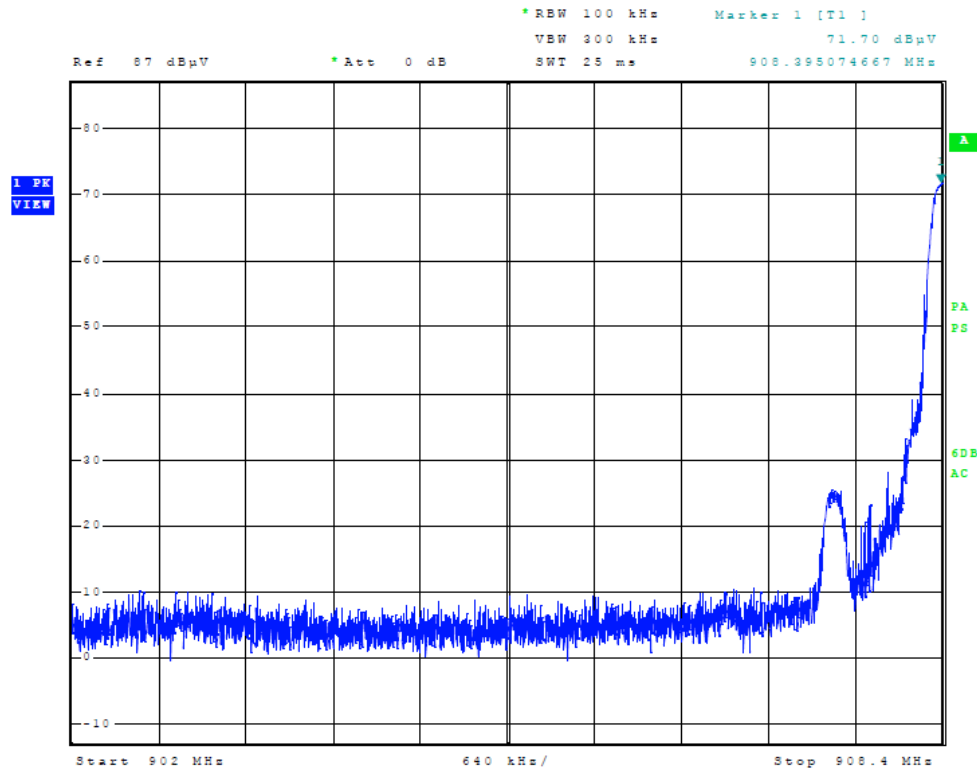

Figure Five Plot of Lower Band Edge

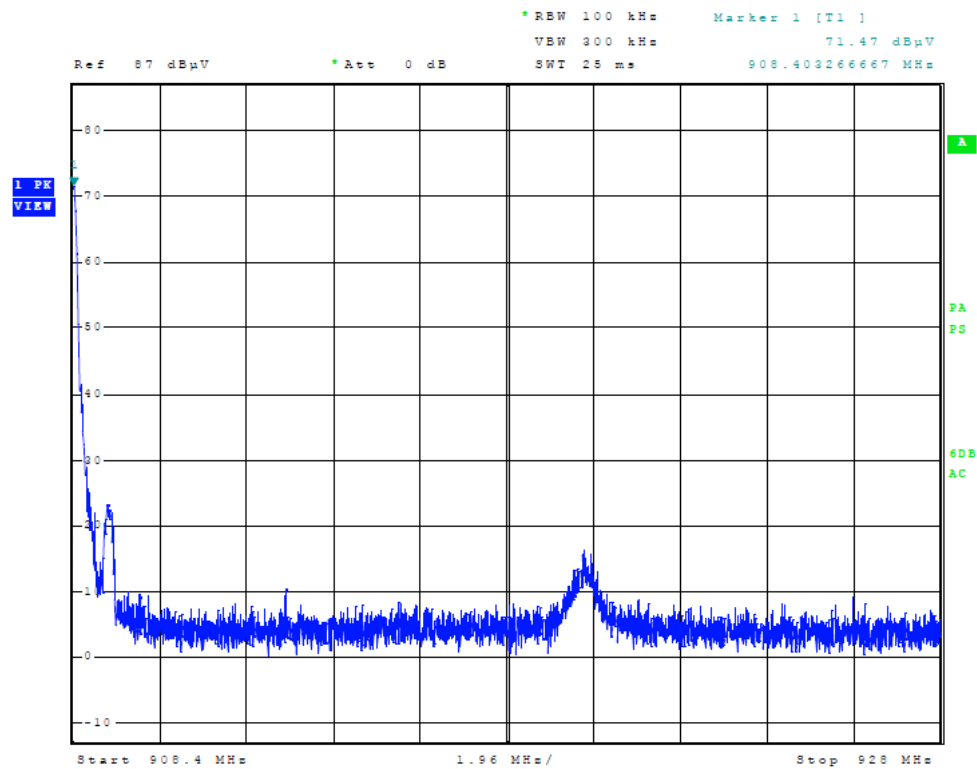

Figure Six Plot of Higher Band Edge

Transmitter Emissions Data

Table Five Transmitter Radiated Emission Data

Frequency in MHz	Horizontal Peak (dBµV/m)	Horizontal Quasi-Peak (dBµV/m)	Horizontal Average (dBµV/m)	Vertical Peak (dBµV/m)	Vertical Quasi-Peak (dBµV/m)	Vertical Average (dBµV/m)	Limit @ 3m (dBµV/m)
908.4	84.7	84.6	N/A	91.7	91.6	N/A	--
1816.8	37.0	N/A	24.8	38.2	N/A	26.0	54
2725.2	45.4	N/A	38.9	44.3	N/A	36.3	54
3633.6	41.7	N/A	28.8	41.5	N/A	28.7	54
4542.0	45.3	N/A	32.9	45.9	N/A	33.0	54
5450.4	44.6	N/A	33.1	46.2	N/A	32.8	54
6358.8	41.9	N/A	28.7	41.1	N/A	28.7	54

Other emissions present had amplitudes at least 20 dB below the limit.

Quasi-Peak amplitude emissions are recorded above for frequency range of 30-1000 MHz.

Average amplitude emissions are recorded above for frequency range above 1000 MHz.

Summary of Results for Radiated Emissions of Intentional Radiator

The EUT presented compliant with the radiated emissions requirements of CFR47 Part 15.249 and RSS-210 with highest radiated emission level measured of 91.7 dBµV/m at 3-meters. The EUT demonstrated a minimum margin of -15.1 dB below the harmonic emissions requirements. The EUT demonstrated a minimum margin of -15.1 dB below the emissions requirements for restricted bands. There were no other significantly measurable emissions observed in restricted bands other than those recorded in this report. Other emissions were present with amplitudes at least 20 dB below the requirements. The EUT demonstrated compliance with the specifications of CFR47 15.249 and RSS-210. There were no deviations or exceptions to the requirements.



NVLAP Lab Code 200087-0

Annex

- Annex A Measurement Uncertainty Calculations
- Annex B Rogers Labs Test Equipment List
- Annex C Rogers Qualifications
- Annex D FCC Site Registration Letter
- Annex E Industry Canada Site Registration Letter



Annex A Measurement Uncertainty Calculations

Measurement uncertainty calculations were made for the laboratory. Result of measurement uncertainty calculations are recorded below for AC line conducted and radiated emission measurements.

Measurement Uncertainty	U _(E)	U _(lab)
3 Meter Horizontal 30-200 MHz Measurements	2.08	4.16
3 Meter Vertical 30-200 MHz Measurements	2.16	4.33
3 Meter Vertical Measurements 200-1000 MHz	2.99	5.97
10 Meter Horizontal Measurements 30-200 MHz	2.07	4.15
10 Meter Vertical Measurements 30-200 MHz	2.06	4.13
10 Meter Horizontal Measurements 200-1000 MHz	2.32	4.64
10 Meter Vertical Measurements 200-1000 MHz	2.33	4.66
3 Meter Measurements 1-6 GHz	2.57	5.14
3 Meter Measurements 6-18 GHz	2.58	5.16
AC Line Conducted	1.72	3.43



Annex B Rogers Labs Test Equipment List

List of Test Equipment	Calibration Date
Spectrum Analyzer: Rohde & Schwarz ESU40	5/13
Spectrum Analyzer: HP 8562A, HP Adapters: 11518, 11519, and 11520 Mixers: 11517A, 11970A, 11970K, 11970U, 11970V, 11970W	5/13
Spectrum Analyzer: HP 8591EM	5/13
Antenna: EMCO Biconilog Model: 3143	5/13
Antenna: Sunol Biconilog Model: JB6	10/13
Antenna: EMCO Log Periodic Model: 3147	10/13
Antenna: Com Power Model: AH-118	10/13
Antenna: Com Power Model: AH-840	10/13
Antenna: Antenna Research Biconical Model: BCD 235	10/13
Antenna: EMCO 6509	10/13
LISN: Compliance Design Model: FCC-LISN-2.Mod.cd, 50 µHy/50 ohm/0.1 µf	10/13
R.F. Preamp CPPA-102	10/13
Attenuator: HP Model: HP11509A	10/13
Attenuator: Mini Circuits Model: CAT-3	10/13
Attenuator: Mini Circuits Model: CAT-3	10/13
Cable: Belden RG-58 (L1)	10/13
Cable: Belden RG-58 (L2)	10/13
Cable: Belden 8268 (L3)	10/13
Cable: Time Microwave: 4M-750HF290-750	10/13
Cable: Time Microwave: 10M-750HF290-750	10/13
Frequency Counter: Leader LDC825	2/14
Oscilloscope Scope: Tektronix 2230	2/14
Wattmeter: Bird 43 with Load Bird 8085	2/14
Power Supplies: Sorensen SRL 20-25, SRL 40-25, DCR 150, DCR 140	2/14
R.F. Generators: HP 606A, HP 8614A, HP 8640B	2/14
R.F. Power Amp 65W Model: 470-A-1010	2/14
R.F. Power Amp 50W M185- 10-501	2/14
R.F. Power Amp A.R. Model: 10W 1010M7	2/14
R.F. Power Amp EIN Model: A301	2/14
LISN: Compliance Eng. Model 240/20	2/14
LISN: Fischer Custom Communications Model: FCC-LISN-50-16-2-08	2/14
Antenna: EMCO Dipole Set 3121C	2/14
Antenna: C.D. B-101	2/14
Antenna: Solar 9229-1 & 9230-1	2/14
Audio Oscillator: H.P. 201CD	2/14
ELGAR Model: 1751	2/14
ELGAR Model: TG 704A-3D	2/14
ESD Test Set 2010i	2/14
Fast Transient Burst Generator Model: EFT/B-101	2/14
Field Intensity Meter: EFM-018	2/14
KEYTEK Ecat Surge Generator	2/14
Shielded Room 5 M x 3 M x 3.0 M	



Annex C Rogers Qualifications

Scot D. Rogers, Engineer

Rogers Labs, Inc.

Mr. Rogers has approximately 17 years' experience in the field of electronics. Engineering experience includes six years in the automated controls industry and remaining years working with the design, development and testing of radio communications and electronic equipment.

Positions Held

Systems Engineer: A/C Controls Mfg. Co., Inc. 6 Years

Electrical Engineer: Rogers Consulting Labs, Inc. 5 Years

Electrical Engineer: Rogers Labs, Inc. Current

Educational Background

- 1) Bachelor of Science Degree in Electrical Engineering from Kansas State University.
- 2) Bachelor of Science Degree in Business Administration Kansas State University.
- 3) Several Specialized Training courses and seminars pertaining to Microprocessors and Software programming.

Scot D. Rogers



NVLAP Lab Code 200087-0

Annex D FCC Site Registration Letter

FEDERAL COMMUNICATIONS COMMISSION

**Laboratory Division
7435 Oakland Mills Road
Columbia, MD 21046**

June 28, 2013

Registration Number: 90910

Rogers Labs, Inc.
4405 West 259th Terrace,
Louisburg, KS 66053

Attention: Scot Rogers,

Re: Measurement facility located at Louisburg
3 & 10 meter site
Date of Renewal: June 28, 2013

Dear Sir or Madam:

Your request for renewal of the registration of the subject measurement facility has been received. The information submitted has been placed in your file and the registration has been renewed. The name of your organization will remain on the list of facilities whose measurement data will be accepted in conjunction with applications for Certification under Parts 15 or 18 of the Commission's Rules. Please note that the file must be updated for any changes made to the facility and the registration must be renewed at least every three years.

Measurement facilities that have indicated that they are available to the public to perform measurement services on a fee basis may be found on the FCC website www.fcc.gov under E-Filing, OET Equipment Authorization Electronic Filing, Test Firms.

Sincerely,

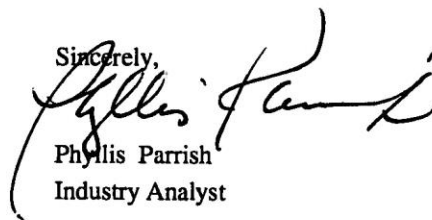

Phyllis Parrish
Industry Analyst



NVLAP Lab Code 200087-0

Annex E Industry Canada Site Registration Letter

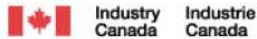

June 19, 2013

OUR FILE: 46405-3041

Submission No: 168037

Rogers Labs Inc.
4405 West 259th Terrace
Louisburg
KS, USA
66053

Attention: Mr. Scot D. Rogers

Dear Sir:

The Bureau has received your application for the renewal of 3/10m OATS. Be advised that the information received was satisfactory to Industry Canada. The following number(s) is now associated to the site(s) for which registration / renewal was sought (**Site# 3041A-1**). Please reference the appropriate site number in the body of test reports containing measurements performed on the site. In addition, please keep for your records the following information;

- The company address code associated to the site(s) located at the above address is: **3041A**

Furthermore, to obtain or renew a unique site number, the applicant shall demonstrate that the site has been accredited to ANSI C63.4-2003 or later. A scope of accreditation indicating the accreditation by a recognized accreditation body to ANSI C63.4-2003 or later shall be accepted. Please indicate in a letter the previous assigned site number if applicable and the type of site (example: 3 metre OATS or 3 metre chamber). If the test facility is not accredited to ANSI C63.4-2003 or later, the test facility shall submit test data demonstrating full compliance with the ANSI standard. The Bureau will evaluate the filing to determine if recognition shall be granted.

The frequency for re-validation of the test site and the information that is required to be filed or retained by the testing party shall comply with the requirements established by the accrediting organization. However, in all cases, test site re-validation shall occur on an interval not to **exceed three years**. There is no fee or form associated with an OATS filing. OATS submissions are encouraged to be submitted electronically to the Bureau using the following URL;

http://strategis.ic.gc.ca/epic/internet/inceb-bhst.nsf/en/h_tt00052e.html.

If you have any questions, you may contact the Bureau by e-mail at certification.bureau@ic.gc.ca Please reference our file and submission number above for all correspondence.

Yours sincerely,

Bill Payn
For: Wireless Laboratory Manager
Certification and Engineering Bureau
3701 Carling Ave., Building 94
P.O. Box 11490, Station "H"
Ottawa, Ontario K2H 8S2
Email: Bill.Payn@ic.gc.ca
Tel. No. (613) 990-3639
Fax. No. (613) 990-4752

Rogers Labs, Inc.
4405 W. 259th Terrace
Louisburg, KS 66053
Phone/Fax: (913) 837-3214
Revision 1

Digital Monitoring Products, Inc.
Model: CellComC SN: Unit 2
Test #: 140403A
Test to: FCC (15.249), RSS-210
File: DMP PC0159 TstRpt 140403A

FCC ID: CCKPC0159
IC: 5251A-PC0159
Date: April 21, 2014
Page 29 of 29