

TEST REPORT



DT&C Co., Ltd.

42, Yurim-ro, 154Beon-gil, Cheoin-gu, Yongin-si, Gyeonggi-do, Korea, 17042
Tel : 031-321-2664, Fax : 031-321-1664

1. Report No : DRTFCC2108-0087

2. Customer

• Name (FCC) : COMMAX CO., Ltd. / Name (IC) : Commax Co., Ltd

• Address (FCC) : 494 Dunchon-Daero, Jungwon-Gu, Seongnam-si, Gyeonggi-do South Korea 13229

Address (IC) : 513-11, Sangdaewon-dong, Jungwon-gu Seongnam-si, Gyeonggi-do 13229
Korea (Republic Of)

3. Use of Report : FCC & IC Certification

4. Product Name / Model Name : RFID Module / CRM-1356BM

FCC ID: CCECRM-1356BM

IC: 22254-CRM1356BM

5. FCC Regulation(s): Part 15.225

IC Standard(s): RSS-210 Issue 10

Test Method used: ANSI C63.10-2013

6. Date of Test : 2021.07.02 ~ 2021.07.20



7. Location of Test : Permanent Testing Lab On Site Testing

8. Testing Environment : See appended test report.

9. Test Result : Refer to the attached Test Result

The results shown in this test report refer only to the sample(s) tested unless otherwise stated.

This test report is not related to KOLAS accreditation.

Affirmation	Tested by	Reviewed by
	Name : SeungMin Gil 	Name : JaeJin Lee  (Signature)

2021 . 08 . 20 .

DT&C Co., Ltd.

If this report is required to confirmation of authenticity, please contact to report@dtnc.net

Test Report Version

Test Report No.	Date	Description	Revised by	Reviewed by
DRTFCC2108-0087	Aug. 20, 2021	Initial issue	SeungMin Gil	JaeJin Lee

CONTENTS

1. General Information.....	4
1.1. Description of EUT	4
1.2. Declaration by the applicant / manufacturer	4
1.3. Testing Laboratory	5
1.4. Testing Environment.....	5
1.5. Measurement Uncertainty	5
1.6. Test Equipment List.....	6
2. Test Methodology	7
2.1. EUT Configuration.....	7
2.2. EUT Exercise	7
2.3. General Test Procedures.....	7
2.4. Description of Test Mode.....	7
2.5. Tested frequency	7
3. Antenna Requirements.....	7
4. Summary of Test Result	8
5. Test Result	9
5.1. 20dB bandwidth & Occupied Bandwidth	9
5.2. In-band emissions.....	10
5.3. Out-of-band emissions	12
5.4. Frequency Stability	14
5.5. AC Power-Line Conducted Emissions.....	15

1. General Information

1.1. Description of EUT

Equipment Class	Low Power Communications Device Transmitter (DXX)
Product Name	RFID Module
Model Name	CRM-1356BM
Add Model Name	NA
Firmware Version Identification Number	1.0
EUT Serial Number	No specified
Power Supply	DC 5 V
Frequency Range	13.560 MHz
Modulation Type	ASK
Antenna Type	FPCB Loop Antenna

1.2. Declaration by the applicant / manufacturer

N/A

1.3. Testing Laboratory

DT&C Co., Ltd.	
The 3 m test site and conducted measurement facility used to collect the radiated data are located at the 42, Yurim-ro, 154beon-gil, Cheoin-gu, Yongin-si, Gyeonggi-do, Korea 17042.	
The test site complies with the requirements of § 2.948 according to ANSI C63.4-2014.	
- FCC & IC MRA Designation No. : KR0034	
- ISED#: 5740A	
www.dtnc.net	
Telephone	: + 82-31-321-2664
FAX	: + 82-31-321-1664

1.4. Testing Environment

Ambient Condition	
▪ Temperature	+23 °C ~ +25 °C
▪ Relative Humidity	43 % ~ 46 %

1.5. Measurement Uncertainty

The measurement uncertainties shown below were calculated in accordance with requirements of ANSI C63.4-2014 and ANSI C63.10-2013. All measurement uncertainty values are shown with a coverage factor of $k = 2$ to indicate a 95 % level of confidence.

Parameter	Measurement uncertainty
AC power-line conducted emission	3.4 dB (The confidence level is about 95 %, $k = 2$)
Radiated emission (Below 1 GHz)	4.9 dB (The confidence level is about 95 %, $k = 2$)

1.6. Test Equipment List

Type	Manufacturer	Model	Cal.Date (yy/mm/dd)	Next.Cal.Date (yy/mm/dd)	S/N
Spectrum Analyzer	Agilent Technologies	N9020A	21/06/24	22/06/24	MY50200834
Spectrum Analyzer	Agilent Technologies	N9020A	21/06/24	22/06/24	US47360812
DC Power Supply	Agilent Technologies	66332A	21/06/24	22/06/24	US37473422
Multimeter	FLUKE	17B+	20/12/16	21/12/16	3630701WS
Signal Generator	Rohde Schwarz	SMBV100A	20/12/16	21/12/16	255571
Thermohygrometer	BODYCOM	BJ5478	20/12/16	21/12/16	120612-1
Thermohygrometer	BODYCOM	BJ5478	20/12/16	21/12/16	120612-2
Loop Antenna	ETS-Lindgren	6502	21/01/28	23/01/28	00226186
BILOG ANTENNA	Schwarzbeck	VULB 9160	20/12/16	21/12/16	3362
PreAmplifier	H.P	8447D	20/12/16	21/12/16	2944A07774
Temp & Humi Test Chamber	SJ Science	SJ-TH-S50	20/12/14	21/12/14	SJ-TH-S50-140205
Cable	HUBER+SUHNER	SUCOFLEX100	21/01/08	22/01/08	M-01
Cable	HUBER+SUHNER	SUCOFLEX100	21/01/08	22/01/08	M-02
Cable	JUNFLON	MWX241	21/01/08	22/01/08	M-03
Cable	JUNFLON	J12J101757-00	21/01/08	22/01/08	M-07
Cable	HUBER+SUHNER	SUCOFLEX106	21/01/08	22/01/08	M-09
EMI Receiver	ROHDE&SCHWARZ	ESU	21/01/19	22/01/19	100538
PULSE LIMITER	Rohde Schwarz	ESH3-Z2	20/08/25	21/08/25	101333
LISN	SCHWARZBECK	NSLK 8128 RC	20/10/23	21/10/23	8128 RC-387
HYGROMETER	TESTO	608-H1	21/01/19	22/01/19	34862883
Cable	DT&C	Cable	21/01/05	22/01/05	RFC-69
Test Software	tsj	Radiated Emission Measurement	N/A	N/A	Version 2.00.0177
Test Software	tsj	Noise Terminal Voltage Measurement	N/A	N/A	Version 2.00.0170

Note1: The measurement antennas were calibrated in accordance to the requirements of ANSI C63.5-2017.

Note2: The cable is not a regular calibration item, so it has been calibrated by DT&C itself.

2. Test Methodology

The tests were performed according to the ANSI C63.10-2013.

2.1. EUT Configuration

The EUT configuration for testing is installed on RF field strength measurement to meet the Commissions requirement and operating in a manner that intends to maximize its emission characteristics in a continuous normal application.

2.2. EUT Exercise

The EUT was operated in the test mode to fix the TX frequency that was for the purpose of the measurements. According to its specifications, the EUT must comply with the requirements of the FCC and IC rules.

2.3. General Test Procedures

Conducted Emissions

According to the requirements in Section 6.2 of ANSI C63.10, the EUT is placed on the wooden table, which is 0.8 m above ground plane and the conducted emissions from the EUT are measured in the frequency range between 0.15 MHz and 30MHz using CISPR Quasi-peak and Average detector.

Radiated Emissions

The EUT is placed on a non-conductive table, which is 0.8 m above ground plane. The turntable shall rotate 360 degrees to determine the position of maximum emission level. EUT is set 3 m away from the receiving antenna, which varied from 1 m to 4 m to find out the highest emission. And also, each emission was to be maximized by changing the polarization of receiving antenna both horizontal and vertical. In order to find out the highest emission, the relative positions of this hand-held transmitter (EUT) was rotated through three orthogonal axes according to the requirements in Section 6.3 of ANSI C63.10

2.4. Description of Test Mode

Test mode1	Continuous transmitting mode
-------------------	------------------------------

The EUT has been tested with the operating condition for maximizing the emission characteristics. And the internal firmware was used for staying in continuous transmitting mode.

2.5. Tested frequency

Channel	Tested Frequency(MHz)
Lowest	13.56
Middle	-
Highest	-

3. Antenna Requirements

An intentional radiator antenna shall be designed to ensure that no antenna other than that furnished by the responsible party can be used with the device. The use of a permanently attached antenna or of an antenna that uses a unique coupling to the intentional radiator shall be considered sufficient to comply with the provisions of this section.

**The internal antenna is permanently attached on the PCB.
Therefore this E.U.T Complies with the requirement of §15.203**

4. Summary of Test Result

FCC part section(s)	RSS section(s)	Test Description	Limit	Test condition	Status Note 1
15.215(c)	-	20 dB Bandwidth	-	Radiated	C
-	RSS-Gen [6.7]	Occupied Bandwidth	-		C
15.225(a)	RSS-210 [B6(a)]	In-Band Emissions	15,848 $\mu\text{V}/\text{m}$ @ 30 m 13.553 MHz – 13.567 MHz		C Note 3
15.225(b)	RSS-210 [B6(b)]	In-Band Emissions	334 $\mu\text{V}/\text{m}$ @ 30 m 13.410 MHz – 13.553 MHz 13.567 MHz – 13.710 MHz		C Note 3
15.225(c)	RSS-210 [B6(c)]	In-Band Emissions	106 $\mu\text{V}/\text{m}$ @ 30 m 13.110 MHz – 13.410 MHz 13.710 MHz – 14.010 MHz		C Note 3
15.225(d) 15.209	RSS-210 [B6(d)] RSS-Gen [8.9]	Out-of Band Emissions	Emissions outside of the specified band (13.110 MHz - 14.010 MHz) must meet the radiated limits detailed in 15.209 (Refer to section 5.3)		C Note 3
15.225(e)	RSS-210 [B6]	Frequency Stability	± 0.01 % of operating frequency	Temp & Humid Test Chamber	C
15.207	RSS-Gen [8.8]	AC Conducted Emissions	Part 15.207 (Refer to section 5.5)	AC Line Conducted	C
15.203	-	Antenna Requirements	Part 15.203 (Refer to section 3)	-	C

Note 1: **C** = Comply **NC** = Not Comply **NT** = Not Tested **NA** = Not Applicable
 Note 2: For radiated emission tests below 30 MHz were performed on semi-anechoic chamber which is correlated with OATS.
 Note 3: This test item was performed in three orthogonal EUT positions and the worst case data was reported.

5. Test Result

5.1. 20dB bandwidth & Occupied Bandwidth

- Procedure: ANSI C63.10-2013 Section 6.9.2, RSS-Gen [6.7]

The 20 dB Bandwidth is measured with a spectrum analyzer connected via a receive antenna placed near the EUT while the EUT is operating in transmission mode.

1. Center frequency = EUT channel center frequency
2. Span = 2 ~ 5 times the OBW
3. RBW = 1 % ~ 5 % OBW
4. VBW ≥ 3 x RBW
5. Detector = Peak
6. Trace = Max hold
7. The trace was allowed to stabilize
8. Determine the reference value = Set the spectrum analyzer marker to the highest level of the displayed trace
9. Using the marker-delta function of the instrument, determine the “-xx dB down amplitude” using [(reference value) - xx].
10. Reset the marker-delta function and move the marker to the other side of the emission until the delta marker amplitude is at the same level as the reference marker amplitude. The marker-delta frequency reading at this point is the specified emission bandwidth.

- Measurement Data: Comply

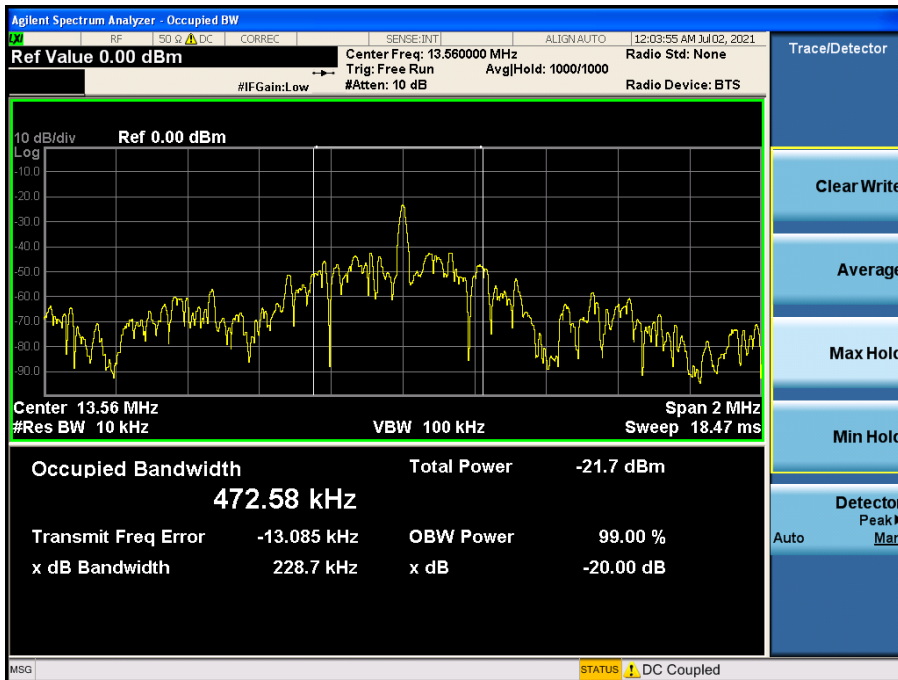

Tested Frequency [MHz]	20 dB BW (KHz)	Occupied BW (KHz)
13.560	228.700	472.580

- Minimum Standard: NA

5.2. In-band emissions

- Test Configuration

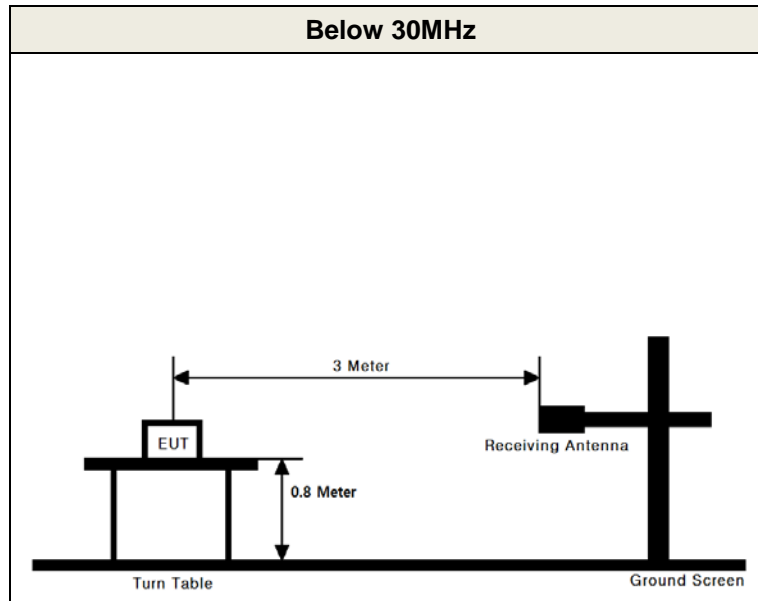

- Procedure: The radiated emission was tested according to the **section 6.4 of the ANSI C63.10-2013**.

The EUT was placed on a 0.8 m high non-conductive table and it was placed at 3m distance from the antenna. Measurements were performed for each of the three antenna orientations. (ie. parallel, perpendicular, and ground-parallel)

Also, measurements were performed with the EUT oriented in 3 orthogonal axis and rotated 360 degrees to determine worst-case orientation for maximum emissions.

RBW = As specified in below table, VBW ≥ 3 x RBW, Sweep = Auto, Detector = Peak
Trace mode = Max Hold until the trace stabilizes.

Frequency	RBW
9 - 150 kHz	200 – 300 Hz
0.15 - 30 MHz	9 – 10 kHz
30 – 1 000 MHz	100 – 120 kHz
> 1000 MHz	1 MHz

- Minimum Standard: Part 15.225(a), (b), (c) & RSS-210 [B6(a), (b), (c)]

Frequency Band [MHz]	Limit at 30 m measurement distance	
	[uV/m]	[dBuV/m]
13.553 - 13.567	15,848	84.0
13.410 - 13.553 13.567 - 13.710	334	50.5
13.110 - 13.410 13.710 - 14.010	106	40.5

- Measurement Data:

Test Frequency Band [MHz]	Freq. [MHz]	EUT Axis.	ANT (Note 1)	Reading Level [dBuV]	TF [dB/m]	Field Strength @3 m [dBuV/m]	Field Strength @30 m [dBuV/m]	Limit [dBuV/m]	Margin [dB]
13.110 ~ 13.410	13.376	Y	P	35.3	10.5	45.8	5.8	40.5	34.7
13.410 ~ 13.553	13.553	Y	P	54.2	10.5	64.7	24.7	50.5	25.8
13.553 ~ 13.567	13.560	Y	P	58.8	10.5	69.3	29.3	84.0	54.7
13.567 ~ 13.710	13.568	Y	P	52.7	10.5	63.2	23.2	50.5	27.3
13.710 ~ 14.010	13.770	Y	P	33.9	10.5	44.4	4.4	40.5	36.1

Note 1. Loop antenna orientation

“P”: Parallel, “V”: perpendicular, “G”: ground-parallel

Note 2. This test item was performed at 3 m and the data were extrapolated to the specified measurement distance of 30 m using the square of an inverse linear distance extrapolation factor (40 dB/decade) as specified in §15.31(f)(2).

▪ Extrapolation Factor = $40 \log(3\text{m} / 30\text{m}) = -40$

Note 3. All data were recorded using a spectrum analyzer employing a peak detector.

If PK results were meet Quasi-peak limit, Quasi-peak measurements were omitted.

Note 4. Sample Calculation.

Margin = Limit – Field Strength @ 30 m / Field Strength @ 30 m = Field Strength @ 3 m – 40 dB

Field Strength @ 3 m = Reading + TF / TF = AF + CL

Where, TF = Total Factor, AF = Antenna Factor, CL = Cable Loss

5.3. Out-of-band emissions

- Test configuration

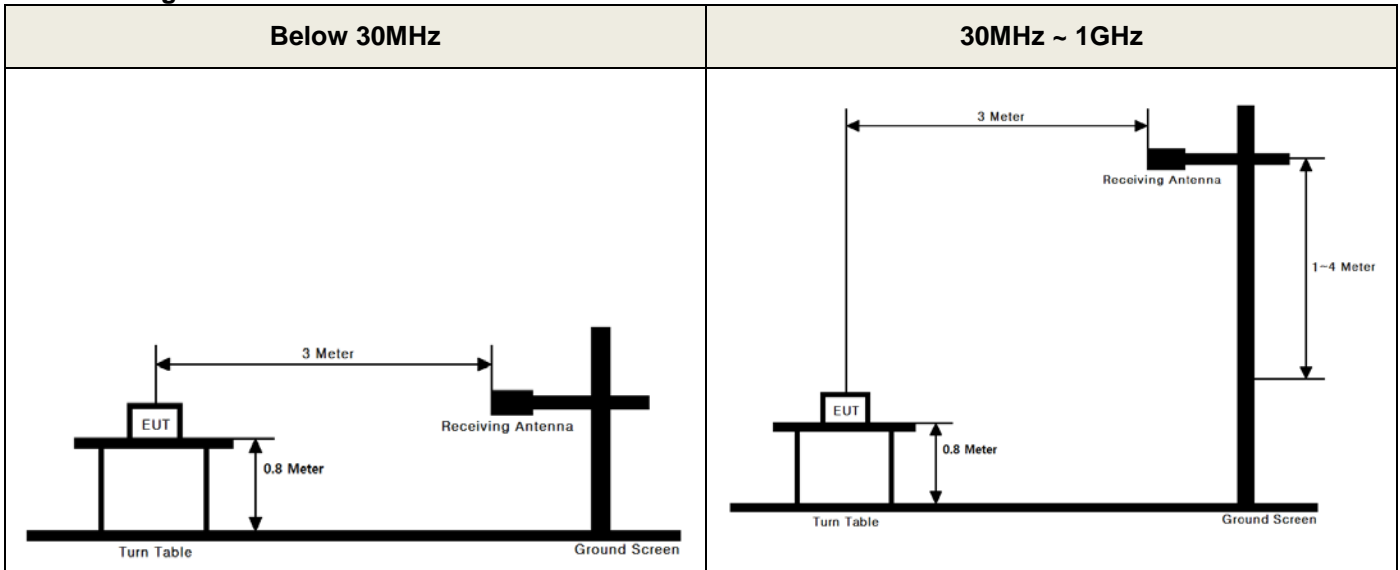

- Procedure: The radiated emission was tested according to the **section 6.4, 6.5 of the ANSI C63.10-2013.**

For below 30 MHz, measurements were performed as described in section 4.2.3.

For above 30 MHz;

The turntable shall rotate 360 degrees to determine the position of maximum emission level. EUT is set 3 m away from the receiving antenna, which varied from 1 m to 4 m to find out the highest emission. And also, each emission was to be maximized by changing the polarization of receiving antenna both horizontal and vertical. In order to find out the highest emission, the relative positions of the EUT were rotated through three orthogonal axes.

RBW = As specified in below table, VBW ≥ 3 x RBW, Sweep = Auto, Detector = Peak

Trace mode = Max Hold until the trace stabilizes.

Frequency	RBW
9 - 150 kHz	200 – 300 Hz
0.15 - 30 MHz	9 – 10 kHz
31 – 1 000 MHz	101 – 120 kHz
> 1000 MHz	1 MHz

- Minimum Standard: Part 15.209, 225(d) & RSS-210[B6(d)], RSS-Gen[8.9]

The field strength of any emissions appearing outside of the 13.110 - 14.010 MHz band shall not exceed the general radiated emission limits as below.

Frequency (MHz)	FCC Limit (uV/m)	IC Limit (uA/m)	Measurement Distance (m)
0.009 – 0.490	2 400 / F (kHz)	6.37/F (F in kHz)	300
0.490 – 1.705	2 4000 / F (kHz)	63.7/F (F in kHz)	30
1.705 – 30.0	30	0.08	30

Frequency (MHz)	FCC Limit (uV/m)	IC Limit (uV/m)	Measurement Distance (m)
30 ~ 88	100 **	100	3
88 ~ 216	150 **	150	3
216 ~ 960	200 **	200	3
Above 960	500	500	3

**Except as provided in paragraph (g), fundamental emissions from intentional radiators operating under this section shall not be located in the frequency bands 54-72 MHz, 76-88 MHz, 174-216 MHz or 470-806 MHz. However, operation within these frequency bands is permitted under other sections of this part, e.g., §§15.231 and 15.241.

- Measurement Data:

Frequency [MHz]	EUT Axis.	ANT (Note 1)	Reading [dBuV]	TF [dB/m]	DCF [dB]	Electric Field Strength [dBuV/m]	Magnetic Field Strength [dBuA/m]	Limit [dBuV/m]	Limit [dBuA/m]	Margin [dB]
0.553	Y	P	37.1	11.2	-40	8.3	-43.2	32.7	-18.8	24.4
27.100	Y	P	15.3	9.2	-40	-15.5	-67.0	29.5	-21.9	45.0
40.670	Y	V	33.7	-8.9	0	24.8	-	40.0	-	15.2
413.151	Y	H	32.2	-2.2	0	30.0	-	46.0	-	16.0
703.175	Y	H	30.0	3.5	0	33.5	-	46.0	-	12.5
790.472	Y	V	30.5	5.4	0	35.9	-	46.0	-	10.1
-	-	-	-	-	-	-	-	-	-	-
-	-	-	-	-	-	-	-	-	-	-

Note 1. No other spurious and harmonic emissions were reported greater than listed emissions above table.

Note 2. All data were recorded using a spectrum analyzer employing a peak detector.

If PK results were meet Quasi-peak limit, Quasi-peak measurements were omitted.

Note 3. Loop antenna orientation (30 MHz Below)

“P”= Parallel, “V”= perpendicular, “G”= ground-parallel

Bilog antenna polarization (30 MHz above)

“H”= Horizontal, “V”= Vertical

Note 4. Information of Distance Correction Factor

For finding emissions, measurements may be performed at a distance closer than that specified in the regulations.

In this case, the distance factor is applied to the result.

- Calculation of distance correction factor

At frequencies below 30 MHz = $40 \log(\text{tested distance} / \text{specified distance})$

At frequencies at or above 30 MHz = $20 \log(\text{tested distance} / \text{specified distance})$

When distance factor is “N/A”, the measurements were performed at the specified distance and distance factor is not applied.

Note 5. Sample calculation

Margin = Limit[dBuV/m] – Electric Field Strength

Electric Field Strength (dBuV/m) = Reading + TF – DCF

Magnetic Field Strength (dBuA/m) = Electric Field Strength – 51.5 dB

TF = AF + CL – AG

Where, TF = Total Factor, AF = Antenna Factor, CL = Cable Loss, AG = Amplifier Gain,

DCF = Distance Correction Factor

5.4. Frequency Stability

- Procedure:

Part 15.225 requires that devices operating in the 13.553 – 13.567 MHz shall maintain the carrier frequency within 0.01 % of the operating frequency over the temperature variation of -20 degrees to + 50 degrees C at normal supply voltage.

- Measurement Data: Comply

Operating Frequency : 13,560,000 Hz

VOLTAGE (%)	POWER (V _{DC})	TEMP (°C)	Frequency (Hz)	Freq. Dev. (Hz)	Deviation (%)
100%	5.00	+20(ref)	13,559,832	-168	0.001 239
100%		-20	13,559,845	-155	0.001 143
100%		-10	13,559,861	-139	0.001 025
100%		0	13,559,805	-195	0.001 438
100%		+10	13,559,803	-197	0.001 453
100%		+20	13,559,832	-168	0.001 239
100%		+30	13,559,822	-178	0.001 313
100%		+40	13,559,725	-275	0.002 028
100%		+50	13,559,739	-261	0.001 925
85%		4.25	20	13,559,817	-183
115%	5.75	20	13,559,833	-167	0.001 232

- Minimum Standard: Part 15. 225(e) & RSS-210 [B6]

The frequency tolerance of the carrier signal shall be maintained within ± 0.01 % of the operating frequency.

5.5. AC Power-Line Conducted Emissions

- Test Requirements and limit, Part 15.207 & RSS-Gen [8.8]

An intentional radiator that is designed to be connected to the public utility (AC) power line, the radio frequency voltage that is conducted back onto the AC power line on any frequency or frequencies, within the band 150 kHz to 30 MHz, shall not exceed the limits in the following table, as measured using a 50 uH/50 ohm line impedance stabilization network (LISN).

Compliance with the provision of this paragraph shall on the measurement of the radio frequency voltage between each power line and ground at the power terminal. The lower applies at the boundary between the frequency ranges.

Frequency Range (MHz)	Conducted Limit (dBuV)	
	Quasi-Peak	Average
0.15 ~ 0.5	66 to 56 *	56 to 46 *
0.5 ~ 5.0	56	46
5 ~ 30	60	50

* Decreases with the logarithm of the frequency

- Test Configuration

See test photographs for the actual connections between EUT and support equipment.

- Test Procedure

Conducted emissions from the EUT were measured according to the ANSI C63.10-2013.

1. The test procedure is performed in a 6.5 m × 3.5 m × 3.5 m (L × W × H) shielded room. The EUT along with its peripherals were placed on a 1.0 m (W) × 1.5 m (L) and 0.8 m in height wooden table and the EUT was adjusted to maintain a 0.4 meter space from a vertical reference plane.
2. The EUT was connected to power mains through a line impedance stabilization network (LISN) which provides 50 ohm coupling impedance for measuring instrument and the chassis ground was bounded to the horizontal ground plane of shielded room.
3. All peripherals were connected to the second LISN and the chassis ground also bounded to the horizontal ground plane of shielded room.
4. The excess power cable between the EUT and the LISN was bundled. The power cables of peripherals were unbundled. All connecting cables of EUT and peripherals were moved to find the maximum emission.

- **Measurement Data: Comply** (refer to the next page)

Measurement Data (with antenna terminated)

Results of Conducted Emission

DTNC

Date 2021-07-09

Order No.
Model No. CRM-1356BM
Serial No.
Test Condition NFC_13.56MHz

Reference No.
Power Supply 120 V, 60 Hz
Temp/Humi. 23 °C / 46 %
Operator S.M.GIL

Memo

LIMIT : FCC P15.207 QP
FCC P15.207 AV

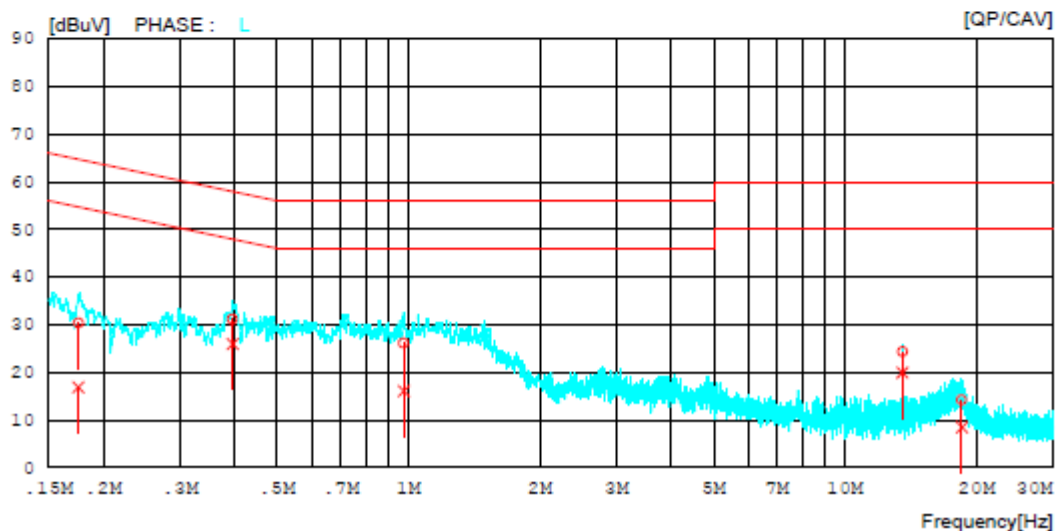
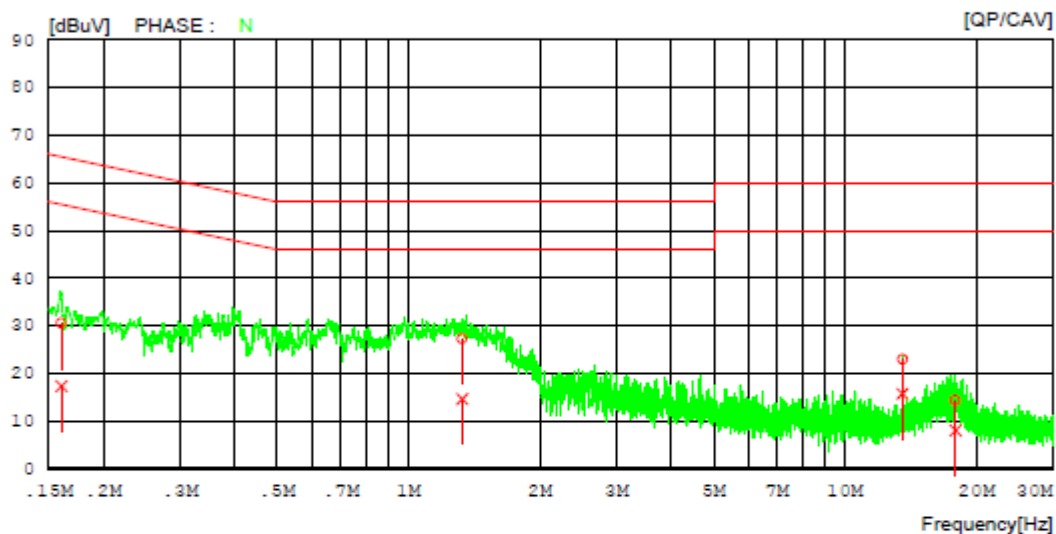

Measurement Data (with antenna terminated)

Results of Conducted Emission

DTNC

Date 2021-07-09

Order No.	Reference No.	120 V, 60 Hz
Model No. CRM-1356BM	Power Supply	23 °C / 46 %
Serial No.	Temp/Humi.	S.M.GIL
Test Condition NFC_13.56MHz	Operator	

Memo

 LIMIT : FCC P15.207 QP
 FCC P15.207 AV

NO	FREQ [MHz]	READING		C. FACTOR [dB]	RESULT		LIMIT		MARGIN		PHASE
		QP [dBuV]	CAV [dBuV]		QP [dBuV]	CAV [dBuV]	QP [dBuV]	CAV [dBuV]			
1	0.16037	20.63	7.44	9.90	30.53	17.34	65.44	55.44	34.91	38.10	N
2	1.32759	17.22	4.58	10.05	27.27	14.63	56.00	46.00	28.73	31.37	N
3	13.55872	12.58	5.38	10.39	22.97	15.77	60.00	50.00	37.03	34.23	N
4	17.89558	3.91	-2.39	10.45	14.36	8.06	60.00	50.00	45.64	41.94	N
5	0.17541	20.42	6.92	9.90	30.32	16.82	64.70	54.70	34.38	37.88	L
6	0.39530	21.22	16.05	9.91	31.13	25.96	57.95	47.95	26.82	21.99	L
7	0.97525	16.01	5.98	10.04	26.05	16.02	56.00	46.00	29.95	29.98	L
8	13.55872	13.86	9.50	10.36	24.22	19.87	60.00	50.00	35.78	30.14	L
9	18.54076	3.74	-1.98	10.39	14.13	8.41	60.00	50.00	45.87	41.59	L