

**LABORATORY TEST REPORT**  
**RADIO PERFORMANCE MEASUREMENTS**

for the

TPGH7A Handportable Transceiver

Tested in accordance with:

FCC 47 CFR Parts 22 and 90

RSS-119 Issue 12  
RSS-Gen Issue 5

Report Revision: 1

Issue Date: 27 November 2019

PREPARED BY: Alfred Schinkelshoek

  
Test Technician

CHECKED & APPROVED BY: M. C. James

  
Laboratory Technical Manager



FCC Registration: 838288  
ISED Registration: 737A

All tests reported herein have been performed in accordance with the laboratory's scope of accreditation.

This document must not be reproduced except in full, without the written permission of the Compliance Laboratory Manager

TELTEST Laboratories (A Division of Tait International Ltd)  
PO Box 1645, 558 Wairakei Road, Christchurch, New Zealand.

Telephone: 64 3 358 3399  
FAX: 64 3 359 4632

## TABLE OF CONTENTS

REVISION .....	3
INTRODUCTION .....	4
TEST REQUIREMENTS AND RESULT SUMMARY .....	5
STATEMENT OF COMPLIANCE .....	6
CHANNEL TABLE .....	7
LIST OF ANTENNA INTENDED FOR USE WITH THE DEVICE .....	8
MODULATION TYPES, NECESSARY BANDWIDTH & EMISSION DESIGNATORS	9
TEST RESULTS .....	11
TRANSMITTER OUTPUT POWER (CONDUCTED) .....	11
TRANSMITTER AUDIO FREQUENCY RESPONSE - PRE-EMPHASIS .....	13
TRANSMITTER MODULATION LIMITING .....	17
TRANSMITTER 99% EMISSION BANDWIDTH .....	20
TRANSMITTER OCCUPIED BANDWIDTH AND SPECTRUM MASKS .....	21
TRANSMITTER SPURIOUS EMISSIONS (CONDUCTED) .....	58
TRANSMITTER SPURIOUS EMISSIONS (RADIATED) .....	73
TRANSIENT FREQUENCY BEHAVIOR .....	78
TRANSMITTER FREQUENCY STABILITY - TEMPERATURE .....	91
TRANSMITTER FREQUENCY STABILITY - VOLTAGE .....	98
RECEIVER SPURIOUS EMISSIONS (CONDUCTED) .....	99
TEST EQUIPMENT LIST .....	103
ANNEX A – TEST SETUP DETAILS .....	105
ANNEX B – Photographs .....	107

## REVISION

<b>Date</b>	<b>Revision</b>	<b>Comments</b>
27 November 2019	1	Initial test report

## INTRODUCTION

Type approval testing of the TPGH7A, 4 Watt, Handportable transceiver in order to demonstrate compliance with FCC 47 Parts 22 & 90, and RSS-119 Issue 12 & RSS-Gen Issue 5. This radio supports analogue, digital FFSK, Digital Mobile Radio (DMR), APCO P25 phase-1 and APCO P25 phase-2 modulations.

### REPORT PREPARED FOR

Tait International Ltd  
245 Wooldridge Road  
Harewood  
Christchurch 8051  
New Zealand

### DESCRIPTION OF SAMPLE

Manufacturer: Tait International Limited  
Equipment: Handportable Transceiver  
Type: TPGH7A  
Product Code: T03-00071-HBAA  
Serial Number(s): 26205906  
Frequency range: 450 → 520 MHz  
Transmit Power: 4 W

Modulation		Channel Spacing	Speech Channels	Symbol Rate (symbols/sec)	Data Rate (bps)
Analogue FM		12.5 kHz	1	-	-
FFSK	Fast Frequency Shift Keying	12.5 kHz	-	1200	1200
		12.5 kHz	-	2400	2400
Digital Mobile Radio (DMR)	4 Level FSK (2 slot TDMA) (ETSI TS102 361-1)	12.5 kHz	2	4800	9600
APCO P25 Phase 1	C4FM (TIA 102)	12.5 kHz	1	4800	9600
APCO P25 Phase 2	H-CPM (2 slot TDMA) (TIA 102)	12.5 kHz	2	6000	12000

### HARDWARE & SOFTWARE

Quantity: 1

### Analog and DMR Tests:

<b>Type</b>	<b>Code and Version</b>
Hardware ID	TPGB1X-H700_0001
Firmware Package	QIDMR_TPG.0060

### P25 Phase I & Phase II

<b>Type</b>	<b>Code and Version</b>
Hardware ID	TPGB1X-H700_0001
Firmware Package	QIP25_TPG.0060

### TEST CONDITIONS

All testing was performed between 18 → 27 November 2019, and under the following conditions:

Ambient temperature: 15°C → 30°C  
Relative Humidity: 20% → 75%  
Standard Test Voltage 7.5 V<sub>DC</sub>

## TEST REQUIREMENTS AND RESULT SUMMARY

<b>ISED Specification</b>	<b>FCC Specification</b>	<b>Test Items</b>	<b>Test Methods</b>	<b>Result</b>
RSS-119 5.3	FCC 47 CFR 90.214	Transmitter Frequency Stability - Temperature	RSS-Gen 6.11 ANSI C63.26 5.6.4	Pass
RSS-119 5.3	FCC 47 CFR 2.1055 (d) (1)	Transmitter Frequency Stability - Voltage	RSS-Gen 6.11 ANSI C63.26 5.6.5	Pass
RSS-119 5.4	FCC 47 CFR 2.1046	Transmitter Output Power (Conducted)	RSS-Gen 6.12 ANSI C63.26 5.2.4.2	Pass
RSS-119 5.5	FCC 47CFR 90.209	Transmitter 99% Emission Bandwidth	RSS-Gen 6.7 ANSI C63.26 5.4.4	Pass
RSS-119 5.5	FCC 47 CFR 2.1049 (c)	Transmitter Occupied Bandwidth and Spectrum Mask	RSS-119 4.2.2 TIA-603-E 2.2.11	Pass
RSS-119 5.8	FCC 47 CFR 2.1051	Transmitter Spurious Emissions (Conducted)	RSS-Gen 6.13 ANSI C63.26 5.7	Pass
RSS-119 5.8	FCC 47 CFR 2.1053	Transmitter Spurious Emissions (Radiated)	RSS-Gen 6.13 ANSI C63.26 5.5	Pass
RSS-119 5.9	FCC 47 CFR 90.214	Transient Frequency Behaviour	TIA 603E 2.2.2	Pass
RSS-Gen 7	FCC 47CFR 15.111	Receiver Spurious Emissions (Conducted)	RSS-Gen 7.4 TIA-603E 2.1.2	Pass

## STATEMENT OF COMPLIANCE

We, TELTEST LABORATORIES of 558 Wairakei Road, Christchurch, New Zealand, declare under our sole responsibility that the product:

Equipment: Handportable Transceiver  
Type: TPGH7A  
Product Code: T03-00071-HBAA  
Serial Number(s): 26205906  
Quantity: 1

to which this declaration relates, is in conformity with the following standards:

FCC 47 CFR Parts 22 and 90

RSS-119 Issue 12 & RSS-Gen Issue 5

Signature: 

M. C. James  
Laboratory Technical Manager

Date: 2 December 2019

The results obtained in this test report pertain only to the item(s) tested. Teltest does not make any claims of compliance for samples or variants that were not tested.

## CHANNEL TABLE

Label	Channel Number	Receive Frequency	Transmit Frequency	Power	Bandwidth
450 NH	1	450.125000	450.125000	4 watts	12.5
450 NL	2	450.125000	450.125000	1 watt	12.5
454 NH	3	454.500000	454.500000	4 watts	12.5
454 NL	4	454.500000	454.500000	1 watt	12.5
459 NH	5	459.900000	459.900000	4 watts	12.5
459 NL	6	459.900000	459.900000	1 watt	12.5
465 NH	7	465.100000	465.100000	4 watts	12.5
465 NL	8	465.100000	465.100000	1 watt	12.5
469 NH	9	469.900000	469.900000	4 watts	12.5
469 NL	10	469.900000	469.900000	1 watt	12.5
511 NH	11	511.900000	511.900000	4 watts	12.5
511 NL	12	511.900000	511.900000	1 watt	12.5

**Programming Application Name**  
DMR and P25 Terminals Programming Application

**Version**  
2.106.1.74

## LIST OF ANTENNA INTENDED FOR USE WITH THE DEVICE

Manufacturer Part Number	Antenna Type	Antenna Gain	Antenna Input Impedance
TPA-AN-012	¼ Wave Whip	2dBi	50 Ω
TPA-AN-015	Helical	1dBi	50 Ω

The equipment tested has a 50 Ω coaxial antenna connection. No antenna was fitted to the EUT during testing the parameters in this report.

The EUT was connected as shown in Annex A, using a customer supplied test box to provide access to the analogue and digital interfaces. A “dummy” battery with connections for external DC supply was used to power the equipment.



## MODULATION TYPES, NECESSARY BANDWIDTH & EMISSION DESIGNATORS

### MODULATION TYPES:

F3E	Analogue Frequency Modulation (FM)	
F2D	FFSK	1200 bps and 2400 bps
FXW	DMR Digital Voice	9600 bps
FXD	DMR Digital Data	9600 bps
F1E	P25 phase 1 Digital Voice	9600 bps
F1D	P25 phase 1 Digital Data	9600 bps
F1W	P25 phase 2 Digital Voice / Data	12000 bps

CHANNEL SPACING: 12.5 kHz

### EMISSION DESIGNATORS:

	12.5 kHz
Analog FM	11K0F3E
FFSK Data 1200 bps	6K60F2D
FFSK Data 2400 bps	7K80F2D
Digital Voice DMR	7K60FXW
Digital Data DMR	7K60FXD
Digital Voice P25 phase 1	8K10F1E
Digital Data P25 phase 1	8K10F1D
Digital Data and Voice P25 phase 2	8K10F1W

### CALCULATIONS

Equation:  $B_n = 2M + 2Dk$

(M is highest modulating frequency; D is peak allowable deviation; k is a constant of 1 for FM)

#### Analogue Voice 12.5 kHz Bandwidth

Necessary bandwidth

M = 3.0 kHz

D = 2.5 kHz

$$B_n = (2 \times 3.0) + (2 \times 2.5) \times 1$$

$$= 11.0 \text{ kHz}$$

Emission Designator

**11K0F3E**

F3E represents an FM voice transmission

#### Fast Frequency Shift Keying (FFSK – 1200 bps) 12.5 kHz Bandwidth

Necessary bandwidth

M = 1.8 kHz

D = 1.5 kHz (60% of peak deviation)

$$B_n = (2 \times 1.8) + (2 \times 1.5) \times 1$$

$$= 6.6 \text{ kHz}$$

Emission Designator

**6K60F2D**

F2D represents a FM data transmission with the use of a modulating sub carrier

#### Fast Frequency Shift Keying (FFSK – 2400 bps) 12.5 kHz Bandwidth

Necessary bandwidth

M = 2.4 kHz

D = 1.5 kHz (60% of peak deviation)

$$B_n = (2 \times 2.4) + (2 \times 1.5) \times 1$$

$$= 7.8 \text{ kHz}$$

Emission Designator

**7K80F2D**

F2D represents a FM data transmission with the use of a modulating sub carrier

$$= 10.8 \text{ kHz}$$

## Emission Designators – Continued

Digital Voice 12.5 kHz Bandwidth DMR  
99% bandwidth  
= 7.6 kHz

Emission Designator  
**7K60FXW**  
FXW represents a FM Time Division Multiple Access (TDMA) combination of data and telephony

Digital Data 12.5 kHz Bandwidth DMR  
99% bandwidth  
= 7.6 kHz

Emission Designator  
**7K60FXD**  
FXD represents FM Time Division Multiple Access (TDMA) data only

Digital Voice 12.5 kHz Bandwidth P25 phase 1  
99% bandwidth  
= 8.1 kHz

Emission Designator  
**8K10F1E**  
F1E represents a digital FM voice transmission

Digital Data 12.5 kHz Bandwidth P25 phase 1  
99% bandwidth  
= 8.1 kHz

Emission Designator  
**8K10F1D**  
F1D represents an digital FM data transmission

Digital Data and Voice 12.5 kHz Bandwidth P25 phase 2  
99% bandwidth  
= 8.1 kHz

Emission Designator  
**8K10F1W**  
F1W represents an FM channel with a combination of digital data and voice transmission

## TEST RESULTS

### TRANSMITTER OUTPUT POWER (CONDUCTED)

SPECIFICATION: FCC 47 CFR 2.1046  
RSS-119 5.4  
RSS-Gen 6.12

GUIDE: ANSI C63.26 5.2.4.2

#### MEASUREMENT PROCEDURE:

1. Refer Annex A for Equipment set up.
2. The coaxial attenuator has an impedance of 50 Ohms.
3. The unmodulated output power was measured with an RF Power meter.

#### EXAMPLE CALCULATION:

<u>Example calculation</u>	
Power in dBm =	Measured power (dBm) + attenuator and cable loss (dB)
Chan 1 power (dBm)	5.36 dBm +30.82 dB
=	= 36.18dBm
Power in Watts =	$(10^{(36.18\text{dBm})}/10)/1000$
=	= 4.1W

#### MEASUREMENT RESULTS:

Manufacturer's Rated Output Power:

Switchable: 4 W and 1 W

Nominal 4 W	Measured (W)	Variation (%)	Variation (dB)
450.125 MHz	4.1	3.7	0.2
454.5 MHz	4.2	4.0	0.2
459.9 MHz	4.2	4.8	0.2
465.1 MHz	4.2	6.0	0.3
469.9 MHz	4.3	6.3	0.3
511.9 MHz	4.2	5.8	0.2
Measurement Uncertainty		± 0.6 dB	

Transmitter Output Power (Conducted) - continued

Nominal 1 W	Measured (W)	Variation (%)	Variation (dB)
450.125 MHz	1.0	3.2	0.1
454.5 MHz	1.0	1.1	0.0
459.9 MHz	1.0	3.1	0.1
465.1 MHz	1.0	4.4	0.2
469.9 MHz	1.1	6.8	0.3
511.9 MHz	1.0	4.2	0.2
Measurement Uncertainty		± 0.6 dB	

LIMIT CLAUSES:

FCC 47 CFR 90.205 (s)

The output power shall not exceed by more than 20%... the manufacturer's rated output power for the particular transmitter specifically listed on the authorization.

RSS-119 5.4

The output power shall be within ±1.0 dB of the manufacturer's rated power.

## TRANSMITTER AUDIO FREQUENCY RESPONSE - PRE-EMPHASIS

SPECIFICATION: FCC 47 CFR 2.1047 (a)

GUIDE: ANSI C63.26 5.3.3.2

### MEASUREMENT PROCEDURE:

1. Refer Annex A for Equipment set up.
2. An audio input tone of 1000 Hz was applied with the level set to obtain 20% of maximum deviation. This was used as the 0 dB reference point.
3. The AF was varied while the audio level was held constant.
4. The response in dB relative to 1000 Hz was measured.

### MEASUREMENT RESULTS:

See the plots on the following pages for 12.5 kHz channel spacing tested at 4 W transmit power.

LIMIT CLAUSE: TIA/EIA-603E 3.2.6

MEASUREMENT UNCERTAINTY:  $\pm 1.5\%$

Tx FREQUENCY: 450.125 MHz

12.5 kHz Channel Spacing

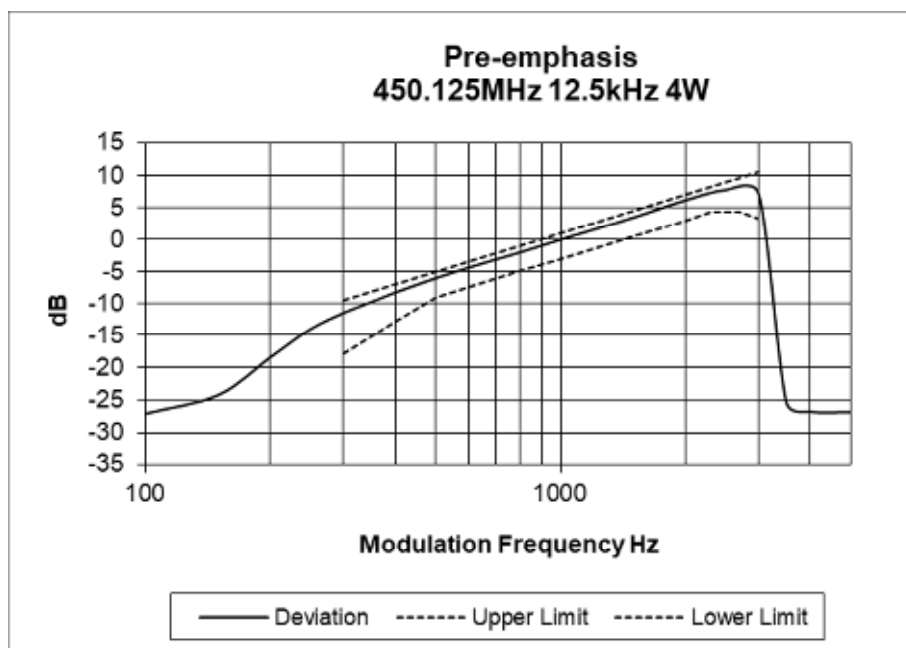

### Transmitter Audio Frequency Response – Pre-emphasis

Tx FREQUENCY: 454.5 MHz

12.5 kHz Channel Spacing

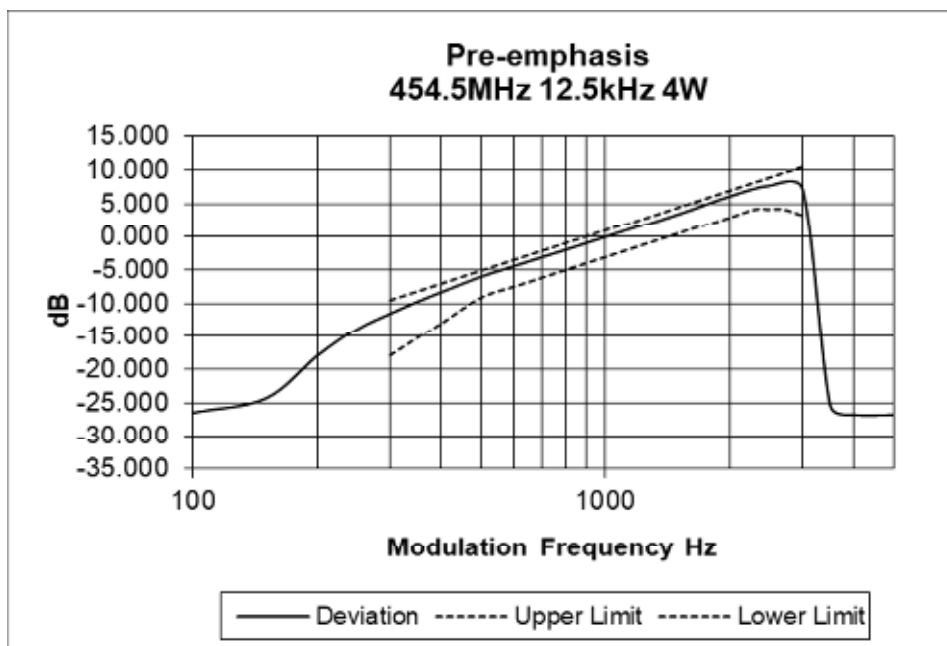

Tx FREQUENCY: 459.9 MHz

12.5 kHz Channel Spacing

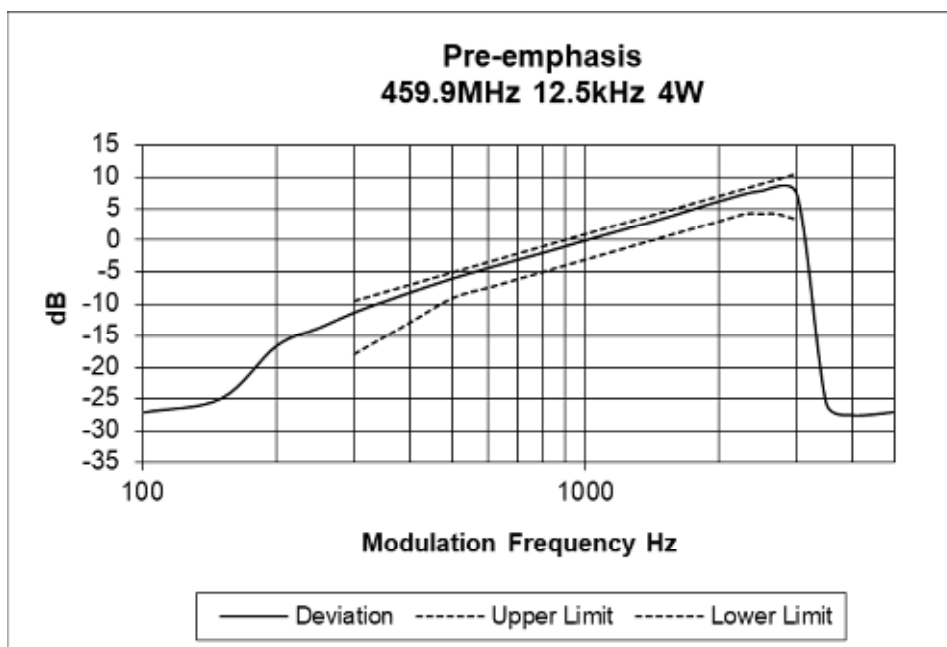

### Transmitter Audio Frequency Response – Pre-emphasis

Tx FREQUENCY: 465.1 MHz

12.5 kHz Channel Spacing

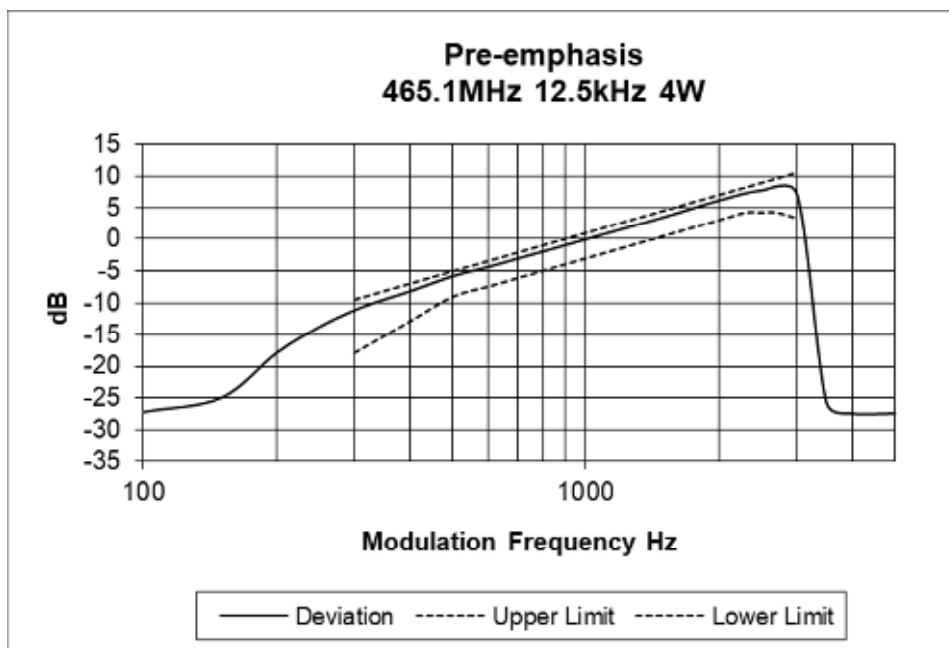

Tx FREQUENCY: 469.9 MHz

12.5 kHz Channel Spacing

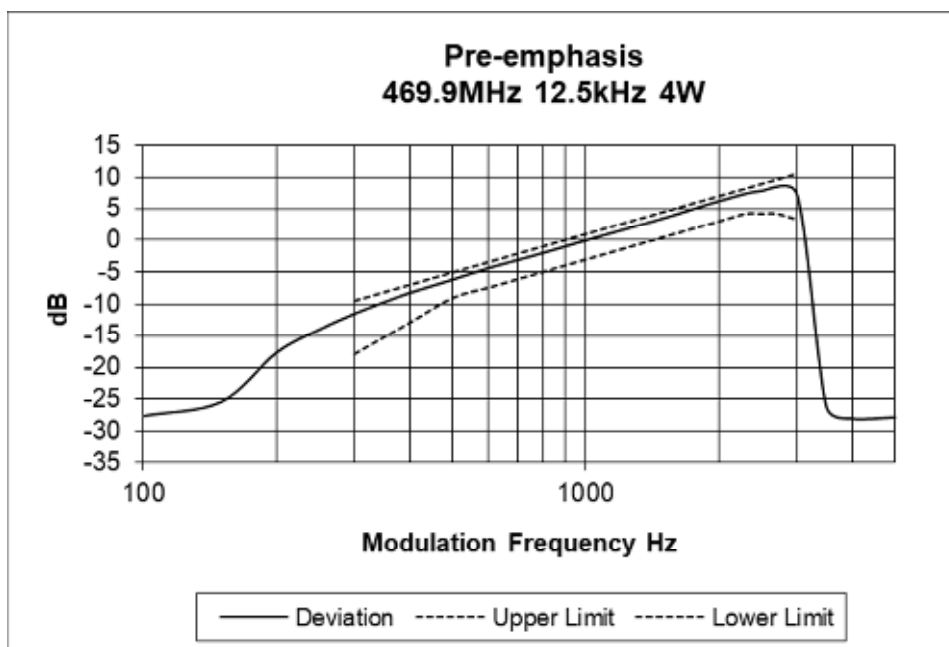

Transmitter Audio Frequency Response – Pre-emphasis

Tx FREQUENCY: 511.9 MHz 12.5 kHz Channel Spacing

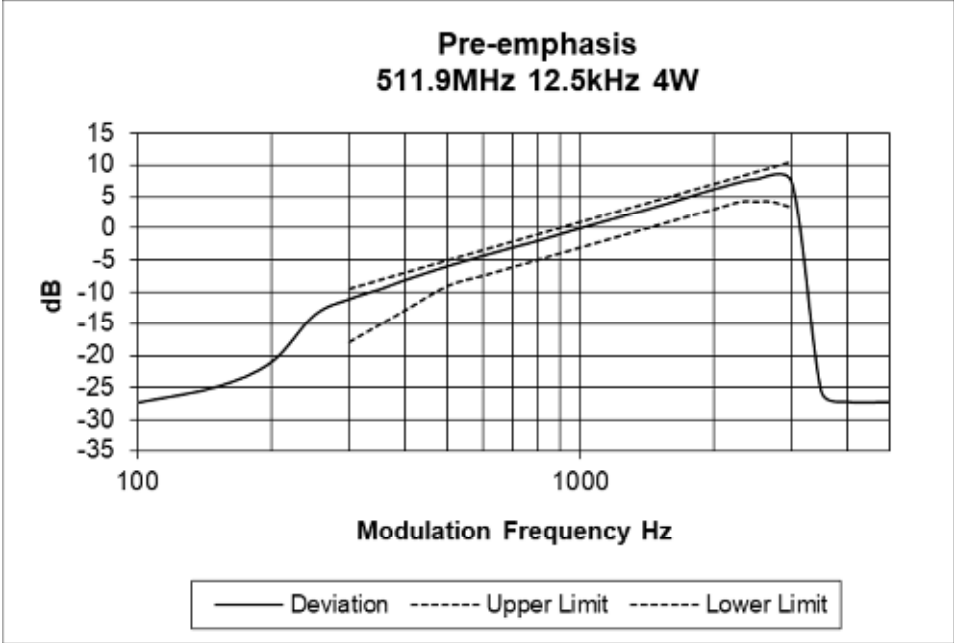



## TRANSMITTER MODULATION LIMITING

SPECIFICATION: FCC 47 CFR 2.1047 (b)

GUIDE: ANSI C63.26 5.3.2

### MEASUREMENT PROCEDURE:

1. Refer Annex A for Equipment set up.
2. An audio input tone of 1000 Hz was applied with the level set to obtain 60% of maximum deviation. This was used as the 0 dB reference point.
3. The modulation response was measured at four audio frequencies while increasing the input level in 5dB steps.
4. Additionally the level used to measure sideband spectrum (occupied bandwidth) was included in the level sweep.
5. Measurements were made for both Positive and Negative Deviation.

### MEASUREMENT RESULTS:

See the plots on the following pages for 12.5 kHz channel spacing.

LIMIT CLAUSE: TIA/EIA-603E 1.3.4.4

MEASUREMENT UNCERTAINTY:  $\pm 1.5 \%$

Tx FREQUENCY: 450.125 MHz

12.5 kHz Channel Spacing

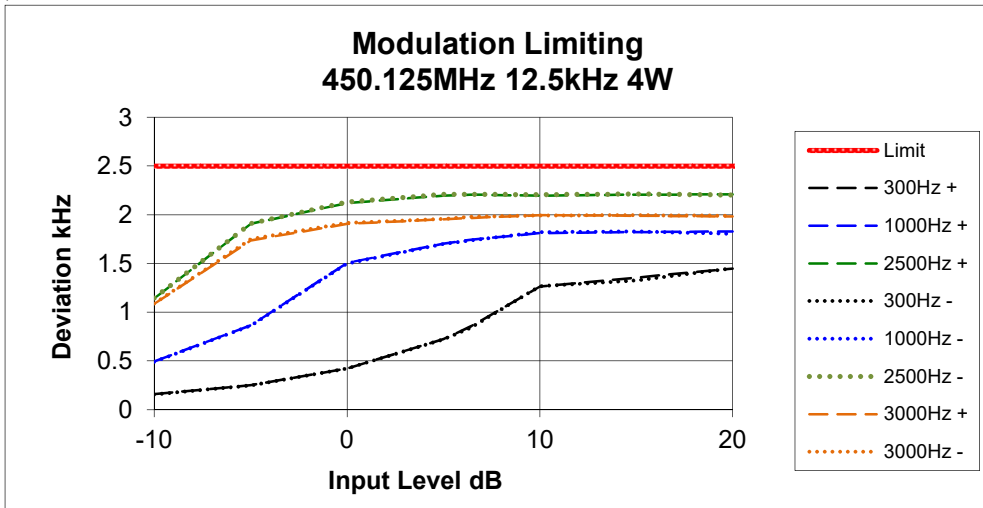

Tx FREQUENCY: 454.5 MHz

12.5 kHz Channel Spacing

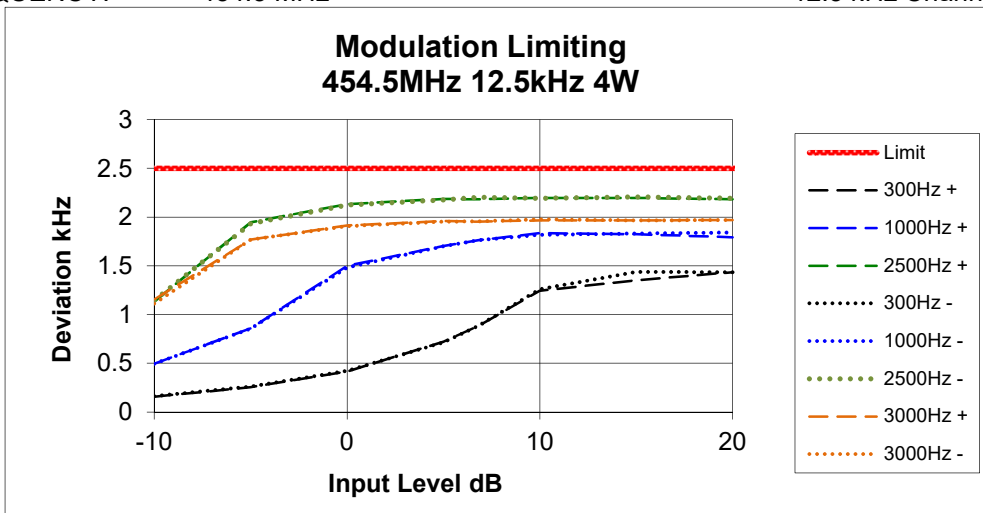

Tx FREQUENCY: 459.9 MHz

12.5 kHz Channel Spacing

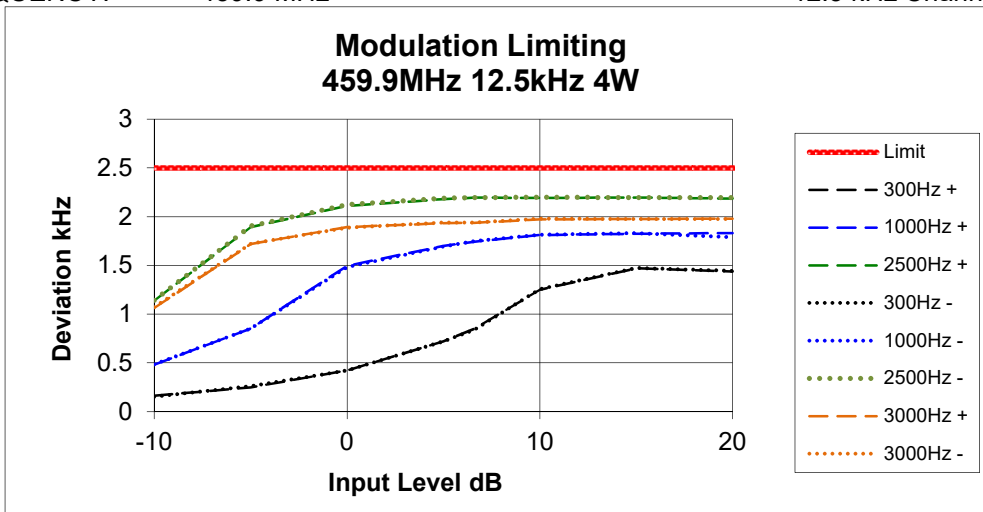

### Transmitter Modulation Limiting

Tx FREQUENCY: 465.1 MHz

12.5 kHz Channel Spacing

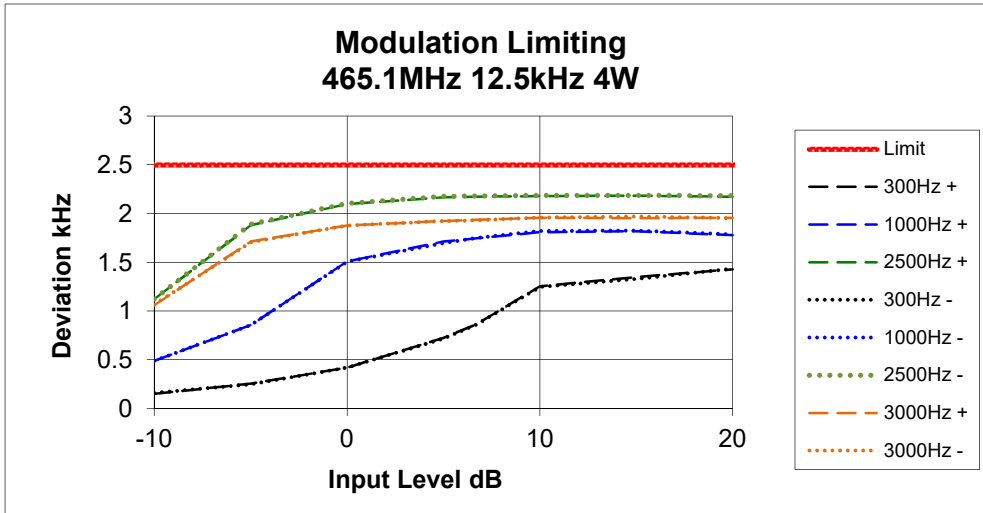

Tx FREQUENCY: 469.9 MHz

12.5 kHz Channel Spacing

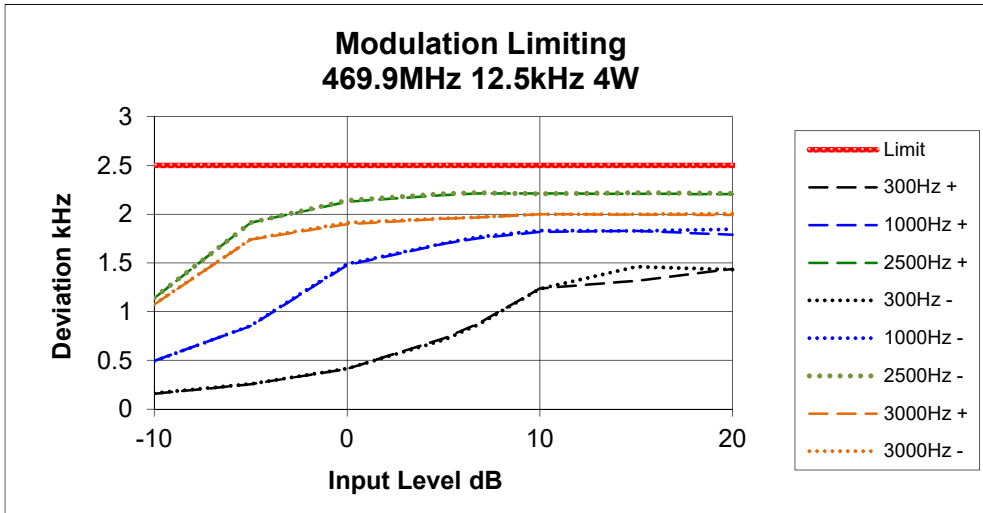

Tx FREQUENCY: 511.9 MHz

12.5 kHz Channel Spacing

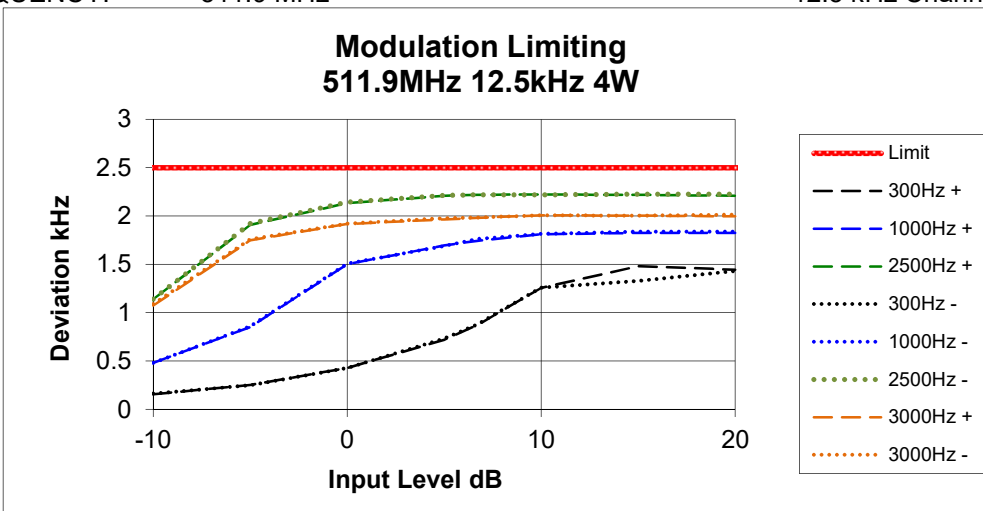

## TRANSMITTER 99% EMISSION BANDWIDTH

SPECIFICATION: RSS-119 5.5

GUIDE: RSS-Gen 6.7

### MEASUREMENT PROCEDURE:

1. Refer Annex A for Equipment Set up.
2. For analog measurements: The EUT was modulated by a 2500 Hz tone at an input level 16 dB above a level that produced 50% deviation. The input level was established at the frequency of maximum response of the audio modulating circuit.  
For Data measurements: The EUT was modulated with an internally generated pseudo random bit sequence at the appropriate Baud rates.
3. The Occupied Bandwidth was measured on the Spectrum Analyser.

### MEASUREMENT RESULTS:

Channel Spacing (MHz)	Channel Spacing (kHz)	Bandwidths (kHz)					
		Analog	FFSK 1200 bps	FFSK 2400 bps	DMR	APCO P25 phase I	APCO P25 phase II
450.125	12.5	9.93	6.10	5.40	7.47	7.72	7.80
454.5	12.5	9.77	6.10	5.38	7.53	7.97	7.87
459.9	12.5	9.93	5.92	5.33	7.58	7.93	7.80
465.1	12.5	9.93	6.20	5.38	7.43	7.68	7.83
469.9	12.5	9.93	6.00	5.33	7.42	7.97	7.93
511.9	12.5	9.93	6.27	5.43	7.37	7.85	7.70
Limit Authorized Bandwidth 47 CFR 90.209 RSS 119 5.5		11.25	11.25	11.25	11.25	11.25	11.25
Necessary BW used in emission designator		11.0	6.6	7.8	7.6	8.1	8.1
Result		Pass	Pass	Pass	Pass	Pass	Pass

## TRANSMITTER OCCUPIED BANDWIDTH AND SPECTRUM MASKS

SPECIFICATION: FCC 47 CFR 2.1049 (c) RSS-119 5.5

GUIDE: TIA/EIA-603E 2.2.11 (Analogue)  
TIA-102.CAAA-C 2.2.5 (Digital)

### MEASUREMENT PROCEDURE:

4. Refer Annex A for Equipment Set up.
5. For Analogue measurements: The EUT was modulated by a 2500 Hz tone at an input level 16 dB above a level that produced 50% deviation. The input level was established at the frequency of maximum response of the audio modulating circuit.  
For Data measurements: The EUT was modulated with an internally generated pseudo random bit sequence at the appropriate Baud rates.
6. The Occupied Bandwidth was measured on the Spectrum Analyser, with bandwidth settings as noted on the recorded plots.

### MEASUREMENT RESULTS:

See the plots on the following pages for 12.5 kHz channel spacing.

MEASUREMENT UNCERTAINTY 95%  $\pm 0.65$ dB

LIMIT CLAUSE: FCC 47 CFR 90.210 RSS-119 5.5

### EMISSION MASKS

Emission Mask D 12.5 kHz Channel Spacing Analogue, FFSK, Digital Voice/data

### DATA SPEED

Digital Voice/Data 12.5 kHz Channel Spacing 9600 bps & 12000 bps  
FFSK 12.5 kHz Channel Spacing 1200 bps & 2400 bps

### Occupied Bandwidth and Spectrum Masks

ANALOGUE VOICE

Tx FREQUENCY: 450.125 MHz 4 W 12.5 kHz Channel Spacing

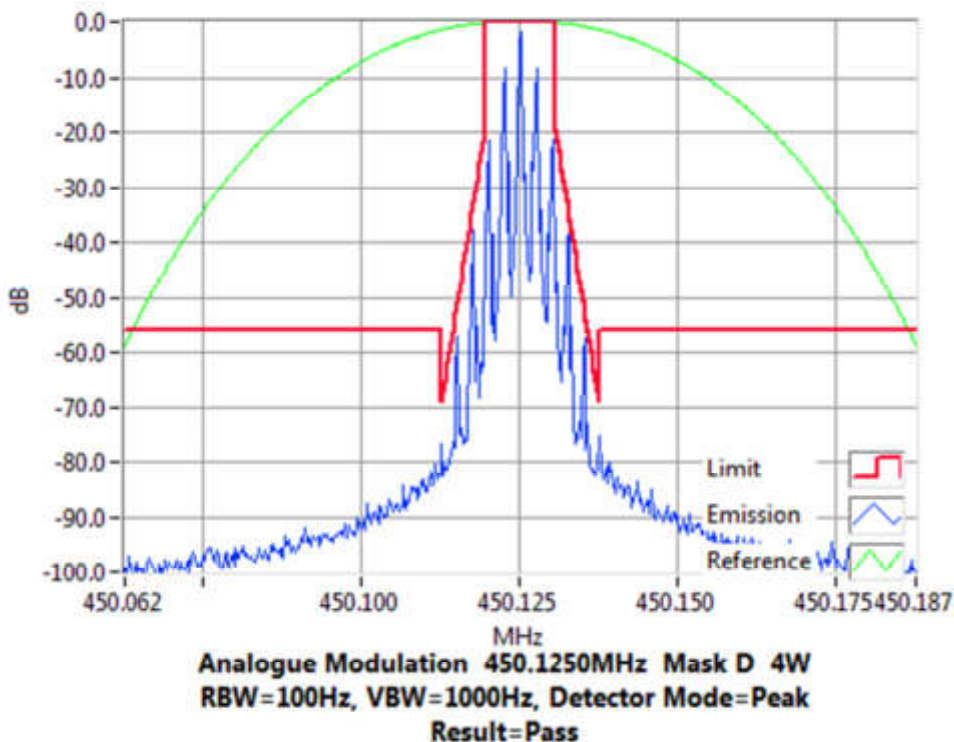

Tx FREQUENCY: 450.125 MHz 1 W 12.5 kHz Channel Spacing

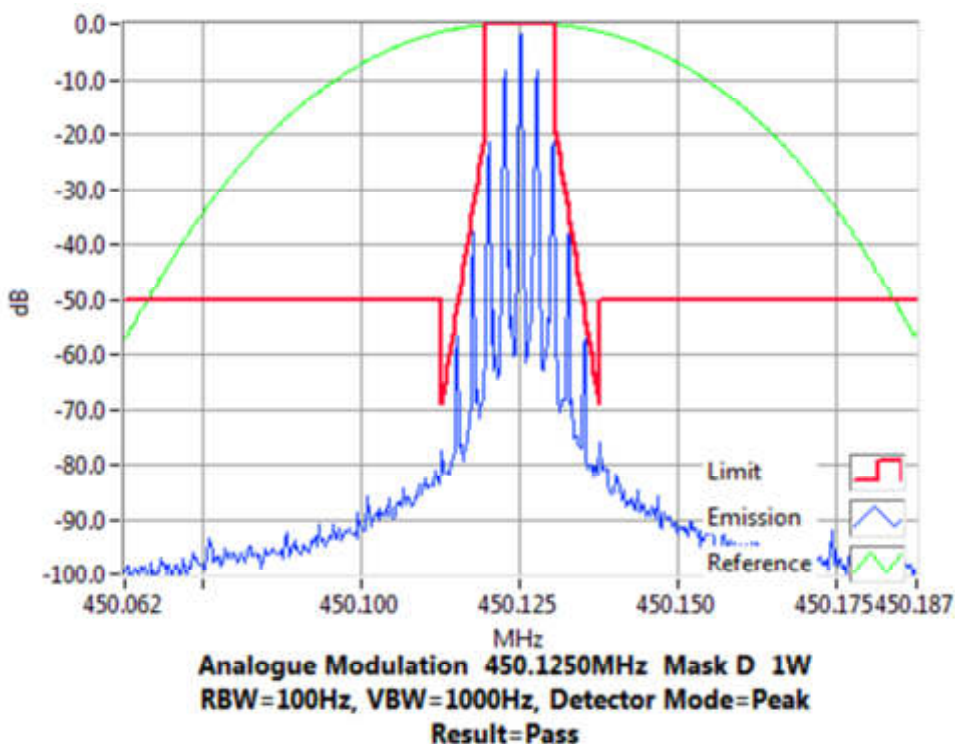

### Occupied Bandwidth and Spectrum Masks

ANALOGUE VOICE

Tx FREQUENCY: 454.5 MHz 4 W 12.5 kHz Channel Spacing

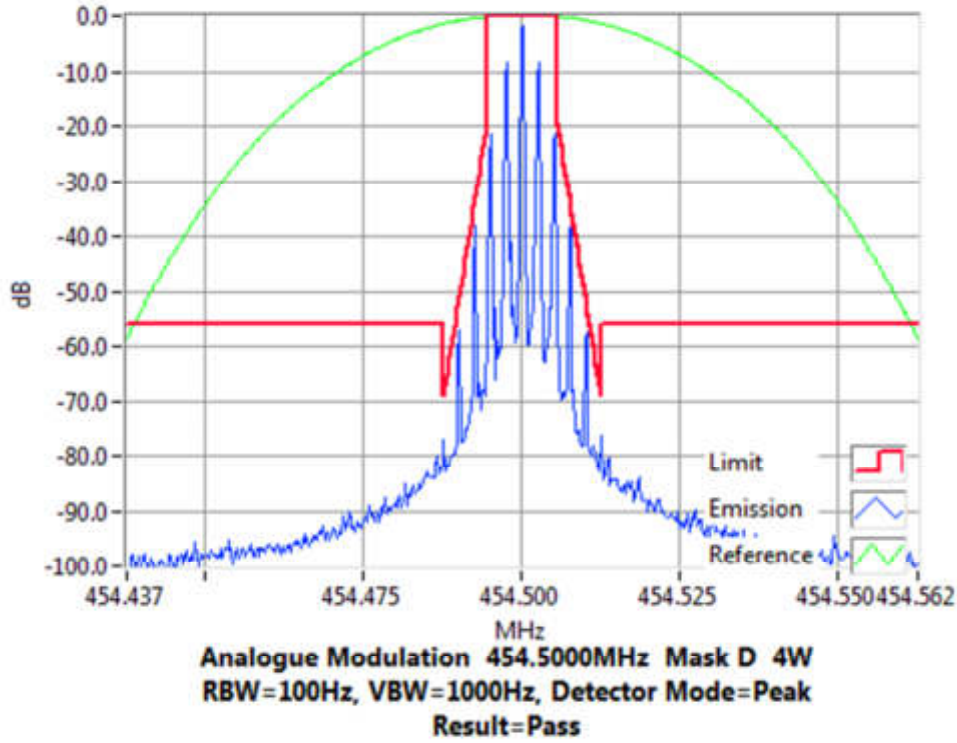

Tx FREQUENCY: 454.5 MHz 1 W 12.5 kHz Channel Spacing

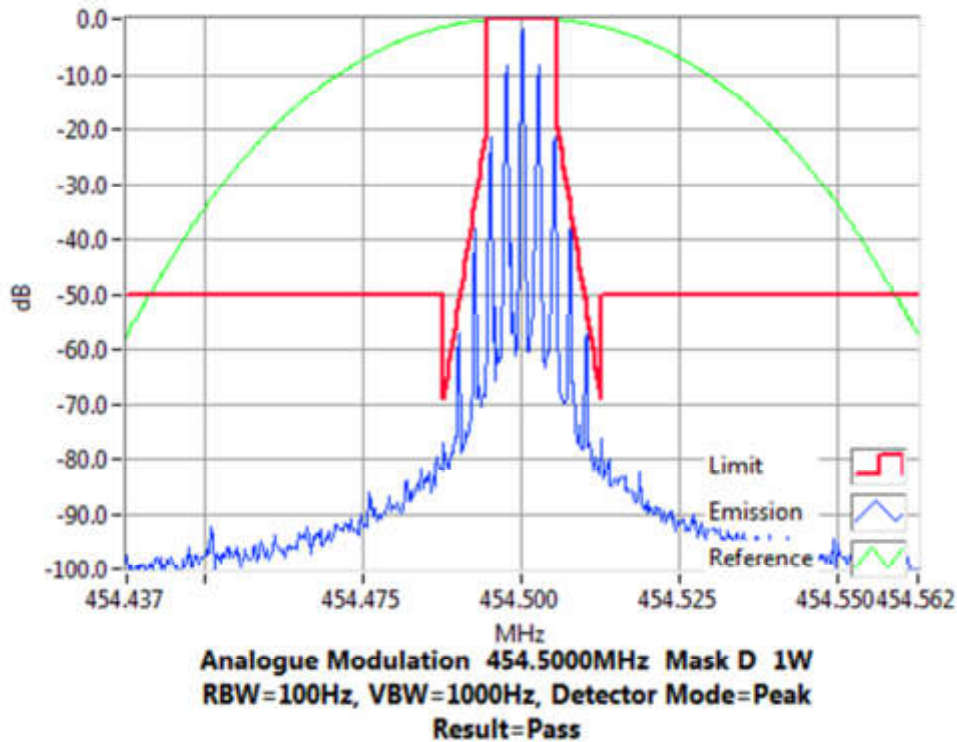

### Occupied Bandwidth and Spectrum Masks

ANALOGUE VOICE

Tx FREQUENCY: 459.9 MHz 4 W 12.5 kHz Channel Spacing

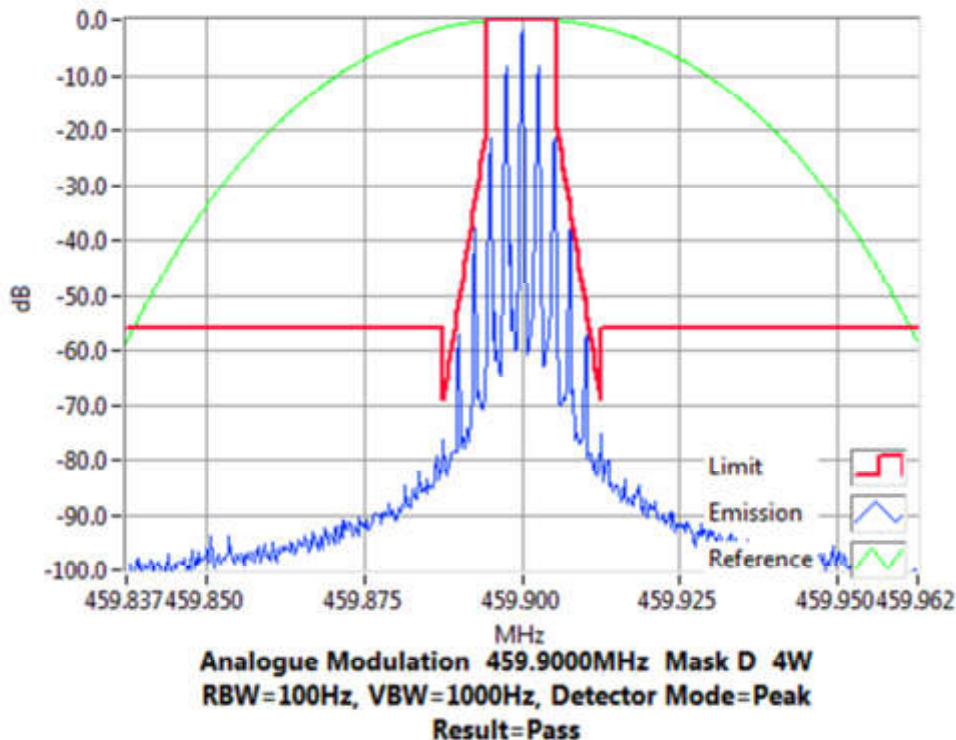

Tx FREQUENCY: 459.9 MHz 1 W 12.5 kHz Channel Spacing

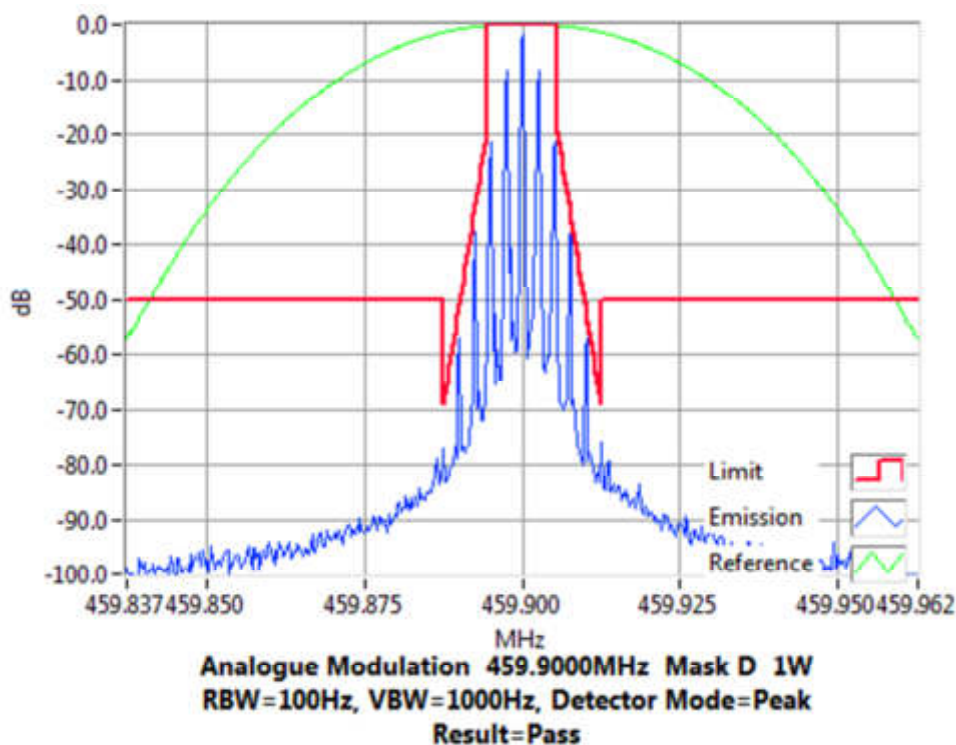



### Occupied Bandwidth and Spectrum Masks

ANALOGUE VOICE

Tx FREQUENCY: 465.1 MHz 4 W 12.5 kHz Channel Spacing

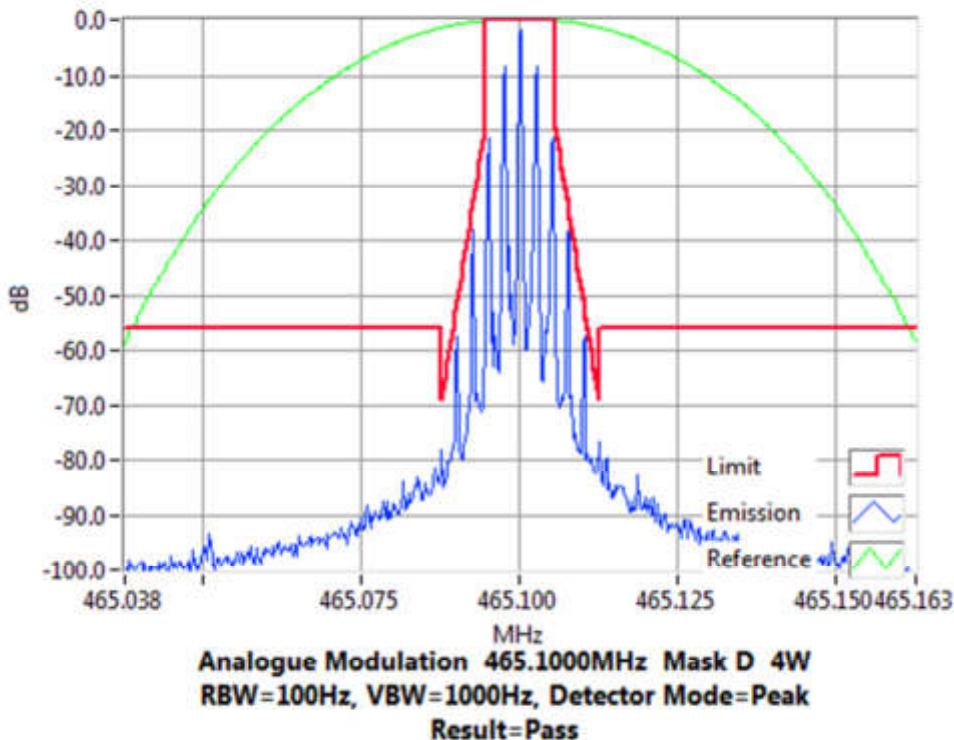

Tx FREQUENCY: 465.1 MHz 1 W 12.5 kHz Channel Spacing

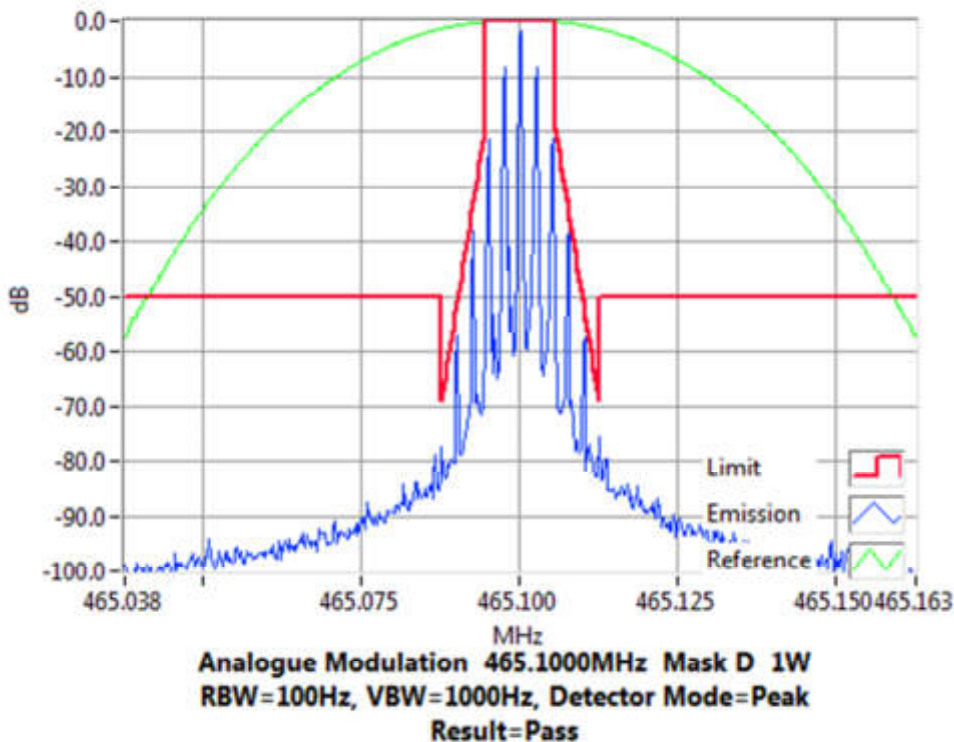

### Occupied Bandwidth and Spectrum Masks

ANALOGUE VOICE

Tx FREQUENCY: 469.9 MHz 4 W 12.5 kHz Channel Spacing

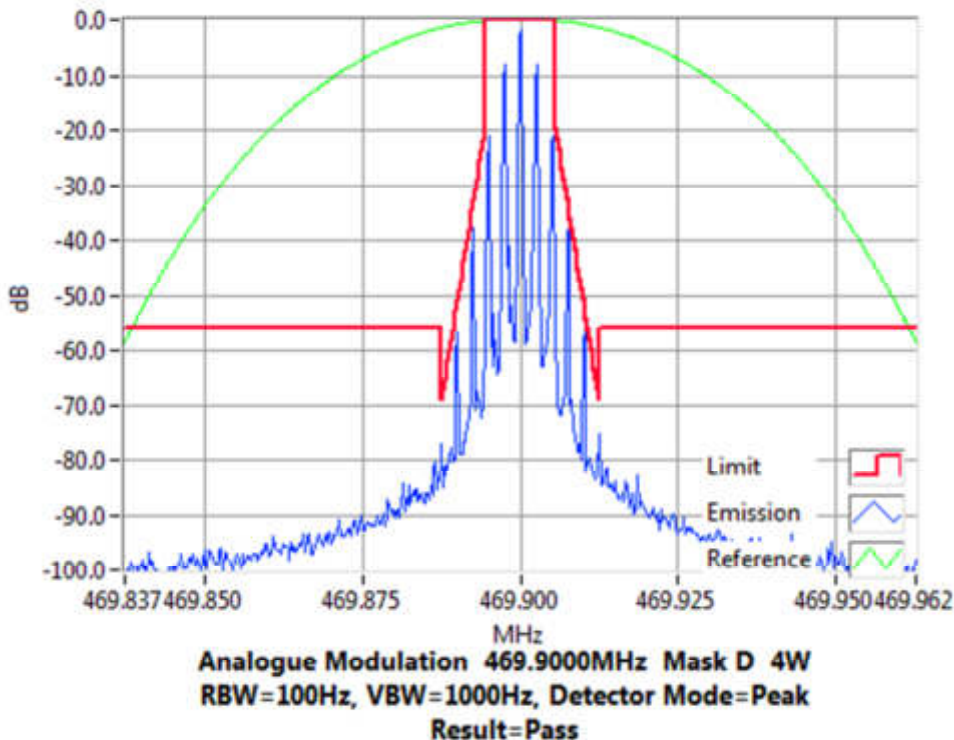

Tx FREQUENCY: 469.9 MHz 1 W 12.5 kHz Channel Spacing

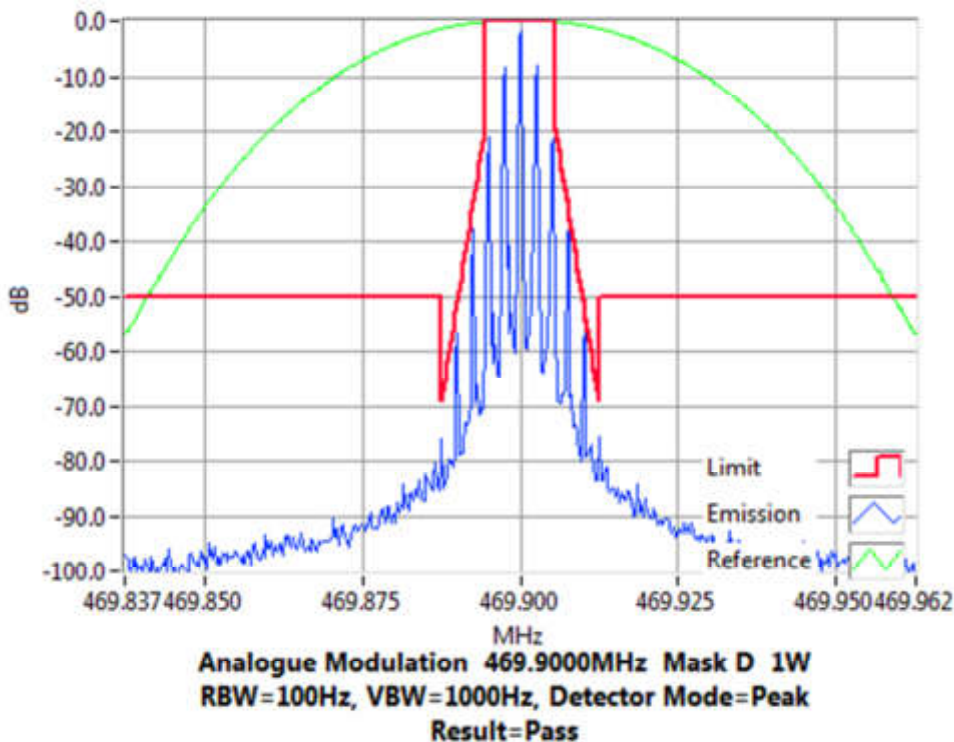

### Occupied Bandwidth and Spectrum Masks

ANALOGUE VOICE

Tx FREQUENCY: 511.9 MHz 4 W 12.5 kHz Channel Spacing

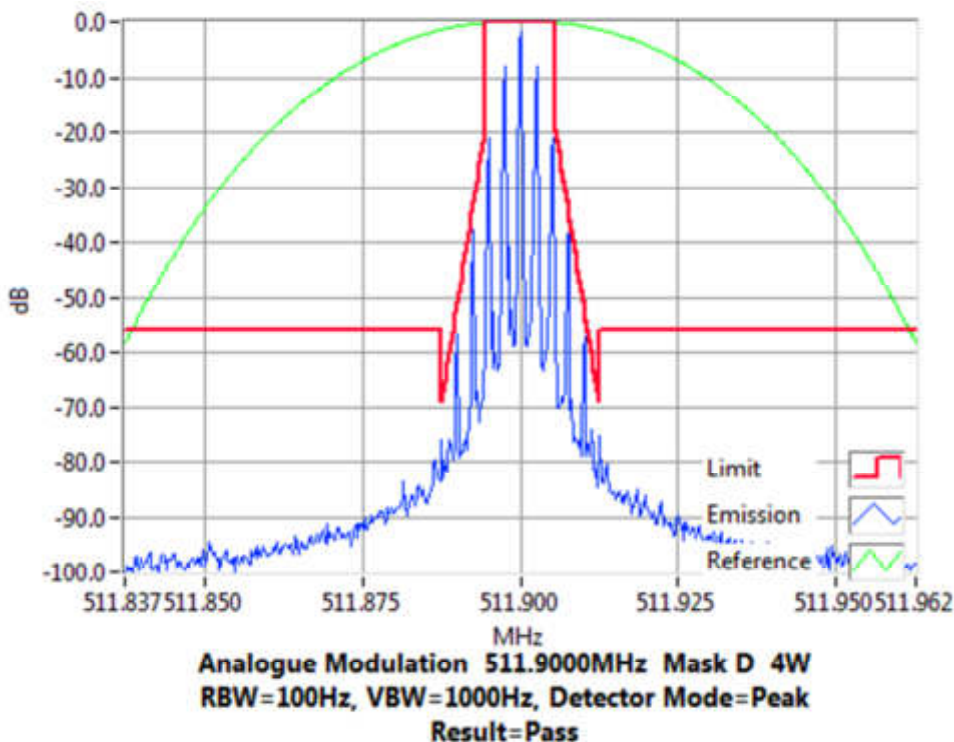

Tx FREQUENCY: 511.9 MHz 1 W 12.5 kHz Channel Spacing

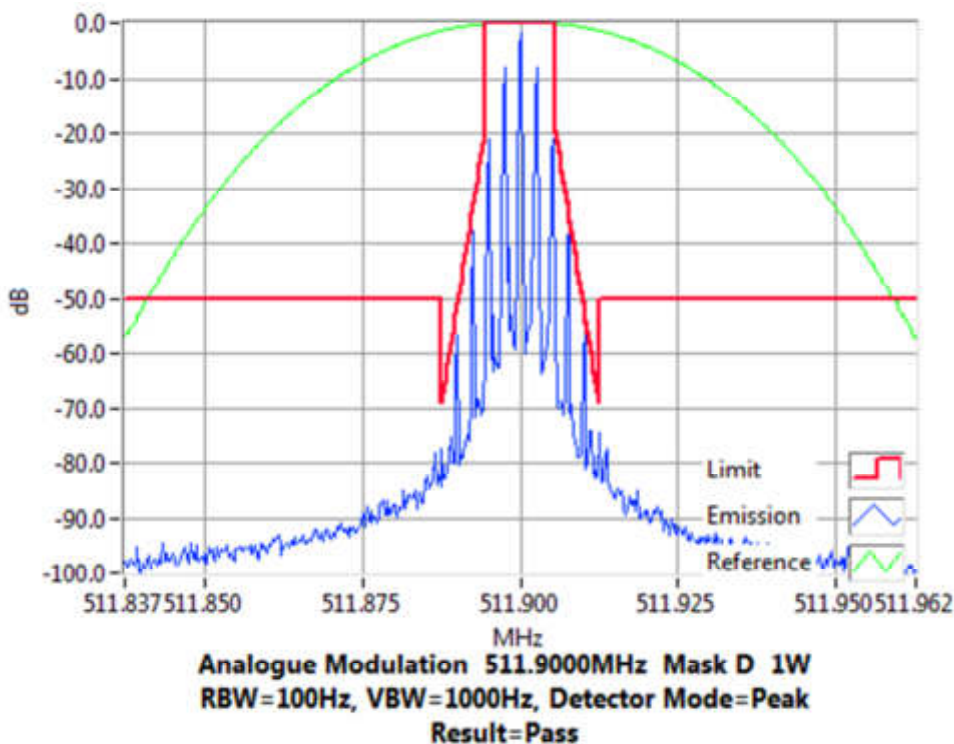

### Occupied Bandwidth and Spectrum Masks

FSK 1200 bps

Tx FREQUENCY: 450.125 MHz 4 W 12.5 kHz Channel Spacing

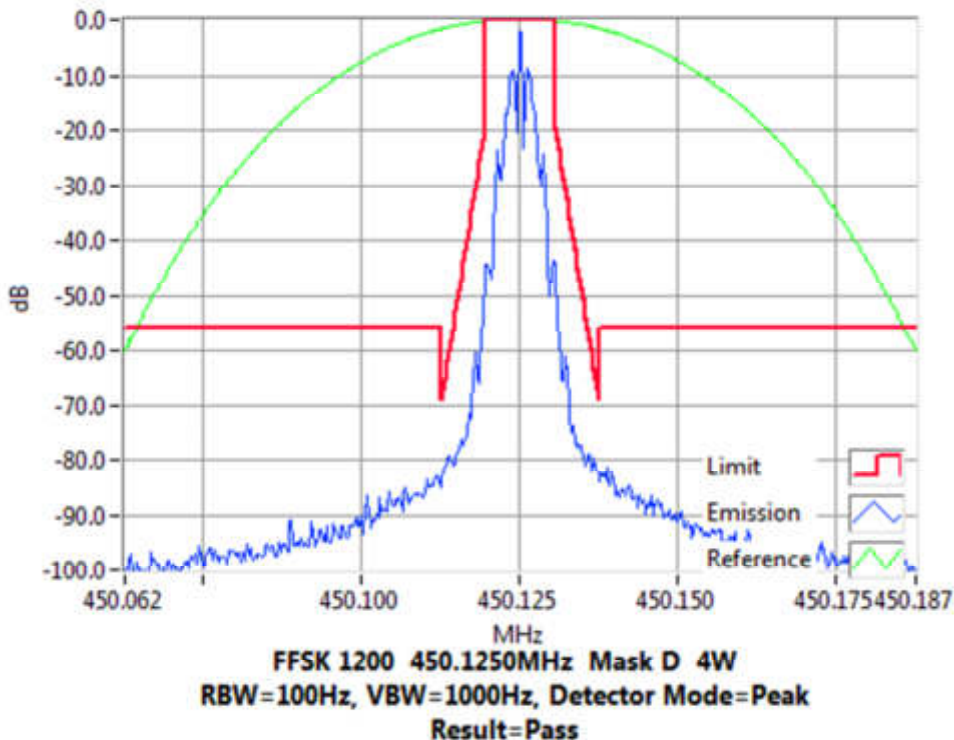

Tx FREQUENCY: 450.125 MHz 1 W 12.5 kHz Channel Spacing

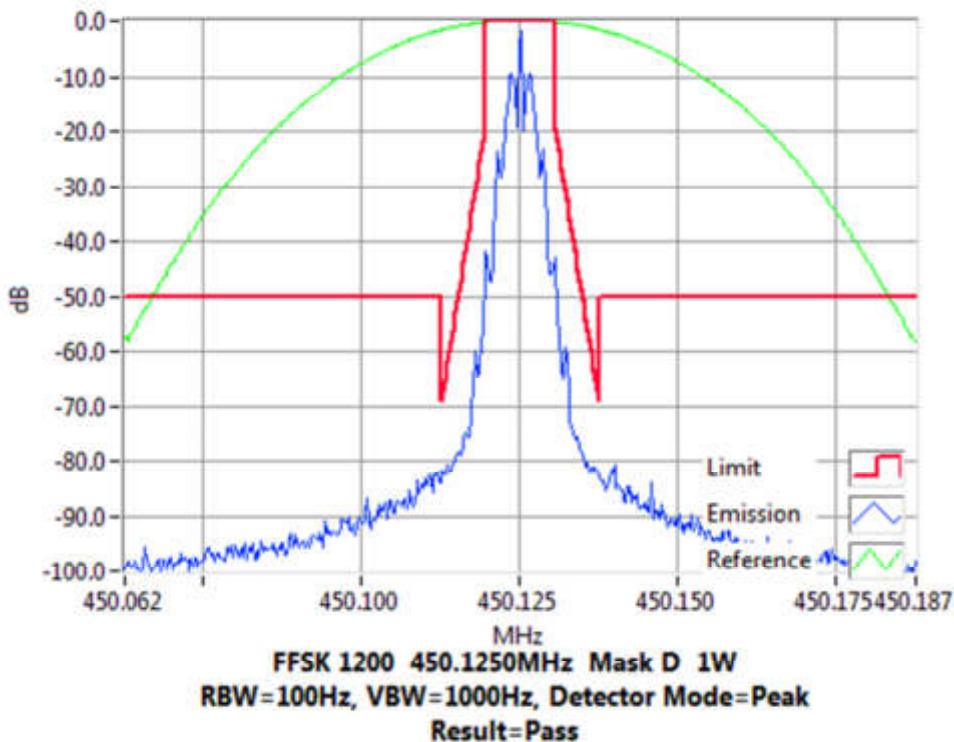

### Occupied Bandwidth and Spectrum Masks

FSK 1200 bps

Tx FREQUENCY: 454.5 MHz 4 W 12.5 kHz Channel Spacing

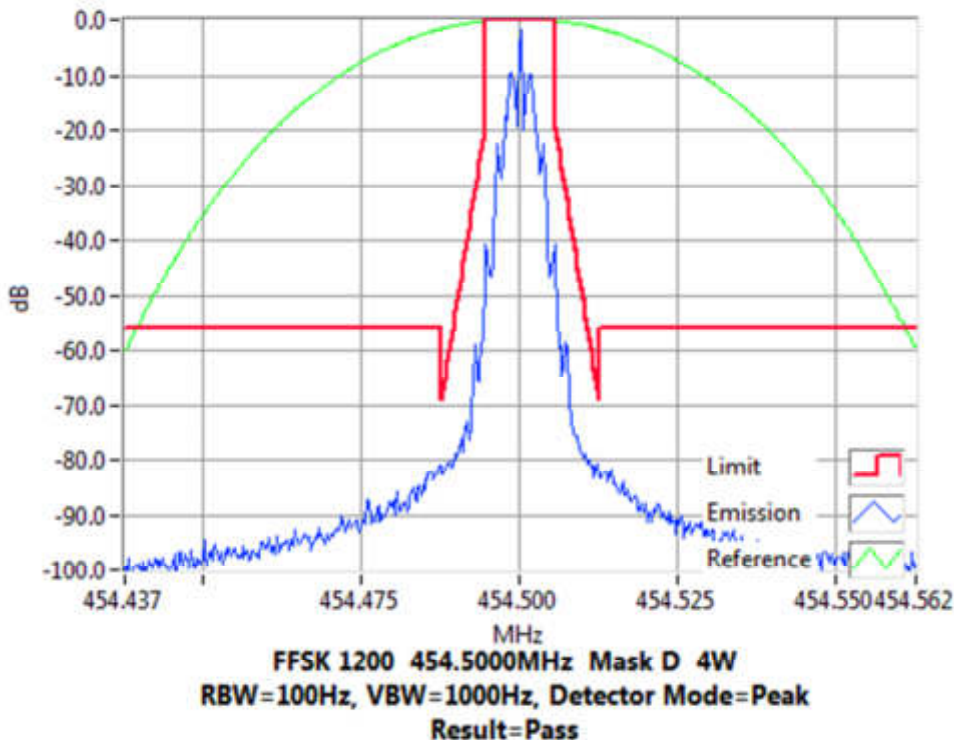

Tx FREQUENCY: 454.5 MHz 1 W 12.5 kHz Channel Spacing

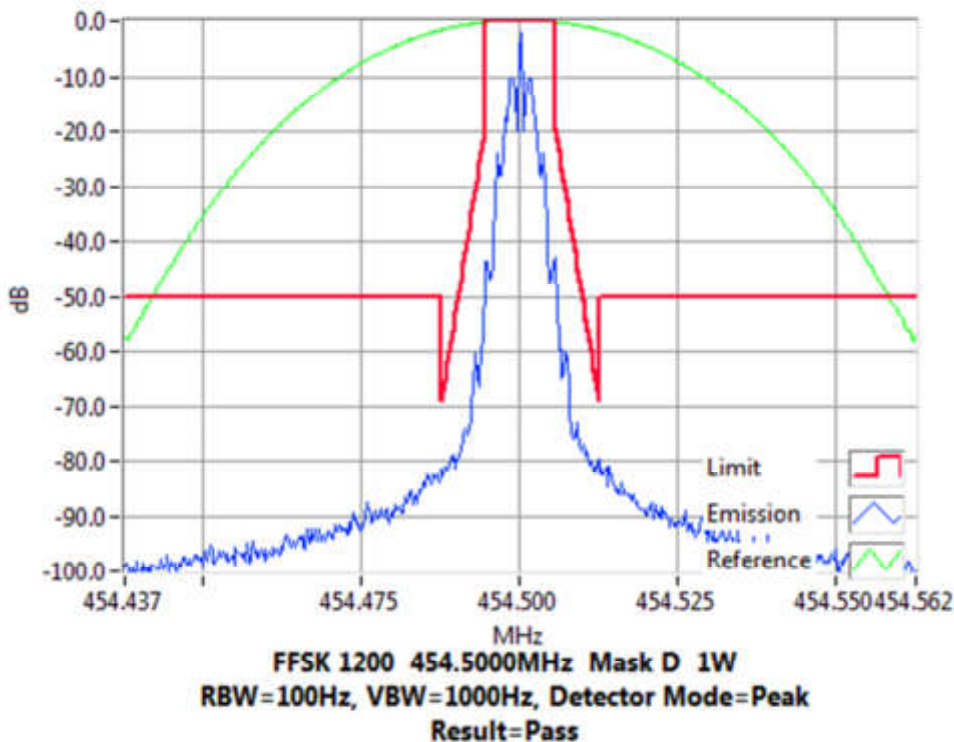

### Occupied Bandwidth and Spectrum Masks

FSK 1200 bps

Tx FREQUENCY: 459.9 MHz 4 W 12.5 kHz Channel Spacing

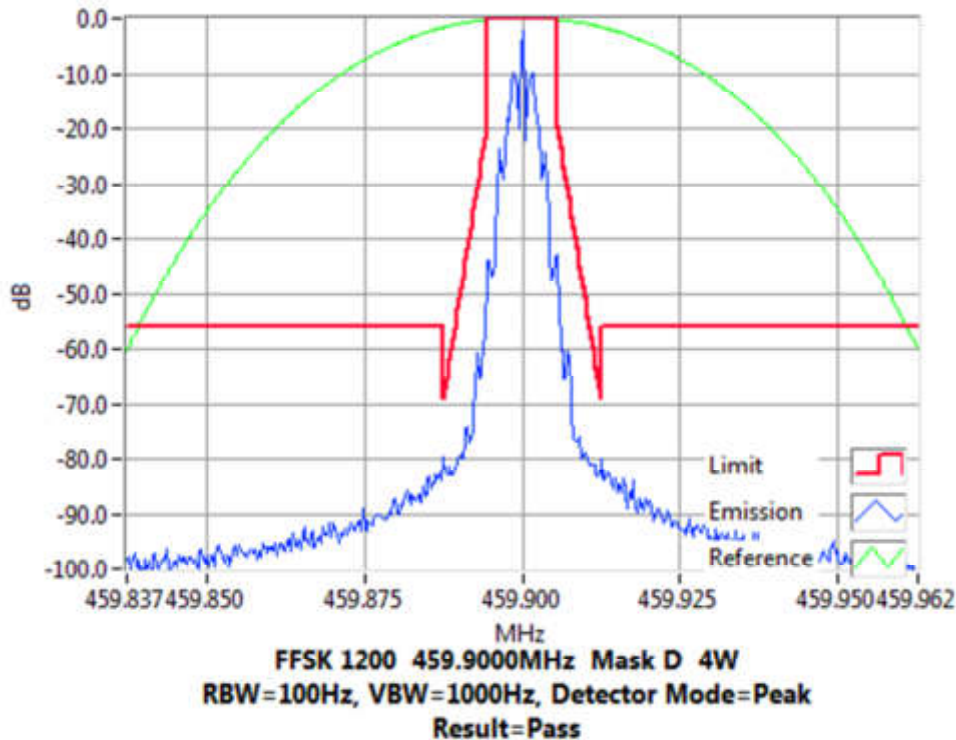

Tx FREQUENCY: 459.9 MHz 1 W 12.5 kHz Channel Spacing

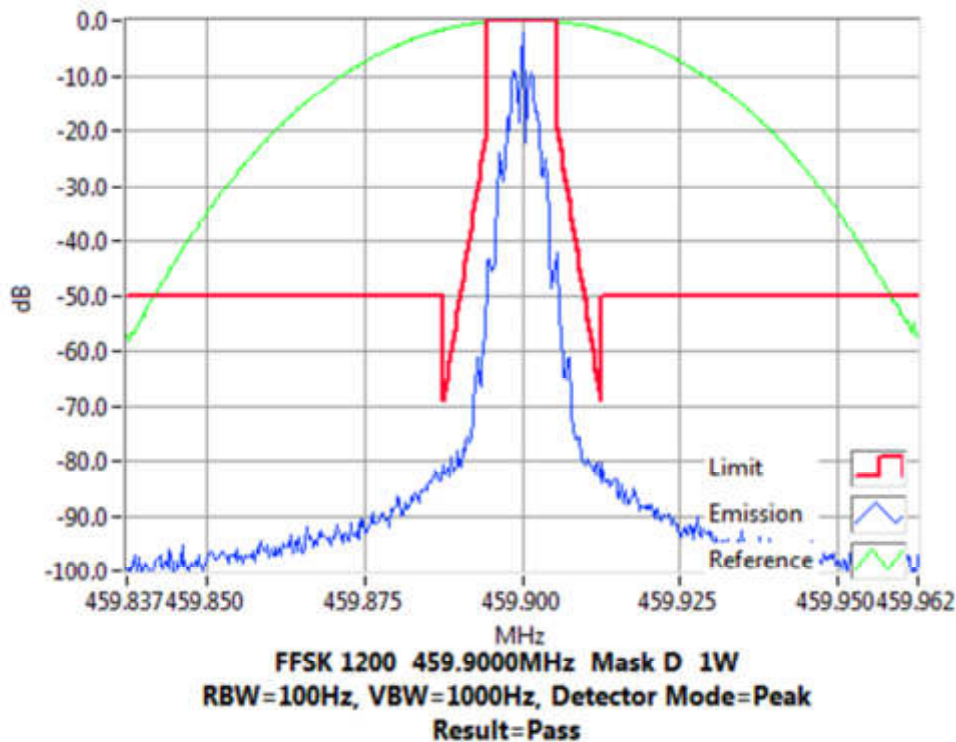

### Occupied Bandwidth and Spectrum Masks

FSK 1200 bps

Tx FREQUENCY: 465.1 MHz 4 W 12.5 kHz Channel Spacing

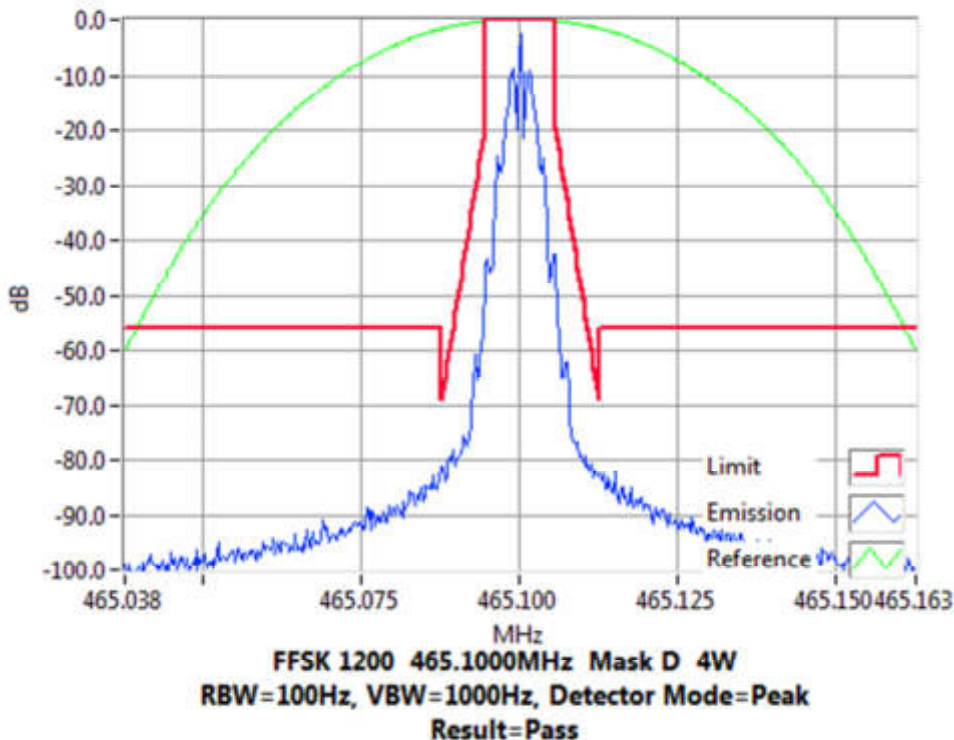

Tx FREQUENCY: 465.1 MHz 1 W 12.5 kHz Channel Spacing

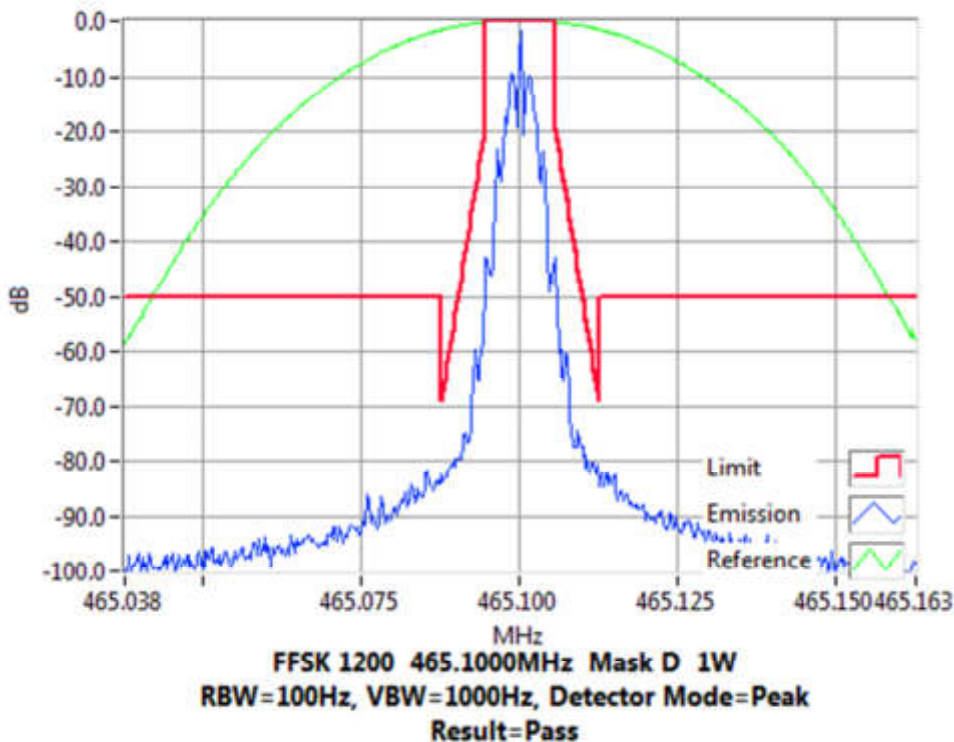

### Occupied Bandwidth and Spectrum Masks

FSK 1200 bps

Tx FREQUENCY: 469.9 MHz 4 W 12.5 kHz Channel Spacing

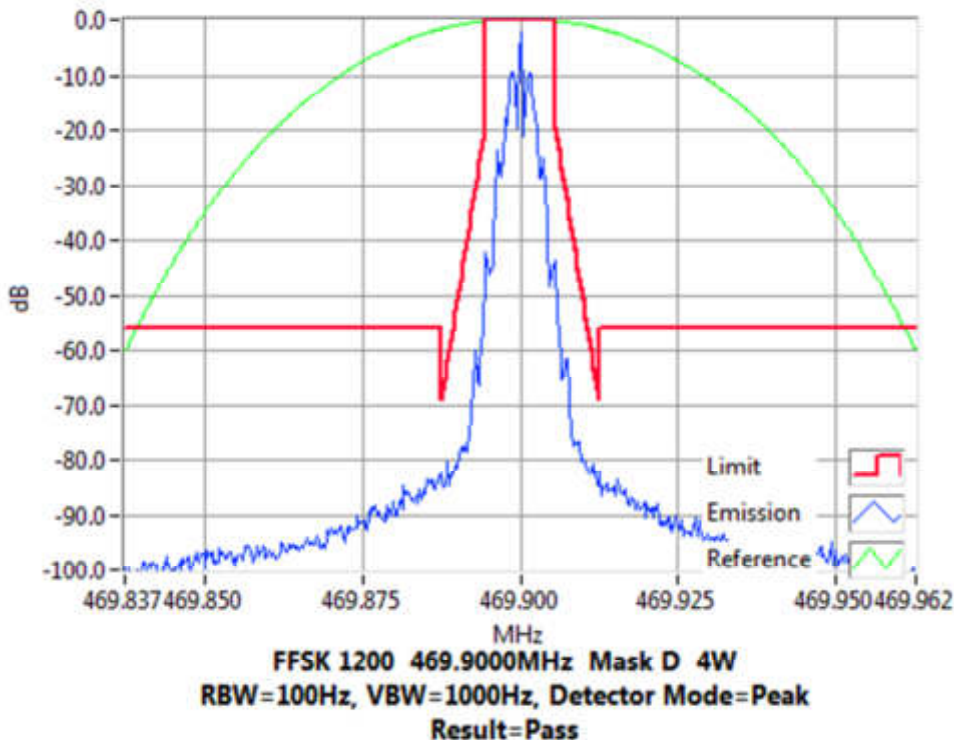

Tx FREQUENCY: 469.9 MHz 1 W 12.5 kHz Channel Spacing

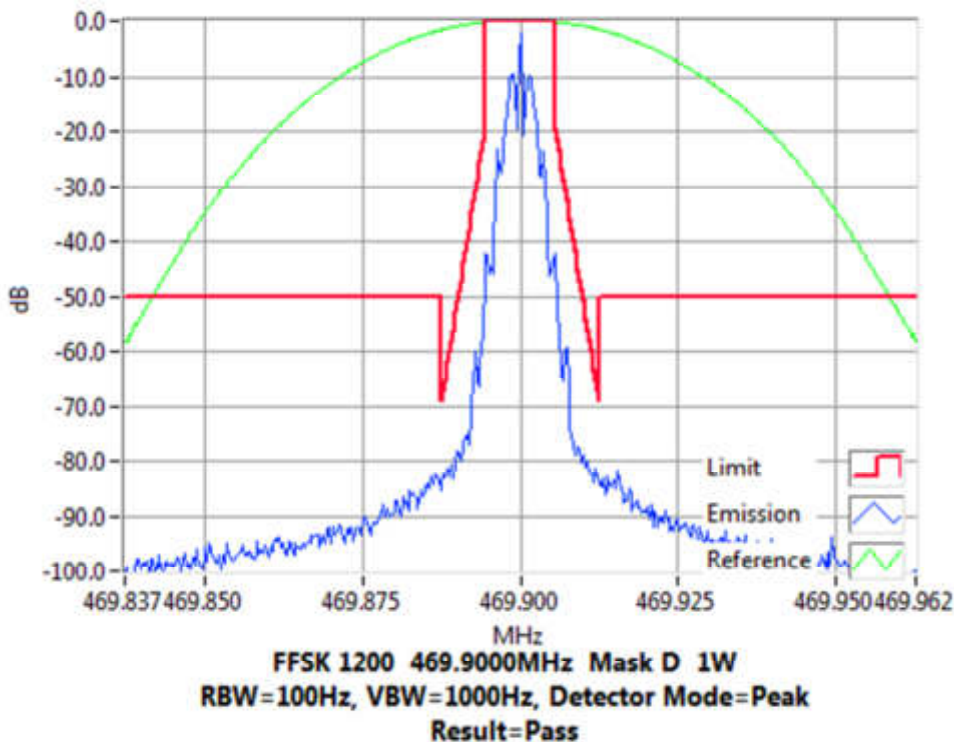



### Occupied Bandwidth and Spectrum Masks

FSK 1200 bps

Tx FREQUENCY: 511.9 MHz 4 W 12.5 kHz Channel Spacing

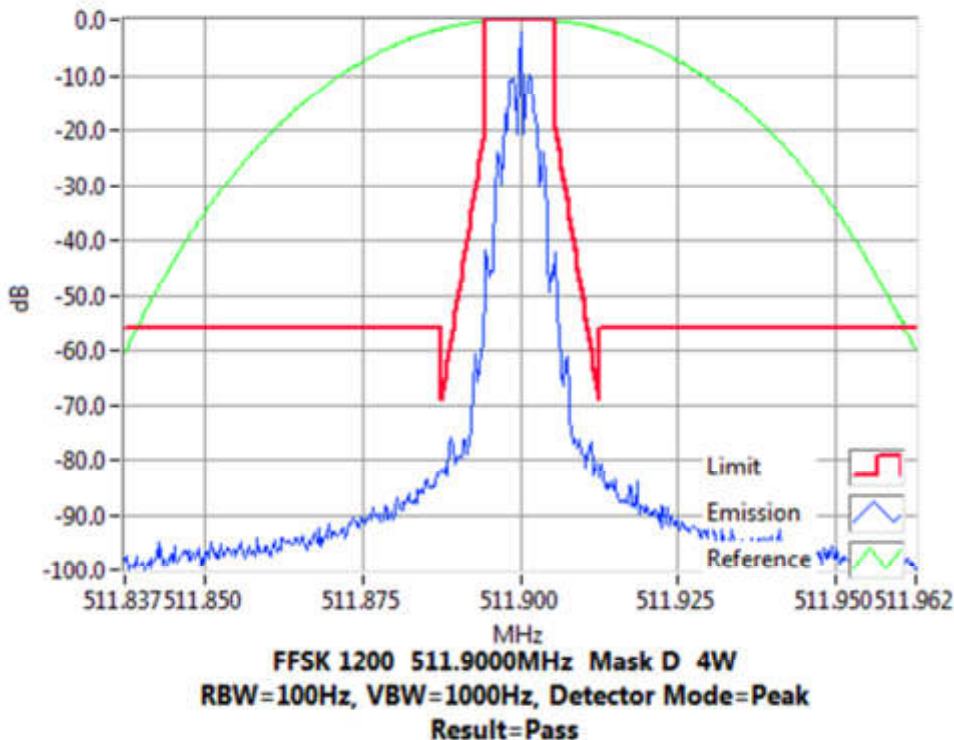

Tx FREQUENCY: 511.9 MHz 1 W 12.5 kHz Channel Spacing

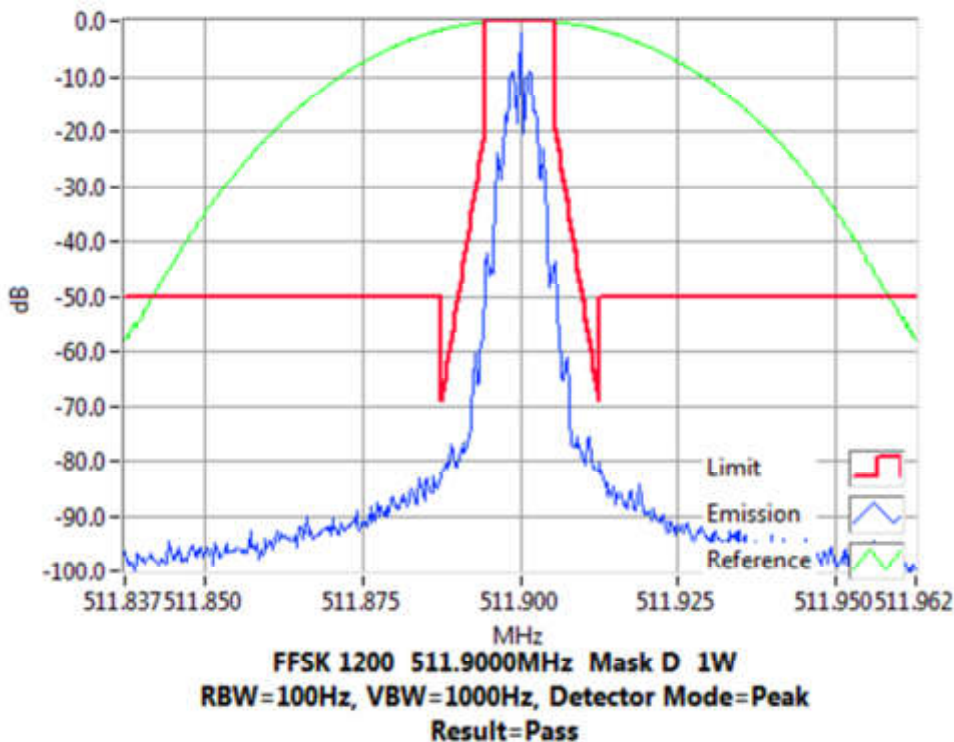

### Occupied Bandwidth and Spectrum Masks

FFSK 2400 bps

Tx FREQUENCY: 450.125 MHz 4 W 12.5 kHz Channel Spacing

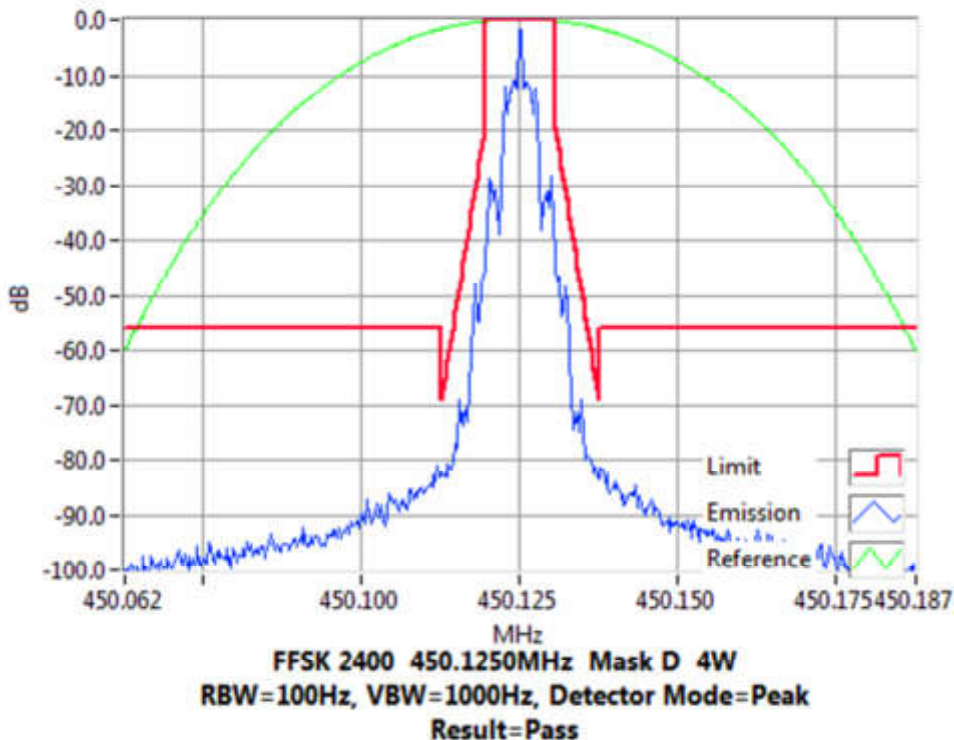

Tx FREQUENCY: 450.125 MHz 1 W 12.5 kHz Channel Spacing

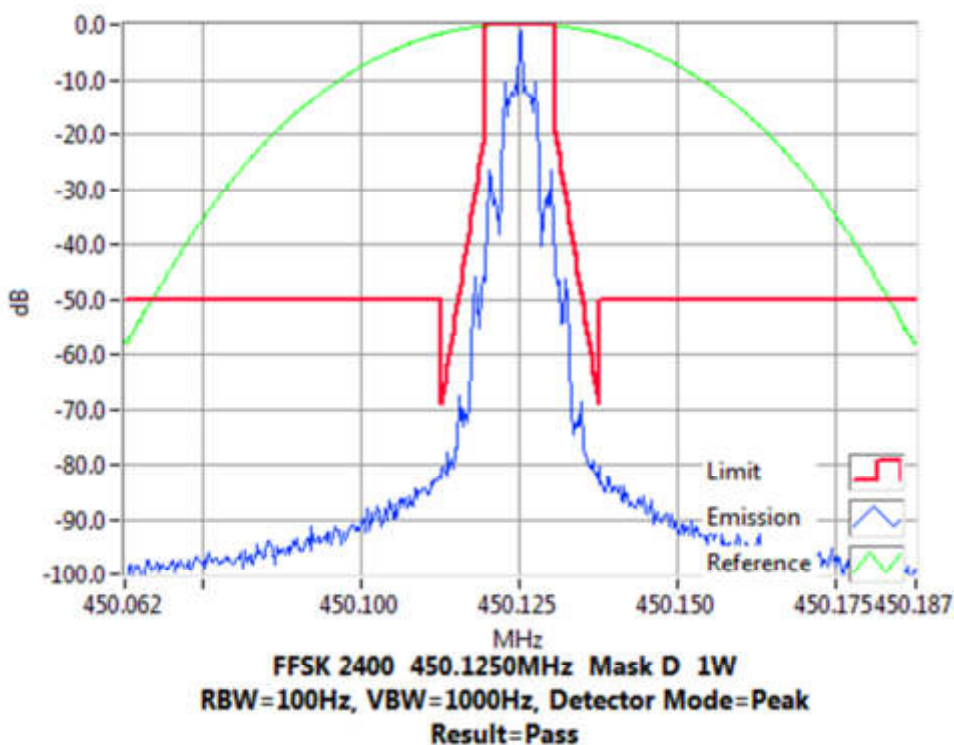

### Occupied Bandwidth and Spectrum Masks

FSK 2400 bps

Tx FREQUENCY: 454.5 MHz 4 W 12.5 kHz Channel Spacing

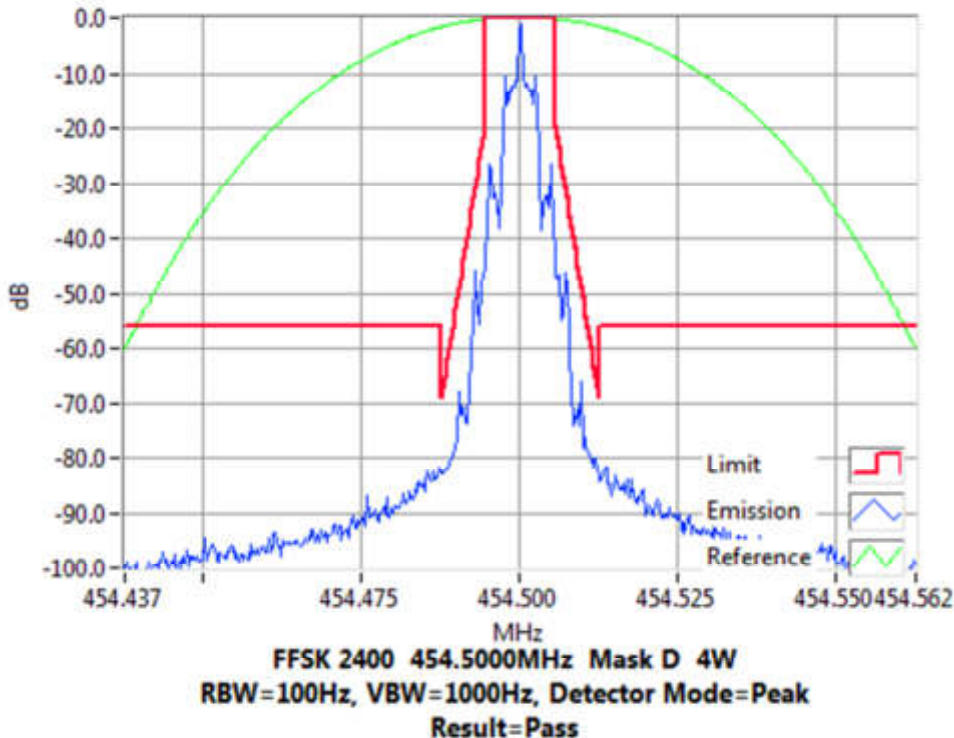

Tx FREQUENCY: 454.5 MHz 1 W 12.5 kHz Channel Spacing

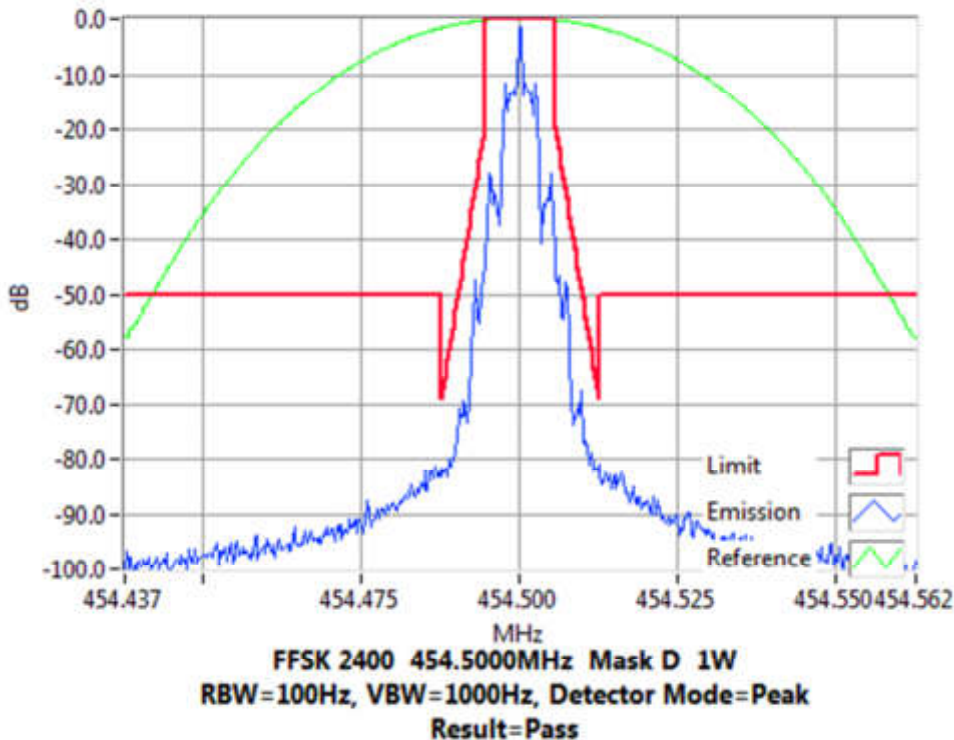

### Occupied Bandwidth and Spectrum Masks

FSK 2400 bps

Tx FREQUENCY: 459.9 MHz 4 W 12.5 kHz Channel Spacing

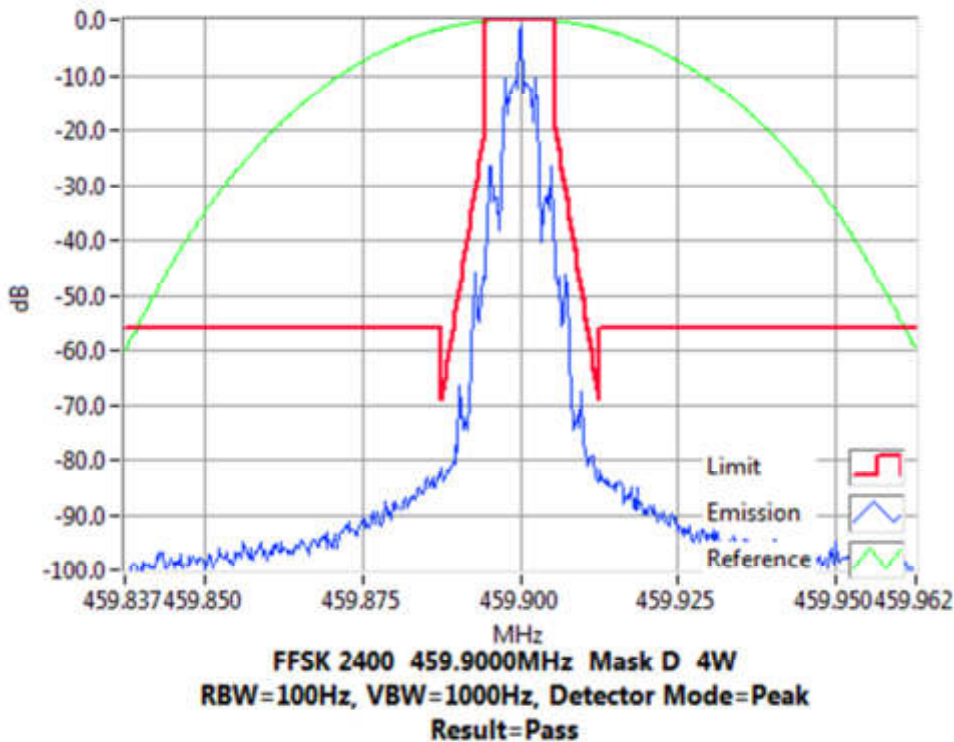

Tx FREQUENCY: 459.9 MHz 1 W 12.5 kHz Channel Spacing

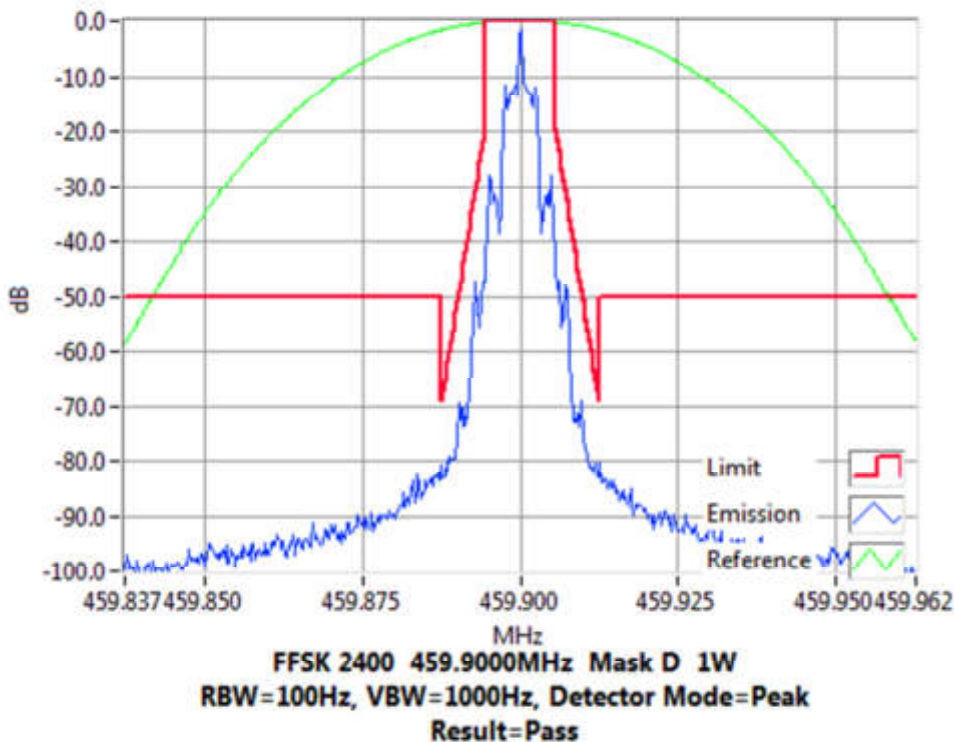

### Occupied Bandwidth and Spectrum Masks

FSK 2400 bps

Tx FREQUENCY: 465.1 MHz 4 W 12.5 kHz Channel Spacing

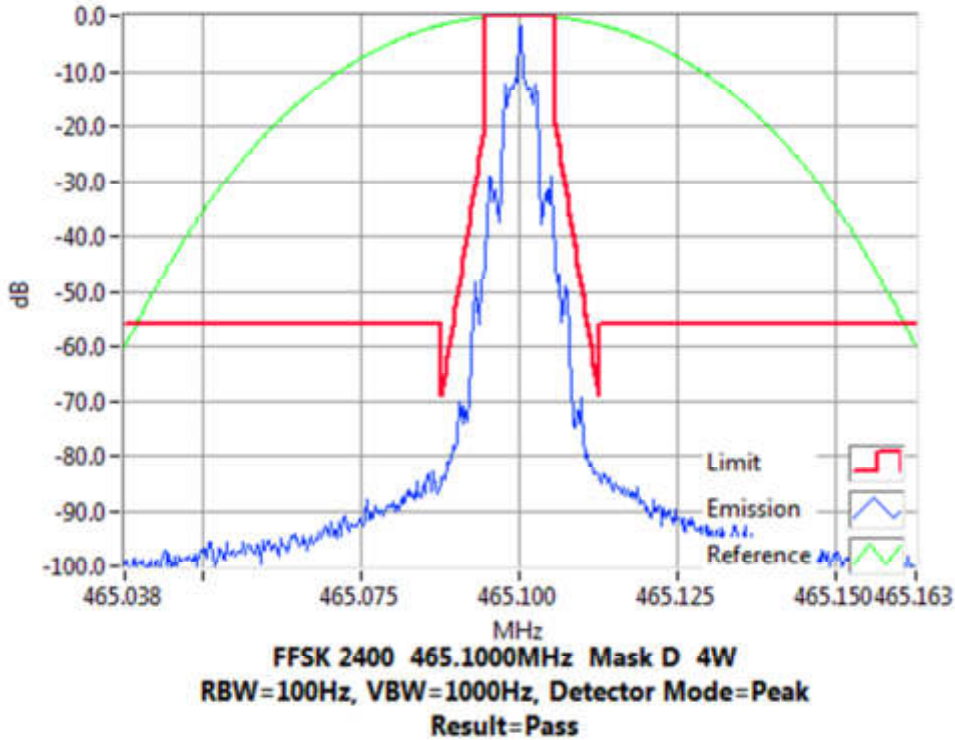

Tx FREQUENCY: 465.1 MHz 1 W 12.5 kHz Channel Spacing

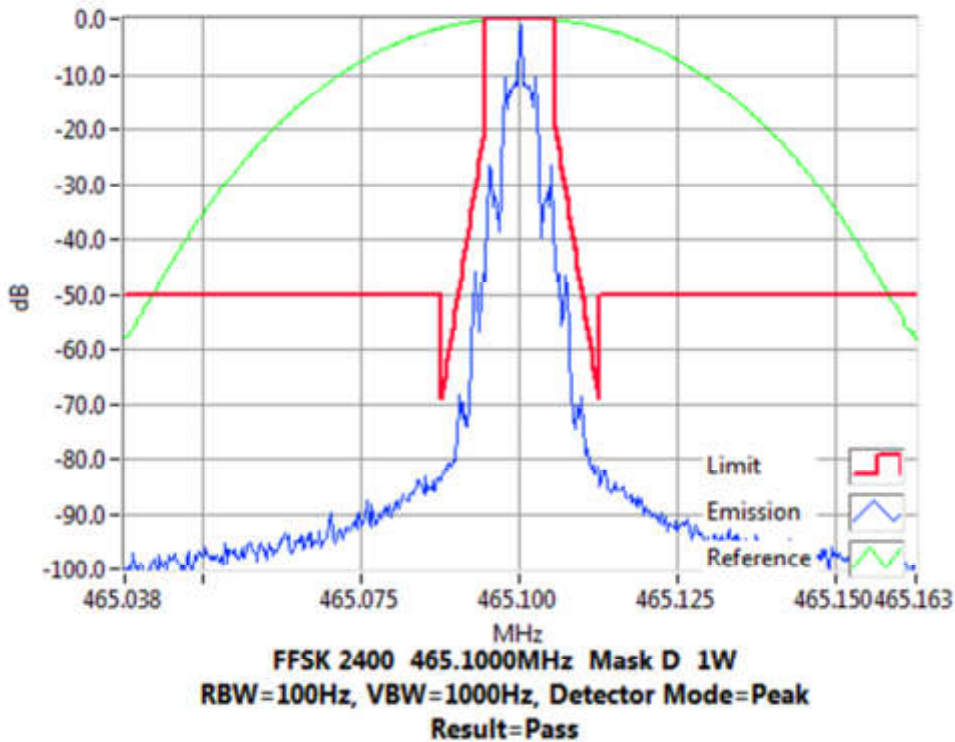

### Occupied Bandwidth and Spectrum Masks

FSK 2400 bps

Tx FREQUENCY: 469.9 MHz 4 W 12.5 kHz Channel Spacing

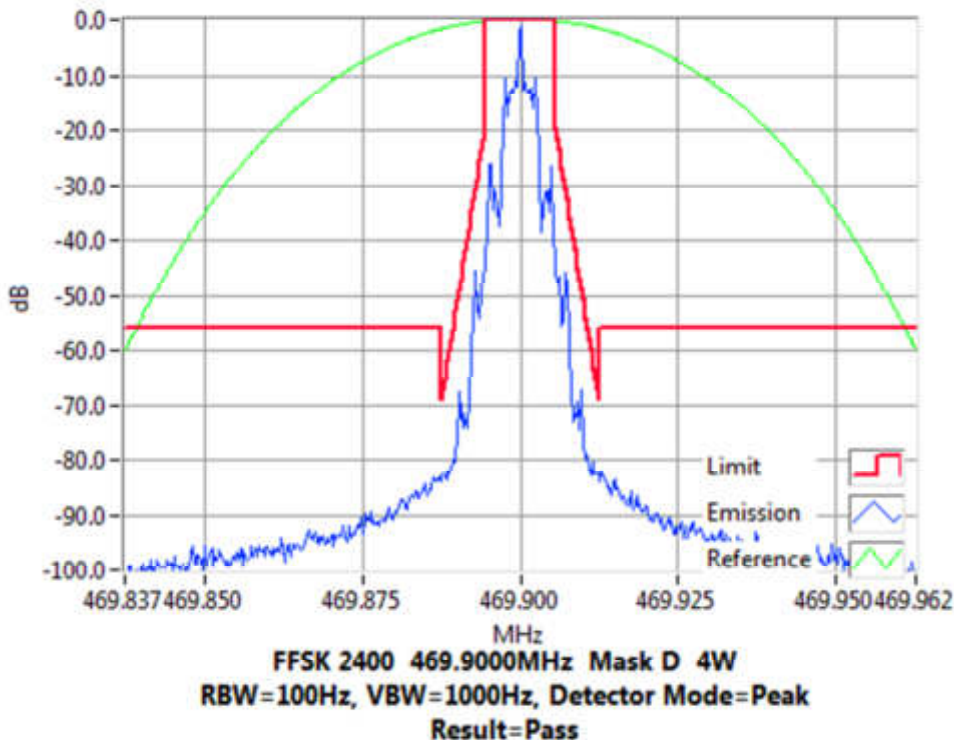

Tx FREQUENCY: 469.9 MHz 1 W 12.5 kHz Channel Spacing

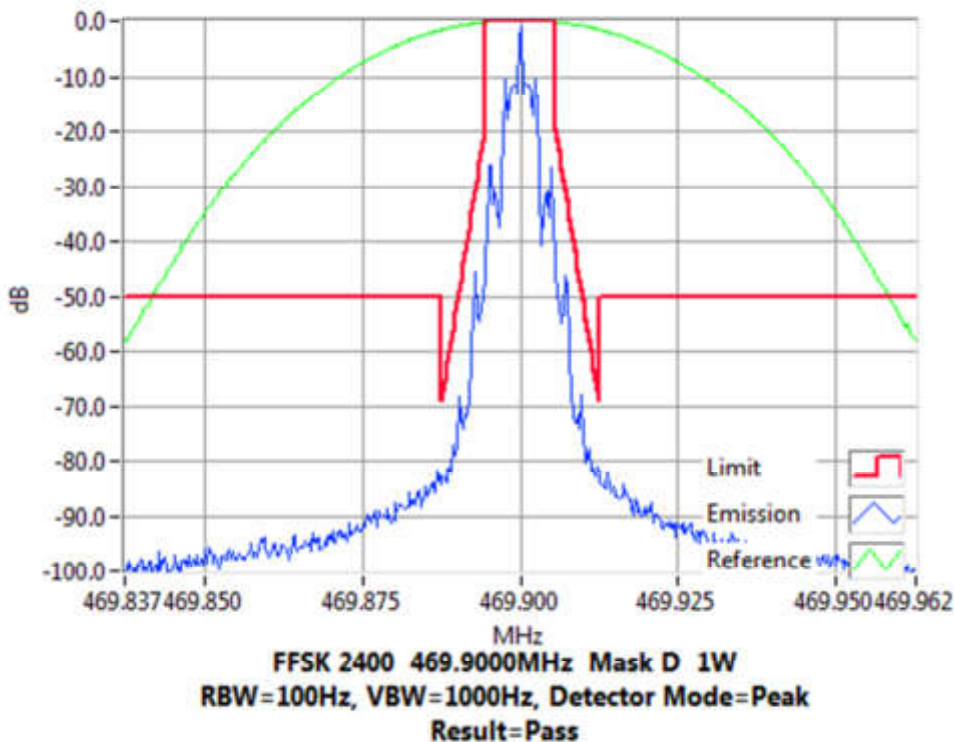

### Occupied Bandwidth and Spectrum Masks

FSK 2400 bps

Tx FREQUENCY: 511.9 MHz 4 W 12.5 kHz Channel Spacing

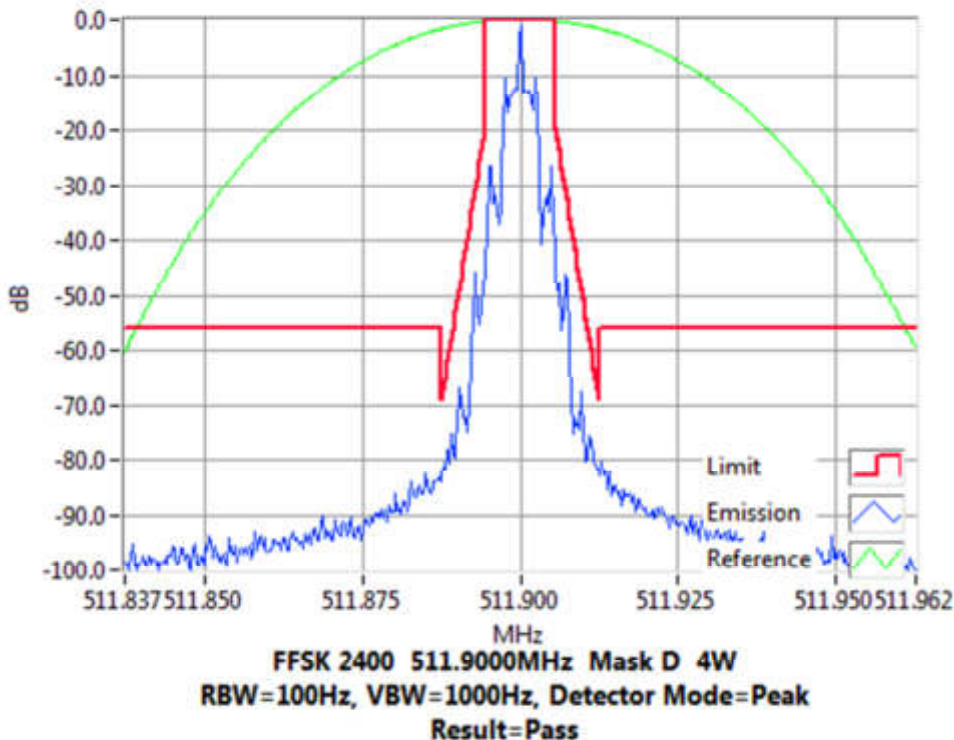

Tx FREQUENCY: 511.9 MHz 1 W 12.5 kHz Channel Spacing

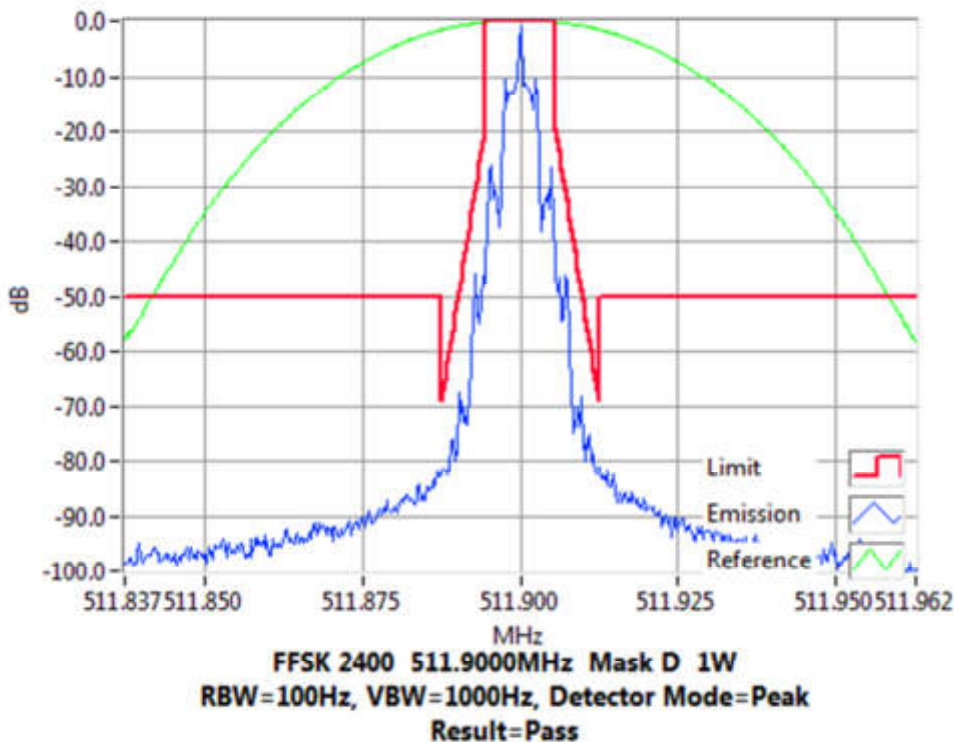

### Occupied Bandwidth and Spectrum Masks

DMR

Tx FREQUENCY: 450.125 MHz 4 W 12.5 kHz Channel Spacing

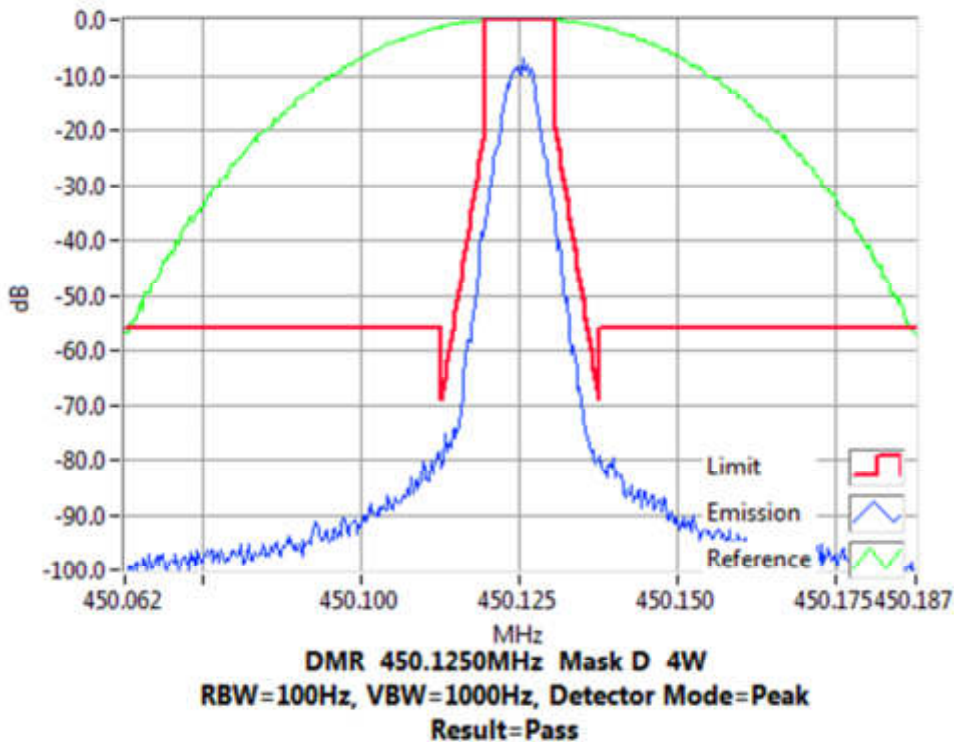

Tx FREQUENCY: 450.125 MHz 1 W 12.5 kHz Channel Spacing

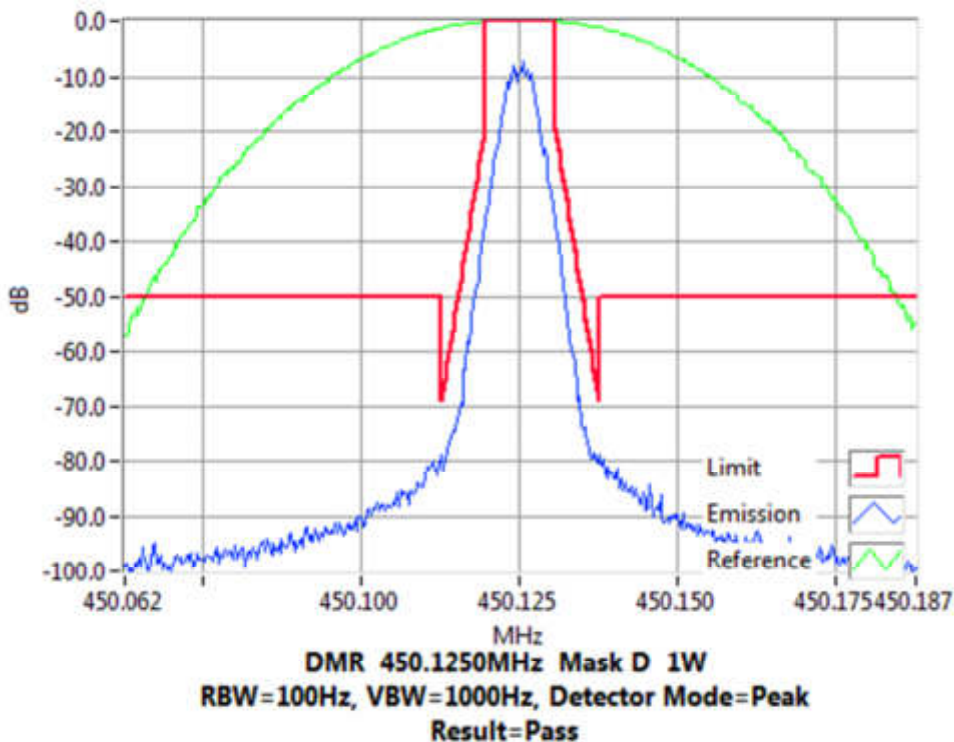



### Occupied Bandwidth and Spectrum Masks

DMR

Tx FREQUENCY: 454.5 MHz 4 W 12.5 kHz Channel Spacing

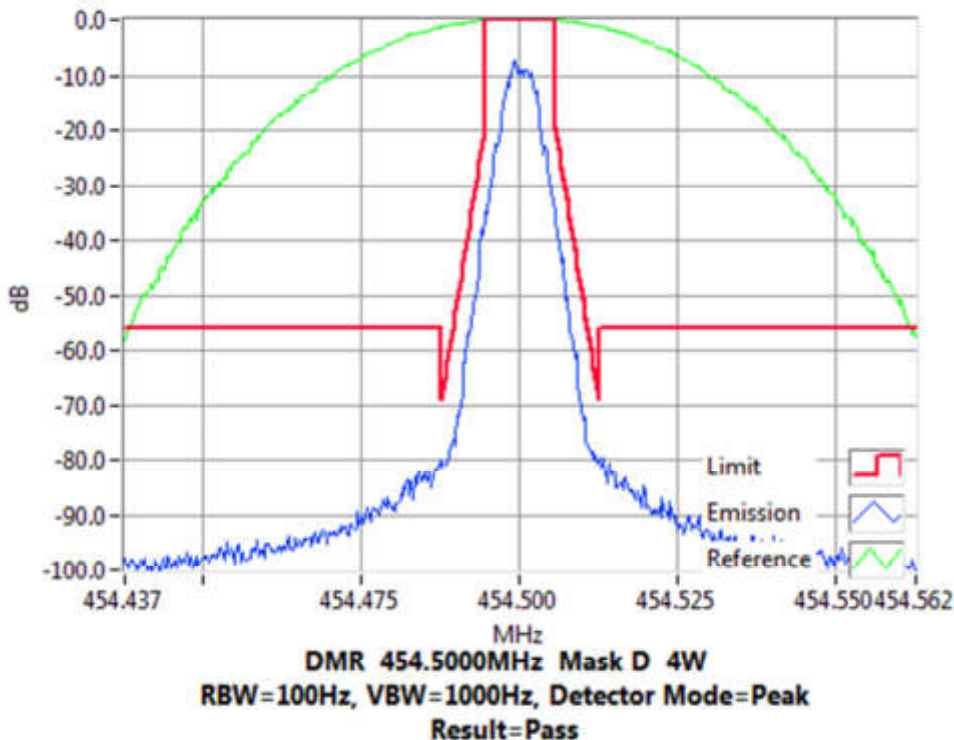

Tx FREQUENCY: 454.5 MHz 1 W 12.5 kHz Channel Spacing

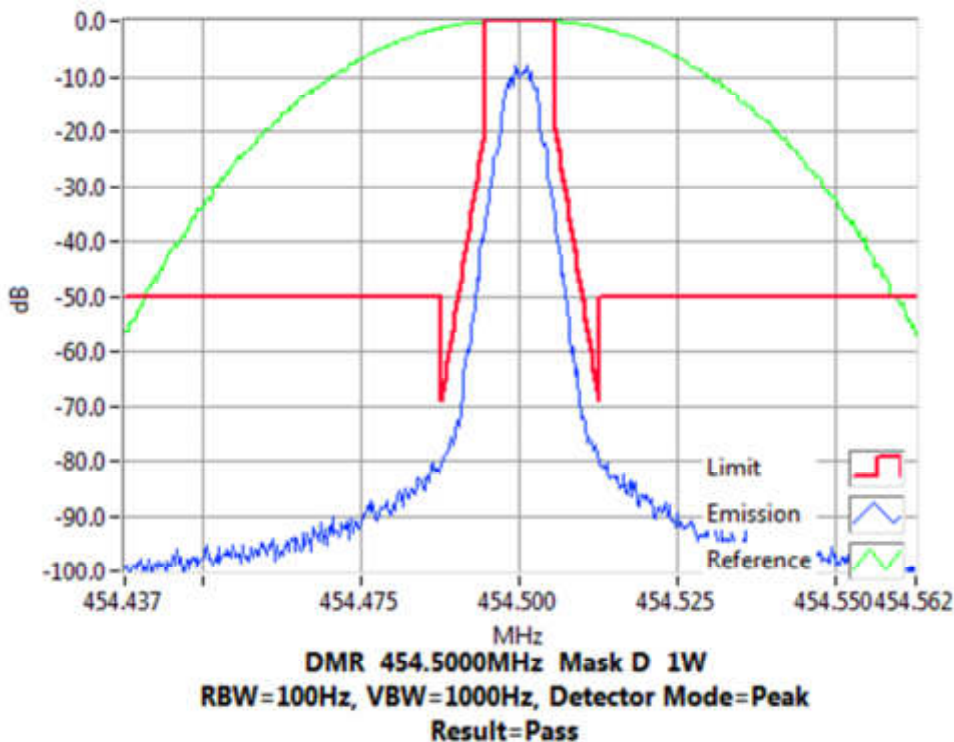

### Occupied Bandwidth and Spectrum Masks

DMR

Tx FREQUENCY: 459.9 MHz 4 W 12.5 kHz Channel Spacing

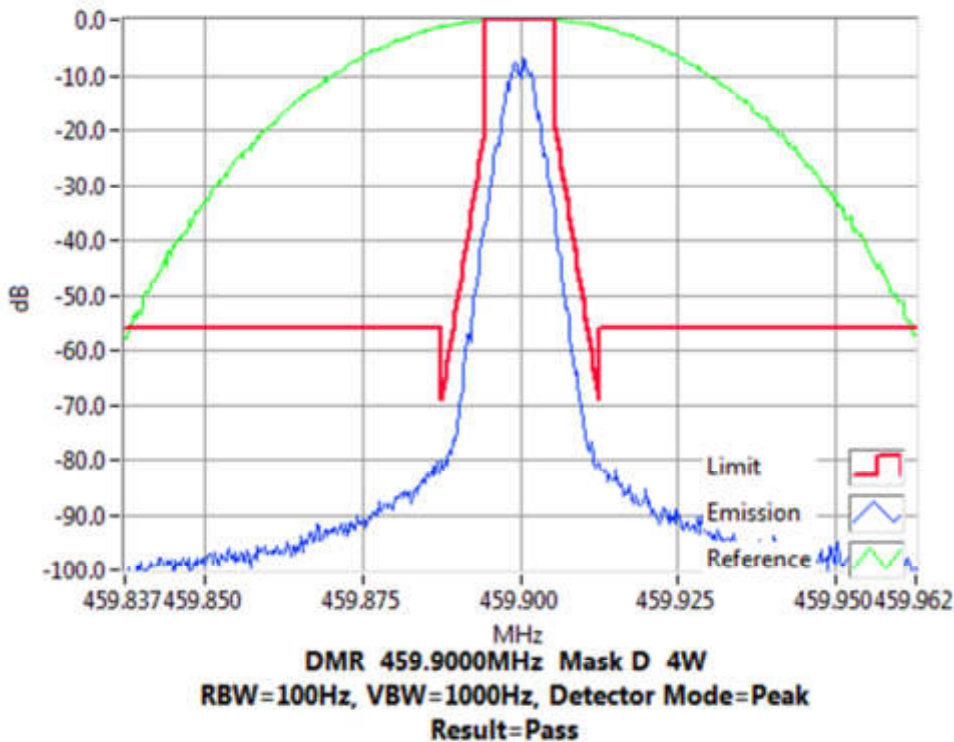

Tx FREQUENCY: 459.9 MHz 1 W 12.5 kHz Channel Spacing

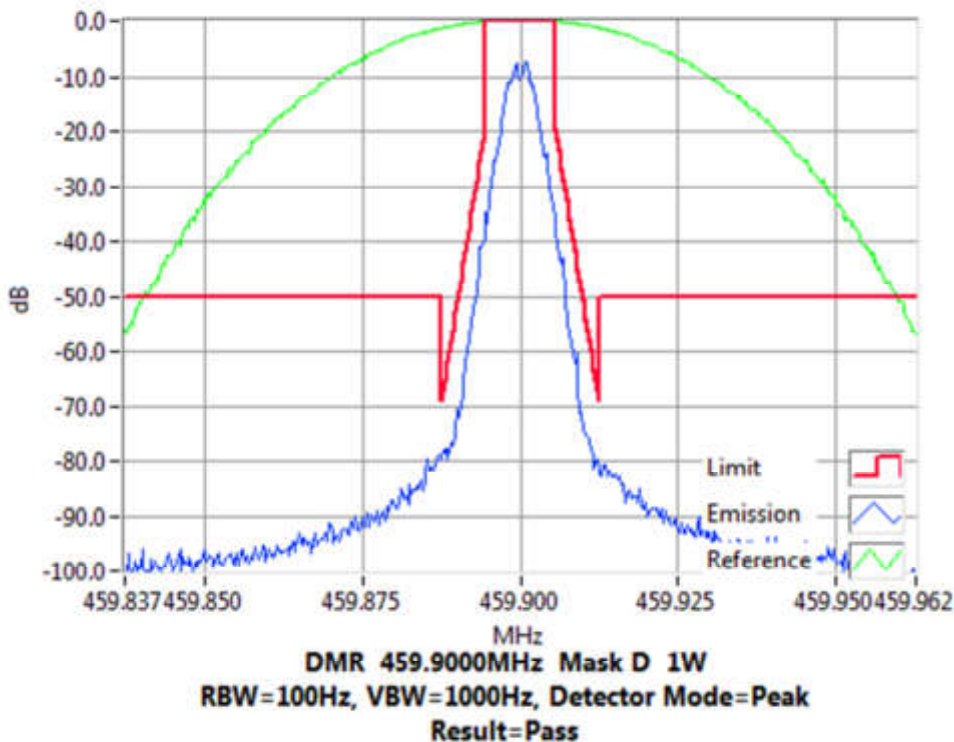

### Occupied Bandwidth and Spectrum Masks

DMR

Tx FREQUENCY: 465.1 MHz 4 W 12.5 kHz Channel Spacing

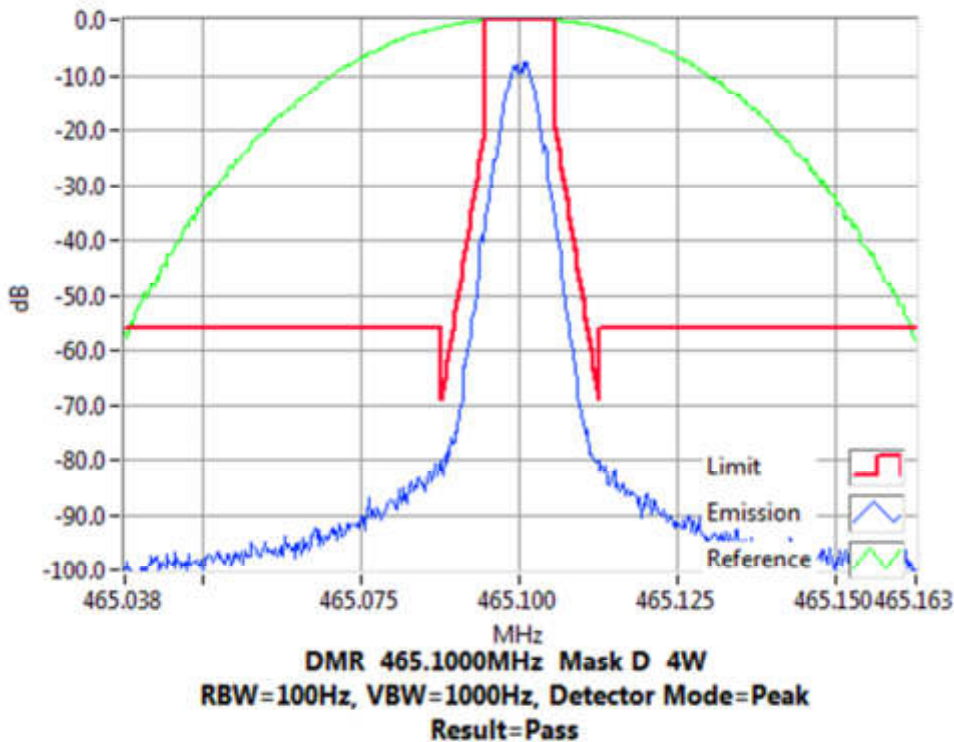

Tx FREQUENCY: 465.1 MHz 1 W 12.5 kHz Channel Spacing

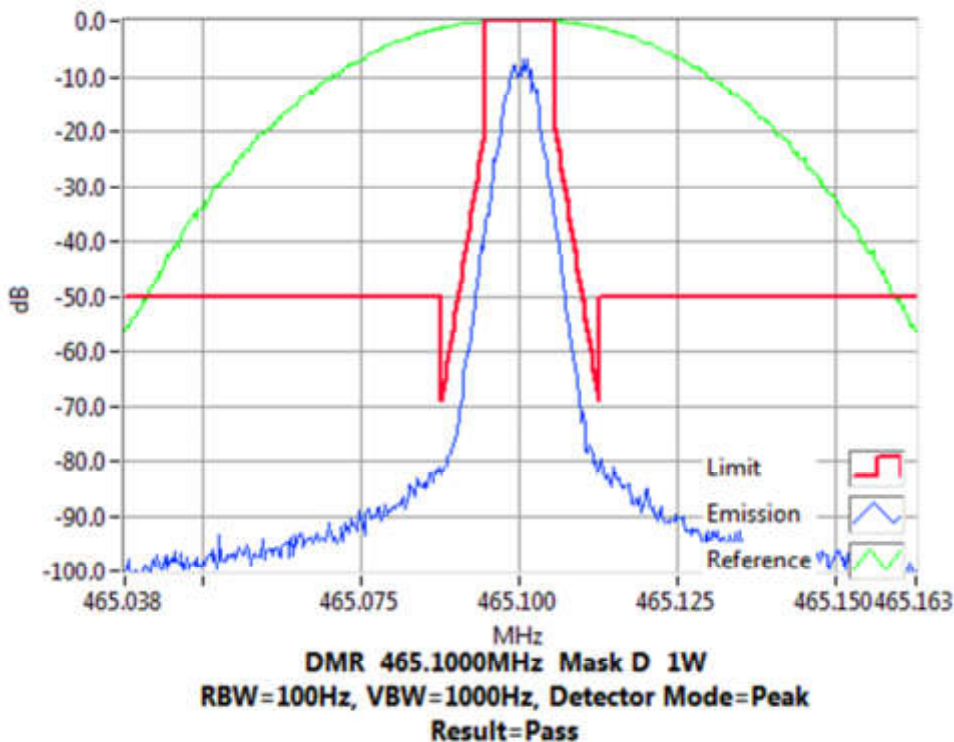

### Occupied Bandwidth and Spectrum Masks

DMR

Tx FREQUENCY: 469.9 MHz 4 W 12.5 kHz Channel Spacing

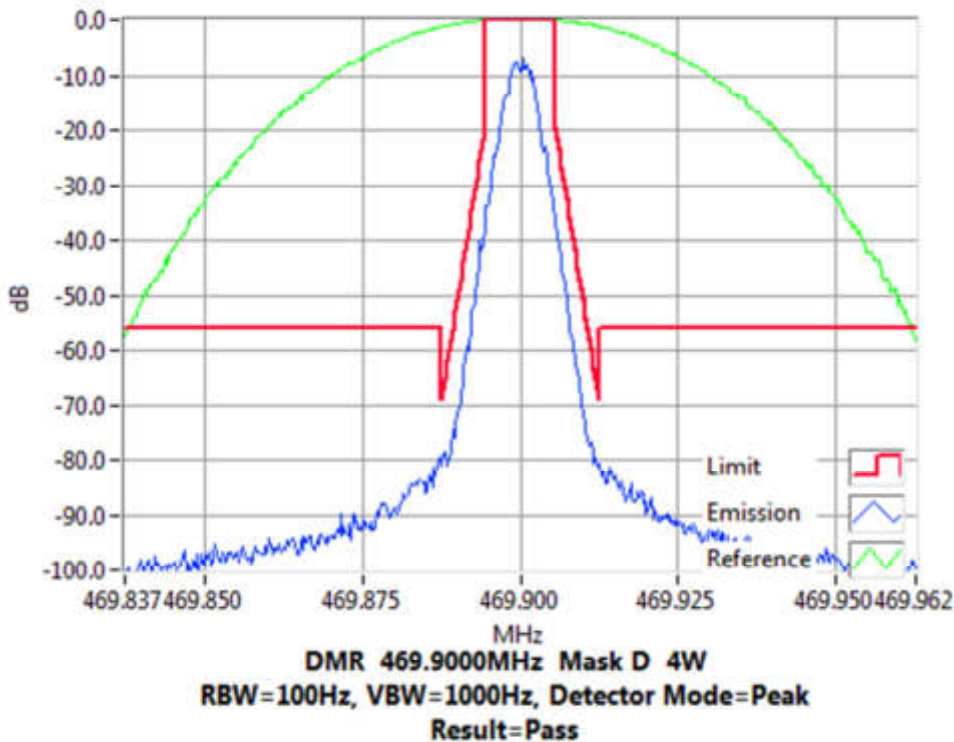

Tx FREQUENCY: 469.9 MHz 1 W 12.5 kHz Channel Spacing

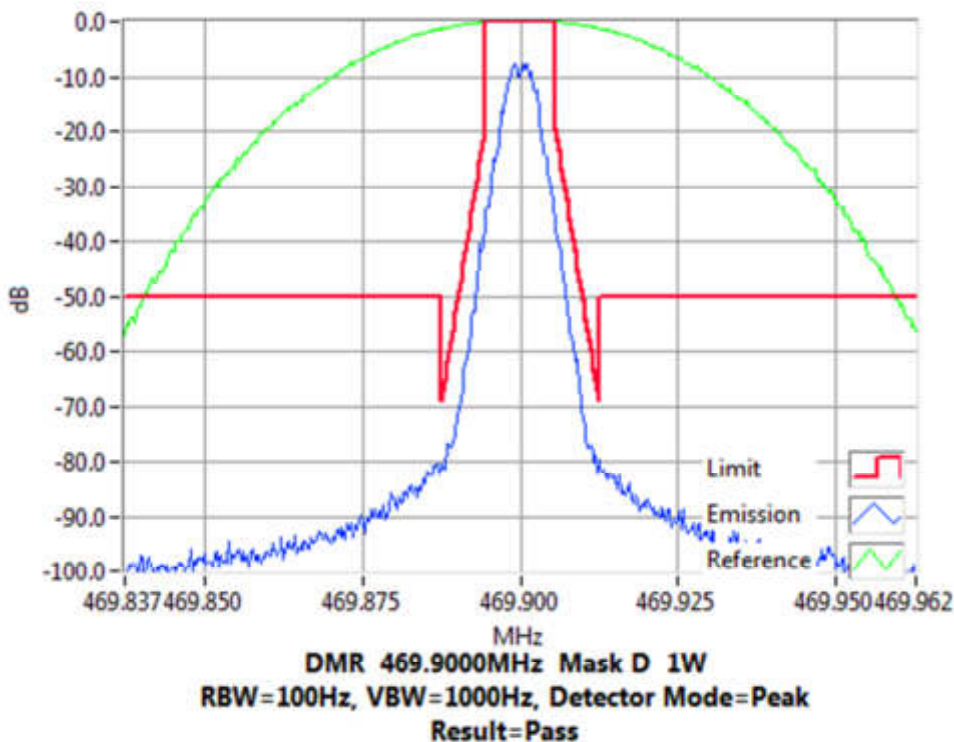

### Occupied Bandwidth and Spectrum Masks

DMR

Tx FREQUENCY: 511.9 MHz 4 W 12.5 kHz Channel Spacing

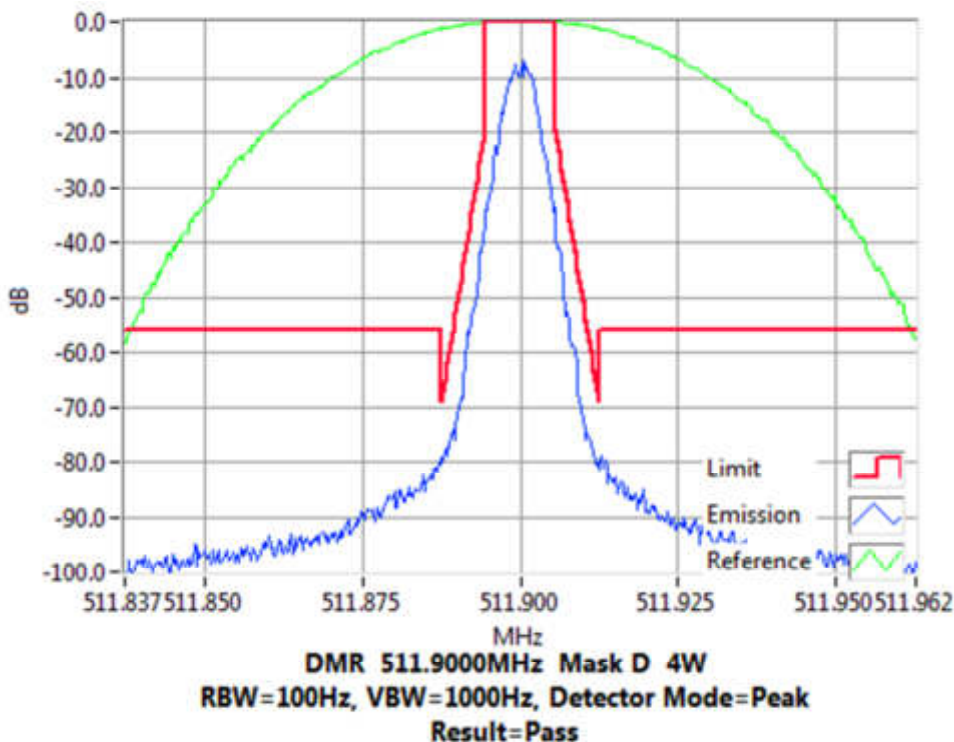

Tx FREQUENCY: 511.9 MHz 1 W 12.5 kHz Channel Spacing

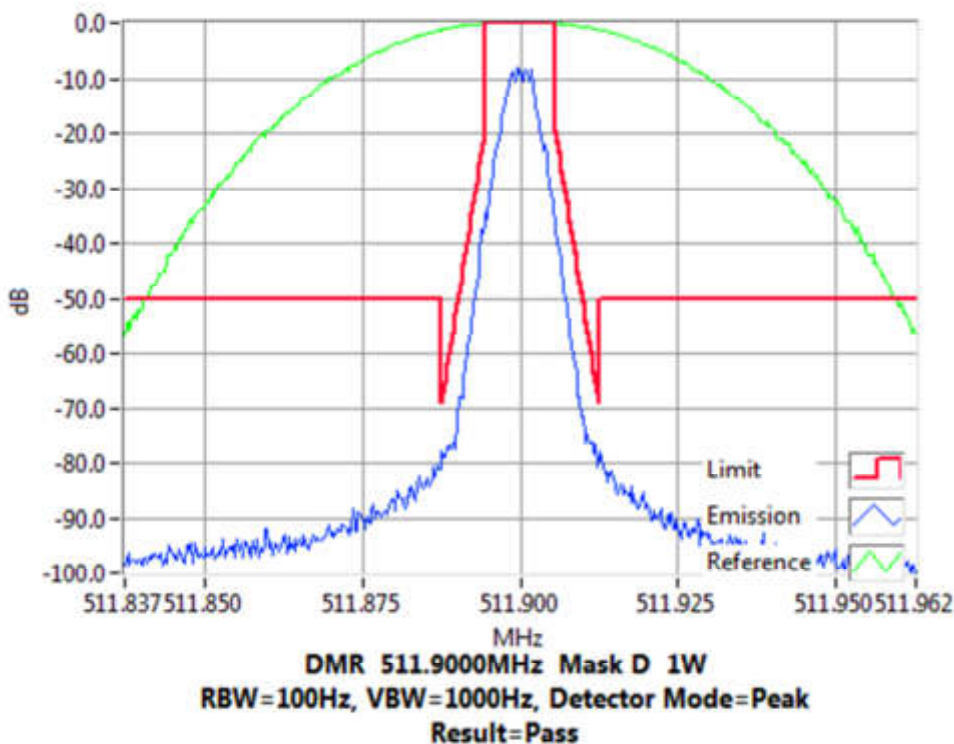

### Occupied Bandwidth and Spectrum Masks

APCO P25 phase-1

Tx FREQUENCY: 450.125 MHz 4 W 12.5 kHz Channel Spacing

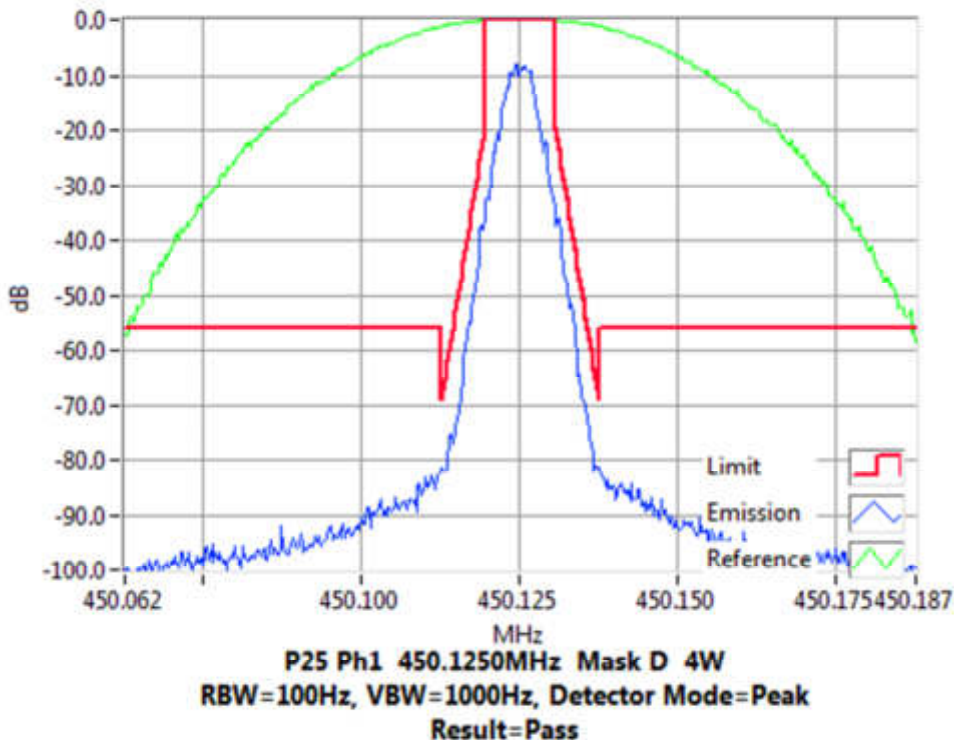

Tx FREQUENCY: 450.125 MHz 1 W 12.5 kHz Channel Spacing

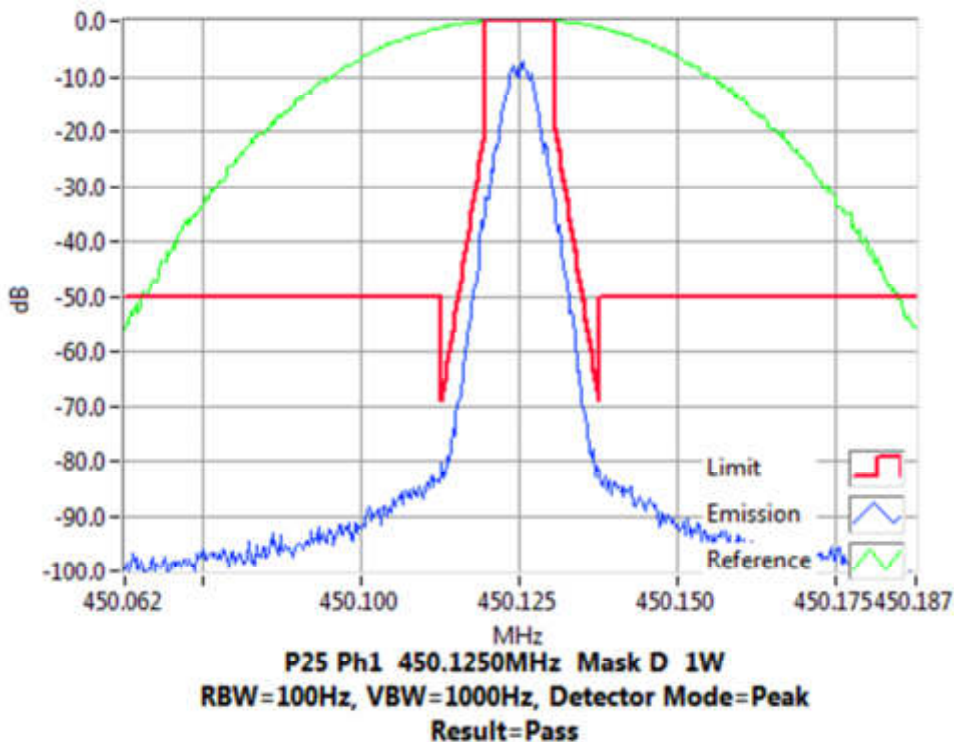

### Occupied Bandwidth and Spectrum Masks

APCO P25 phase-1

Tx FREQUENCY: 454.5 MHz 4 W 12.5 kHz Channel Spacing

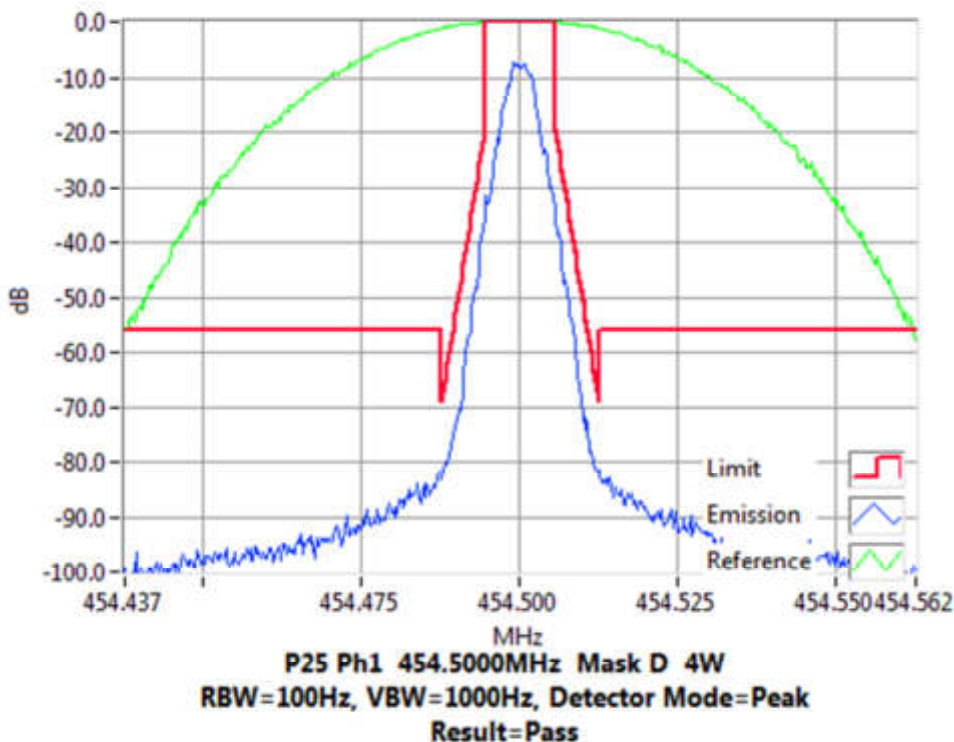

Tx FREQUENCY: 454.5 MHz 1 W 12.5 kHz Channel Spacing

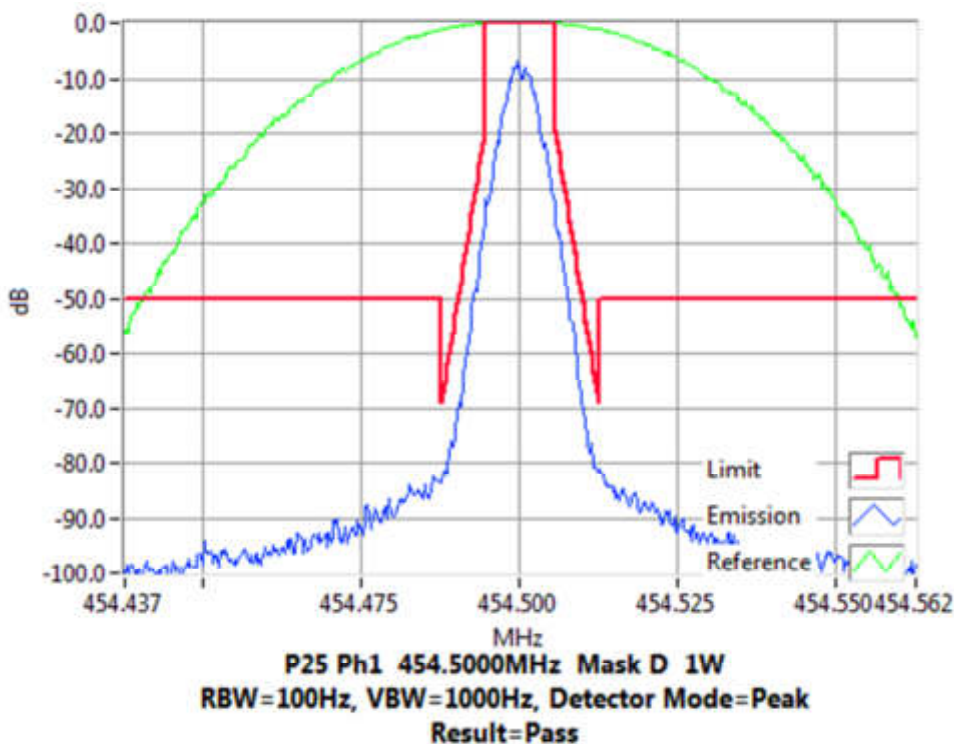

### Occupied Bandwidth and Spectrum Masks

APCO P25 phase-1

Tx FREQUENCY: 459.9 MHz 4 W 12.5 kHz Channel Spacing

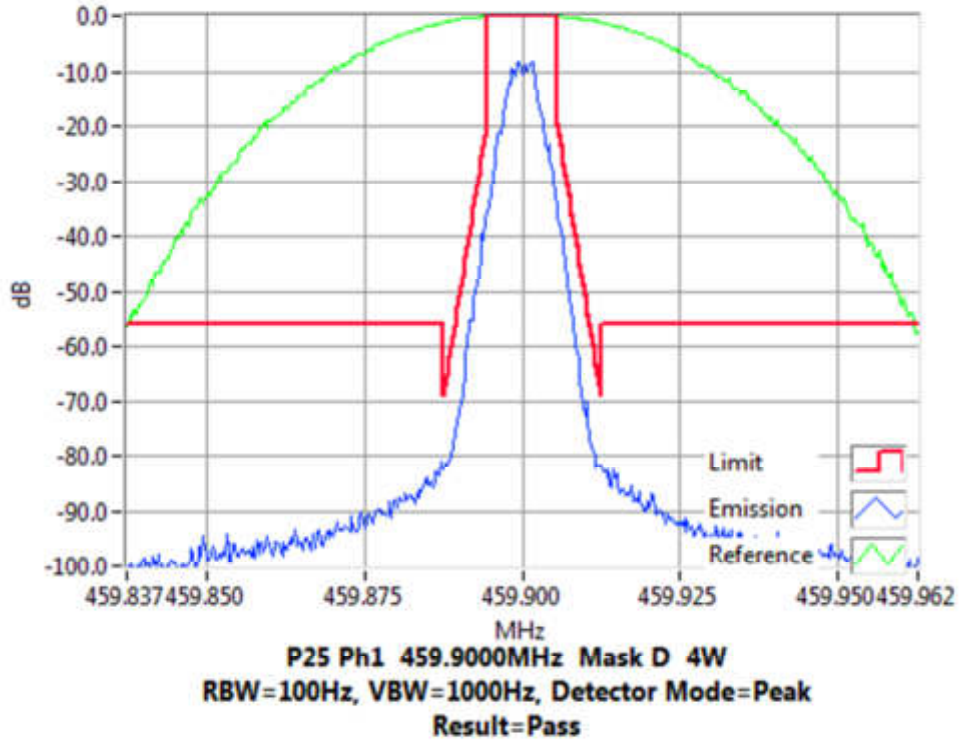

Tx FREQUENCY: 459.9 MHz 1 W 12.5 kHz Channel Spacing

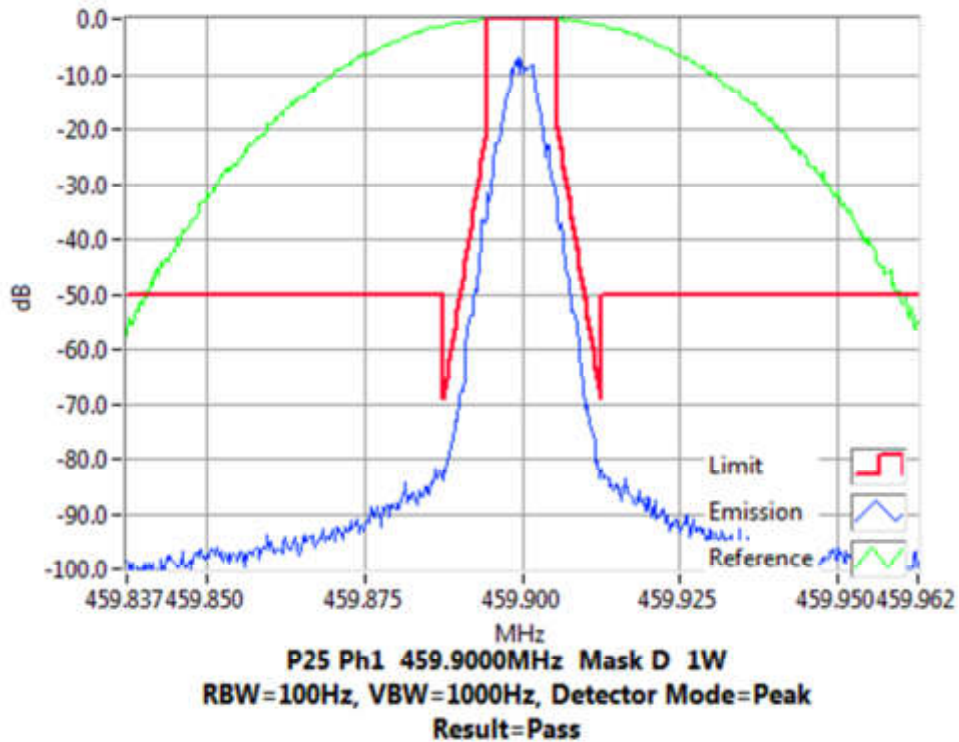



### Occupied Bandwidth and Spectrum Masks

APCO P25 phase-1

Tx FREQUENCY: 465.1 MHz 4 W 12.5 kHz Channel Spacing

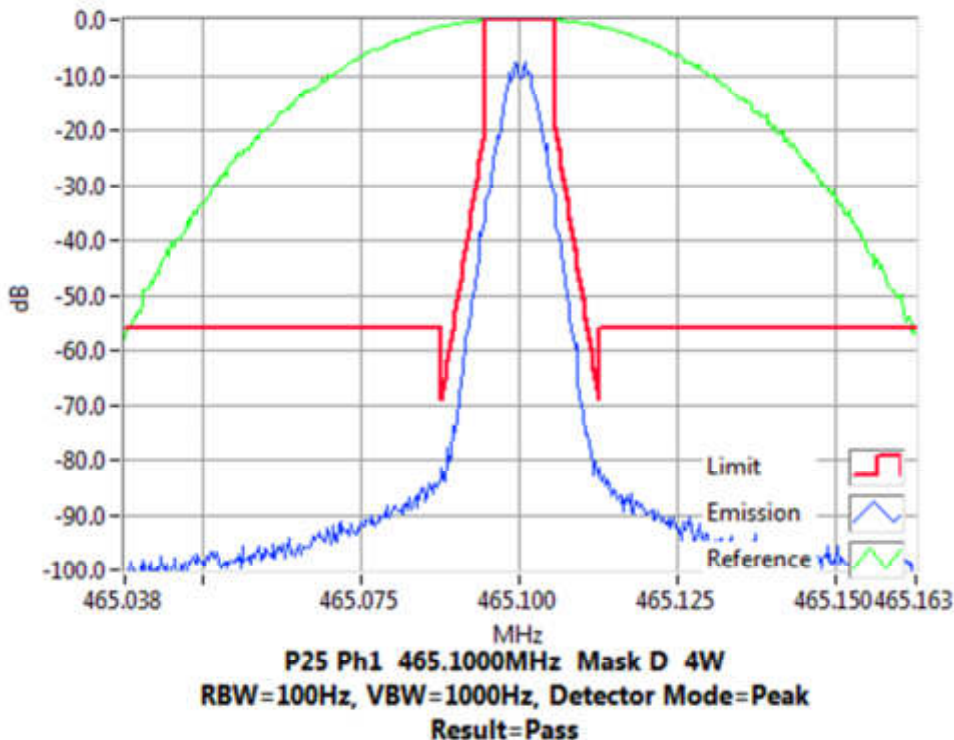

Tx FREQUENCY: 465.1 MHz 1 W 12.5 kHz Channel Spacing

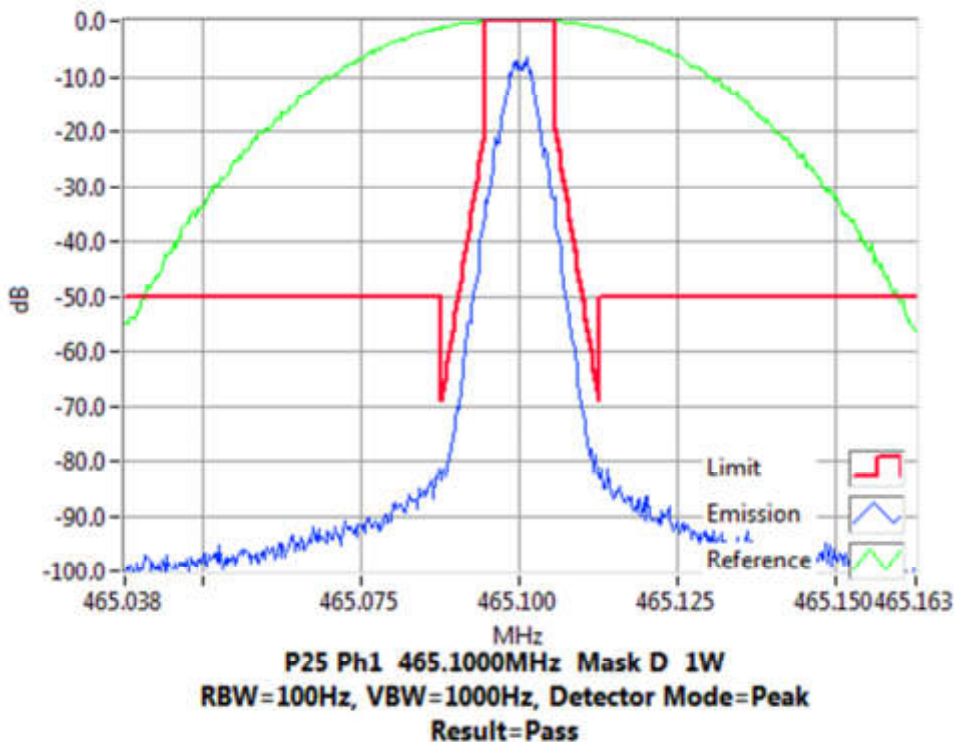

### Occupied Bandwidth and Spectrum Masks

APCO P25 phase-1

Tx FREQUENCY: 469.9 MHz 4 W 12.5 kHz Channel Spacing

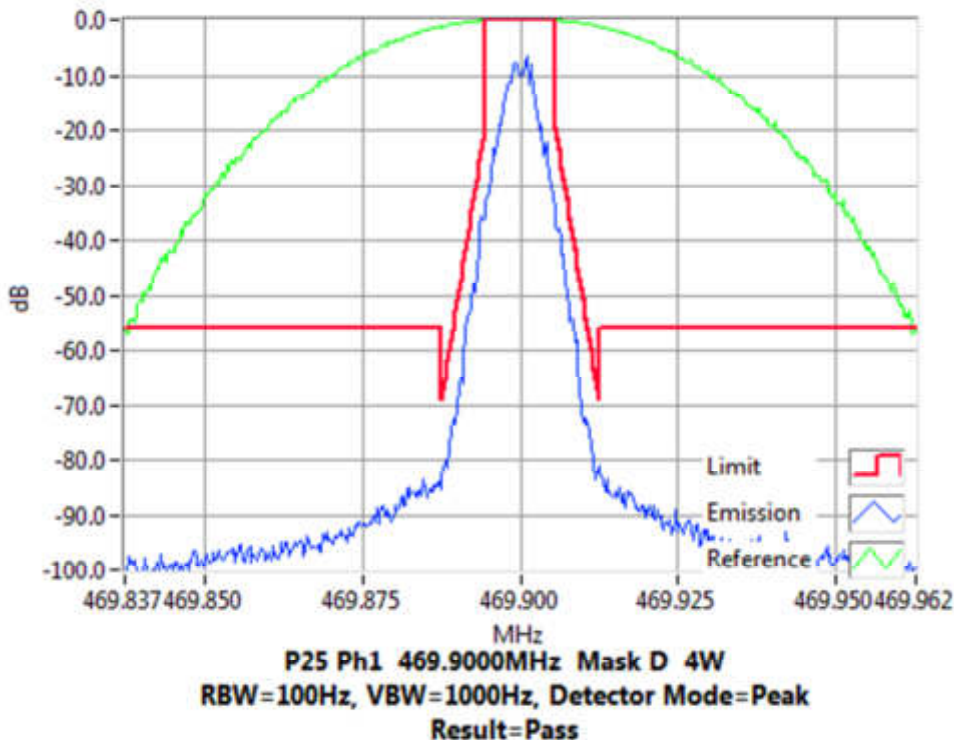

Tx FREQUENCY: 469.9 MHz 1 W 12.5 kHz Channel Spacing

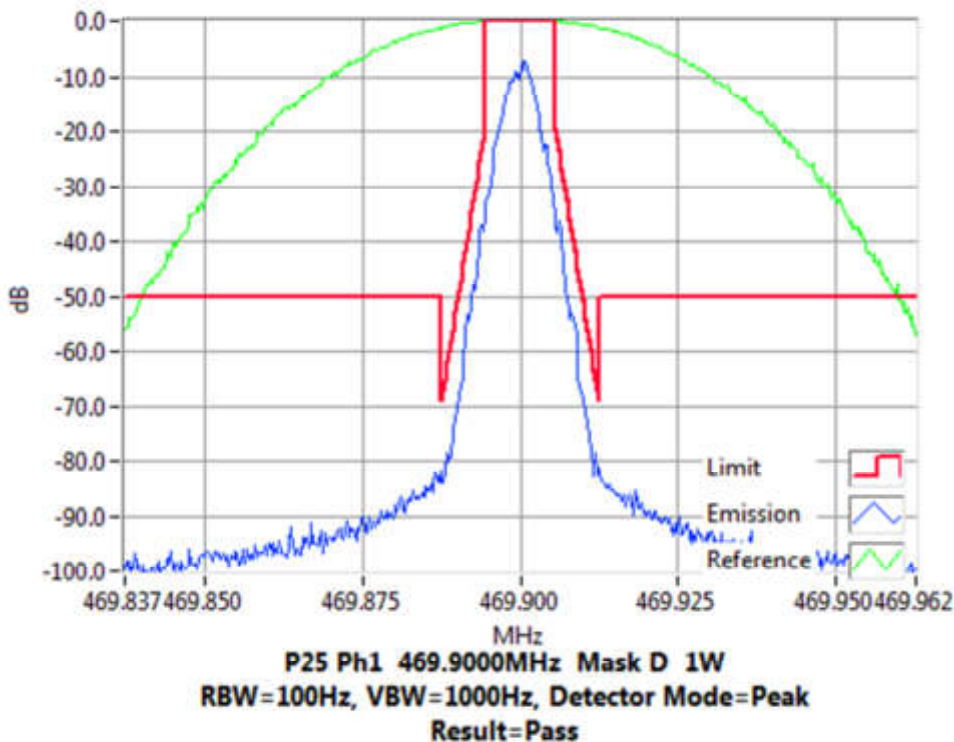

### Occupied Bandwidth and Spectrum Masks

APCO P25 phase-1

Tx FREQUENCY: 511.9 MHz 4 W 12.5 kHz Channel Spacing

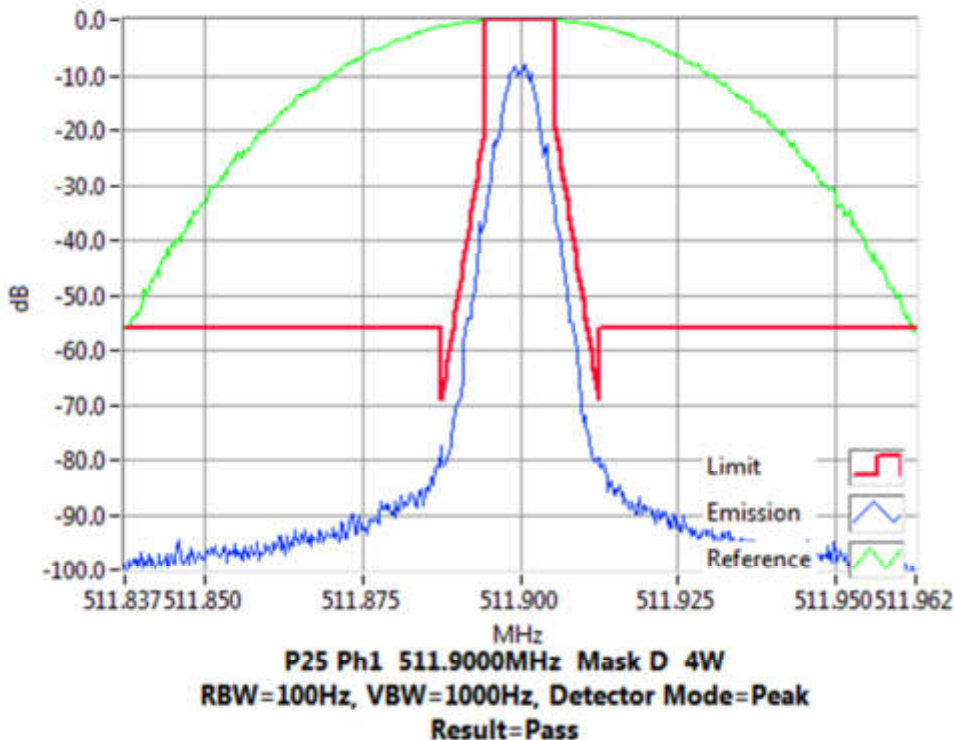

Tx FREQUENCY: 511.9 MHz 1 W 12.5 kHz Channel Spacing

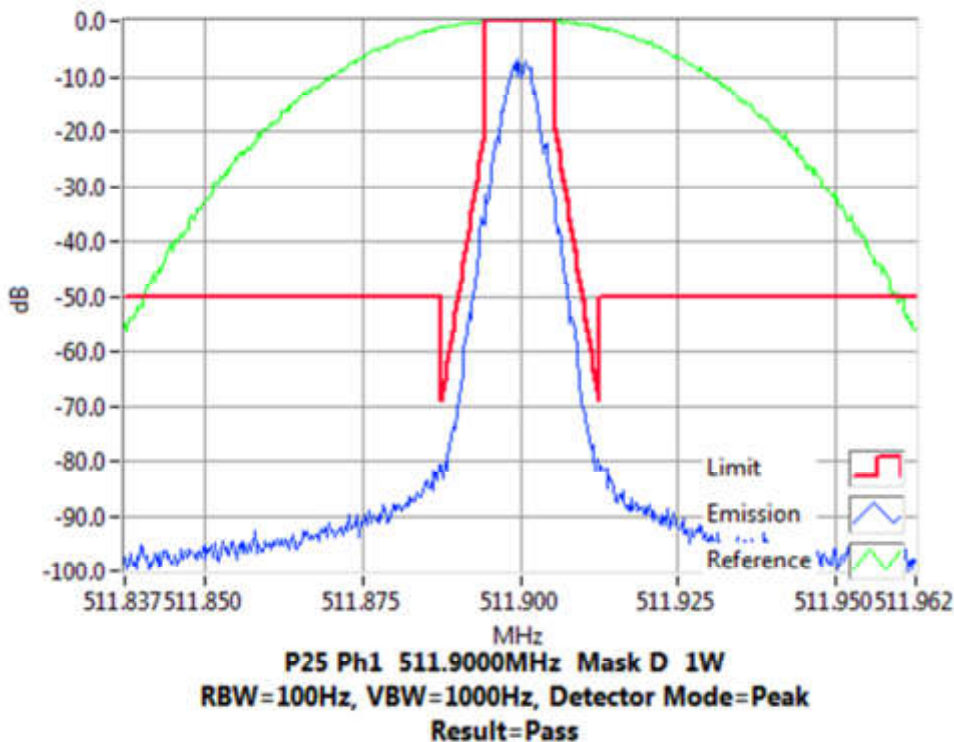

### Occupied Bandwidth and Spectrum Masks

APCO P25 phase-2

Tx FREQUENCY: 450.125 MHz 4 W 12.5 kHz Channel Spacing

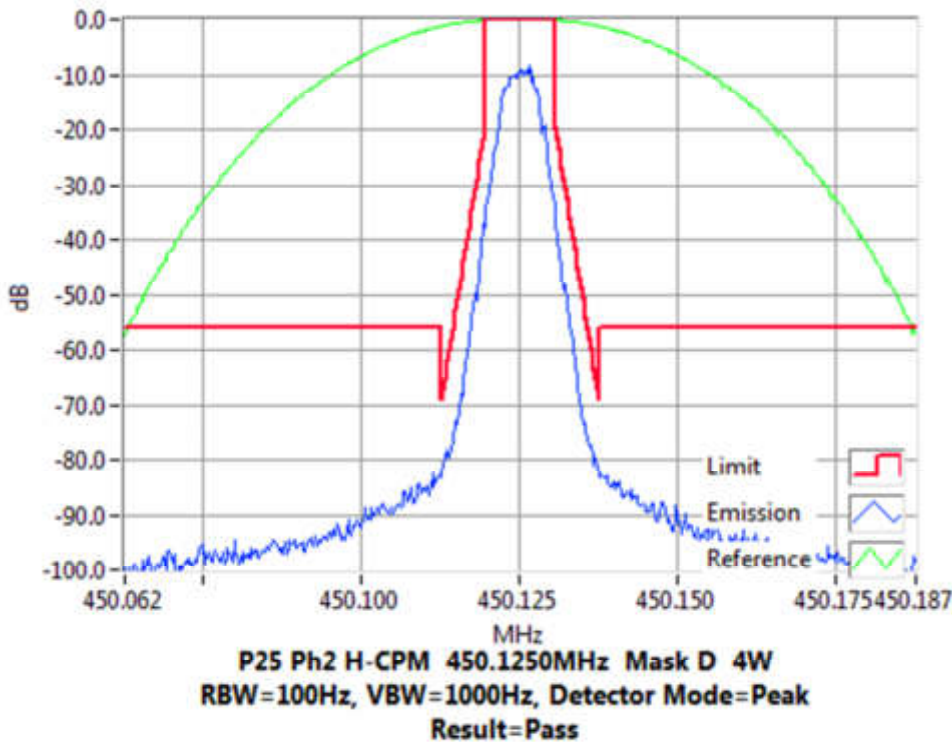

Tx FREQUENCY: 450.125 MHz 1 W 12.5 kHz Channel Spacing

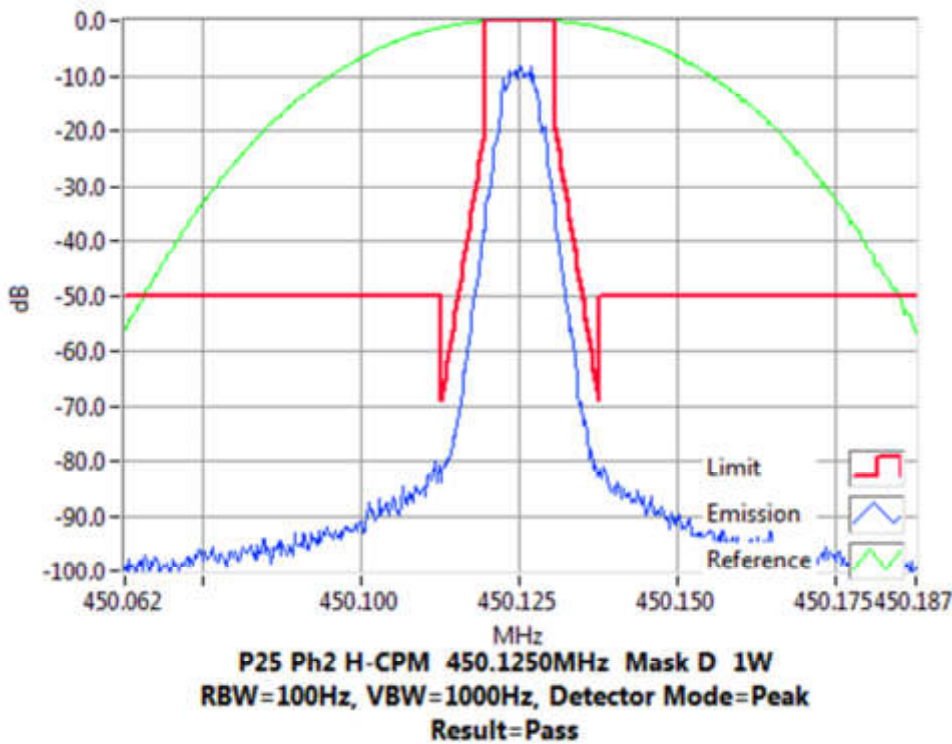

### Occupied Bandwidth and Spectrum Masks

APCO P25 phase-2

Tx FREQUENCY: 454.5 MHz 4 W 12.5 kHz Channel Spacing

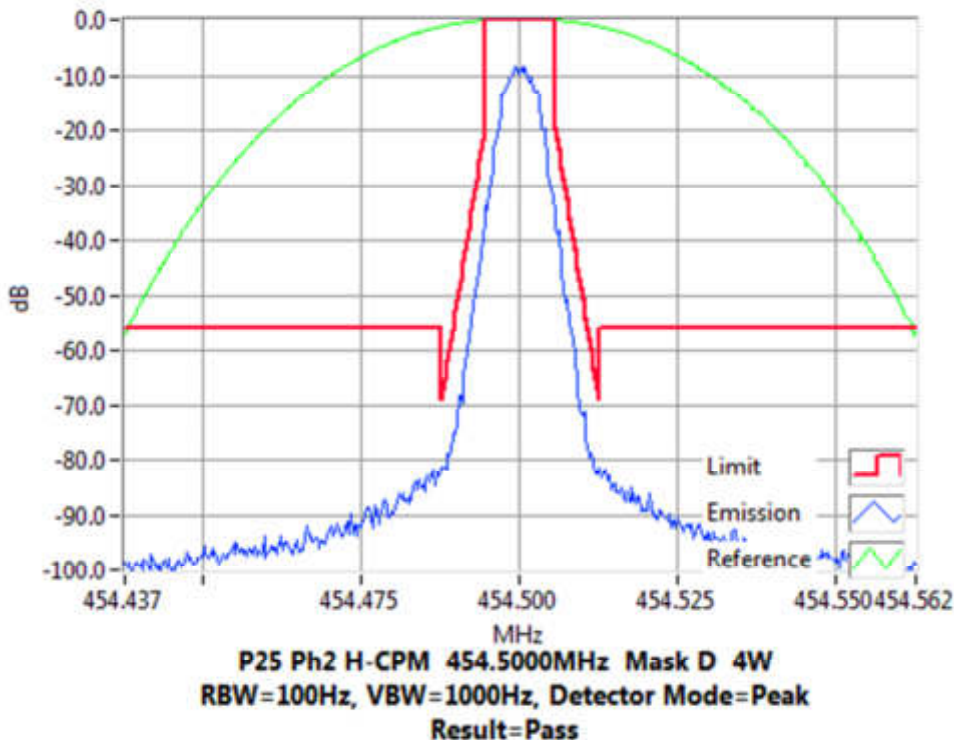

Tx FREQUENCY: 454.5 MHz 1 W 12.5 kHz Channel Spacing

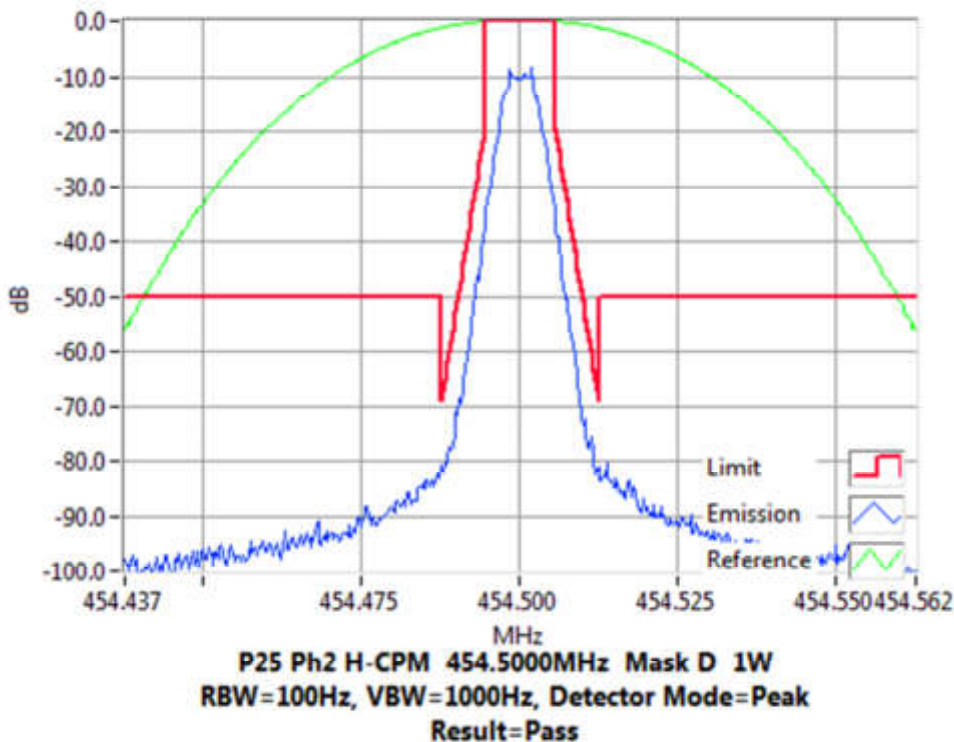

### Occupied Bandwidth and Spectrum Masks

APCO P25 phase-2

Tx FREQUENCY: 459.9 MHz 4 W 12.5 kHz Channel Spacing

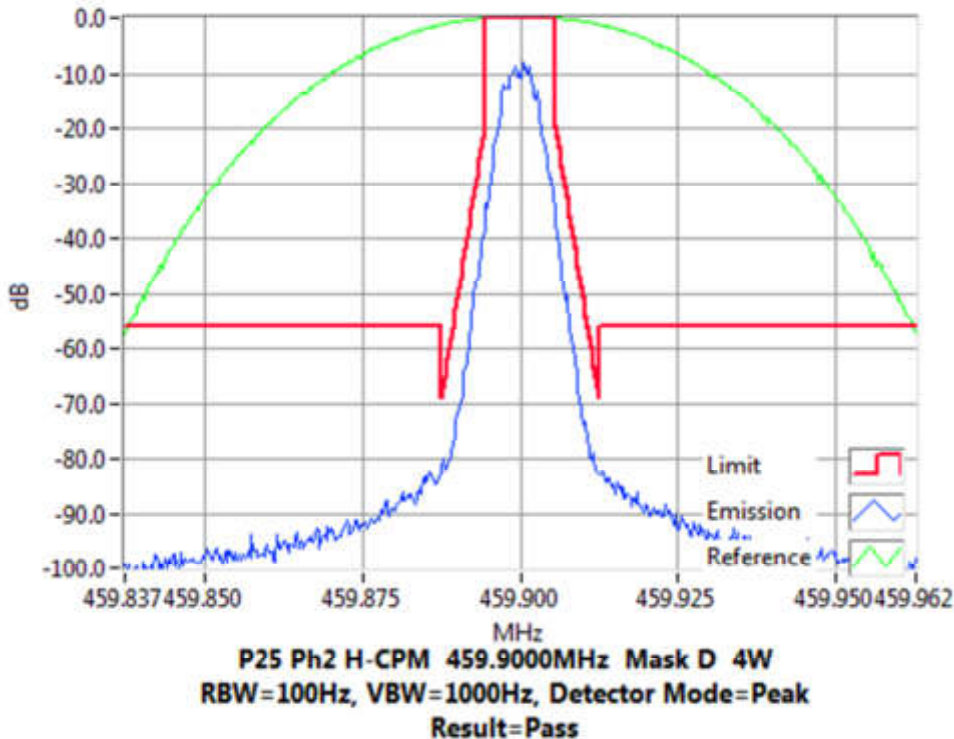

Tx FREQUENCY: 459.9 MHz 1 W 12.5 kHz Channel Spacing

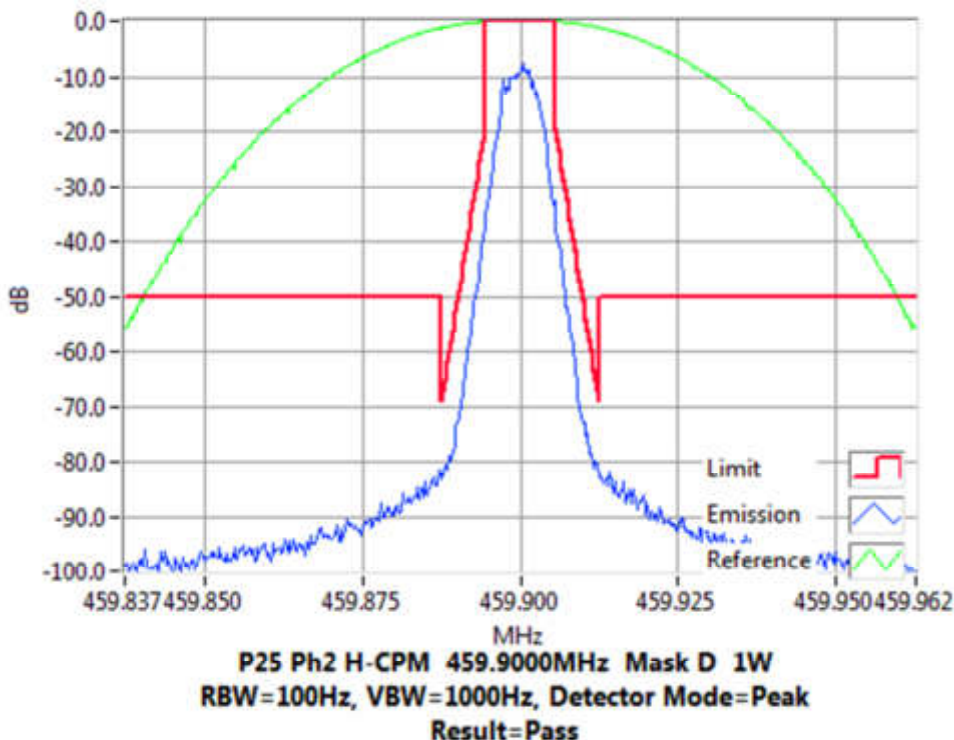

### Occupied Bandwidth and Spectrum Masks

APCO P25 phase-2

Tx FREQUENCY: 465.1 MHz 4 W 12.5 kHz Channel Spacing

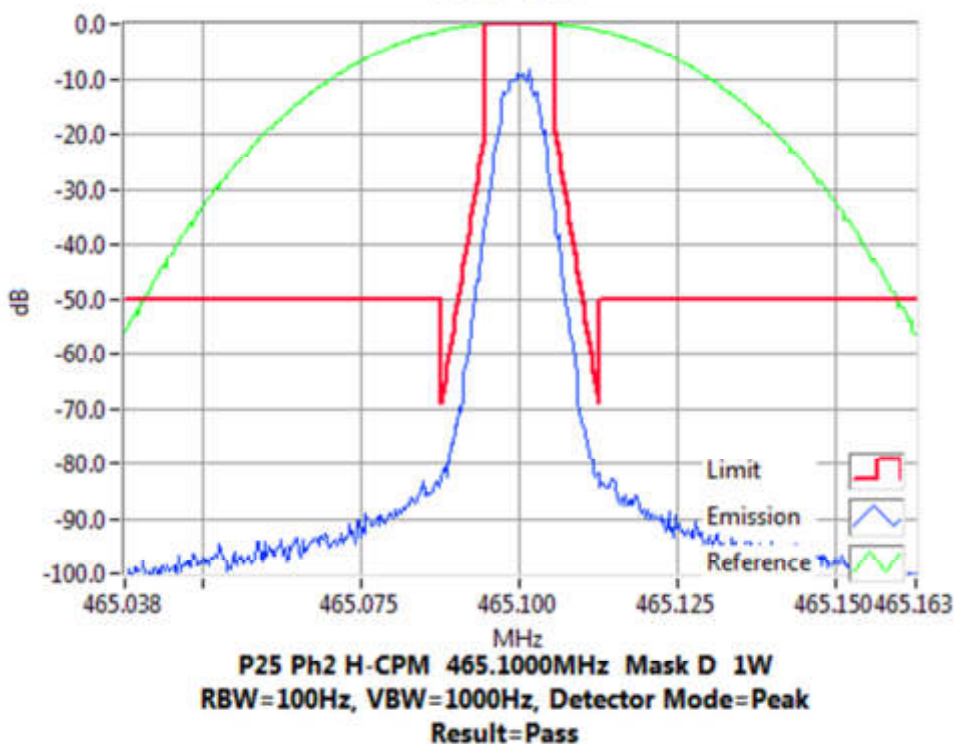
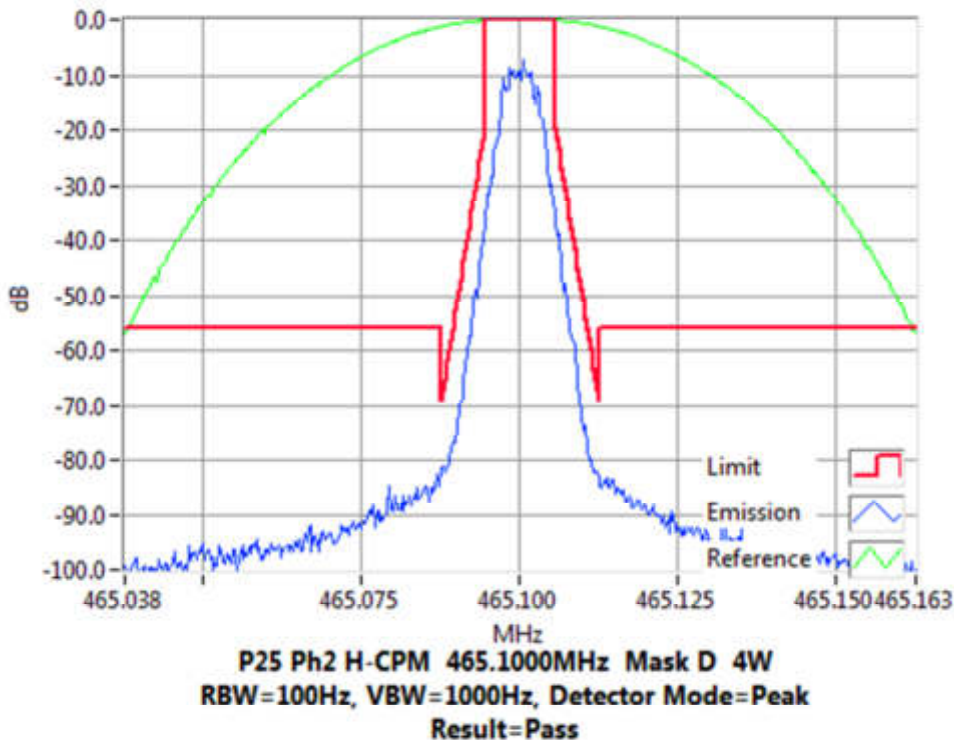

Tx FREQUENCY: 465.1 MHz 1 W 12.5 kHz Channel Spacing

### Occupied Bandwidth and Spectrum Masks

APCO P25 phase-2

Tx FREQUENCY: 469.9 MHz 4 W 12.5 kHz Channel Spacing

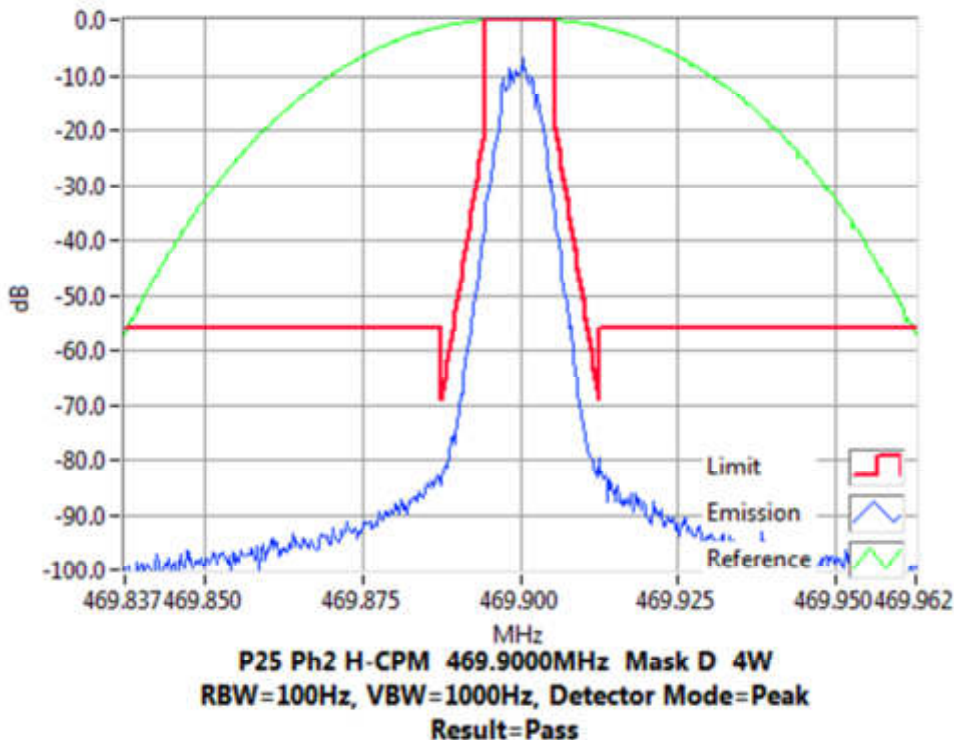

Tx FREQUENCY: 469.9 MHz 1 W 12.5 kHz Channel Spacing

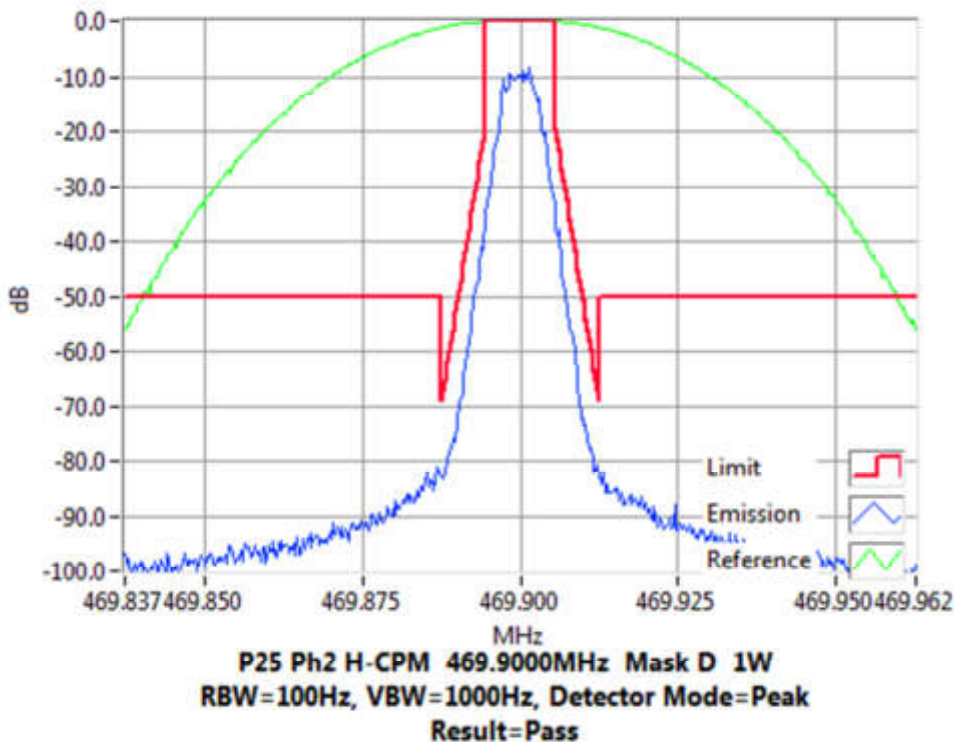



### Occupied Bandwidth and Spectrum Masks

APCO P25 phase-2

Tx FREQUENCY: 511.9 MHz 4 W 12.5 kHz Channel Spacing

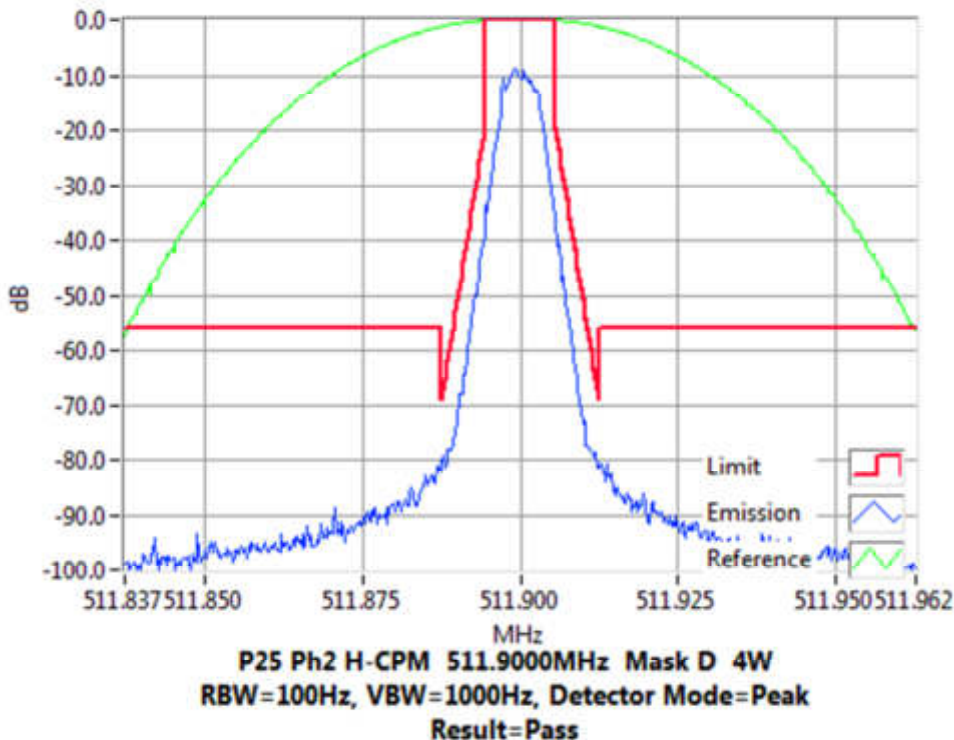

Tx FREQUENCY: 511.9 MHz 1 W 12.5 kHz Channel Spacing

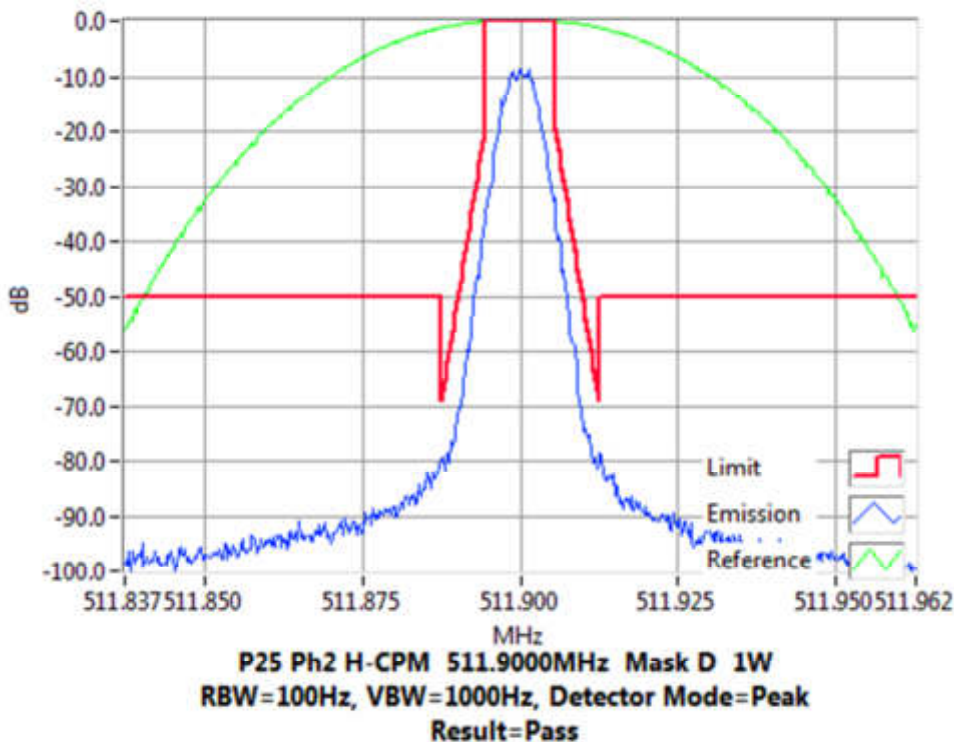

## TRANSMITTER SPURIOUS EMISSIONS (CONDUCTED)

SPECIFICATIONS: FCC 47 CFR 2.1051

RSS-119 5.8  
RSS-Gen 6.13

GUIDE: TIA/EIA-603E 2.2.13

### MEASUREMENT PROCEDURE:

1. Refer Annex A for equipment set up.
2. The frequency range examined was from the lowest frequency generated within the EUT, to a frequency higher than the 10<sup>th</sup> Harmonic: 100 kHz to Fc-BW  
Fc+ BW to 10Fc (5.2 GHz)
3. The EUT was set to transmit high or low power, modulated with P25 Phase 1 (C4FM). A scan is performed with a resolution bandwidth of 100 kHz and a video bandwidth of 30 kHz for frequencies up to 1 GHz, and a resolution bandwidth of 1 MHz and a video bandwidth of 3 MHz for frequencies above 1 GHz. A filter was used for frequencies just below the second harmonic to 4 GHz.
4. For each frequency range the spectrum analyser was loaded with the appropriate calibration figures to compensate for the cables, attenuator and filter losses, allowing the emission levels to be read directly with no further calculation.  
The calibrations are loaded as an overall reference level offset plus a set of correction factors for the required frequency band.

Spurious emissions which were attenuated by more than 20 dB below the limit were not recorded.

Example of attenuation correction:

30dB 350W CK9178	32.12	
2m5 Blue 33449	0.57	
3m Blue 503429	0.57	
Total Attenuation @ 500.000M Hz	33.26	Sum of component attenuation (a)
Amplitude offset	33.14	(b)
Correction @ 500.000 MHz	0.12	(a-b)

A photograph of the test set-up is included below.

### MEASUREMENT RESULTS:

See the tables and plots on the following pages for 12.5 kHz channel spacing.

LIMIT CLAUSES: FCC 47 CFR 90.210

RSS-119 5.8

Photo: Conducted Emissions Test Setup

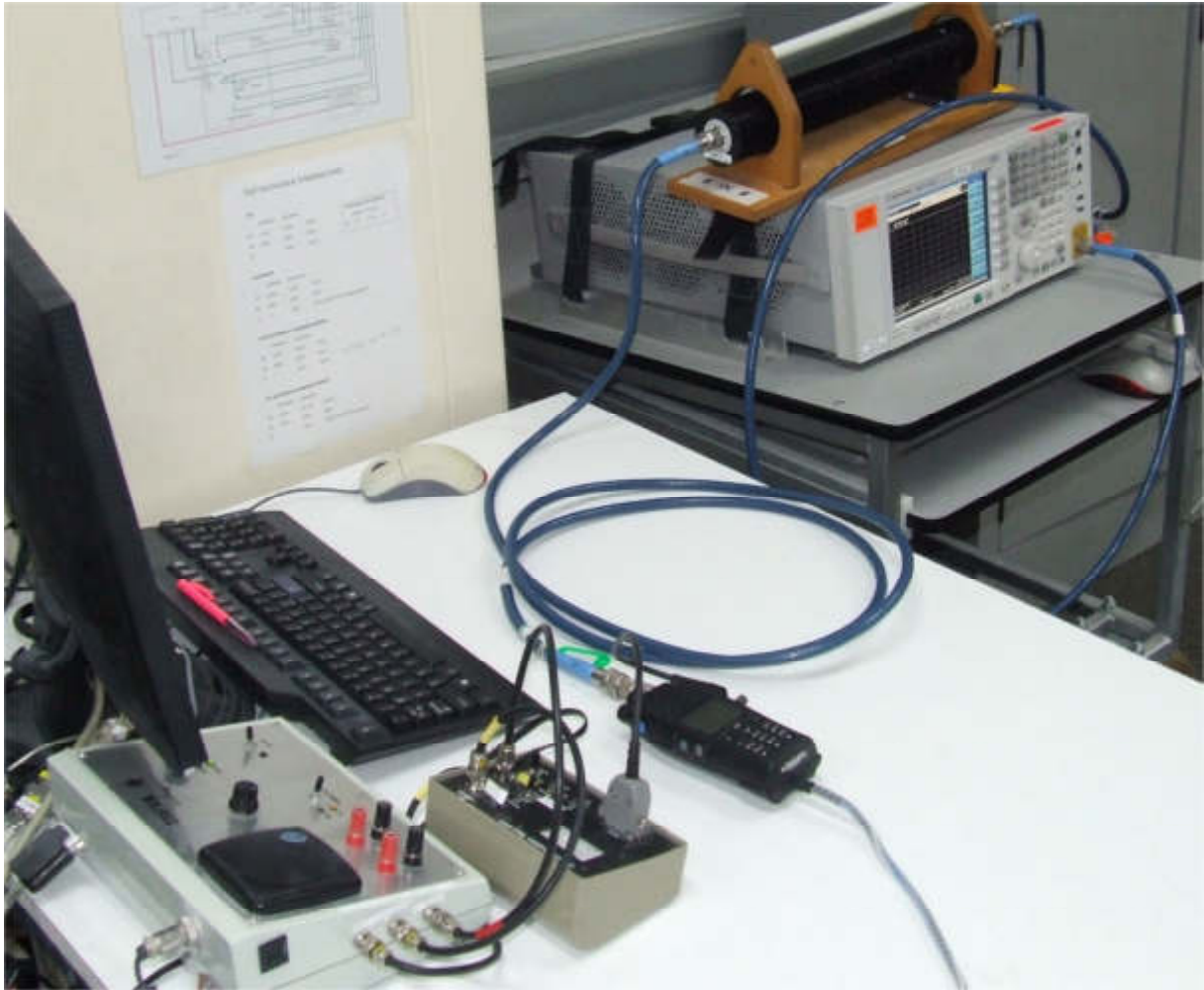

Spurious Emissions (Tx Conducted)

SPECIFICATION: FCC 47 CFR 2.1051

RSS-119 5.8

12.5 kHz Channel Spacing

450.125 MHz @ 4 W

Emission Mask D

Emission Frequency (MHz)	Level (dBm)	Level (dBc)
~	~	~

12.5 kHz Channel Spacing

450.125 MHz @ 1 W

Emission Mask D

Emission Frequency (MHz)	Level (dBm)	Level (dBc)
~	~	~
Measurement Uncertainty:	≤12.75 GHz ± 3.0 dB	
No emissions were detected at a level greater than 20 dB below the limit.		

Spurious Emissions (Tx Conducted)

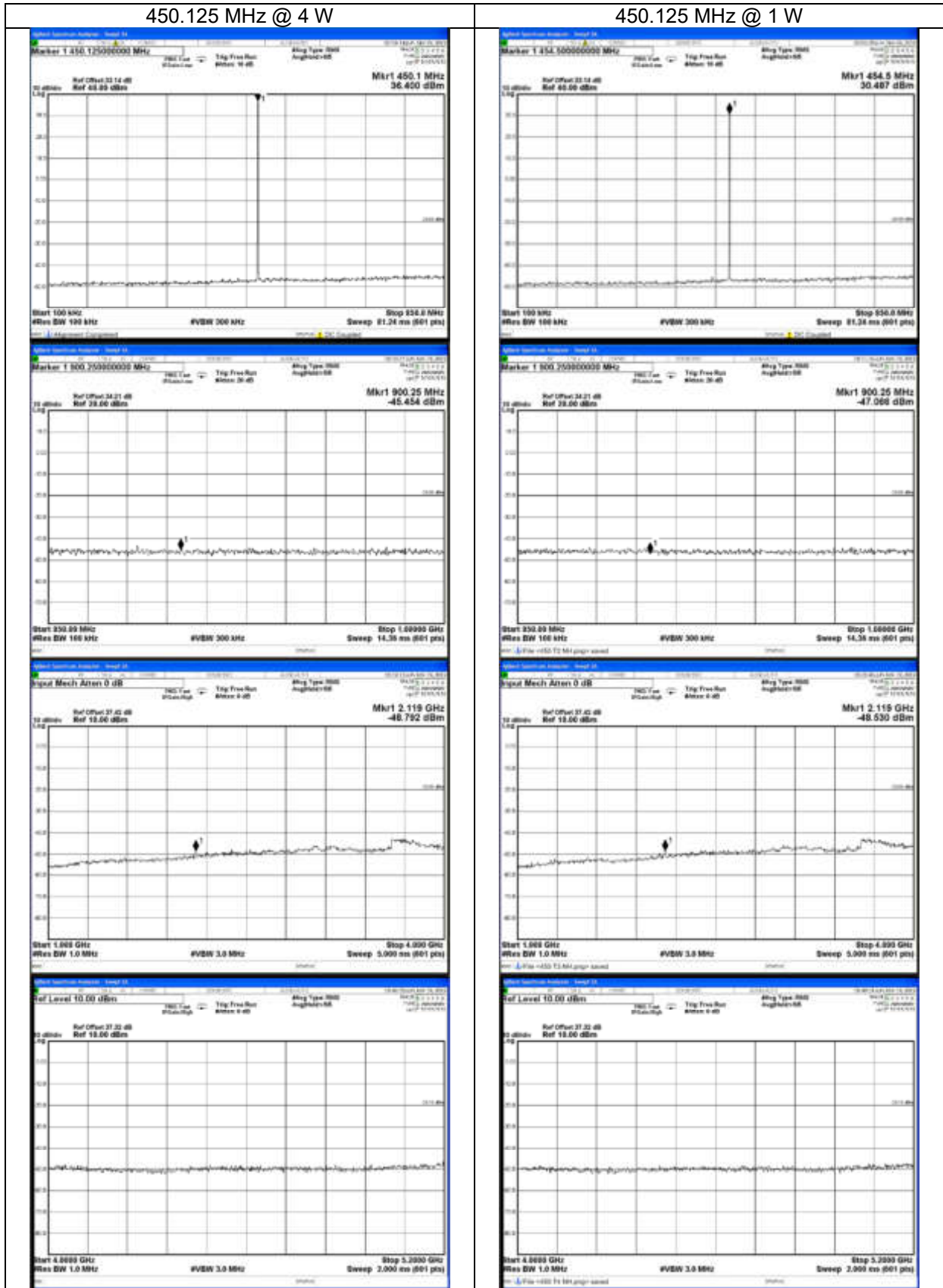

Spurious Emissions (Tx Conducted)

SPECIFICATION: FCC 47 CFR 2.1051

RSS-119 5.8

12.5 kHz Channel Spacing                      454.5 MHz @ 4 W                      Emission Mask D

Emission Frequency (MHz)	Level (dBm)	Level (dBc)
~	~	~

12.5 kHz Channel Spacing                      454.5 MHz @ 1 W                      Emission Mask D

Emission Frequency (MHz)	Level (dBm)	Level (dBc)
~	~	~
Measurement Uncertainty:	≤12.75 GHz    ± 3.0 dB	
No emissions were detected at a level greater than 20 dB below the limit.		

Spurious Emissions (Tx Conducted)

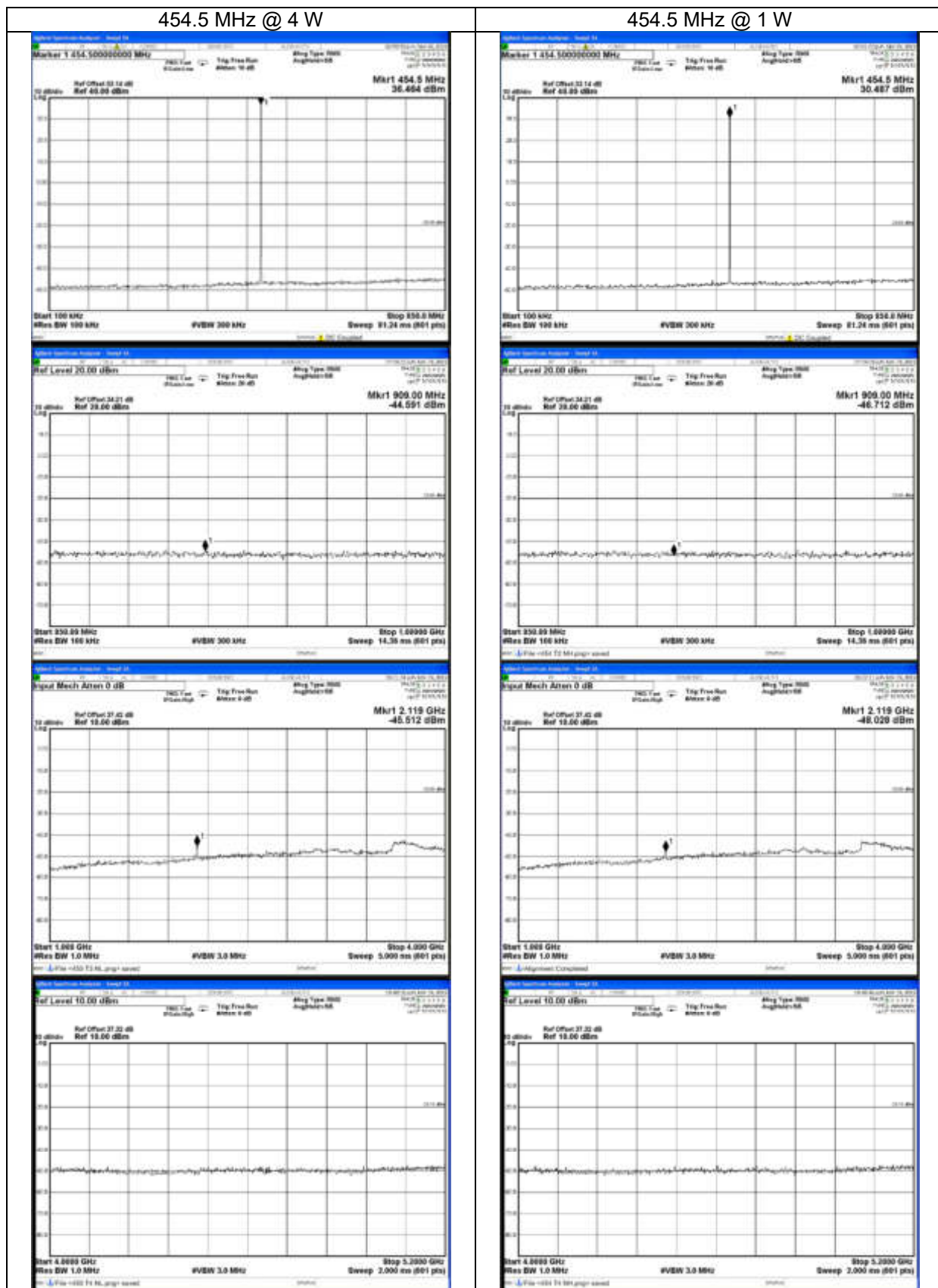

Spurious Emissions (Tx Conducted)

SPECIFICATION: FCC 47 CFR 2.1051

RSS-119 5.8

12.5 kHz Channel Spacing                      459.9 MHz @ 4 W                      Emission Mask D

Emission Frequency (MHz)	Level (dBm)	Level (dBc)
~	~	~

12.5 kHz Channel Spacing                      459.9 MHz @ 1 W                      Emission Mask D

Emission Frequency (MHz)	Level (dBm)	Level (dBc)
~	~	~
Measurement Uncertainty:	≤12.75 GHz    ± 3.0 dB	
No emissions were detected at a level greater than 20 dB below the limit.		



Spurious Emissions (Tx Conducted)

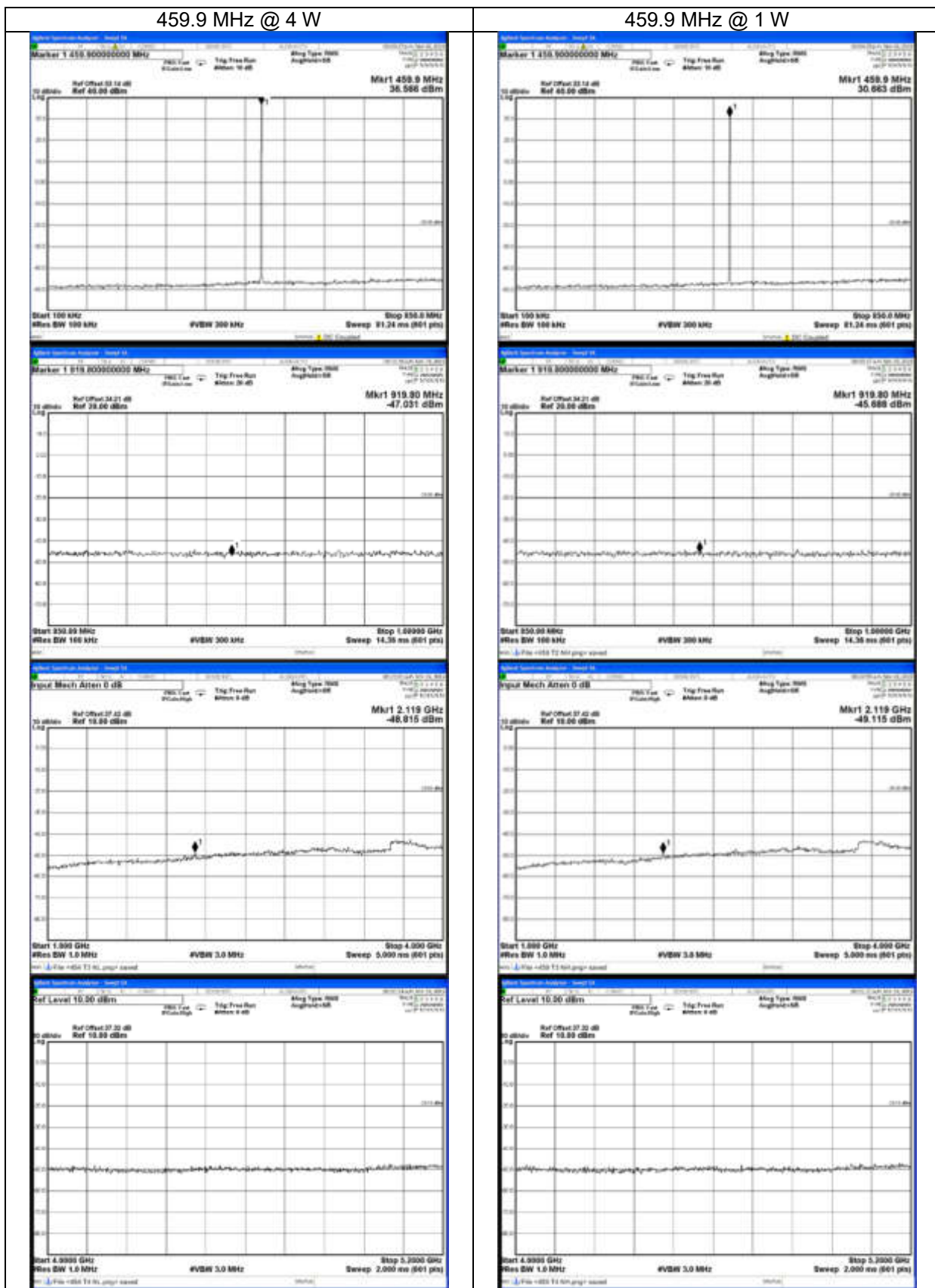

Spurious Emissions (Tx Conducted)

SPECIFICATION: FCC 47 CFR 2.1051

RSS-119 5.8

12.5 kHz Channel Spacing

465.1 MHz @ 4 W

Emission Mask D

Emission Frequency (MHz)	Level (dBm)	Level (dBc)
~	~	~

12.5 kHz Channel Spacing

465.1 MHz @ 1 W

Emission Mask D

Emission Frequency (MHz)	Level (dBm)	Level (dBc)
~	~	~
Measurement Uncertainty:	≤12.75 GHz ± 3.0 dB	
No emissions were detected at a level greater than 20 dB below the limit.		

Spurious Emissions (Tx Conducted)

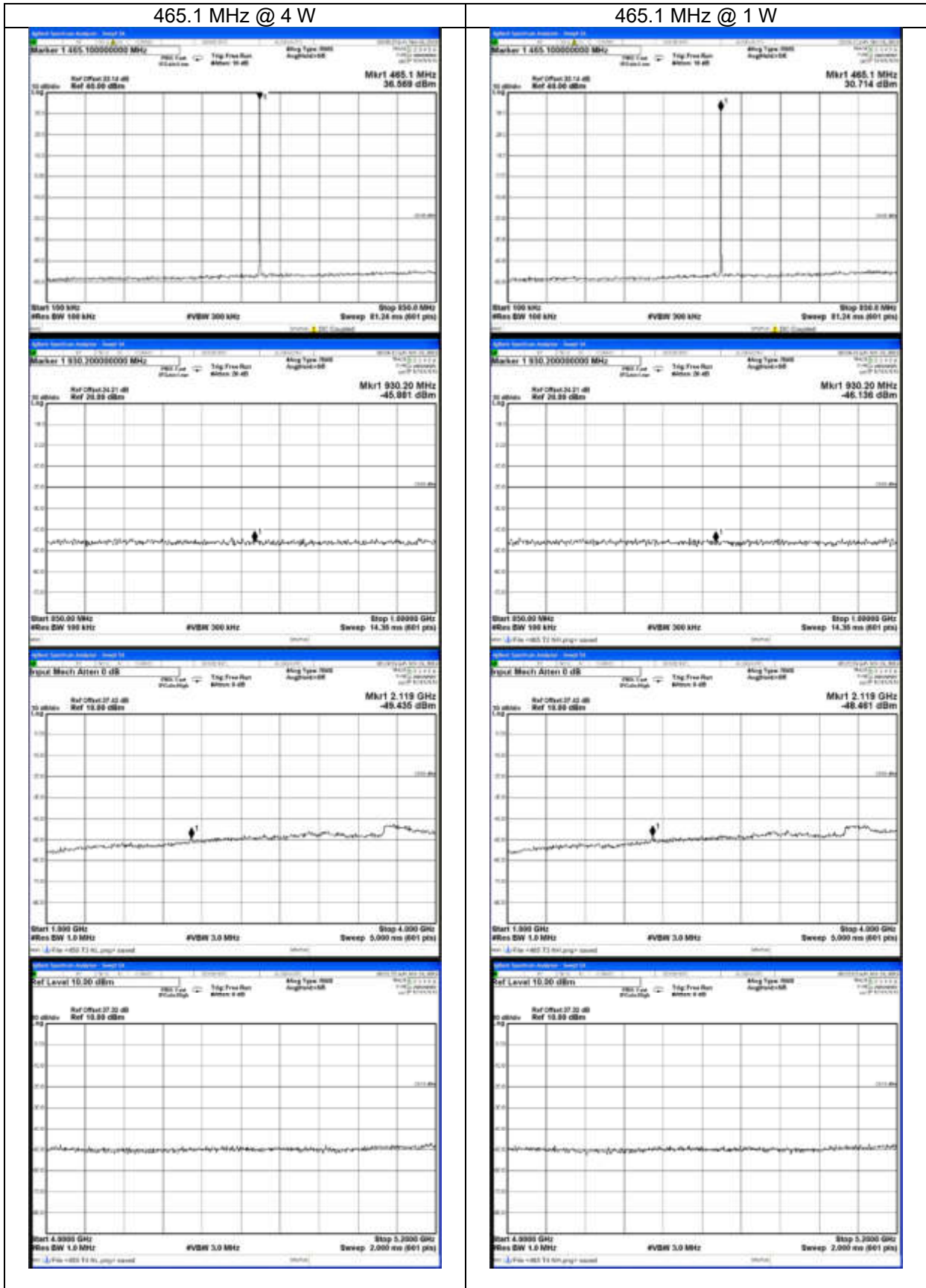

Spurious Emissions (Tx Conducted)

SPECIFICATION: FCC 47 CFR 2.1051

RSS-119 5.8

12.5 kHz Channel Spacing

469.9 MHz @ 4 W

Emission Mask D

Emission Frequency (MHz)	Level (dBm)	Level (dBc)
~	~	~

12.5 kHz Channel Spacing

469.9 MHz @ 1 W

Emission Mask D

Emission Frequency (MHz)	Level (dBm)	Level (dBc)
~	~	~
Measurement Uncertainty:	≤12.75 GHz ± 3.0 dB	
No emissions were detected at a level greater than 20 dB below the limit.		

Spurious Emissions (Tx Conducted)

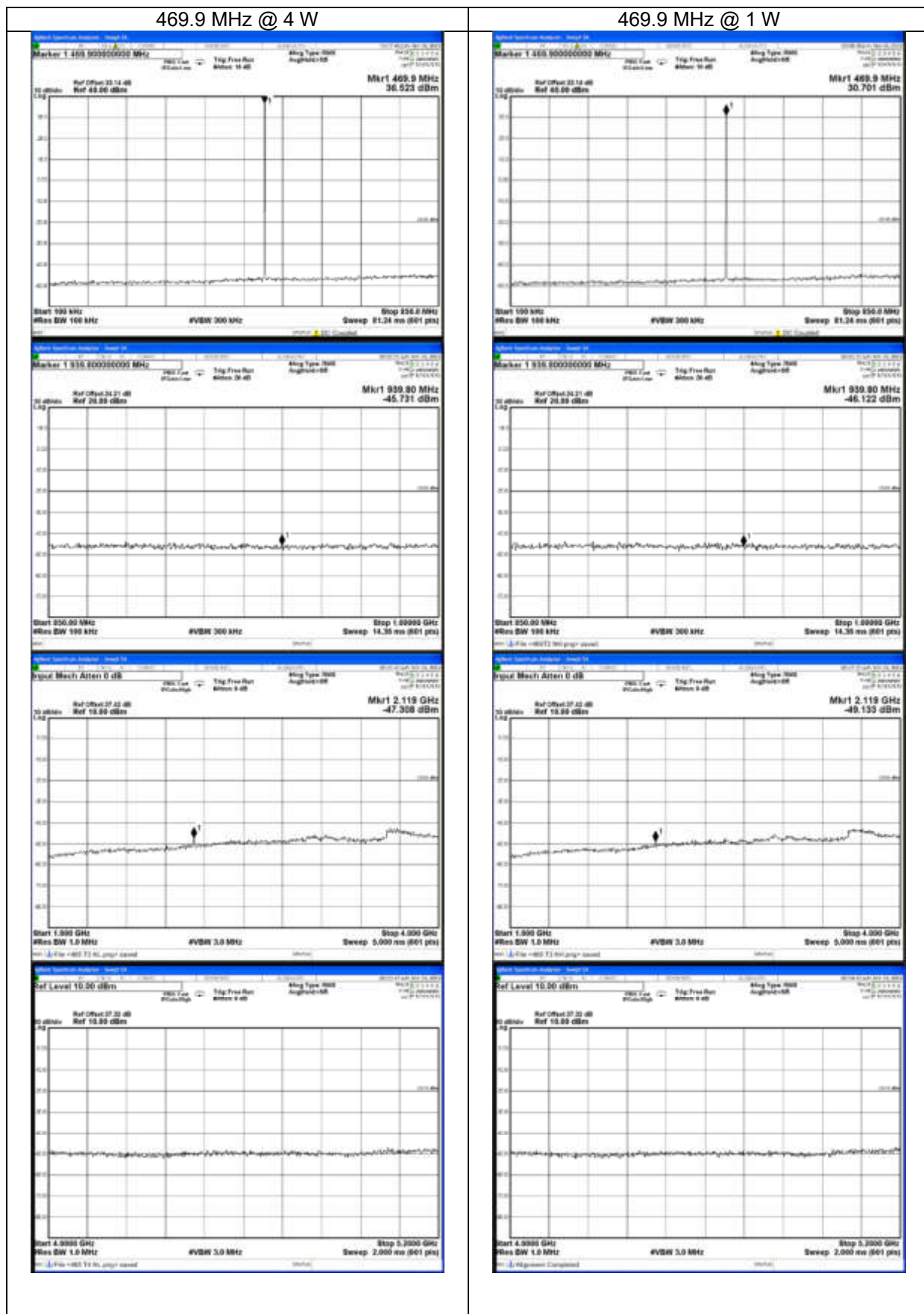

Spurious Emissions (Tx Conducted)

SPECIFICATION: FCC 47 CFR 2.1051

RSS-119 5.8

12.5 kHz Channel Spacing

511.9 MHz @ 4 W

Emission Mask D

Emission Frequency (MHz)	Level (dBm)	Level (dBc)
~	~	~

12.5 kHz Channel Spacing

511.9 MHz @ 1 W

Emission Mask D

Emission Frequency (MHz)	Level (dBm)	Level (dBc)
~	~	~
Measurement Uncertainty:	≤12.75 GHz ± 3.0 dB	
No emissions were detected at a level greater than 20 dB below the limit.		

Spurious Emissions (Tx Conducted)

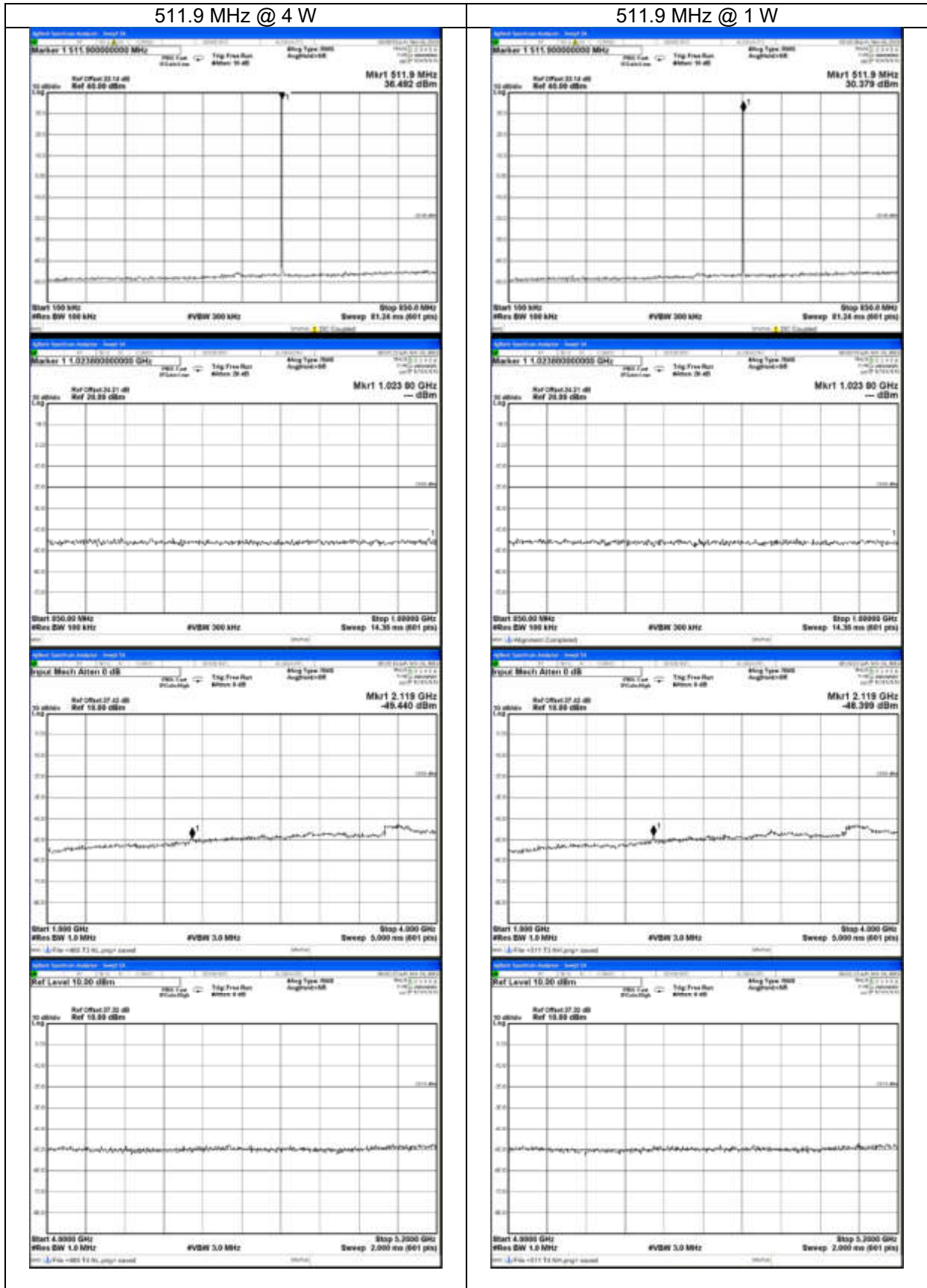

Spurious Emissions (Tx Conducted)

SPECIFICATION: FCC 47 CFR 2.1051 RSS-119 5.8

LIMITS: FCC 47 CFR 90.210 RSS-119 5.8

Carrier Output Power	Emission Mask D 12.5 kHz Channel Spacing $50 + 10 \text{ Log}_{10} (P_{\text{Watts}})$	
4 W	-20 dBm	- dBc
1 W	-20 dBm	- dBc



## TRANSMITTER SPURIOUS EMISSIONS (RADIATED)

SPECIFICATION: FCC 47 CFR 2.1053

GUIDE: TIA/EIA-603E 2.2.12

### MEASUREMENT PROCEDURE:

#### Initial Scan:

1. The EUT is placed in the S-Line TEM cell and emissions are measured from 30 MHz to 800 MHz. Any emission within 20 dB of the limit is then re-tested on the OATS.
2. The EUT is placed in the reverberation chamber and emissions are measured from 800 MHz to the upper frequency required. Any emission within 20 dB of the limit is then re-tested on the OATS.
3. The harmonics emissions up to the 6<sup>th</sup> harmonic of the fundamental frequency are measured on the OATS

#### OATS Measurement:

1. The EUT is placed on a wooden turntable at a distance of three metres from the test antenna. The output terminal is connected to an RF dummy load.
2. The test antenna is raised from 1 m to 4 m to obtain a maximum reading; the turntable is then rotated through 360° to obtain the maximum response of each spurious emission. Valid emissions are determined by switching the EUT on and off.
3. The EUT is then replaced by a signal generator and substitution antenna to make measurements by the substitution method.

### MEASUREMENT RESULTS:

See the tables on the following pages

LIMIT CLAUSE: FCC 47 CFR 90.210

Spurious Emissions (Tx Radiated) - Continued

SPECIFICATION: FCC 47 CFR 2.1053

12.5 kHz Channel Spacing                      450.125 MHz @ 4 W                      Emission Mask D

Emission Frequency (MHz)	Level (dBm)	Level (dBc)
~	~	~

12.5 kHz Channel Spacing                      450.125 MHz @ 1 W                      Emission Mask D

Emission Frequency (MHz)	Level (dBm)	Level (dBc)
~	~	~
Measurement Uncertainty	± 4.6 dB	
No emissions were detected at a level greater than 20 dB below the limit.		

12.5 kHz Channel Spacing                      454.5 MHz @ 4 W                      Emission Mask D

Emission Frequency (MHz)	Level (dBm)	Level (dBc)
~	~	~

12.5 kHz Channel Spacing                      454.5 MHz @ 1 W                      Emission Mask D

Emission Frequency (MHz)	Level (dBm)	Level (dBc)
~	~	~
Measurement Uncertainty	± 4.6 dB	
No emissions were detected at a level greater than 20 dB below the limit.		

12.5 kHz Channel Spacing                      459.9 MHz @ 4 W                      Emission Mask D

Emission Frequency (MHz)	Level (dBm)	Level (dBc)
~	~	~

12.5 kHz Channel Spacing                      459.9 MHz @ 1 W                      Emission Mask D

Emission Frequency (MHz)	Level (dBm)	Level (dBc)
~	~	~
Measurement Uncertainty	± 4.6 dB	
No emissions were detected at a level greater than 20 dB below the limit.		

Spurious Emissions (Tx Radiated) - Continued

12.5 kHz Channel Spacing                      465.1 MHz @ 4 W                      Emission Mask D

Emission Frequency (MHz)	Level (dBm)	Level (dBc)
~	~	~

12.5 kHz Channel Spacing                      465.1 MHz @ 1 W                      Emission Mask D

Emission Frequency (MHz)	Level (dBm)	Level (dBc)
~	~	~
Measurement Uncertainty	± 4.6 dB	
No emissions were detected at a level greater than 20 dB below the limit.		

12.5 kHz Channel Spacing                      469.9 MHz @ 4 W                      Emission Mask D

Emission Frequency (MHz)	Level (dBm)	Level (dBc)
~	~	~

12.5 kHz Channel Spacing                      469.9 MHz @ 1 W                      Emission Mask D

Emission Frequency (MHz)	Level (dBm)	Level (dBc)
~	~	~
Measurement Uncertainty	± 4.6 dB	
No emissions were detected at a level greater than 20 dB below the limit.		

12.5 kHz Channel Spacing                      511.9 MHz @ 4 W                      Emission Mask D

Emission Frequency (MHz)	Level (dBm)	Level (dBc)
~	~	~

12.5 kHz Channel Spacing                      511.9 MHz @ 1 W                      Emission Mask D

Emission Frequency (MHz)	Level (dBm)	Level (dBc)
~	~	~
Measurement Uncertainty	± 4.6 dB	
No emissions were detected at a level greater than 20 dB below the limit.		

Spurious Emissions (Tx Radiated) - Continued

LIMITS: FCC 47 CFR 2.1053

Carrier Output Power	Emission Mask D 12.5 kHz Channel Spacing $50 + 10 \text{ Log}_{10} (P_{\text{Watts}})$	
4 W	-20 dBm	- dBc
1 W	-20 dBm	- dBc

Open Area Test Site Results:

12.5 kHz Channel Spacing

511.9 MHz @ 4 W

Emission Mask D

Harmonics Emission Frequency (MHz)	Level (dBm)	Level (dBc)
1023.800000	-45.40	-81.4
1535.700000	-64.83	-100.83
2047.600000	-73.43	-109.43
2559.500000	-75.69	-111.69
3071.400000	-76.15	-112.15
3583.300000	-70.36	-106.36
Measurement Uncertainty	± 4.6 dB	

Sample Calculation	Measurement					Result
	Reference	Substitution				
Emission Frequency (MHz)	Reference Level (dBm)	Sig-gen Level	Cable and Attenuator Gain	Antenna Gain (dBd)	Path and Boresight corrections	dBm
1023.800000	-81.89	-31.66	-17.76	3.85	0.18	-45.40
		A	B	C	D	E

Result (E) = A+B+C+D Result

Photo: OATS Setup



## TRANSIENT FREQUENCY BEHAVIOR

SPECIFICATION: FCC 47 CFR 90.214 RSS-119 5.9

GUIDE: TIA/EIA-603E 2.2.19

### MEASUREMENT PROCEDURE:

1. Refer Annex A for equipment set up.
2. Measurements and plots were made following the TIA/EIA procedure.

### MEASUREMENT RESULTS:

See the tables and plots on the following pages for 12.5 kHz channel spacing.

LIMIT CLAUSES: FCC 47 CFR 90.214 RSS-119 5.9

### Transient Frequency Behaviour

SPECIFICATION: FCC 47 CFR 90.214

RSS-119 5.9

Tx FREQUENCY: 450.125 MHz

4 W

12.5 kHz Channel Spacing

TRANSIENT RESPONSE PERIOD	CARRIER PEAK VARIATION FROM NORMAL	
	Key ON (kHz)	Key OFF (kHz)
t1	-0.2	N/A
t2	-0.3	N/A
t3	N/A	0.7

Confirm that during periods t1 and t3 the frequency difference does not exceed the value of one channel separation.	YES	NO
	✓	<input type="checkbox"/>
Confirm that during the period t2 the frequency difference does not exceed half a channel separation.	YES	NO
	✓	<input type="checkbox"/>
Confirm that during the period t2 to t3 the frequency difference does not exceed the frequency error limit.	YES	NO
	✓	<input type="checkbox"/>

Measurement Uncertainty: Frequency  $\pm$  130 Hz; Time  $\pm$  0.2%

LIMIT: FCC 47 CFR 90.214

TRANSIENT PERIODS	FREQUENCY RANGE	
	150 MHz – 174 MHz	421 MHz – 512 MHz
t1 (ms)	5 ms	10 ms
t2 (ms)	20 ms	25 ms
t3 (ms)	5 ms	10 ms

LIMIT: RSS-119 5.9

Transient Frequency Behaviour for Equipment Designed to Operate on 12.5 kHz Channels			
TRANSIENT PERIODS	Maximum Frequency Difference	FREQUENCY RANGE	
		138 – 174 MHz	406.1 – 470 MHz
t1 (ms)	$\pm$ 12.5 kHz	5 ms	10 ms
t2 (ms)	$\pm$ 6.25 kHz	20 ms	25 ms
t3 (ms)	$\pm$ 12.5 kHz	5 ms	10 ms

Note: RSS-119 5.9 - If the transmitter carrier output power rating is 6 Watts or less, the frequency difference during the time periods t1 and t3 may exceed the maximum frequency difference for these time periods.

### Transient Frequency Behaviour

SPECIFICATION: FCC 47 CFR 90.214

RSS-119 5.9

Tx FREQUENCY: 450.125 MHz 4 W

12.5 kHz Channel Spacing

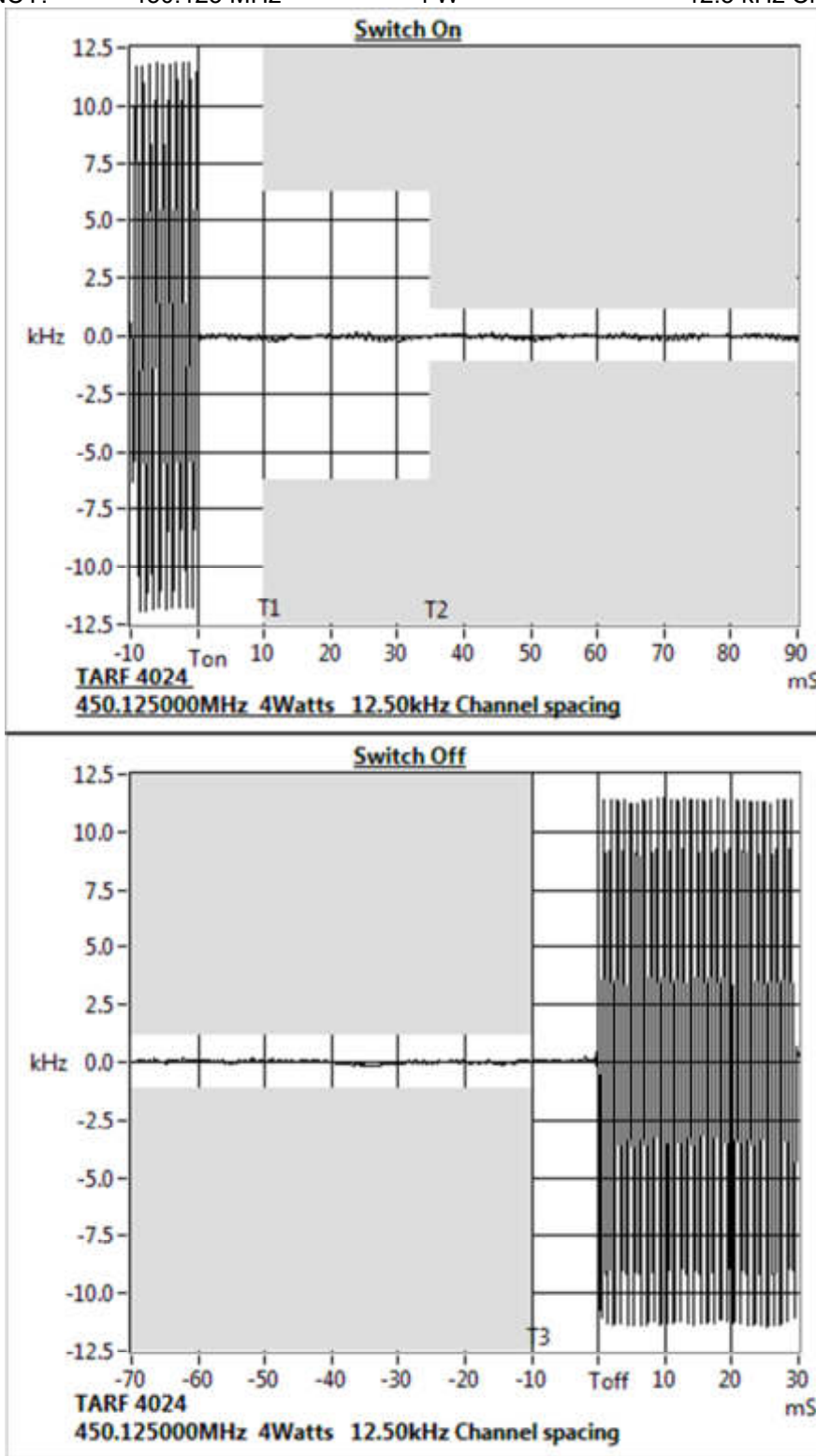



### Transient Frequency Behaviour

SPECIFICATION: FCC 47 CFR 90.214

Tx FREQUENCY: 454.5 MHz                      4 W                      12.5 kHz Channel Spacing

TRANSIENT RESPONSE PERIOD	CARRIER PEAK VARIATION FROM NORMAL	
	Key ON (kHz)	Key OFF (kHz)
t1	-0.2	N/A
t2	-0.2	N/A
t3	N/A	0.2

Confirm that during periods t1 and t3 the frequency difference does not exceed the value of one channel separation.	YES	NO
	✓	<input type="checkbox"/>
Confirm that during the period t2 the frequency difference does not exceed half a channel separation.	YES	NO
	✓	<input type="checkbox"/>
Confirm that during the period t2 to t3 the frequency difference does not exceed the frequency error limit.	YES	NO
	✓	<input type="checkbox"/>

Measurement Uncertainty:      Frequency  $\pm$  130 Hz;      Time  $\pm$  0.2%

LIMIT:                      FCC 47 CFR 90.214

TRANSIENT PERIODS	FREQUENCY RANGE	
	150 MHz – 174 MHz	421 MHz – 512 MHz
t1 (ms)	5 ms	10 ms
t2 (ms)	20 ms	25 ms
t3 (ms)	5 ms	10 ms

LIMIT:                      RSS-119 5.9

Transient Frequency Behaviour for Equipment Designed to Operate on 12.5 kHz Channels			
TRANSIENT PERIODS	Maximum Frequency Difference	FREQUENCY RANGE	
		138 – 174 MHz	406.1 – 470 MHz
t1 (ms)	$\pm$ 12.5 kHz	5 ms	10 ms
t2 (ms)	$\pm$ 6.25 kHz	20 ms	25 ms
t3 (ms)	$\pm$ 12.5 kHz	5 ms	10 ms

Note: RSS-119 5.9 - If the transmitter carrier output power rating is 6 Watts or less, the frequency difference during the time periods t1 and t3 may exceed the maximum frequency difference for these time periods,

### Transient Frequency Behavior

SPECIFICATION: FCC 47 CFR 90.214

Tx FREQUENCY: 454.5 MHz                      4 W                      12.5 kHz Channel Spacing

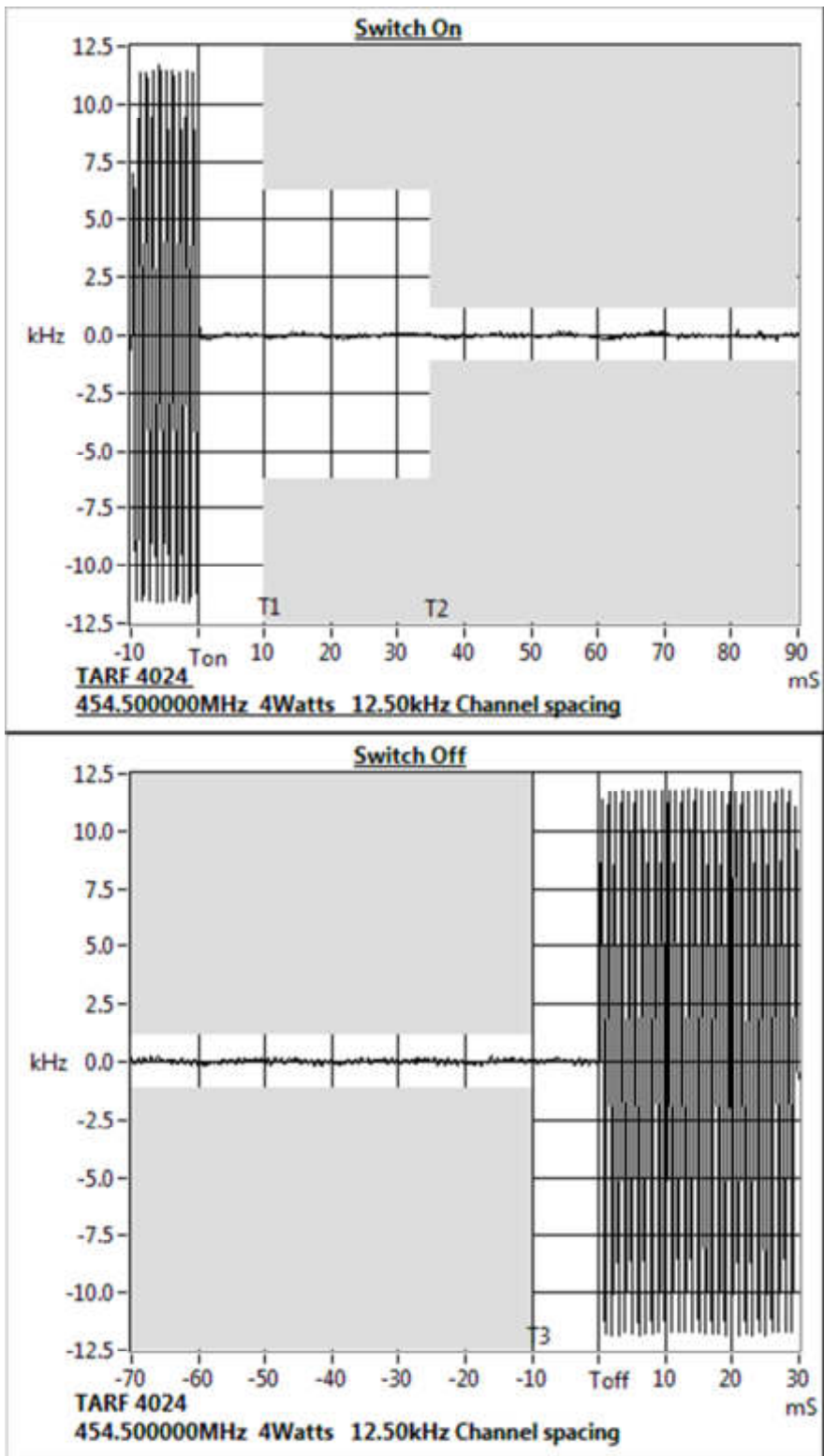

### Transient Frequency Behaviour

SPECIFICATION: FCC 47 CFR 90.214

RSS-119 5.9

Tx FREQUENCY: 459.9 MHz

4 W

12.5 kHz Channel Spacing

TRANSIENT RESPONSE PERIOD	CARRIER PEAK VARIATION FROM NORMAL	
	Key ON (kHz)	Key OFF (kHz)
t1	0.6	N/A
t2	0.2	N/A
t3	N/A	-1.1

Confirm that during periods t1 and t3 the frequency difference does not exceed the value of one channel separation.	YES	NO
	✓	<input type="checkbox"/>
Confirm that during the period t2 the frequency difference does not exceed half a channel separation.	YES	NO
	✓	<input type="checkbox"/>
Confirm that during the period t2 to t3 the frequency difference does not exceed the frequency error limit.	YES	NO
	✓	<input type="checkbox"/>

Measurement Uncertainty: Frequency  $\pm$  130 Hz; Time  $\pm$  0.2%

LIMIT: FCC 47 CFR 90.214

TRANSIENT PERIODS	FREQUENCY RANGE	
	150 MHz – 174 MHz	421 MHz – 512 MHz
t1 (ms)	5 ms	10 ms
t2 (ms)	20 ms	25 ms
t3 (ms)	5 ms	10 ms

LIMIT: RSS-119 5.9

Transient Frequency Behaviour for Equipment Designed to Operate on 12.5 kHz Channels			
TRANSIENT PERIODS	Maximum Frequency Difference	FREQUENCY RANGE	
		138 – 174 MHz	406.1 – 470 MHz
t1 (ms)	$\pm$ 12.5 kHz	5 ms	10 ms
t2 (ms)	$\pm$ 6.25 kHz	20 ms	25 ms
t3 (ms)	$\pm$ 12.5 kHz	5 ms	10 ms

Note: RSS-119 5.9 - If the transmitter carrier output power rating is 6 Watts or less, the frequency difference during the time periods t1 and t3 may exceed the maximum frequency difference for these time periods.

### Transient Frequency Behaviour

SPECIFICATION: FCC 47 CFR 90.214

RSS-119 5.9

Tx FREQUENCY: 459.9 MHz

4 W

12.5 kHz Channel Spacing

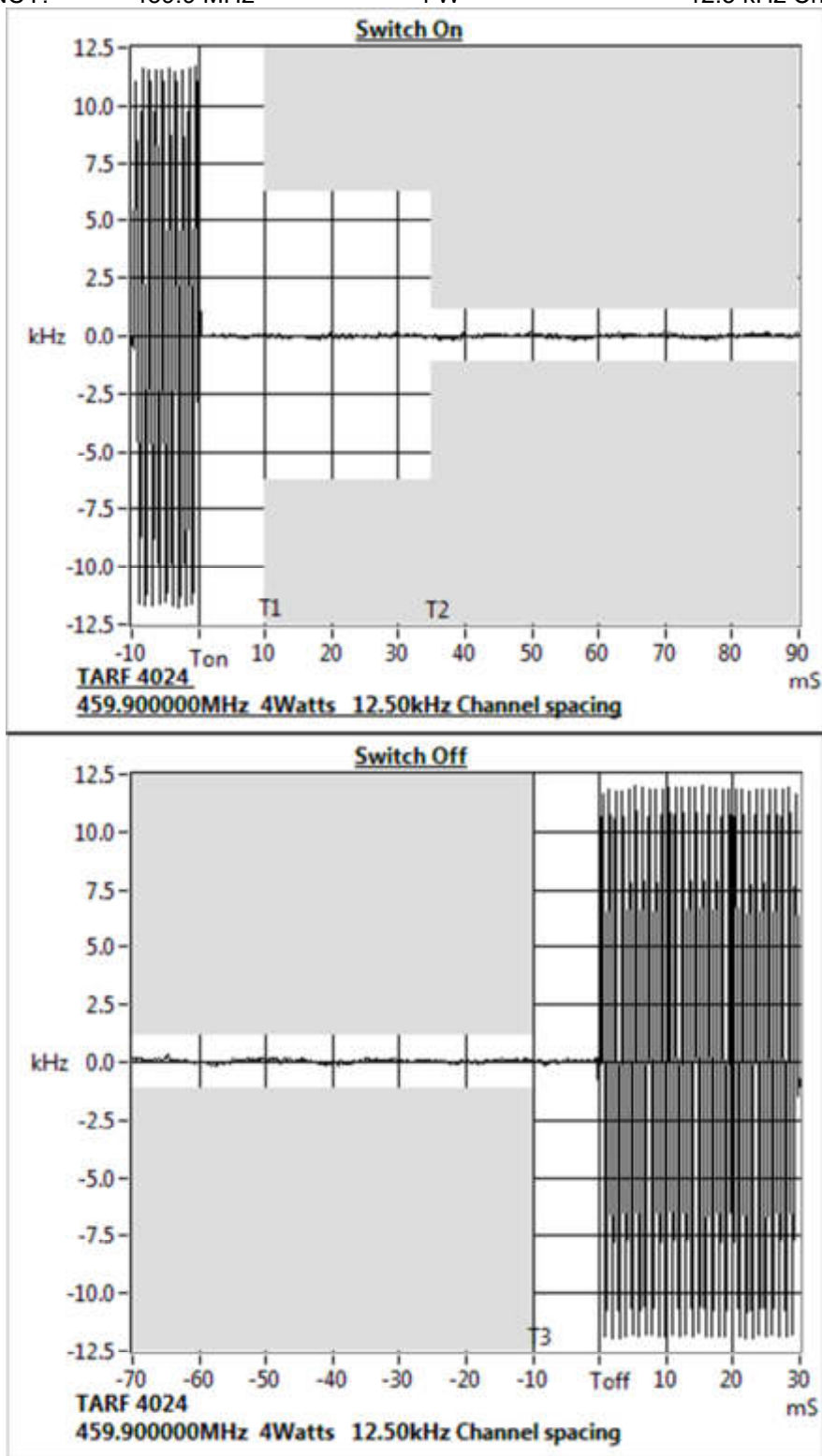

### Transient Frequency Behaviour

SPECIFICATION: FCC 47 CFR 90.214

RSS-119 5.9

Tx FREQUENCY: 465.1 MHz 4 W 12.5 kHz Channel Spacing

TRANSIENT RESPONSE PERIOD	CARRIER PEAK VARIATION FROM NORMAL	
	Key ON (kHz)	Key OFF (kHz)
t1	-0.3	N/A
t2	-0.2	N/A
	N/A	4.7

Confirm that during periods t1 and t3 the frequency difference does not exceed the value of one channel separation.	YES	NO
	✓	<input type="checkbox"/>
Confirm that during the period t2 the frequency difference does not exceed half a channel separation.	YES	NO
	✓	<input type="checkbox"/>
Confirm that during the period t2 to t3 the frequency difference does not exceed the frequency error limit.	YES	NO
	✓	<input type="checkbox"/>

Measurement Uncertainty: Frequency  $\pm$  130 Hz; Time  $\pm$  0.2%

LIMIT: FCC 47 CFR 90.214

TRANSIENT PERIODS	FREQUENCY RANGE	
	150 MHz – 174 MHz	421 MHz – 512 MHz
t1 (ms)	5 ms	10 ms
t2 (ms)	20 ms	25 ms
t3 (ms)	5 ms	10 ms

LIMIT: RSS-119 5.9

Transient Frequency Behaviour for Equipment Designed to Operate on 12.5 kHz Channels			
TRANSIENT PERIODS	Maximum Frequency Difference	FREQUENCY RANGE	
		138 – 174 MHz	406.1 – 470 MHz
t1 (ms)	$\pm$ 12.5 kHz	5 ms	10 ms
t2 (ms)	$\pm$ 6.25 kHz	20 ms	25 ms
t3 (ms)	$\pm$ 12.5 kHz	5 ms	10 ms

Note: RSS-119 5.9 - If the transmitter carrier output power rating is 6 Watts or less, the frequency difference during the time periods t1 and t3 may exceed the maximum frequency difference for these time periods.

### Transient Frequency Behaviour

SPECIFICATION: FCC 47 CFR 90.214

RSS-119 5.9

Tx FREQUENCY: 465.1 MHz 4 W 12.5 kHz Channel Spacing

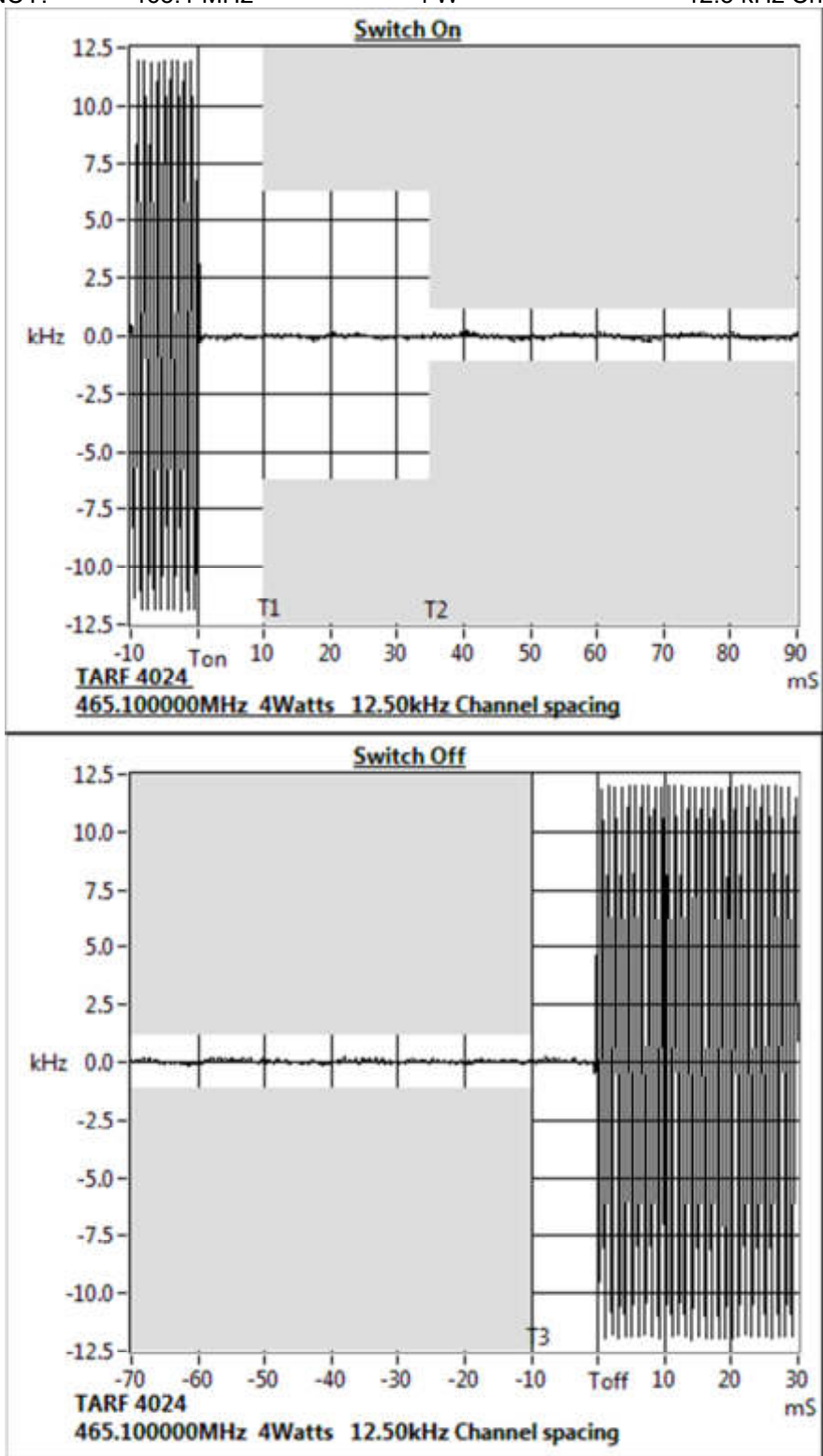

### Transient Frequency Behaviour

SPECIFICATION: FCC 47 CFR 90.214

RSS-119 5.9

Tx FREQUENCY: 469.9 MHz

4 W

12.5 kHz Channel Spacing

TRANSIENT RESPONSE PERIOD	CARRIER PEAK VARIATION FROM NORMAL	
	Key ON (kHz)	Key OFF (kHz)
t1	0.2	N/A
t2	0.2	N/A
t3	N/A	0.6

Confirm that during periods t1 and t3 the frequency difference does not exceed the value of one channel separation.	YES	NO
	✓	<input type="checkbox"/>
Confirm that during the period t2 the frequency difference does not exceed half a channel separation.	YES	NO
	✓	<input type="checkbox"/>
Confirm that during the period t2 to t3 the frequency difference does not exceed the frequency error limit.	YES	NO
	✓	<input type="checkbox"/>

Measurement Uncertainty: Frequency  $\pm$  130 Hz; Time  $\pm$  0.2%

LIMIT: FCC 47 CFR 90.214

TRANSIENT PERIODS	FREQUENCY RANGE	
	150 MHz – 174 MHz	421 MHz – 512 MHz
t1 (ms)	5 ms	10 ms
t2 (ms)	20 ms	25 ms
t3 (ms)	5 ms	10 ms

LIMIT: RSS-119 5.9

Transient Frequency Behaviour for Equipment Designed to Operate on 12.5 kHz Channels			
TRANSIENT PERIODS	Maximum Frequency Difference	FREQUENCY RANGE	
		138 – 174 MHz	406.1 – 470 MHz
t1 (ms)	$\pm$ 12.5 kHz	5 ms	10 ms
t2 (ms)	$\pm$ 6.25 kHz	20 ms	25 ms
t3 (ms)	$\pm$ 12.5 kHz	5 ms	10 ms

Note: RSS-119 5.9 - If the transmitter carrier output power rating is 6 Watts or less, the frequency difference during the time periods t1 and t3 may exceed the maximum frequency difference for these time periods.

### Transient Frequency Behaviour

SPECIFICATION: FCC 47 CFR 90.214

RSS-119 5.9

Tx FREQUENCY: 469.9 MHz

4 W

12.5 kHz Channel Spacing

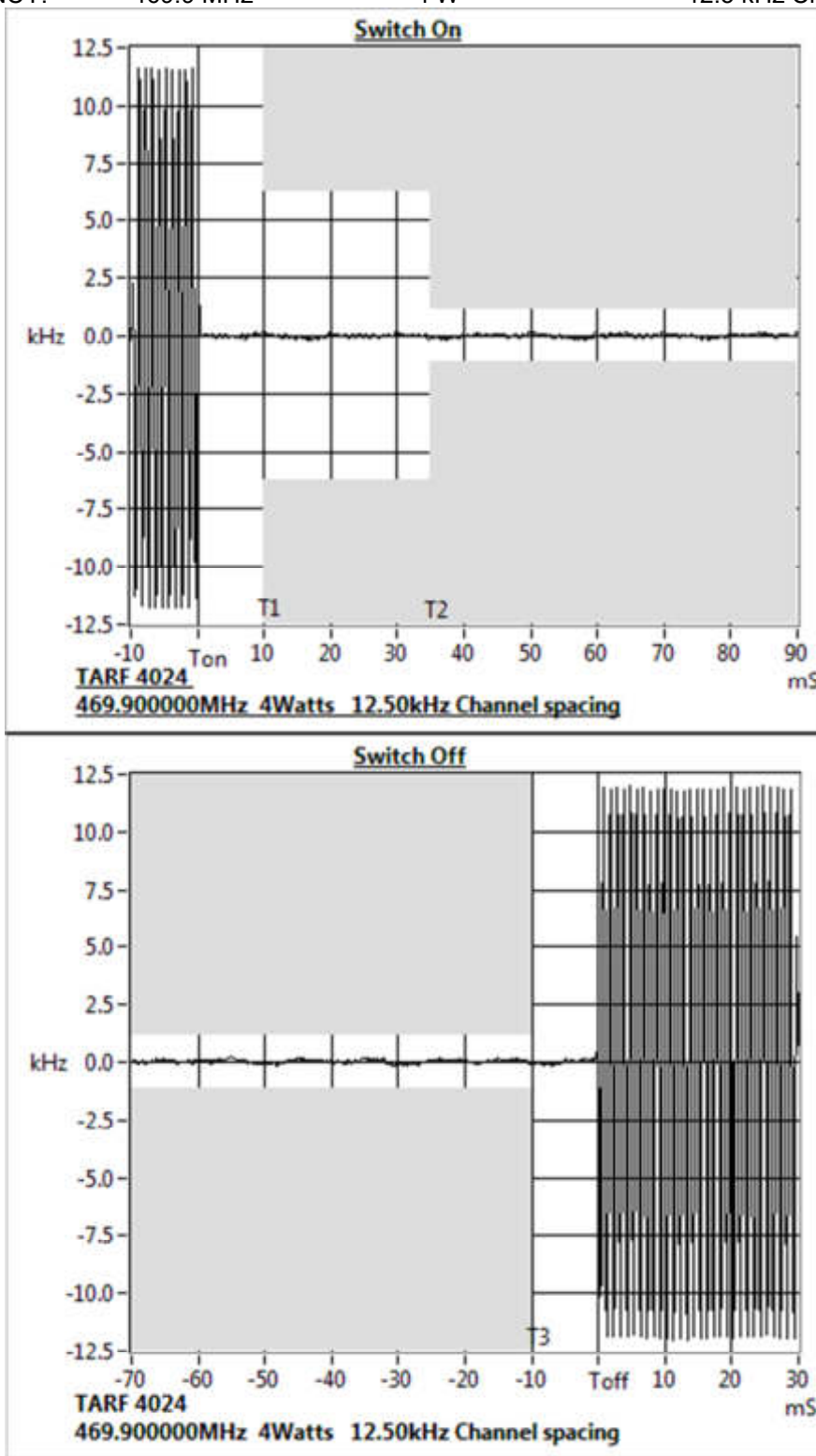



### Transient Frequency Behaviour

SPECIFICATION: FCC 47 CFR 90.214

RSS-119 5.9

Tx FREQUENCY: 511.9 MHz 4 W 12.5 kHz Channel Spacing

TRANSIENT RESPONSE PERIOD	CARRIER PEAK VARIATION FROM NORMAL	
	Key ON (kHz)	Key OFF (kHz)
t1	1.0	N/A
t2	0.2	N/A
t3	N/A	-2.3

Confirm that during periods t1 and t3 the frequency difference does not exceed the value of one channel separation.	YES	NO
	✓	<input type="checkbox"/>
Confirm that during the period t2 the frequency difference does not exceed half a channel separation.	YES	NO
	✓	<input type="checkbox"/>
Confirm that during the period t2 to t3 the frequency difference does not exceed the frequency error limit.	YES	NO
	✓	<input type="checkbox"/>

Measurement Uncertainty: Frequency  $\pm$  130 Hz; Time  $\pm$  0.2%

LIMIT: FCC 47 CFR 90.214

TRANSIENT PERIODS	FREQUENCY RANGE	
	150 MHz – 174 MHz	421 MHz – 512 MHz
t1 (ms)	5 ms	10 ms
t2 (ms)	20 ms	25 ms
t3 (ms)	5 ms	10 ms

LIMIT: RSS-119 5.9

Transient Frequency Behaviour for Equipment Designed to Operate on 12.5 kHz Channels			
TRANSIENT PERIODS	Maximum Frequency Difference	FREQUENCY RANGE	
		138 – 174 MHz	406.1 – 470 MHz
t1 (ms)	$\pm$ 12.5 kHz	5 ms	10 ms
t2 (ms)	$\pm$ 6.25 kHz	20 ms	25 ms
t3 (ms)	$\pm$ 12.5 kHz	5 ms	10 ms

Note: RSS-119 5.9 - If the transmitter carrier output power rating is 6 Watts or less, the frequency difference during the time periods t1 and t3 may exceed the maximum frequency difference for these time periods.

### Transient Frequency Behaviour

SPECIFICATION: FCC 47 CFR 90.214

RSS-119 5.9

Tx FREQUENCY: 511.9 MHz 4 W

12.5 kHz Channel Spacing

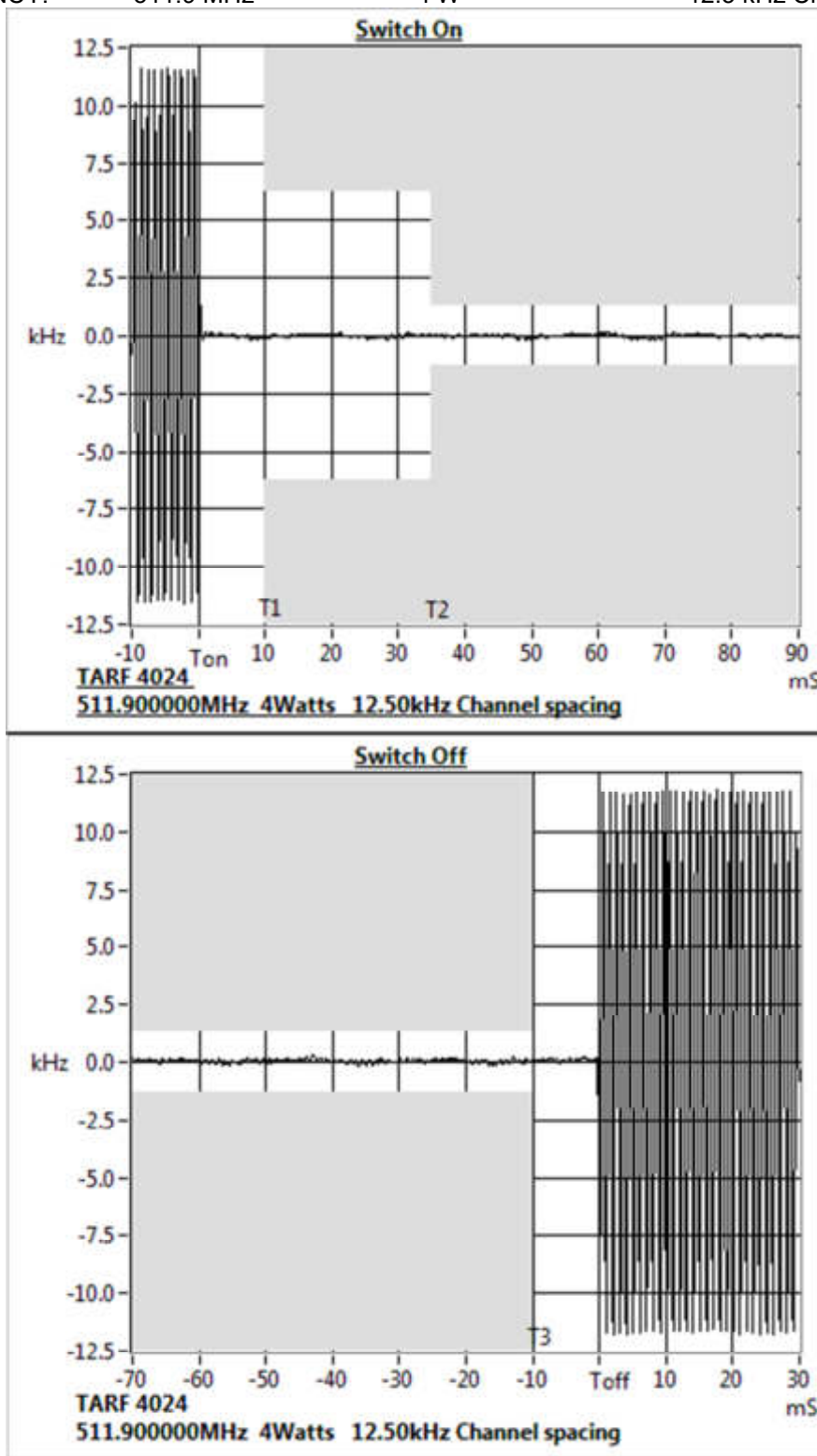

## TRANSMITTER FREQUENCY STABILITY - TEMPERATURE

SPECIFICATION: FCC 47 CFR 2.1055 (a) (1)

RSS-119 5.3

GUIDE: ANSI C63.26 5.6.4

### MEASUREMENT PROCEDURE:

1. Refer Annex A for equipment set up.
2. The EUT was tested for frequency error from  $-30^{\circ}\text{C}$  to  $+50^{\circ}\text{C}$  in  $10^{\circ}\text{C}$  increments
3. The frequency error was recorded in parts per million (ppm).

### MEASUREMENT RESULTS:

See the plots on the following pages for 12.5 kHz channel spacing.

#### 450.125 MHz

Temperature ( $^{\circ}\text{C}$ )	Frequency (Hz)	Error (ppm)
-30	-57	-0.13
-20	-52	-0.12
-10	-9	-0.02
0	-36	-0.08
10	-56	-0.12
20	-6	-0.01
30	22	0.05
40	30	0.07
50	61	0.14
Measurement Uncertainty	$\pm 7 \times 10^{-8}$	

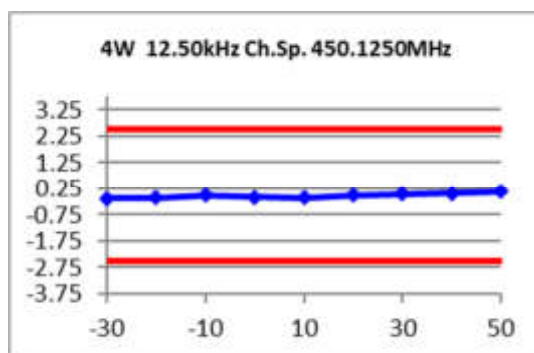

Transmitter Frequency Stability – Temperature

454.5 MHz

Temperature (°C)	Frequency (Hz)	Error (ppm)
-30	-50	-0.11
-20	-54	-0.12
-10	-1	0
0	-43	-0.09
10	-51	-0.11
20	2	0
30	25	0.06
40	38	0.08
50	67	0.15
Measurement Uncertainty	$\pm 7 \times 10^{-8}$	

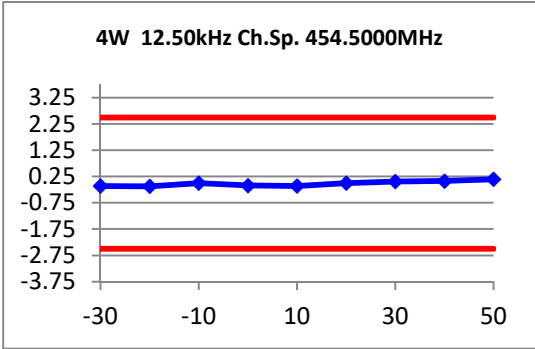

Transmitter Frequency Stability – Temperature

459.9 MHz

Temperature (°C)	Frequency (Hz)	Error (ppm)
-30	-46	-0.1
-20	-46	-0.1
-10	7	0.02
0	-46	-0.1
10	-40	-0.09
20	13	0.03
30	34	0.07
40	44	0.1
50	77	0.17
Measurement Uncertainty	$\pm 7 \times 10^{-8}$	

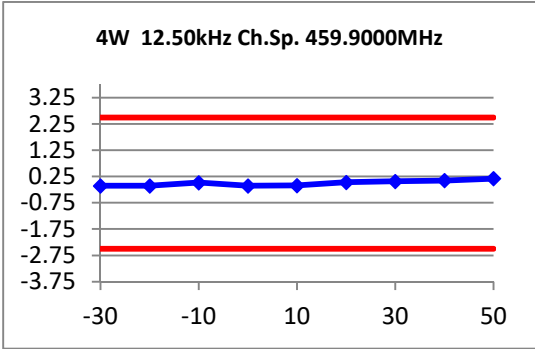

Transmitter Frequency Stability – Temperature

465.1 MHz

Temperature (°C)	Frequency (Hz)	Error (ppm)
-30	-51	-0.11
-20	-44	-0.09
-10	5	0.01
0	-55	-0.12
10	-31	-0.07
20	19	0.04
30	34	0.07
40	42	0.09
50	76	0.16
Measurement Uncertainty	$\pm 7 \times 10^{-8}$	

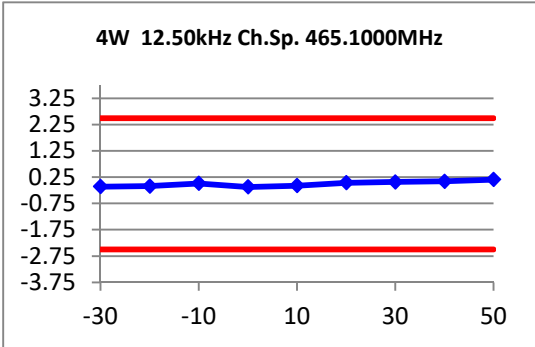

Transmitter Frequency Stability – Temperature

469.9 MHz

Temperature (°C)	Frequency (Hz)	Error (ppm)
-30	-54	-0.11
-20	-43	-0.09
-10	1	0
0	-63	-0.13
10	-36	-0.08
20	15	0.03
30	30	0.06
40	47	0.1
50	76	0.16
Measurement Uncertainty	$\pm 7 \times 10^{-8}$	

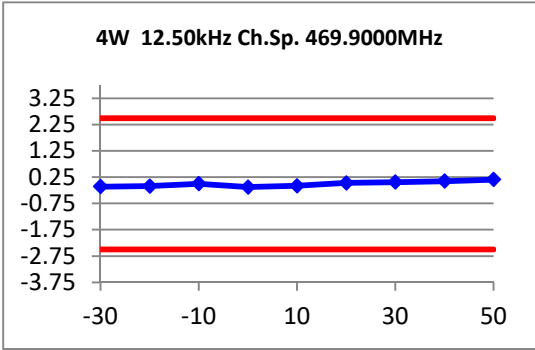

Transmitter Frequency Stability – Temperature

511.9 MHz

Temperature (°C)	Frequency (Hz)	Error (ppm)
-30	-59	-0.12
-20	-37	-0.07
-10	2	0
0	-62	-0.12
10	-28	-0.05
20	22	0.04
30	42	0.08
40	62	0.12
50	88	0.17
Measurement Uncertainty	$\pm 7 \times 10^{-8}$	

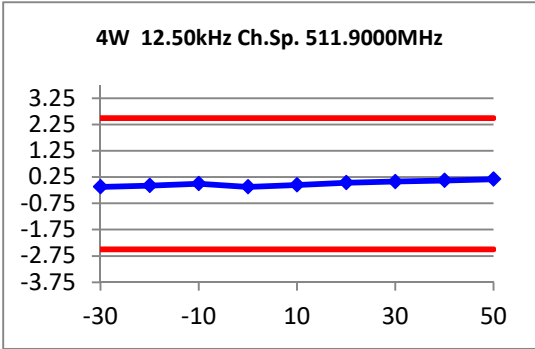



TELTEST Laboratories  
Tait International Ltd  
Report Number 4024

LIMIT: FCC 47 CFR 90.213 RSS-119 5.3

Channel Spacing (kHz)	Frequency Error (ppm)
12.5	2.5

## TRANSMITTER FREQUENCY STABILITY - VOLTAGE

SPECIFICATION: FCC 47 CFR 2.1055 (d) (1)

RSS-119 5.3  
RSS-Gen 6.11

GUIDE: ANSI C63.26 5.6.5

**MEASUREMENT PROCEDURE:**

1. Refer Annex A for equipment set up.
2. The EUT was tested for frequency error at an input voltage to the radio of nominal battery voltage and battery end point .
3. The frequency error was recorded in parts per million (ppm).

**MEASUREMENT RESULTS:**

	FREQUENCY ERROR (ppm) for 12.5 kHz		
	7.5 V <sub>DC</sub>	6.375 V <sub>DC</sub>	7.5 V <sub>DC</sub>
450.125 MHz	0.05	0.05	0.05
454.5 MHz	0.10	0.10	0.11
459.9 MHz	0.11	0.12	0.12
465.1 MHz	0.01	0.00	0.01
469.9 MHz	0.13	0.13	0.13
511.9 MHz	0.13	0.13	0.14
Measurement Uncertainty	$\pm 7 \times 10^{-8}$		

LIMIT CLAUSES: FCC 47 CFR 90.213 RSS-119 5.3

Channel Spacing (kHz)	Frequency Error (ppm)
12.5	2.5

## RECEIVER SPURIOUS EMISSIONS (CONDUCTED)

SPECIFICATION: RSS-119 5.8

GUIDE: TIA/EIA-603E 2.1.2

### MEASUREMENT PROCEDURE:

1. Refer Annex A for Equipment set up diagram.
2. The frequency range examined was from 30 MHz to 3 times highest tunable frequency.
3. Spurious emissions which were attenuated more than 20 dB below the limit were not recorded.
4. A scan is performed with a resolution bandwidth of 100 kHz and a video bandwidth of 30 kHz for frequencies up to 1 GHz, and a resolution bandwidth of 1 MHz and a video bandwidth of 3 MHz for frequencies above 1 GHz
5. For each frequency range the spectrum analyser was loaded with the appropriate calibration figures to compensate for the cables and attenuator losses allowing the emission levels to be read directly with no further calculation .

Spurious emissions which were attenuated by more than 20 dB below the limit were not recorded.

Example of attenuation correction:

30dB 350W CK9178	32.69	
2m5 Blue 33449	1.29	
3m Blue 503429	1.16	
Total Attenuation @ 2.119G Hz	37.19	Sum of component attenuation (a)
Amplitude offset	37.42	(b)
Correction @ 2.119G Hz	-0.23	(a-b)

Measurement Uncertainty	≤12.75 GHz ± 3.0 dB
-------------------------	---------------------

Receiver Spurious Emissions (Conducted) – Continued

450.125 MHz Receive, 450.125 MHz Tx standby		
Emission Frequency (MHz)	Level (nW)	Level (dBm)
~	~	~
No emissions were detected within 20 dB of Limit.		

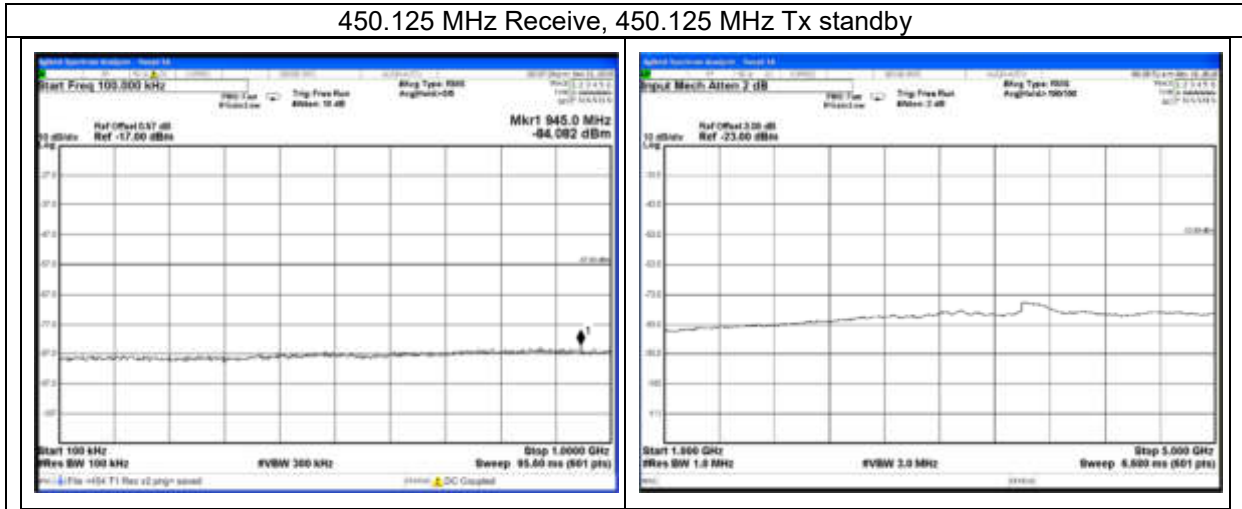

454.5 MHz Receive, 454.5 MHz Tx standby		
Emission Frequency (MHz)	Level (nW)	Level (dBm)
~	~	~
No emissions were detected within 20 dB of Limit.		

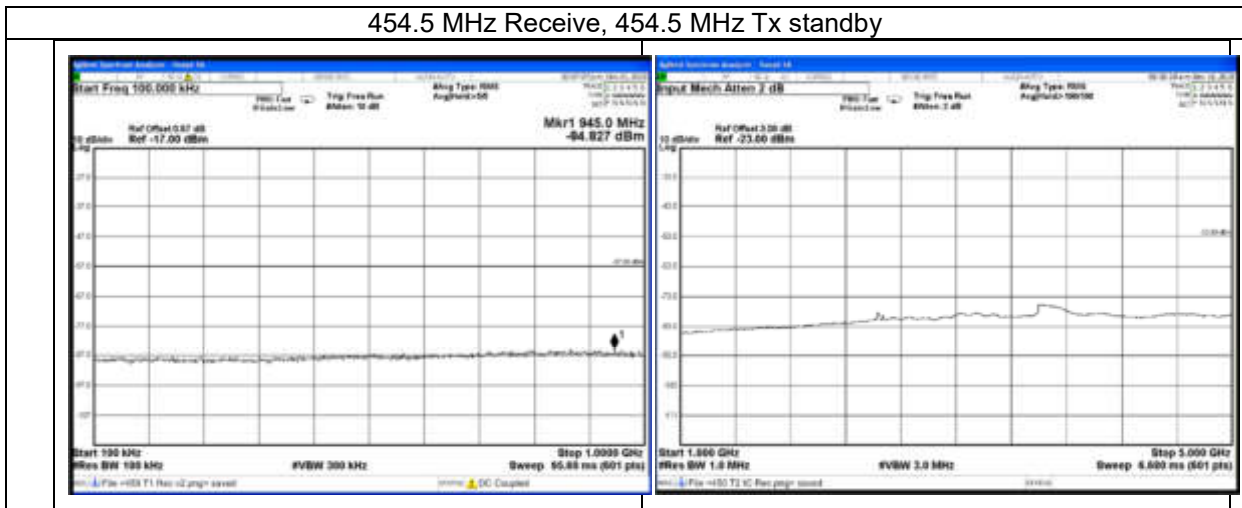

459.9 MHz Receive, 459.9 MHz Tx standby		
Emission Frequency (MHz)	Level (nW)	Level (dBm)
~	~	~
No emissions were detected within 20 dB of Limit.		

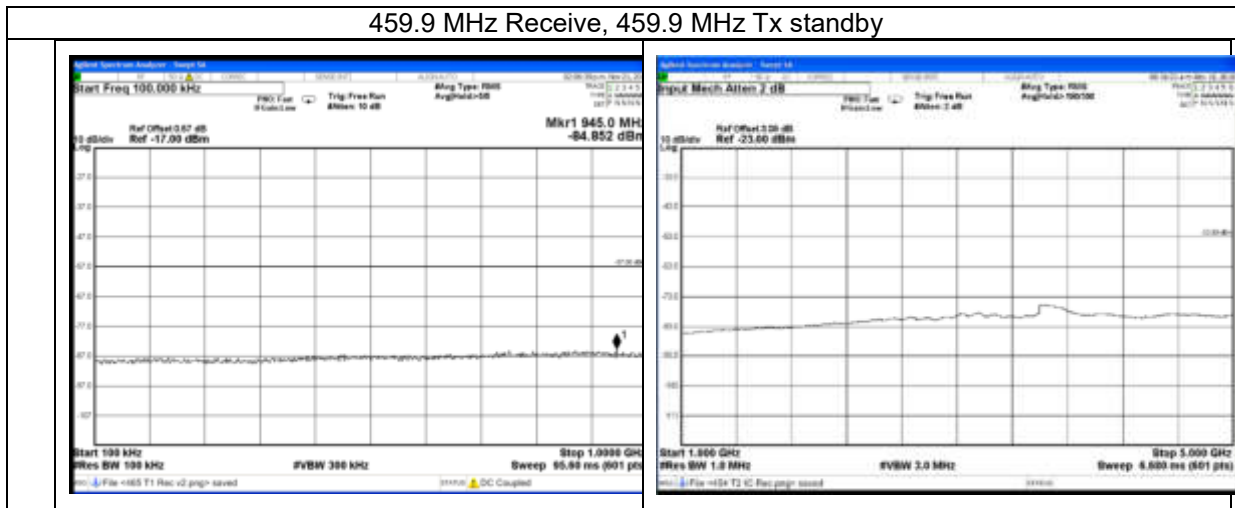

465.1 MHz Receive, 465.1 MHz Tx standby		
Emission Frequency (MHz)	Level (nW)	Level (dBm)
~	~	~

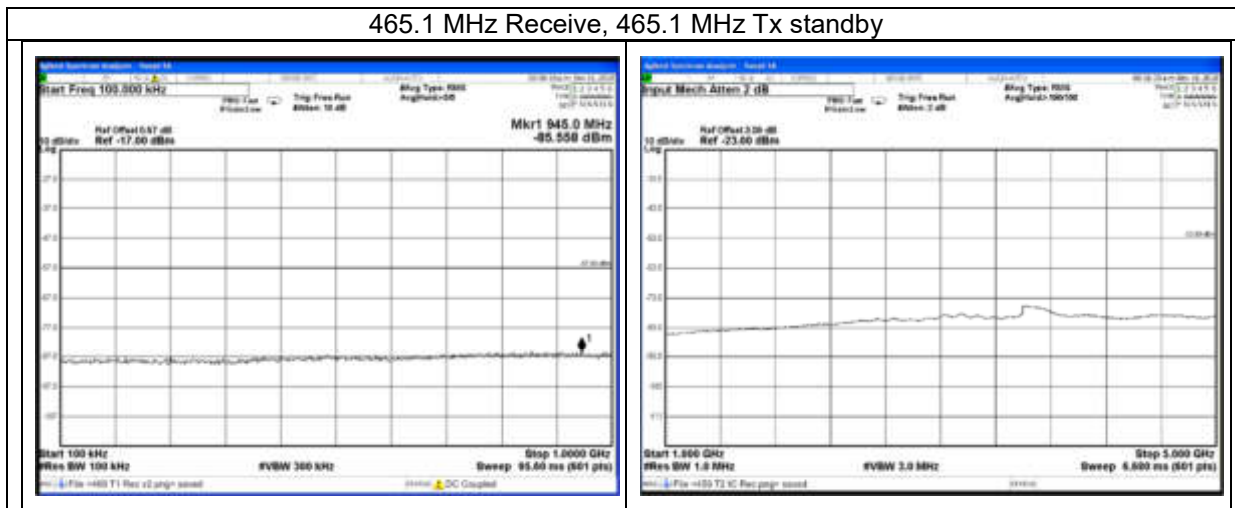

Receiver Spurious Emissions (Conducted) – Continued

469.9 MHz Receive, 469.9 MHz Tx standby		
Emission Frequency (MHz)	Level (nW)	Level (dBm)
~	~	~
No emissions were detected within 20 dB of Limit.		

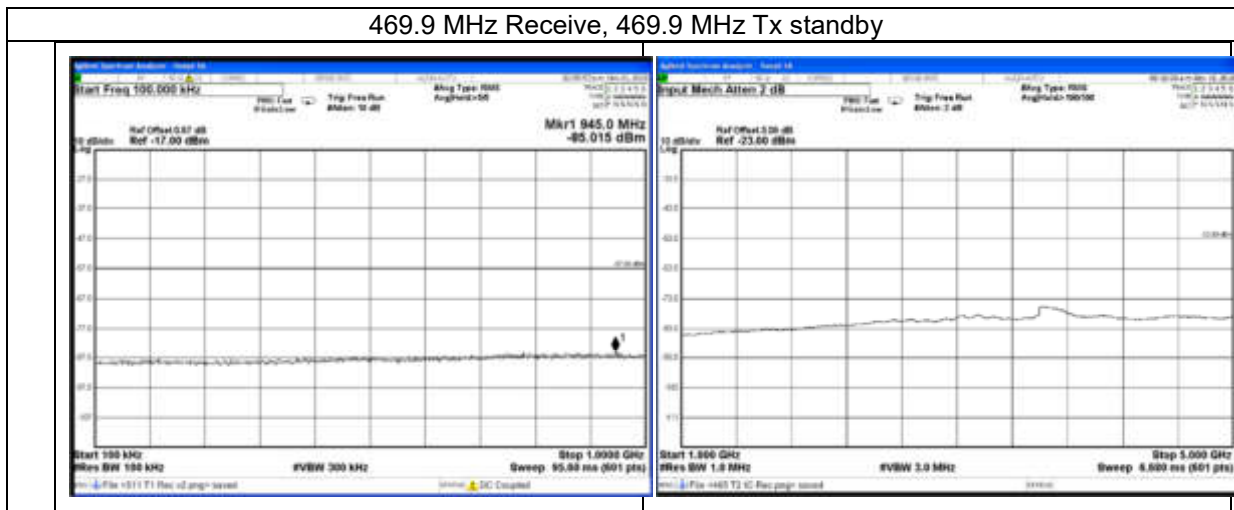

511.9 MHz Receive, 511.9 MHz Tx standby		
Emission Frequency (MHz)	Level (nW)	Level (dBm)
~	~	~
No emissions were detected within 20 dB of Limit.		

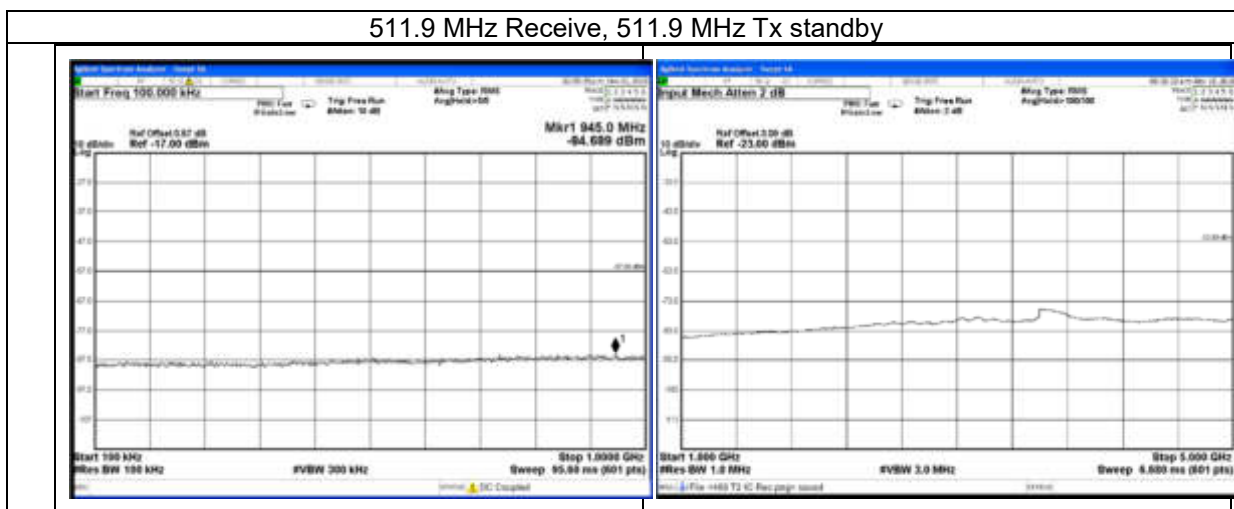

## TEST EQUIPMENT LIST

Equipment Type	Information	Manufacturer	Model No	Serial No#	Tait ID	Cal Due
Antenna	18GHz DRG	Emco	DRG3115	2084	E3076	
Antenna	18GHz DRG	Emco	DRG3115	9512-4638	E3560	15-May-20
Antenna	Reverb - 1-18GHz DRG	Schwarzbeck	BBHA 9120 D	9120D-885	E4857	
Antenna	Reverb - 1-18GHz DRG	Schwarzbeck	BBHA 9120 D	9120D-884	E4858	
Audio Analyser	TREVA1	Hewlett Packard	HP8903A	2437A04625	E4986	3-Oct-20
Coax Cable	2.5m Blue	Suhner	Sucoflex 104A	33449/4PEA	E4997	23-Oct-20
Coax Cable	3m Blue	Suhner	Sucoflex 126EA	503429/126EA	E5015	23-Oct-20
Coax Cable	OATS Turntable Cable 1	Intelcom	RG214	OATS1	E4621	28-Oct-20
Coax Cable	OATS Tower Cable	Intelcom	RG214	OATS2	E4622	28-Oct-20
Coax Cable	2m Black	Suhner	RG214HF/Nm/Nm/2000	TeltestBlack2	E4623	23-Oct-20
Coax Cable	2m Black	Suhner	RG214HF/Nm/Nm/2000	TeltestBlack3	E4624	23-Oct-20
Coax Cable	Reverb - 4.5m Multiflex 141	TeltestBlue6	MF 141	TeltestBlue6	E4843	24-Oct-20
Coax Cable	Reverb - 2m Multiflex 141	TeltestBlue5	MF 141	TeltestBlue5	E4844	24-Oct-20
Coax Cable	Reverb - 2m Multiflex 141	TeltestBlue4	MF 141	TeltestBlue4	E4845	24-Oct-20
Coax Cable	Reverb - 1m Multiflex 141	TeltestBlue3	MF 141	TeltestBlue3	E4846	24-Oct-20
Coax Cable	Reverb - 1m Multiflex 141	TeltestBlue2	MF 141	TeltestBlue2	E4847	24-Oct-20
Coax Cable	Reverb - 1m Multiflex 141	TeltestBlue1	MF 141	TeltestBlue1	E4848	24-Oct-20
Coax Cable	2m Black	Suhner	RG214HF/Nm/Nm/2000	TeltestBlack6	E4849	23-Oct-20
Coax Cable	2m Black	Suhner	RG214HF/Nm/Nm/2000	TeltestBlack5	E4850	23-Oct-20
Coax Cable	OATS Turntable Cable 2	Intelcom	RG215	OATS3	E4995	28-Oct-20
Coax Cable	2m Black	Suhner	RG214HF/Nm/Nm/2000	TeltestBlack7	E5004	28-Oct-20
Environ. Chamber	Upright	Contherm	5400 RHSLT.M	1416	E4051	7-Aug-23
Environ. Chamber	Upright	Contherm	5400 RHSLT.M	1416	E4051	15-May-20
Filter High Pass/ Notch	400 to 520MHz	Tait		N/A	E3384	3-Oct-20
Modulation Analyser	43740	Hewlett Packard	HP8901B (Opt 002)	2441A00393	E3073	3-Oct-20
OATS	Controller	Electrometrics	EM-4700	119	E4445	
OATS	Turntable	Electrometrics	EM-4704A	105	E4446	
OATS	Antenna Tower	Electrometrics	EM-4720-2	112	E4447	
OATS	NSA	Tait				18-Jun-20
Oscilloscope	100MHz Digital	Tektronics	TDS340	B013611	E3585	3-Oct-21
Power Meter	TREVA1 Power Head for HP8901	Hewlett Packard	HP11722A	3111A05573	E7054	30-Sep-20
Power Supply	TREVA1	Agilent	HP6032A	MY41000319	E4045	24-Sep-20
RF Amplifier	+21.7 dB 1GHz	Tait	ZFL-1000LN	E3660	E3360	30-Apr-20
RF Amplifier	Pre-amplifier	Agilent	87405C	MY47010688	E4941	14-Oct-20
RF Attenuator	10dB 50W	Weinschel	24-10-34	AZ0401	E3388	24-Oct-20
RF Attenuator	33dB 350W	Weinschel	67-30-33 & BW-N3W5+	CK9178	E5023	15-Jul-20
RF Attenuator	TREVA1 3dB	Weinschel	Model 1	BL9958	E4081	24-Oct-20

TELTEST Laboratories  
Tait International Ltd  
Report Number 4024

RF Attenuator	TREVA 1 20dB 150W	Weinschel	40-20-23	MF817	E4082	28-Oct-20
<b>Equipment Type</b>	<b>Information</b>	<b>Manufacturer</b>	<b>Model No</b>	<b>Serial No#</b>	<b>Tait ID</b>	<b>Cal Due</b>
RF Attenuator	3dB 0.5W	Weinschel	Model 2	CH6857	E5012	23-Oct-20
RF Chamber	S-LINE TEM CELL	Rohde & Schwarz	1089.9296.02	338232/003	E3636	12-Sep-20
RF Chamber	Reverb - Stirrer controller for reverb chamber	Teseq	Stirrer Controller	29765.1	E4854	
RF Chamber	Reverb - 0.5 - 18GHz Reverberation Chamber	Teseq	RVC XS	29765	E4855	
RF Combiner	TREVA1	Minicircuits	ZFSC-4-1	-	E4083	
RF Load	50W	Weinschel	F1426	AE2490	E3624	22-Oct-20
Signal Generator	Analog 4GHz	Agilent	E4422B	GB40050320	E3788	10-Oct-20
Signal Generator	Digital 3GHz	Agilent	E4438C	MY49070242	E4657	9-Oct-21
Signal Generator	TREVA1 Analog 3.2GHz	Agilent	E8663D	MY50420224	E4908	2-Oct-20
Spectrum Analyser	13.2GHz	Agilent	E4445A	MY42510072	E4139	19-Jul-20
Spectrum Analyser	26.5GHz	Agilent	PXA N9030A	MY49432161	E4907	27-Oct-20
Spectrum Analyser	13.2GHz	Agilent	E4445A	MY42510072	E4139	19-Jul-20
Temp & Humidity datalogger		Hobo	U21-011	10134275	E4980	5-May-20
TREVA 1		Teltest	-	1	-	5-Nov-19
Testware	Frequency Vs Temperature		April 2018	-	-	
Testware	Occupied Bandwidth		July 2019	-	-	
Testware	Radiated Emissions		April 2018	-	-	
Testware	Reverb Emissions		May 2019	-	-	
Testware	Sideband Spectrum		February 2017	-	-	
Testware	TREVA		7 February 2019	-	-	
Testware	Spec An Correction Loader		June 2019	-	-	

\* NOTE:

- All instruments were within their calibration period at time of testing.
- Items without calibration dates are calibrated immediately before use, or set using calibrated instruments.



### ANNEX A – TEST SETUP DETAILS

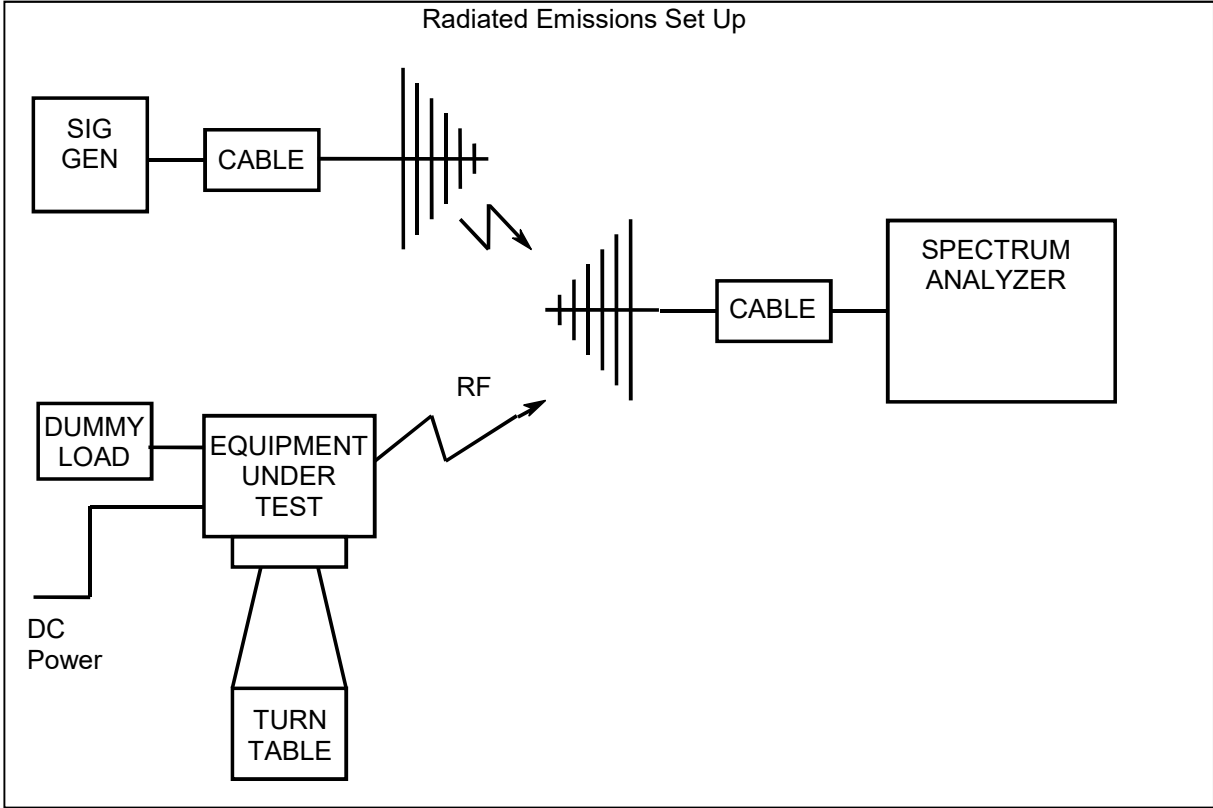

All other testing is performed using the Teltest **R**adio **E**VAuation system (TREVA), which is configured as shown below. The Spectrum Analyser is connected to the EUT via the attenuator network for Conducted Emissions testing, and Occupied Bandwidth.

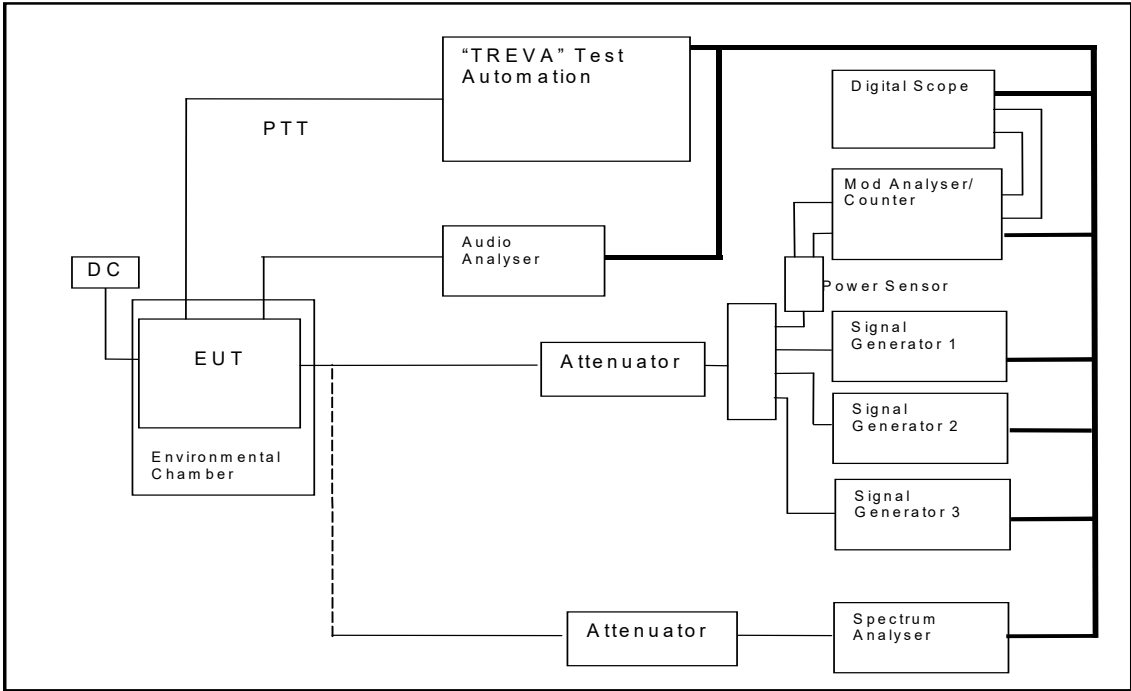

Photo showing the EUT connection to the test system using the customer supplied test box and battery eliminator.



## ANNEX B – Photographs



Bottom Front Right



**Top Rear Left**

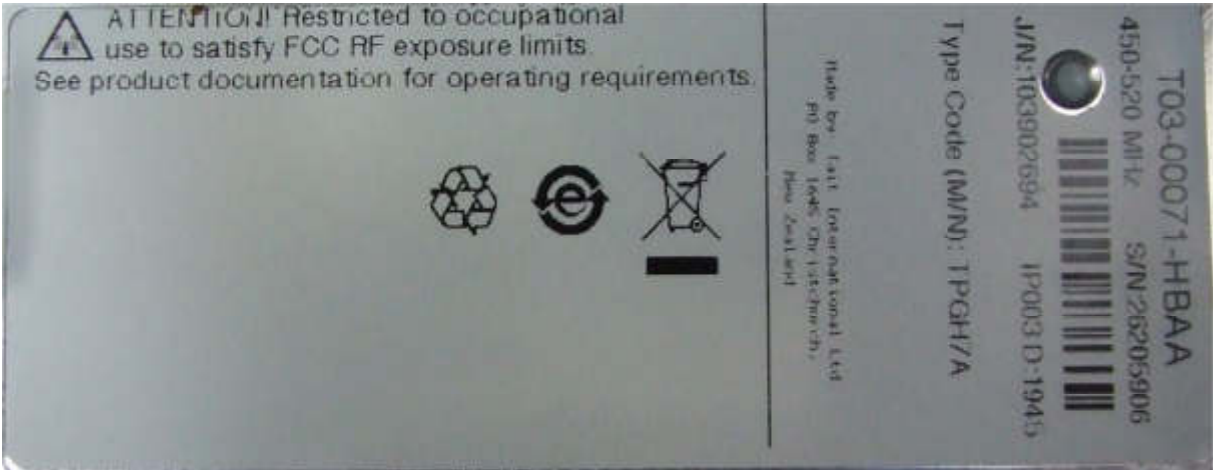

**Label on back**



**Label on bottom**

END OF REPORT