

# TP3300/TP3350 DMR Conventional Portable Radios User's Guide

MPE-00001-04 · Issue 4 · August 2021



## **User Guide Cross Reference**

T03-00312 series: Analog and DMR Tier 2 portable radios are elsewhere in this manual referred to as TP3300

T03-00313 series: Analog and DMR Tier 2 portable radios, with added GPS and BT functionality, are elsewhere in this manual referred to as TP3350

# Contents

For your safety.....	7
Menu map.....	19
<b>1 About this guide .....</b>	<b>20</b>
Safety warnings used in this guide .....	20
Related documentation.....	21
<b>2 Before using your radio .....</b>	<b>22</b>
Package Contents .....	23
For your safety—battery warning.....	24
Attaching labels to the radio or battery .....	24
Charging the battery before first use .....	25
Attaching the battery.....	26
Removing the battery .....	26
Attaching the antenna.....	27
Removing the antenna .....	27
Replacing the belt clip .....	27
Attaching an audio accessory.....	28
<b>3 Getting started .....</b>	<b>29</b>
About your DMR digital radio.....	30
About the radio controls.....	32
Understanding the radio display .....	34
Understanding the radio indicators.....	36
Using function keys to access frequently used features.....	38
Navigating the radio’s menus .....	39
<b>4 Operation.....</b>	<b>40</b>
Turning the radio on and off .....	41
Adjusting the speaker volume .....	42
Connecting to a Bluetooth® device (TP3350 only) .....	42
Answering a Call Alert .....	44
Selecting a zone .....	45
Selecting a channel .....	45
Changing a Channel.....	46
Making a group call .....	46
Making a private call.....	47
Turning scanning on and off .....	47
Making a call alert.....	48
Sending a quick text message.....	49
Sending an emergency alarm.....	51
Turning location information on and off (TP3350 only).....	52
<b>5 Charging and caring for batteries.....</b>	<b>53</b>

About the chargers .....	54
Before using the charger .....	54
Charging temperatures .....	55
Leaving the battery on charge .....	55
Receiving calls while charging.....	56
Low battery warning .....	56
Charging a battery for the first time .....	57
Charging a battery .....	57
LED behavior .....	58
Removing the battery from the charger .....	59
Maintaining battery life and performance .....	59
Storing batteries .....	59
Disposing of batteries .....	60
<b>6 Troubleshooting .....</b>	<b>61</b>
About troubleshooting.....	62
When your radio won't turn on.....	62
Identifying the radio's audible tones .....	62
Viewing radio information .....	62
General care.....	63
<b>Tait Software Licence Agreement.....</b>	<b>64</b>
<b>Simplified Declaration of Conformity .....</b>	<b>71</b>

# Copyright and trademarks

All information contained in this document is the property of Tait International Limited. All rights reserved. This document may not, in whole or in part, be copied, photocopied, reproduced, translated, stored, or reduced to any electronic medium or machine-readable form, without prior written permission from Tait International Limited.

The word TAIT and the TAIT logo are trademarks of Tait International Limited.

All trade names referenced are the service mark, trademark or registered trademark of the respective manufacturers.

# Disclaimer

There are no warranties extended or granted by this document. Tait International Limited accepts no responsibility for damage arising from use of the information contained in the document or of the equipment and software it describes. It is the responsibility of the user to ensure that use of such information, equipment and software complies with the laws, rules and regulations of the applicable jurisdictions.

# Enquiries and comments

If you have any enquiries regarding this document, or any comments, suggestions and notifications of errors, please contact your regional Tait office.

# Updates of manual and equipment

In the interests of improving the performance, reliability or servicing of the equipment, Tait International Limited reserves the right to update the equipment or this document or both without prior notice.

# Intellectual property rights

This product may be protected by one or more patents or designs of Tait International Limited together with their international equivalents, pending patent or design applications, and registered trade marks.

This product may also be made under license under one or more of the following patents:

- US7203207, AU2004246135, CA2527142, GB2418107, HK1082608, MY134526, US8306071

- US7339917, AU2004246136, CA2526926, GB2418812, MY134217

- US7499441, AU2005262626, CA2570441, GB2430333, JP4690397, NZ551231, KR100869043, RU2351080,

BRP10512052, MXPA06015241  
- US 7200129, AU2005226531, CA2558551, CN1930809,  
GB2429378, JP4351720, BRP10508671, NZ549124,  
KR848483, RU2321952

The Bluetooth® word mark and logos are registered trademarks owned by Bluetooth SIG, Inc, and any use of such marks by Tait International Limited is under licence. Other trademarks and trade names are those of their respective owners.

## **Environmental responsibilities**

Tait International Limited is an environmentally responsible company which supports waste minimization, material recovery and restrictions in the use of hazardous materials.

The European Union's Waste Electrical and Electronic Equipment (WEEE) Directive requires that this product be disposed of separately from the general waste stream when its service life is over. For more information about how to dispose of your unwanted Tait product, visit the Tait WEEE website at [www.taitradio.com/weee](http://www.taitradio.com/weee). Please be environmentally responsible and dispose through the original supplier, or contact Tait International Limited.

Tait International Limited also complies with the Restriction of the Use of Certain Hazardous Substances in Electrical and Electronic Equipment (RoHS) Directive in the European Union.

In China, we comply with the Measures for Administration of the Pollution Control of Electronic Information Products. We will comply with environmental requirements in other markets as they are introduced.

# For your safety

Before using your radio, please read the following important safety and compliance information.

## Radio frequency exposure information



For your own safety and to ensure you comply with the radio frequency (RF) exposure guidelines of the United States Federal Communication Commission's (FCC), Industry Canada, and those from other administrations, please read the following information before using this radio.

### Using this radio

You should use this radio only for work-related purposes (it is not authorized for any other use) and if you are fully aware of, and can exercise control over, your exposure to RF energy. To prevent exceeding FCC RF exposure limits, you must control the amount and duration of RF that you and other people are exposed to.

It is also important that you:

- Do not remove the RF Exposure label from the radio.
- Ensure this RF exposure information accompanies the radio when it is transferred to other users.
- Do not use the radio if you do not adhere to the guidelines on controlling your exposure to RF.

### Controlling your exposure to RF energy

This radio emits radio frequency (RF) energy or radio waves primarily when calls are made. RF is a form of electromagnetic energy (as is sunlight), and there are recommended levels of maximum RF exposure.

To control your exposure to RF and comply with the maximum exposure limits for occupational/controlled environments, follow these guidelines:

- Do not talk (transmit) on the radio more than the rated transmit duty cycle. This is important because the radio radiates more energy when it is transmitting than when it is receiving.
- When listening and talking on the radio, hold it upright in front of your face so that it is at least one inch (2.5 cm) away from any part of your face. Keeping the radio at the recommended distance is important because exposure to RF decreases rapidly the further away the antenna is from your body.
- Keep the antenna at least one inch (2.5 cm) from your face at all times.
- If you wear your radio, you must always put it in a carrying accessory carry accessory that has been specifically approved by Tait for this radio. Using non-approved body-worn accessories may mean you expose yourself to higher levels of RF than recommended by the FCC's occupational/controlled environment RF exposure limits.
- Ensure you only use Tait-approved antennas, batteries, and accessories.

For more information on what RF energy is and how to control your exposure to it, visit the FCC website at [www.fcc.gov/oet/rfsafety/rf-faqs.html](http://www.fcc.gov/oet/rfsafety/rf-faqs.html).

### **Compliance with RF energy exposure standards**

This two-way radio complies with these RF energy exposure standards and guidelines:

- United States Federal Communications Commission, Code of Federal Regulations; 47 CFR §§ 1.1307, 1.1310, and 2.1093.
- American National Standards Institute (ANSI) / Institute of Electrical and Electronic Engineers (IEEE) C95.1-2005.
- Institute of Electrical and Electronic Engineers (IEEE) C95.1-2005 Edition.



- European Directive 2013/35/EU on minimum health and safety requirements regarding the exposure of workers to the risks arising from physical agents (electromagnetic fields).

This radio complies with the IEEE and ICNIRP exposure limits for occupational/controlled RF exposure environments at operating duty factors of up to 50% talk to 50% listen.

### **Conformité aux normes d'exposition à l'énergie RF**

Cette radio émetteur-récepteur se conforme aux normes et aux règlements d'exposition à l'énergie RF :

- La Commission fédérale de la communication des Etats-Unis, Code de règlements fédéraux (CFR) Titre 47 Sections 1.1307, 1.1310 et 2.1091 (radios mobiles) ou 2.1093 (radios portatives).
- American National Standards Institute (ANSI) / Institute of Electrical and Electronic Engineers (IEEE) C95. 1-2005.
- Institute of Electrical and Electronic Engineers (IEEE) C95.1-2005 Edition.
- La directive européenne 2013/35/EU concernant les prescriptions minimales de sécurité et de santé relatives à l'exposition des travailleurs aux risques dus aux agents physiques (champs électromagnétiques).

Cette radio se conforme aux limites d'exposition de l'IEEE (FCC) et ICNIRP pour les environnements d'exposition au rayonnement RF professionnel et contrôlé aux cycles de marche de 50% en mode transmission et 50% en mode réception.

# Radio frequency emissions limits in the USA

## **CFR Title 47 Part 15.19 (a) (1) - Receivers**

Part 15 of the FCC Rules imposes RF emission limits on receivers. This radio complies with Part 15 of the FCC Rules. Operation is subject to the condition that this device does not cause harmful interference.

## **CFR Title 47 Part 15.19 (a) (3) - All other devices**

This device complies with Part 15 of the FCC Rules. Operation is subject to the following two conditions. (1) This device may not cause harmful interference, and (2) This device must accept any interference received, including interference that may cause undesired operation.

## **Note**

This equipment has been tested and found to comply with the limits for a Class B digital device, pursuant to part 15 of the FCC Rules. These limits are designed to provide reasonable protection against harmful interference in a residential installation. This equipment generates, uses and can radiate radio frequency energy and, if not installed and used in accordance with the instructions, may cause harmful interference to radio communications. However, there is no guarantee that interference will not occur in a particular installation. If this equipment does cause harmful interference to radio or television reception, which can be determined by turning the equipment off and on, the user is encouraged to try to correct the interference by one or more of the following measures:

- Reorient or relocate the receiving antenna.
- Increase the separation between the equipment and receiver.
- Connect the equipment into an outlet on a circuit different from that to which the receiver is connected.
- Consult the dealer or an experienced radio/TV technician for help.

# Radio frequency emissions limits in Canada

## ISED RSS warning

This device complies with Innovation, Science and Economic Development Canada Compliance licence-exempt RSS standard(s). Operation is subject to the following two conditions: (1) this device may not cause interference, and (2) this device must accept any interference, including interference that may cause undesired operation of the device.

*Le présent appareil est conforme aux CNR d'Innovation, Sciences et Développement économique Canada applicables aux appareils radio exempts de licence. L'exploitation est autorisée aux deux conditions suivantes: (1) l'appareil ne doit pas produire de brouillage, et (2) l'utilisateur de l'appareil doit accepter tout brouillage radioélectrique subi, même si le brouillage est susceptible d'en compromettre le fonctionnement.*

Under Innovation, Science and Economic Development Canada regulations, this radio transmitter may only operate using an antenna of a type and maximum (or lesser) gain approved for the transmitter by Innovation, Science and Economic Development Canada. To reduce potential radio interference to other users, the antenna type and its gain should be so chosen that, the equivalent isotropically radiated power (e.i.r.p.) is not more than that necessary for successful communication.

*Conformément à la réglementation d'Innovation, Sciences et Développement économique Canada, le présent émetteur radio peut fonctionner avec une antenne d'un type et d'un gain maximal (ou inférieur) approuvé pour l'émetteur par Industrie Canada. Dans le but de réduire les risques de brouillage radioélectrique à l'intention des autres utilisateurs, il faut choisir le type d'antenne et son gain de sorte que la puissance isotrope rayonnée équivalente (p.i.r.e.) ne dépasse pas l'intensité nécessaire à l'établissement d'une communication satisfaisante.*

Any Changes expressly or modifications not approved by the party responsible for compliance could void the user's authority to operate the equipment.

Tout changement expressément ou toute modification non approuvée par la partie responsable de la conformité pourrait annuler l'autorité de l'utilisateur à utiliser l'équipement.

SAR tests are conducted using standard operating positions accepted by the ISEDC with the device transmitting at its highest certified power level in all tested frequency bands, although the SAR is determined at the highest certified power level, the actual SAR level of the device while operating can be well below the maximum value.

Before a new model device is available for sale to the public, it must be tested and certified to the ISEDC that it does not exceed the exposure limit established by the ISEDC, Tests for each device are performed in positions and locations (worn on the body) as required by the ISEDC.

For face-up, 25mm was used for test, this equipment should be installed and operated with minimum distance 25mm.

For body worn operation, this device has been tested and meets the ISEDC RF exposure guidelines when used with an accessory designated for this product or when used with an accessory that Contains no metal.

Non-compliance with the above restrictions may result in violation of RF exposure guidelines.

Les tests SAR sont effectués en utilisant des positions de fonctionnement standard acceptées par la ISEDC avec l'appareil transmettant à son niveau de puissance certifié le plus élevé dans toutes les bandes de fréquences testées, bien que le SAR soit déterminé au niveau de puissance certifié le plus élevé, le niveau SAR réel de l'appareil tout en fonctionnement peut être bien en de?à de la valeur maximale. Avant qu'un nouveau modèle d'appareil soit disponible à la vente au public, il doit être testé et certifié par la ISEDC qu'il ne dépasse pas la limite d'exposition établie par la ISEDC. Des tests pour chaque appareil sont effectués dans des positions et des emplacements (porté sur le corps) comme requis par la ISEDC. Pour face vers le haut, 25 mm a été utilisé pour le test, cet équipement doit être installé et utilisé avec une distance minimale de 25 mm.

Pour un fonctionnement porté sur le corps, cet appareil a été testé et répond aux directives d'exposition RF FCC/ISEDC lorsqu'il est utilisé avec un accessoire con?u pour ce produit ou lorsqu'il est utilisé avec un accessoire qui ne contient pas de métal.

Le non-respect des restrictions ci-dessus peut entra?ner une violation des directives d'exposition aux RF.

# EMC regulatory compliance in Australia



This product meets all ACMA regulatory requirements for electromagnetic compatibility (EMC). For more information about EMC compliance, visit the ACMA website at <https://www.acma.gov.au/Industry/Suppliers/Product-supply-and-compliance>.

## Australia and New Zealand citizens band (476.4 to 477.4MHz)

AS/NZS 4365 deals with the use of frequencies in the 476.425 to 477.400 MHz band. Products capable of operating in this band have been approved for operation in the UHF Citizens Band Radio Service which is licensed in Australia by the ACMA Radiocommunications (Citizens Band Radio Stations) Class Licence and in New Zealand by the MED General User Radio Licence for Citizens Band Radio. Operation is subject to conditions contained within those licences.

Repeaters operate by receiving a transmission on one channel and re-transmitting it on another. Operators are required to avoid using local repeater input channels, which will be in the range of 31 to 38, unless it is intended to use the repeater facility, and to avoid using local repeater output channels, which will be in the range 1 to 8, at any time.

No voice transmissions are permitted on data channels 22 and 23. Equipment meeting this standard will inhibit voice operation on channels 22 and 23.

In Australia:

- Except in an emergency, a CB transmitter must not be operated on UHF channels 5 and 35.
- Channel 11 is the customary calling channel for establishing communications.

- Channel 40 is the customary road vehicle channel.

## Health, safety and electromagnetic compatibility in Europe

In the European Community, radio and telecommunications equipment is regulated by the Radio Equipment Directive (2014/52/EU). The requirements of this directive include protection of health and safety of users, as well as electromagnetic compatibility.

### Intended purpose of product

This product is an FM radio transceiver. It is intended for radiocommunication in the Private Mobile Radio (PMR) or Public Access Mobile Radio (PAMR) services, to be used in all member states of the European Union (EU) and states within the European Economic Area (EEA).

### Restrictions

This product can be programmed to transmit on frequencies that are not harmonized throughout the EU/EEA, and will require a licence to operate in each member state.

This product can be programmed for frequencies or emissions that may make its use illegal. Where applicable, a license must be obtained before this product is used. All license requirements must be observed. Limitations may apply to transmitter power, operating frequency, channel spacing, and emission.

### Declaration of conformity

Simplified declarations of conformity appear on [page 71](#) of this document. To download the formal declaration of conformity, go to [www.taitradio.com/eudoc](http://www.taitradio.com/eudoc).

## Interference with electronic devices



**Warning** Some electronic devices may be prone to malfunction due to the lack of protection from RF energy that is present when your radio is transmitting.

Examples of electronic devices that may be affected by RF energy are:

- aircraft electronic systems
- vehicular electronic systems such as fuel injection, anti-skid brakes, and cruise control
- medical devices such as pacemakers and hearing aids
- medical equipment in hospitals or health care facilities.

Switch off the radio before boarding an aircraft. Using your radio while in the air is not permitted.

Consult the manufacturer (or its representative) of any such electronic devices to determine whether electronic circuits in those devices will perform normally when the radio is transmitting.



**Warning** If you have a pacemaker:

- immediately turn off the radio if you suspect it is interfering with the pacemaker
- keep the radio at least 6 inches (15cm) from the pacemaker while the radio is on
- use the radio on the side opposite to the pacemaker to minimize interference
- never carry the radio in a breast pocket.

If there is interference between your hearing aid and the radio, please discuss an alternative solution with the hearing aid manufacturer.

## Potentially explosive atmospheres and blasting areas



**Warning** Unless the radio is specifically certified for use in a potentially explosive atmosphere, do not take the radio into such an atmosphere. An explosion could cause serious injury or death. Examples of potentially explosive atmospheres include any environment where there are flammable liquids, gases, or dusts.



**Warning** Turn off the radio before approaching any area where you are instructed to turn off a two-way radio.

## Radio installation and operation in vehicles



**Warning** Keep the radio away from airbags and airbag deployment areas. Do not install, charge, or place a radio near such areas. An activated airbag can propel a portable radio with sufficient force to cause serious injury to vehicle occupants. An airbag may not perform to specification if obstructed by a radio.



**Warning** To avoid damage to existing wiring, airbags, fuel tanks, fuel and brake lines, or battery cables, refer to the installation guide for the radio, and to the vehicle manufacturer's manual, before installing electronic equipment in the vehicle.

Using a handheld microphone or a radio while driving a vehicle may violate the laws and legislation that apply in your country or state. Please check the vehicle regulations in your area.



# Electromagnetic compatibility in European vehicles

In the European Community, radio equipment fitted to automotive vehicles is regulated by UNECE Regulation 10 Revision 5. The requirements of this regulation cover the electromagnetic compatibility of electrical or electronic equipment fitted to automotive vehicles.

## Unapproved modifications or changes to radio

The radio is designed to satisfy the applicable compliance regulations. Do not make modifications or changes to the radio that are not expressly approved by Tait. Failure to do so could invalidate compliance requirements and void the user's authority to operate the radio.

### Attaching of labels



**Warning** Do not obstruct the vent hole on the battery or the vent hole on the radio chassis label. If the vent on the battery is obstructed, the battery may explode, causing personal injury and/or damage to property. If the vent on the radio is obstructed, audio quality and/or key function may deteriorate and radio seals may be damaged.



**Caution** Tait recommends that you do not affix additional labels to the surfaces between the radio chassis and the battery. The fit between these surfaces is intentionally firm and any added thickness will damage the points of attachment between radio and battery. Do not obstruct the vent holes (see Warning above). Do not allow the paper label to extend beyond the recessed label area or to conceal relevant product information.

## Use of lithium-ion batteries



**Warning** A damaged battery can cause an explosion or fire, and can result in personal injury and/or property damage. To prevent personal injury and/or damage to property, read the important safety information supplied with the battery.

## Short-circuiting battery contacts



**Warning** Do not short-circuit the battery contacts, neither intentionally nor accidentally, e.g. by placing the battery with conductive materials such as keys or jewelry inside a pocket or container. Short-circuiting the battery contacts can heat up the conductive material and cause personal injury and/or damage to property.

# Menu map

This section shows the menus and submenus that may be programmed for your radio (for radios with display only).

## Contact

### Favorite contact list

#### Contact list

- Edit contact
- Delete contact
- View contact

#### New contact

#### Manual dial

## Ctrl services

#### Alert call

#### Radio check

#### Radio disable

#### Radio enable

#### Remote monitor

## Message

### New message

### Quick text

### Status message

#### Inbox

- Forward
- Reply

#### Outbox

#### Drafts

## Call logs

### Outgoing

### Incoming

### Missed

## Zone

## Scan

### Scan on/off

### Scan list

## Programming

### Channel

- Frequency
- Slot
- Color code
- Tx contact
- Rx group list
- CTCSS

### Radio

- Radio alias
- Radio ID

## Settings

### Radio settings

- Talk around
- Power level
- Squelch level
- Lone worker
- Backlight
- Day/night mode
- Brightness
- Keypad lock
- LED
- Tones
- Man down<sup>1</sup>
- Encrypt
- Channel display mode
- Language
- Radio password
- Optional key
- VOX
- Keypad mode
- Vibration

### Radio information

## Accessories

### GPS<sup>1</sup>

### Position view

### Time zone

### BT<sup>1</sup>

### Work order

---

1. TP3350 only

# 1 About this guide

This user's guide provides information about the T03-00302 (TP3300) and T03-00303 (TP3350) DMR conventional and analog portable radios.

Both models are available with the following front panels:

- display and 16 keys
- display and 4 keys
- no display and no keys

These front panels are interchangeable. Contact your radio provider for more information.

 Bluetooth<sup>®</sup> (page 42), GPS (page 52), and man-down features are only available in TP3350 portables. Mandown can operate in all signalling modes.

The radio behavior described in this guide applies to radios with firmware version v1.01. If your radio does not operate as you expect, contact your radio provider for assistance.

## Safety warnings used in this guide

Please follow exactly any instruction that appears in the text as an 'alert'. An alert provides necessary safety information as well as instruction in the proper use of the product. This user's guide uses the following types of alert:



**Warning** This alert is used when there is a hazardous situation which, if not avoided, could result in death or serious injury.



**Caution** This alert is used when there is a hazardous situation which, if not avoided, could result in minor or moderate injury.

**Notice** This alert is used to highlight information that is required to ensure procedures are performed correctly. Incorrectly performed procedures could result in equipment damage or malfunction.



This icon is used to draw your attention to information that may improve your understanding of the equipment or procedure.

## Related documentation

The following documentation is also available for your Tait radio, which you can access from the Tait Technical Support website (<http://support.taitradio.com>):

- *Safety and Compliance Information*—supplied with each radio. (The same information is included in this user's guide.)
- *Li-ion Battery Safety Information*—supplied with each Li-ion battery.

## 2 Before using your radio

Once you have unpacked your radio, there are a few tasks you must do before you can use it. The most important of these is to charge your battery for the first time—allow 2.5 hours for this.



**Warning** Do not charge the battery or change the antenna in a hazardous location. An explosion could cause serious injury or death.

### **This section covers:**

- [Package Contents](#)
- [For your safety—battery warning](#)
- [Attaching labels to the radio or battery](#)
- [Charging the battery before first use](#)
- [Attaching the battery](#)
- [Removing the battery](#)
- [Attaching the antenna](#)
- [Removing the antenna](#)
- [Replacing the belt clip](#)
- [Attaching an audio accessory](#)

# Package Contents

Your TP3 package contains the following items:

- Radio
- Antenna(s)
- Battery(s)
- Battery Charger
- Multi-National Plug Pack
- Belt Clip
- Safety and Compliance documents

# For your safety—battery warning



**Warning** This radio uses a Lithium-ion battery. If the battery is damaged or handled in an unsafe manner, it can cause personal injury and/or damage to property. Read the important safety information included with your battery.

## Attaching labels to the radio or battery

The radio has recesses to attach labels to the front (not for 16-key radio), both sides and the rear.

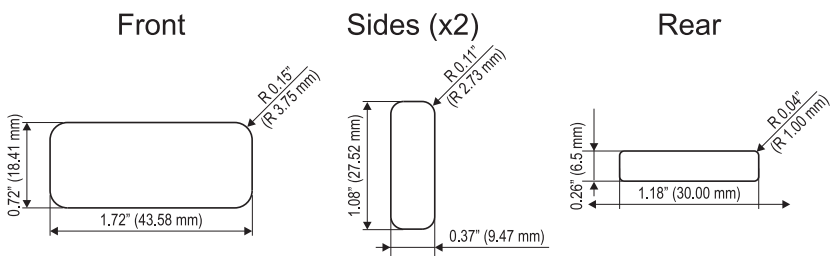

Please contact your Tait dealer for pre-printed, customized labels.



**Warning** Do not cover the battery vent hole or the vent hole on the radio chassis. If the vent on the battery is obstructed, the battery may explode, causing personal injury and/or damage to property. If the vent on the radio is obstructed, audio quality and/or key function may deteriorate and radio seals may be damaged.

**Notice** Tait recommends that you do not affix additional labels to the surfaces between the radio chassis and the battery. The fit between these surfaces is intentionally firm and any added thickness will damage the points of attachment between radio and battery.



# Charging the battery before first use

Before using your battery for the first time, you must charge it. Follow the instructions included with your Tait charger. This information is repeated in the section "[Charging and caring for batteries](#)" on [page 53](#).

-  For best charging performance, switch off the radio before placing it in the charger.

# Attaching the battery

- 1 Rotate the power/volume control switch counterclockwise to turn off the radio.

 If the battery has been attached while the radio is turned on, turn the radio off and then on again before use.

- 2 Insert the top of the battery into the recess at the back of the chassis.
- 3 Lightly press the bottom of the battery towards the radio until the battery catch clicks.
- 4 Make sure that the battery is firmly in position.

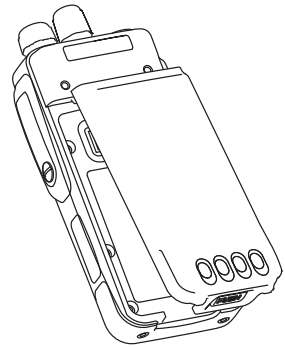

# Removing the battery

The battery is secured to the radio by a battery catch in the radio's rear panel.

To remove the battery from the radio, so that the battery can be charged or replaced:

- 1 Rotate the power/volume control switch counterclockwise to turn off the radio.

 If the battery has been removed while the radio is turned on, turn the radio off and then on again before use.

- 2 Push the **PRESS** button at the bottom of the radio to release the battery catch, and pull the battery away from the radio.

# Attaching the antenna

Before using the radio, screw the antenna clockwise into the antenna connector. The antenna should be screwed sufficiently tight so that it doesn't unscrew easily. This is important as it creates a seal.

# Removing the antenna



**Warning** Do not change the antenna in a hazardous location. An explosion could cause serious injury or death.

Use a firm grip and turn the antenna counterclockwise half a turn. Use a lighter grip to fully unscrew the antenna, and carefully remove it.

# Replacing the belt clip

- 1 To remove the belt clip, use a Pozidrive screwdriver to undo the two belt clip screws.
- 2 To attach the belt clip, use a Pozidrive screwdriver to fasten the two belt clip screws.

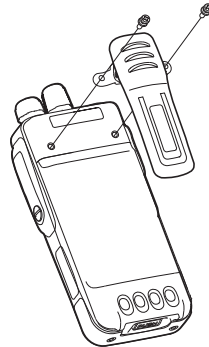

# Attaching an audio accessory

Audio accessories plug into the radio's accessory connector. The accessory connector is protected by a cover, which needs to be removed before an accessory can be installed.

**Notice** The accessory cover protects the accessory connector from electrostatic discharge. Keep the cover in place unless the connector is in use.

To remove the accessory cover and install an audio accessory:

- 1 Use a coin or other blunt object to loosen the screw that secures the accessory cover to the radio.
- 2 Remove the accessory cover and store it in a safe place.
- 3 Plug the accessory into the accessory connector.
- 4 Tighten the screw.
- 5 Once the radio has recognized the accessory, the accessory icon  will appear.

# 3 Getting started

This section gives an overview of your DMR radio, describes the radio's controls and indicators, and explains how the radio menus are organized.

**This section covers:**

- [About your DMR digital radio](#)
- [About the radio controls](#)
- [Understanding the radio display](#)
- [Understanding the radio indicators](#)
- [Using function keys to access frequently used features](#)
- [Navigating the radio's menus](#)

# About your DMR digital radio

Your DMR digital radio can be programmed for DMR conventional. Analog conventional operation is also available.

You may notice differences between digital and analog calls in terms of:

- static noise in low signal areas, and
- radio coverage in marginal reception areas.

## Lack of static noise

On digital networks there is no static noise, even in low signal areas. This lack of static is because your digital radio removes the 'noise' from the call, so that you hear only clear voice.

## Coverage

With digital networks, a call remains clear and then drops off quickly at the border of a coverage area. The reason for this is that a digital call is either received or it isn't. With analog networks, the background noise in a call gets progressively worse when you are in fringe areas or even slightly outside normal coverage areas.

## What you hear on an analog channel

On analog channels, your radio may be programmed so that you hear all conversations on a channel, or your user group may be segregated from other user groups by using special signaling. The special signaling is used to control the muting and unmuting of your radio, so that your radio is muted when other user groups are talking and unmuted for members of your user group.

There are two muting controls that operate in your radio:

- signaling mute
- squelch

### Signaling mute

The radio's signaling mute only allows the radio to unmute if the incoming call carries the tones specific to your user group. Your user group may use tones that are either audible, subaudible or both.

### Squelch

The radio's squelch allows the radio to unmute only when the strength of the incoming signal is above a predetermined threshold. This means that only signals of reasonable intelligibility are made audible.

# About the radio controls

The radio controls are the PTT key, power/volume control, channel selector, scroll keys, selection keys, and function keys. Some keys have functions assigned to both short and long key presses:

- a short key press is less than one second, and
- a long key press is more than one second.

The radio controls and their functions are described in the following sections.

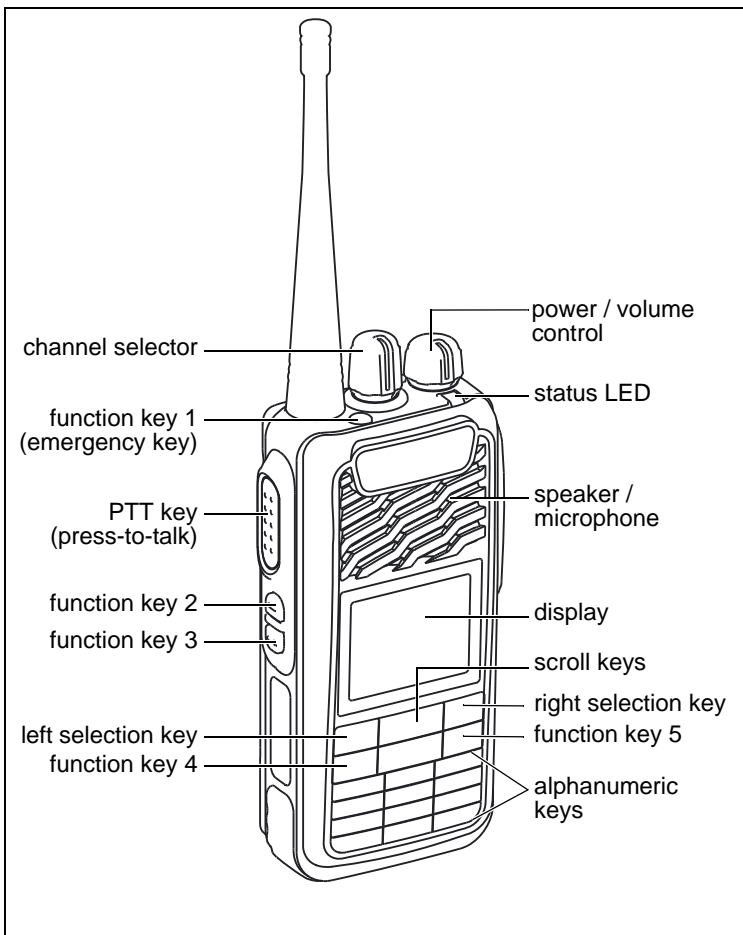

















<b>Name</b>	<b>Function</b>
PTT key	Press and hold to transmit and release to listen
Power/volume control	Rotate to turn the radio on and change the speaker volume
Channel selector	Select and change channels
Left and right selection keys	Action determined by the text above the selection key
Scroll keys	Scroll up and down through a list of menu options, scroll left and right in messages, or access a pre-programmed menu
Function keys	Programmed for frequently used options
Alphanumeric keys	Used to enter letters and numbers







# Understanding the radio display

The messages and icons you see on your radio display depend on the mode in which your radio is operating and the way it is programmed.

## Radio display icons



These are some of the icons you may see on your radio display:

Icon	Meaning
	No signal.
	Signal strength indicator: the more bars, the stronger the signal being received by the radio
	Battery indicator: shows how much charge is available in the battery.
	Bluetooth: The Bluetooth feature is enabled but there is no remote Bluetooth device connected.
	Bluetooth connected: The Bluetooth feature is enabled. The icon stays lit when one or more remote Bluetooth devices are connected.
	Scanning: your radio is monitoring a group of channels or workgroups for activity.
	Scan land on: Scan feature is enabled.
	Encryption: Encryption is turned on.
	GPS available: GPS is turned on. The icon stays lit when a position fix is available.
	GPS not available/out of range: GPS is turned on. The icon stays lit when a position fix is available.
	Accessories connected.
	High-power transmit: Your radio is set to transmit on high power.
	Low-power transmit: Your radio is set to transmit on low power.
	Direct mode (talkaround mode). In repeater mode no icon is shown.

Icon	Meaning
	Unread message.
	VOX enabled.
	Speaker open.
	Private Call Indicates a Private Call in progress. In the Contacts list, it indicates a subscriber alias (name) or ID (number).
	Bluetooth Audio Device Bluetooth-enabled audio device, such as a headset.
	Item sent successfully.

## Switch Input Method

Long-press the # key to switch input method between:

-  lowercase
-  uppercase
-  numeric

# Understanding the radio indicators





The status LED indicator and the radio's audible tones—together with the radio display—all combine to give you information about the state of your radio.

The most common way the indicators work is described in the following sections.

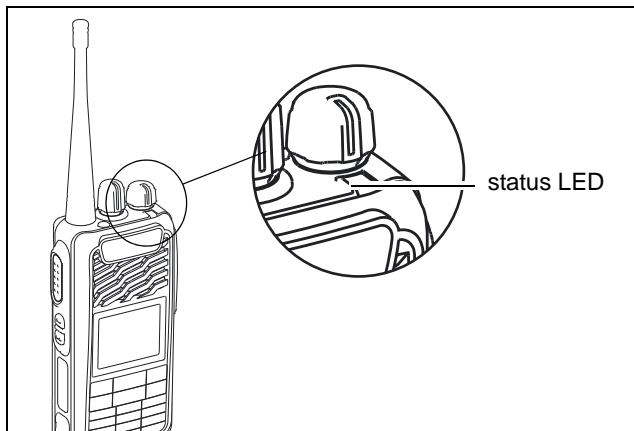
-  The way these indicators behave may be affected by the way your radio is programmed.

## Status indicators



Color		Meaning
Red		On: The radio is transmitting.
		Flashing: The battery is low.
Green		On: The radio is receiving, or detecting activity over the air.
Orange		On: The radio is powering up.
		Flashing: The Radio is scanning, or in selective call, or emergency state.

## Audible tones



**Warning** Your radio may be programmed to be silent, which means you may not hear any alerts.

The radio uses audible tones to alert you to its status:

- Radio controls and keypress tones—the tones and beeps you hear when you press your radio's keys or use the controls.
- Incoming call tone—when the radio is receiving a call.
- Warning tones—when there is an error, or the battery is low, for example.

## Voice annunciation

Your radio may be programmed to play a pre-recorded message

- for start-up channel
- when changing the channel
- for the battery condition

# Using function keys to access frequently used features

The function keys provide access to some of the features you will use most often. These features are assigned to the function keys when the radio is programmed. Some keys may have a feature associated with both a short key press and a long key press.

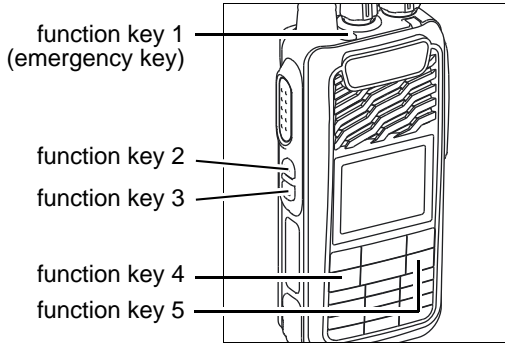

Use the following table to record the function keys programmed for your radio:

	<b>Short key press</b>	<b>Long key press</b>
F1		
F2		
F3		
F4		
F5		

For more information about the function keys that can be programmed on your radio, contact your radio provider.

# Navigating the radio's menus

Radios with display have a number of menus, each containing lists or submenus. The menus available depend on the way your radio is programmed. See also ["Menu map" on page 19](#).

To access the menu, press the left selection key whenever **Menu** appears above it.

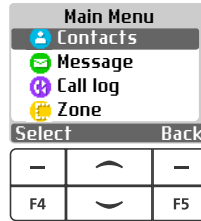

Use the scroll keys to move through the menu list.

When the menu you want is highlighted, press **Select** (left selection key).

To go back one level, press **Back** (right selection key).

# 4 Operation

This section describes the basic operation of your radio.

## **This section covers:**

- Turning the radio on and off
- Adjusting the speaker volume
- Connecting to a Bluetooth® device (TP3350 only)
- Selecting a zone
- Selecting a channel
- Making a group call
- Making a private call
- Turning scanning on and off
- Making a call alert
- Sending a quick text message
- Sending an emergency alarm
- Turning location information on and off (TP3350 only)



# Turning the radio on and off

Rotate the On/Off/Volume control switch clockwise until you hear a click. You see a welcome message or welcome image.

The LED lights up solid orange and the Home screen lights up if the backlight setting is set to turn on automatically.

To turn off the radio, rotate the switch counterclockwise until you hear a click. You see a brief **Powering Down** on the radio's display.

 Your radio may not turn on if your battery is very low. (See "[Low battery warning](#)" on page 56.)

## Security lock on power-up feature

Your radio may be automatically locked each time it is powered-up.

- 1 Power up the radio.
- 2 Enter your current six-digit password with the radio keypad. The display shows \*\*\*\*\*.

You hear a positive indicator tone for every digit pressed.

- 3 Press the right selection key to remove the each \* on the display.
- 4 Press the left selection key to proceed.

If the password is correct, your radio proceeds to power up.

If the password is incorrect, the display shows **Password Input Error**. Repeat step 2.

# Adjusting the speaker volume

Rotate the power/volume control clockwise to increase the speaker volume and counterclockwise to decrease the volume.

-  The volume control also changes the volume level of the radio's audible indicators.

# Connecting to a Bluetooth<sup>®</sup> device (TP3350 only)

You may be able to connect a Bluetooth device to your radio.

## Compatibility with Tait radios

Bluetooth devices may operate with Tait radios, provided they:

- are compatible with the Bluetooth Specification Version 2.0 or higher. Tait recommends Bluetooth Specification Version 2.1 or higher.
- include Bluetooth Headset Profile (HSP) adopted version 1.1 or 1.2, or Bluetooth Handsfree Profile (HFP) version 1.5 or 1.6.

## Wearing a Bluetooth headset

Place the headset on your ear. Depending on which ear you are going to wear the headset, simply adjust the ear hook accordingly.

To get the best performance from your headset:

- 1 Do not block the device's internal antenna (see the device's user documentation). The human body can interfere with a Bluetooth signal.
- 2 If you usually use your radio with your right hand, wear the headset on your right ear.

- 3 Avoid coming in contact with the internal antenna of a headset or radio.

## Pairing a Bluetooth device with the radio

-  Before attempting to connect a device, Tait recommends that the device is fully charged. Refer to the documentation of your Bluetooth device for charging instructions.

Pairing creates a unique and encrypted wireless link between the radio, and the Bluetooth device. To use a device with your radio, they must first be paired.

When you connect to a Bluetooth device for the first time, you need to instruct the radio to search for compatible devices using Bluetooth wireless technology. The search should take less than one minute.



-  Do not turn off your Bluetooth device or press the right selection key during the finding and connecting operation as this cancels the operation.

A pin code may be required to be programmed in your radio before it can pair with some devices. Contact your dealer for more information.

### 16-key and 4-key radios

- 1 Turn on your Bluetooth device and place it in pairing mode. Refer to the documentation of your Bluetooth device.
- 2 On your radio, press **Menu** and select **Accessories**.
- 3 Select **Bluetooth > My Devices**.



-  If you cannot see **My Devices**, turn on the **BT On/Off** setting.
- 4 Scroll to the required device and press **Select**.
-  You can also use **Search Devices** to locate available devices.

## 5 Select **Connect**.

The display shows **Connecting to <device>**. Your Bluetooth device may require additional steps to complete the pairing. Refer to the documentation of your Bluetooth-enabled device.

If successful, the radio display shows **<Device> Connected**. A tone sounds and ✓ appears beside the connected device. The Bluetooth Connected icon appears on the status bar, or if unsuccessful, the radio display shows **Connected Failed**.

### **No-key no-display radio**

- 1 Turn on your Bluetooth device and place it in pairing mode. Refer to the documentation of your Bluetooth device.
- 2 On your radio, press the function key programmed for **Bluetooth Connect**.

A tone sounds and the LED blinks orange.

Your Bluetooth device may require additional steps to complete the pairing. Refer to the documentation of your Bluetooth device.

If successful, a positive tone sounds, or if unsuccessful, a negative indicator tone sounds.

## **Answering a Call Alert**

16-key and 4-key radios:

- To answer a call alert on your radio, select View then press and hold the PTT button.

# Selecting a zone

A zone is a group of channels.

The 16-key and 4-key radios support up to 2000 channels and 250 zones, with a maximum of 160 channels per zone.

The non-keypad radio supports up to 32 channels and two zones, with a maximum of 16 channels per zone.

## 16-key and 4-key radios

- Press the function key programmed for Zone.

or

- 1 Press **Menu** and select **Zone**.

The selected zone is indicated by a .

- 2 Scroll to the required zone and press **Select**.

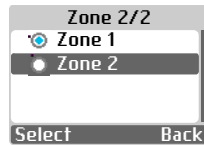

## No-key no display radio

- Press the function key programmed for Zone.

You hear a positive indicator tone, indicating the radio has switched from Zone 1 to Zone 2.

or

You hear a negative indicator tone, indicating the radio has switched from Zone 2 to Zone 1.

# Selecting a channel

Once the required zone is displayed (if you have multiple zones in your radio), turn the channel selector to select the channel.

# Changing a Channel

To use the quick channel change method simply dial the channel you would like to use. e.g. - dial 502 to move to channel 502.

## Making a group call

- 1 Turn the channel selector to select the channel with the active group alias or ID.
- 2 Hold the radio vertically one to two inches (2.5 to 5cm) from your mouth.
- 3 Press the PTT key to make the call.

The LED lights up solid red and the Group Call icon  appears. The first text line shows the group call alias.

- 4 Wait for the Talk Permit tone to finish (if enabled) and speak clearly into the microphone, or wait for the PTT side tone to finish (if enabled) and speak clearly into the microphone.
- 5 Release the PTT key to listen.

When the called radio responds, the LED lights up green. You see the Group Call icon , the group alias or ID, and transmitting radio alias or ID on your display.

- 6 Your radio may be programmed to create a short alert tone the moment the target radio releases the PTT key, indicating the channel is free for you to respond. Press the PTT key to respond.

or

If there is no voice activity for a predetermined period of time, the call ends.

- 7 The radio returns to the screen you were on prior to initiating the call.

# Making a private call

- 1 Turn the channel selector to select the channel with the active subscriber alias or ID.
- 2 Hold the radio vertically one to two inches (2.5 to 5cm) from your mouth.
- 3 Press the PTT key to make the call.  
The LED lights up red. The Private Call icon  appears. The first text line shows the subscriber alias. The second text line displays the call status.
- 4 Wait for the Talk Permit tone to finish (if enabled) and speak clearly into the microphone.
- 5 Release the PTT key to listen.  
When the target radio responds, the LED lights up green.
- 6 Your radio may be programmed to create a short alert tone the moment the target radio releases the PTT key, indicating the channel is free for you to respond. Press the PTT key to respond.  
or  
If there is no voice activity for a predetermined period of time, the call ends.
- 7 You hear a short tone. The display shows **Call Ended**.

# Turning scanning on and off

## 16-key and 4-key radios

- Press the function key programmed to turn scan on and off.

or

- 1 Press **Menu** and select **Scan > Scan Switch**.
- 2 Select **On** or **Off**.



If you cannot turn on scanning, select a scan list first (**Scan > Scan List**).

During scan, the LED flashes orange and the Scan icon  is displayed.

### No-key no-display radio

- Press the function key programmed to turn scan on or off.

During scan, the LED flashes orange.

## Making a call alert

### 16-key and 4-key radios

- Press the function key programmed to make a call alert to the predefined ID.

or

- 1 Press **Menu** and select **Contacts > Contact List**.
- 2 Scroll to required contact and press **Select**.
- 3 Select **Ctrl Services** and **Call Alert**.

or (for 16-key radio only)

- 1 Press **Menu** and select **Contacts > Manual Dial**.
- 2 Enter the subscriber ID you want to page and press **Confirm**.
- 3 In the **Ctrl Services** menu select **Call Alert**.

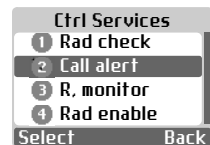

The display shows **Call Alert** and the subscriber alias or ID, indicating that the call alert has been sent.

The LED flashes red when your radio is sending the call alert.

If the call alert acknowledgement is received, the display briefly shows **Success!**

If the call alert acknowledgement is not received, the display briefly shows **Failed!**



## No-key no-display radio

- Press the function key programmed to make a call alert to the predefined contact.

The LED flashes when your radio is sending the call alert.

If the Call Alert acknowledgement is received, two chirps sound.

or

If the Call Alert acknowledgement is not received, a low-pitched tone sounds.

# Sending a quick text message



## 16-key radio

- Press the function key programmed to send a predefined quick text message to a predefined contact.

or

- Press the function key programmed to open the **Quick Text** function. Go to step 2 below.

or

- 1 Press **Menu** and select **Message > Quick Text**.
- 2 Scroll to the required quick text and press **Select**.
- 3 Use the keypad to edit the message, if required.
  - a. Press  to move to the left.
  - b. Press  to move to the right.
  - c. Press the \* key to delete any unwanted characters.
  - d. Press the # key to input one space to the right.
  - e. Long-press the # key to switch between lowercase, uppercase and numeric input.
- 4 Press **Confirm**.

 You can also press the right selection key to quit the operation.

**5** Press **Send**.

 You can also press **Save** to save the message in the drafts.

**6** Select **Contact List**, scroll to the required contact and then press **Select**.

or

Select **Manual Dial** and enter the subscriber ID and press **Confirm**.

The display shows **Sending Msg...** and the LED flashes red.

If the message is sent, a tone sounds and the display shows **Send Success!**

or

If the message is not sent, a low tone sounds and the display shows **Send Failed!**

### **4-key radio**

■ Press the function key programmed to open the Quick Text function. Go to step 2 below.

or

**1** Press **Menu** and select **Message > Quick Text**.

**2** Scroll to the required quick text and press **Select**.

**3** Scroll to the required contact and press **Select**.

The display shows **Sending Msg...** and the LED flashes red.

If the message is sent, a tone sounds and the display shows **Send Success!**

or

If the message is not sent, a low tone sounds and the display shows **Send Failed!**

## No-key no-display radio

- Press the function key programmed to send a pre-defined quick text message to a predefined ID.

The LED flashes red.

Two chirps indicate that the message has been sent, or  
a low-pitched tone indicates that the message cannot be sent.

## Sending an emergency alarm



If your radio is set to silent, it will not display any audio or visual indicators during Emergency mode.

- Press the function key programmed for emergency.

The display shows **Tx Alarm** and the destination alias. The LED blinks red and the Emergency icon appears.

or

The radio will send an emergency telegram. You can now press PTT to make an emergency call, and receive by releasing PTT. After a call hang time, the radio return to its normal working state.

or



The radio will send an emergency telegram and then transmit voice from the microphone for a preset time. And then goes back to normal working state. Then the radio return to its normal working state

# Turning location information on and off (TP3350 only)

Your radio may be enabled to send location information.

## 16-key and 4-key radios

- 1 Press **Menu** and select **Accessories > GPS**.
- 2 Select **GPS On/Off** and select on or off.

When GPS is turned on, the GPS icon  will appear. Once a GPS signal is available, the GPS icon will change to .

## No-key no-display radio

- Press the function key programmed for GPS to turn GPS on or off.

If turned on, a positive tone sounds. If turned off, a negative tone sounds.

# 5 Charging and caring for batteries

This section describes how to charge your Tait radio battery as well as care for it, to ensure safe operation, maximum performance and prolonged battery life.

## **This section covers:**

- [About the chargers](#)
- [Before using the charger](#)
- [Before using the charger](#)
- [Charging temperatures](#)
- [Leaving the battery on charge](#)
- [Receiving calls while charging](#)
- [Low battery warning](#)
- [Charging a battery for the first time](#)
- [Charging a battery](#)
- [LED behavior](#)
- [Removing the battery from the charger](#)
- [Maintaining battery life and performance](#)
- [Storing batteries](#)
- [Disposing of batteries](#)

# About the chargers

Unless otherwise indicated, the charging advice and instructions in this document apply to all chargers.

The following chargers are available for your Tait radios and batteries:

Part number range	Designation
T03-00322-xxxx	Desktop charger



## Before using the charger

Check the battery label and charger label to see if the charger is compatible with the battery. See also ["About the chargers" on page 54](#).



**Warning** Handle the battery safely. Failure to observe the following handling recommendations could result in personal injury and/or equipment damage.

- Before using a Li-ion battery, read the Li-ion Battery Safety Information (MPC-00006-xx) included with your battery, and follow the instructions it provides. Incorrect use of a Li-ion battery can cause explosion or fire.
- Do not short-circuit the battery contacts, neither intentionally nor accidentally, e.g. by placing the battery with conductive materials such as keys or jewelry inside a pocket or container. Short-circuiting the battery contacts can heat up the conductive material.
- Do not obstruct the vent hole(s) on the battery. If the vent on the battery is obstructed the battery may explode, causing personal injury and/or equipment damage. If the vent on the radio is obstructed, audio quality and/or key function may deteriorate and radio seals may be damaged.

**Notice** Turn the radio off before removing the battery, and turn it on again after attaching the battery. This ensures that the radio powers down and up correctly. Failing to follow this procedure may require the radio to be turned off then on again to operate correctly.

## Charging temperatures

**Notice** Do not expose a battery to very high or very low temperatures for extended periods of time. Doing so will shorten the usable life ('service life') of the battery.

To achieve the best results when charging your battery:

- Before you begin to charge your battery, make sure that the battery temperature is close to the room temperature in which the battery is to be charged.
- If possible, charge the battery in temperatures between 50°F and 77°F (between 10°C and 25°C). This temperature range is the optimal charging range.

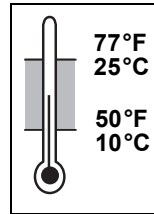

Charging only starts when the battery is between 32°F to 104°F (0°C to 40°C).



When the battery temperature is outside the normal charging range, the orange LED on the charger is lit. Charging will start or resume once the temperature is within normal limits, and no action is required by you.

## Leaving the battery on charge

You can leave a battery/radio in the charger once charging is complete. Leaving a battery in the charger will not overcharge or damage it.

You can remove a battery/radio from the charger at any time without harming the battery, the radio, or the charger. When you return the battery/radio to the charger, charging is automatically resumed.

## Receiving calls while charging

**Notice** For best charging performance, switch off the radio before placing it in the charger.

You can receive a call while the radio is in the charger, but your radio performance may be degraded. If you do remove the radio from the charger to answer a call, the call will not be disrupted.

Removing the radio from the charger to make or receive a call ends the charging process. Charging safely recommences when the radio is reinserted into the charger.

## Low battery warning

**Notice** Do not allow a radio battery to fully discharge every time you use it, or you will shorten the service life of the battery.



When the battery is low, your radio warns you in the following ways:

- The battery symbol on the radio display looks empty.
- The status LED on the radio slowly flashes red.
- A high-pitched beep sounds.

You should recharge or replace the battery as soon as possible.





# Charging a battery for the first time

-  Fully charge a battery before using it for the first time.
-  The red LED stays lit while the battery charges.

## Charging a battery

**Notice** For best charging performance, switch off the radio before placing it in the charger.

- 1 Desktop charger: Connect the charger to the correct Tait power adaptor.

-  6-way charger: Power on the charger.
-  Initially, all three LEDs are lit for 2 seconds.

























- 2 Place just a battery in the charger, or a radio with a battery attached (desktop charger or 6-way charger only). There is no need to remove a belt clip, antenna, or any accessory that is attached to the accessory connector.

-  The red LED lights up, and stays lit while the battery charges.

-  When charging is complete, the green LED stays lit.

# LED behavior

If there is a battery in the charger when power is supplied to the charger, the LEDs behave as follows:

  	Meaning
  	The charger has been connected to a power supply briefly.
  	The battery is charging. steady
  	Charging complete. Remove the battery, or leave it in the charger. steady
  	■ The battery temperature is outside the normal charging range. Charging will start or resume once the temperature is within normal limits. No action is required by you. steady
	■ There is a fault. Contact your dealer.
  	If the LEDs for all charger slots continuously flash orange, or red then orange, the charger itself may be faulty. Contact your dealer.
  	
  	There is a fault. Contact your dealer. all off

If the charger does not behave as expected:

- Make sure the radio or battery is seated properly in the charger.
- Check that the charger is properly plugged into the originally supplied power supply.
- Check that the battery and charger contacts are clean. To clean, wipe the contacts with a dry lint-free cloth to remove any dirt, oil or grease.

# Removing the battery from the charger

- Lift the battery/radio out of the charger.

You can remove a battery/radio from the charger at any time without harming the battery, the radio, or the charger. When you return the battery/radio to the charger, charging is automatically resumed. You can also leave a battery/radio in the charger once charging is complete.

# Maintaining battery life and performance

With proper care and maintenance you will maintain the performance and life of the battery. It is recommended that you:

- Use only Tait chargers and batteries.
- Do not expose a battery to very high or very low temperatures for extended periods of time. Doing so will shorten the service life of the battery.  
Very high: above 140°F (60°C)  
Very low: less than -4°F (-20°C)
- Charge the battery at a room temperature of between 50°F and 77°F (between 10°C and 25°C). This temperature range is the optimal charging range.
- Wipe excess moisture and dirt from the radio, radio contacts and battery contacts before charging the battery.
- Store batteries properly when not in use. See "[Storing batteries](#)".

# Storing batteries

When not in use for a month or more, batteries should be stored correctly to prolong their life.

- Remove the battery from the radio before storage.
- Fully charge the battery if storing for less than one month.
- Charge batteries to about 30% if storing for longer than one month.
- Store in a cool dry place.

Batteries that have been stored for any length of time must be charged before being used. See "[Charging a battery for the first time](#)" on page 57.

## Disposing of batteries



Run the battery flat before disposing of it. When disposing of the battery, be sure to do so in an environmentally sensitive manner. Please contact your radio provider for information on recycling programs in your area. See "[Environmental responsibilities](#)" on page 6 for more information.

# 6 Troubleshooting

This section describes troubleshooting procedures, and basic maintenance.

## **This section covers:**

- [About troubleshooting](#)
- [When your radio won't turn on](#)
- [Identifying the radio's audible tones](#)
- [Viewing radio information](#)
- [General care](#)

# About troubleshooting

If you are experiencing difficulty operating your radio, you may find the following sections helpful. Consult your radio provider for assistance, if necessary.

## When your radio won't turn on

If the LED on your radio does not glow red when the radio is turned on, it is probable that power is not reaching the radio. Check the following:

- Is the battery firmly attached to the radio?
- Is the battery sufficiently charged?
- Is the battery charger working properly?

If all appears to be in order, but your radio still fails to operate properly, contact your radio provider for further assistance.

## Identifying the radio's audible tones

The radio's audible tones can help you identify a potential problem. See "[Audible tones](#)" on page 37.

## Viewing radio information

Your radio provider may ask you for the hardware and firmware version of your radio, for troubleshooting purposes.

Use the **Radio Info** menu to view information such as the hardware and firmware version of your radio, the radio serial number, and various radio identities.

- 1 Press **Menu** and select **Settings > Radio Info**.
- 2 Scroll to the radio information you want to view.

# General care

Your radio requires no regular maintenance other than ensuring that the battery has sufficient charge and that no damage has occurred to the antenna or the battery.

**Notice** To prevent permanent damage to the radio case, do not allow the radio to come into contact with detergents, alcohol, aerosol sprays, or petroleum-based products.

For general battery care, see ["Maintaining battery life and performance" on page 59](#).

## Cleaning the contacts of the battery

**Notice** Do not scratch or scrape the contacts of the battery. If necessary, wipe the contacts of the battery with a dry, lint-free cloth to remove any dirt, oil or grease.

## Cleaning the radio

If you need to clean the radio case, use a cloth dampened with clean water. Do not immerse the radio in fluids.

# Tait Software Licence Agreement

This Software License Agreement ("Agreement") is between you ("Licensee") and Tait International Limited ("Tait").

By using any of the Software items embedded and pre-loaded in the related Tait Designated Product, included on CD, downloaded from the Tait website, or provided in any other form, you agree to be bound by the terms of this Agreement. If you do not agree to the terms of this Agreement, do not install or use any of the Software. If you install or use any of the Software, that will be deemed to be acceptance of the terms of this Agreement.

For good and valuable consideration, the parties agree as follows:

## SECTION 1 DEFINITIONS

**"Confidential Information"** means all or any information supplied to or received by Licensee from Tait, whether before or after installation or use and whether directly or indirectly pertaining to the Software and Documentation supplied by Tait, including without limitation all information relating to the Designated Products, hardware, software; copyright, design registrations, trademarks; operations, processes, and related business affairs of Tait; and including any other goods or property supplied by Tait to Licensee pursuant to the terms of this Agreement.

**"Designated Products"** means products provided by Tait to Licensee with which or for which the Software and Documentation is licensed for use.

**"Documentation"** means product and software documentation that specifies technical and performance features and capabilities; user, operation, and training manuals for the

Software; and all physical or electronic media upon which such information is provided.

**"Executable Code"** means Software in a form that can be run in a computer and typically refers to machine language, which is comprised of native instructions the computer carries out in hardware. Executable code may also refer to programs written in interpreted languages that require additional software to actually execute.

**"Intellectual Property Rights"** and **"Intellectual Property"** mean the following or their substantial equivalents or counterparts, recognized by or through action before any governmental authority in any jurisdiction throughout the world and including, but not limited to all rights in patents, patent applications, inventions, copyrights, trademarks, trade secrets, trade names, and other proprietary rights in or relating to the Software and Documentation; including any adaptations, corrections, de-compilations, disassemblies, emulations, enhancements fixes, modifications, translations and updates to or derivative works from, the Software or Documentation, whether made by Tait or another party, or any improvements that result from Tait processes or, provision of information services.

**"Licensee"** means any individual or entity that has accepted the terms of this License.

**"Open Source Software"** means software with freely obtainable source code and license for modification, or permission for free distribution.

**"Open Source Software License"** means the terms or conditions under which the Open Source Software is licensed.



“**Person**” means any individual, partnership, corporation, association, joint stock company, trust, joint venture, limited liability company, governmental authority, sole proprietorship, or other form of legal entity recognized by a governmental authority.

“**Security Vulnerability**” means any flaw or weakness in system security procedures, design, implementation, or internal controls that if exercised (accidentally triggered or intentionally exploited) could result in a security breach such that data is compromised, manipulated, or stolen, or a system is damaged.

“**Software**” (i) means proprietary software in executable code format, and adaptations, translations, de-compilations, disassemblies, emulations, or derivative works of such software; (ii) means any modifications, new versions and new releases of the software provided by Tait; (iii) means any upgrades, enhancements or other functions or features to the Software provided by Tait; and (iv) may contain one or more items of software owned by a third-party supplier. The term “Software” includes the applicable “Software Key” and does not include any third-party software provided under separate license or not licensable under the terms of this Agreement.

“**Source Code**” means software expressed in human readable language necessary for understanding, maintaining, modifying, correcting, and enhancing any software referred to in this Agreement and includes all states of that software prior to its compilation into an executable programme.

“**Software Key**” means a code or key that is supplied by Tait to access, enable and use the Software or certain functions or features of the Software.

“**Tait**” means Tait International Limited and includes its Affiliates.

## **Section 2 SCOPE**

This Agreement contains the terms and conditions of the license Tait is providing to Licensee, and of Licensee’s use of the Software and Documentation. Tait and Licensee enter into this Agreement in connection with Tait delivery of certain proprietary Software and/or products containing embedded or pre-loaded proprietary Software.

## **SECTION 3 GRANT OF LICENSE**

3.1. Subject to the provisions of this Agreement and the payment of applicable license fees, Tait grants to Licensee a personal, limited, non-transferable (except as permitted in Section 7), and non-exclusive license to use the Software in executable code form, and the Documentation, solely in connection with Licensee’s use of the Designated Products for the useful life of the Designated Products. This Agreement does not grant any rights to source code.

3.2. The Licensee acknowledges that one or more Software Keys may be required from Tait for the Software or certain functions or features of the Software. The Licensee may only access, enable and use such Software or functions or features of the Software with Software Keys issued by Tait. Tait may provide the Licensee with a Software Key for the Software or certain functions or features of the Software agreed to by the parties as part of this Agreement. The Software Key may control the functions or features of the Software licensed in accordance with this Agreement. The Licensee’s license to the Software Key is limited to a license to use the Software Key only to access, enable and use the Software or certain functions or features of the Software that Tait has agreed to provide to the

Licensee and only in accordance with the Documentation.

3.3. If the Software licensed under this Agreement contains or is derived from Open Source Software, the terms and conditions governing the use of such Open Source Software are in the Open Source Software Licenses of the copyright owner and not in this Agreement. If there is a conflict between the terms and conditions of this Agreement and the terms and conditions of the any applicable Open Source Software Licenses, the terms and conditions of the Open Source Software Licenses will take precedence. For information about Open Source Components contained in Tait products and the related Open Source licenses, see:

<https://www.taitradio.com/opensource>

## **SECTION 4 LIMITATIONS ON USE**

4.1. Licensee may use the Software only for Licensee's internal business purposes and only in accordance with the Documentation. Any other use of the Software is strictly prohibited. Without limiting the general nature of these restrictions, Licensee will not make the Software available for use by third parties on a "time sharing," "application service provider," "service bureau" basis, or for any other similar commercial rental or sharing arrangement.

4.2. Licensee will not, and will not directly or indirectly allow or enable any third party to: (i) reverse engineer, disassemble, extract components, decompile, reprogram, or otherwise reduce the Software or any portion thereof to a human perceptible form or otherwise attempt to recreate the source code; (ii) modify, adapt, create derivative works of, or merge the Software; (iii) copy, reproduce, distribute, lend, or lease the Software or Documentation to any third party;

(iv) grant any sublicense or other rights in the Software or Documentation to any third party; (v) take any action that would cause the Software or Documentation to be placed in the public domain; (vi) remove, or in any way alter or obscure any copyright notice or other notice of Tait or third-party licensor's proprietary rights; (vii) provide, copy, transmit, disclose, divulge or make the Software or Documentation available to, or permit the use of the Software by, any third party or on any machine except as expressly authorized by this Agreement; or (viii) use, or permit the use of, the Software in a manner that would result in the production of a copy of the Software by any means whatsoever other than what is permitted in this Agreement. Licensee may make one copy of the Software to be used solely for archival, back-up, or disaster recovery purposes; provided that Licensee may not operate that copy of the Software at the same time as the original Software is being operated. Licensee may make as many copies of the Documentation as it may reasonably require for the internal use of the Software.

4.3. Unless otherwise authorized by Tait in writing, Licensee will not, and will not enable or allow any third party to: (i) install a copy of the Software on more than one unit of a Designated Product; or (ii) copy or transfer Software installed on one unit of a Designated Product to any other device. Licensee may temporarily transfer Software installed on a Designated Product to another device if the Designated Product is inoperable or malfunctioning. Temporary transfer of the Software to another device must be discontinued when the original Designated Product is returned to operation and the Software must be removed from the other device.

4.4. Licensee will maintain, during the term of this Agreement and for a

period of two years thereafter, accurate records relating to this license grant to verify compliance with this Agreement. Tait, or a third party nominated by Tait, may inspect Licensee's premises, books and records, upon reasonable prior notice to Licensee, during Licensee's normal business hours and subject to Licensee's facility and security regulations. Tait is responsible for the payment of all expenses and costs of the inspection, provided that Licensee shall indemnify Tait for all costs (including audit costs and legal costs on a solicitor client basis) if Licensee has breached the terms of this Agreement. Any information obtained by Tait during the course of the inspection will be kept in strict confidence by Tait and used solely for the purpose of verifying Licensee's compliance with the terms of this Agreement.

## **SECTION 5 OWNERSHIP AND TITLE**

Tait, its licensors, and its suppliers retain all of their Intellectual Property Rights in and to the Software and Documentation, in any form. No rights are granted to Licensee under this Agreement by implication, estoppel or otherwise, except for those rights which are expressly granted to Licensee in this Agreement. All Intellectual Property developed, originated, or prepared by Tait in connection with providing the Software, Designated Products, Documentation, or related services, remains vested exclusively in Tait, and Licensee will not have any shared development or other Intellectual Property Rights.

## **SECTION 6 LIMITED WARRANTY; DISCLAIMER OF WARRANTY**

6.1. The commencement date and the term of the Software warranty will be a

period of one (1) year from Tait shipment of the Software. If Licensee is not in breach of any obligations under this Agreement, Tait warrants that the unmodified Software, when used properly and in accordance with the Documentation and this Agreement, will be free from a reproducible defect that eliminates the functionality or successful operation of a feature critical to the primary functionality or successful operation of the Software. Whether a defect has occurred will be determined solely by Tait. Tait does not warrant that Licensee's use of the Software or the Designated Products will be uninterrupted, error-free, completely free of Security Vulnerabilities, or that the Software or the Designated Products will meet Licensee's particular requirements. Tait makes no representations or warranties with respect to any third-party software included in the Software.

6.2 Tait sole obligation to Licensee, and Licensee's exclusive remedy under this warranty, is to use reasonable efforts to remedy any material Software defect covered by this warranty. These efforts will involve either replacing the media or attempting to correct significant, demonstrable program or documentation errors or Security Vulnerabilities. If Tait cannot correct the defect within a reasonable time, then at Tait option, Tait will replace the defective Software with functionally equivalent Software, license to Licensee substitute Software which will accomplish the same objective, or terminate the license and refund Licensee's paid license fee. If Tait investigation of the perceived defect reveals that no such defect in fact exists, Tait may recover its costs in respect of such investigation from Licensee.

6.3. Tait disclaims any and all other warranties relating to the Software or

Documentation other than the express warranties set forth in this Section 6. Warranties in Section 6 are in lieu of all other warranties whether express or implied, oral or written, and including without limitation any and all implied warranties of condition, title, non-infringement, merchantability, or fitness for a particular purpose or use by Licensee (whether Tait knows, has reason to know, has been advised of, or is otherwise aware of any such purpose or use), whether arising by law, by reason of custom or usage of trade, or by course of dealing. In addition, Tait disclaims any warranty to any person other than Licensee with respect to the Software or Documentation.

## **SECTION 7 TRANSFERS**

7.1. Licensee will not transfer the Software or Documentation to any third party without specific prior written consent from Tait. Tait may withhold such consent or at its own discretion make the consent conditional upon the transferee paying applicable license fees and agreeing to be bound by this Agreement.

7.2. In the case of a value-added reseller or distributor of Tait Designated Products, the consent referred to in Section 7.1 may be contained in a Tait Reseller or Tait Distributor Agreement.

7.3. If the Designated Products are Tait vehicle-mounted mobile products or hand-carried portable radio products and Licensee transfers ownership of the Tait mobile or portable radio products to a third party, Licensee may assign its right to use the Software which is embedded in or furnished for use with the radio products and the related Documentation; provided that Licensee transfers all copies of the Software and Documentation to the transferee.

7.4. For the avoidance of any doubt, Section 7.3 excludes TaitNet Infrastructure, or the products listed at any time under network products at: <http://www.taitradio.com>.

7.5. If Licensee, as a contractor or subcontractor (integrator), is purchasing Tait Designated Products and licensing Software not for its own internal use but for end use only by a Customer, the Licensee may transfer such Software, but only if a) Licensee transfers all copies of such Software and the related Documentation to the transferee and b) Licensee has first obtained from its Customer (and, if Licensee is acting as a subcontractor, from the interim transferee(s) and from the ultimate end user sub license) an enforceable sublicense agreement that prohibits any other transfer and that contains restrictions substantially identical to the terms set forth in this Software License Agreement. Except as stated in the foregoing, Licensee and any transferee(s) authorised by this Section may not otherwise transfer or make available any Tait Software to any third party nor permit any party to do so. Licensee will, on request, make available evidence reasonably satisfactory to Tait demonstrating compliance with all the foregoing.

## **SECTION 8 TERM AND TERMINATION**

8.1. Licensee's right to use the Software and Documentation will commence when the Designated Products are supplied by Tait to Licensee and will continue for the life of the Designated Products with which or for which the Software and Documentation are supplied, unless Licensee breaches this Agreement, in which case this Agreement and Licensee's right to use the Software and Documentation may be terminated immediately upon notice by Tait.

8.2. Within thirty (30) days after termination of this Agreement, Licensee must certify in writing to Tait that all copies of the Software have been removed or deleted from the Designated Products and that all copies of the Software and Documentation have been returned to Tait or destroyed by Licensee and are no longer in use by Licensee.

8.3. Licensee acknowledges that Tait made a considerable investment of resources in the development, marketing, and distribution of the Software and Documentation and that Licensee's breach of this Agreement will result in irreparable harm to Tait for which monetary damages would be inadequate. If Licensee breaches this Agreement, Tait may terminate this Agreement and be entitled to all available remedies at law or in equity including immediate injunctive relief and repossession of all non-embedded Software and associated Documentation. Licensee shall pay all Tait costs (on an indemnity basis) for the enforcement of the terms of this Agreement.

## **SECTION 9 CONFIDENTIALITY**

Licensee acknowledges that the Software and Documentation contain proprietary and Confidential Information valuable to Tait and are Tait trade secrets, and Licensee agrees to respect the confidentiality of the information contained in the Software and Documentation.

## **SECTION 10 LIMITATION OF LIABILITY**

10.1. In no circumstances shall Tait be under any liability to Licensee, or any other person whatsoever, whether in Tort (including negligence), Contract (except as expressly provided in this Agreement), Equity, under any Statute, or otherwise at law for any losses or damages whether general, special, exemplary, punitive, direct,

indirect, or consequential arising out of or in connection with any use or inability of using the Software.

10.2. Licensee's sole remedy against Tait will be limited to breach of contract and Tait sole and total liability for any such claim shall be limited at the option of Tait to the repair or replacement of the Software or the refund of the purchase price of the Software.

## **SECTION 11 GENERAL**

11.1. COPYRIGHT NOTICES. The existence of a copyright notice on the Software will not be construed as an admission or presumption of publication of the Software or public disclosure of any trade secrets associated with the Software.

11.2. COMPLIANCE WITH LAWS. Licensee acknowledges that the Software may be subject to the laws and regulations of the jurisdiction covering the supply of the Designated Products and will comply with all applicable laws and regulations, including export laws and regulations, of that country.

11.3. ASSIGNMENTS AND SUBCONTRACTING. Tait may assign its rights or subcontract its obligations under this Agreement, or encumber or sell its rights in any Software, without prior notice to, or consent of, Licensee.

11.4. GOVERNING LAW. This Agreement shall be subject to and construed in accordance with New Zealand law and disputes between the parties concerning the provisions hereof shall be determined by the New Zealand Courts of Law. Provided however Tait may at its election bring proceedings for breach of the terms hereof or for the enforcement of any judgment in relation to a breach of the terms hereof in any jurisdiction Tait considers fit for the purpose of ensuring compliance with the terms hereof or obtaining relief for breach of the terms hereof.

## 11.5. THIRD-PARTY

**BENEFICIARIES.** This Agreement is entered into solely for the benefit of Tait and Licensee. No third party has the right to make any claim or assert any right under this Agreement, and no third party is deemed a beneficiary of this Agreement. Notwithstanding the foregoing, any licensor or supplier of third-party software included in the Software will be a direct and intended third-party beneficiary of this Agreement.

**11.6. SURVIVAL.** Sections 4, 5, 6.3, 7, 8, 9, 10, and 11 survive the termination of this Agreement.

**11.7. ORDER OF PRECEDENCE.** In the event of inconsistencies between this Agreement and any other Agreement between the parties, the parties agree that, with respect to the specific subject matter of this Agreement, this Agreement prevails.

**11.8 SECURITY.** Tait uses reasonable means in the design and writing of its own Software and the acquisition of third-party Software in order to limit Security Vulnerabilities. While no software can be guaranteed to be free from Security Vulnerabilities, if a Security Vulnerability is discovered, Tait will take the steps specified in Section 6 of this Agreement.

**11.9 EXPORT.** Licensee will not transfer, directly or indirectly, any Designated Product, Documentation or Software furnished hereunder or the direct product of such Documentation or Software to any country for which New Zealand or any other applicable country requires an export license or other governmental approval without first obtaining such license or approval.

**11.10 SEVERABILITY.** In the event that any part or parts of this Agreement shall be held illegal or null and void by any court or administrative body of competent jurisdiction, such determination shall not affect the

remaining terms which shall remain in full force and effect as if such part or parts held to be illegal or void had not been included in this Agreement. Tait may replace the invalid or unenforceable provision with a valid and enforceable provision that achieves the original intent and economic effect of this Agreement.

**11.11 CONSUMER GUARANTEES.** Licensee acknowledges that the licenses supplied in terms of this agreement are supplied to Licensee in business, and that the guarantees and other provisions of prevailing consumer protection legislation shall not apply.

**11.12 WHOLE AGREEMENT.** Licensee acknowledges that it has read this Agreement, understands it and agrees to be bound by its terms and conditions. Licensee also agrees that, subject only to the express terms of any other agreement between Tait and Licensee to the contrary, this is the complete and exclusive statement of the Agreement between it and Tait in relation to the Software. This Agreement supersedes any proposal or prior agreement, oral or written, and any other communications between Licensee and Tait relating to the Software and the Designated Products.

## Simplified Declaration of Conformity

**EN** Hereby, Tait International Limited declares that the radio equipment type TPEB1F, TPEB1G, TPEHGF, TPEHGG, TPEH7F & TPEH7G is in compliance with Directive 2014/53/EU.

The full text of the EU declaration of conformity is available at the following internet address:

[www.taitradio.com/eudoc](http://www.taitradio.com/eudoc)

**BG** С настоящото Tait International Limited декларира, че този тип радиосъоръжение TPEB1F, TPEB1G, TPEHGF, TPEHGG, TPEH7F & TPEH7G е в съответствие с Директива 2014/53/ЕС.

Цялостният текст на ЕС декларацията за съответствие може да се намери на следния интернет адрес: [www.taitradio.com/eudoc](http://www.taitradio.com/eudoc)

**ES** Por la presente, Tait International Limited declara que el tipo de equipo radioeléctrico TPEB1F, TPEB1G, TPEHGF, TPEHGG, TPEH7F & TPEH7G es conforme con la Directiva 2014/53/UE.

El texto completo de la declaración UE de conformidad está disponible en la dirección Internet siguiente: [www.taitradio.com/eudoc](http://www.taitradio.com/eudoc)

**CS** Tímto Tait International Limited prohlašuje, že typ rádiového zařízení TPEB1F, TPEB1G, TPEHGF, TPEHGG, TPEH7F & TPEH7G je v souladu se směrnicí 2014/53/EU.

Úplné znění EU prohlášení o shodě je k dispozici na této internetové adrese: [www.taitradio.com/eudoc](http://www.taitradio.com/eudoc)

**DA** Hermed erklærer Tait International Limited, at radioudstyrstypen TPEB1F, TPEB1G, TPEHGF, TPEHGG, TPEH7F & TPEH7G er i overensstemmelse med direktiv 2014/53/EU. EU-overensstemmelseserklæringens fulde tekst kan findes på følgende internetadresse: [www.taitradio.com/eudoc](http://www.taitradio.com/eudoc)

**DE** Hiermit erklärt Tait International Limited, dass der Funkanlagentyp TPEB1F, TPEB1G, TPEHGF, TPEHGG, TPEH7F & TPEH7G der Richtlinie 2014/53/EU entspricht.

Der vollständige Text der EU-Konformitätserklärung ist unter der folgenden Internetadresse verfügbar: [www.taitradio.com/eudoc](http://www.taitradio.com/eudoc)

**ET** Käesolevaga deklareerib Tait TPEB1F, TPEB1G, TPEHGF, TPEHGG, TPEH7F & TPEH7G vastab direktiivi 2014/53/EL nõuetele.

ELi vastavusdeklaratsiooni täielik tekst on kättesaadav järgmisel internetiaadressil: [www.taitradio.com/eudoc](http://www.taitradio.com/eudoc)

**EL** Με την παρούσα ο/η Tait International Limited, δηλώνει ότι ο ραδιοεξοπλισμός TPEB1F, TPEB1G, TPEHGF, TPEHGG, TPEH7F & TPEH7G πληροί την οδηγία 2014/53/ΕΕ.

Το πλήρες κείμενο της δήλωσης συμμόρφωσης ΕΕ διατίθεται στην ακόλουθη ιστοσελίδα στο διαδίκτυο: [www.taitradio.com/eudoc](http://www.taitradio.com/eudoc)

**FR** Le soussigné Tait International Limited, déclare que l'équipement radioélectrique du type TPEB1F, TPEB1G, TPEHGF, TPEHGG, TPEH7F & TPEH7G est conforme à la directive 2014/53/UE.

Le texte complet de la déclaration UE de conformité est disponible à l'adresse internet suivante: [www.taitradio.com/eudoc](http://www.taitradio.com/eudoc)

**HR** Tait International Limited ovime izjavljuje da je radijska oprema tipa TPEB1F, TPEB1G, TPEHGF, TPEHGG, TPEH7F & TPEH7G u skladu s Direktivom 2014/53/EU.

Cjeloviti tekst EU izjave o sukladnosti dostupan je na sljedećoj internetskoj adresi: [www.taitradio.com/eudoc](http://www.taitradio.com/eudoc)

**IT** Il fabbricante, Tait International Limited, dichiara che il tipo di apparecchiatura radio TPEB1F, TPEB1G, TPEHGF, TPEHGG, TPEH7F & TPEH7G è conforme alla direttiva 2014/53/UE.

Il testo completo della dichiarazione di conformità UE è disponibile al seguente indirizzo Internet: [www.taitradio.com/eudoc](http://www.taitradio.com/eudoc)

**LV** Ar šo Tait International Limited deklarē, ka radioiekārta TPEB1F, TPEB1G, TPEHGF, TPEHGG, TPEH7F & TPEH7G atbilst Direktīvai 2014/53/ES.

Pilns ES atbilstības deklarācijas teksts ir pieejams šādā interneta vietnē:

[www.taitradio.com/eudoc](http://www.taitradio.com/eudoc)

**LT** Aš, Tait International Limited, patvirtinu, kad radijo įrenginių tipas TPEB1F, TPEB1G, TPEHGF, TPEHGG, TPEH7F & TPEH7G atitinka Direktyvą 2014/53/ES.

Visas ES atitikties deklaracijos tekstas prieinamas šiuo interneto adresu:

[www.taitradio.com/eudoc](http://www.taitradio.com/eudoc)

**HU** Tait International Limited igazolja, hogy a TPEB1F, TPEB1G, TPEHGF, TPEHGG, TPEH7F & TPEH7G típusú rádióberendezés megfelel a 2014/53/EU irányelvnek.

Az EU-megfelelőségi nyilatkozat teljes szövege elérhető a következő internetes címen: [www.taitradio.com/eudoc](http://www.taitradio.com/eudoc)

MT B'dan, Tait International Limited, niddikjara li dan it-tip ta' taghmir tar-radju TPEB1F, TPEB1G, TPEHGF, TPEHGG, TPEH7F & TPEH7G huwa konformi mad-Direttiva 2014/53/UE.

It-test kollu tad-dikjarazzjoni ta' konformità tal-UE huwa disponibbli f'dan l-indirizz tal-Internet li ġej: [www.taitradio.com/eudoc](http://www.taitradio.com/eudoc)

NL Hierbij verklaar ik, Tait International Limited, dat het type radioapparatuur TPEB1F, TPEB1G, TPEHGF, TPEHGG, TPEH7F & TPEH7G conform is met Richtlijn 2014/53/EU.

De volledige tekst van de EU-conformiteitsverklaring kan worden geraadpleegd op het volgende internetadres: [www.taitradio.com/eudoc](http://www.taitradio.com/eudoc)

PL Tait International Limited niniejszym oświadcza, że typ urządzenia radiowego TPEB1F, TPEB1G, TPEHGF, TPEHGG, TPEH7F & TPEH7G jest zgodny z dyrektywą 2014/53/UE.

Pełny tekst deklaracji zgodności UE jest dostępny pod następującym adresem internetowym:

[www.taitradio.com/eudoc](http://www.taitradio.com/eudoc)

PT O(a) abaixo assinado(a) Tait International Limited declara que o presente tipo de equipamento de rádio TPEB1F, TPEB1G, TPEHGF, TPEHGG, TPEH7F & TPEH7G está em conformidade com a Diretiva 2014/53/UE.

O texto integral da declaração de conformidade está disponível no seguinte endereço de Internet: [www.taitradio.com/eudoc](http://www.taitradio.com/eudoc)

RO Prin prezenta, Tait International Limited declară că tipul de echipamente radio TPEB1F, TPEB1G, TPEHGF, TPEHGG, TPEH7F & TPEH7G este în conformitate cu Directiva 2014/53/UE.

Textul integral al declarației UE de conformitate este disponibil la următoarea adresă internet: [www.taitradio.com/eudoc](http://www.taitradio.com/eudoc)

SK Tait International Limited týmto vyhlasuje, že rádiové zariadenie typu TPEB1F, TPEB1G, TPEHGF, TPEHGG, TPEH7F & TPEH7G je v súlade so smernicou 2014/53/EU.

Úplné EÚ vyhlásenie o zhode je k dispozícii na tejto internetovej adrese: [www.taitradio.com/eudoc](http://www.taitradio.com/eudoc)

SL Tait International Limited potrjuje, da je tip radijske opreme TPEB1F, TPEB1G, TPEHGF, TPEHGG, TPEH7F & TPEH7G skladen z Direktivo 2014/53/EU.

Celotno besedilo izjave EU o skladnosti je na voljo na naslednjem spletnem naslovu:

[www.taitradio.com/eudoc](http://www.taitradio.com/eudoc)

FI Tait International Limited vakuuttaa, että radiolaitetyyppi TPEB1F, TPEB1G, TPEHGF, TPEHGG, TPEH7F & TPEH7G on direktiivin 2014/53/EU mukainen.

EU-vaatimustenmukaisuusvakuutuksen täysimittainen teksti on saatavilla seuraavassa internetosoitteessa: [www.taitradio.com/eudoc](http://www.taitradio.com/eudoc)  
SV Härmed försäkrar Tait International Limited att denna typ av radioutrustning TPEB1F, TPEB1G, TPEHGF, TPEHGG, TPEH7F & TPEH7G överensstämmer med direktiv 2014/53/EU.

Den fullständiga texten till EU-försäkran om överensstämmelse finns på följande webbadress: [www.taitradio.com/eudoc](http://www.taitradio.com/eudoc)