



TESTING LABORATORY
CERTIFICATE #4820.01



FCC PART 27 MEASUREMENT AND TEST REPORT

For

Tait International Limited

245 Wooldridge Road, Harewood, 1645, Christchurch, New Zealand

FCC ID: CASTPDK5B

Report Type: Class II Permissive Change	Product Type: Portable Radio
Report Number: RDG190514001-00	
Report Date: 2019-05-27	
Reviewed By: Jerry Zhang EMC Manager	<i>Jerry Zhang</i>
Test Laboratory: Bay Area Compliance Laboratories Corp. (Dongguan) No.69 Pulongcun, Puxinhu Industry Area, Tangxia, Dongguan, Guangdong, China Tel: +86-769-86858888 Fax: +86-769-86858891 www.baclcorp.com.cn	

Note: This test report is prepared for the customer shown above and for the device described herein. It may not be duplicated or used in part without prior written consent from Bay Area Compliance Laboratories Corp. (Dongguan). This report must not be used by the customer to claim product certification, approval, or endorsement by A2LA* or any agency of the Federal Government. * This report may contain data that are not covered by the A2LA accreditation and are marked with an asterisk “*”.

TABLE OF CONTENTS

GENERAL INFORMATION.....	3
PRODUCT DESCRIPTION FOR EQUIPMENT UNDER TEST (EUT)	3
OBJECTIVE	3
RELATED SUBMITTAL(S)/GRANT(S).....	3
TEST METHODOLOGY	3
MEASUREMENT UNCERTAINTY	4
TEST FACILITY	4
SYSTEM TEST CONFIGURATION.....	5
DESCRIPTION OF TEST CONFIGURATION	5
EQUIPMENT MODIFICATIONS	5
SUPPORT EQUIPMENT LIST AND DETAILS	5
BLOCK DIAGRAM OF TEST SETUP	5
SUMMARY OF TEST RESULTS	6
FCC §2.1047 - MODULATION CHARACTERISTIC	7
APPLICABLE STANDARD	7
TEST PROCEDURE	7
TEST DATA	7
FCC § 2.1046& § 27.50 - RF OUTPUT POWER.....	11
APPLICABLE STANDARD	11
TEST PROCEDURE	11
TEST EQUIPMENT LIST AND DETAILS.....	11
TEST DATA	11
FCC §2.1049& §27.53- OCCUPIED BANDWIDTH.....	13
APPLICABLE STANDARD	13
TEST PROCEDURE	13
TEST EQUIPMENT LIST AND DETAILS.....	13
TEST DATA	13
FCC §2.1051, §27.53 - SPURIOUS EMISSIONS AT ANTENNA TERMINALS	19
APPLICABLE STANDARD	19
TEST PROCEDURE	19
TEST EQUIPMENT LIST AND DETAILS.....	19
TEST DATA	19
FCC §2.1053 & §27.53 - SPURIOUS RADIATED EMISSIONS	28
APPLICABLE STANDARD	28
TEST PROCEDURE	28
TEST EQUIPMENT LIST AND DETAILS.....	29
TEST DATA	29
FCC §2.1055& §27.54 - FREQUENCY STABILITY.....	31
APPLICABLE STANDARD	31
TEST PROCEDURE	31
TEST EQUIPMENT LIST AND DETAILS.....	31
TEST DATA	32

GENERAL INFORMATION

Product Description for Equipment under Test (EUT)

EUT Name:		Portable Radio
EUT Model:		TPDK5B
Operation Frequency:		787-788MHz
Rated Output Power(Conducted):		3W(High Power Level) 1W(Low Power Level)
Modulation Type:		FM,4FSK,FFSK
Channel Spacing:		12.5 kHz
Rated Input Voltage:		7.5V DC from battery and 12VDC from charger base
Adapter Information	Model:	ZD24W120200
	Input:	AC 100-240V, 50/60Hz,0.8A
	Output:	DC 12V, 2A
External Dimension:		155mm(L)*62mm(W)*44mm(H)
Serial Number:		26054495
EUT Received Date:		2019.5.15

Objective

This report is prepared on behalf of *Tait International Limited* in accordance with: Part 2-Subpart J, Part 27 of the Federal Communication Commissions rules.

This is Class II Permissive change application, the difference with original is:

- 1) add part 27 frequency range 787-788 MHz to the TNF certification

The changes between the previous device and the current one are stated and guaranteed by the applicant, the differences between them only affect part 27 results.

Related Submittal(s)/Grant(s)

No

Test Methodology

All tests and measurements indicated in this document were performed in accordance with the Code of Federal Regulations Title 47 Part 2, Sub-part J as well as the following parts:

Part 27 – Miscellaneous wireless communications services

Applicable Standards: TIA/EIA 603-D-2010.

All radiated and conducted emissions measurements were performed at Bay Area Compliance Laboratories Corp.(Dongguan).

Measurement Uncertainty

Parameter	Measurement Uncertainty
Occupied Channel Bandwidth	$\pm 5\%$
RF output power, conducted	$\pm 0.61\text{dB}$
Unwanted Emissions, radiated	30MHz ~ 1GHz: 5.85 dB 1G~26.5GHz: 5.23 dB
Unwanted Emissions, conducted	$\pm 1.5\text{ dB}$
Temperature	$\pm 1^\circ\text{C}$
Humidity	$\pm 5\%$
DC and low frequency voltages	$\pm 0.4\%$
Duty Cycle	1%

Test Facility

The Test site used by Bay Area Compliance Laboratories Corp. (Dongguan) to collect test data is located on the No.69 Pulongcun, Puxinhu Industry Area, Tangxia, Dongguan, Guangdong, China.

The lab has been recognized as the FCC accredited lab under the KDB 974614 D01 and is listed in the FCC Public Access Link (PAL) database, FCC Registration No. : 897218, the FCC Designation No. : CN1220.

The lab has been recognized by Innovation, Science and Economic Development Canada to test to Canadian radio equipment requirements, the CAB identifier : CN0022.

SYSTEM TEST CONFIGURATION

Description of Test Configuration

The system was configured for testing in a test mode which has been done in the factory.

Equipment Modifications

No modification was made to the EUT.

Support Equipment List and Details

Manufacturer	Description	Model	Serial Number
Unknown	50 Load Terminal	100W	100W-1

Block Diagram of Test Setup

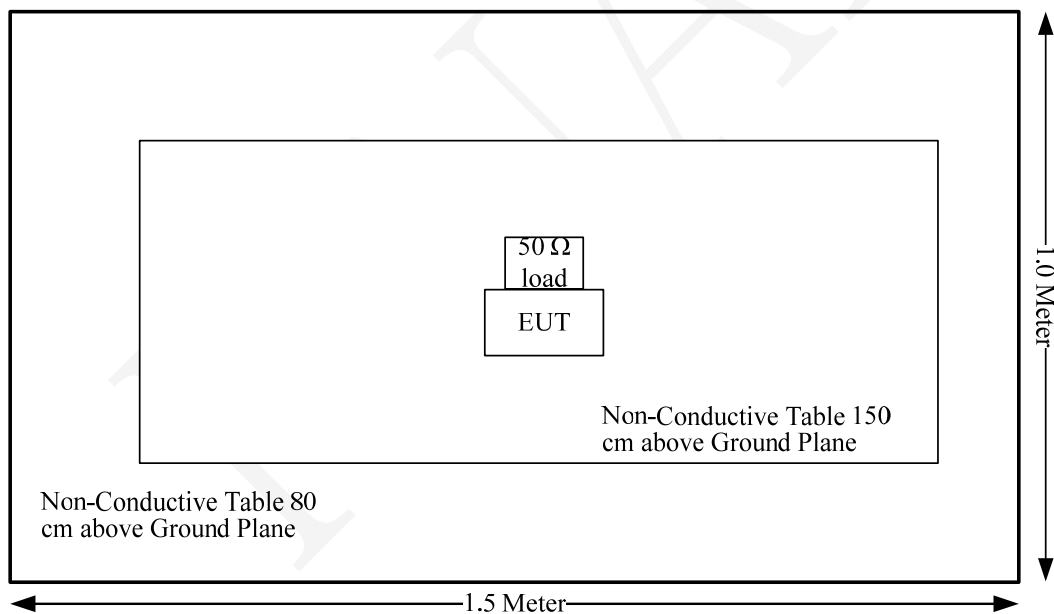

SUMMARY OF TEST RESULTS

FCC Rules	Description of Test	Result
§2.1046; §27.50	RF Output Power	Compliance
§ 2.1047	Modulation Characteristics	Compliance
§ 2.1049; §27.53	Occupied Bandwidth	Compliance
§ 2.1051, §27.53	Spurious Emissions at Antenna Terminal	Compliance
§ 2.1053 §27.53	Field Strength of Spurious Radiation	Compliance
§ 2.1051;§27.53	Out of band emission, Band Edge	Compliance
§ 2.1055;§27.54	Frequency stability vs. temperature Frequency stability vs. voltage	Compliance

FCC §2.1047 - MODULATION CHARACTERISTIC

Applicable Standard

FCC §2.1047

- (a) Equipment which utilizes voice modulated communication shall show the frequency response of the audio modulating circuit over a range of 100 to 5000 Hz. for equipment which is required to have a low pass filter, the frequency response of the filter, or all of the circuitry installed between the modulation limited and the modulated stage shall be supplied.
- (b) Equipment which employs modulation limiting, a curve showing the percentage of modulation versus the modulation input voltage shall be supplied.

Test Equipment List and Details

Manufacturer	Description	Model	Serial Number	Calibration Date	Calibration Due Date
HP	RF Communications Test Set	8920A	3438A05201	2019-01-04	2020-01-04
UNI-T	Multimeter	UT39A	M130199938	2018-07-24	2019-07-24
Pro instrument	DC Power Supply	pps3300	3300012	N/A	N/A
Agilent	MXG Vector Signal Generator	N5182B	MY51350142	2018-07-19	2019-07-19

* **Statement of Traceability:** Bay Area Compliance Laboratories Corp. (Dongguan) attests that all calibrations have been performed, traceable to National Primary Standards and International System of Units (SI).

Test Procedure

Test Method: TIA/EIA-603 2.2.3

Test Data

Environmental Conditions

Temperature:	25.8 °C
Relative Humidity:	46%
ATM Pressure:	100.2 kPa

The testing was performed by Andy Huang on 2019-05-24

Test Mode: Transmitting

Result: Compliance.

Audio Frequency Response – High Power,12.5kHz

Carrier Frequency: 787.7MHz, Channel Separation:12.5kHz

Modulation Frequency (Hz)	Response data (dB)
300	-10.44
400	-7.79
500	-5.77
600	-4.41
700	-2.98
800	-1.89
900	-0.94
1000	0.00
1200	1.77
1400	2.93
1600	3.97
1800	5.12
2000	6.04
2200	6.88
2400	7.46
2600	8.01
2800	8.79
3000	7.24

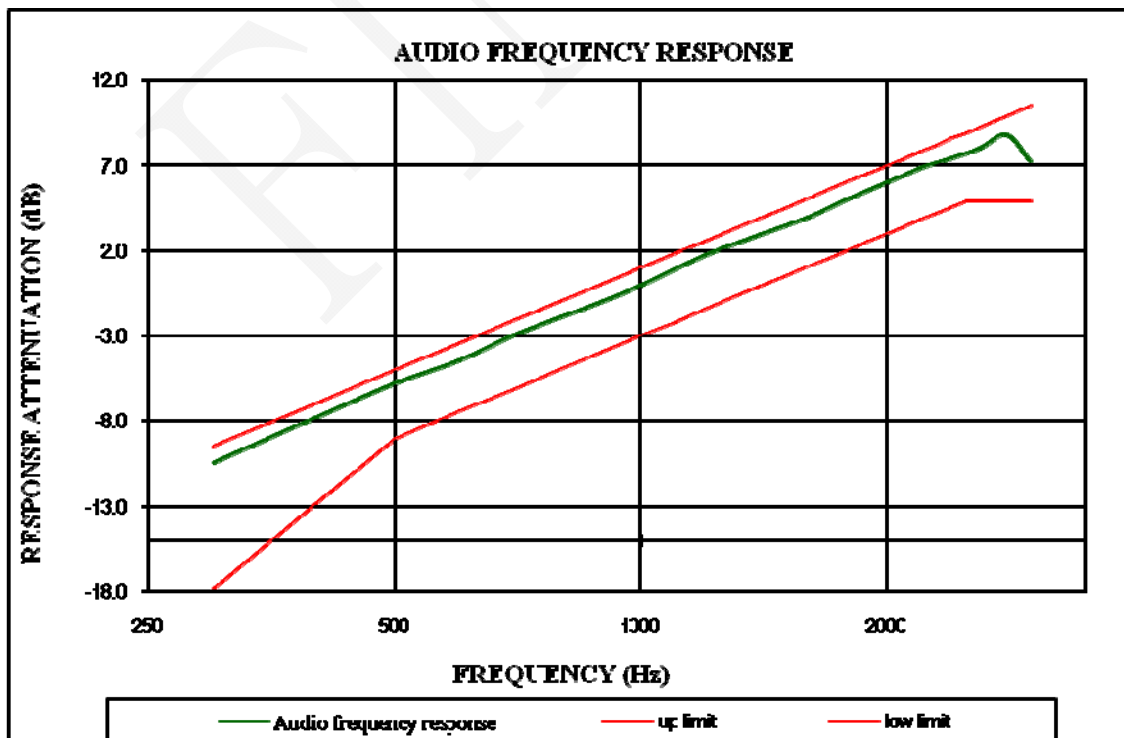

MODULATION LIMITING – High Power

Carrier Frequency: 787.5 MHz, Channel Separation:12.5kHz

Audio Frequency (Hz)	Instantaneous		Steady-state		Limit [kHz]
	Deviation (@+20dB) [kHz]	Deviation (@-20dB) [kHz]	Deviation (@+20dB) [kHz]	Deviation (@-20dB) [kHz]	
300	1.49	0.17	1.47	0.15	2.5
400	1.76	0.23	1.72	0.20	2.5
500	1.89	0.29	1.87	0.26	2.5
600	1.83	0.22	1.80	0.21	2.5
700	1.82	0.29	1.79	0.27	2.5
800	1.91	0.33	1.88	0.30	2.5
900	1.88	0.26	1.86	0.24	2.5
1000	1.89	0.37	1.88	0.35	2.5
1200	2.04	0.29	2.03	0.28	2.5
1400	2.06	0.32	2.03	0.31	2.5
1600	2.11	0.39	2.09	0.36	2.5
1800	2.10	0.47	2.06	0.43	2.5
2000	2.13	0.46	2.10	0.42	2.5
2200	2.20	0.44	2.19	0.40	2.5
2400	2.22	0.53	2.22	0.48	2.5
2600	2.25	0.55	2.21	0.53	2.5
2800	2.26	0.57	2.25	0.56	2.5
3000	2.02	0.53	1.99	0.50	2.5

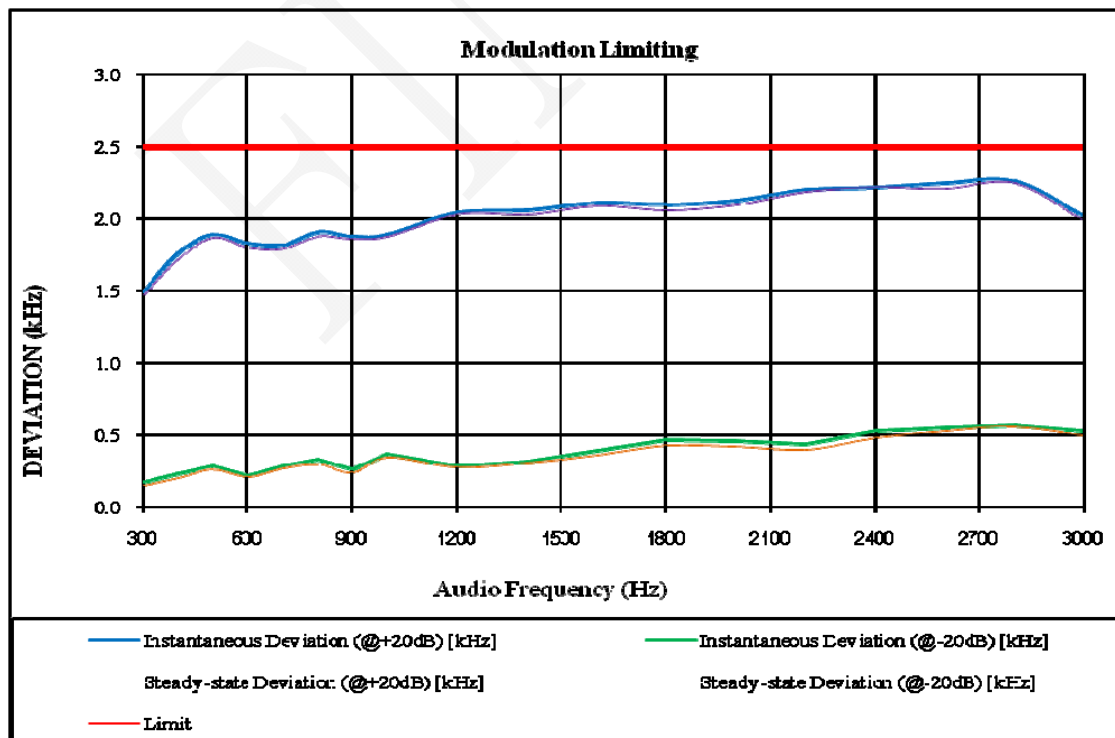

Audio Frequency Low Pass Filter Response – High Power

Carrier Frequency: 787.5 MHz, Channel Spacing = 12.5 kHz

Audio Frequency	Response Attenuation	Limit
kHz	dB	dB
3.0	-3.9	0.0
3.5	-10.7	-6.7
4.0	-17.2	-12.5
5.0	-27.6	-22.2
7.0	-39.4	-36.8
10.0	-58.3	-52.3
15.0	-78.1	-69.9
20.0	-86.7	-82.5
30.0	-86.9	-82.5
50.0	-86.9	-82.5
70.0	-87.3	-82.5

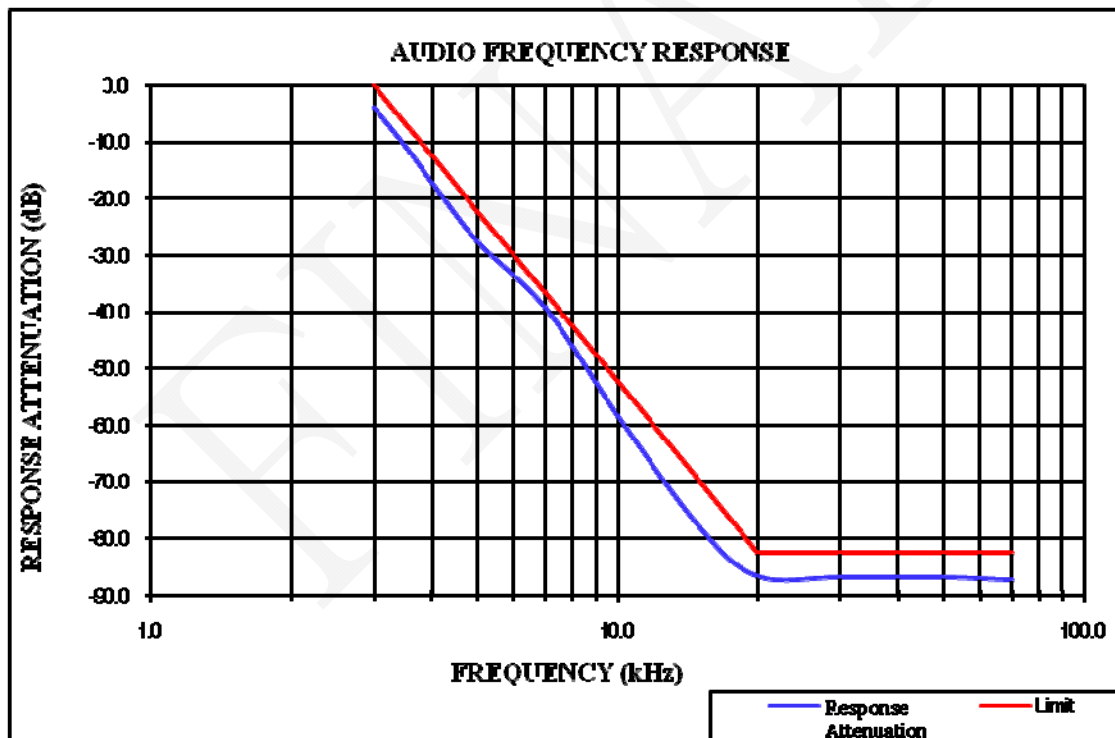

FCC § 2.1046& § 27.50 - RF OUTPUT POWER

Applicable Standard

According to §27.50

(b)(10) Portable stations (hand-held devices) transmitting in the 746-757 MHz, 776-788 MHz, and 805-806 MHz bands are limited to 3 watts ERP.

Test Procedure

Conducted RF Output Power:

The RF output of the transmitter was connected to the input of the spectrum analyzer through sufficient attenuation.

Spectrum Analyzer Setting:

RBW	VBW
100 kHz	300 kHz

Test Equipment List and Details

Manufacturer	Description	Model	Serial Number	Calibration Date	Calibration Due Date
Rohde & Schwarz	Signal Analyzer	FSIQ26	831929/005	2018-08-03	2019-08-03
Unknown	Coaxial Cable	C-SJ00-0010	C0010/02	Each time	N/A
E-Microwave	Blocking Control	EMDCB-00036	0E01201048	Each time	N/A

* **Statement of Traceability:** Bay Area Compliance Laboratories Corp. (Dongguan) attests that all calibrations have been performed, traceable to National Primary Standards and International System of Units (SI).

Test Data

Environmental Conditions

Temperature:	25.8 °C
Relative Humidity:	46%
ATM Pressure:	100.2 kPa

**The testing was performed by Andy Huang on 2019-05-24*

Output Power:

Modulation Mode	Channel Separation	f _c	Power Level	Conducted Output Power
		MHz		dBm
FM	12.5kHz	787.5	High	33.88
4FSK				33.86
FFSK (1200 bps)				33.88
FFSK (2400 bps)				34.12
FM			Low	29.69
4FSK				29.73
FFSK (1200 bps)				29.52
FFSK (2400 bps)				29.95

Note:

ERP = Reading +Antenna Gain(dBi)-2.15

ERP limit is 3W(34.77dBm), the maximum allowed antenne gain is 2.8dBi.

FCC §2.1049& §27.53- OCCUPIED BANDWIDTH

Applicable Standard

FCC §2.1049, and §27.53.

Test Procedure

The RF output of the transmitter was connected to the simulator and the spectrum analyzer through sufficient attenuation.

The 26 dB & 99% bandwidth was recorded.

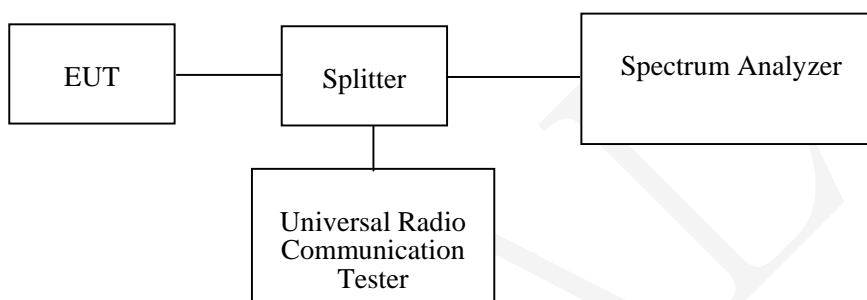

Test Equipment List and Details

Manufacturer	Description	Model	Serial Number	Calibration Date	Calibration Due Date
Rohde & Schwarz	Signal Analyzer	FSIQ26	831929/005	2018-08-03	2019-08-03
Unknown	Coaxial Cable	C-SJ00-0010	C0010/02	Each time	N/A
E-Microwave	Blocking Control	EMDCB-00036	0E01201048	Each time	N/A

* **Statement of Traceability:** Bay Area Compliance Laboratories Corp. (Dongguan) attests that all calibrations have been performed, traceable to National Primary Standards and International System of Units (SI).

Test Data

Environmental Conditions

Temperature:	26.2~27.9 °C
Relative Humidity:	46~49%
ATM Pressure:	100.5~100.8kPa

The testing was performed by Andy Huang from 2019-05-16 to 2019-05-18

Test Mode: Transmitting

Test Result: Compliant. Please refer to the following table and plots.

Modulation Mode	Channel Separation	f _c	99% Occupied Bandwidth	26 dB Bandwidth	Power Level
		MHz	kHz	kHz	
FM	12.5kHz	787.5	9.920	10.421	High
			9.920	10.321	Low
4FSK	12.5kHz		7.615	9.820	High
			7.415	9.519	Low
FFSK(1200 bps)	12.5kHz		5.912	7.615	High
			6.012	7.615	Low
FFSK(2400 bps)	12.5kHz		5.311	6.112	High
			5.411	5.912	Low

FINAL

FM,12.5kHz,High Power - Frequency 787.5MHz: 99% Occupied & 26 dB Bandwidth

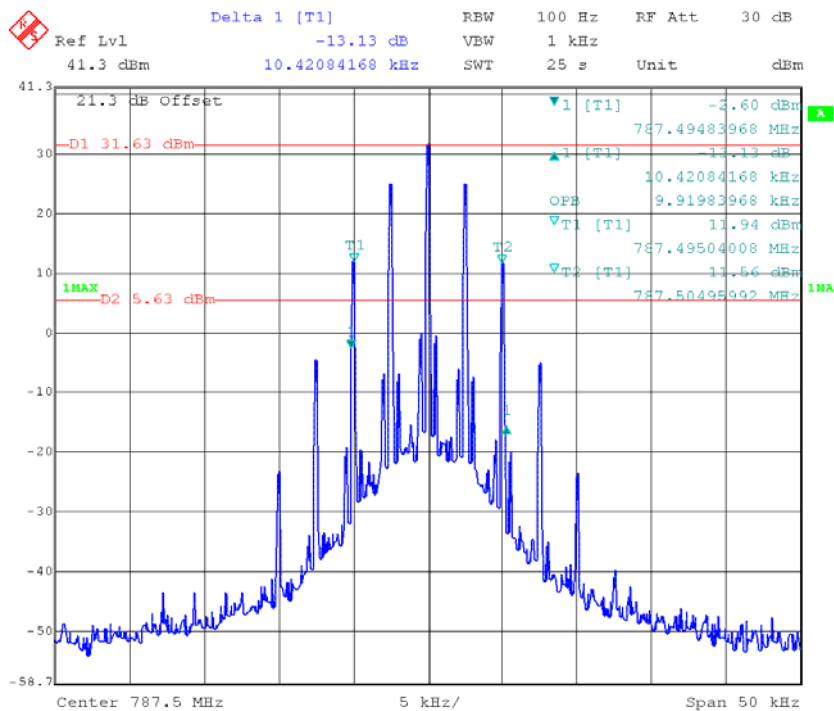

FM,12.5kHz,Low Power - Frequency 787.5 MHz: 99% Occupied & 26 dB Bandwidth

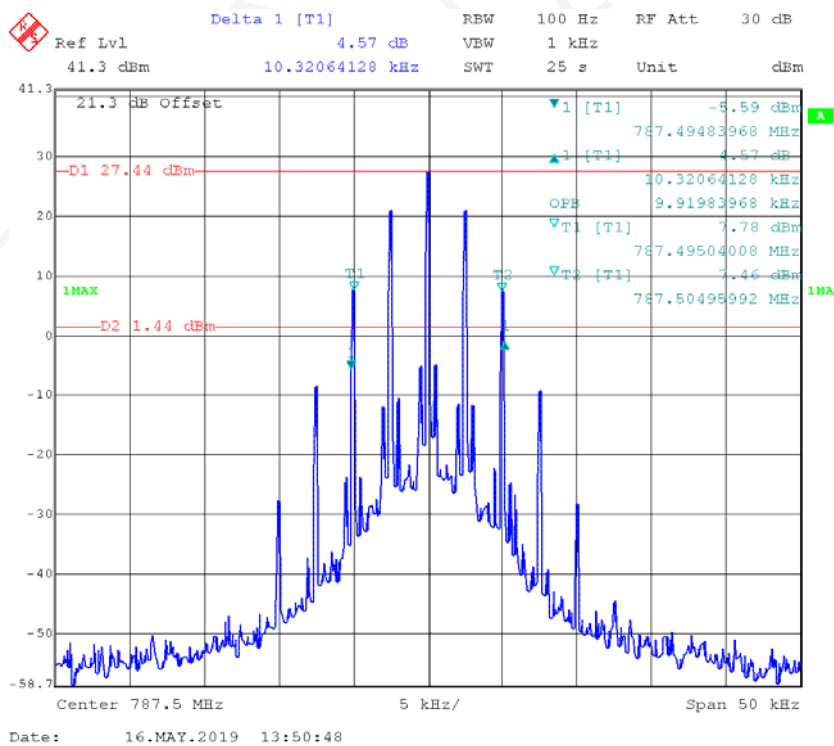

4FSK,12.5kHz,High Power - Frequency 453.2125MHz: 99% Occupied & 26 dB Bandwidth

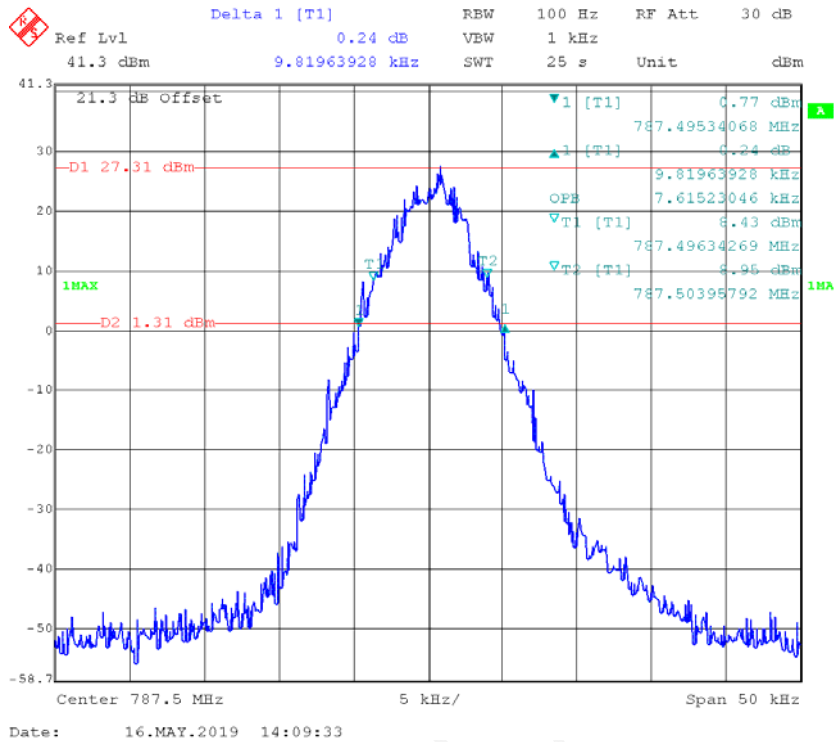

4FSK,12.5kHz,Low Power - Frequency 453.2125MHz: 99% Occupied & 26 dB Bandwidth

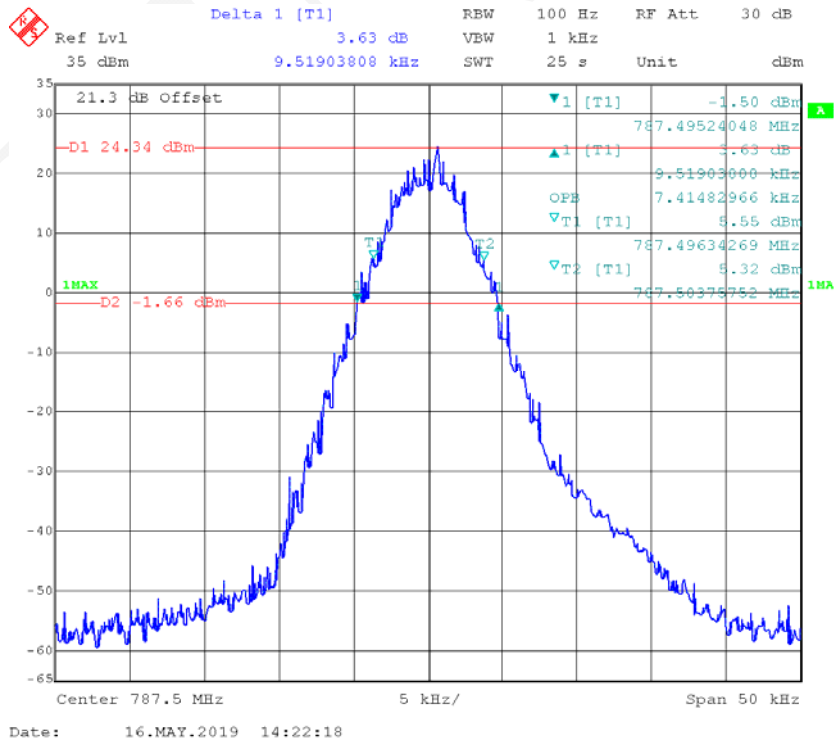

FFSK/1200,12.5kHz,High Power - Frequency 787.5MHz: 99% Occupied & 26 dB Bandwidth

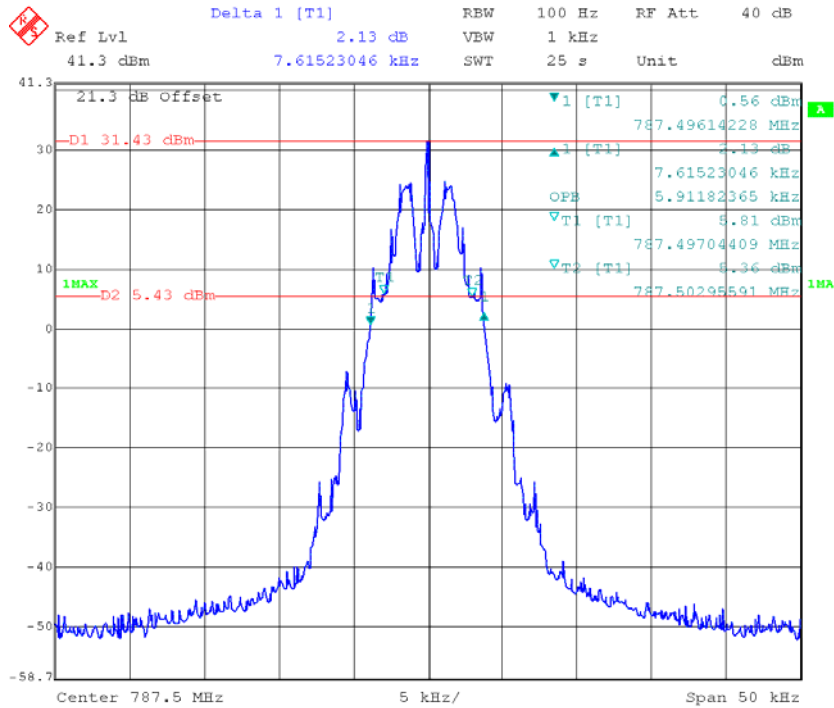

Date: 16.MAY.2019 15:50:02

FFSK/1200,12.5kHz,Low Power - Frequency 787.5 MHz: 99% Occupied & 26 dB Bandwidth

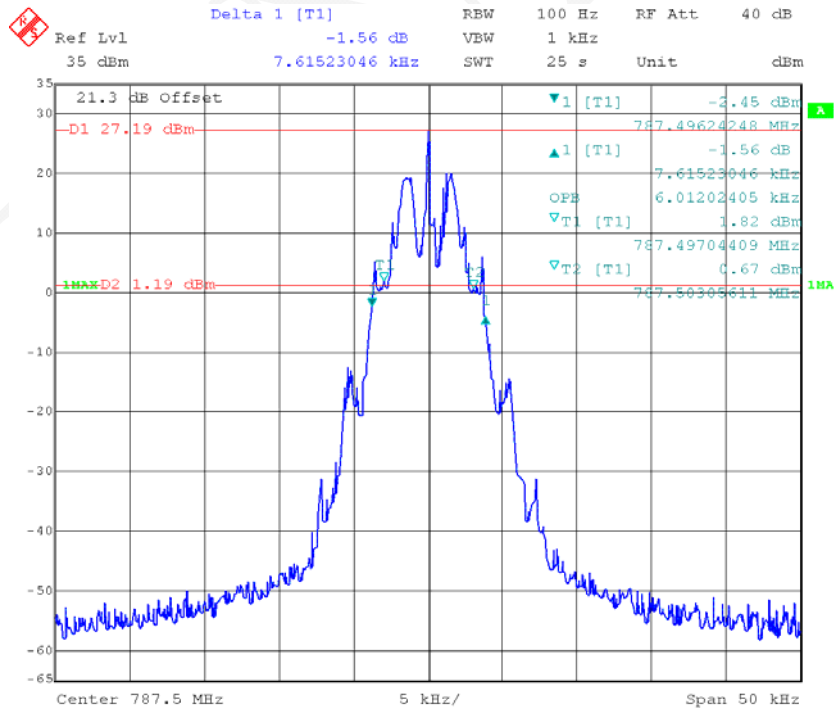

Date: 16.MAY.2019 16:03:55

FFSK/2400,12.5kHz,High Power - Frequency 787.5MHz: 99% Occupied & 26 dB Bandwidth

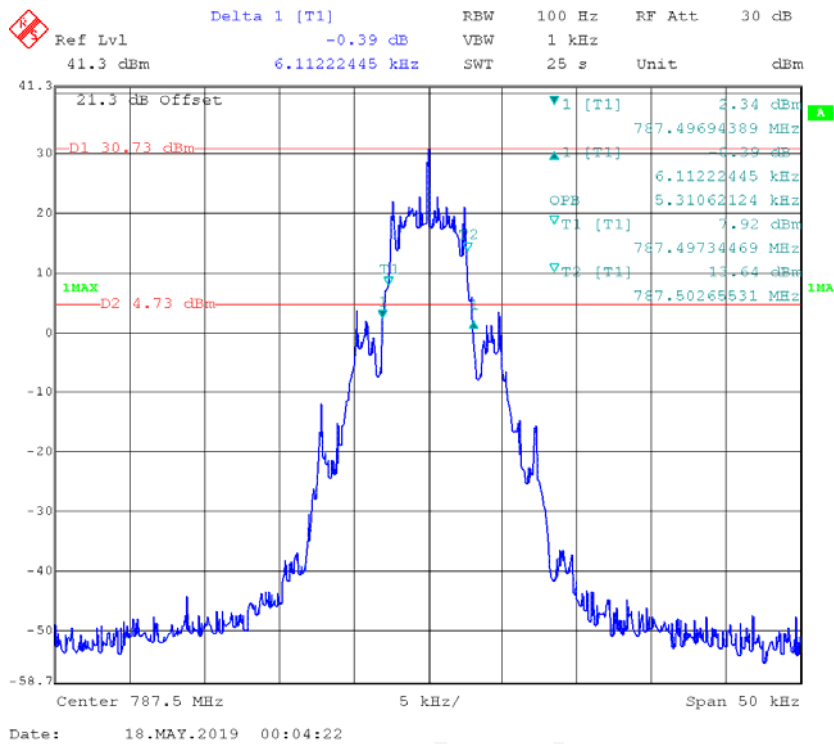

FFSK/2400,12.5kHz,Low Power - Frequency 787.5MHz: 99% Occupied & 26 dB Bandwidth

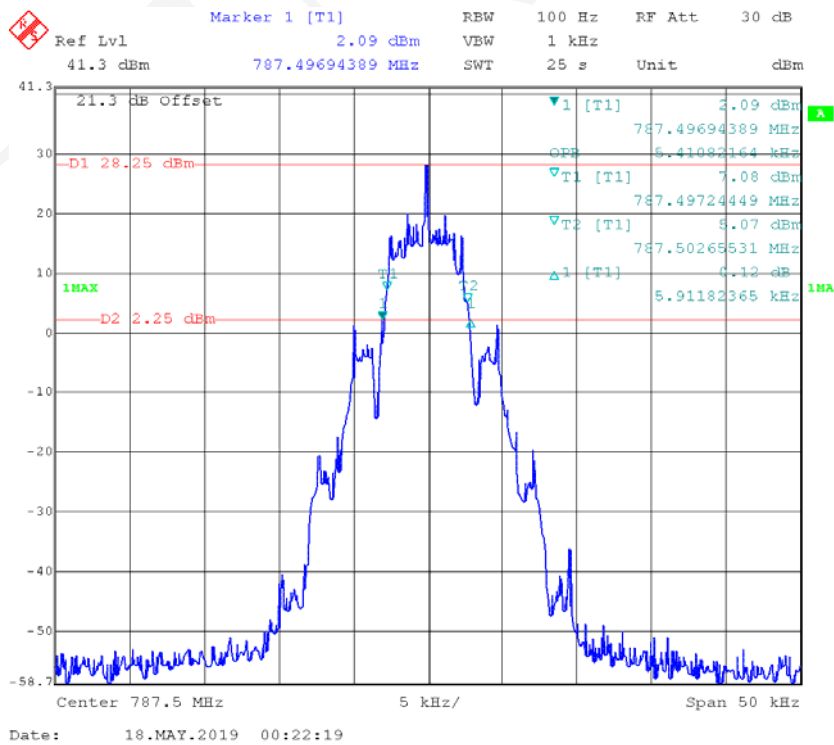

FCC §2.1051, §27.53 - SPURIOUS EMISSIONS AT ANTENNA TERMINALS

Applicable Standard

FCC §2.1051, and §27.53.

The spectrum was to be investigated to the tenth harmonics of the highest fundamental frequency as specified in § 2.1051.

Test Procedure

The RF output of the transceiver was connected to a spectrum analyzer and simulator through appropriate attenuation. Sufficient scans were taken to show any out of band emissions up to 10th harmonic.

Test Equipment List and Details

Manufacturer	Description	Model	Serial Number	Calibration Date	Calibration Due Date
Rohde & Schwarz	Signal Analyzer	FSIQ26	831929/005	2018-08-03	2019-08-03
Unknown	Coaxial Cable	C-SJ00-0010	C0010/02	Each time	N/A
E-Microwave	Blocking Control	EMDCB-00036	0E01201048	Each time	N/A

* **Statement of Traceability:** Bay Area Compliance Laboratories Corp. (Dongguan) attests that all calibrations have been performed, traceable to National Primary Standards and International System of Units (SI).

Test Data

Environmental Conditions

Temperature:	24.2~26.5 °C
Relative Humidity:	52~59%
ATM Pressure:	100.4~ 100.9kPa

* *The testing was performed by Neil Liao & Tyler Pan from 2019-05-16 to 2019-05-23*

Please refer to the following plots.

FM, High power:

Channel Spacing 12.5 kHz, 787.5MHz

Fund.test with Filter

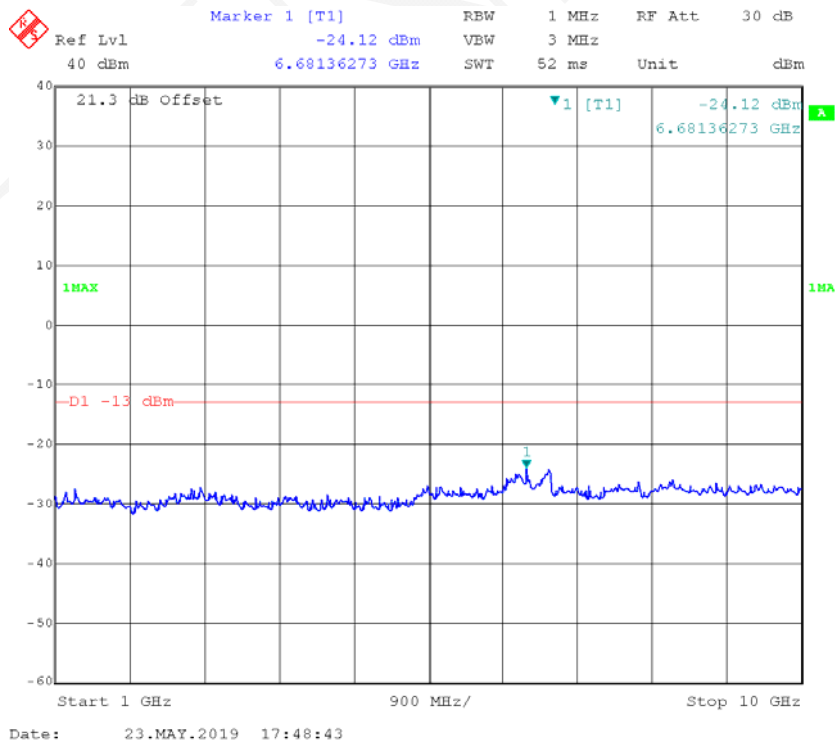
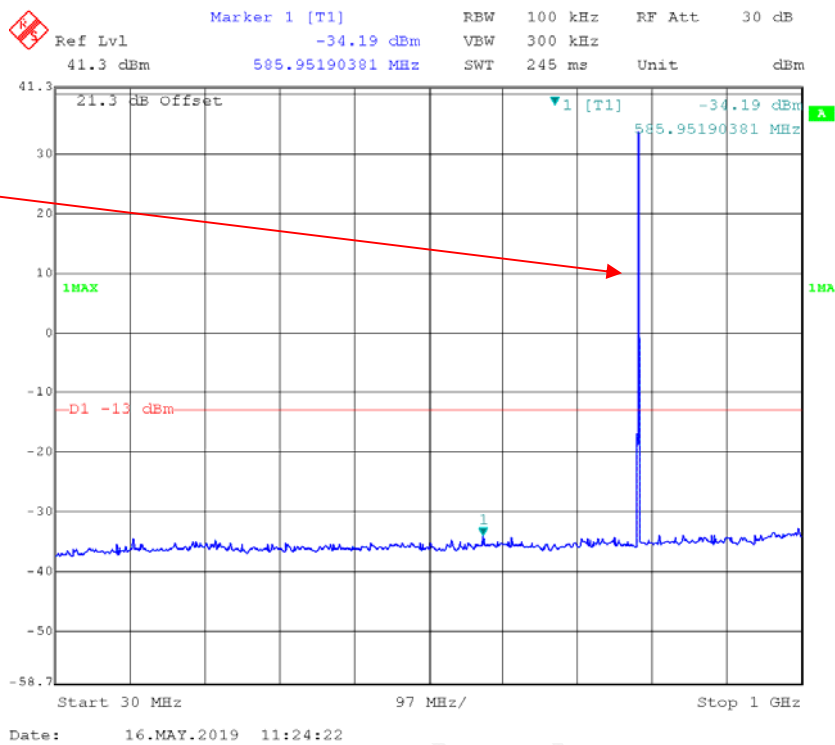

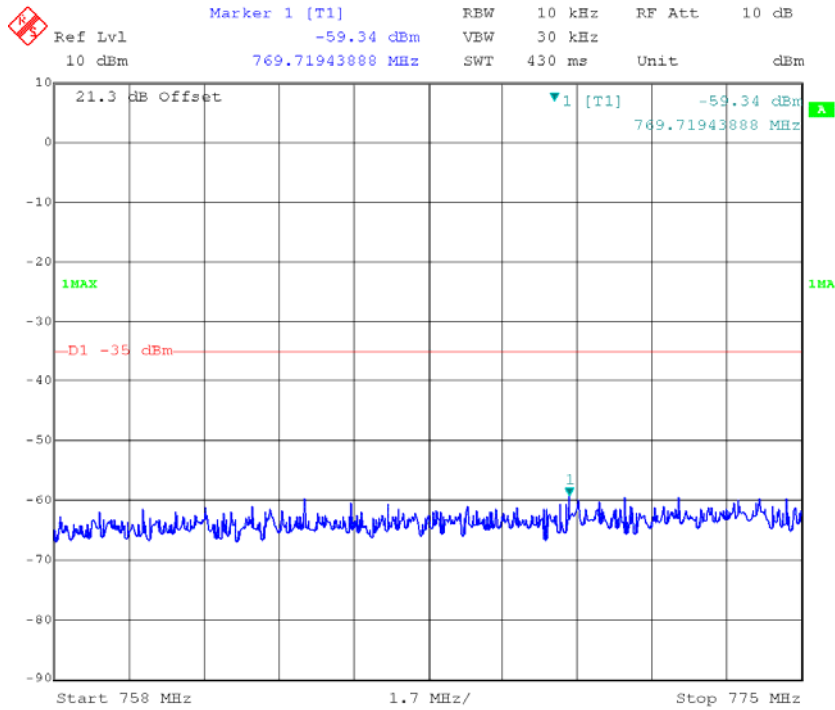

Date: 16.MAY.2019 15:18:15

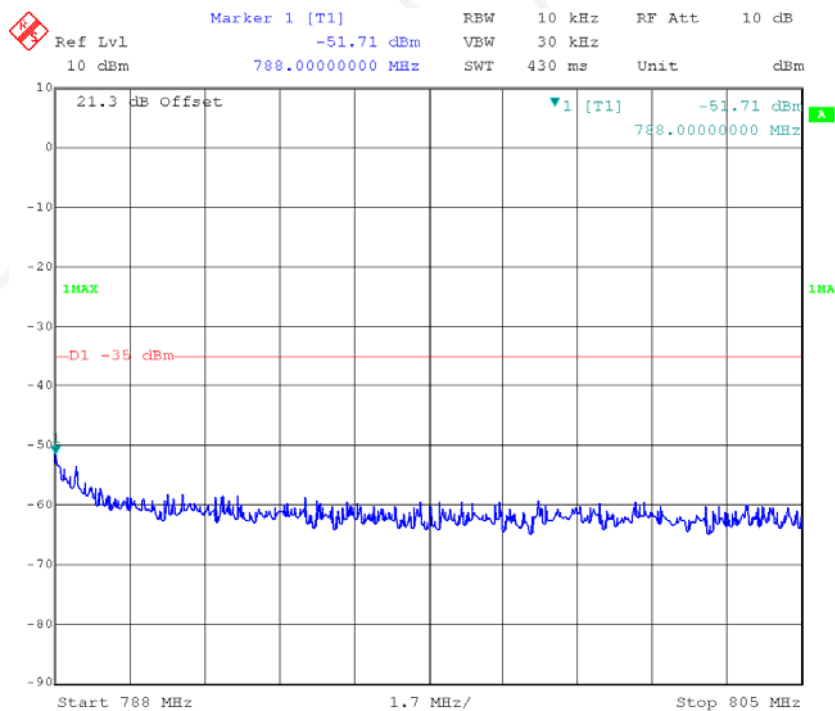

Date: 16.MAY.2019 15:17:25

4FSK, High power:

Channel Spacing 12.5 kHz, 787.5MHz

Fund.test with Filter

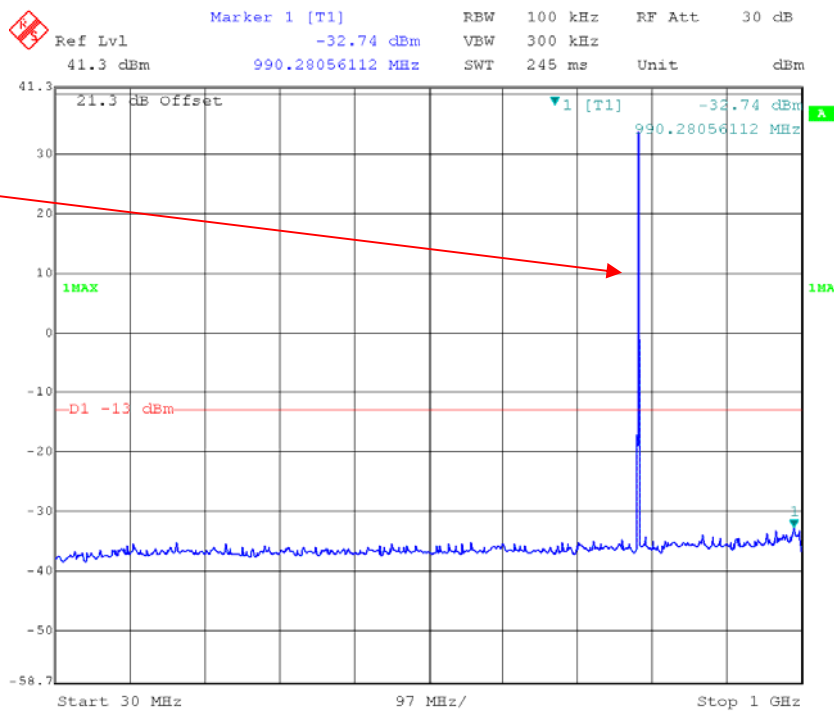

Date: 16.MAY.2019 11:36:28



Date: 23.MAY.2019 17:48:01

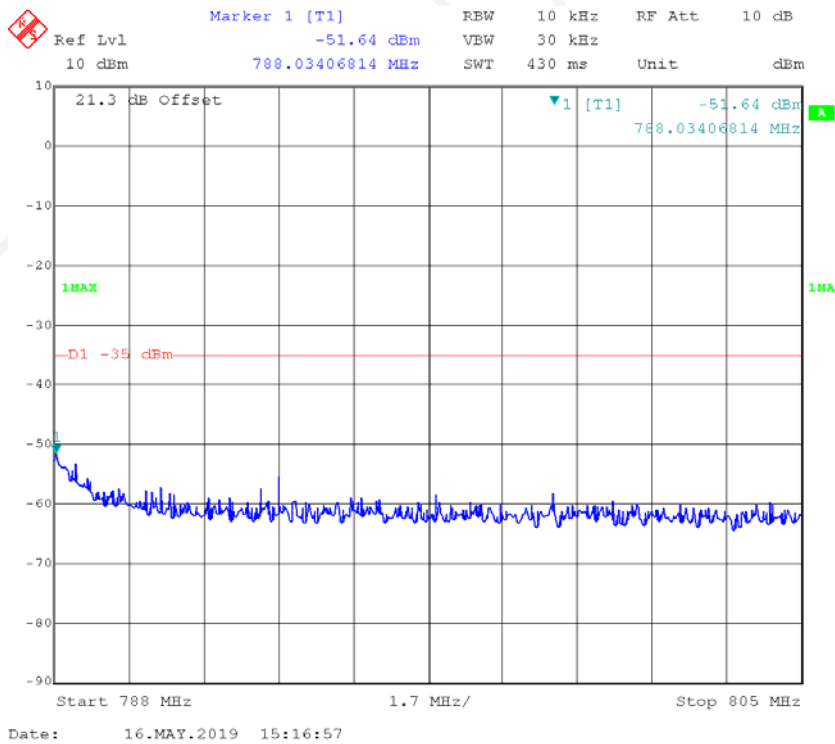
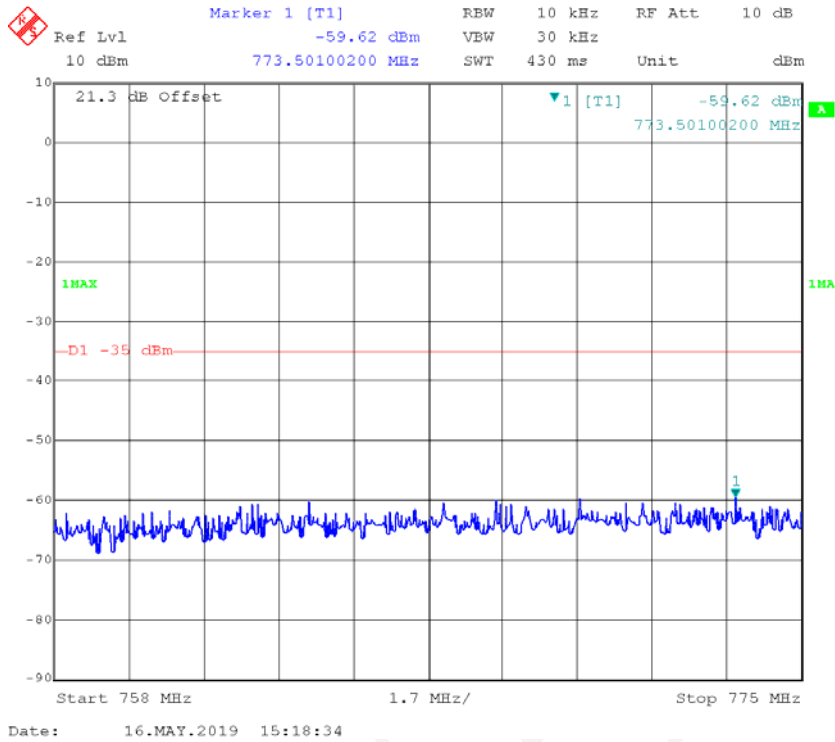

FFSK1200, High power:

Channel Spacing 12.5 kHz, 787.5MHz

Fund.test with Filter

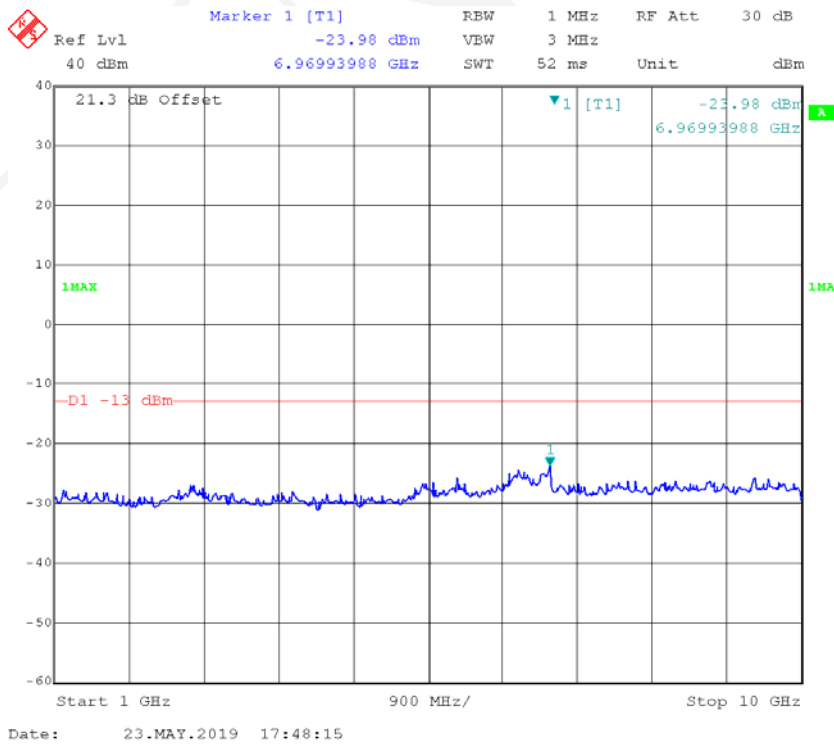
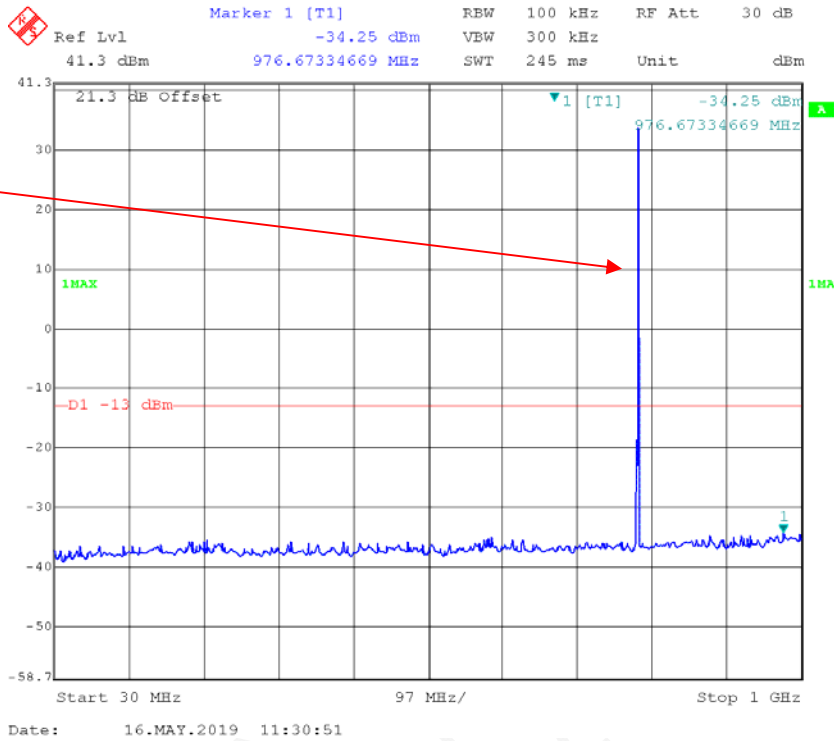

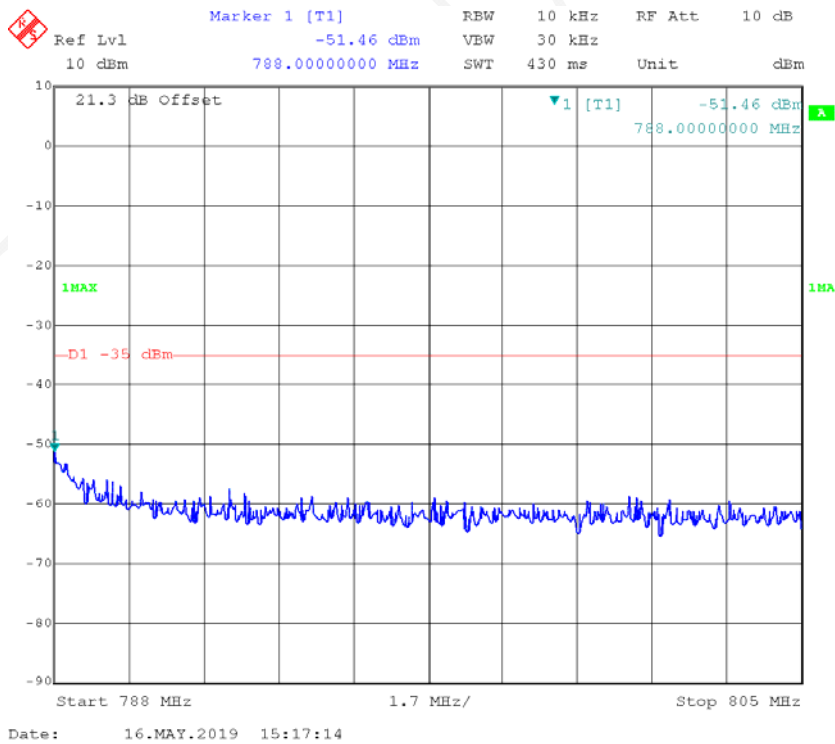
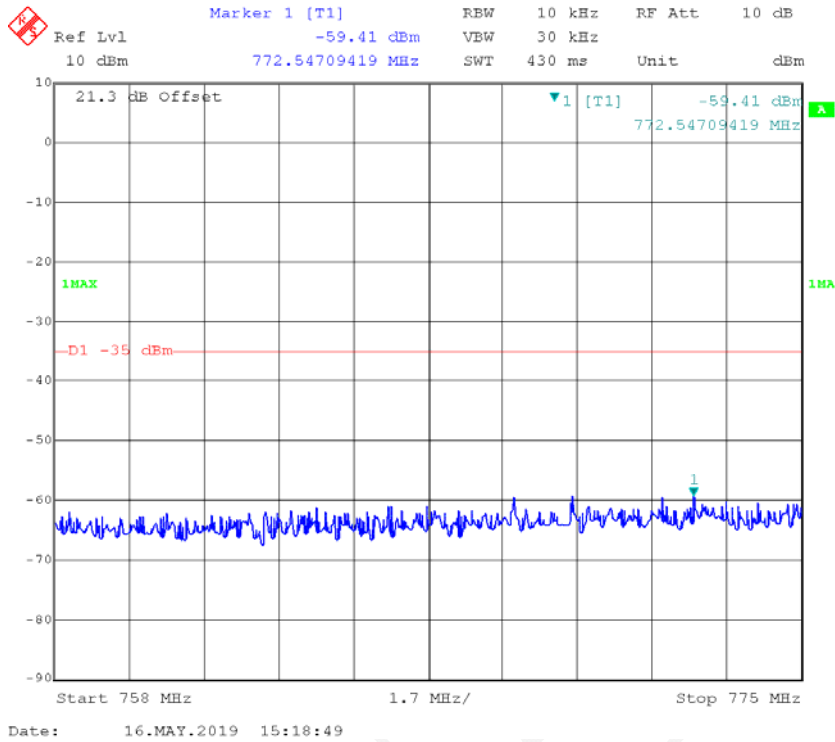

FFSK2400, High power:

Channel Spacing 12.5 kHz, 787.5MHz

Fund.test with Filter

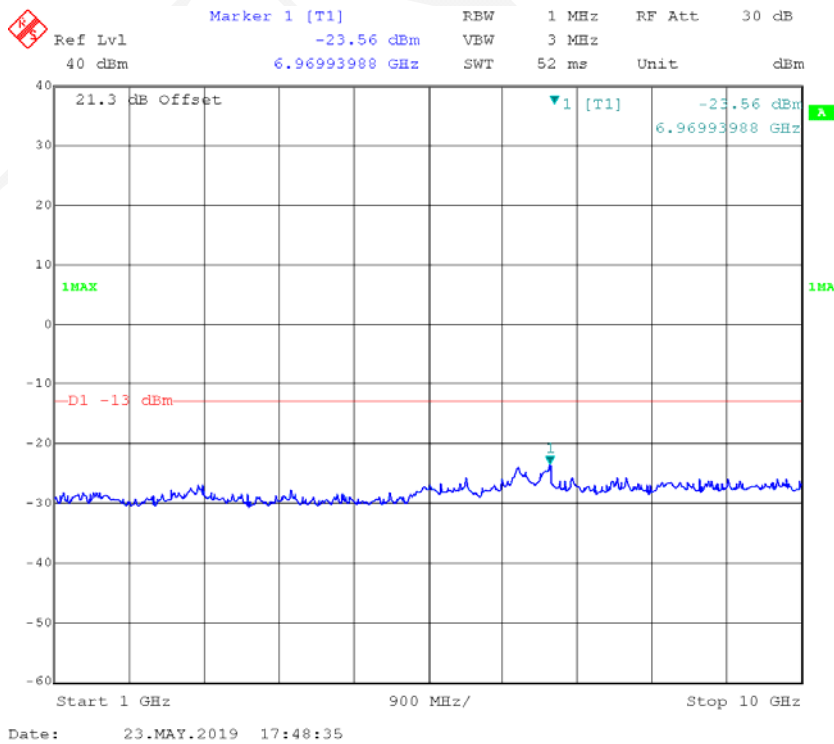
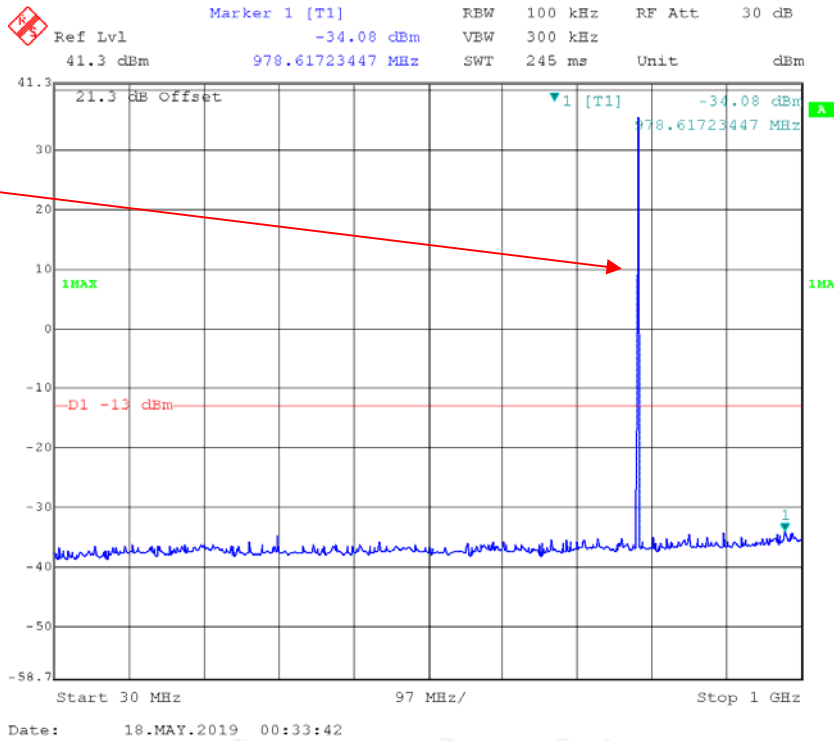

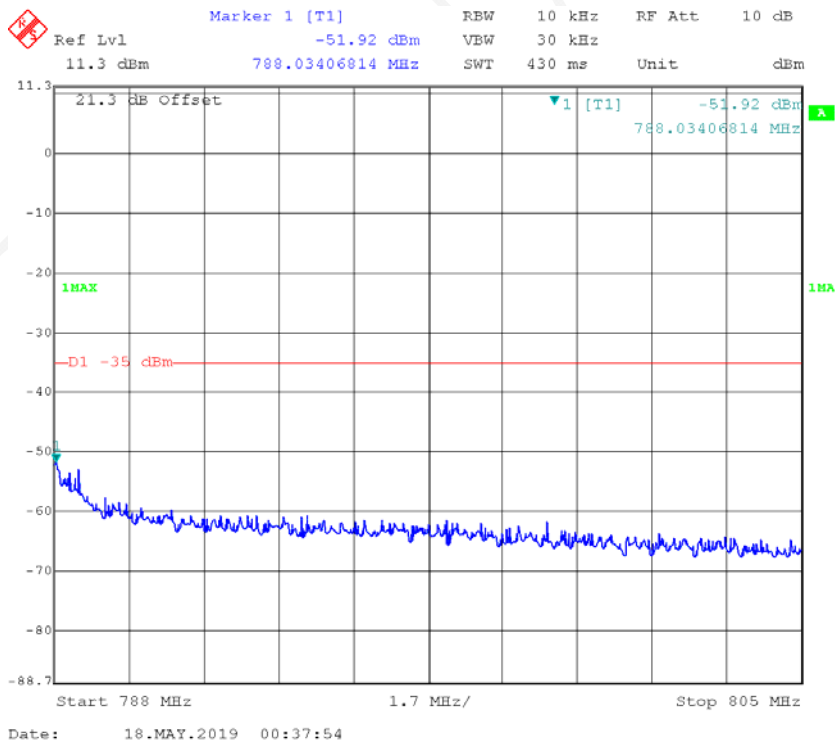
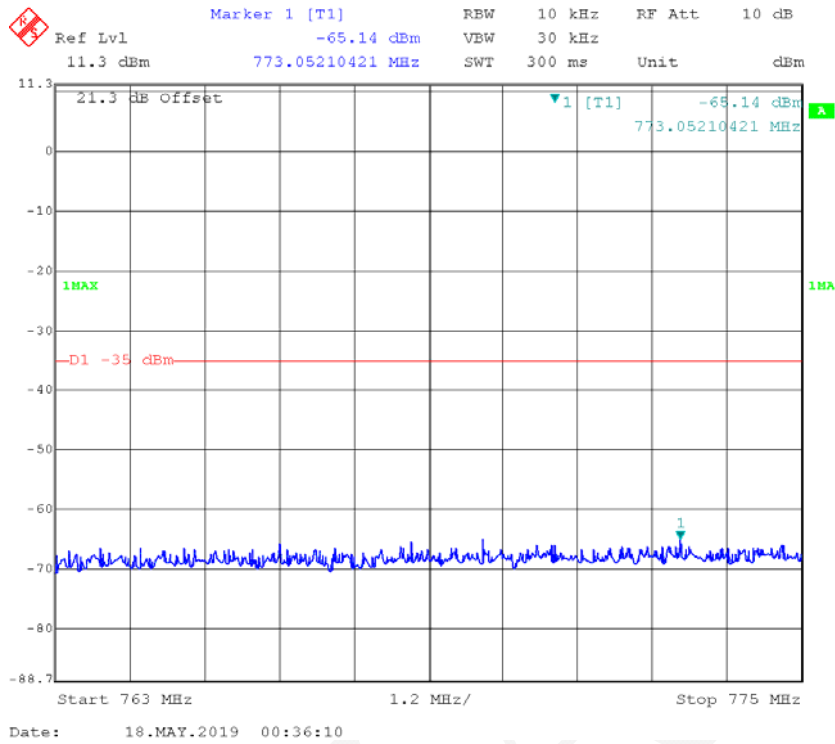

FCC §2.1053 & §27.53 - SPURIOUS RADIATED EMISSIONS

Applicable Standard

FCC § 2.1053 and § 27.53.

Test Procedure

The transmitter was placed on a wooden turntable, and it was transmitting into a non-radiating load which was also placed on the turntable.

The measurement antenna was placed at a distance of 3 meters from the EUT. During the tests, the antenna height and polarization as well as EUT azimuth were varied in order to identify the maximum level of emissions from the EUT. The test was performed by placing the EUT on 3-orthogonal axis.

The frequency range up to tenth harmonic of the fundamental frequency was investigated.

Remove the EUT and replace it with substitution antenna. A signal generator was connected to the substitution antenna by a non-radiating cable. The absolute levels of the spurious emissions were measured by the substitution.

Spurious emissions in dB = $10 \lg(\text{TXpwr in Watts}/0.001)$ – the absolute level

Spurious attenuation limit in dB = $43 + 10 \text{Log}_{10}(\text{power out in Watts})$

Test Equipment List and Details

Manufacturer	Description	Model	Serial Number	Calibration Date	Calibration Due Date
R&S	EMI Test Receiver	ESCI	100035	2018-08-03	2019-08-03
Sunol Sciences	Antenna	JB3	A060611-3	2017-07-21	2019-07-21
EMCO	Adjustable Dipole Antenna	3121C	9109-753	N/A	N/A
Unknown	Coaxial Cable	C-NJNJ-50	C-1000-01	2018-09-05	2019-09-05
Unknown	Coaxial Cable	C-NJNJ-50	C-0400-02	2018-09-05	2019-09-05
Unknown	Coaxial Cable	C-NJNJ-50	C-0530-01	2018-09-24	2019-09-24
Unknown	Coaxial Cable	C-NJNJ-50	C-0200-02	2018-09-05	2019-09-05
Sonoma	Amplifier	310N	185914	2018-10-13	2019-10-13
Agilent	Spectrum Analyzer	E4440A	SG43360054	2019-01-04	2020-01-04
TDK RF	Horn Antenna	HRN-0118	130 084	2017-01-15	2020-01-04
ETS-Lindgren	Horn Antenna	3115	000 527 35	2017-01-15	2020-01-04
Unknown	Coaxial Cable	C-SJSJ-50	C-0800-01	2018-09-05	2019-09-05
MITEQ	Amplifier	AFS42-00101800-25-S-42	2001271	2018-09-05	2019-09-05
Agilent	Signal Generator	E8247C	MY43321350	2018-12-10	2019-12-10
Quinstar	Amplifier	QLW-18405536-JO	15964001001	2018-06-27	2019-06-27

* **Statement of Traceability:** Bay Area Compliance Laboratories Corp. (Dongguan) attests that all calibrations have been performed, traceable to National Primary Standards and International System of Units (SI).

Test Data

Environmental Conditions

Temperature:	24.2~26.5 °C
Relative Humidity:	52~59%
ATM Pressure:	100.4~ 100.9kPa

* The testing was performed by Neil Liao & Tyler Pan from 2019-05-18 to 2019-05-23

Operation Mode: Transmitting

30 MHz-10 GHz(FM mode was the worst):

Frequency (MHz)	Polar (H/V)	Receiver Reading (dB μ V)	Substituted Method			Absolute Level (dBm)	Limit (dBm)	Margin (dB)
			Substituted Level (dBm)	Antenna Gain (dBd/dBi)	Cable Loss (dB)			
Frequency:787.500 MHz								
476.00	H	22.14	-58.85	0.00	0.69	-59.54	-13.00	46.54
536.00	V	21.74	-55.43	0.00	0.73	-56.16	-13.00	43.16
1575.00	H	36.78	-67.70	10.23	1.32	-58.79	-13.00	45.79
1575.00	V	36.80	-67.61	10.23	1.32	-58.70	-13.00	45.70
2362.50	H	37.15	-65.98	12.01	1.21	-55.18	-13.00	42.18
2362.50	V	38.24	-65.91	12.01	1.21	-55.11	-13.00	42.11
3150.00	H	38.16	-63.40	12.34	1.53	-52.59	-13.00	39.59
3150.00	V	37.65	-63.38	12.34	1.53	-52.57	-13.00	39.57
3937.50	H	38.25	-61.49	12.29	1.47	-50.67	-13.00	37.67
3937.50	V	38.33	-61.93	12.29	1.47	-51.11	-13.00	38.11
4725.000	H	38.41	-58.92	13.22	1.50	-47.20	-13.00	34.20
4725.000	V	37.46	-59.92	13.22	1.50	-48.20	-13.00	35.20
5512.500	H	38.21	-57.32	12.82	1.24	-45.74	-13.00	32.74
5512.500	V	38.06	-57.90	12.82	1.24	-46.32	-13.00	33.32

Note:

- 1) The unit of Antenna Gain is dBd for frequency below 1GHz, and the unit of Antenna Gain is dBi for frequency above 1GHz.
- 2) Absolute Level = Substituted Level - Cable loss + Antenna Gain
- 3) Margin = Limit-Absolute Level

FCC §2.1055& §27.54 - FREQUENCY STABILITY

Applicable Standard

FCC § 2.1055 (a)& §27.54

Test Procedure

Frequency Stability vs. Temperature: The equipment under test was connected to an external power supply and the RF output was connected to communication test set via feed-through attenuators. The EUT was placed inside the temperature chamber. The power leads and RF output cable exited the chamber through an opening made for the purpose.

After the temperature stabilized for approximately 20 minutes, the frequency output was recorded from the communication test set.

Frequency Stability vs. Voltage: An external variable power supply was connected to the battery terminals of the equipment under test. The voltage was set from 85% to 115% of the nominal value and was then decreased until the transmitter light no longer illuminated; i.e., the battery end point. The output frequency was recorded for each battery voltage.

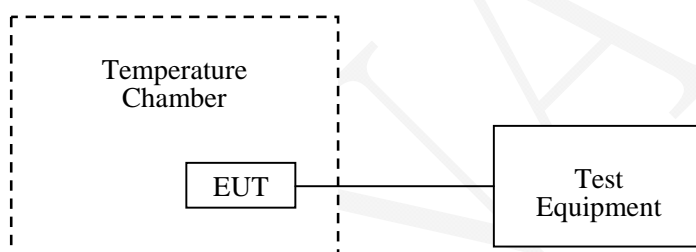

Test Equipment List and Details

Manufacturer	Description	Model	Serial Number	Calibration Date	Calibration Due Date
Rohde & Schwarz	Signal Analyzer	FSIQ26	831929/005	2018-08-03	2019-08-03
Unknown	Coaxial Cable	C-SJ00-0010	C0010/02	Each time	N/A
E-Microwave	Blocking Control	EMDCB-00036	0E01201048	Each time	N/A
ESPEC	Constant temperature and humidity Tester	ESX-4CA	018 463	2019-03-26	2020-03-26
UNI-T	Multimeter	UT39A	M130199938	2018-07-24	2019-07-24
Pro instrument	DC Power Supply	pps3300	3300012	N/A	N/A

* **Statement of Traceability:** Bay Area Compliance Laboratories Corp. (Dongguan) attests that all calibrations have been performed, traceable to National Primary Standards and International System of Units (SI).

Test Data

Environmental Conditions

Temperature:	25.8 °C
Relative Humidity:	46%
ATM Pressure:	100.2 kPa

The testing was performed by Andy Huang on 2019-05-24

FM, 12.5kHz, Reference Frequency: 787.5 MHz					
Temperature (°C)	Voltage Supplied (Vdc)	Measured Frequency (MHz)	Frequency Error (ppm)	Limit (ppm)	
-30	7.5	787.500090	0.11	2.5	
-20		787.499980	-0.03		
-10		787.499870	-0.17		
0		787.500120	0.15		
10		787.500010	0.01		
20		787.500030	0.04		
30		787.499990	-0.01		
40		787.499860	-0.18		
50		787.500290	0.37		
20		6.4	787.500230		0.29
20		9.0	787.500050		0.06

4FSK, 12.5kHz, Reference Frequency: 787.5 MHz					
Temperature (°C)	Voltage Supplied (Vdc)	Measured Frequency (MHz)	Frequency Error (ppm)	Limit (ppm)	
-30	7.5	787.499940	-0.08	2.5	
-20		787.499940	-0.08		
-10		787.499930	-0.09		
0		787.499850	-0.19		
10		787.500330	0.42		
20		787.500310	0.39		
30		787.499930	-0.09		
40		787.500190	0.24		
50		787.500290	0.37		
20		6.4	787.500240		0.30
20		9.0	787.499840		-0.20

FFSK(1200 bps), 12.5kHz, Reference Frequency: 787.5 MHz				
Temperature (°C)	Voltage Supplied (Vdc)	Measured Frequency (MHz)	Frequency Error (ppm)	Limit (ppm)
-30	7.5	787.500170	0.22	2.5
-20		787.499960	-0.05	
-10		787.500150	0.19	
0		787.500120	0.15	
10		787.500250	0.32	
20		787.500100	0.13	
30		787.499880	-0.15	
40		787.499870	-0.17	
50		787.499940	-0.08	
20		6.4	787.500100	
20	9.0	787.500080	0.10	

FFSK(2400 bps), 12.5kHz, Reference Frequency: 787.5 MHz				
Temperature (°C)	Voltage Supplied (Vdc)	Measured Frequency (MHz)	Frequency Error (ppm)	Limit (ppm)
-30	7.5	787.499990	-0.01	2.5
-20		787.500140	0.18	
-10		787.499840	-0.20	
0		787.499940	-0.08	
10		787.500070	0.09	
20		787.500070	0.09	
30		787.499980	-0.03	
40		787.499900	-0.13	
50		787.500320	0.41	
20		6.4	787.499990	
20	9.0	787.500240	0.30	

Note: The fundamental emissions stay within the authorized bands of operation based on the frequency deviation measured is small, the extreme voltage was declared by applicant.

******* END OF REPORT *******