

LABORATORY TEST REPORT

RADIO PERFORMANCE MEASUREMENTS

for the

TPDH7A Handportable Transceiver

Tested in accordance with:

FCC 47 CFR Parts 22, 74 and 90

RSS-119 Issue 11
RSS-Gen Issue 3

Report Revision:

1

Issue Date:

12-03-2014

PREPARED BY:

Robin Kidson

Test Technician

CHECKED & APPROVED BY:

M.C. James

Laboratory Technical Manager



OATS FCC LISTING REGISTRATION: 837095
OATS IC LISTING REGISTRATION: SITE# 737A-1

All tests reported herein have been performed in accordance with the laboratory's scope of accreditation.

This document must not be reproduced except in full, without the written permission of the Compliance Laboratory Manager

TELTEST Laboratories (A Division of Tait Communications)
PO Box 1645, 558 Wairakei Road, Christchurch, New Zealand.

Telephone: 64 3 358 3399
FAX: 64 3 359 4632

TABLE OF CONTENTS

REVISION	3
INTRODUCTION	4
Statement of Compliance	6
MODULATION TYPES, NECESSARY BANDWIDTH & EMISSION DESIGNATORS	7
TEST RESULTS	9
TRANSMITTER OUTPUT POWER (CONDUCTED)	9
TRANSMITTER AUDIO FREQUENCY RESPONSE - PRE-EMPHASIS	10
TRANSMITTER MODULATION LIMITING	15
TRANSMITTER OCCUPIED BANDWIDTH AND SPECTRUM MASKS	23
TRANSMITTER SPURIOUS EMISSIONS (CONDUCTED)	60
TRANSMITTER SPURIOUS EMISSIONS (RADIATED)	66
TRANSIENT FREQUENCY BEHAVIOR	70
TRANSMITTER FREQUENCY STABILITY - TEMPERATURE	87
TRANSMITTER FREQUENCY STABILITY - VOLTAGE	91
RECEIVER SPURIOUS EMISSIONS (CONDUCTED)	92
TEST EQUIPMENT LIST	93
ANNEX A – TEST SETUP DETAILS	94

REVISION

Date	Revision	Comments
12-03-14	1	Initial test report

INTRODUCTION

This report covers the requirements of FCC 47 Parts 22, 74 & 90, and RSS-119 Issue 11 & RSS-Gen Issue 3.

REASON FOR REPORT					
Type approval testing of the TPDH7A, 4 Watt, handportable transceiver in order to demonstrate compliance with FCC 47 Parts 22, 74 & 90, and RSS-119 Issue 11 & RSS-Gen Issue 3. This radio supports analogue, digital FFSK, P25 phase-1, P25 phase-2, and Digital Mobile Radio modulations.					
Modulation		Channel Spacing	Speech Channels	Symbol Rate (symbols/sec)	Data Rate (bps)
Analogue FM		12.5 kHz 25.0 kHz	1	-	-
FFSK	Fast Frequency Shift Keying	12.5 kHz 25.0 kHz	-	1200	1200
		12.5 kHz 25.0 kHz	-	2400	2400
Digital Mobile Radio (DMR)	4 Level FSK (2 slot TDMA) (ETSI TS102 361-1)	12.5 kHz	2	4800	9600
APCO P25 Phase 1	C4FM (TIA 102)	12.5 kHz	1	4800	9600
APCO P25 Phase 2	H-CPM (2 slot TDMA) (TIA 102)	12.5 kHz	2	6000	12000

Type Approval Testing of the T03-00035-HCDG
Serial number 25523091
Frequency range 450 → 520 MHz

in accordance with:

FCC 47 CFR Parts 22, 74 and 90
RSS-119 Issue 11 & RSS-Gen Issue 3

REPORT PREPARED FOR

Tait Communications
PO Box 1645
558 Wairakei Road
Christchurch
New Zealand

DESCRIPTION OF SAMPLE

Manufacturer Tait Limited
Equipment: Handportable Transceiver
Type: TPDH7A
Product Code: T03-00035-HCDG
Serial Number(s): 25523091
Quantity: 1

HARDWARE & SOFTWARE

DMR / Analogue

Hardware ID	TPDB1X-H700_0006
Boot Code	QPD1B_S00_3.00.03.0001
DSP	QPD1A_E00_1.02.00.0021
Radio Application	QPD1F_E00_1.02.00.0021
FPGA Image	QPD1G_S00_1.02.00.0010

P25 Phase - 1

Type	Code and Version
Hardware ID	TPDB1X-H700_0006
Boot Code	QPD1B_S00_3.00.03.0001
DSP	QPD1A_A00_1.06.02.0044
Radio Application	QPD1F_A00_1.06.02.0044
FPGA Image	QPD1G_S00_1.02.00.0010

P25 Phase – 2

Type	Code and Version
Hardware ID	TPDB1X-H700_0006
Boot Code	QPD1B_S00_3.00.03.0001
DSP	QPD1A_A00_1.06.02.0044
Radio Application	QPD1F_A00_1.06.02.0044
FPGA Image	QPD1G_S00_1.00.02.0001_P2.a

TEST CONDITIONS

All testing was performed between 14 → 24 February 2014, 28 February → 3 March 2014, and on 6 March 2014, under the following conditions:

Ambient temperature: 15°C → 30°C

Relative Humidity: 20% → 75%

Standard Test Voltage 7.5 V_{DC}

STATEMENT OF COMPLIANCE

We, TELTEST LABORATORIES of 558 Wairakei Road, Christchurch, New Zealand, declare under our sole responsibility that the product:

Equipment: Handportable Transceiver
Type: TPDH7A
Product Code: T03-00035-HCDG
Serial Number(s): 25523091
Quantity: 1

to which this declaration relates, is in conformity with the following standards:

FCC 47 CFR Parts 22, 74 and 90

RSS-119 Issue 11 & RSS-Gen Issue 3

Signature: _____

M.C. James
Laboratory Technical Manager

Date: _____

MODULATION TYPES, NECESSARY BANDWIDTH & EMISSION DESIGNATORS

MODULATION TYPES:

F3E	Analogue Frequency Modulation (FM)	
F2D	FFSK	1200 bps and 2400 bps
FXW	DMR Digital Voice	9600 bps
FXD	DMR Digital Data	9600 bps
F1E, F7E	P25 phase 1 Digital Voice	9600 bps
F1D, F7D	P25 phase 1 Digital Data	9600 bps
F1W	P25 phase 2 Digital Voice / Data	12000 bps

CHANNEL SPACINGS: 12.5 kHz 25.0 kHz

EMISSION DESIGNATORS:

	12.5 kHz	25.0 kHz
Analog FM	11K0F3E	16K0F3E
FFSK Data 1200 bps	6K60F2D	9K60F2D
FFSK Data 2400 bps	7K80F2D	10K8F2D
Digital Voice DMR	7K60FXW	
Digital Data DMR	7K60FXD	
Digital Voice P25 phase 1	8K10F1E	
	8K10F7E	
Digital Data P25 phase 1	8K10F1D	
	8K10F7D	
Digital Voice P25 phase 2	8K10F1W	
Digital Data P25 phase 2	8K10F1W	

CALCULATIONS

Equation: $B_n = 2M + 2Dk$

(M is highest modulating frequency; D is peak allowable deviation; k is a constant of 1 for FM)

Analog Voice 12.5 kHz Bandwidth

Necessary bandwidth

M = 3.0 kHz

D = 2.5 kHz

$$B_n = (2 \times 3.0) + (2 \times 2.5) \times 1$$

$$= 11.0 \text{ kHz}$$

Emission Designator

11K0F3E

F3E represents an FM voice transmission

Analog Voice 25.0 kHz Bandwidth

Necessary bandwidth

M = 3.0 kHz

D = 5.0 kHz

$$B_n = (2 \times 3.0) + (2 \times 5.0) \times 1$$

$$= 16.0 \text{ kHz}$$

Emission Designator

16K0F3E

F3E represents an FM voice transmission

Fast Frequency Shift Keying (FFSK – 1200 bps) 12.5 kHz Bandwidth

Necessary bandwidth

M = 1.8 kHz

D = 1.5 kHz (60% of peak deviation)

$$B_n = (2 \times 1.8) + (2 \times 1.5) \times 1$$

$$= 6.6 \text{ kHz}$$

Emission Designator

6K60F2D

F2D represents a FM data transmission with the use of a modulating sub carrier

Fast Frequency Shift Keying (FFSK – 1200 bps) 25.0 kHz Bandwidth

Necessary bandwidth

M = 1.8 kHz

D = 3.0 kHz (60% of peak deviation)

$$B_n = (2 \times 1.8) + (2 \times 3.0) \times 1$$

Emission Designator

9K60F2D

F2D represents a FM data transmission with the use of a modulating sub carrier

= 9.6 kHz

Emission Designators – Continued

Fast Frequency Shift Keying (FFSK – 2400 bps) 12.5 kHz Bandwidth

Necessary bandwidth

M = 2.4 kHz

D = 1.5 kHz (60% of peak deviation)

$$B_n = (2 \times 2.4) + (2 \times 1.5) \times 1 \\ = 7.8 \text{ kHz}$$

Emission Designator

7K80F2D

F2D represents a FM data transmission with the use of a modulating sub carrier

Fast Frequency Shift Keying (FFSK – 2400 bps) 25.0 kHz Bandwidth

Necessary bandwidth

M = 2.4 kHz

D = 3.0 kHz (60% of peak deviation)

$$B_n = (2 \times 2.4) + (2 \times 3.0) \times 1 \\ = 10.8 \text{ kHz}$$

Emission Designator

10K80F2D

F2D represents a FM data transmission with the use of a modulating sub carrier

Digital Voice 12.5 kHz Bandwidth P25 phase 1

99% bandwidth

= 8.1 kHz

Emission Designator

8K10F1E

F1E represents a digital FM voice transmission

8K10F7E

F7E represents two or more channels containing quantized or digital voice information

Digital Voice 12.5 kHz Bandwidth P25 phase 2

99% bandwidth

= 8.1 kHz

Emission Designator

8K10F1W

F1W represents a single FM telephony channel

Digital Voice 12.5 kHz Bandwidth DMR

99% bandwidth

= 7.6 kHz

Emission Designator

7K60FXW

FXW represents a FM Time Division Multiple Access (TDMA) combination of data and telephony

Digital Data 12.5 kHz Bandwidth P25 phase 1

99% bandwidth

= 8.1 kHz

Emission Designator

8K10F1D

F1D represents an digital FM data transmission

8K10F7D

F7D represents two or more channels containing quantized or digital information

Digital Data 12.5 kHz Bandwidth P25 phase 2

99% bandwidth

= 8.1 kHz

Emission Designator

8K10F1W

F1W represents digital FM data transmission

Digital Data 12.5 kHz Bandwidth DMR

99% bandwidth

= 7.6 kHz

Emission Designator

7K60FXD

FXD represents FM Time Division Multiple Access (TDMA) data only

TEST RESULTS

TRANSMITTER OUTPUT POWER (CONDUCTED)

SPECIFICATION: FCC 47 CFR 2.1046
RSS-119 5.4

GUIDE: TIA/EIA-603D 2.2.1

MEASUREMENT PROCEDURE:

1. Refer Annex A for Equipment set up.
2. The coaxial attenuator has an impedance of 50 Ohms.
3. The unmodulated output power was measured with an RF Power meter.

MEASUREMENT RESULTS:

Manufacturer's Rated Output Power:

Switchable: 4 W and 1 W

Nominal 4 W	450.1 MHz	459.9 MHz	469.9 MHz	511.9 MHz
Measured	4.1	4.1	4.0	4.0
Variation (%)	1.7	2.5	-0.2	-0.4
Variation (dB)	0.1	0.1	0.0	0.0
Nominal 1 W	450.1 MHz	459.9 MHz	469.9 MHz	511.9 MHz
Measured	0.99	1.02	0.96	0.98
Variation (%)	-0.7	2.3	-3.6	-1.9
Variation (dB)	0.0	0.1	-0.2	-0.1
Measurement Uncertainty	± 0.6 dB			

LIMIT CLAUSES:

FCC 47 CFR 90.205 (s)

The output power shall not exceed by more than 20%... the manufacturer's rated output power for the particular transmitter specifically listed on the authorization.

RSS-119 5.4

The output power shall be within ±1.0 dB of the manufacturer's rated power.

TRANSMITTER AUDIO FREQUENCY RESPONSE - PRE-EMPHASIS

SPECIFICATION: FCC 47 CFR 2.1047 (a)

GUIDE: TIA/EIA-603D 2.2.6

MEASUREMENT PROCEDURE:

1. Refer Annex A for Equipment set up.
2. An audio input tone of 1000 Hz was applied with the level set to obtain 20% of maximum deviation. This was used as the 0 dB reference point.
3. The AF was varied while the audio level was held constant.
4. The response in dB relative to 1000 Hz was measured.

MEASUREMENT RESULTS:

See the plots on the following pages for 12.5 kHz & 25.0 kHz channel spacings tested at 4 W transmit power.

LIMIT CLAUSE: TIA/EIA-603D 3.2.6

Transmitter Audio Frequency Response – Pre-emphasis

SPECIFICATION: FCC 47 CFR 2.1047 (a)

Tx FREQUENCY: 450.1 MHz 12.5 kHz Channel Spacing

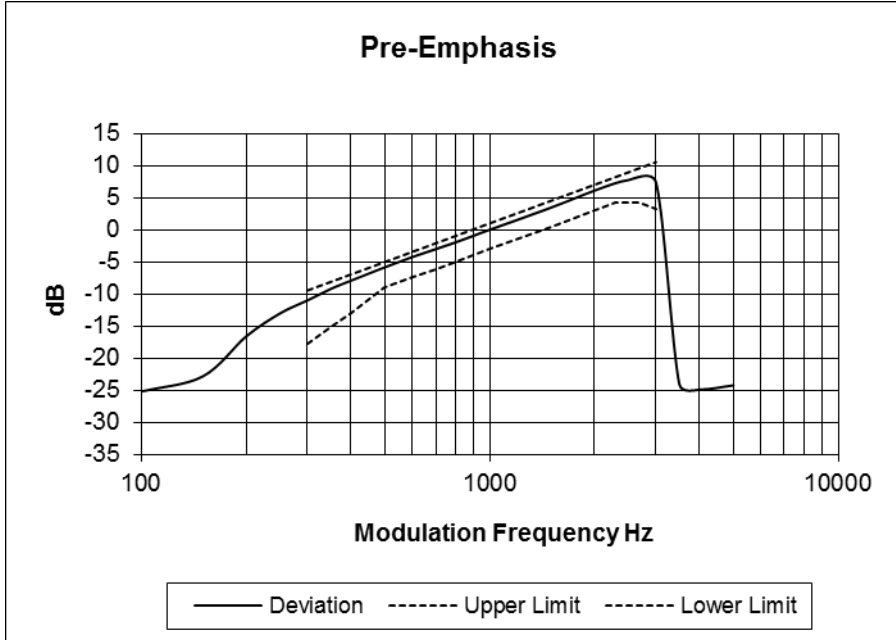

Tx FREQUENCY: 459.9 MHz 12.5 kHz Channel Spacing

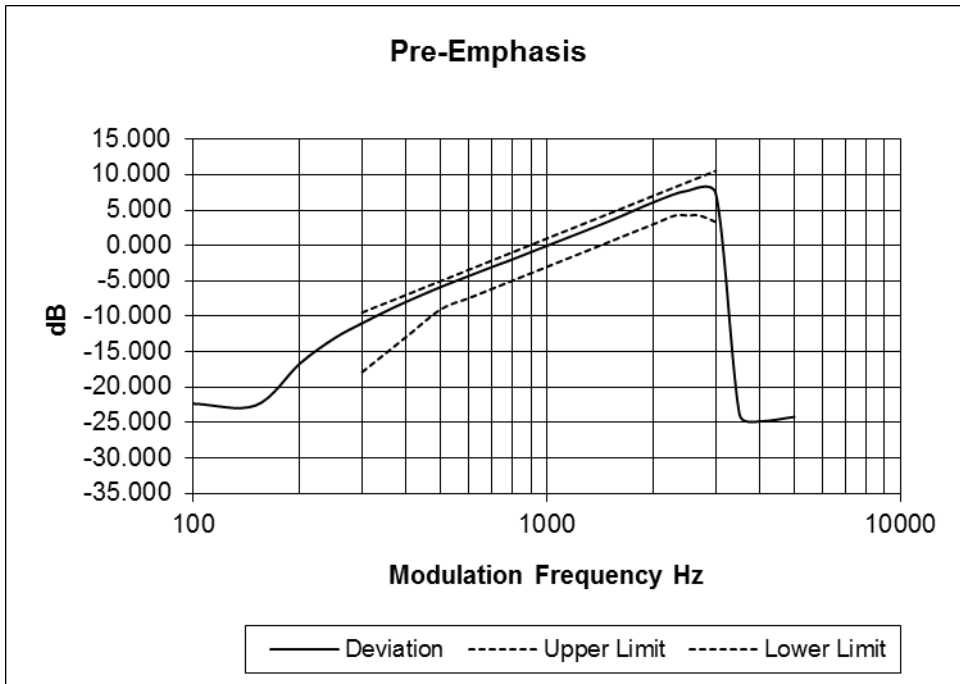

Transmitter Audio Frequency Response – Pre-emphasis

SPECIFICATION: FCC 47 CFR 2.1047 (a)

Tx FREQUENCY: 469.9 MHz

12.5 kHz Channel Spacing

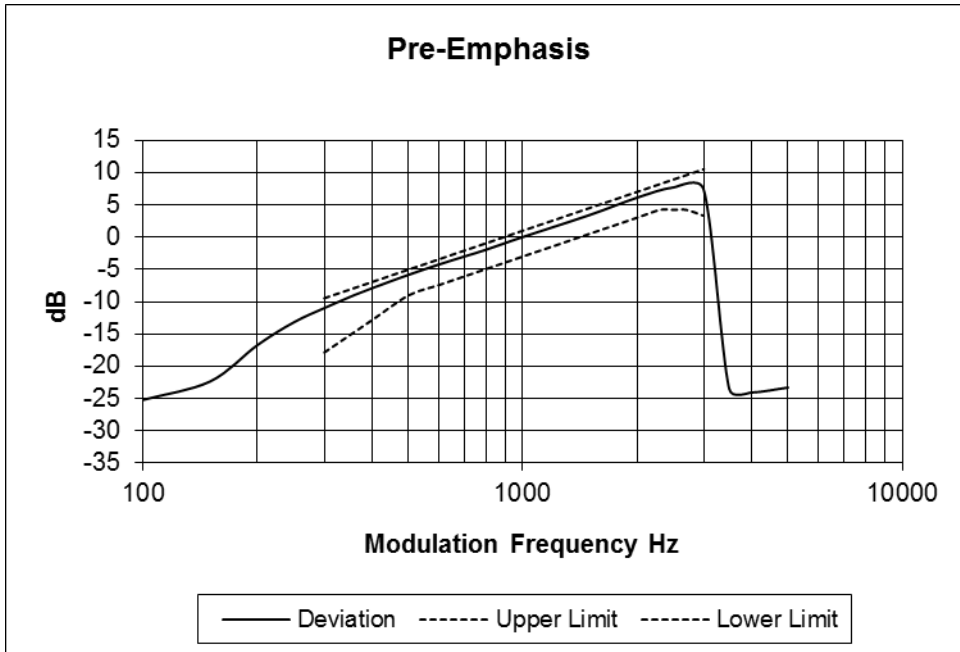

Tx FREQUENCY: 511.9 MHz

12.5 kHz Channel Spacing

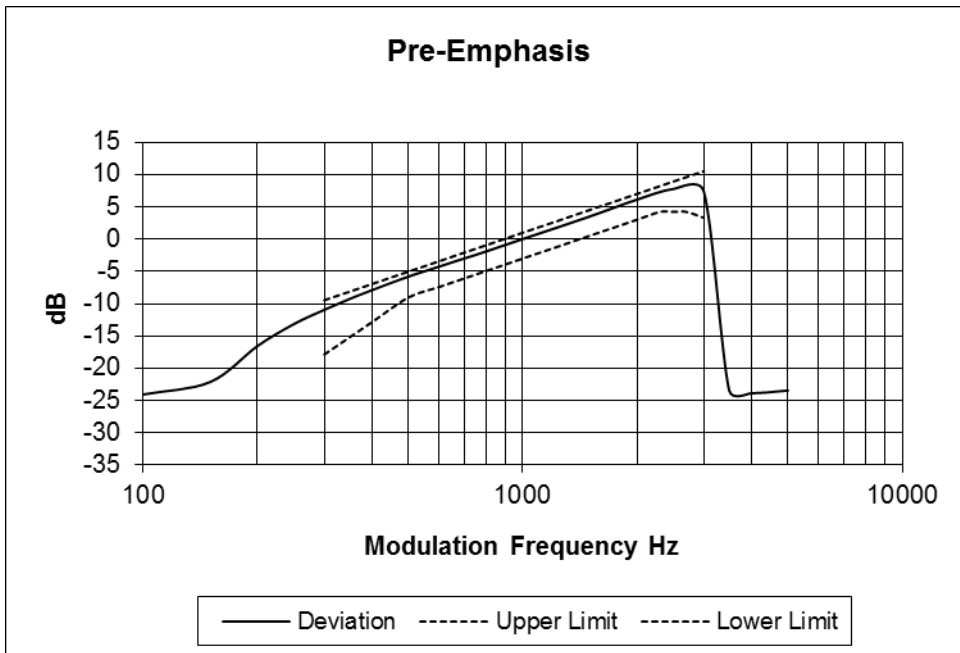

Transmitter Audio Frequency Response – Pre-emphasis

SPECIFICATION: FCC 47 CFR 2.1047 (a)

Tx FREQUENCY: 450.1 MHz 25.0 kHz Channel Spacing

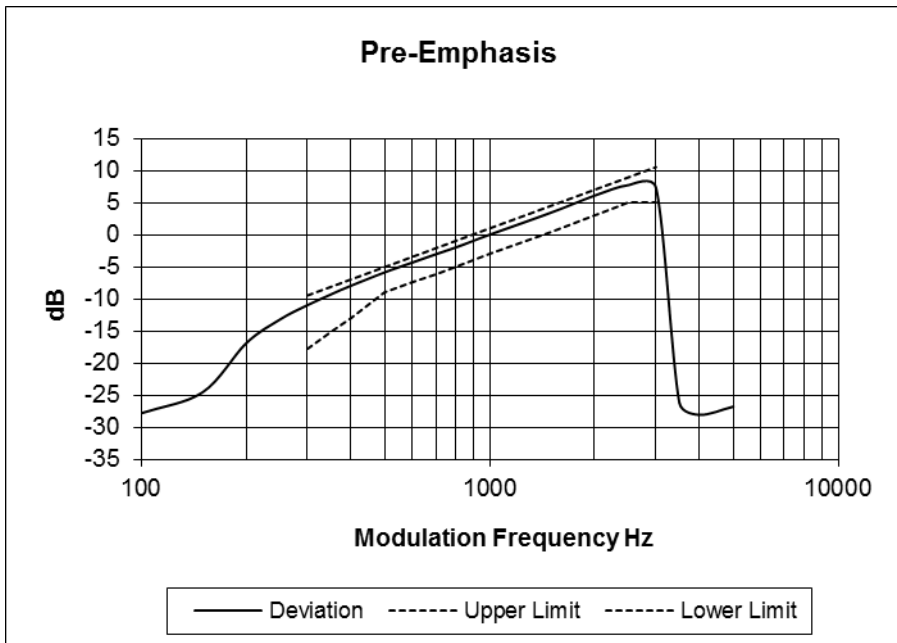

Tx FREQUENCY: 459.9 MHz 25.0 kHz Channel Spacing

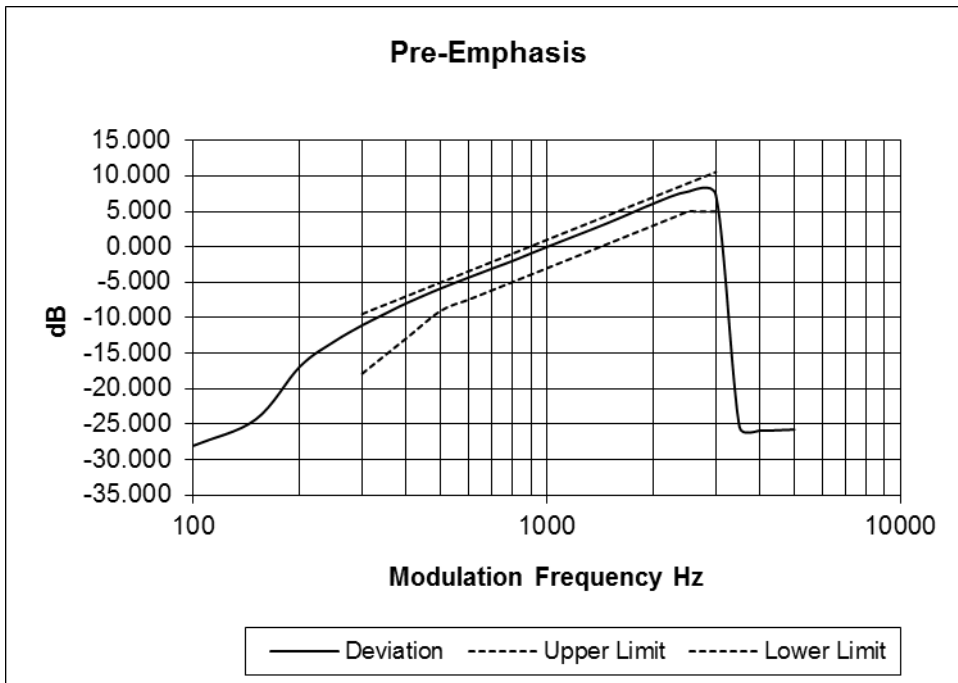

Transmitter Audio Frequency Response – Pre-emphasis

SPECIFICATION: FCC 47 CFR 2.1047 (a)

Tx FREQUENCY: 469.9 MHz 25.0 kHz Channel Spacing

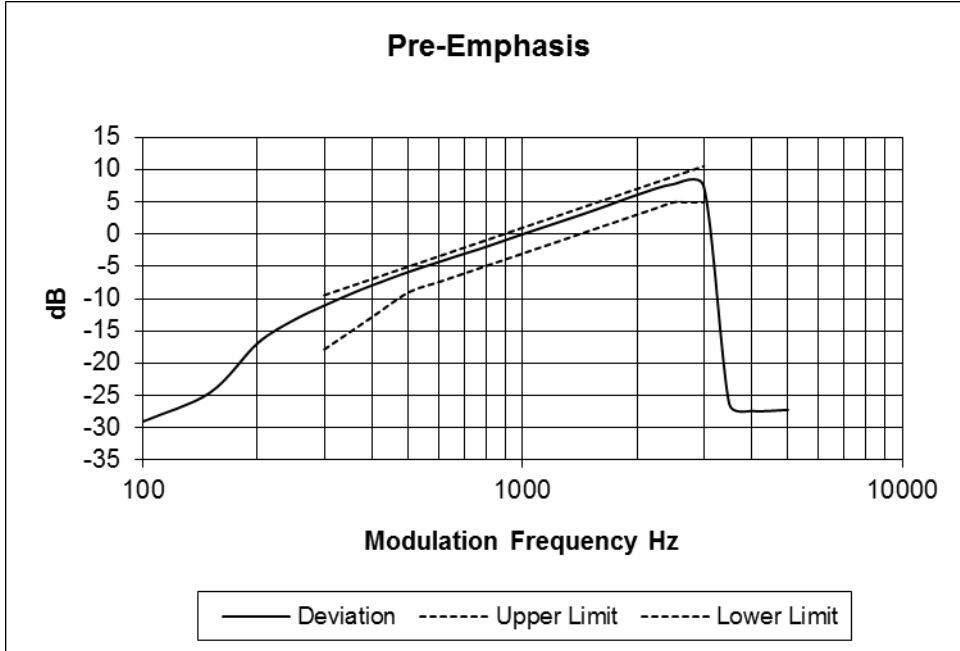

Tx FREQUENCY: 511.9 MHz 25.0 kHz Channel Spacing

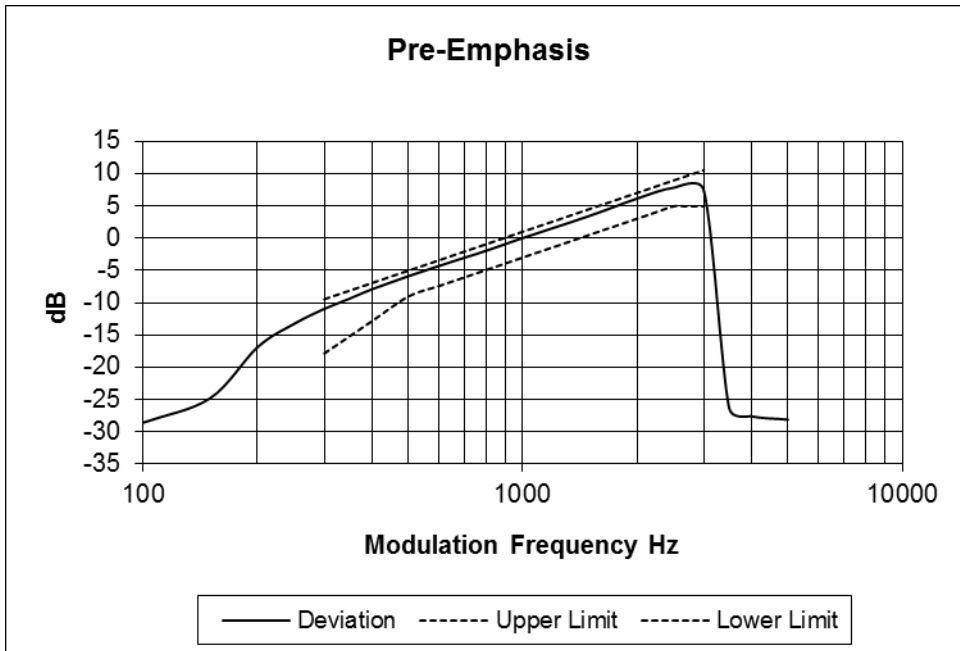

TRANSMITTER MODULATION LIMITING

SPECIFICATION: FCC 47 CFR 2.1047 (b)

GUIDE: TIA/EIA-603D 2.2.3

MEASUREMENT PROCEDURE:

1. Refer Annex A for Equipment set up.
2. The modulation response was measured at three audio frequencies while varying the input level.
3. Measurements were made for both Positive and Negative Deviation.

MEASUREMENT RESULTS:

See the plots on the following pages for 12.5 kHz & 25.0 kHz channel spacings.

LIMIT CLAUSE: TIA/EIA-603D 1.3.4.4

Tx FREQUENCY: 450.1 MHz 12.5 kHz Channel Spacing

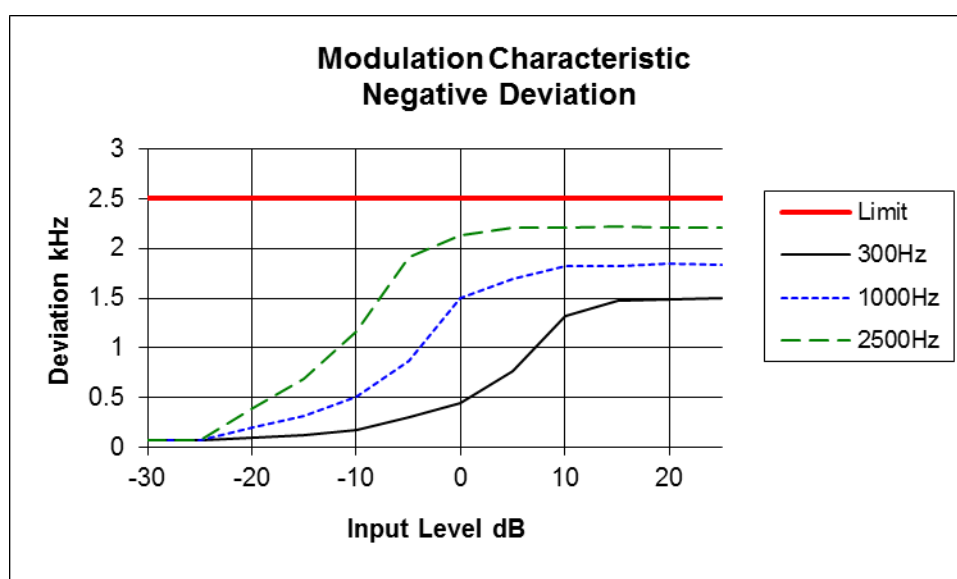
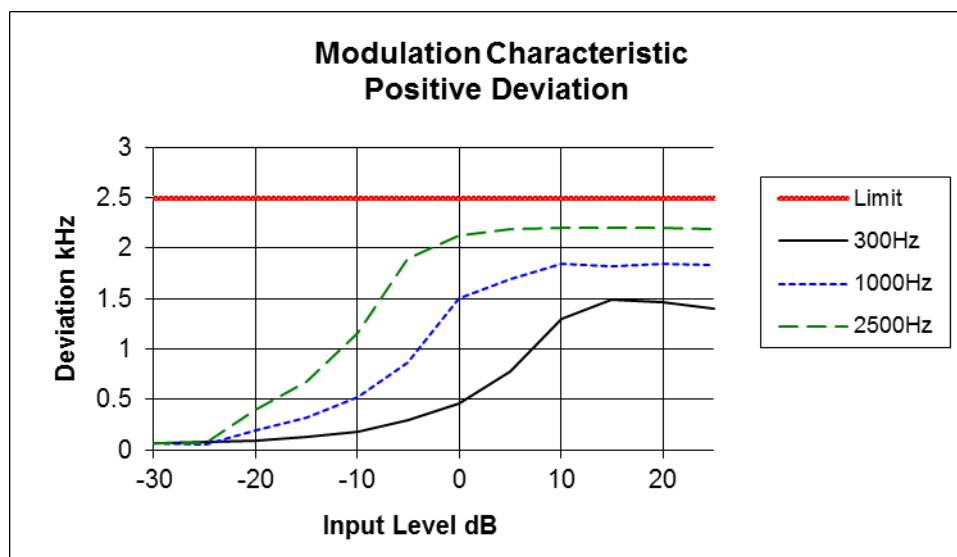

Transmitter Modulation Limiting

SPECIFICATION: FCC CFR 2.1047 (b)

Tx FREQUENCY: 459.9 MHz 12.5 kHz Channel Spacing

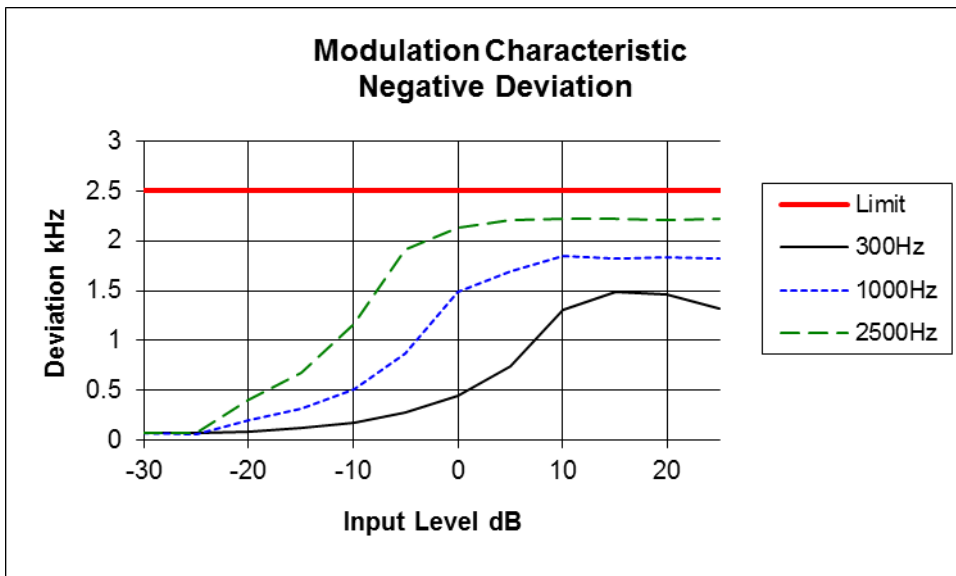
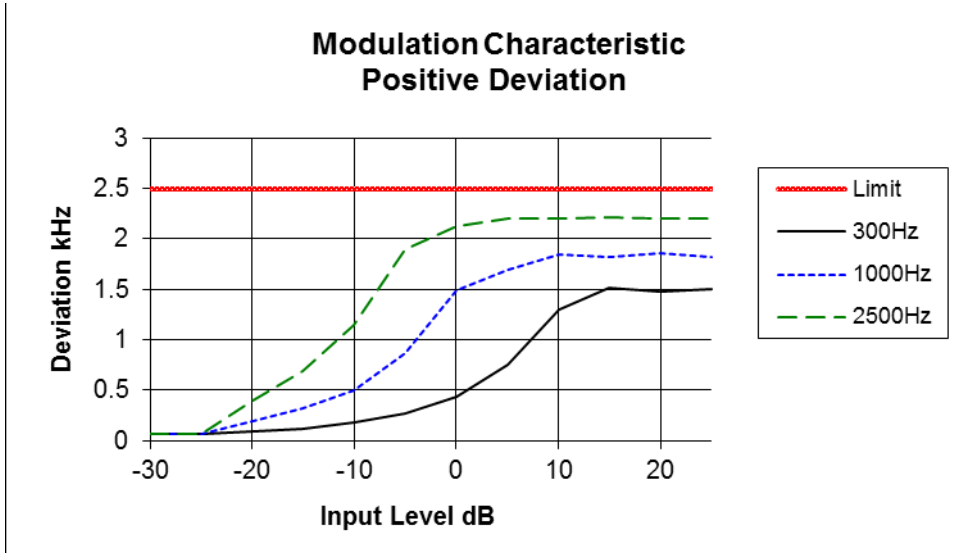

Transmitter Modulation Limiting

SPECIFICATION: FCC CFR 2.1047 (b)

Tx FREQUENCY: 469.9 MHz 12.5 kHz Channel Spacing

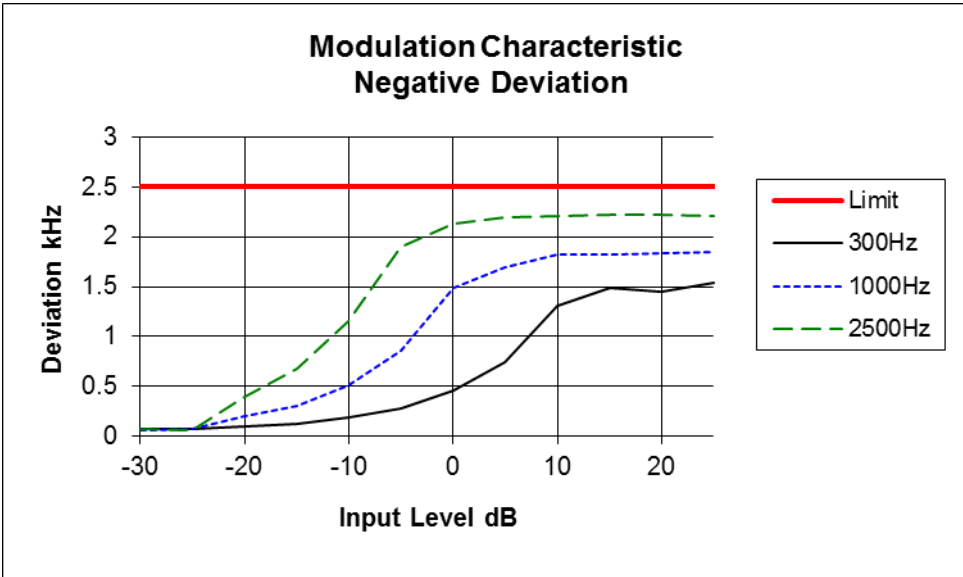
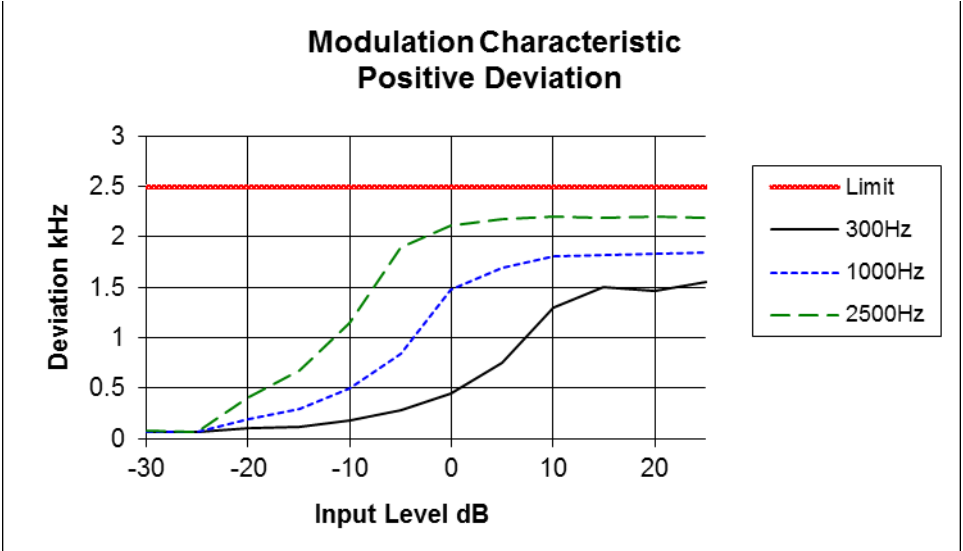

Transmitter Modulation Limiting

SPECIFICATION: FCC CFR 2.1047 (b)

Tx FREQUENCY: 511.9 MHz 12.5 kHz Channel Spacing

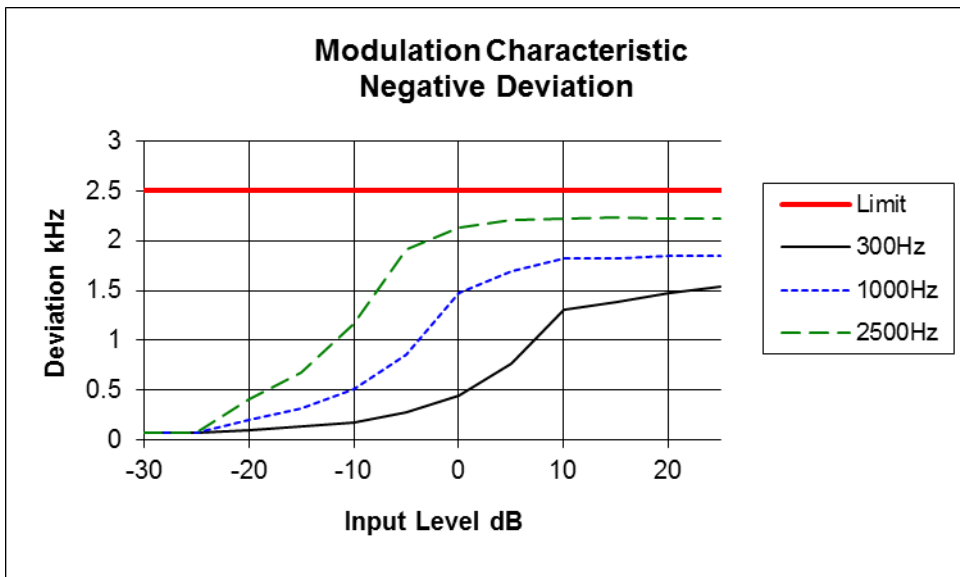
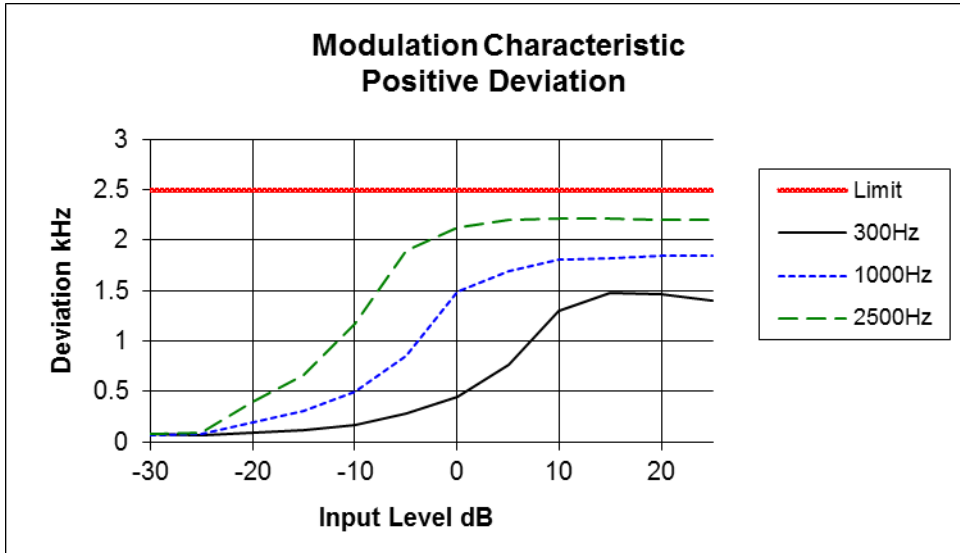

Transmitter Modulation Limiting

SPECIFICATION: FCC CFR 2.1047 (b)

Tx FREQUENCY: 450.1 MHz 25.0 kHz Channel Spacing

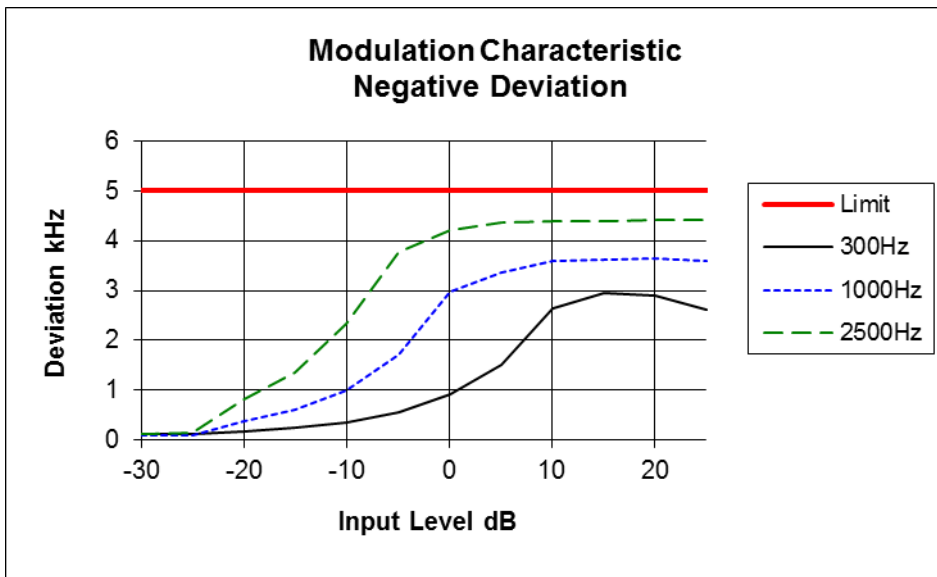
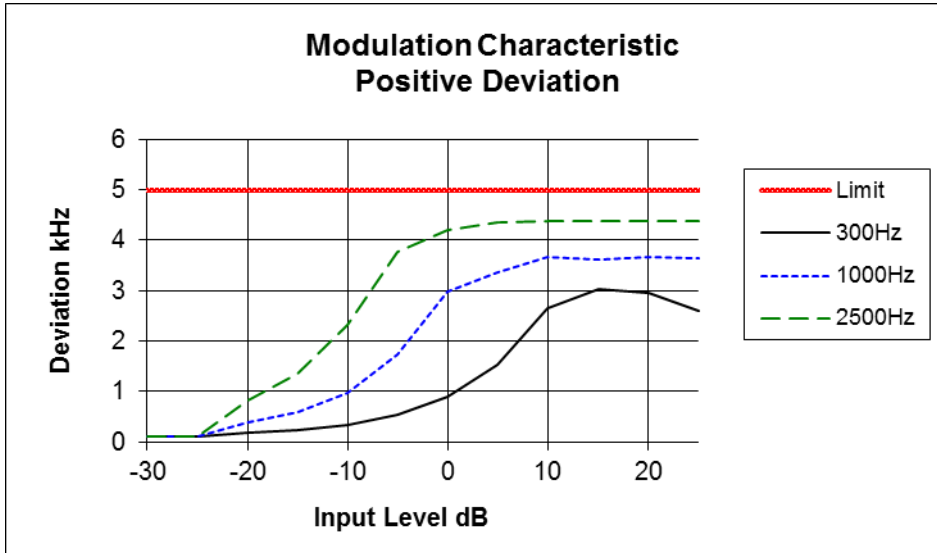

Transmitter Modulation Limiting

SPECIFICATION: FCC CFR 2.1047 (b)

Tx FREQUENCY: 459.9 MHz 25.0 kHz Channel Spacing

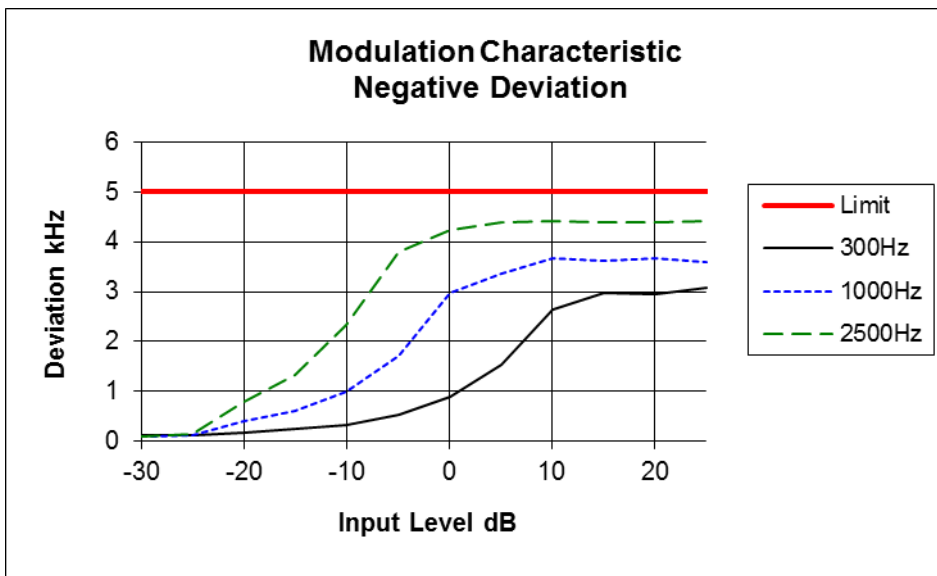
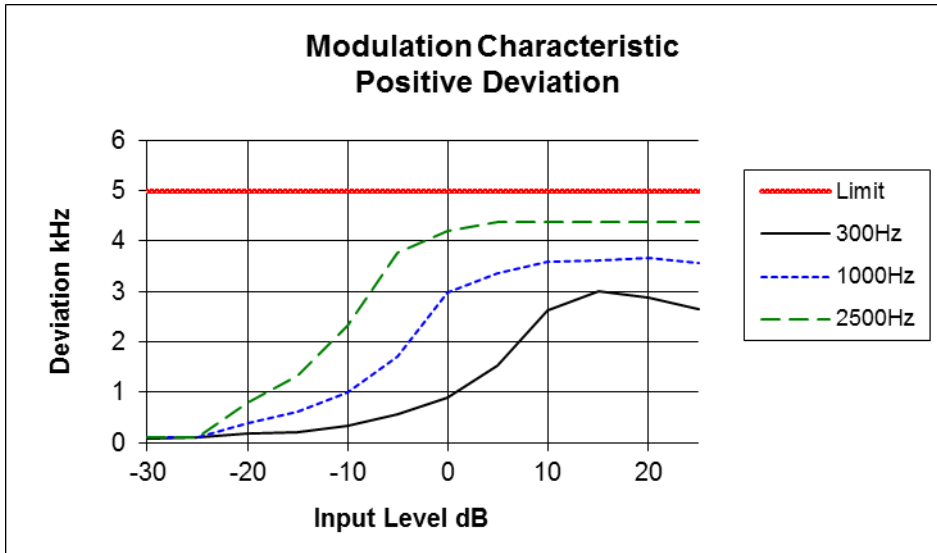

Transmitter Modulation Limiting

SPECIFICATION: FCC CFR 2.1047 (b)

Tx FREQUENCY: 469.9 MHz 25.0 kHz Channel Spacing

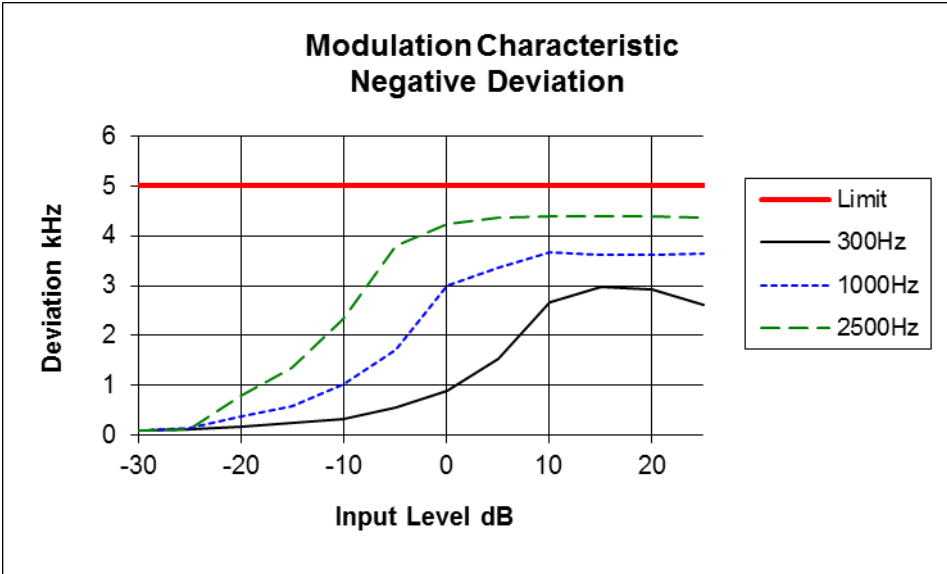
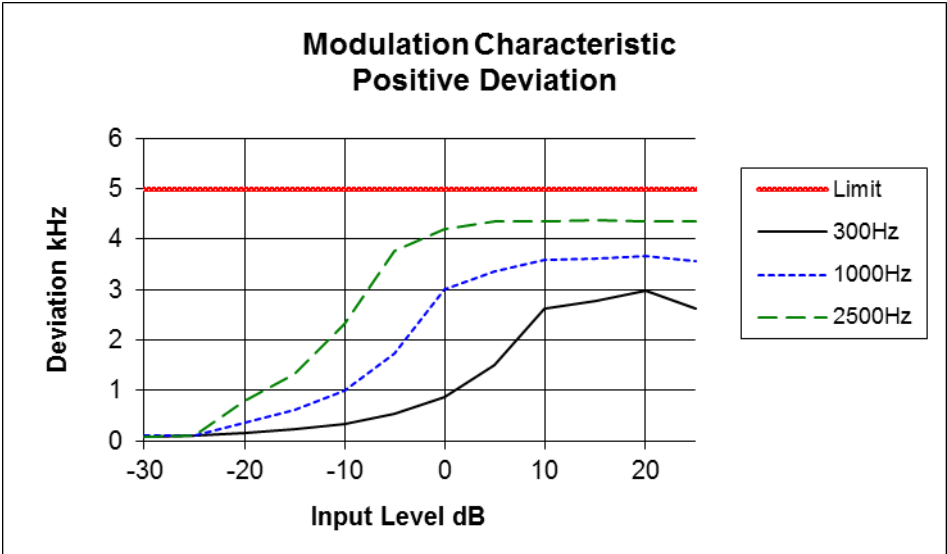

Transmitter Modulation Limiting

SPECIFICATION: FCC CFR 2.1047 (b)

Tx FREQUENCY: 511.9 MHz 25.0 kHz Channel Spacing

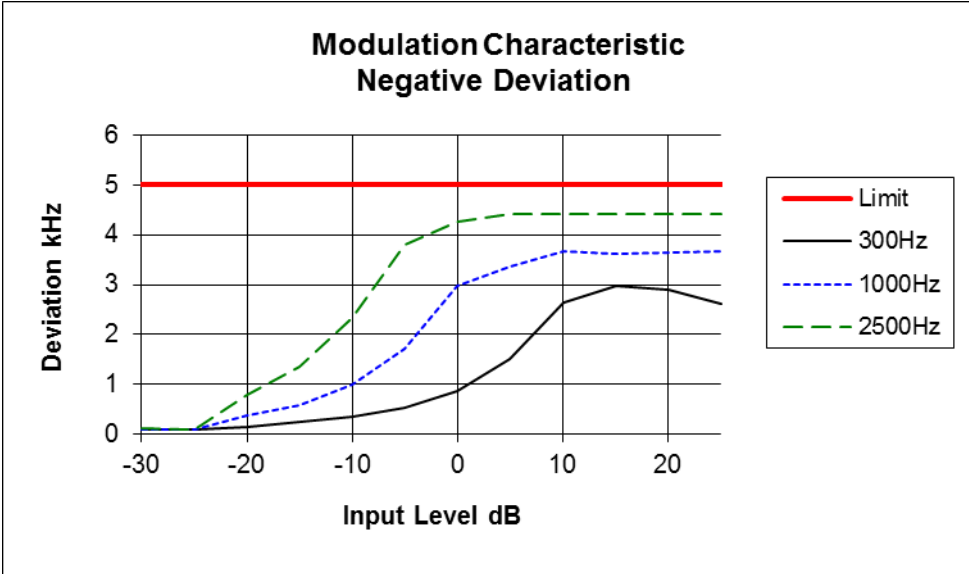
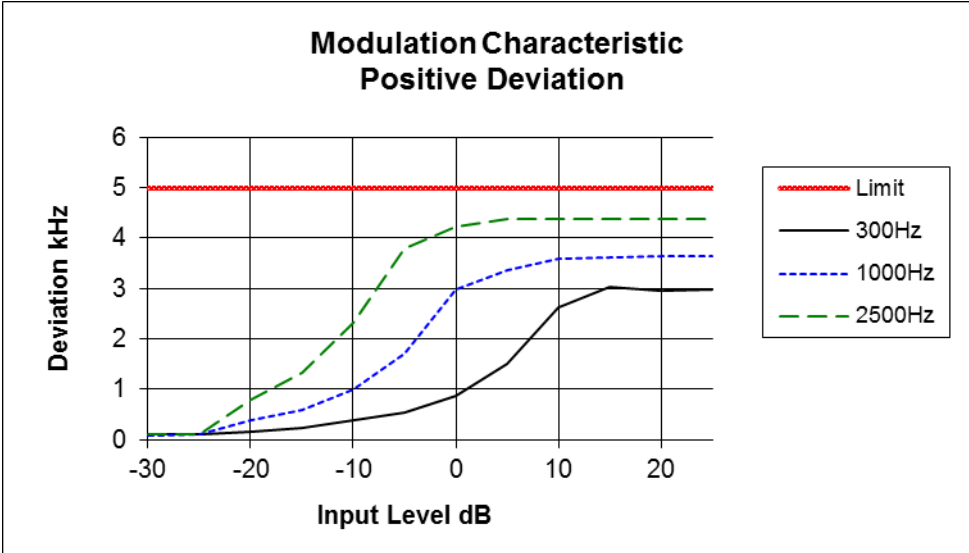

TRANSMITTER OCCUPIED BANDWIDTH AND SPECTRUM MASKS

SPECIFICATION: FCC 47 CFR 2.1049 (c) RSS-119 5.5

GUIDE: TIA/EIA-603D 2.2.11

MEASUREMENT PROCEDURE:

1. Refer Annex A for Equipment Set up.
2. For analog measurements: The EUT was modulated by a 2500 Hz tone at an input level 16 dB above a level that produced 50% deviation. The input level was established at the frequency of maximum response of the audio modulating circuit.
For Data measurements: The EUT was modulated with an internally generated pseudo random bit sequence at the appropriate Baud rates.
3. The Occupied Bandwidth was measured on the Spectrum Analyser, with bandwidth settings as follows.

Emission Mask D – Resolution Bandwidth = 100 Hz, Video Bandwidth = 1 kHz

Emission Mask B, and C – Resolution bandwidth = 300 Hz, Video Bandwidth = 3 kHz

MEASUREMENT RESULTS:

See the plots on the following pages for 12.5 kHz & 25.0 kHz channel spacings.

LIMIT CLAUSE: FCC 47 CFR 90.210 RSS-119 5.5

EMISSION MASKS

Emission Mask D	12.5 kHz Channel Spacing	Analog; FFSK; Digital Voice/Data
Emission Mask B	25.0 kHz Channel Spacing	Analog; FFSK;

DATA SPEED

Digital Voice/Data	12.5 kHz Channel Spacing	9600 bps & 12000 bps
FFSK	12.5 kHz Channel Spacing	1200 bps & 2400 bps
FFSK	25.0 kHz Channel Spacing	1200 bps & 2400 bps

Occupied Bandwidth and Spectrum Masks

ANALOG VOICE

SPECIFICATION: FCC CFR 2.1049 (c)

RSS-119 5.5

Tx FREQUENCY: 450.1 MHz

4 W

12.5 kHz Channel Spacing

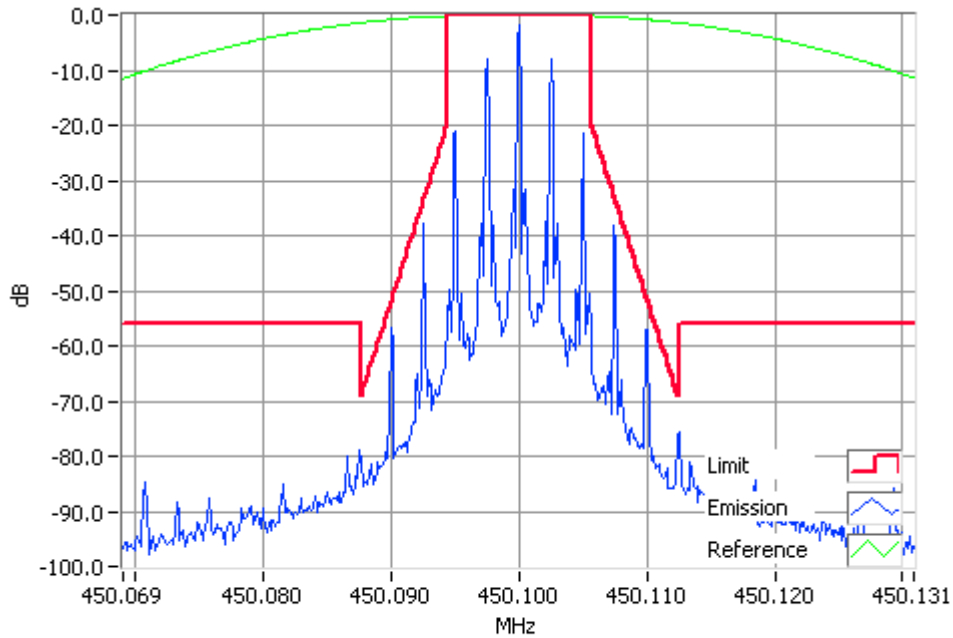

Analogue Modulation 450.1000MHz Mask D 4W
RBW=100Hz, VBW=1000Hz, Detector Mode=Peak
Result=Pass

Tx FREQUENCY: 450.1 MHz

1 W

12.5 kHz Channel Spacing

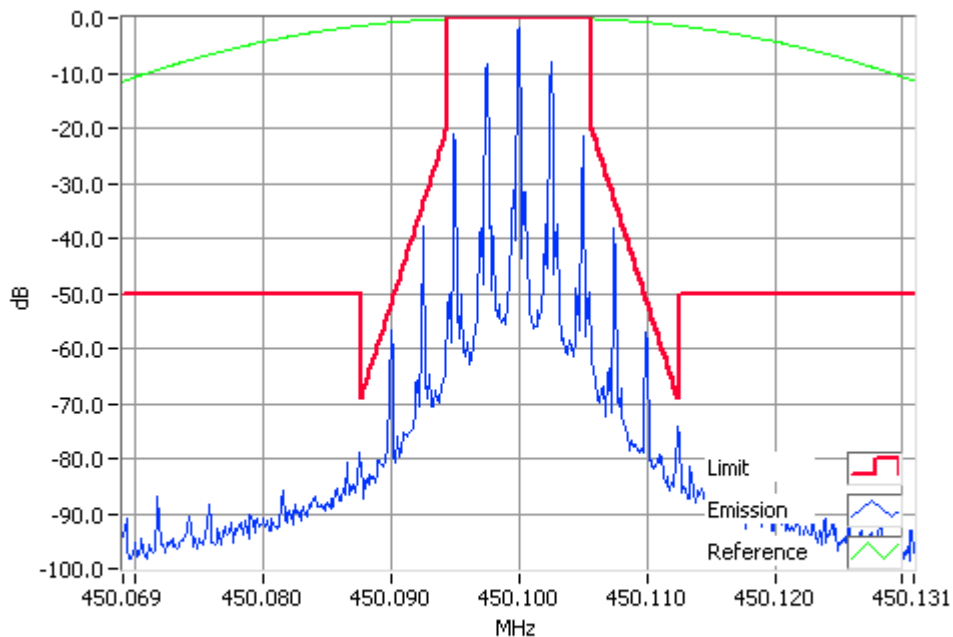

Analogue Modulation 450.1000MHz Mask D 1W
RBW=100Hz, VBW=1000Hz, Detector Mode=Peak
Result=Pass

Occupied Bandwidth and Spectrum Masks

ANALOG VOICE

SPECIFICATION: FCC CFR 2.1049 (c)

RSS-119 5.5

Tx FREQUENCY: 459.9 MHz 4 W 12.5 kHz Channel Spacing

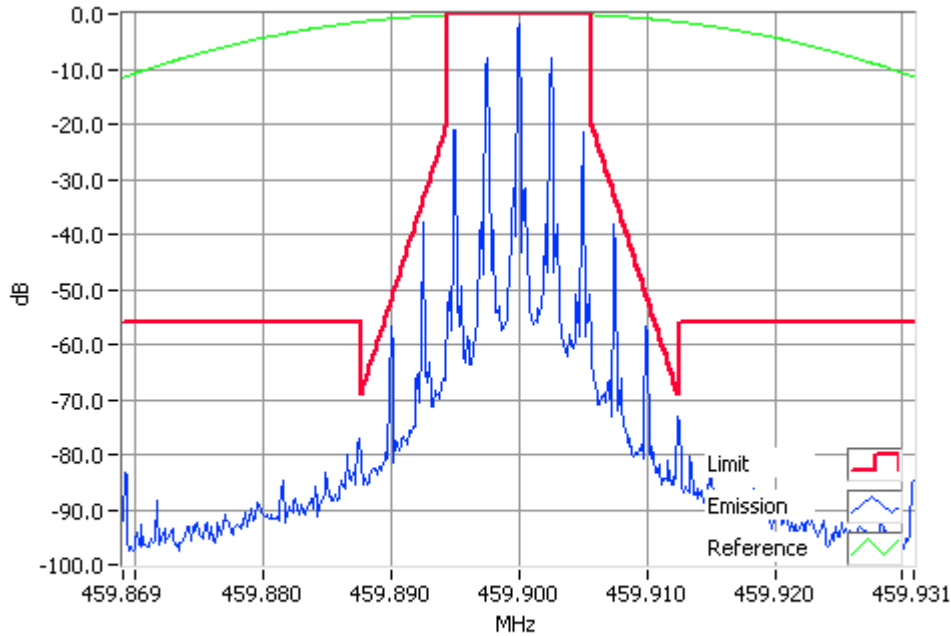

Analogue Modulation 459.9000MHz Mask D 4W
RBW=100Hz, VBW=1000Hz, Detector Mode=Peak
Result=Pass

Tx FREQUENCY: 459.9 MHz 1 W 12.5 kHz Channel Spacing

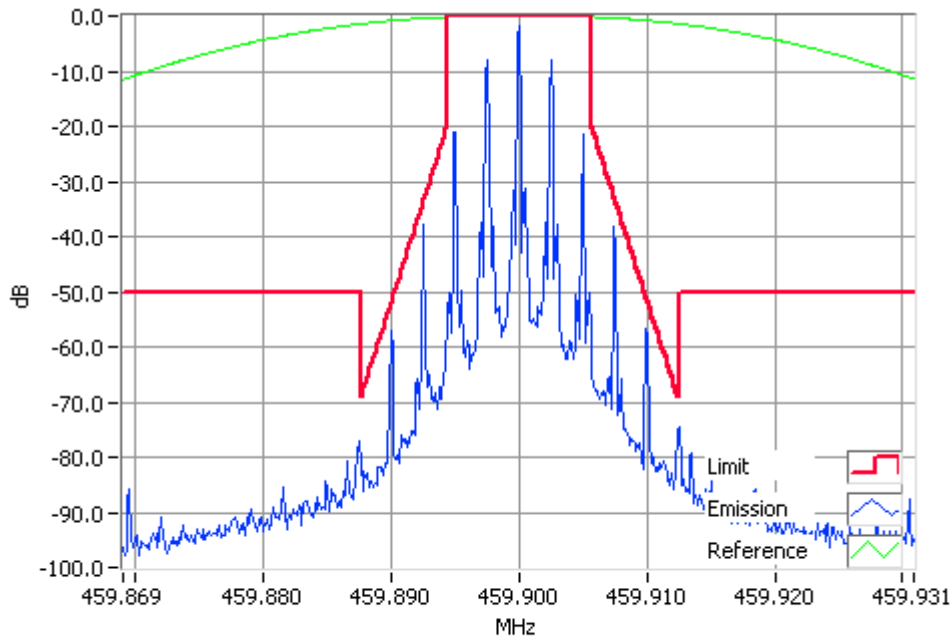

Analogue Modulation 459.9000MHz Mask D 1W
RBW=100Hz, VBW=1000Hz, Detector Mode=Peak
Result=Pass

Occupied Bandwidth and Spectrum Masks

ANALOG VOICE

SPECIFICATION: FCC CFR 2.1049 (c)

RSS-119 5.5

Tx FREQUENCY: 469.9 MHz 4 W 12.5 kHz Channel Spacing

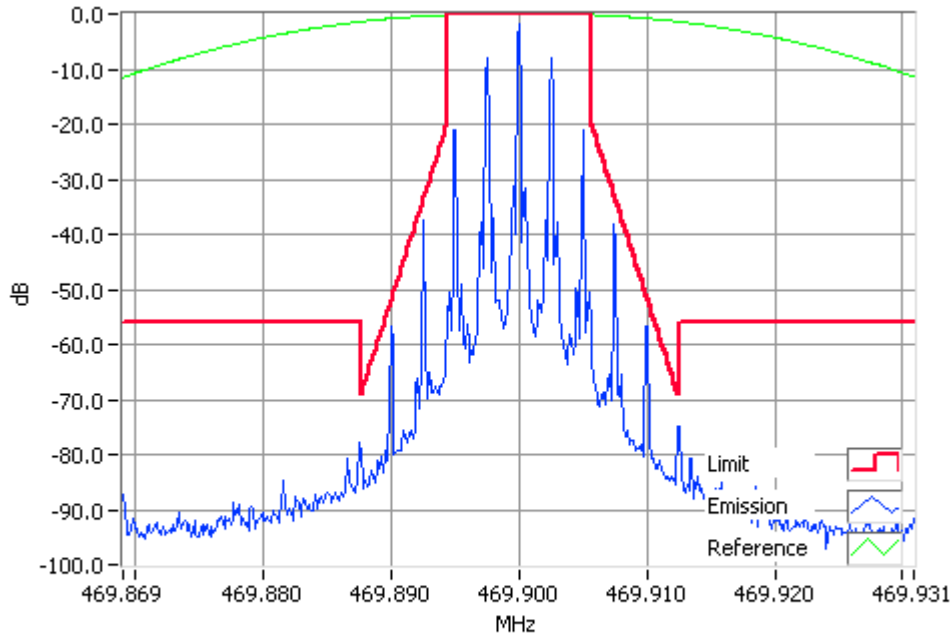

Analogue Modulation 469.9000MHz Mask D 4W
RBW=100Hz, VBW=1000Hz, Detector Mode=Peak
Result=Pass

Tx FREQUENCY: 469.9 MHz 1 W 12.5 kHz Channel Spacing

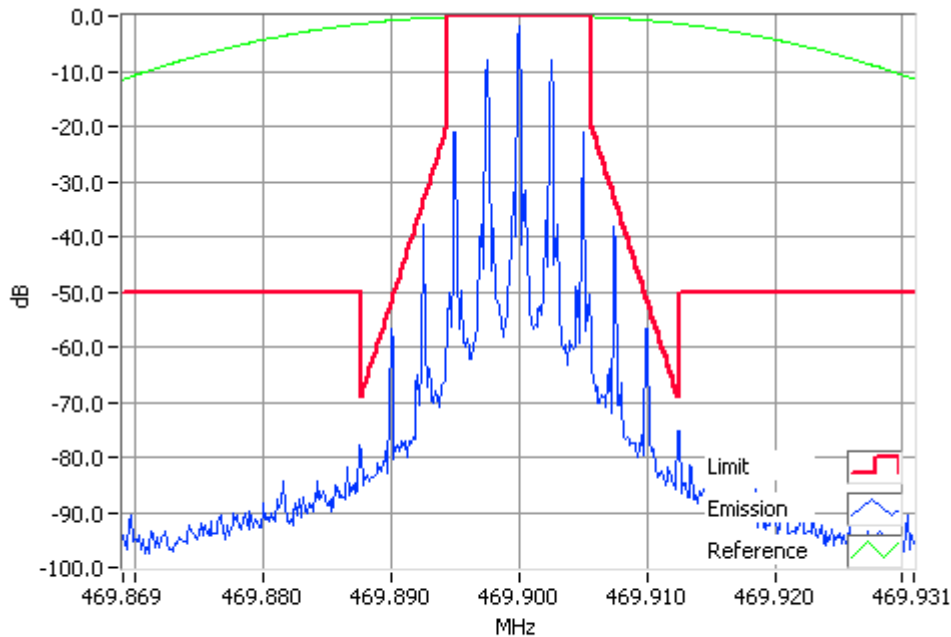

Analogue Modulation 469.9000MHz Mask D 1W
RBW=100Hz, VBW=1000Hz, Detector Mode=Peak
Result=Pass

Occupied Bandwidth and Spectrum Masks

ANALOG VOICE

SPECIFICATION: FCC CFR 2.1049 (c)

RSS-119 5.5

Tx FREQUENCY: 511.9 MHz 4 W 12.5 kHz Channel Spacing

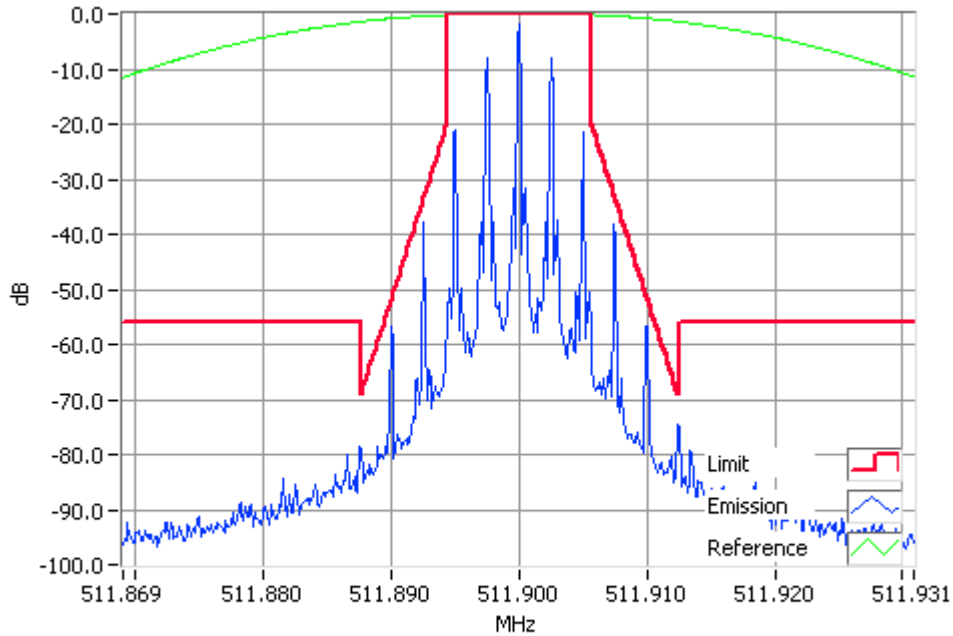

Analogue Modulation 511.9000MHz Mask D 4W
RBW=100Hz, VBW=1000Hz, Detector Mode=Peak
Result=Pass

Tx FREQUENCY: 511.9 MHz 1 W 12.5 kHz Channel Spacing

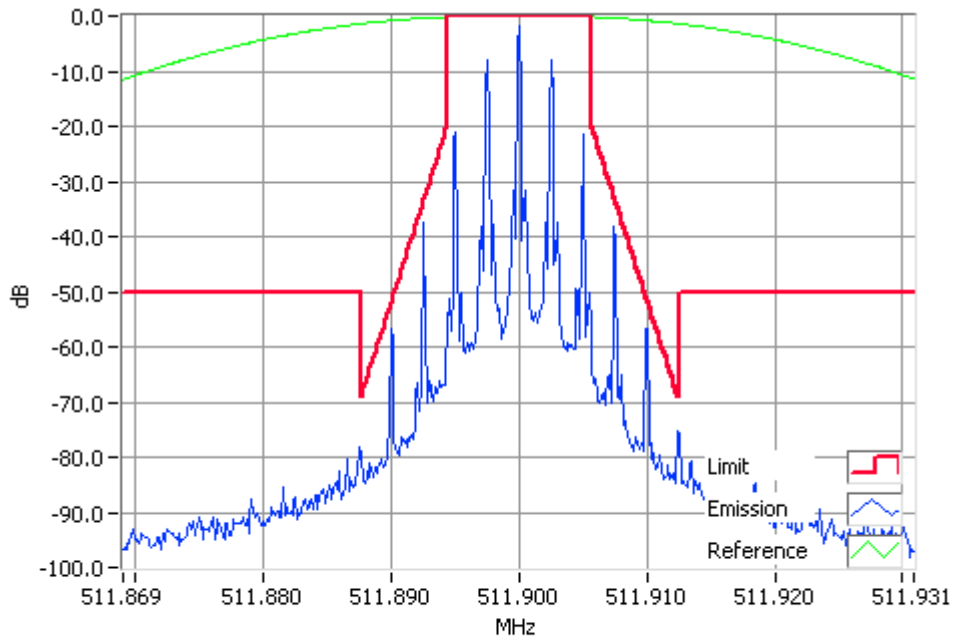

Analogue Modulation 511.9000MHz Mask D 1W
RBW=100Hz, VBW=1000Hz, Detector Mode=Peak
Result=Pass

Occupied Bandwidth and Spectrum Masks

ANALOG VOICE

SPECIFICATION: FCC CFR 2.1049 (c)

RSS-119 5.5

Tx FREQUENCY: 450.1 MHz 4 W 25.0 kHz Channel Spacing

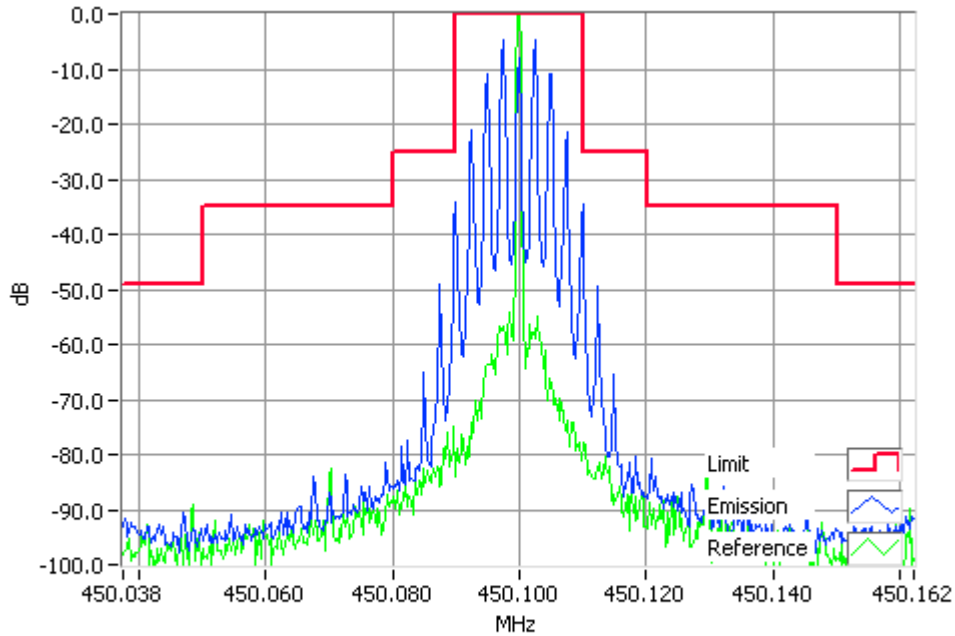

Analogue Modulation 450.1000MHz Mask B 4W
RBW=300Hz, VBW=3000Hz, Detector Mode=Peak
Result=Pass

Tx FREQUENCY: 450.1 MHz 1 W 25.0 kHz Channel Spacing

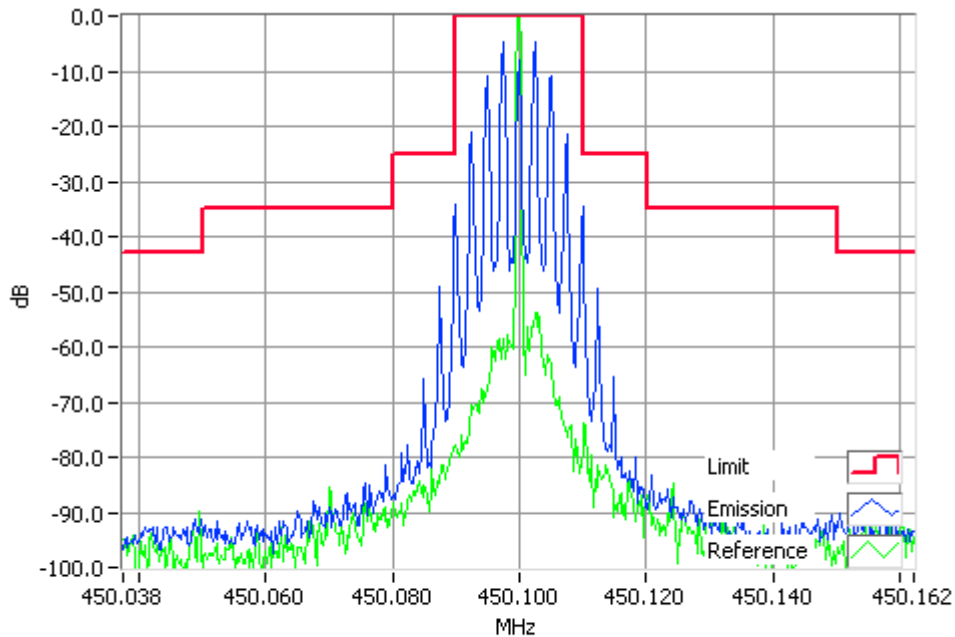

Analogue Modulation 450.1000MHz Mask B 1W
RBW=300Hz, VBW=3000Hz, Detector Mode=Peak
Result=Pass

Occupied Bandwidth and Spectrum Masks

ANALOG VOICE

SPECIFICATION: FCC CFR 2.1049 (c)

RSS-119 5.5

Tx FREQUENCY: 459.9 MHz 4 W 25.0 kHz Channel Spacing

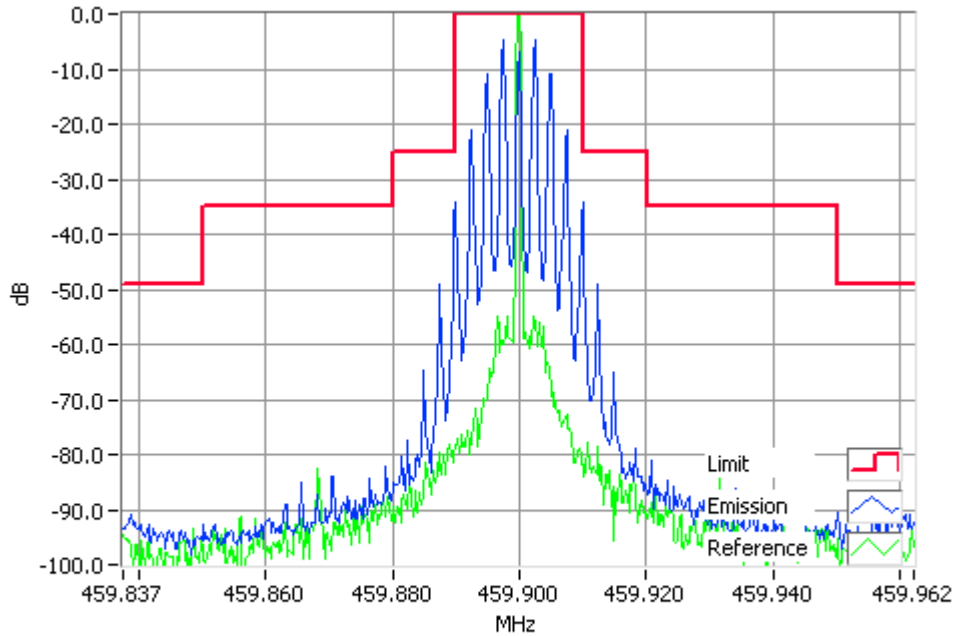

Analogue Modulation 459.9000MHz Mask B 4W
RBW=300Hz, VBW=3000Hz, Detector Mode=Peak
Result=Pass

Tx FREQUENCY: 459.9 MHz 1 W 25.0 kHz Channel Spacing

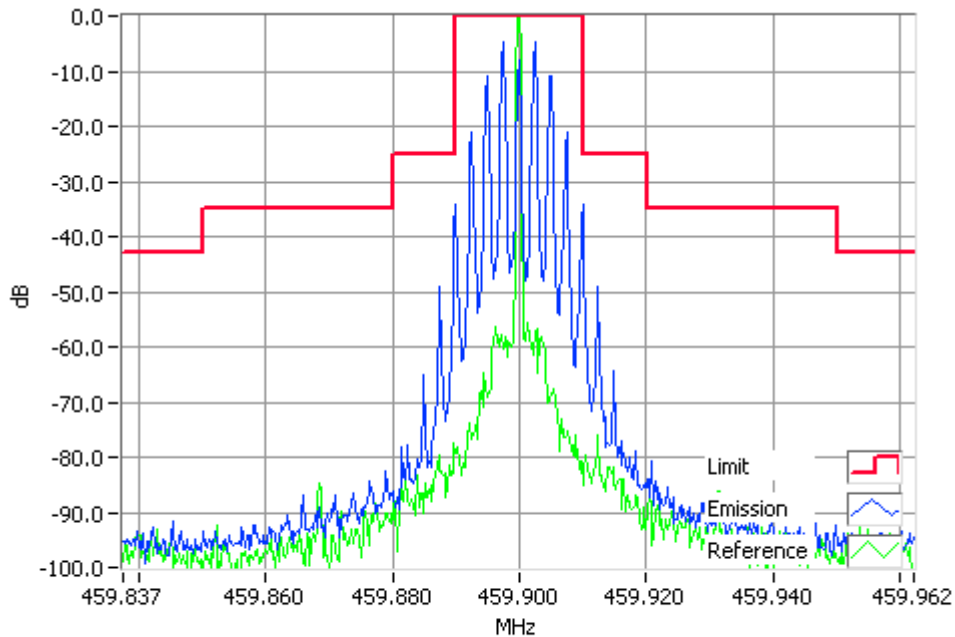

Analogue Modulation 459.9000MHz Mask B 1W
RBW=300Hz, VBW=3000Hz, Detector Mode=Peak
Result=Pass

Occupied Bandwidth and Spectrum Masks

ANALOG VOICE

SPECIFICATION: FCC CFR 2.1049 (c)

RSS-119 5.5

Tx FREQUENCY: 469.9 MHz 4 W 25.0 kHz Channel Spacing

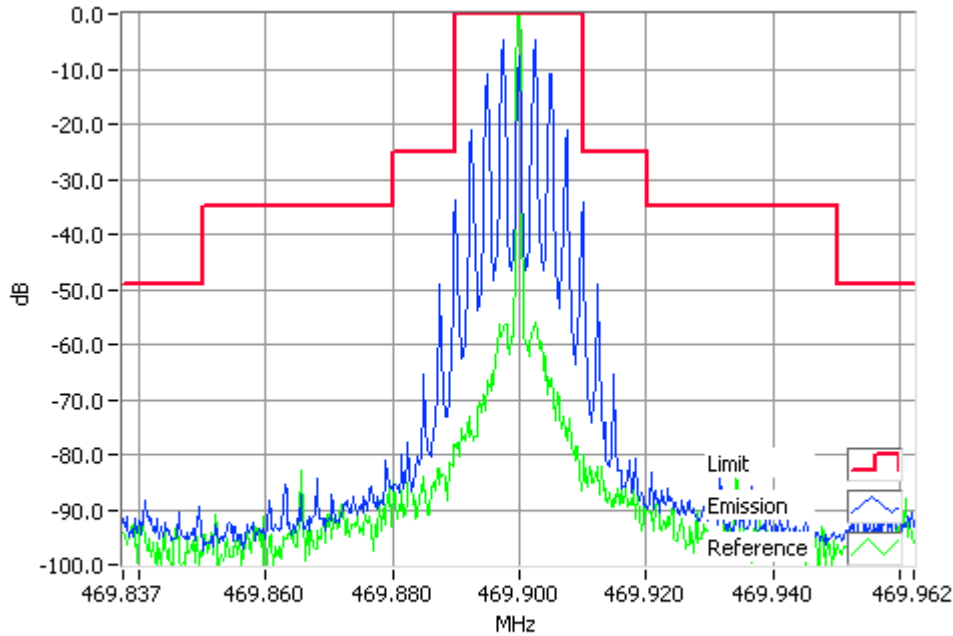

Analogue Modulation 469.9000MHz Mask B 4W
RBW=300Hz, VBW=3000Hz, Detector Mode=Peak
Result=Pass

Tx FREQUENCY: 469.9 MHz 1 W 25.0 kHz Channel Spacing

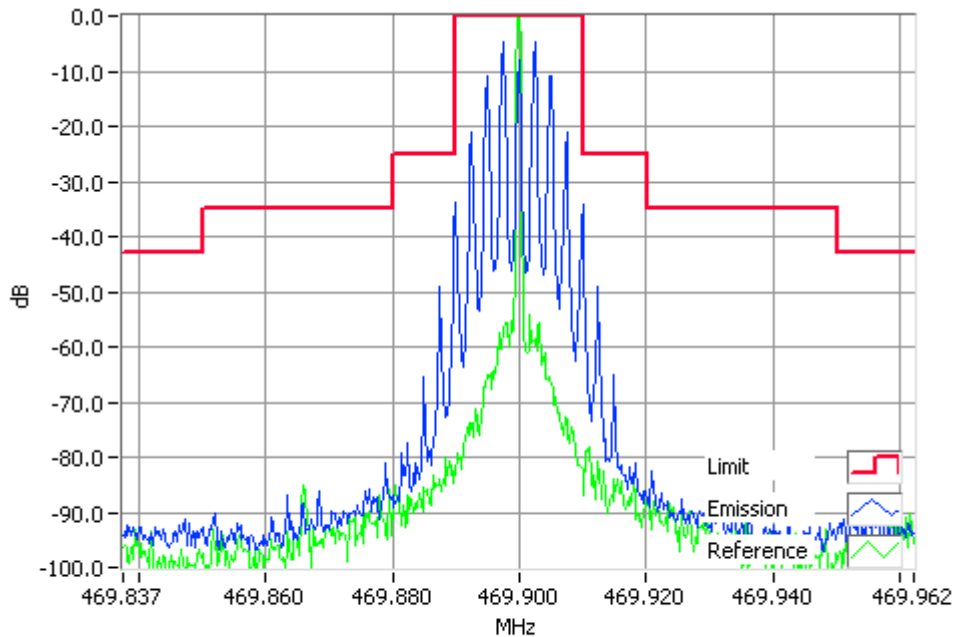

Analogue Modulation 469.9000MHz Mask B 1W
RBW=300Hz, VBW=3000Hz, Detector Mode=Peak
Result=Pass

Occupied Bandwidth and Spectrum Masks

ANALOG VOICE

SPECIFICATION: FCC CFR 2.1049 (c)

RSS-119 5.5

Tx FREQUENCY: 511.9 MHz 4 W 25.0 kHz Channel Spacing

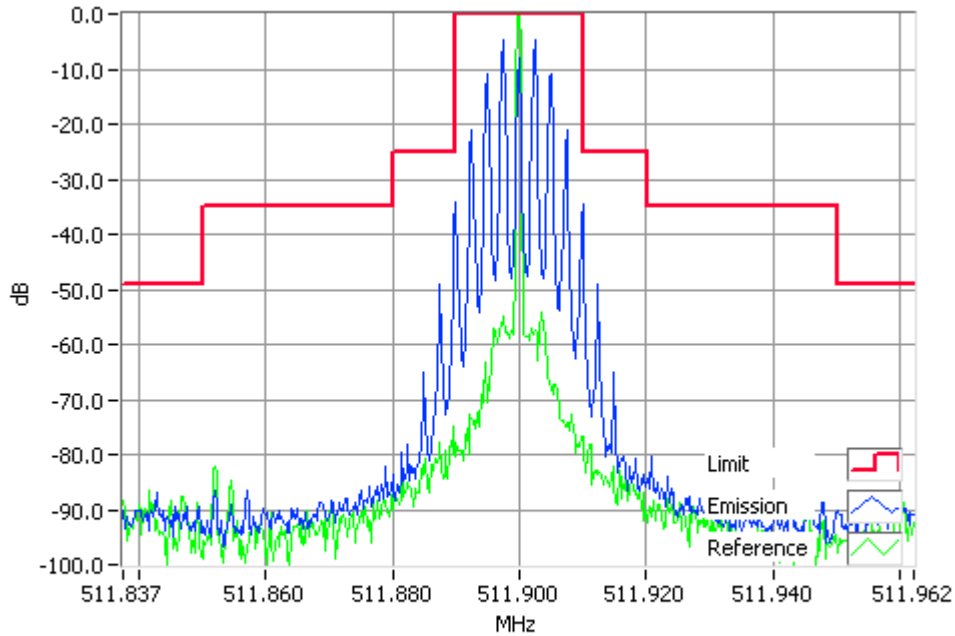

Analogue Modulation 511.9000MHz Mask B 4W
RBW=300Hz, VBW=3000Hz, Detector Mode=Peak
Result=Pass

Tx FREQUENCY: 511.9 MHz 1 W 25.0 kHz Channel Spacing

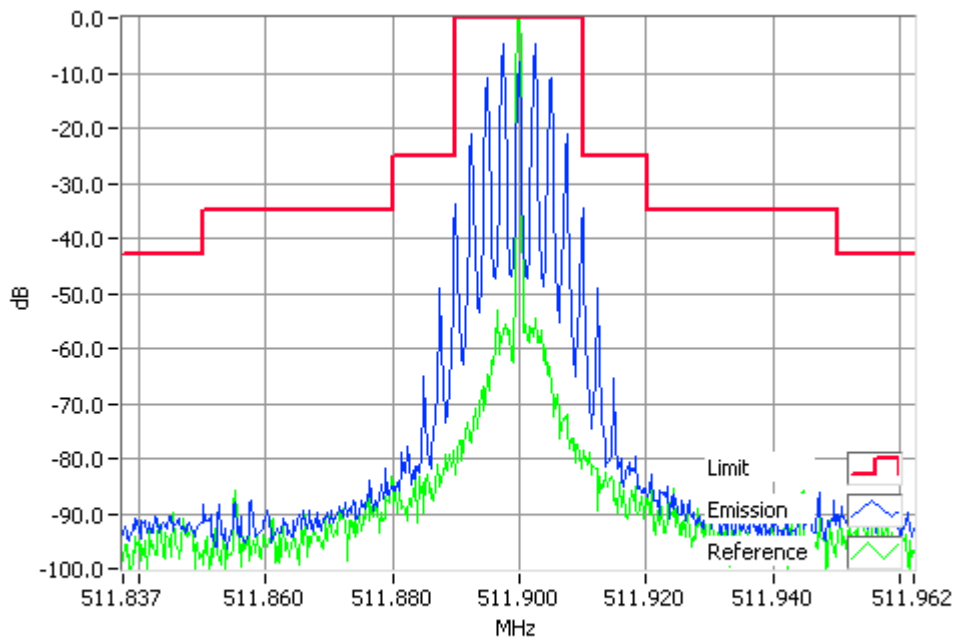

Analogue Modulation 511.9000MHz Mask B 1W
RBW=300Hz, VBW=3000Hz, Detector Mode=Peak
Result=Pass

Occupied Bandwidth and Spectrum Masks

FFSK – 1200 bps

SPECIFICATION: FCC CFR 2.1049 (c)

RSS-119 5.5

Tx FREQUENCY: 450.1 MHz 4 W 12.5 kHz Channel Spacing

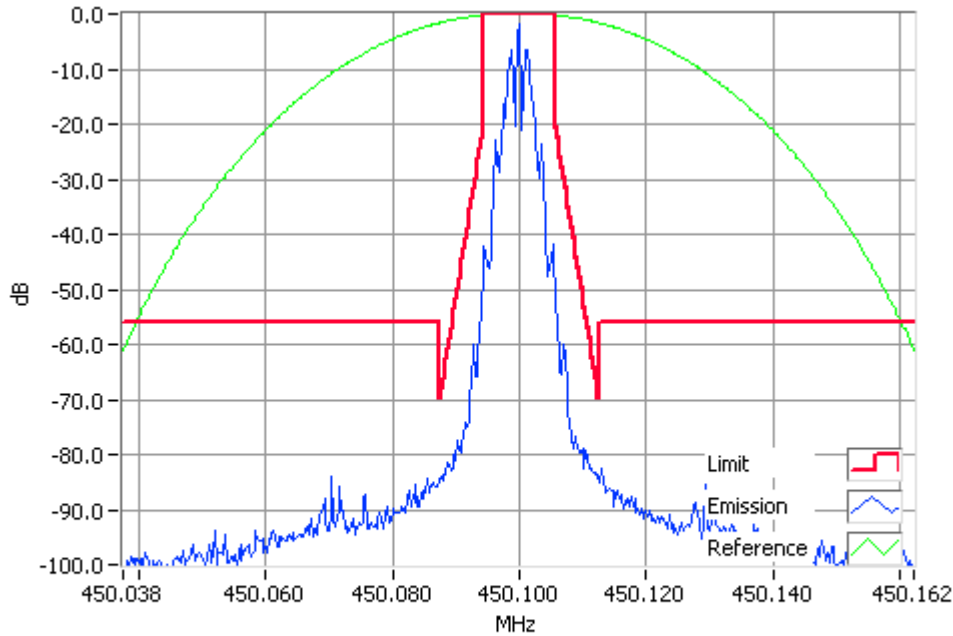

FFSK 1200 bps 450.1000MHz Mask D 4W
RBW=100Hz, VBW=1000Hz, Detector Mode=Peak
Result=Pass

Tx FREQUENCY: 450.1 MHz 1 W 12.5 kHz Channel Spacing

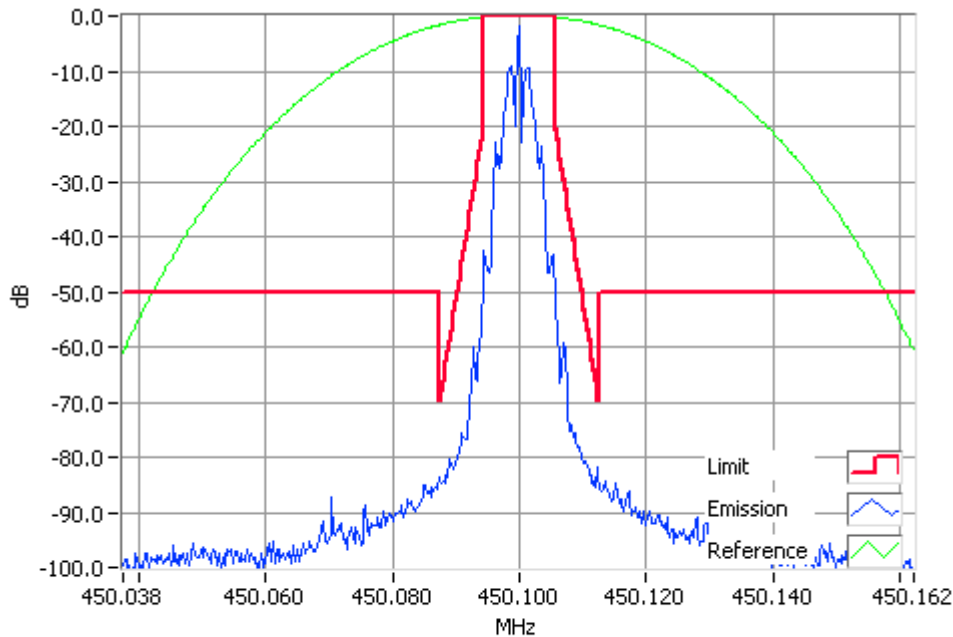

FFSK 1200 bps 450.1000MHz Mask D 1W
RBW=100Hz, VBW=1000Hz, Detector Mode=Peak
Result=Pass

Occupied Bandwidth and Spectrum Masks

FFSK – 1200 bps

SPECIFICATION: FCC CFR 2.1049 (c)

RSS-119 5.5

Tx FREQUENCY: 459.9 MHz 4 W 12.5 kHz Channel Spacing

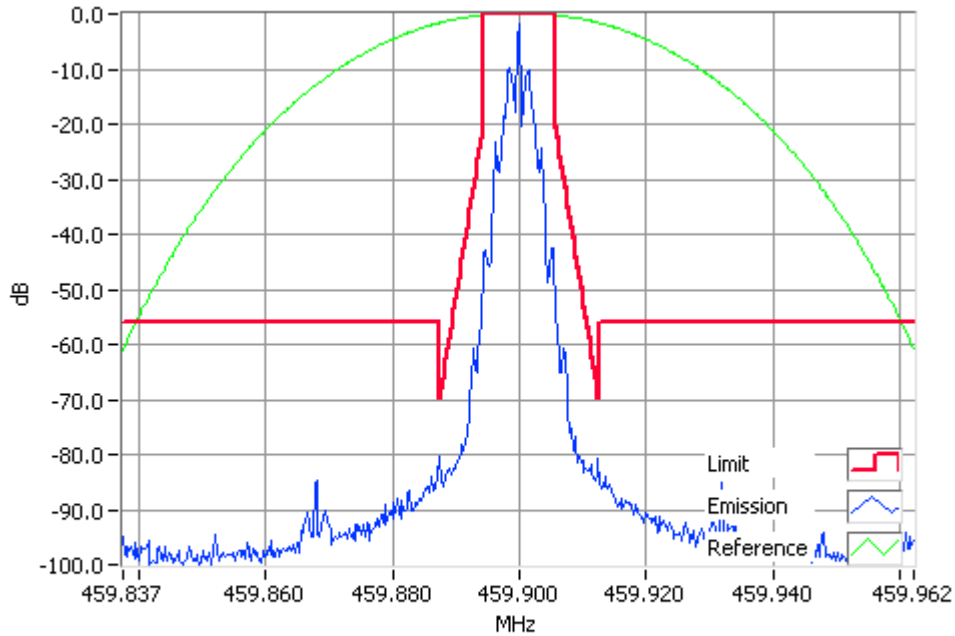

FFSK 1200 bps 459.9000MHz Mask D 4W
RBW=100Hz, VBW=1000Hz, Detector Mode=Peak
Result=Pass

Tx FREQUENCY: 459.9 MHz 1 W 12.5 kHz Channel Spacing

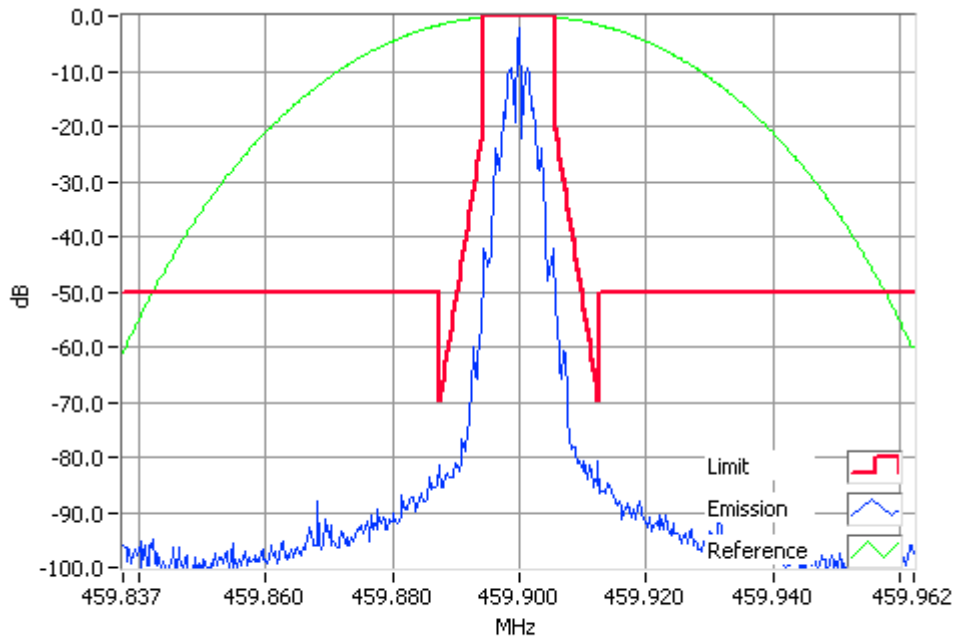

FFSK 1200 bps 459.9000MHz Mask D 1W
RBW=100Hz, VBW=1000Hz, Detector Mode=Peak
Result=Pass

Occupied Bandwidth and Spectrum Masks

FFSK – 1200 bps

SPECIFICATION: FCC CFR 2.1049 (c)

RSS-119 5.5

Tx FREQUENCY: 469.9 MHz 4 W 12.5 kHz Channel Spacing

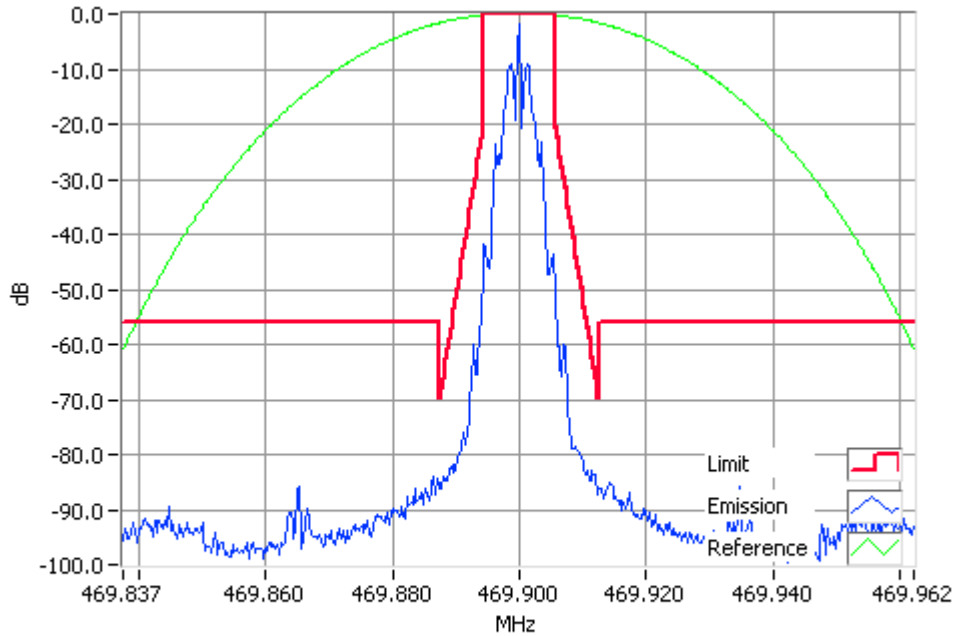

FFSK 1200 bps 469.9000MHz Mask D 4W
RBW=100Hz, VBW=1000Hz, Detector Mode=Peak
Result=Pass

Tx FREQUENCY: 469.9 MHz 1 W 12.5 kHz Channel Spacing

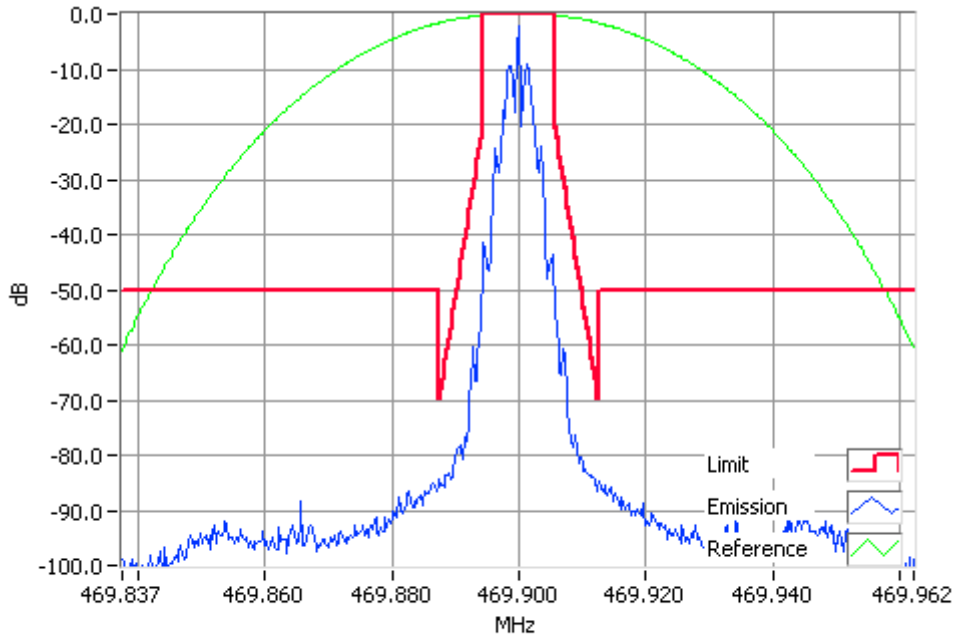

FFSK 1200 bps 469.9000MHz Mask D 1W
RBW=100Hz, VBW=1000Hz, Detector Mode=Peak
Result=Pass

Occupied Bandwidth and Spectrum Masks

FFSK – 1200 bps

SPECIFICATION: FCC CFR 2.1049 (c)

RSS-119 5.5

Tx FREQUENCY: 511.9 MHz 4 W 12.5 kHz Channel Spacing

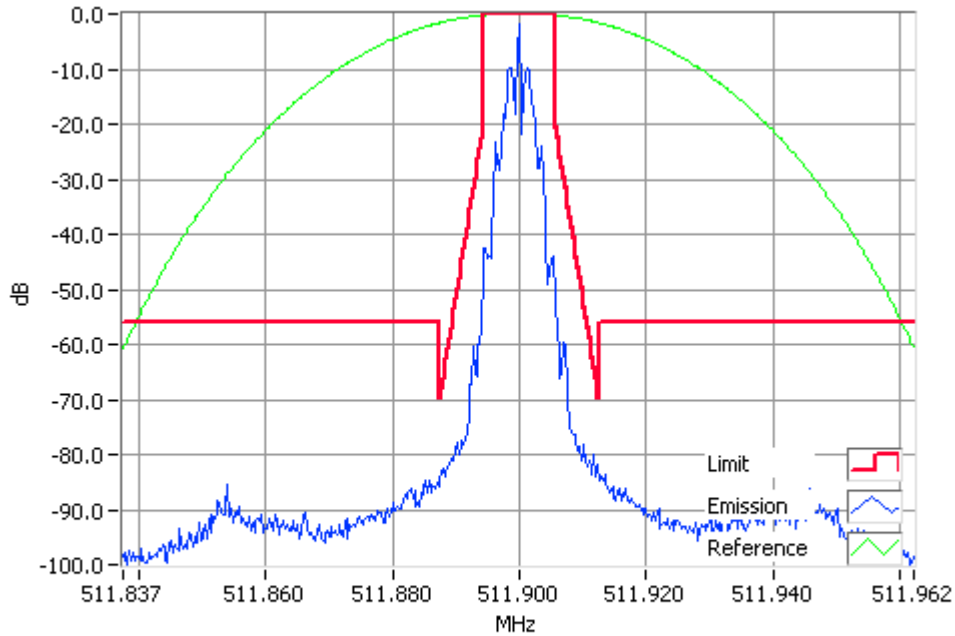

FFSK 1200 bps 511.9000MHz Mask D 4W
RBW=100Hz, VBW=1000Hz, Detector Mode=Peak
Result=Pass

Tx FREQUENCY: 511.9 MHz 1 W 12.5 kHz Channel Spacing

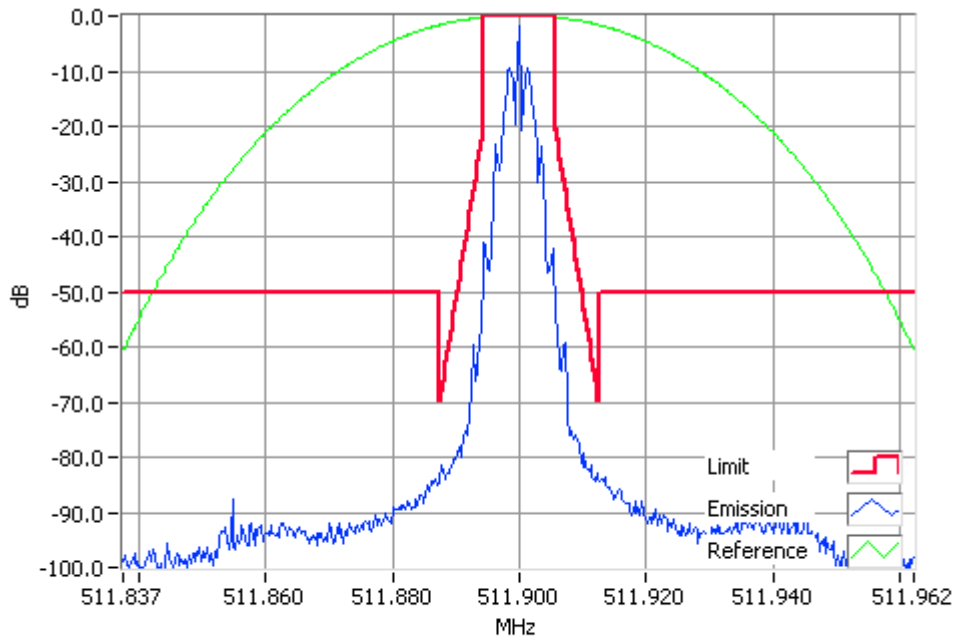

FFSK 1200 bps 511.9000MHz Mask D 1W
RBW=100Hz, VBW=1000Hz, Detector Mode=Peak
Result=Pass

Occupied Bandwidth and Spectrum Masks

FFSK – 1200 bps

SPECIFICATION: FCC CFR 2.1049 (c)

RSS-119 5.5

Tx FREQUENCY: 450.1 MHz 4 W 25.0 kHz Channel Spacing

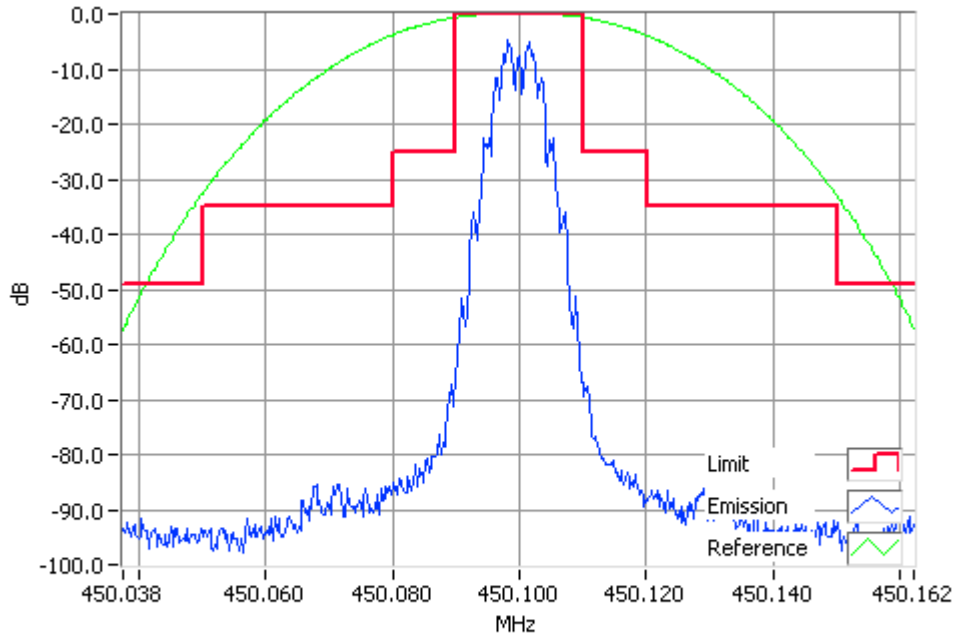

FFSK 1200 bps 450.1000MHz Mask B 4W
RBW=300Hz, VBW=3000Hz, Detector Mode=Peak
Result=Pass

Tx FREQUENCY: 450.1 MHz 1 W 25.0 kHz Channel Spacing

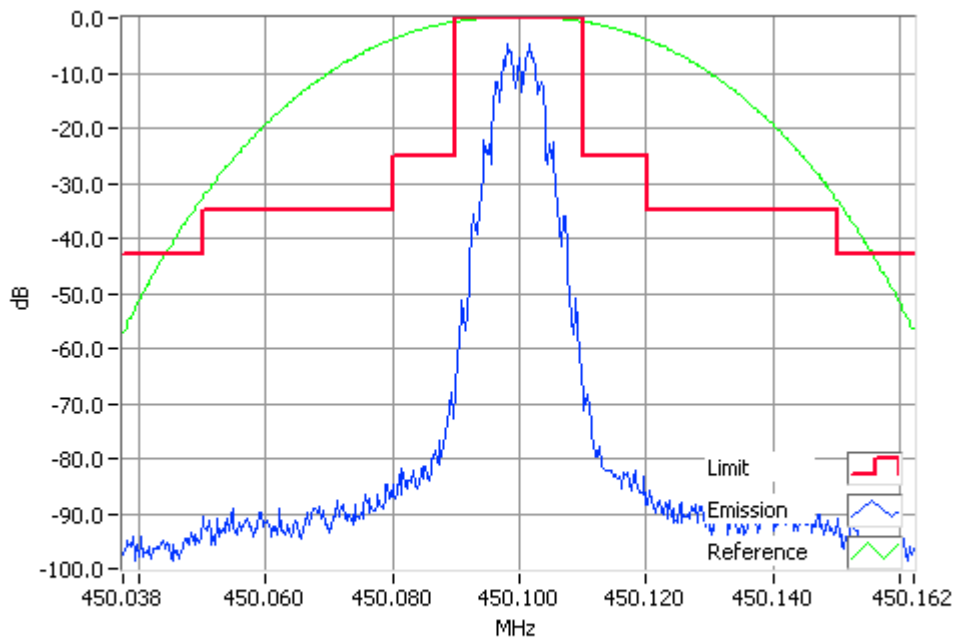

FFSK 1200 bps 450.1000MHz Mask B 1W
RBW=300Hz, VBW=3000Hz, Detector Mode=Peak
Result=Pass

Occupied Bandwidth and Spectrum Masks

FFSK – 1200 bps

SPECIFICATION: FCC CFR 2.1049 (c)

RSS-119 5.5

Tx FREQUENCY: 459.9 MHz 4 W 25.0 kHz Channel Spacing

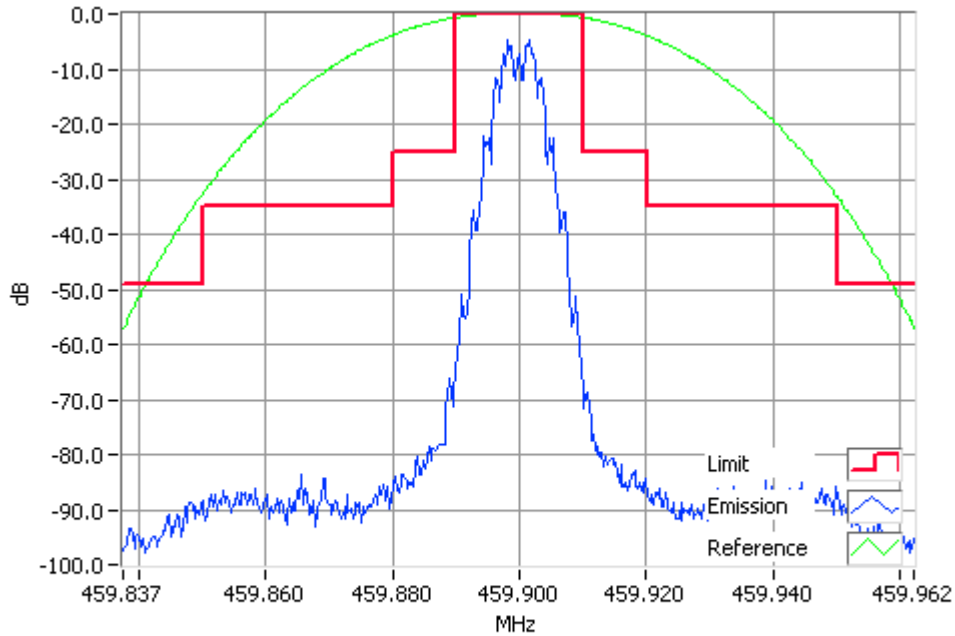

FFSK 1200 bps 459.9000MHz Mask B 4W
RBW=300Hz, VBW=3000Hz, Detector Mode=Peak
Result=Pass

Tx FREQUENCY: 459.9 MHz 1 W 25.0 kHz Channel Spacing

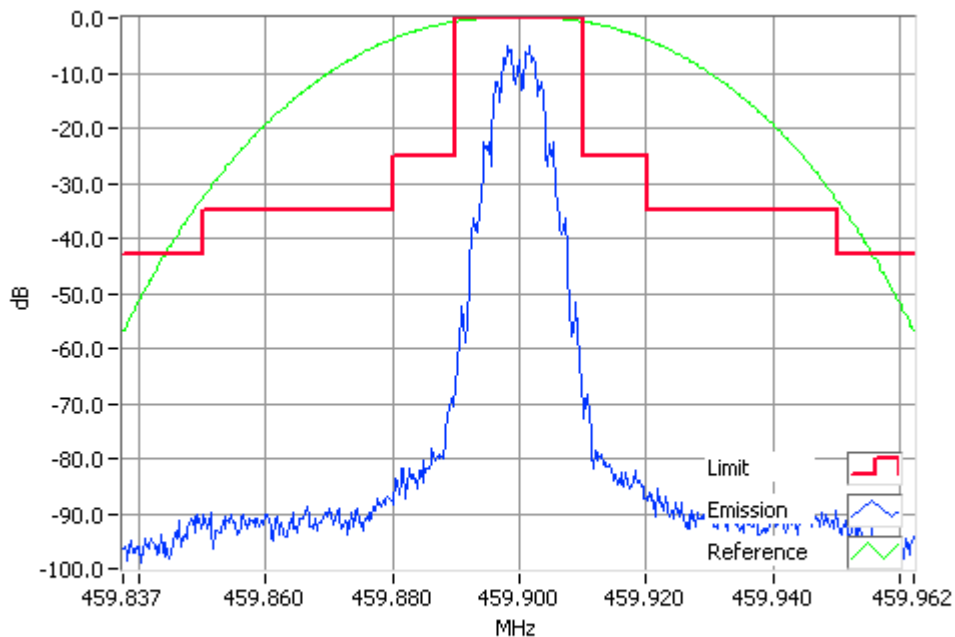

FFSK 1200 bps 459.9000MHz Mask B 1W
RBW=300Hz, VBW=3000Hz, Detector Mode=Peak
Result=Pass

Occupied Bandwidth and Spectrum Masks

FFSK – 1200 bps

SPECIFICATION: FCC CFR 2.1049 (c)

RSS-119 5.5

Tx FREQUENCY: 469.9 MHz 4 W 25.0 kHz Channel Spacing

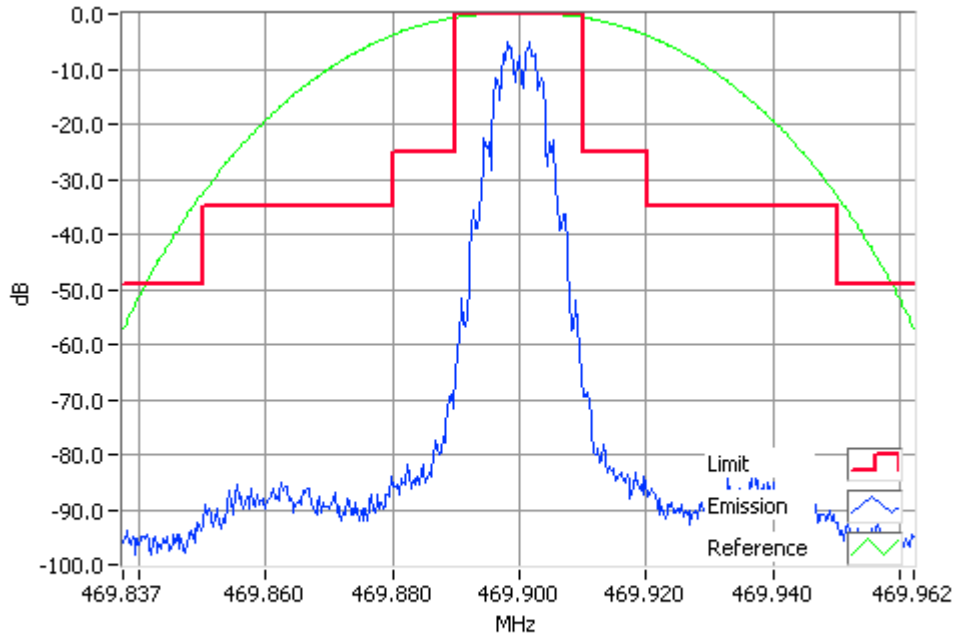

FFSK 1200 bps 469.9000MHz Mask B 4W
RBW=300Hz, VBW=3000Hz, Detector Mode=Peak
Result=Pass

Tx FREQUENCY: 469.9 MHz 1 W 25.0 kHz Channel Spacing

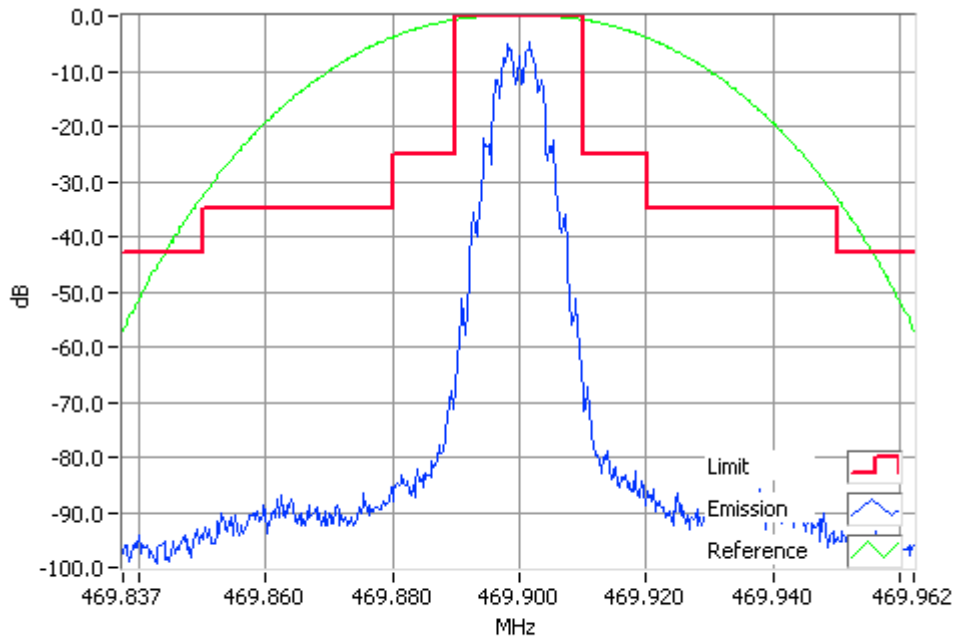

FFSK 1200 bps 469.9000MHz Mask B 1W
RBW=300Hz, VBW=3000Hz, Detector Mode=Peak
Result=Pass

Occupied Bandwidth and Spectrum Masks

FFSK – 1200 bps

SPECIFICATION: FCC CFR 2.1049 (c)

RSS-119 5.5

Tx FREQUENCY: 511.9 MHz 4 W 25.0 kHz Channel Spacing

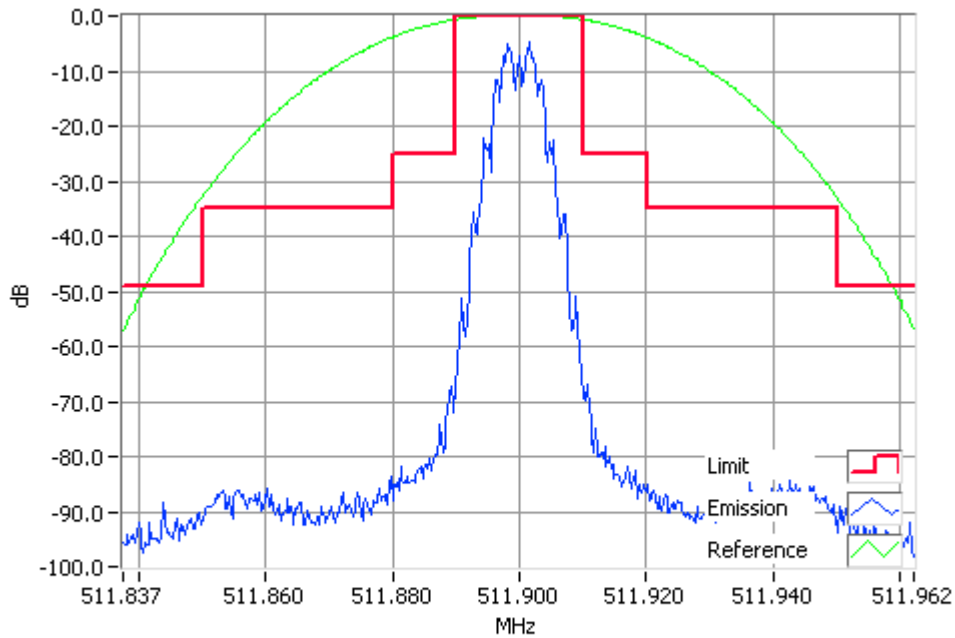

FFSK 1200 bps 511.9000MHz Mask B 4W
RBW=300Hz, VBW=3000Hz, Detector Mode=Peak
Result=Pass

Tx FREQUENCY: 511.9 MHz 1 W 25.0 kHz Channel Spacing

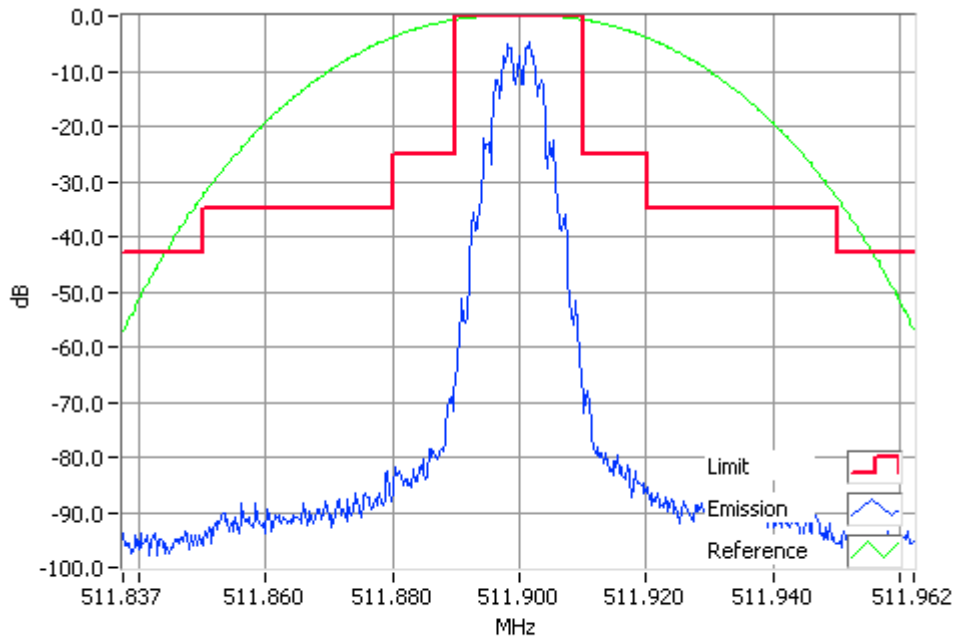

FFSK 1200 bps 511.9000MHz Mask B 1W
RBW=300Hz, VBW=3000Hz, Detector Mode=Peak
Result=Pass

Occupied Bandwidth and Spectrum Masks

FFSK – 2400 bps

SPECIFICATION: FCC CFR 2.1049 (c)

RSS-119 5.5

Tx FREQUENCY: 450.1 MHz 4 W 12.5 kHz Channel Spacing

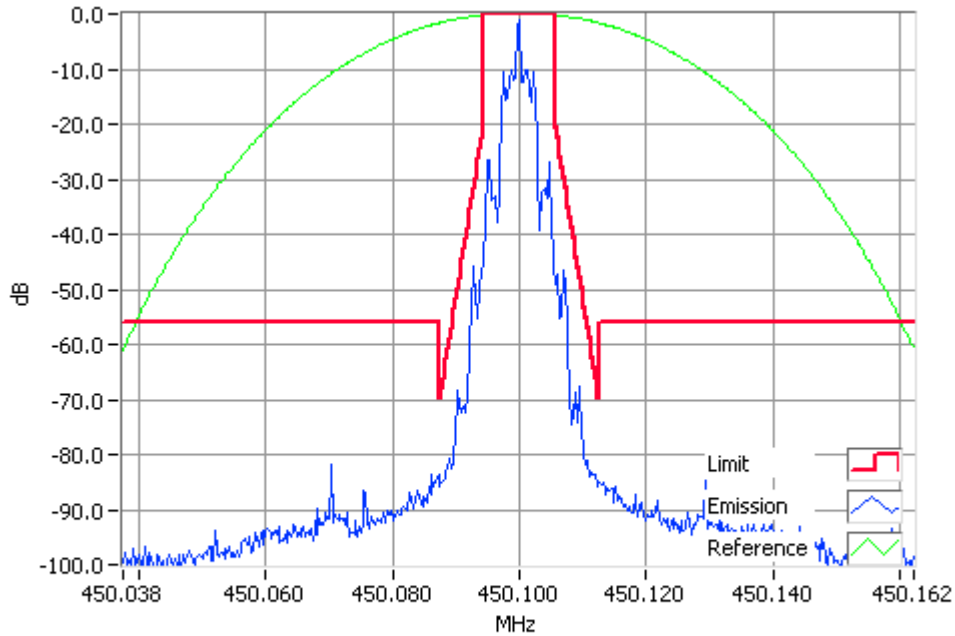

FFSK 2400 bps 450.1000MHz Mask D 4W
RBW=100Hz, VBW=1000Hz, Detector Mode=Peak
Result=Pass

Tx FREQUENCY: 450.1 MHz 1 W 12.5 kHz Channel Spacing

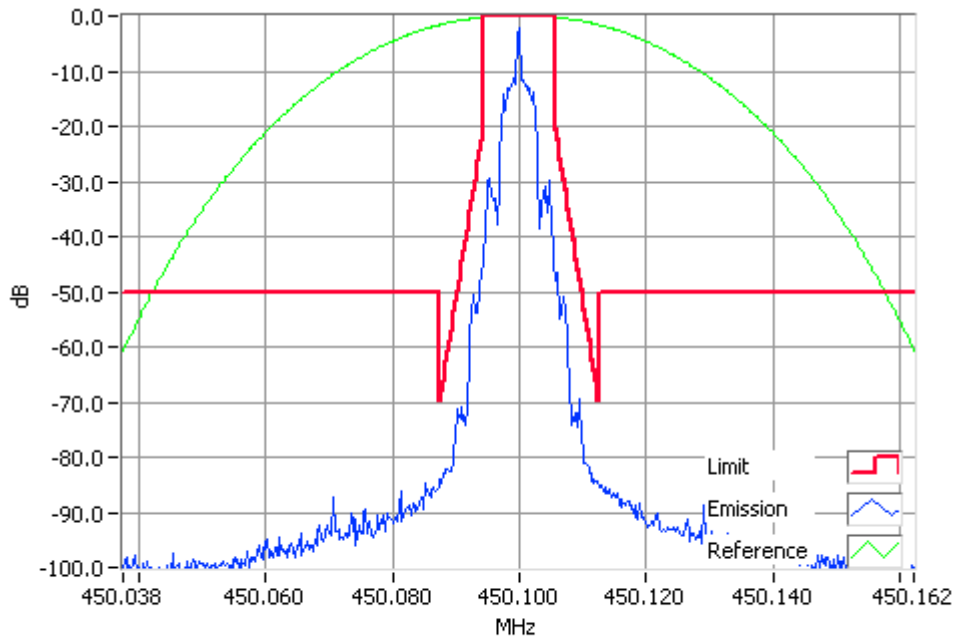

FFSK 2400 bps 450.1000MHz Mask D 1W
RBW=100Hz, VBW=1000Hz, Detector Mode=Peak
Result=Pass

Occupied Bandwidth and Spectrum Masks

FFSK – 2400 bps

SPECIFICATION: FCC CFR 2.1049 (c)

RSS-119 5.5

Tx FREQUENCY: 459.9 MHz 4 W 12.5 kHz Channel Spacing

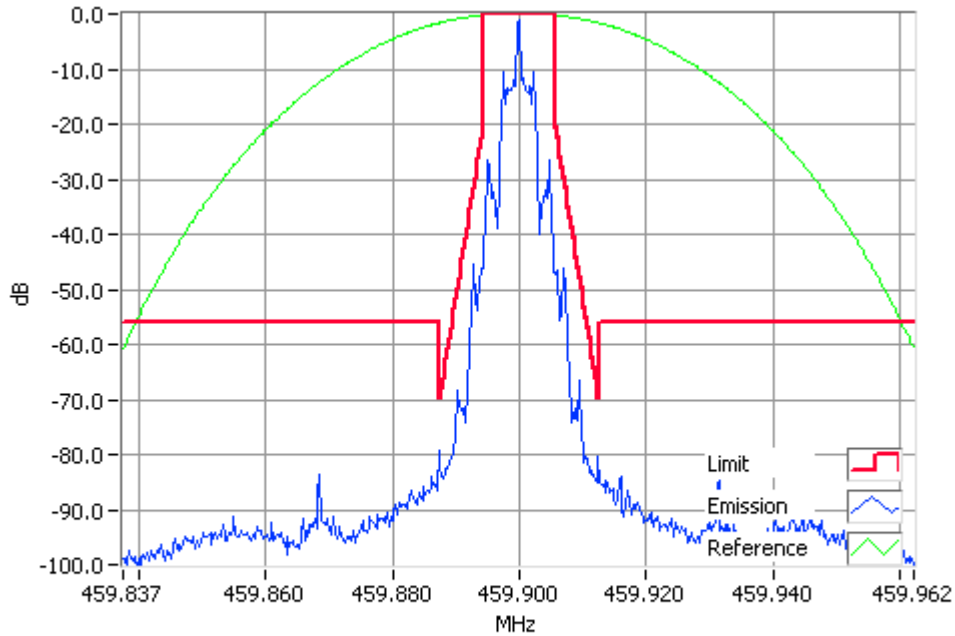

FFSK 2400 bps 459.9000MHz Mask D 4W
RBW=100Hz, VBW=1000Hz, Detector Mode=Peak
Result=Pass

Tx FREQUENCY: 459.9 MHz 1 W 12.5 kHz Channel Spacing

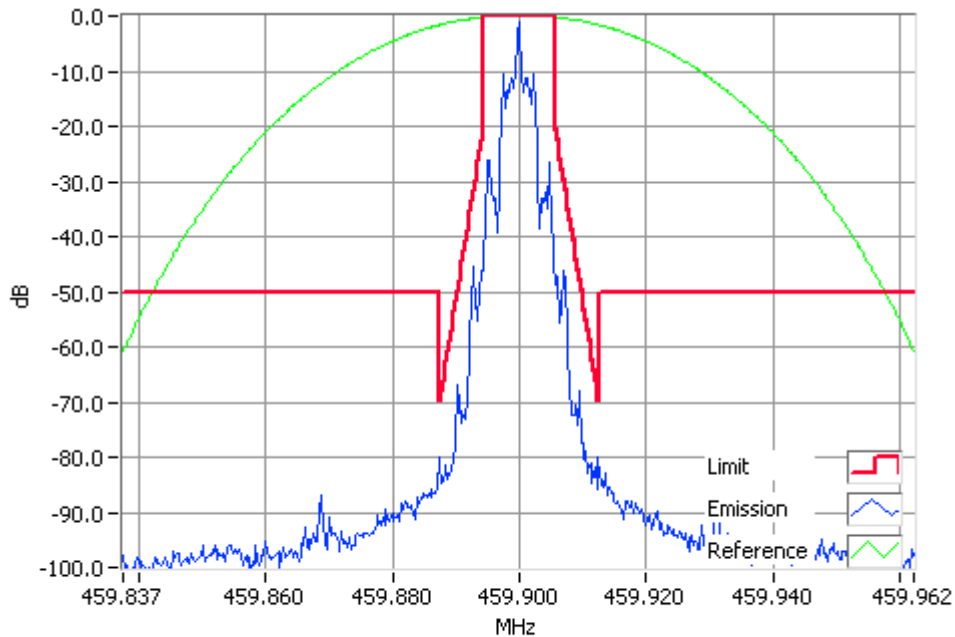

FFSK 2400 bps 459.9000MHz Mask D 1W
RBW=100Hz, VBW=1000Hz, Detector Mode=Peak
Result=Pass

Occupied Bandwidth and Spectrum Masks

FFSK – 2400 bps

SPECIFICATION: FCC CFR 2.1049 (c)

RSS-119 5.5

Tx FREQUENCY: 469.9 MHz 4 W 12.5 kHz Channel Spacing

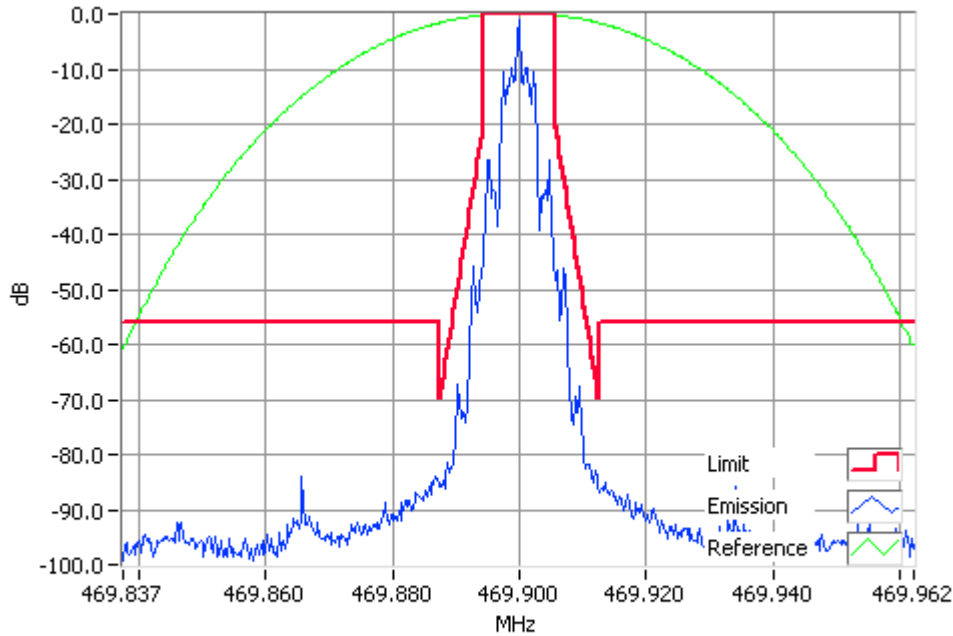

FFSK 2400 bps 469.9000MHz Mask D 4W
RBW=100Hz, VBW=1000Hz, Detector Mode=Peak
Result=Pass

Tx FREQUENCY: 469.9 MHz 1 W 12.5 kHz Channel Spacing

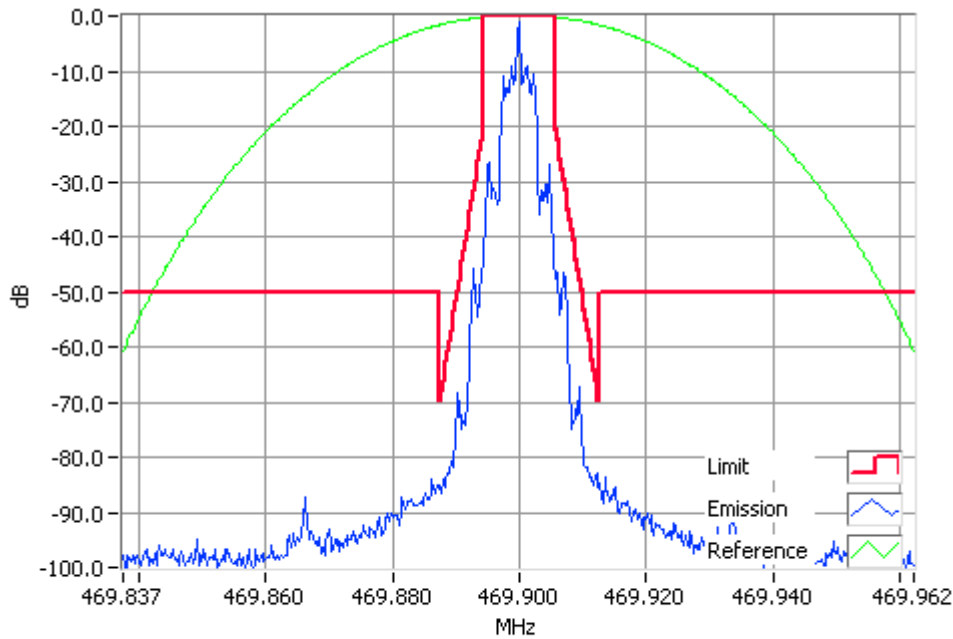

FFSK 2400 bps 469.9000MHz Mask D 1W
RBW=100Hz, VBW=1000Hz, Detector Mode=Peak
Result=Pass

Occupied Bandwidth and Spectrum Masks

FFSK – 2400 bps

SPECIFICATION: FCC CFR 2.1049 (c)

RSS-119 5.5

Tx FREQUENCY: 511.9 MHz 4 W 12.5 kHz Channel Spacing

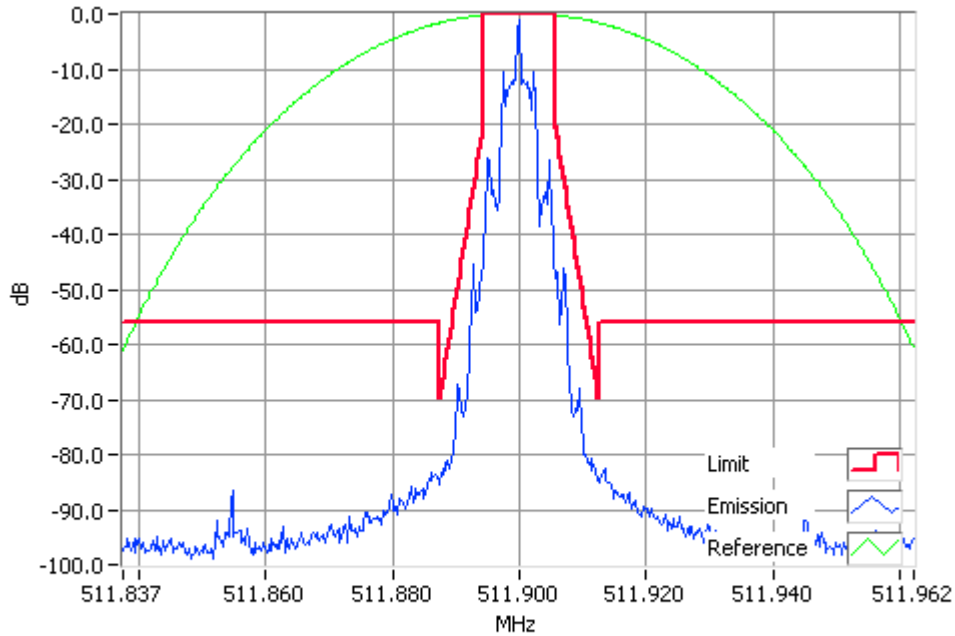

FFSK 2400 bps 511.9000MHz Mask D 4W
RBW=100Hz, VBW=1000Hz, Detector Mode=Peak
Result=Pass

Tx FREQUENCY: 511.9 MHz 1 W 12.5 kHz Channel Spacing

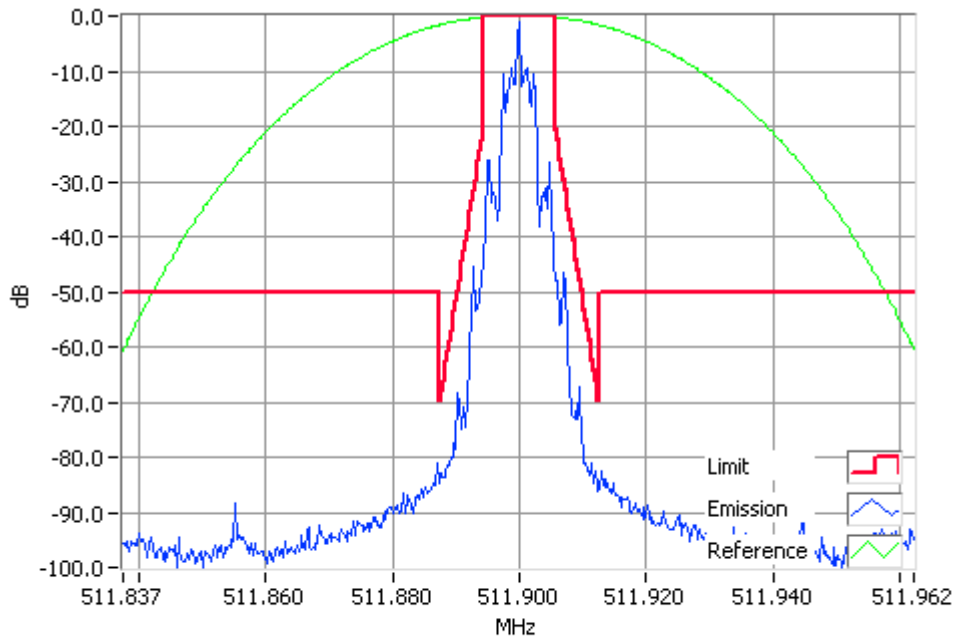

FFSK 2400 bps 511.9000MHz Mask D 1W
RBW=100Hz, VBW=1000Hz, Detector Mode=Peak
Result=Pass

Occupied Bandwidth and Spectrum Masks

FFSK – 2400 bps

SPECIFICATION: FCC CFR 2.1049 (c)

RSS-119 5.5

Tx FREQUENCY: 450.1 MHz 4 W 25.0 kHz Channel Spacing

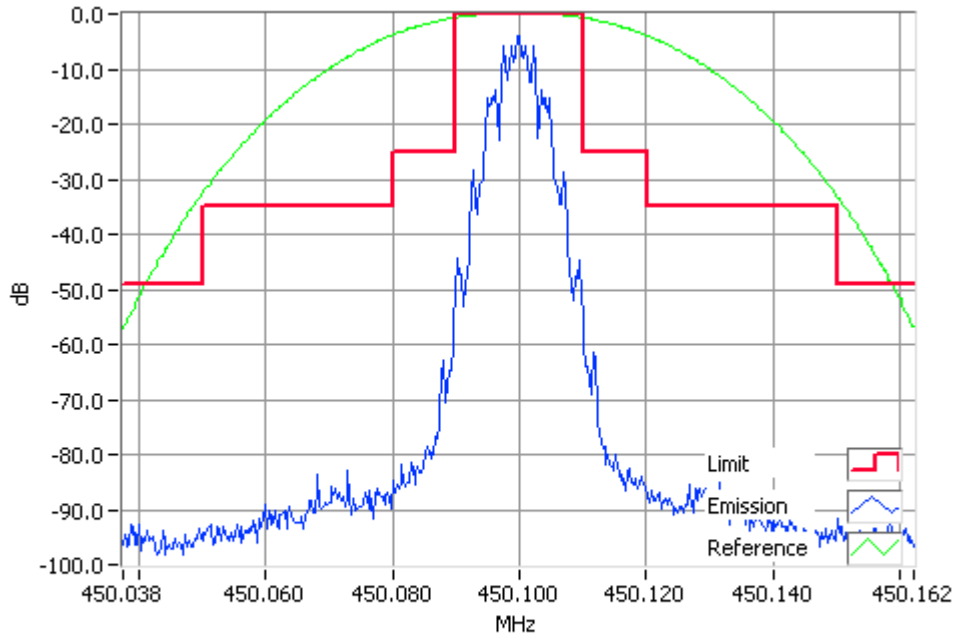

FFSK 2400 bps 450.1000MHz Mask B 4W
RBW=300Hz, VBW=3000Hz, Detector Mode=Peak
Result=Pass

Tx FREQUENCY: 450.1 MHz 1 W 25.0 kHz Channel Spacing

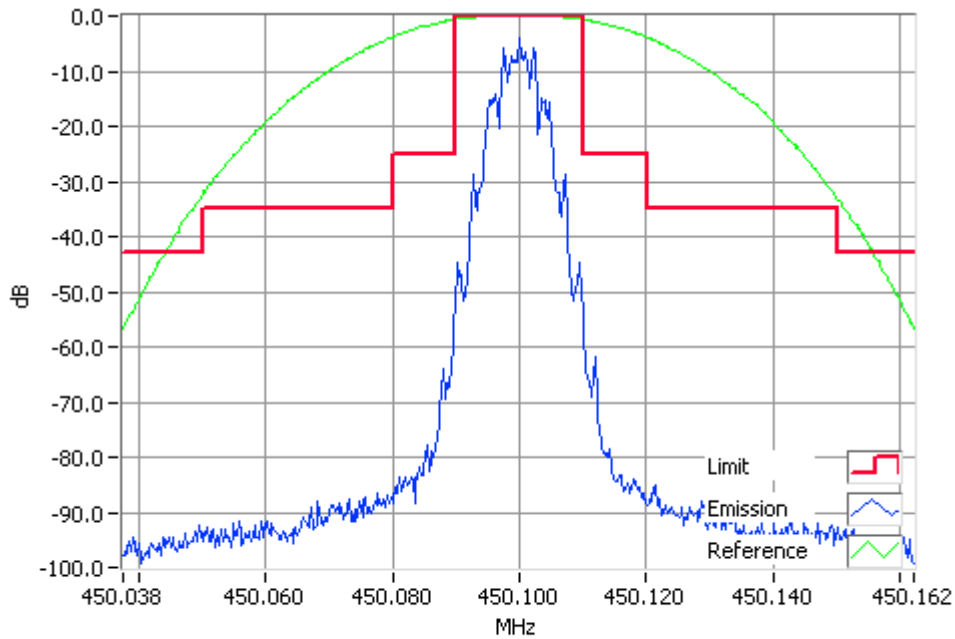

FFSK 2400 bps 450.1000MHz Mask B 1W
RBW=300Hz, VBW=3000Hz, Detector Mode=Peak
Result=Pass

Occupied Bandwidth and Spectrum Masks

FFSK – 2400 bps

SPECIFICATION: FCC CFR 2.1049 (c)

RSS-119 5.5

Tx FREQUENCY: 459.9 MHz 4 W 25.0 kHz Channel Spacing

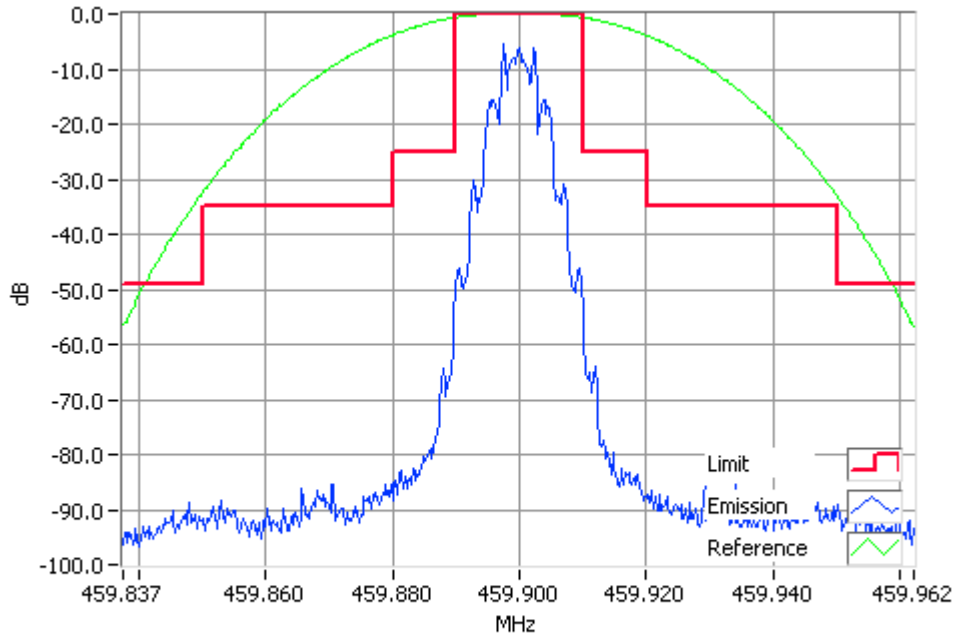

FFSK 2400 bps 459.9000MHz Mask B 4W
RBW=300Hz, VBW=3000Hz, Detector Mode=Peak
Result=Pass

Tx FREQUENCY: 459.9 MHz 1 W 25.0 kHz Channel Spacing

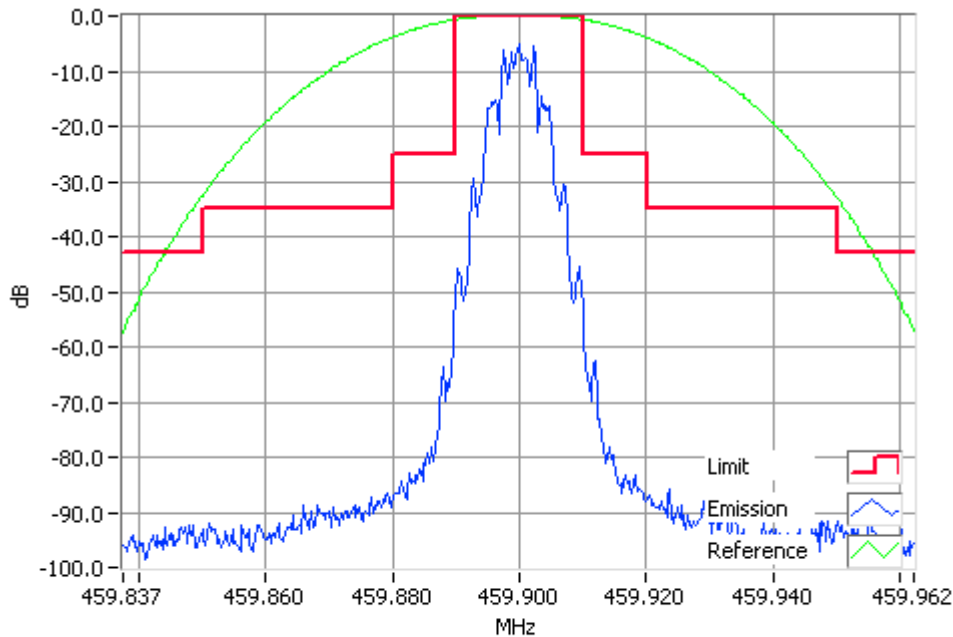

FFSK 2400 bps 459.9000MHz Mask B 1W
RBW=300Hz, VBW=3000Hz, Detector Mode=Peak
Result=Pass

Occupied Bandwidth and Spectrum Masks

FFSK – 2400 bps

SPECIFICATION: FCC CFR 2.1049 (c)

RSS-119 5.5

Tx FREQUENCY: 469.9 MHz 4 W 25.0 kHz Channel Spacing

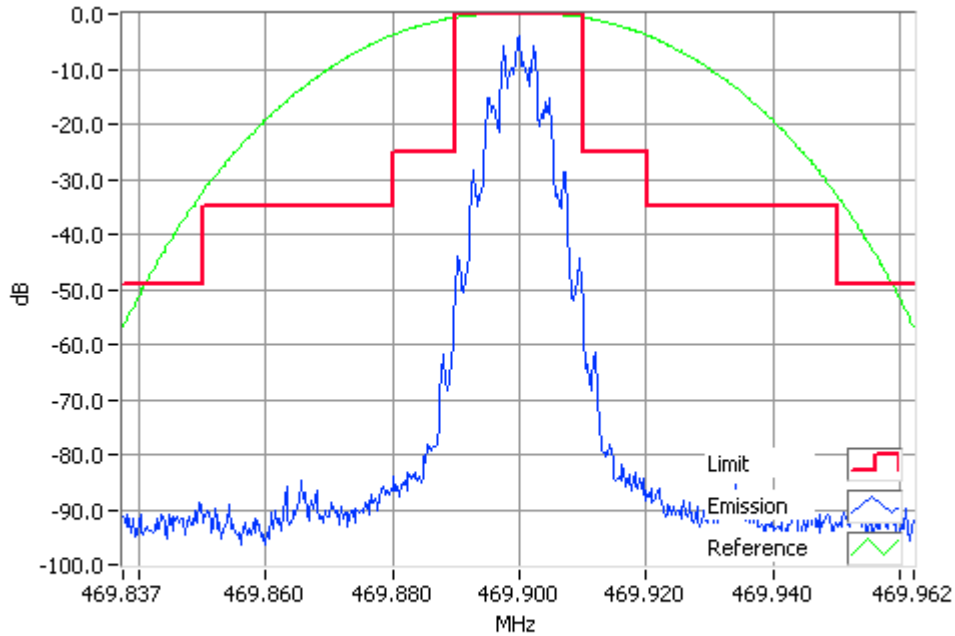

FFSK 2400 bps 469.9000MHz Mask B 4W
RBW=300Hz, VBW=3000Hz, Detector Mode=Peak
Result=Pass

Tx FREQUENCY: 469.9 MHz 1 W 25.0 kHz Channel Spacing

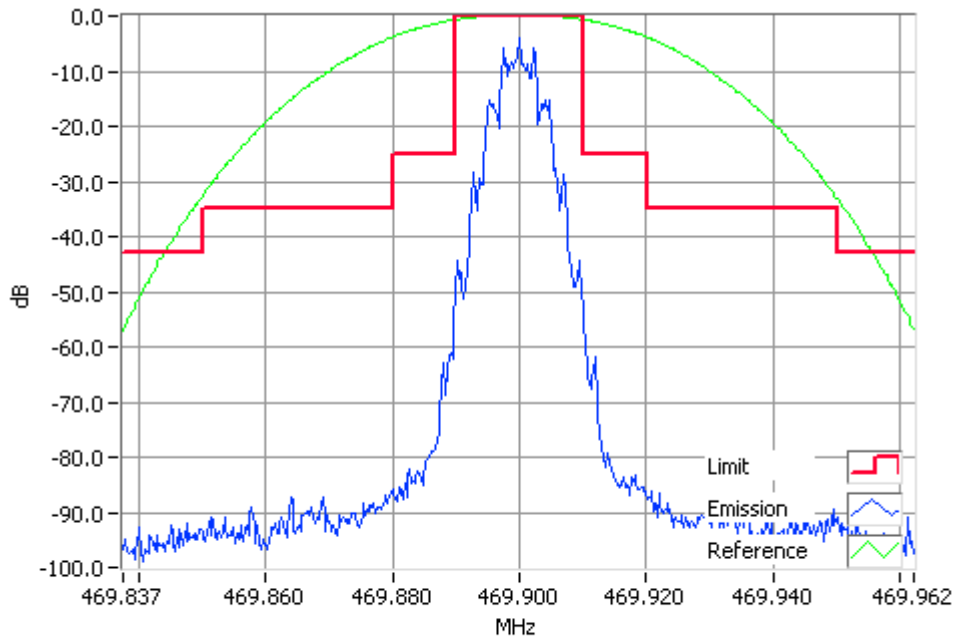

FFSK 2400 bps 469.9000MHz Mask B 1W
RBW=300Hz, VBW=3000Hz, Detector Mode=Peak
Result=Pass

Occupied Bandwidth and Spectrum Masks

FFSK – 2400 bps

SPECIFICATION: FCC CFR 2.1049 (c)

RSS-119 5.5

Tx FREQUENCY: 511.9 MHz 4 W 25.0 kHz Channel Spacing

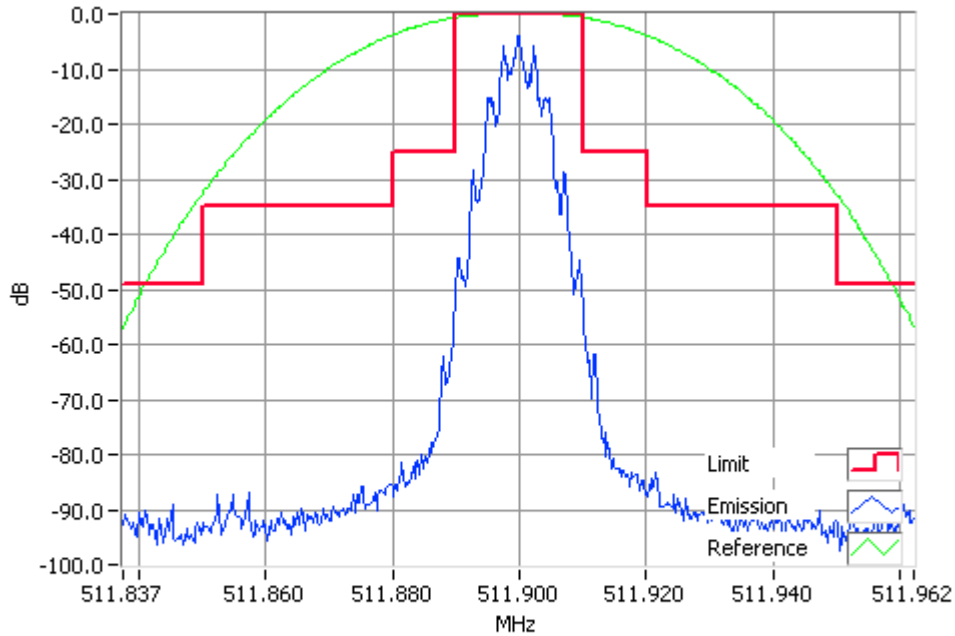

FFSK 2400 bps 511.9000MHz Mask B 4W
RBW=300Hz, VBW=3000Hz, Detector Mode=Peak
Result=Pass

Tx FREQUENCY: 511.9 MHz 1 W 25.0 kHz Channel Spacing

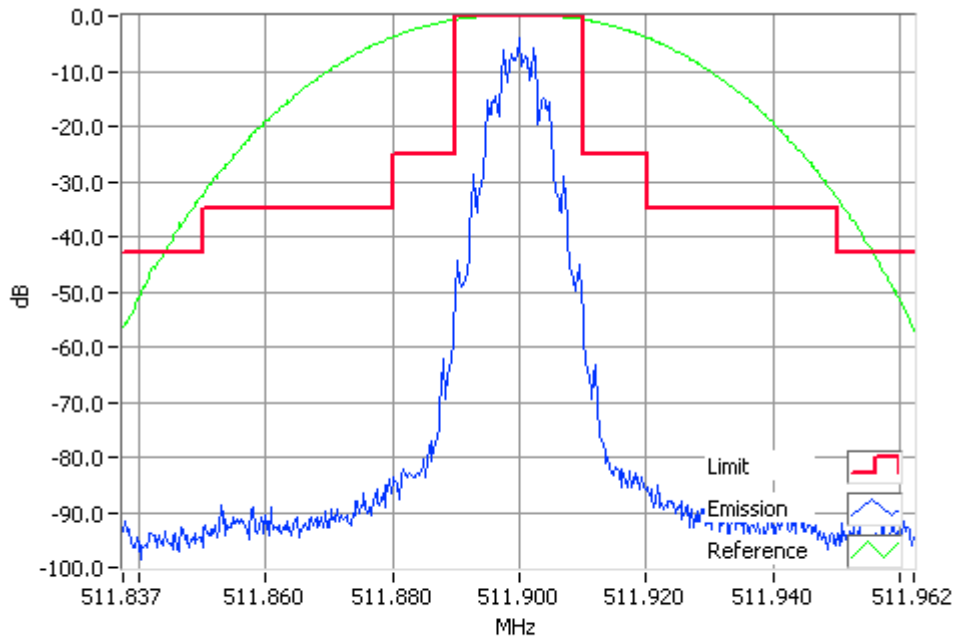

FFSK 2400 bps 511.9000MHz Mask B 1W
RBW=300Hz, VBW=3000Hz, Detector Mode=Peak
Result=Pass

Occupied Bandwidth and Spectrum Masks

DMR

SPECIFICATION: FCC CFR 2.1049 (c)

RSS-119 5.5

Tx FREQUENCY: 450.1 MHz 4 W 12.5 kHz Channel Spacing

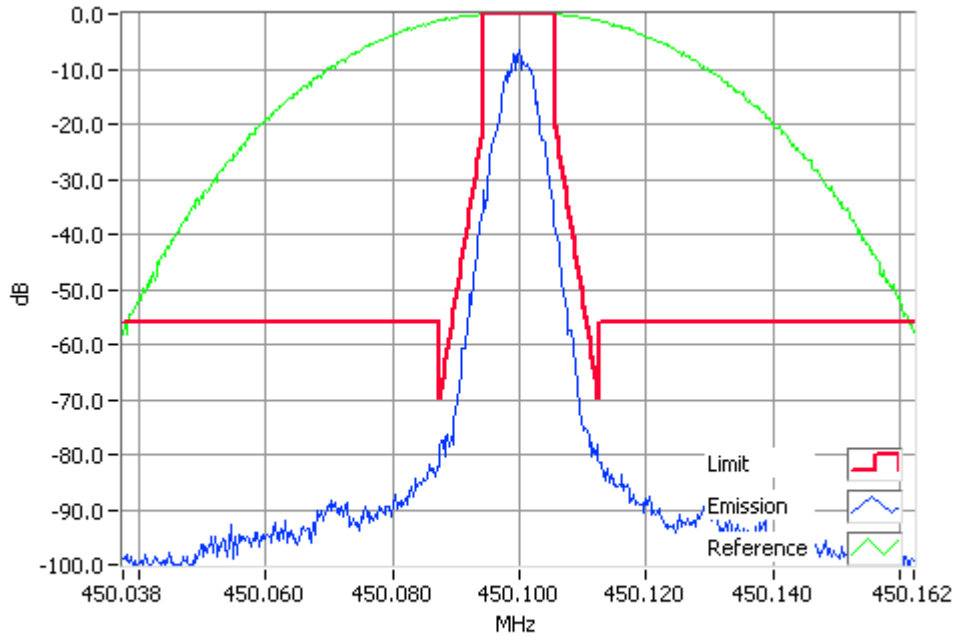

DMR 450.1000MHz Mask D 4W
RBW=100Hz, VBW=1000Hz, Detector Mode=Peak
Result=Pass

Tx FREQUENCY: 450.1 MHz 1 W 12.5 kHz Channel Spacing

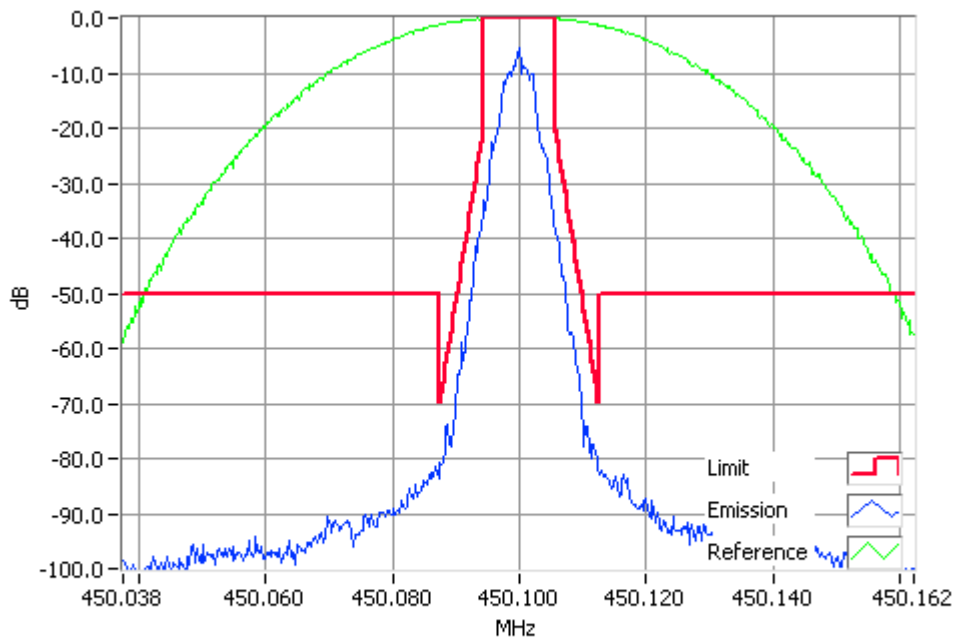

DMR 450.1000MHz Mask D 1W
RBW=100Hz, VBW=1000Hz, Detector Mode=Peak
Result=Pass

Occupied Bandwidth and Spectrum Masks

DMR

SPECIFICATION: FCC CFR 2.1049 (c)

RSS-119 5.5

Tx FREQUENCY: 459.9 MHz 4 W 12.5 kHz Channel Spacing

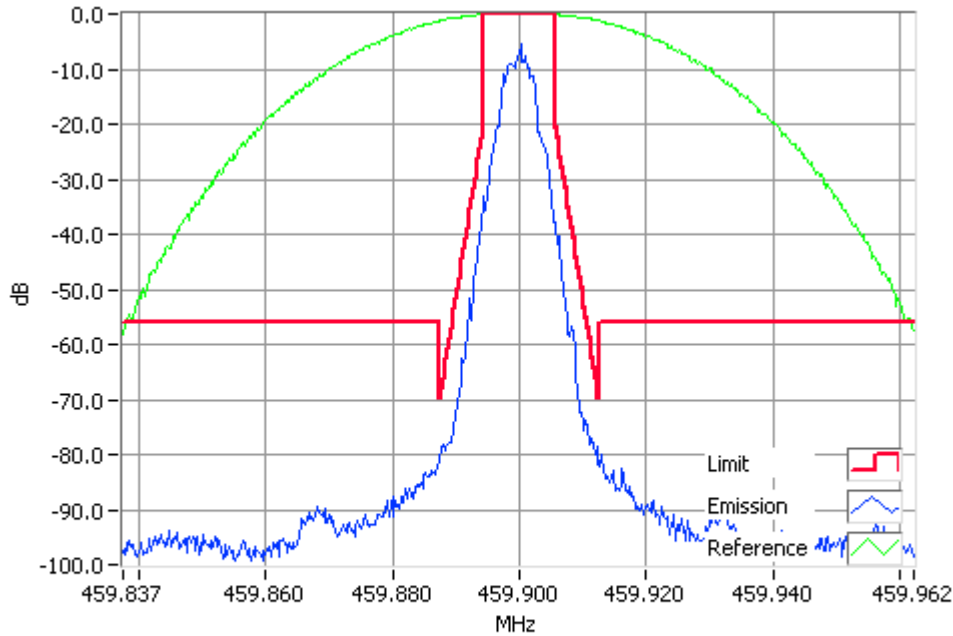

DMR 459.9000MHz Mask D 4W
RBW=100Hz, VBW=1000Hz, Detector Mode=Peak
Result=Pass

Tx FREQUENCY: 459.9 MHz 1 W 12.5 kHz Channel Spacing

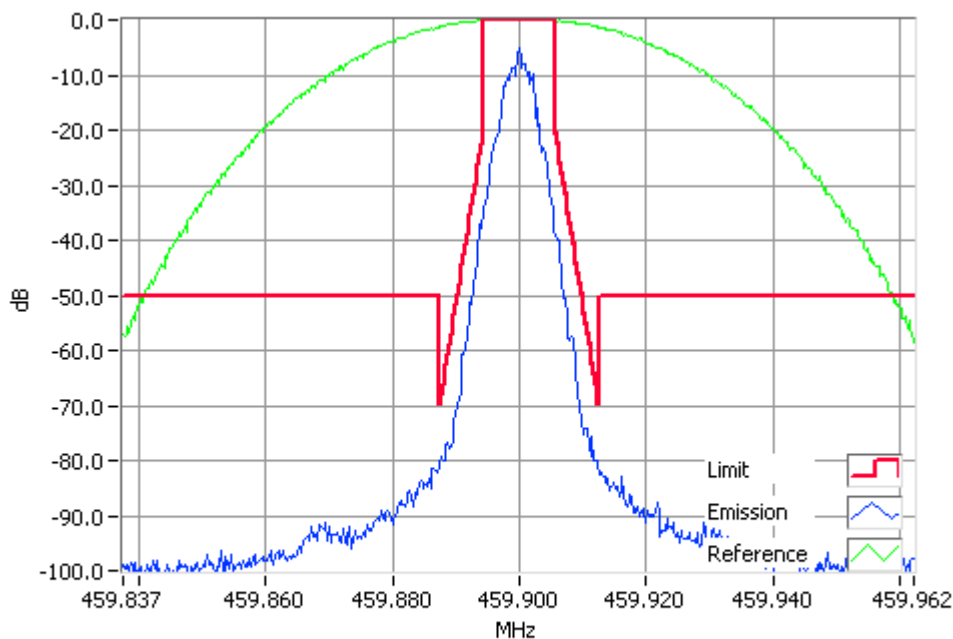

DMR 459.9000MHz Mask D 1W
RBW=100Hz, VBW=1000Hz, Detector Mode=Peak
Result=Pass

Occupied Bandwidth and Spectrum Masks

DMR

SPECIFICATION: FCC CFR 2.1049 (c)

RSS-119 5.5

Tx FREQUENCY: 469.9 MHz 4 W

12.5 kHz Channel Spacing

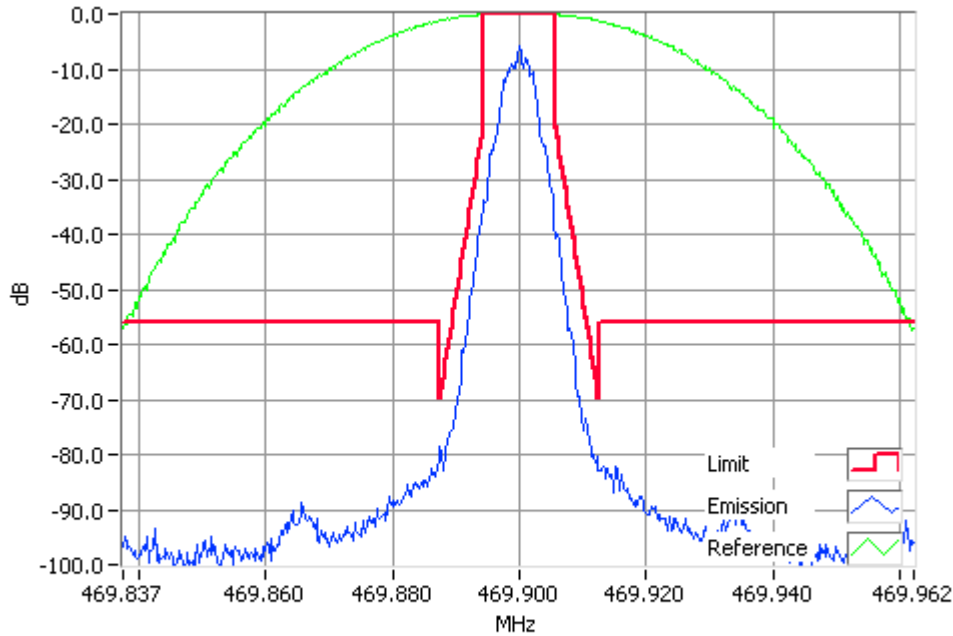

DMR 469.9000MHz Mask D 4W
RBW=100Hz, VBW=1000Hz, Detector Mode=Peak
Result=Pass

Tx FREQUENCY: 469.9 MHz 1 W

12.5 kHz Channel Spacing

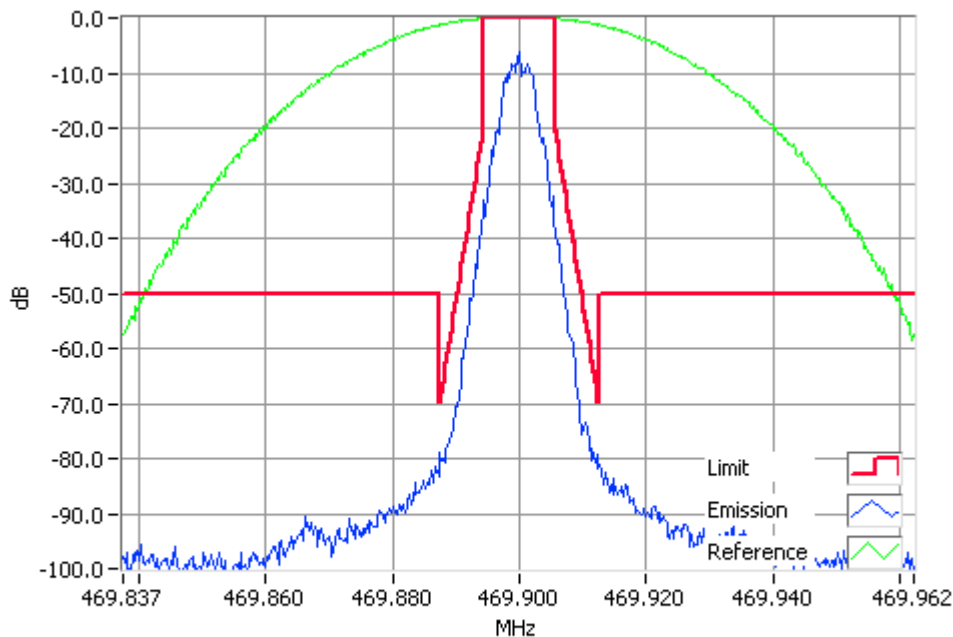

DMR 469.9000MHz Mask D 1W
RBW=100Hz, VBW=1000Hz, Detector Mode=Peak
Result=Pass

Occupied Bandwidth and Spectrum Masks

DMR

SPECIFICATION: FCC CFR 2.1049 (c)

RSS-119 5.5

Tx FREQUENCY: 511.9 MHz 4 W

12.5 kHz Channel Spacing

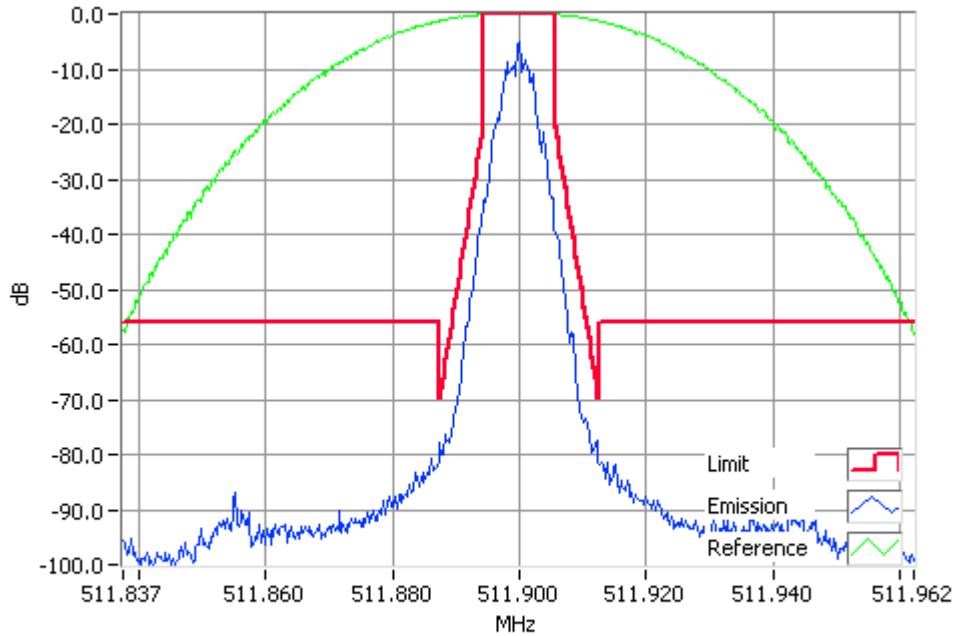

DMR 511.9000MHz Mask D 4W
RBW=100Hz, VBW=1000Hz, Detector Mode=Peak
Result=Pass

Tx FREQUENCY: 511.9 MHz 1 W

12.5 kHz Channel Spacing

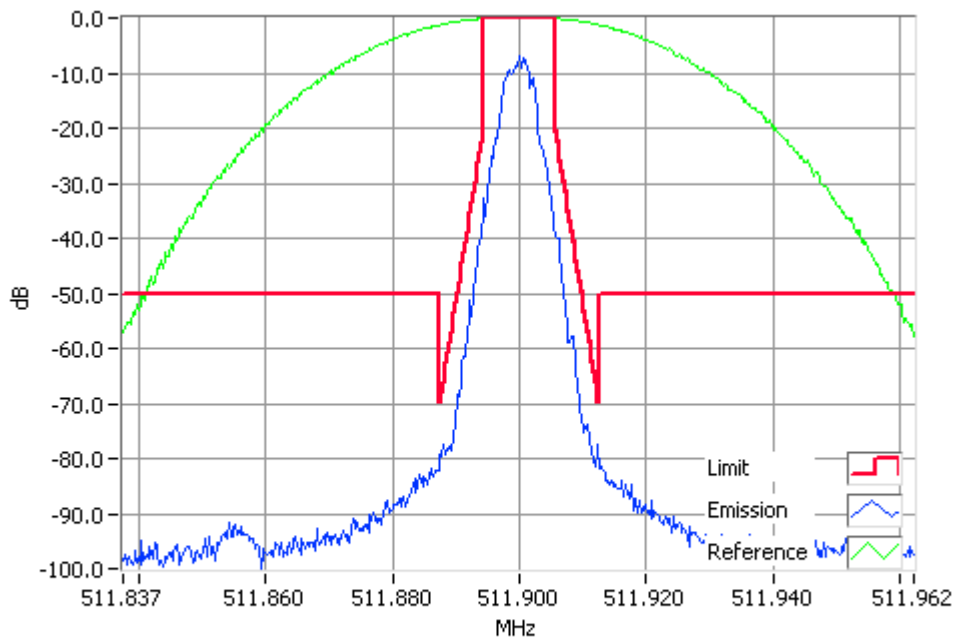

DMR 511.9000MHz Mask D 1W
RBW=100Hz, VBW=1000Hz, Detector Mode=Peak
Result=Pass

Occupied Bandwidth and Spectrum Masks

P25 Phase-1

SPECIFICATION: FCC CFR 2.1049 (c)

RSS-119 5.5

Tx FREQUENCY: 450.1 MHz 4 W 12.5 kHz Channel Spacing

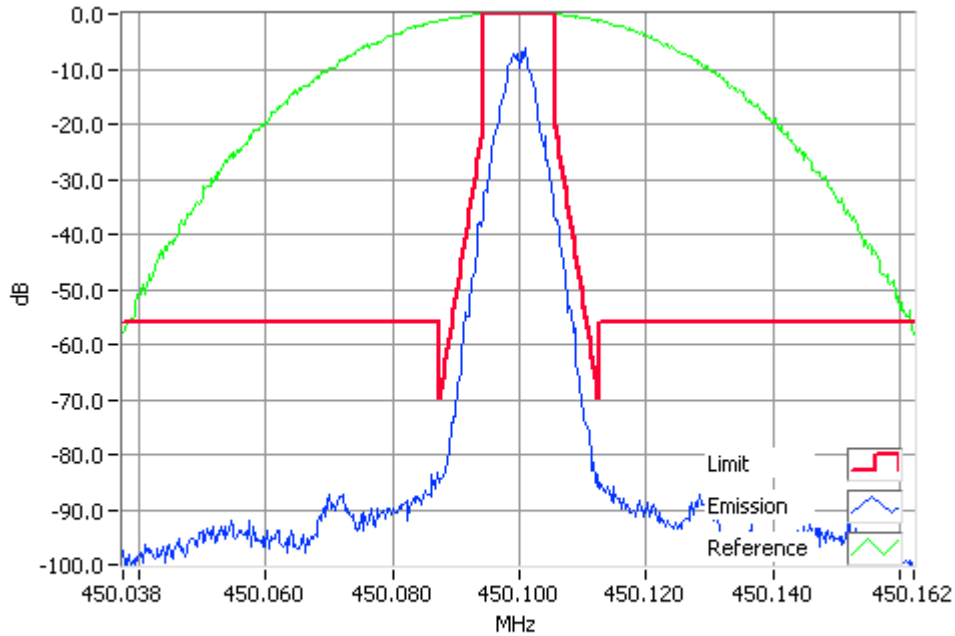

P25 Phase 1 450.1000MHz Mask D 4W
RBW=100Hz, VBW=1000Hz, Detector Mode=Peak
Result=Pass

Tx FREQUENCY: 450.1 MHz 1 W 12.5 kHz Channel Spacing

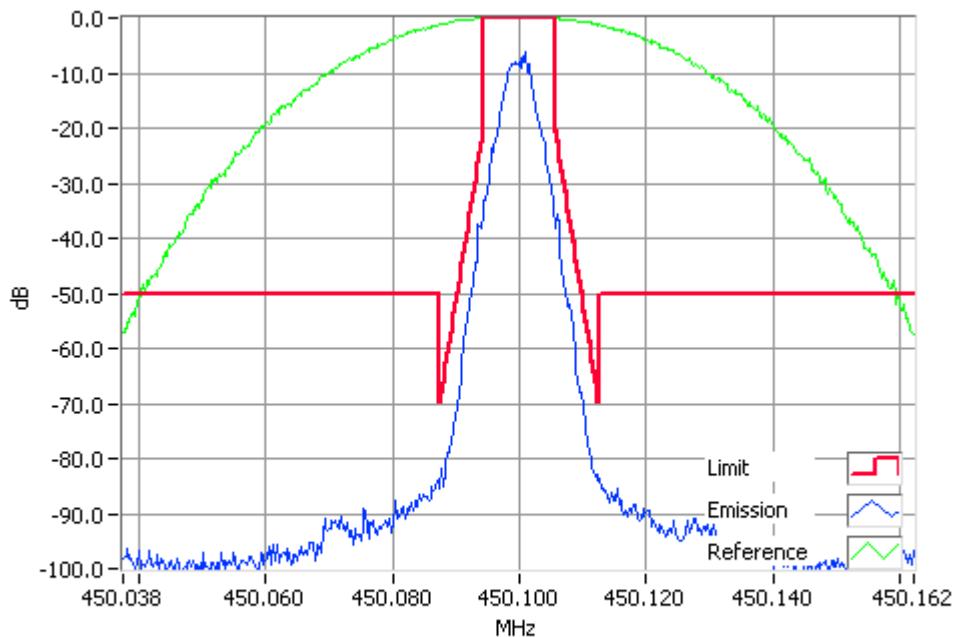

P25 Phase 1 450.1000MHz Mask D 1W
RBW=100Hz, VBW=1000Hz, Detector Mode=Peak
Result=Pass

Occupied Bandwidth and Spectrum Masks

P25 Phase-1

SPECIFICATION: FCC CFR 2.1049 (c)

RSS-119 5.5

Tx FREQUENCY: 459.9 MHz 4 W 12.5 kHz Channel Spacing

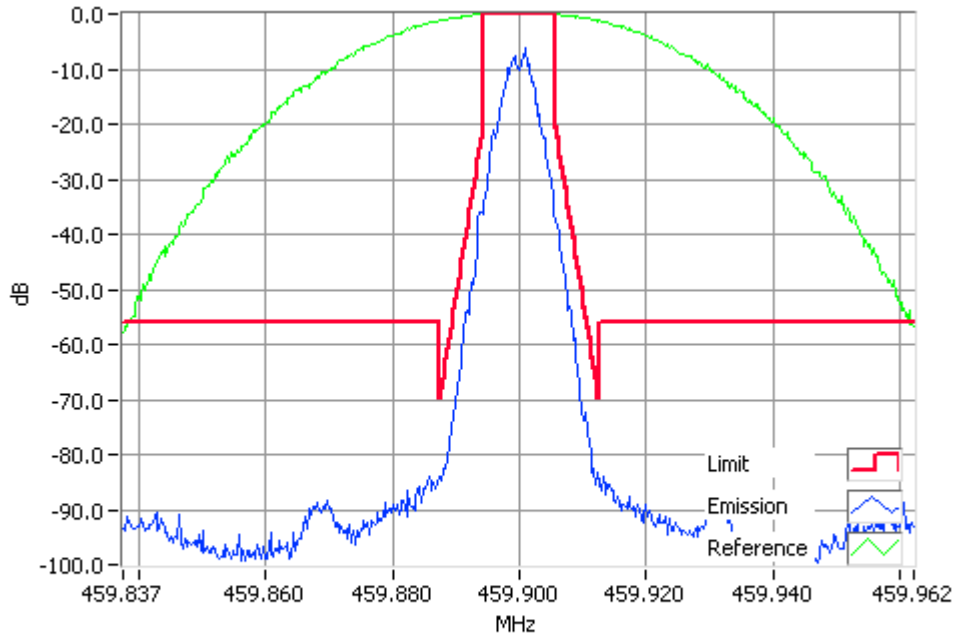

P25 Phase 1 459.9000MHz Mask D 4W
RBW=100Hz, VBW=1000Hz, Detector Mode=Peak
Result=Pass

Tx FREQUENCY: 459.9 MHz 1 W 12.5 kHz Channel Spacing

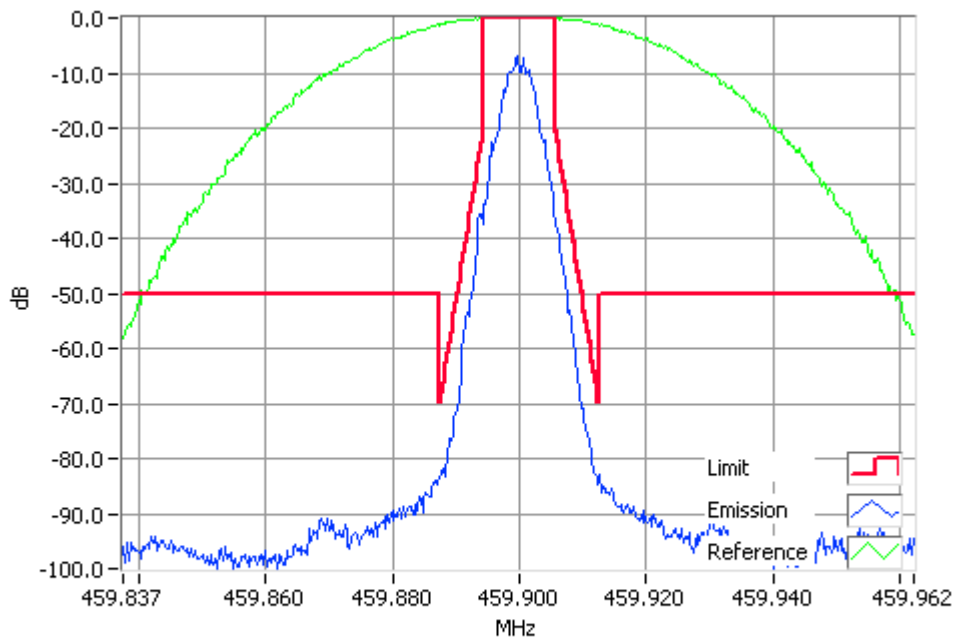

P25 Phase 1 459.9000MHz Mask D 1W
RBW=100Hz, VBW=1000Hz, Detector Mode=Peak
Result=Pass

Occupied Bandwidth and Spectrum Masks

P25 Phase-1

SPECIFICATION: FCC CFR 2.1049 (c)

RSS-119 5.5

Tx FREQUENCY: 469.9 MHz 4 W 12.5 kHz Channel Spacing

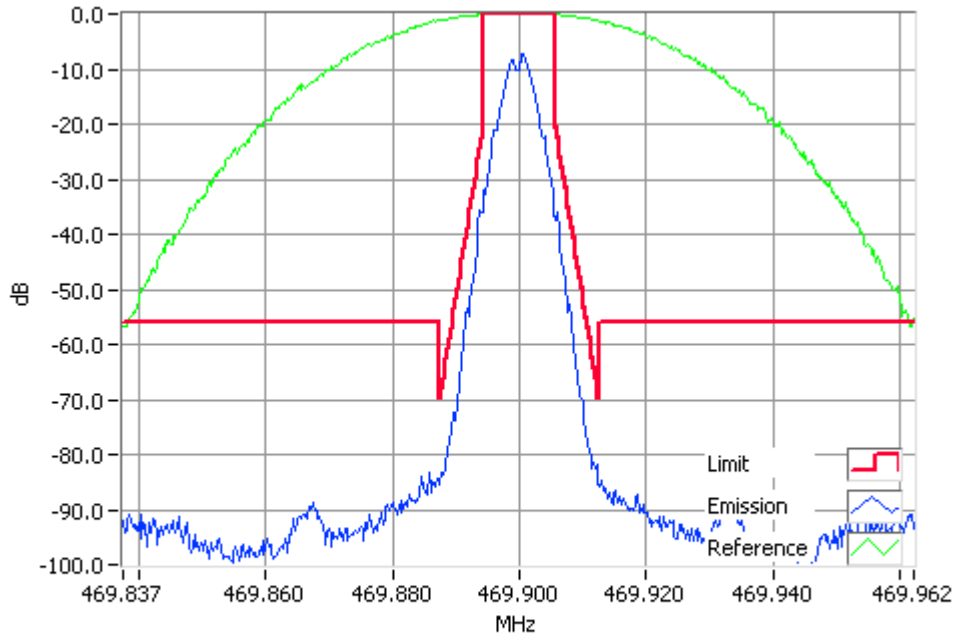

P25 Phase 1 469.9000MHz Mask D 4W
RBW=100Hz, VBW=1000Hz, Detector Mode=Peak
Result=Pass

Tx FREQUENCY: 469.9 MHz 1 W 12.5 kHz Channel Spacing

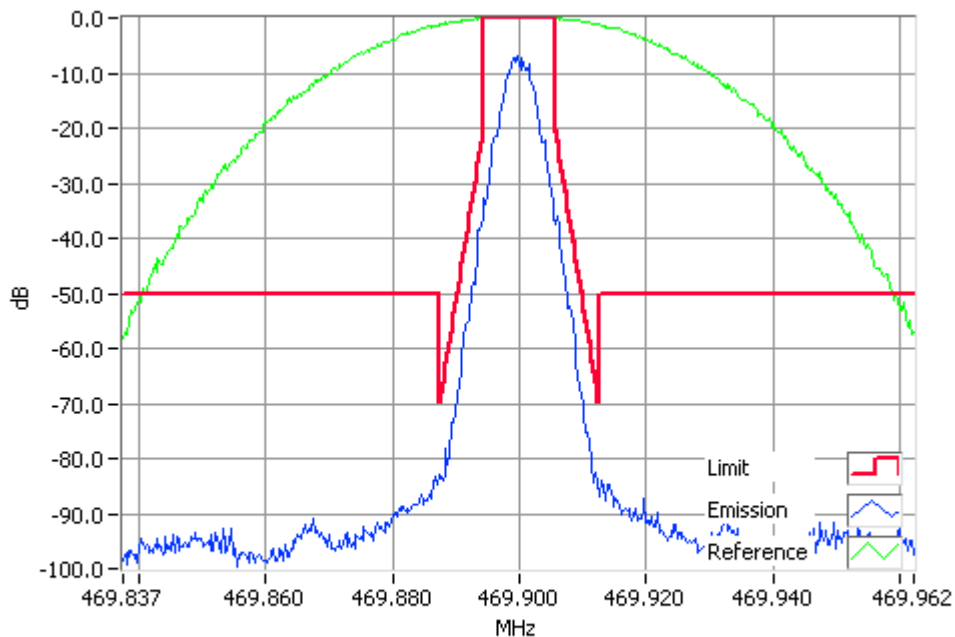

P25 Phase 1 469.9000MHz Mask D 1W
RBW=100Hz, VBW=1000Hz, Detector Mode=Peak
Result=Pass

Occupied Bandwidth and Spectrum Masks

P25 Phase-1

SPECIFICATION: FCC CFR 2.1049 (c)

RSS-119 5.5

Tx FREQUENCY: 511.9 MHz 4 W 12.5 kHz Channel Spacing

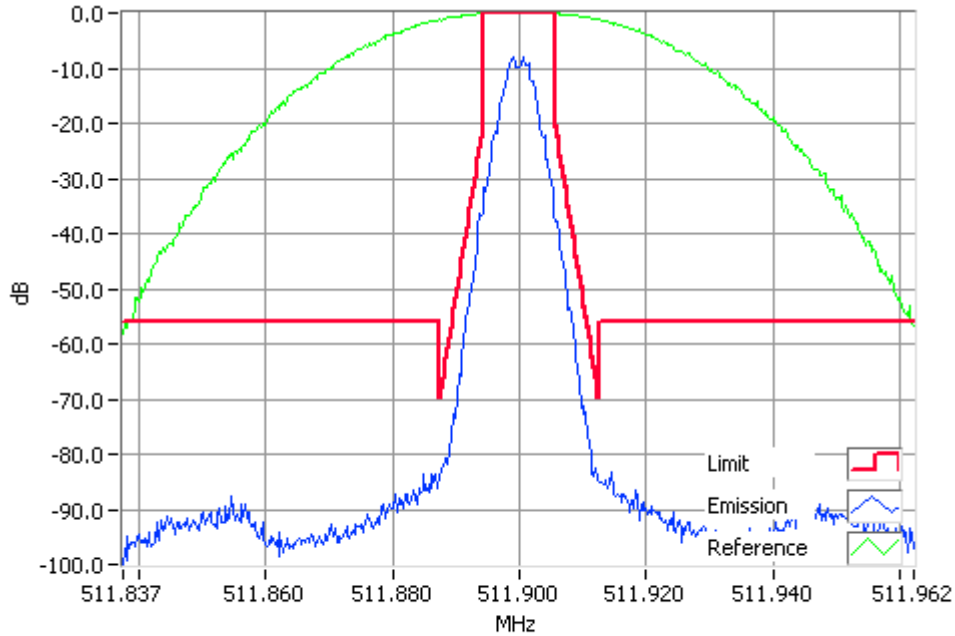

P25 Phase 1 511.9000MHz Mask D 4W
RBW=100Hz, VBW=1000Hz, Detector Mode=Peak
Result=Pass

Tx FREQUENCY: 511.9 MHz 1 W 12.5 kHz Channel Spacing

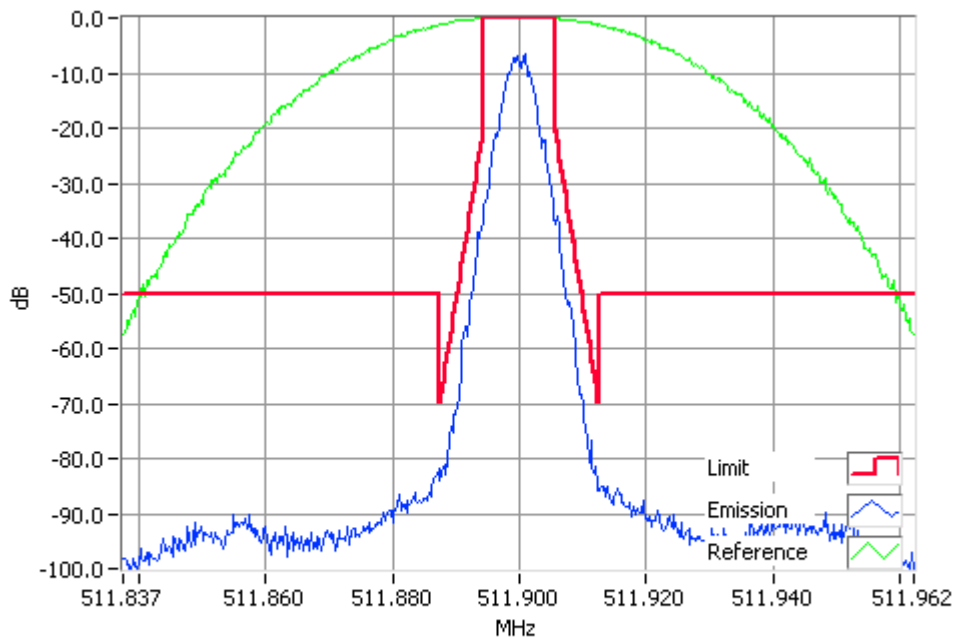

P25 Phase 1 511.9000MHz Mask D 1W
RBW=100Hz, VBW=1000Hz, Detector Mode=Peak
Result=Pass

Occupied Bandwidth and Spectrum Masks

P25 Phase-2

SPECIFICATION: FCC CFR 2.1049 (c)

RSS-119 5.5

Tx FREQUENCY: 450.1 MHz 4 W 12.5 kHz Channel Spacing

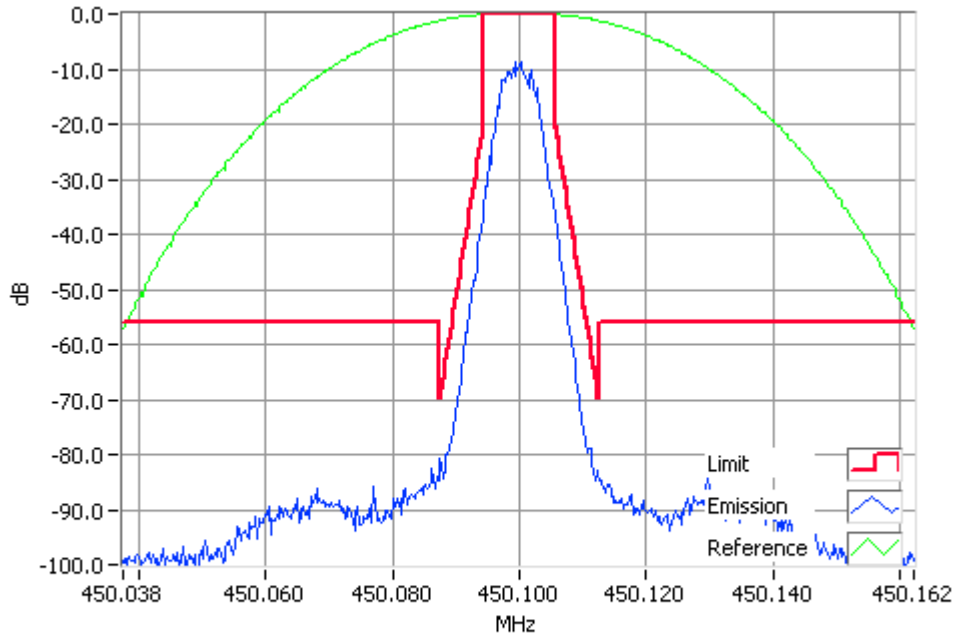

P25 Phase 2 450.1000MHz Mask D 4W
RBW=100Hz, VBW=1000Hz, Detector Mode=Peak
Result=Pass

Tx FREQUENCY: 450.1 MHz 1 W 12.5 kHz Channel Spacing

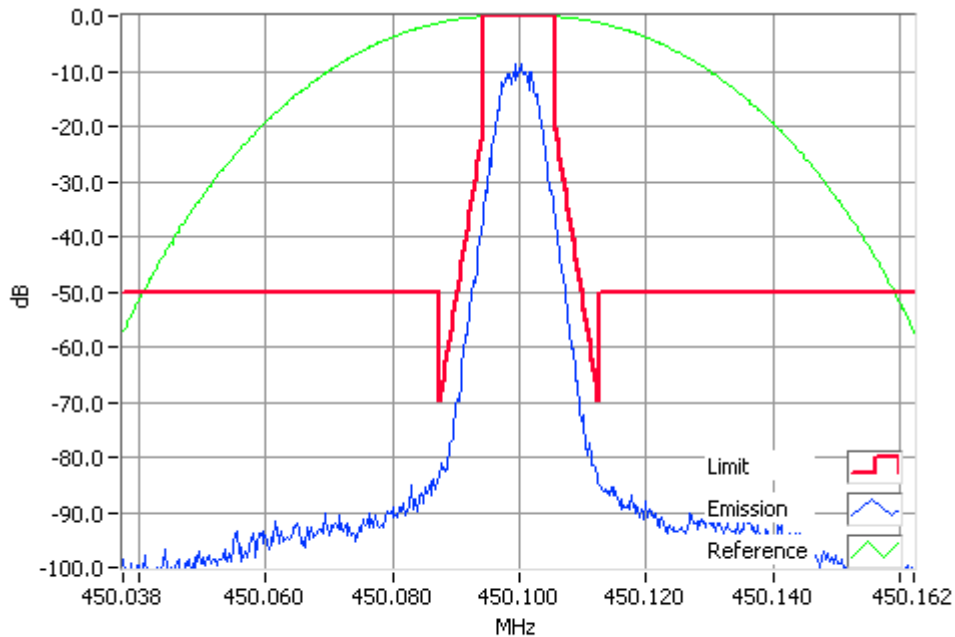

P25 Phase 2 450.1000MHz Mask D 1W
RBW=100Hz, VBW=1000Hz, Detector Mode=Peak
Result=Pass

Occupied Bandwidth and Spectrum Masks

P25 Phase-2

SPECIFICATION: FCC CFR 2.1049 (c)

RSS-119 5.5

Tx FREQUENCY: 459.9 MHz 4 W 12.5 kHz Channel Spacing

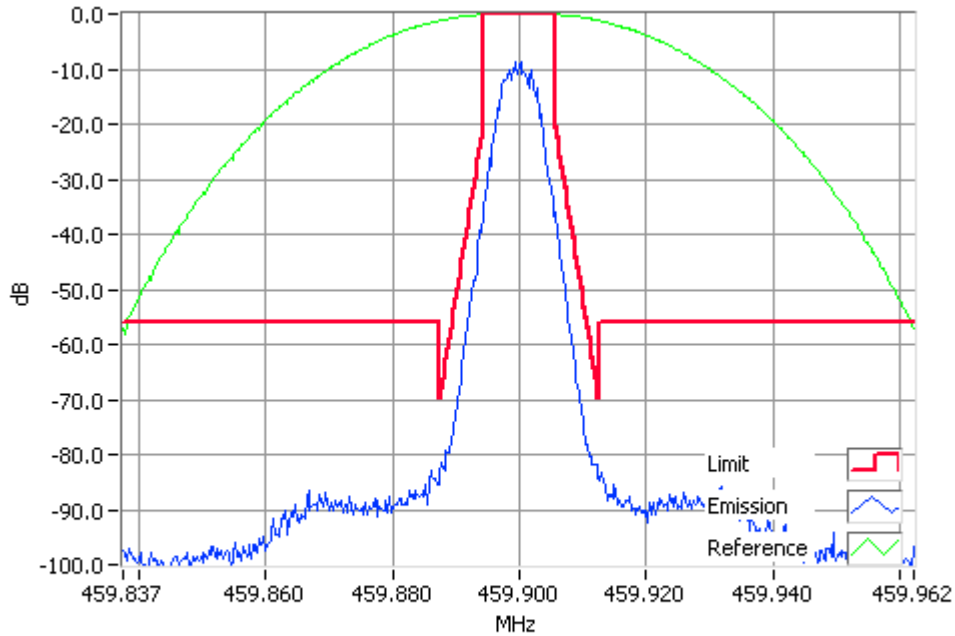

P25 Phase 2 459.9000MHz Mask D 4W
RBW=100Hz, VBW=1000Hz, Detector Mode=Peak
Result=Pass

Tx FREQUENCY: 459.9 MHz 1 W 12.5 kHz Channel Spacing

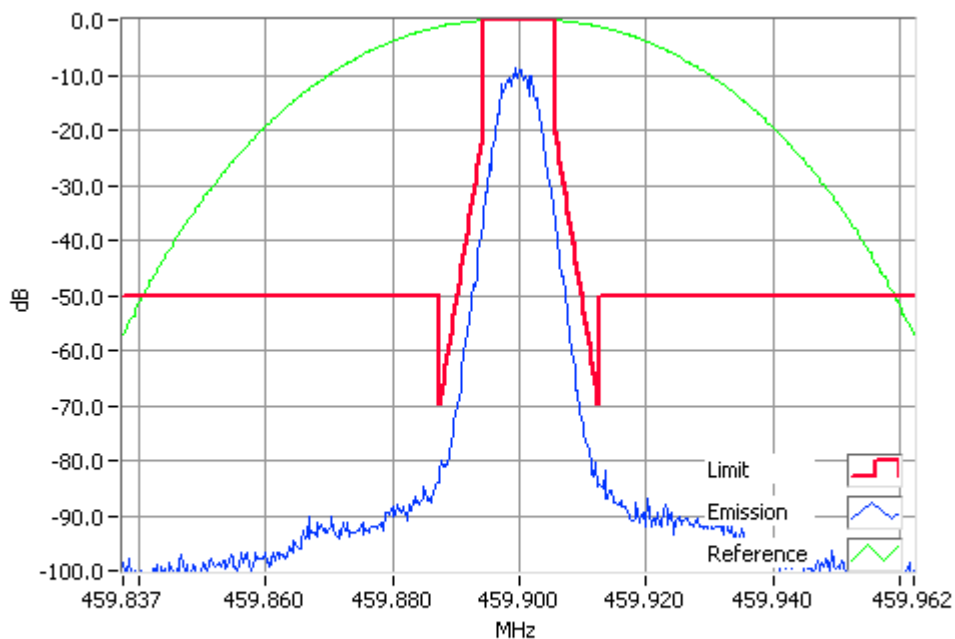

P25 Phase 2 459.9000MHz Mask D 1W
RBW=100Hz, VBW=1000Hz, Detector Mode=Peak
Result=Pass

Occupied Bandwidth and Spectrum Masks

P25 Phase-2

SPECIFICATION: FCC CFR 2.1049 (c)

RSS-119 5.5

Tx FREQUENCY: 469.9 MHz 4 W 12.5 kHz Channel Spacing

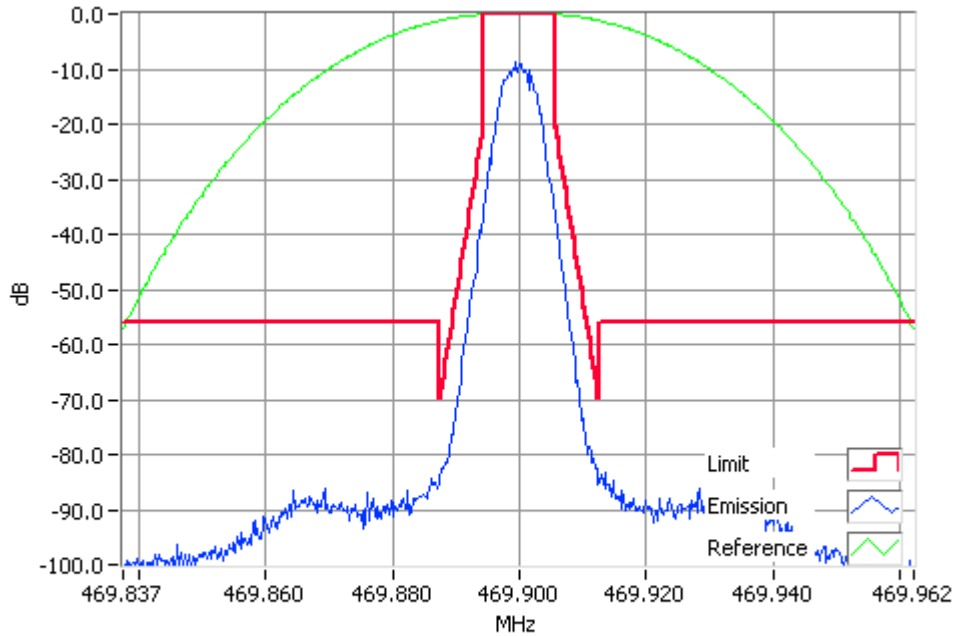

P25 Phase 2 469.9000MHz Mask D 4W
RBW=100Hz, VBW=1000Hz, Detector Mode=Peak
Result=Pass

Tx FREQUENCY: 469.9 MHz 1 W 12.5 kHz Channel Spacing

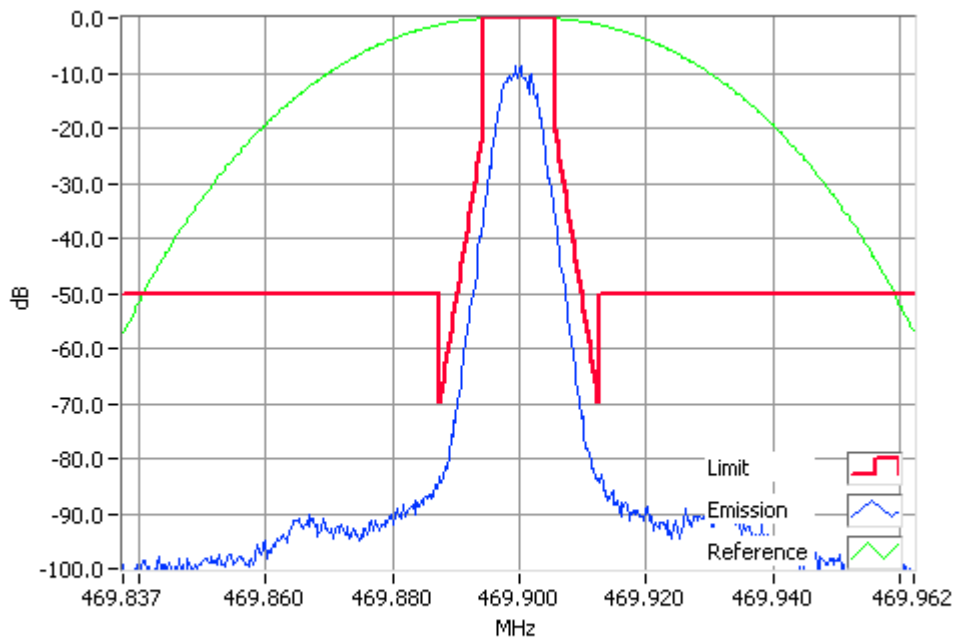

P25 Phase 2 469.9000MHz Mask D 1W
RBW=100Hz, VBW=1000Hz, Detector Mode=Peak
Result=Pass

Occupied Bandwidth and Spectrum Masks

P25 Phase-2

SPECIFICATION: FCC CFR 2.1049 (c)

RSS-119 5.5

Tx FREQUENCY: 511.9 MHz 4 W 12.5 kHz Channel Spacing

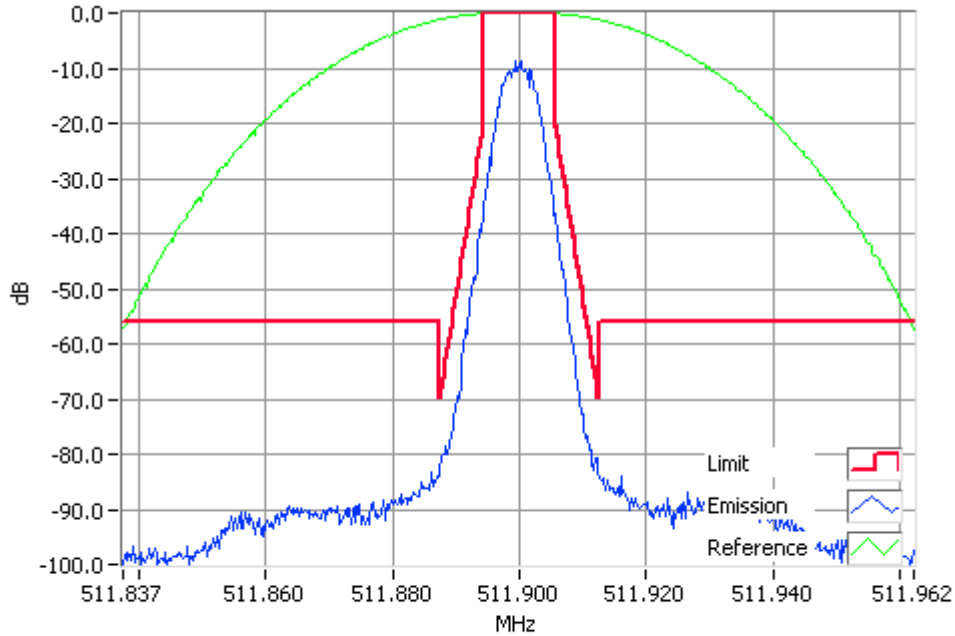

P25 Phase 2 511.9000MHz Mask D 4W
RBW=100Hz, VBW=1000Hz, Detector Mode=Peak
Result=Pass

Tx FREQUENCY: 511.9 MHz 1 W 12.5 kHz Channel Spacing

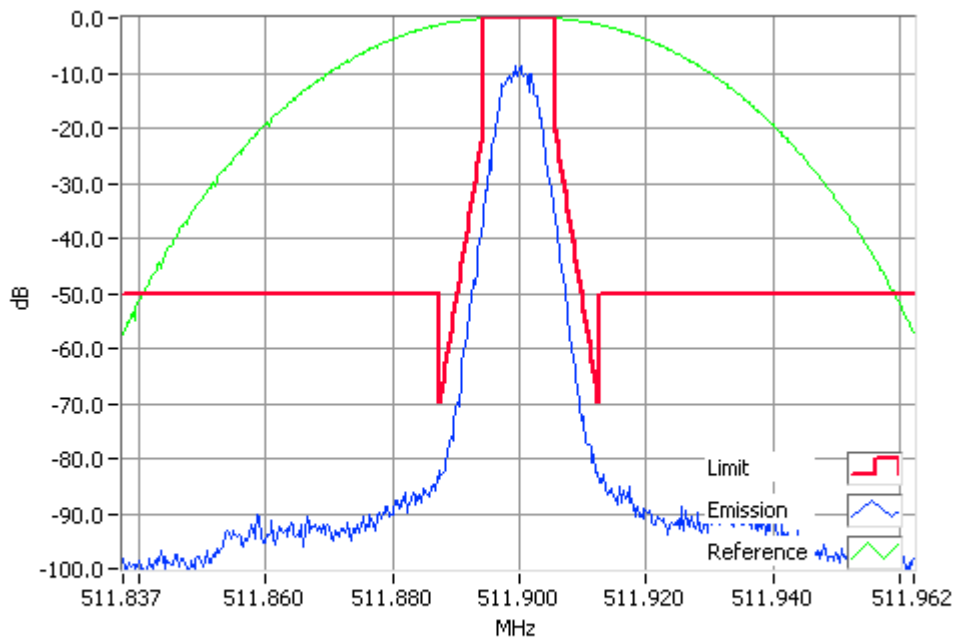

P25 Phase 2 511.9000MHz Mask D 1W
RBW=100Hz, VBW=1000Hz, Detector Mode=Peak
Result=Pass

TRANSMITTER SPURIOUS EMISSIONS (CONDUCTED)

SPECIFICATIONS: FCC 47 CFR 2.1051

RSS-119 5.8

GUIDE: TIA/EIA-603D 2.2.13

MEASUREMENT PROCEDURE:

1. Refer Annex A for equipment set up.
2. The frequency range examined was from the lowest frequency generated within the EUT, to a frequency higher than the 10th Harmonic: 100 kHz to Fc-BW
Fc+ BW to 10Fc GHz
3. A Pre-scan is performed with a resolution bandwidth of 1 kHz, and a video bandwidth of 3 kHz. If any emissions are found to be within 20 dB of the limit a second measurement is made with the carrier modulated, and a resolution bandwidth of 10 kHz, and a video bandwidth of 30 kHz.

Spurious emissions which were attenuated by more than 20 dB below the limit were not recorded.

A photograph of the test set-up is included below.

MEASUREMENT RESULTS:

See the tables and plots on the following pages for 12.5 kHz & 25.0 kHz channel spacings.

LIMIT CLAUSES: FCC 47 CFR 90.210

RSS-119 5.8

Photo: Conducted Emissions Test Setup



Spurious Emissions (Tx Conducted)

12.5 kHz Channel Spacing

450.1 MHz @ 4 W

Emission Mask D

Emission Frequency (MHz)	Level (dBm)	Level (dBc)
~	~	~

12.5 kHz Channel Spacing

450.1 MHz @ 1 W

Emission Mask D

Emission Frequency (MHz)	Level (dBm)	Level (dBc)
~	~	~
No emissions were detected at a level greater than 20 dB below the limit.		

450.1 MHz @ 4 W

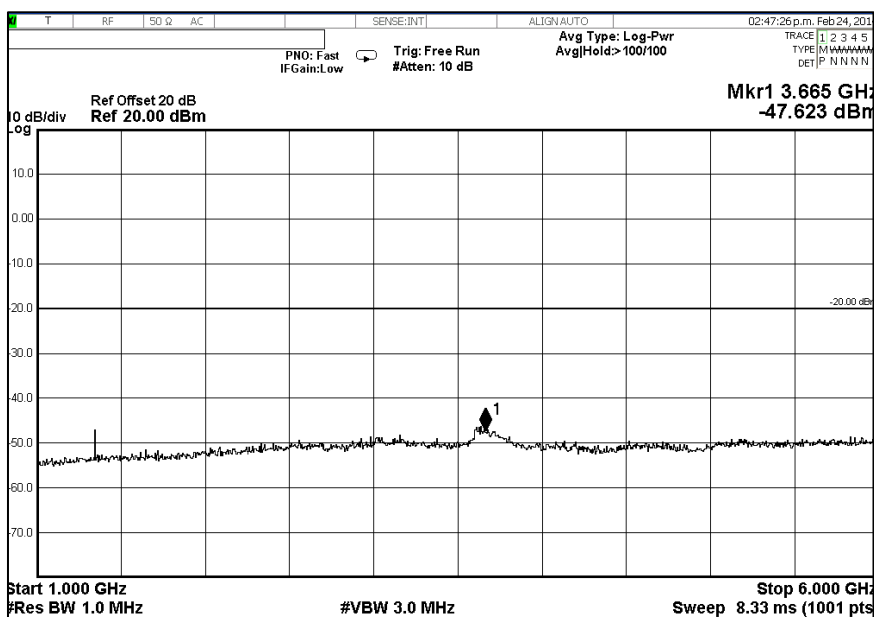

Spurious Emissions (Tx Conducted)

12.5 kHz Channel Spacing

459.9 MHz @ 4 W

Emission Mask D

Emission Frequency (MHz)	Level (dBm)	Level (dBc)
~	~	~

12.5 kHz Channel Spacing

459.9 MHz @ 1 W

Emission Mask D

Emission Frequency (MHz)	Level (dBm)	Level (dBc)
~	~	~

No emissions were detected at a level greater than 20 dB below the limit.

459.9 MHz @ 4 W

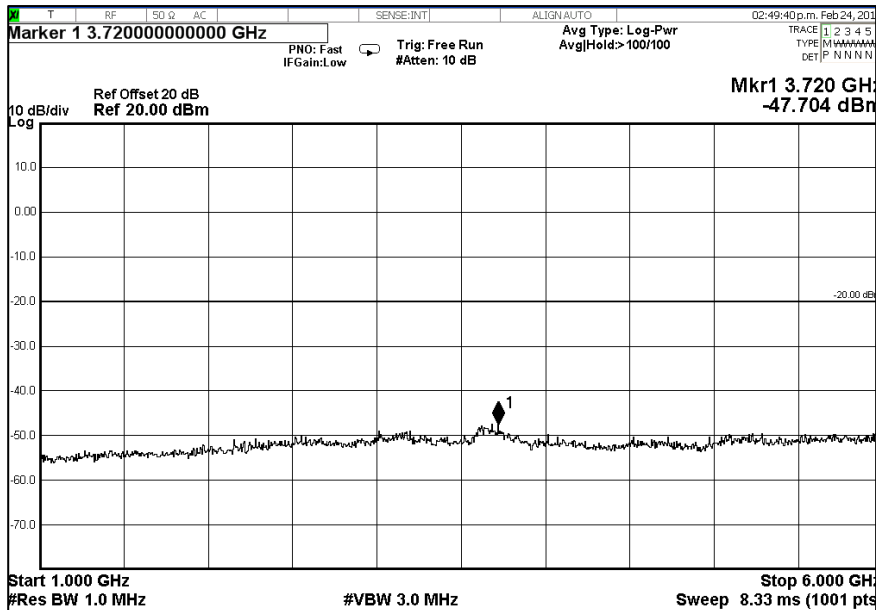
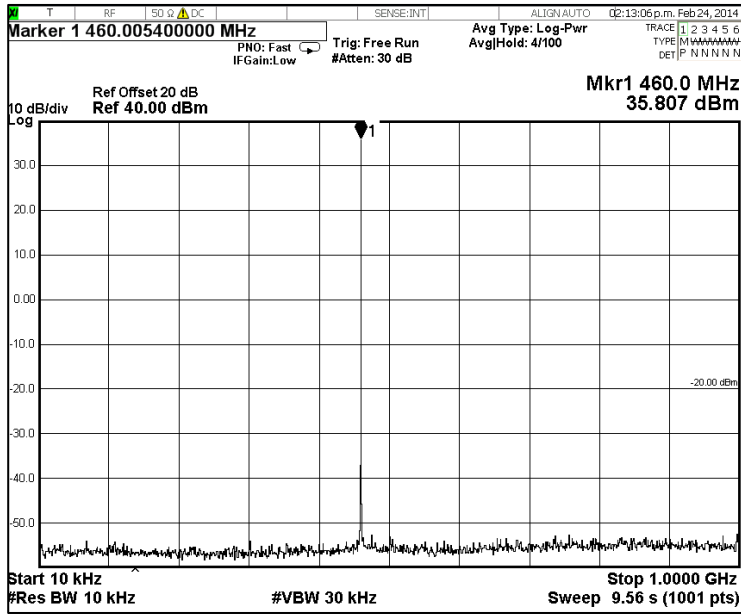

Spurious Emissions (Tx Conducted)

12.5 kHz Channel Spacing

469.9 MHz @ 4 W

Emission Mask D

Emission Frequency (MHz)	Level (dBm)	Level (dBc)
~	~	~

12.5 kHz Channel Spacing

469.9 MHz @ 1 W

Emission Mask D

Emission Frequency (MHz)	Level (dBm)	Level (dBc)
~	~	~

No emissions were detected at a level greater than 20 dB below the limit.

469.9 MHz @ 4 W

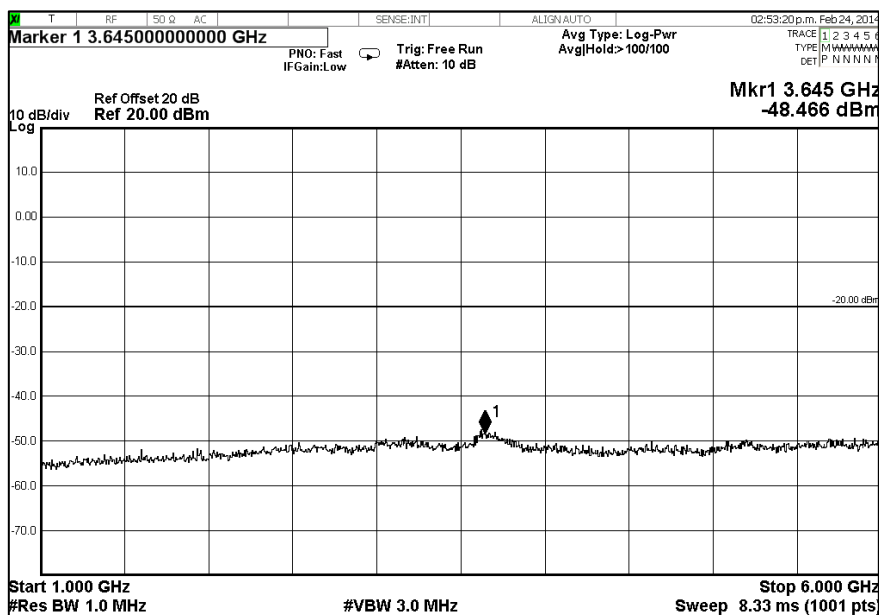
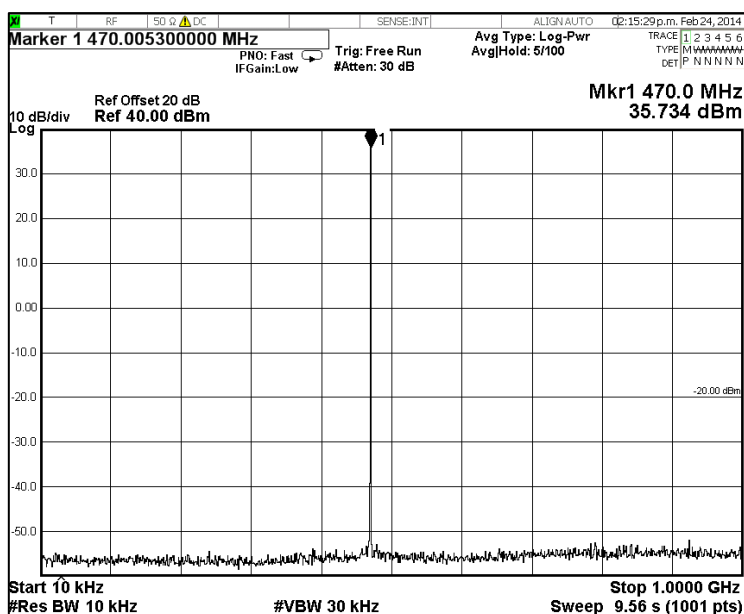

Spurious Emissions (Tx Conducted)

12.5 kHz Channel Spacing

511.9 MHz @ 4 W

Emission Mask D

Emission Frequency (MHz)	Level (dBm)	Level (dBc)
~	~	~

12.5 kHz Channel Spacing

511.9 MHz @ 1 W

Emission Mask D

Emission Frequency (MHz)	Level (dBm)	Level (dBc)
~	~	~

No emissions were detected at a level greater than 20 dB below the limit.

511.9 MHz @ 4 W

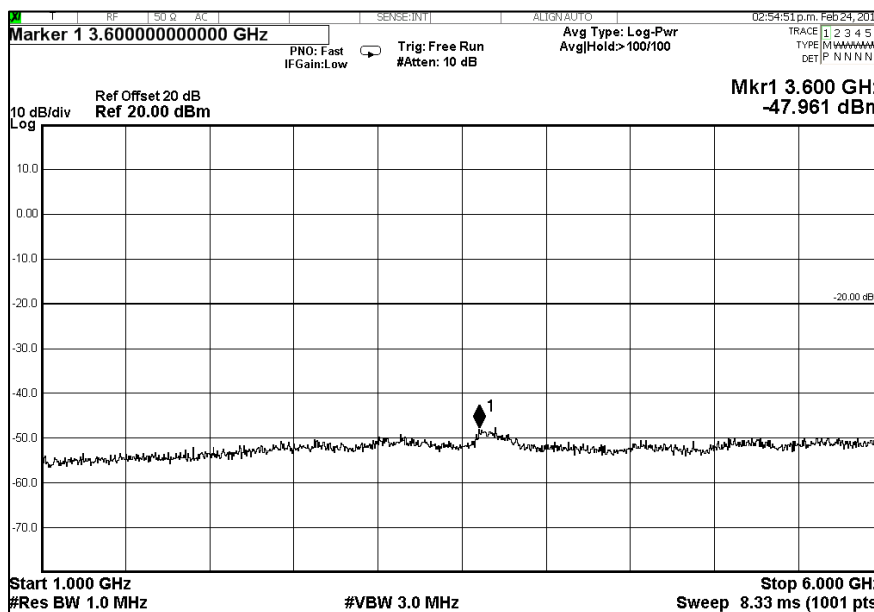
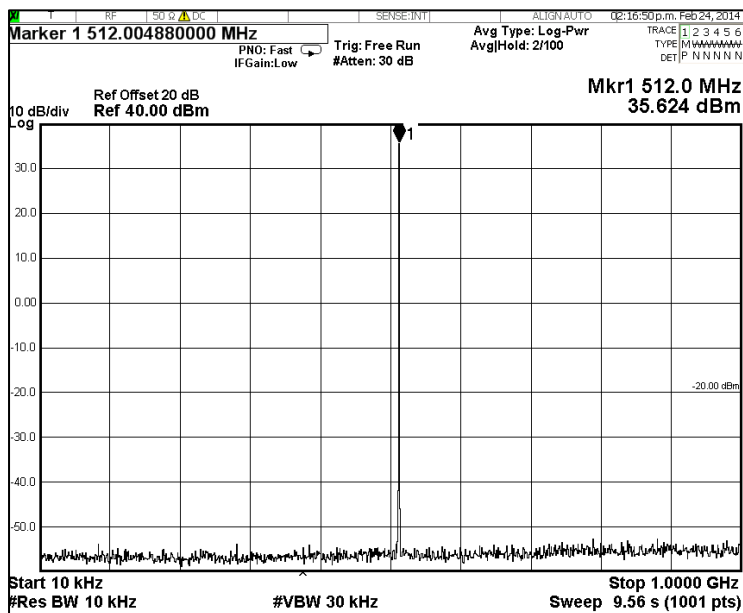

Spurious Emissions (Tx Conducted)

SPECIFICATION: FCC CFR 2.1051 RSS-119 5.8

LIMITS: FCC 47 CFR 90.210 RSS-119 5.8

Carrier Output Power	Emission Mask D 12.5 kHz Channel Spacing $50 + 10 \text{ Log}_{10} (P_{\text{Watts}})$	
	4 W	-20 dBm
1 W	-20 dBm	-50 dBc

TRANSMITTER SPURIOUS EMISSIONS (RADIATED)

SPECIFICATION: FCC 47 CFR 2.1053

GUIDE: TIA/EIA-603D 2.2.12

MEASUREMENT PROCEDURE:

Initial Scan:

1. The EUT is placed in the S-Line TEM cell and emissions are measured from 30 MHz to 1000 MHz. Any emission within 20 dB of the limit is then re-tested on the OATS along with measurements from 1000 MHz to the 10th harmonic of the fundamental frequency.
2. The EUT is placed in the reverberation chamber and emissions are measured from 1000 MHz to the upper frequency required. Any emission within 20 dB of the limit is then re-tested on the OATS.
3. The harmonics emissions up to the 6th harmonic of the fundamental frequency are measured on the OATS

OATS Measurement:

1. The EUT is placed on a wooden turntable at a distance of three metres from the test antenna. The output terminal is connected to an RF dummy load.
2. The test antenna is raised from 1 m to 4 m to obtain a maximum reading; the turntable is then rotated through 360° to obtain the maximum response of each spurious emission. Valid emissions are determined by switching the EUT on and off.
3. The EUT is then replaced by a signal generator and substitution antenna to make measurements by the substitution method.

MEASUREMENT RESULTS:

See the tables on the following pages

LIMIT CLAUSE: FCC 47 CFR 90.210

Spurious Emissions (Tx Radiated)

SPECIFICATION: FCC CFR 2.1053

Tx FREQUENCY: 450.1 MHz

12.5 kHz Channel Spacing 450.1 MHz @ 4 W Emission Mask D

Emission Frequency (MHz)	Level (dBm)	Level (dBc)
~	~	~

12.5 kHz Channel Spacing 450.1 MHz @ 1 W Emission Mask D

Emission Frequency (MHz)	Level (dBm)	Level (dBc)
~	~	~
No emissions were detected at a level greater than 10 dB below the limit.		

12.5 kHz Channel Spacing 459.9 MHz @ 4 W Emission Mask D

Emission Frequency (MHz)	Level (dBm)	Level (dBc)
~	~	~

12.5 kHz Channel Spacing 459.9 MHz @ 1 W Emission Mask D

Emission Frequency (MHz)	Level (dBm)	Level (dBc)
~	~	~
No emissions were detected at a level greater than 10 dB below the limit.		

Tx Radiated Emissions - Continued

12.5 kHz Channel Spacing 469.9 MHz @ 4 W Emission Mask D

Emission Frequency (MHz)	Level (dBm)	Level (dBc)
~	~	~

12.5 kHz Channel Spacing 469.9 MHz @ 1 W Emission Mask D

Emission Frequency (MHz)	Level (dBm)	Level (dBc)
~	~	~
No emissions were detected at a level greater than 10 dB below the limit.		

12.5 kHz Channel Spacing 511.9 MHz @ 4 W Emission Mask D

Emission Frequency (MHz)	Level (dBm)	Level (dBc)
~	~	~

12.5 kHz Channel Spacing 511.9 MHz @ 1 W Emission Mask D

Emission Frequency (MHz)	Level (dBm)	Level (dBc)
~	~	~
No emissions were detected at a level greater than 10 dB below the limit.		

LIMITS: FCC CFR 2.1053

Carrier Output Power	Emission Mask D 12.5 kHz Channel Spacing $50 + 10 \text{ Log}_{10} (P_{\text{Watts}})$	
	4 W	-20 dBm
1 W	-20 dBm	-50 dBc

Tx Radiated Emissions - Continued

Open Area Test Site Results:

12.5 kHz Channel Spacing

469.9 MHz @ 4 W

Emission Mask D

Harmonics Emission Frequency (MHz)	Level (dBm)	Level (dBc)
939.8	-53.9	-89.9
1409.7	-55.4	-91.4
1879.6	-58.9	-94.9
2349.5	-86.5	-122.5
2819.4	-73.9	-109.9
3289.3	-76.5	-112.5

Photo: OATS Setup



TRANSIENT FREQUENCY BEHAVIOR

SPECIFICATION: FCC 47 CFR 90.214 RSS-119 5.9

GUIDE: TIA/EIA-603D 2.2.19

MEASUREMENT PROCEDURE:

1. Refer Annex A for equipment set up.
2. Measurements and plots were made following the TIA/EIA procedure.

MEASUREMENT RESULTS:

See the tables and plots on the following pages for 12.5 kHz & 25.0 kHz channel spacings.

LIMIT CLAUSES: FCC 47 CFR 90.214 RSS-119 5.9

Transient Frequency Behaviour

SPECIFICATION: FCC 47 CFR 90.214

RSS-119 5.9

Tx FREQUENCY: 450.1 MHz

4 W

12.5 kHz Channel Spacing

450.1 MHz @ 4 W Tx

TRANSIENT RESPONSE PERIOD	CARRIER PEAK VARIATION FROM NORMAL	
	Key ON (kHz)	Key OFF (kHz)
t1	-1.1	N/A
t2	-0.7	N/A
t3	N/A	-0.7
t2 → t3 ppm	-1.9	
ERROR LIMIT (t2 → t3) ppm	2.5	

Confirm that during periods t1 and t3 the frequency difference does not exceed the value of one channel separation.	YES	NO
	Y	
Confirm that during the period t2 the frequency difference does not exceed half a channel separation.	YES	NO
	Y	
Confirm that during the period t2 to t3 the frequency difference does not exceed the frequency error limit.	YES	NO
	Y	

LIMIT: FCC 47 CFR 90.214

TRANSIENT PERIODS	FREQUENCY RANGE	
	150 MHz – 174 MHz	421 MHz – 512 MHz
t1 (ms)	5 ms	10 ms
t2 (ms)	20 ms	25 ms
t3 (ms)	5 ms	10 ms

LIMIT: RSS-119 5.9

Transient Frequency Behaviour for Equipment Designed to Operate on 12.5 kHz Channels			
TRANSIENT PERIODS	Maximum Frequency Difference	FREQUENCY RANGE	
		138 – 174 MHz	406.1 – 470 MHz
t1 (ms)	± 12.5 kHz	5 ms	10 ms
t2 (ms)	± 6.25 kHz	20 ms	25 ms
t3 (ms)	± 12.5 kHz	5 ms	10 ms

Note: RSS-119 5.9 - If the transmitter carrier output power rating is 6 Watts or less, the frequency difference during the time periods t1 and t3 may exceed the maximum frequency difference for these time periods.

Transient Frequency Behaviour

SPECIFICATION: FCC 47 CFR 90.214

RSS-119 5.9

Tx FREQUENCY: 450.1 MHz

4 W

12.5 kHz Channel Spacing

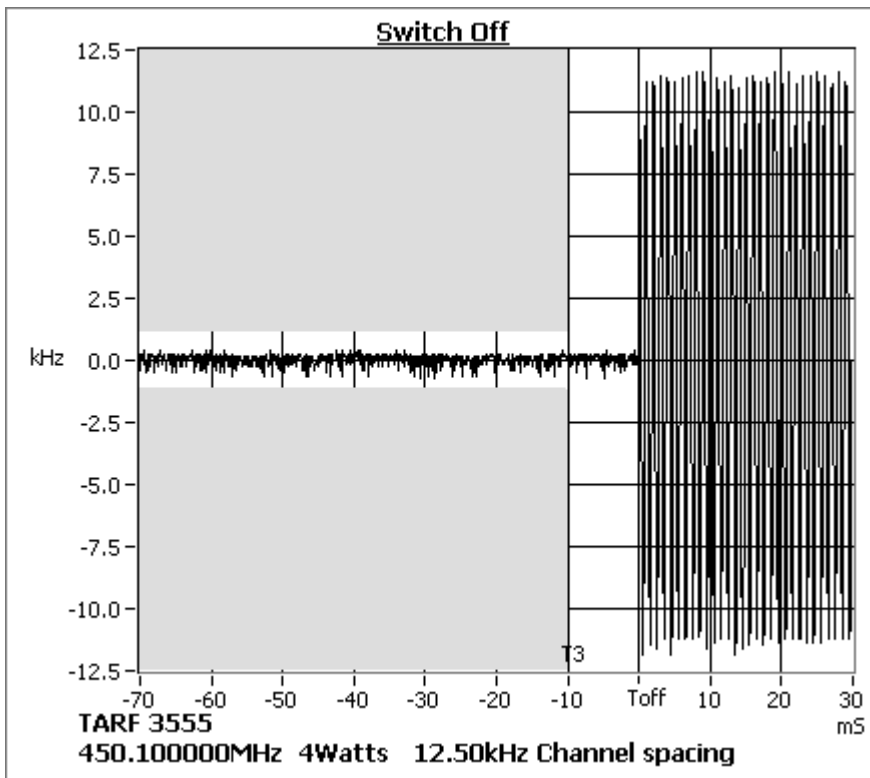
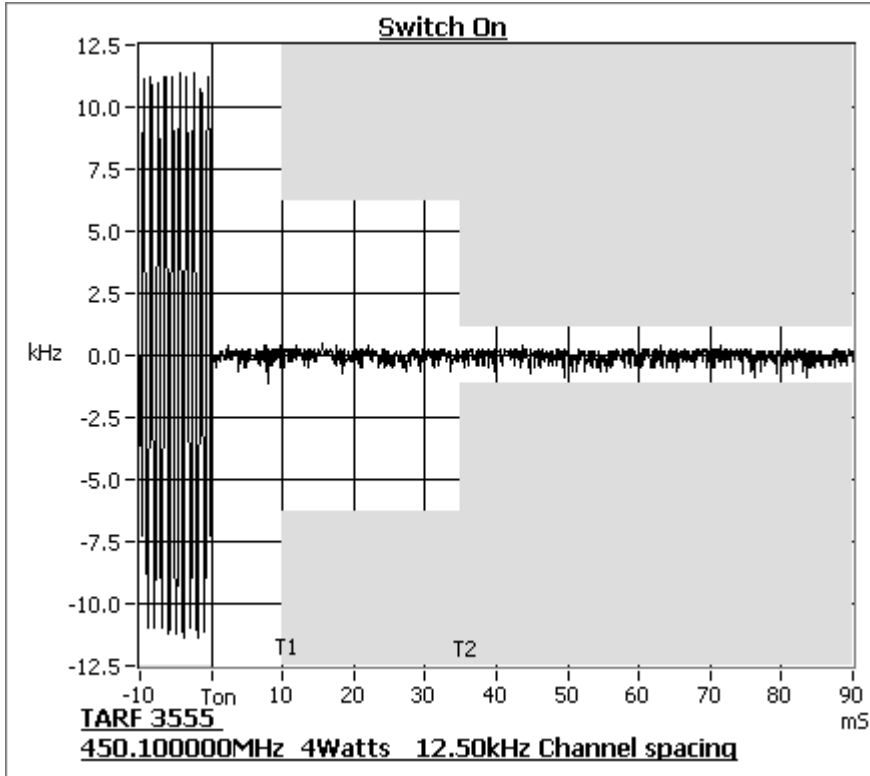

Transient Frequency Behaviour

SPECIFICATION: FCC 47 CFR 90.214

RSS-119 5.9

Tx FREQUENCY: 459.9 MHz

4 W

12.5 kHz Channel Spacing

459.9 MHz @ 4 W Tx

TRANSIENT RESPONSE PERIOD	CARRIER PEAK VARIATION FROM NORMAL	
	Key ON (kHz)	Key OFF (kHz)
t1	-0.9	N/A
t2	-0.7	N/A
t3	N/A	-0.7
t2 → t3 ppm	-1.7	
ERROR LIMIT (t2 → t3) ppm	2.5	

Confirm that during periods t1 and t3 the frequency difference does not exceed the value of one channel separation.	YES	NO
	Y	
Confirm that during the period t2 the frequency difference does not exceed half a channel separation.	YES	NO
	Y	
Confirm that during the period t2 to t3 the frequency difference does not exceed the frequency error limit.	YES	NO
	Y	

LIMIT: FCC 47 CFR 90.214

TRANSIENT PERIODS	FREQUENCY RANGE	
	150 MHz – 174 MHz	421 MHz – 512 MHz
t1 (ms)	5 ms	10 ms
t2 (ms)	20 ms	25 ms
t3 (ms)	5 ms	10 ms

LIMIT: RSS-119 5.9

Transient Frequency Behaviour for Equipment Designed to Operate on 12.5 kHz Channels			
TRANSIENT PERIODS	Maximum Frequency Difference	FREQUENCY RANGE	
		138 – 174 MHz	406.1 – 470 MHz
t1 (ms)	± 12.5 kHz	5 ms	10 ms
t2 (ms)	± 6.25 kHz	20 ms	25 ms
t3 (ms)	± 12.5 kHz	5 ms	10 ms

Note: RSS-119 5.9 - If the transmitter carrier output power rating is 6 Watts or less, the frequency difference during the time periods t1 and t3 may exceed the maximum frequency difference for these time periods.

Transient Frequency Behaviour

SPECIFICATION: FCC 47 CFR 90.214

RSS-119 5.9

Tx FREQUENCY: 459.9 MHz 4 W 12.5 kHz Channel Spacing

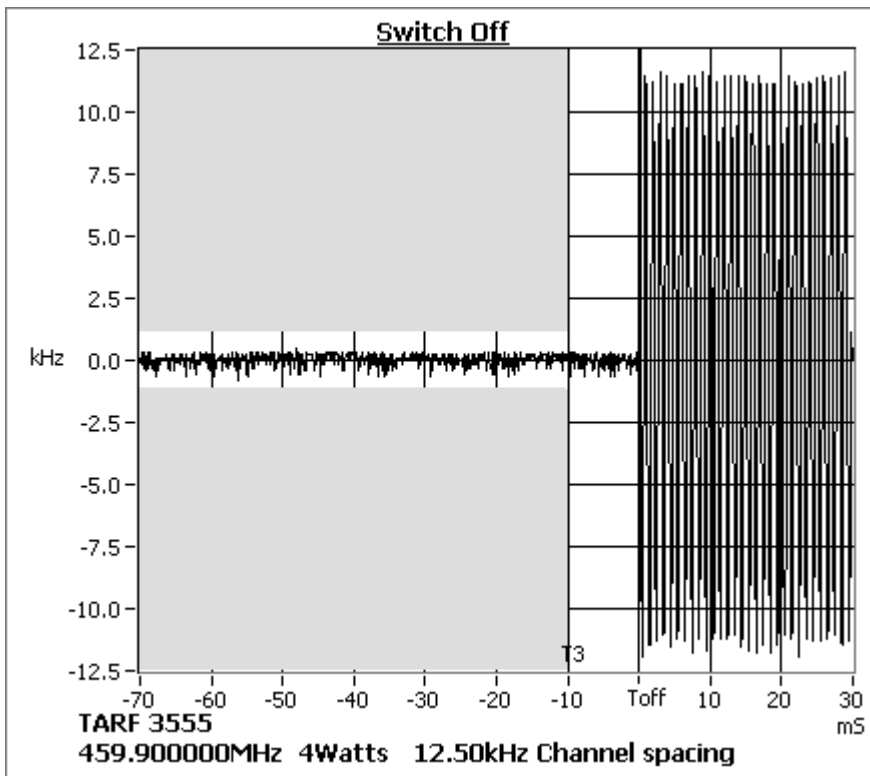
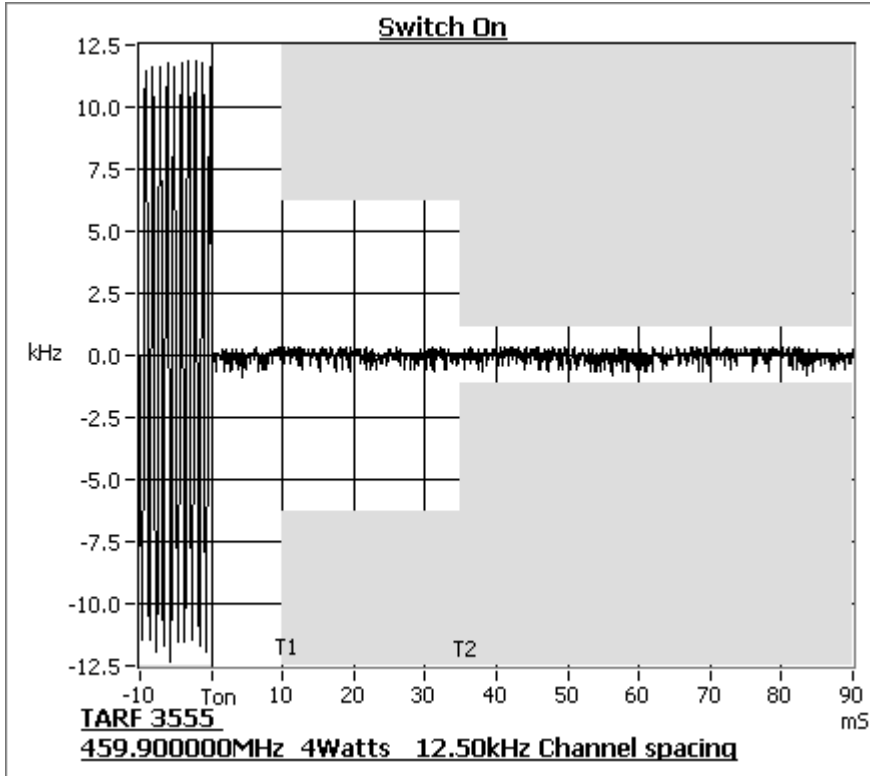

Transient Frequency Behaviour

SPECIFICATION: FCC 47 CFR 90.214

RSS-119 5.9

Tx FREQUENCY: 469.9 MHz

4 W

12.5 kHz Channel Spacing

469.9 MHz @ 4 W Tx

TRANSIENT RESPONSE PERIOD	CARRIER PEAK VARIATION FROM NORMAL	
	Key ON (kHz)	Key OFF (kHz)
t1	-3.2	N/A
t2	-0.8	N/A
t3	N/A	-0.7
t2 → t3 ppm	-1.7	
ERROR LIMIT (t2 → t3) ppm	2.5	

Confirm that during periods t1 and t3 the frequency difference does not exceed the value of one channel separation.	YES	NO
	Y	
Confirm that during the period t2 the frequency difference does not exceed half a channel separation.	YES	NO
	Y	
Confirm that during the period t2 to t3 the frequency difference does not exceed the frequency error limit.	YES	NO
	Y	

LIMIT: FCC 47 CFR 90.214

TRANSIENT PERIODS	FREQUENCY RANGE	
	150 MHz – 174 MHz	421 MHz – 512 MHz
t1 (ms)	5 ms	10 ms
t2 (ms)	20 ms	25 ms
t3 (ms)	5 ms	10 ms

LIMIT: RSS-119 5.9

Transient Frequency Behaviour for Equipment Designed to Operate on 12.5 kHz Channels			
TRANSIENT PERIODS	Maximum Frequency Difference	FREQUENCY RANGE	
		138 – 174 MHz	406.1 – 470 MHz
t1 (ms)	± 12.5 kHz	5 ms	10 ms
t2 (ms)	± 6.25 kHz	20 ms	25 ms
t3 (ms)	± 12.5 kHz	5 ms	10 ms

Note: RSS-119 5.9 - If the transmitter carrier output power rating is 6 Watts or less, the frequency difference during the time periods t1 and t3 may exceed the maximum frequency difference for these time periods.

Transient Frequency Behaviour

SPECIFICATION: FCC 47 CFR 90.214

RSS-119 5.9

Tx FREQUENCY: 469.9 MHz 4 W 12.5 kHz Channel Spacing

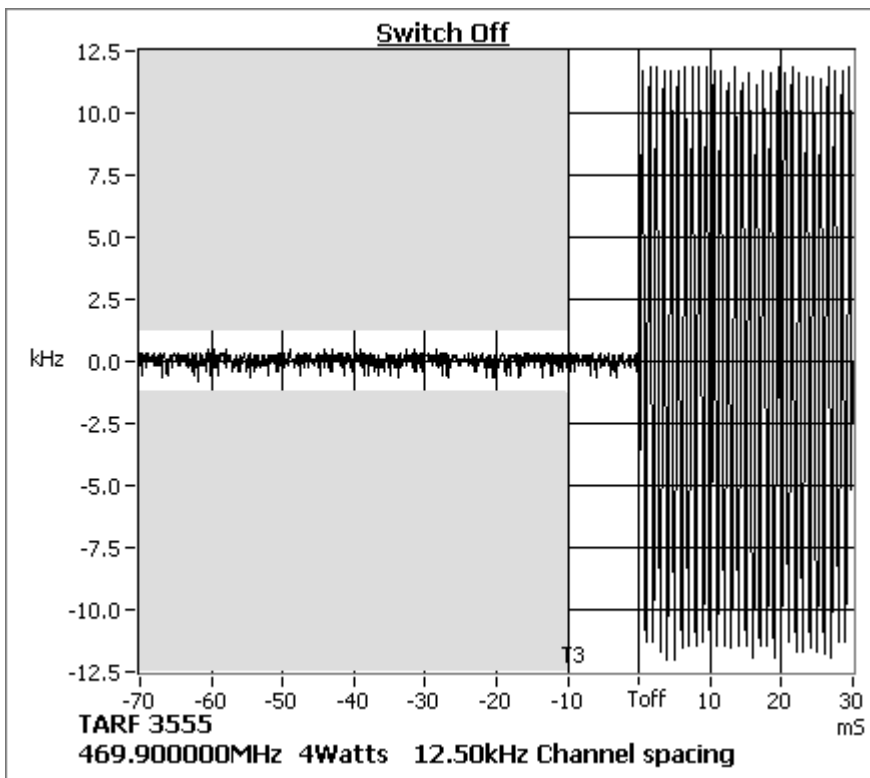
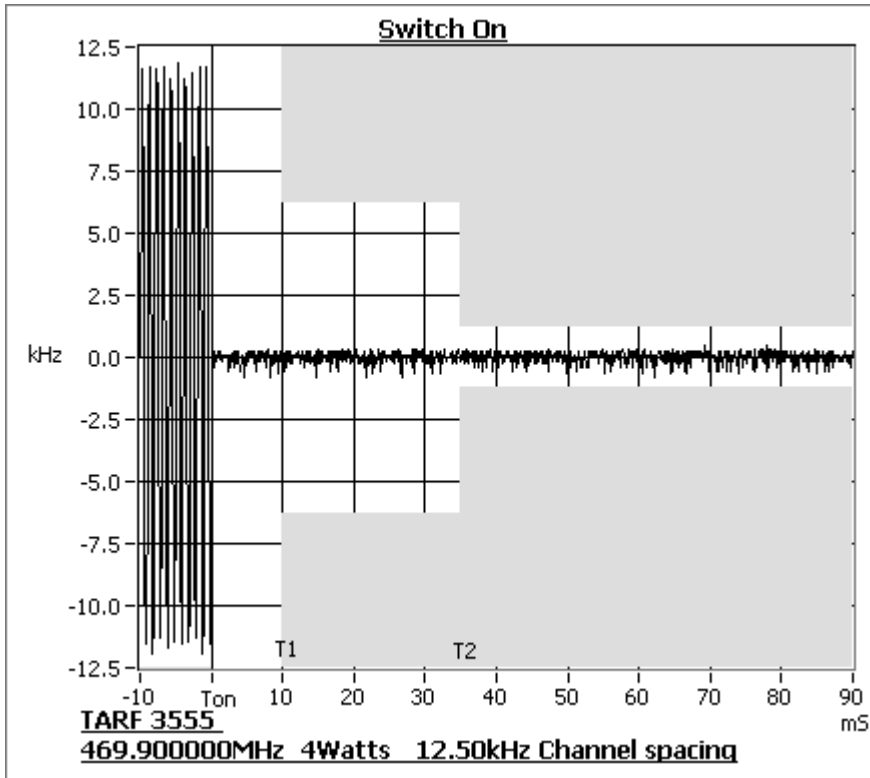

Transient Frequency Behaviour

SPECIFICATION: FCC 47 CFR 90.214

RSS-119 5.9

Tx FREQUENCY: 511.9 MHz 4 W

12.5 kHz Channel Spacing

511.9 MHz @ 4 W Tx

TRANSIENT RESPONSE PERIOD	CARRIER PEAK VARIATION FROM NORMAL	
	Key ON (kHz)	Key OFF (kHz)
t1	-0.8	N/A
t2	-0.8	N/A
t3	N/A	-0.6
t2 → t3 ppm	-1.4	
ERROR LIMIT (t2 → t3) ppm	2.5	

Confirm that during periods t1 and t3 the frequency difference does not exceed the value of one channel separation.	YES	NO
	Y	
Confirm that during the period t2 the frequency difference does not exceed half a channel separation.	YES	NO
	Y	
Confirm that during the period t2 to t3 the frequency difference does not exceed the frequency error limit.	YES	NO
	Y	

LIMIT: FCC 47 CFR 90.214

TRANSIENT PERIODS	FREQUENCY RANGE	
	150 MHz – 174 MHz	421 MHz – 512 MHz
t1 (ms)	5 ms	10 ms
t2 (ms)	20 ms	25 ms
t3 (ms)	5 ms	10 ms

LIMIT: RSS-119 5.9

Transient Frequency Behaviour for Equipment Designed to Operate on 12.5 kHz Channels			
TRANSIENT PERIODS	Maximum Frequency Difference	FREQUENCY RANGE	
		138 – 174 MHz	406.1 – 470 MHz
t1 (ms)	± 12.5 kHz	5 ms	10 ms
t2 (ms)	± 6.25 kHz	20 ms	25 ms
t3 (ms)	± 12.5 kHz	5 ms	10 ms

Note: RSS-119 5.9 - If the transmitter carrier output power rating is 6 Watts or less, the frequency difference during the time periods t1 and t3 may exceed the maximum frequency difference for these time periods.

Transient Frequency Behaviour

SPECIFICATION: FCC 47 CFR 90.214

RSS-119 5.9

Tx FREQUENCY: 511.9 MHz 4 W 12.5 kHz Channel Spacing

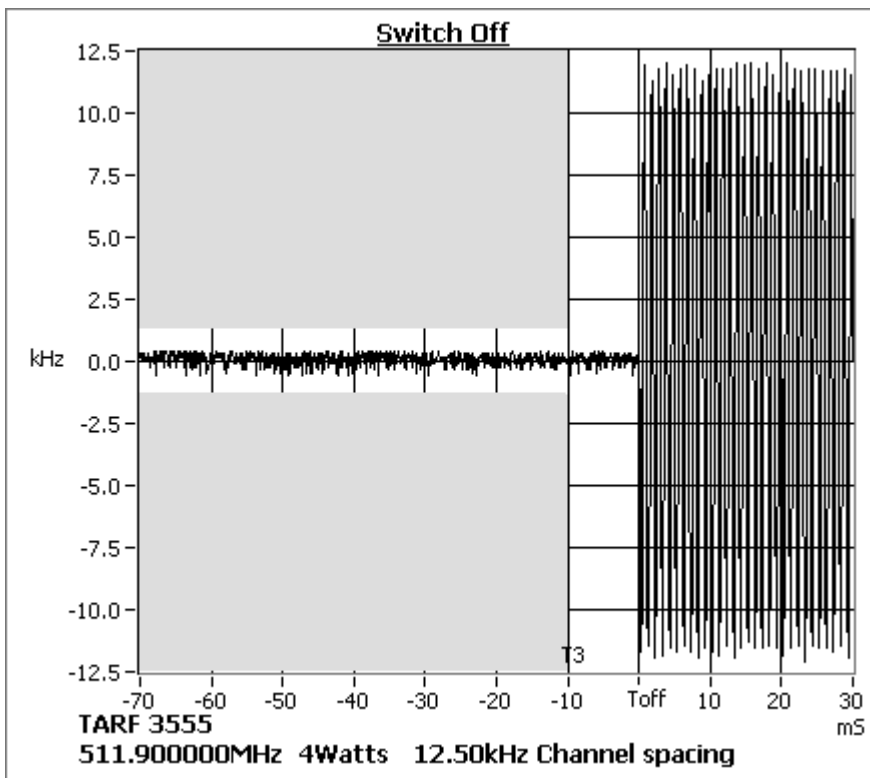
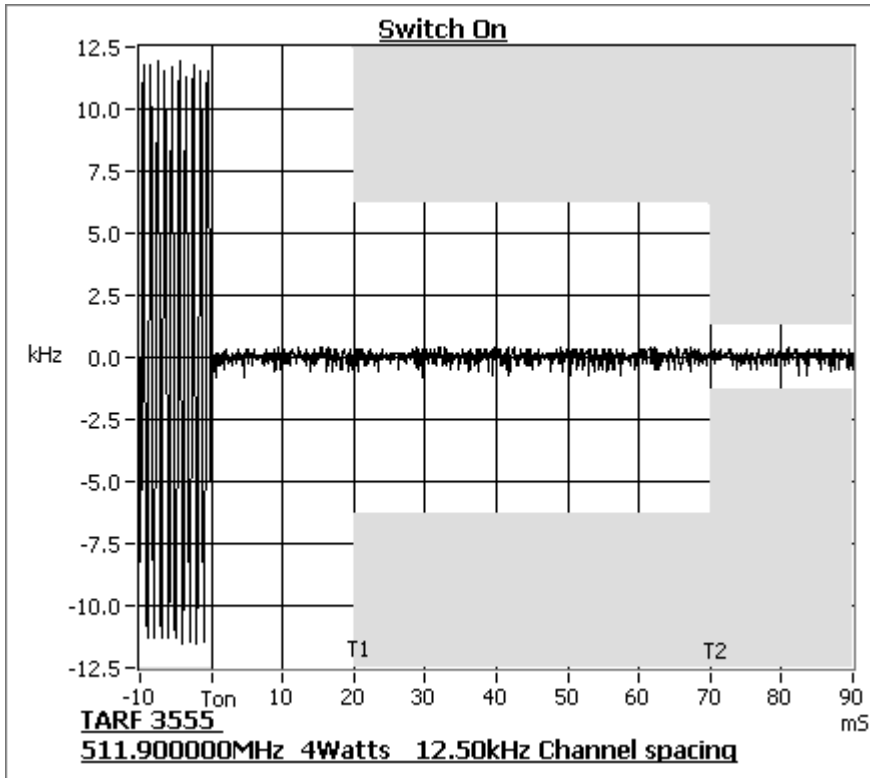

Transient Frequency Behaviour

SPECIFICATION: FCC 47 CFR 90.214

Tx FREQUENCY: 450.1 MHz 4 W 25.0 kHz Channel Spacing

450.1 MHz @ 4 W Tx

TRANSIENT RESPONSE PERIOD	CARRIER PEAK VARIATION FROM NORMAL	
	Key ON (kHz)	Key OFF (kHz)
t1	-3.0	N/A
t2	-1.0	N/A
t3	N/A	-0.5
t2 → t3 ppm	-2.3	
ERROR LIMIT t2 → t3 (ppm)	2.5	

Confirm that during periods t1 and t3 the frequency difference does not exceed the value of one channel separation.	YES	NO
	Y	
Confirm that during the period t2 the frequency difference does not exceed half a channel separation.	YES	NO
	Y	
Confirm that during the period t2 to t3 the frequency difference does not exceed the frequency error limit.	YES	NO
	Y	

LIMIT: FCC 47 CFR 90.214

TRANSIENT PERIODS	FREQUENCY RANGE	
	150 MHz – 174 MHz	421 MHz – 512 MHz
t1 (ms)	5 ms	10 ms
t2 (ms)	20 ms	25 ms
t3 (ms)	5 ms	10 ms

LIMIT: RSS-119 5.9

Transient Frequency Behaviour for Equipment Designed to Operate on 12.5 kHz Channels			
TRANSIENT PERIODS	Maximum Frequency Difference	FREQUENCY RANGE	
		138 – 174 MHz	406.1 – 470 MHz
t1 (ms)	± 12.5 kHz	5 ms	10 ms
t2 (ms)	± 6.25 kHz	20 ms	25 ms
t3 (ms)	± 12.5 kHz	5 ms	10 ms

Note: RSS-119 5.9 - If the transmitter carrier output power rating is 6 Watts or less, the frequency difference during the time periods t1 and t3 may exceed the maximum frequency difference for these time periods,

Transient Frequency Behavior

SPECIFICATION: FCC 47 CFR 90.214

Tx FREQUENCY: 450.1 MHz 4 W 25.0 kHz Channel Spacing

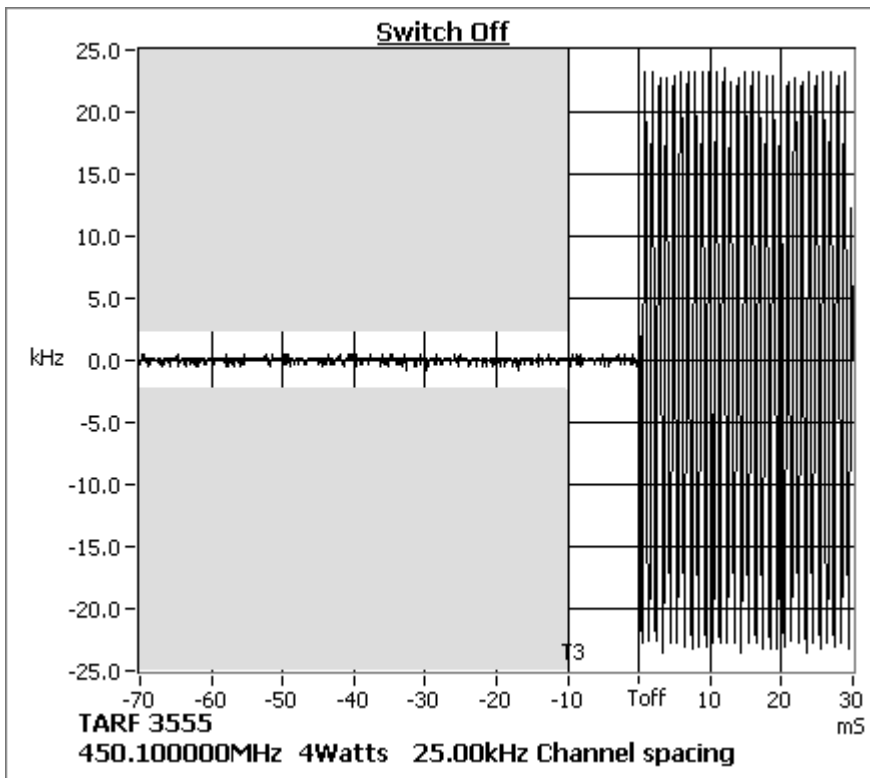
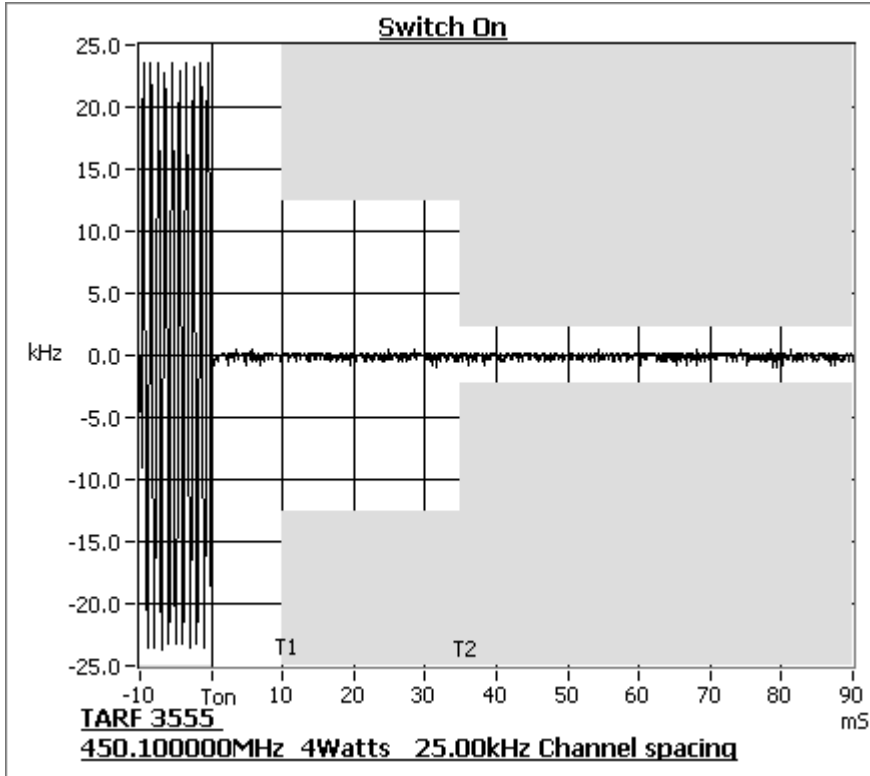

Transient Frequency Behaviour

SPECIFICATION: FCC 47 CFR 90.214

Tx FREQUENCY: 459.9 MHz 4 W 25.0 kHz Channel Spacing

459.9 MHz @ 4 W Tx

TRANSIENT RESPONSE PERIOD	CARRIER PEAK VARIATION FROM NORMAL	
	Key ON (kHz)	Key OFF (kHz)
t1	-0.9	N/A
t2	-0.9	N/A
t3	N/A	-0.4
t2 → t3 ppm	-2.0	
ERROR LIMIT t2 → t3 (ppm)	2.5	

Confirm that during periods t1 and t3 the frequency difference does not exceed the value of one channel separation.	YES	NO
	Y	
Confirm that during the period t2 the frequency difference does not exceed half a channel separation.	YES	NO
	Y	
Confirm that during the period t2 to t3 the frequency difference does not exceed the frequency error limit.	YES	NO
	Y	

LIMIT: FCC 47 CFR 90.214

TRANSIENT PERIODS	FREQUENCY RANGE	
	150 MHz – 174 MHz	421 MHz – 512 MHz
t1 (ms)	5 ms	10 ms
t2 (ms)	20 ms	25 ms
t3 (ms)	5 ms	10 ms

LIMIT: RSS-119 5.9

Transient Frequency Behaviour for Equipment Designed to Operate on 12.5 kHz Channels			
TRANSIENT PERIODS	Maximum Frequency Difference	FREQUENCY RANGE	
		138 – 174 MHz	406.1 – 470 MHz
t1 (ms)	± 12.5 kHz	5 ms	10 ms
t2 (ms)	± 6.25 kHz	20 ms	25 ms
t3 (ms)	± 12.5 kHz	5 ms	10 ms

Note: RSS-119 5.9 - If the transmitter carrier output power rating is 6 Watts or less, the frequency difference during the time periods t1 and t3 may exceed the maximum frequency difference for these time periods,

Transient Frequency Behavior

SPECIFICATION: FCC 47 CFR 90.214

Tx FREQUENCY: 459.9 MHz 4 W 25.0 kHz Channel Spacing

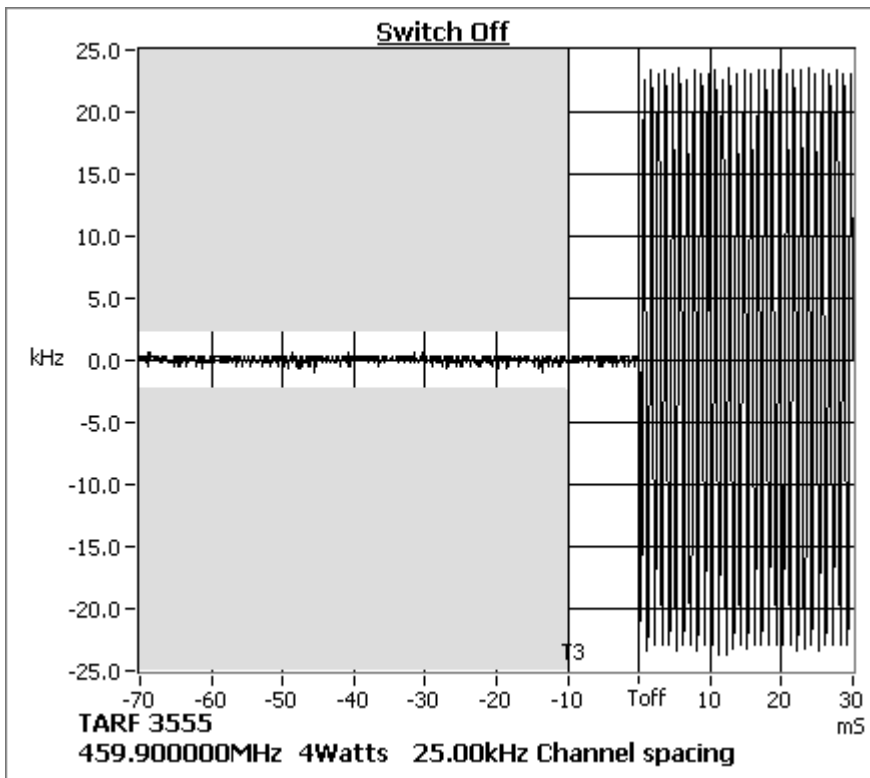
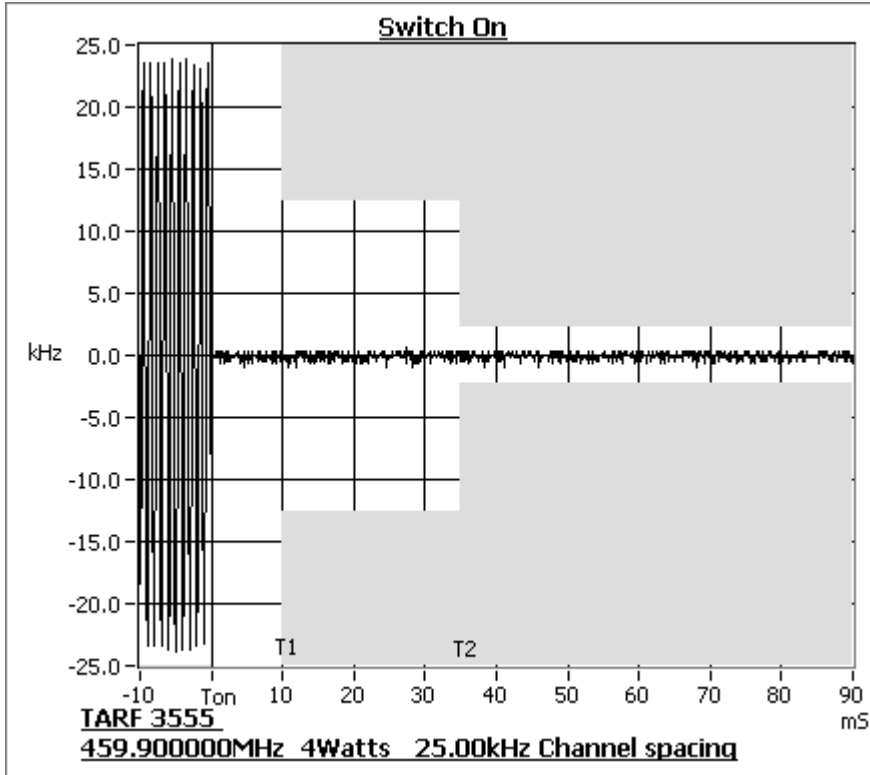

Transient Frequency Behaviour

SPECIFICATION: FCC 47 CFR 90.214

Tx FREQUENCY: 469.9 MHz 4 W 25.0 kHz Channel Spacing

469.9 MHz @ 4 W Tx

TRANSIENT RESPONSE PERIOD	CARRIER PEAK VARIATION FROM NORMAL	
	Key ON (kHz)	Key OFF (kHz)
t1	-0.8	N/A
t2	-0.8	N/A
t3	N/A	-0.6
t2 → t3 ppm	-1.8	
ERROR LIMIT t2 → t3 (ppm)	2.5	

Confirm that during periods t1 and t3 the frequency difference does not exceed the value of one channel separation.	YES	NO
	Y	
Confirm that during the period t2 the frequency difference does not exceed half a channel separation.	YES	NO
	Y	
Confirm that during the period t2 to t3 the frequency difference does not exceed the frequency error limit.	YES	NO
	Y	

LIMIT: FCC 47 CFR 90.214

TRANSIENT PERIODS	FREQUENCY RANGE	
	150 MHz – 174 MHz	421 MHz – 512 MHz
t1 (ms)	5 ms	10 ms
t2 (ms)	20 ms	25 ms
t3 (ms)	5 ms	10 ms

LIMIT: RSS-119 5.9

Transient Frequency Behaviour for Equipment Designed to Operate on 12.5 kHz Channels			
TRANSIENT PERIODS	Maximum Frequency Difference	FREQUENCY RANGE	
		138 – 174 MHz	406.1 – 470 MHz
t1 (ms)	± 12.5 kHz	5 ms	10 ms
t2 (ms)	± 6.25 kHz	20 ms	25 ms
t3 (ms)	± 12.5 kHz	5 ms	10 ms

Note: RSS-119 5.9 - If the transmitter carrier output power rating is 6 Watts or less, the frequency difference during the time periods t1 and t3 may exceed the maximum frequency difference for these time periods,

Transient Frequency Behavior

SPECIFICATION: FCC 47 CFR 90.214

Tx FREQUENCY: 469.9 MHz 4 W 25.0 kHz Channel Spacing

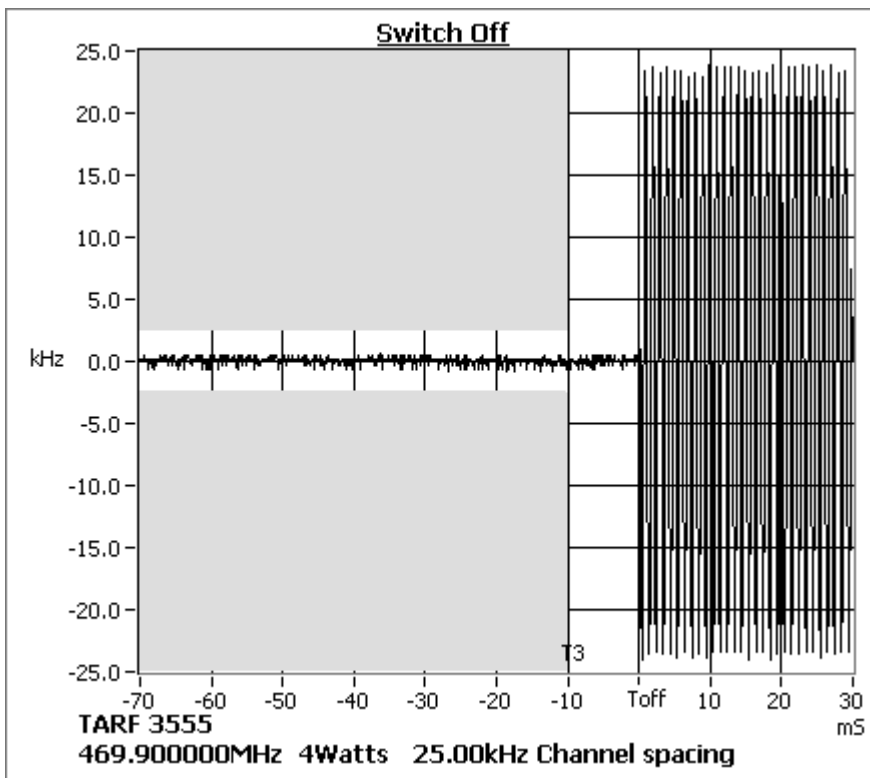
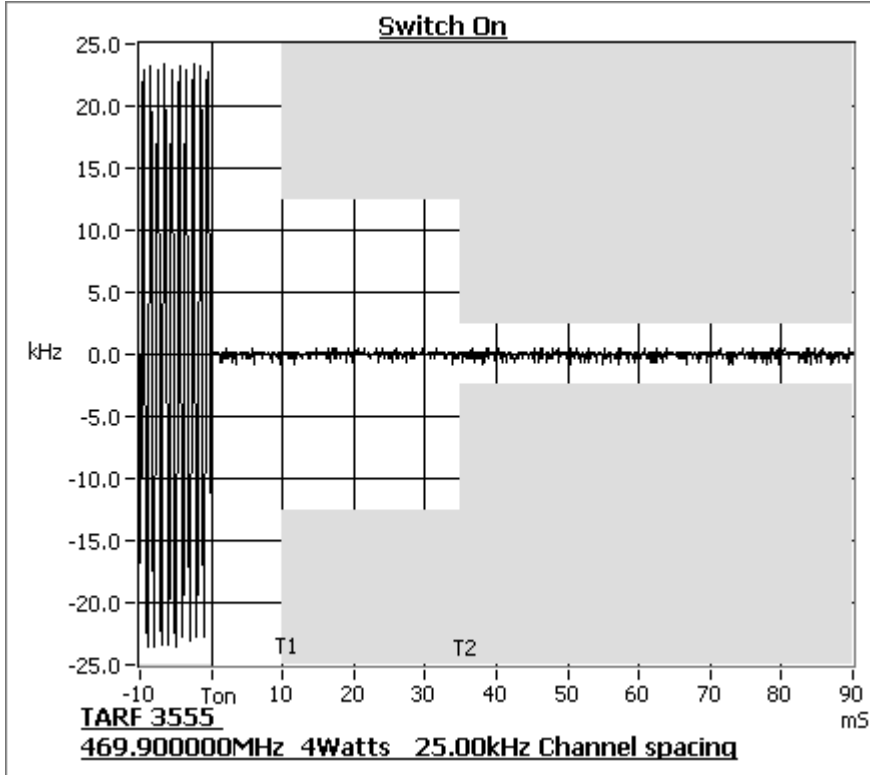

Transient Frequency Behaviour

SPECIFICATION: FCC 47 CFR 90.214

Tx FREQUENCY: 511.9 MHz 4 W 25.0 kHz Channel Spacing

511.9 MHz @ 4 W Tx

TRANSIENT RESPONSE PERIOD	CARRIER PEAK VARIATION FROM NORMAL	
	Key ON (kHz)	Key OFF (kHz)
t1	-1.1	N/A
t2	-1.1	N/A
t3	N/A	-0.9
t2 → t3 ppm	-1.7	
ERROR LIMIT t2 → t3 (ppm)	2.5	

Confirm that during periods t1 and t3 the frequency difference does not exceed the value of one channel separation.	YES	NO
	Y	
Confirm that during the period t2 the frequency difference does not exceed half a channel separation.	YES	NO
	Y	
Confirm that during the period t2 to t3 the frequency difference does not exceed the frequency error limit.	YES	NO
	Y	

LIMIT: FCC 47 CFR 90.214

TRANSIENT PERIODS	FREQUENCY RANGE	
	150 MHz – 174 MHz	421 MHz – 512 MHz
t1 (ms)	5 ms	10 ms
t2 (ms)	20 ms	25 ms
t3 (ms)	5 ms	10 ms

LIMIT: RSS-119 5.9

Transient Frequency Behaviour for Equipment Designed to Operate on 12.5 kHz Channels			
TRANSIENT PERIODS	Maximum Frequency Difference	FREQUENCY RANGE	
		138 – 174 MHz	406.1 – 470 MHz
t1 (ms)	± 12.5 kHz	5 ms	10 ms
t2 (ms)	± 6.25 kHz	20 ms	25 ms
t3 (ms)	± 12.5 kHz	5 ms	10 ms

Note: RSS-119 5.9 - If the transmitter carrier output power rating is 6 Watts or less, the frequency difference during the time periods t1 and t3 may exceed the maximum frequency difference for these time periods,

Transient Frequency Behavior

SPECIFICATION: FCC 47 CFR 90.214

Tx FREQUENCY: 511.9 MHz 4 W 25.0 kHz Channel Spacing

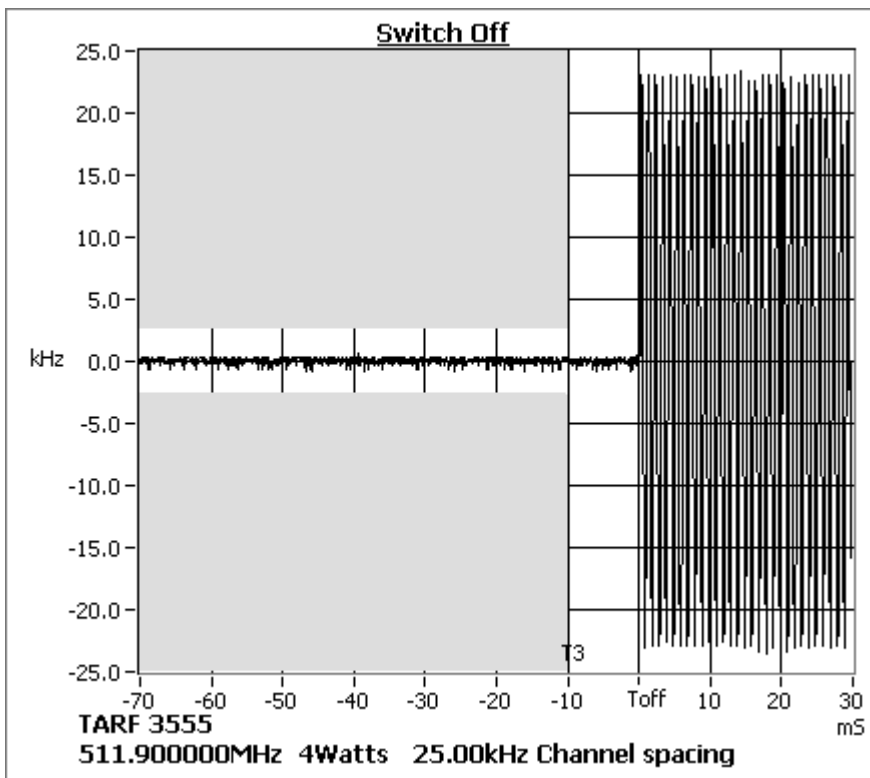
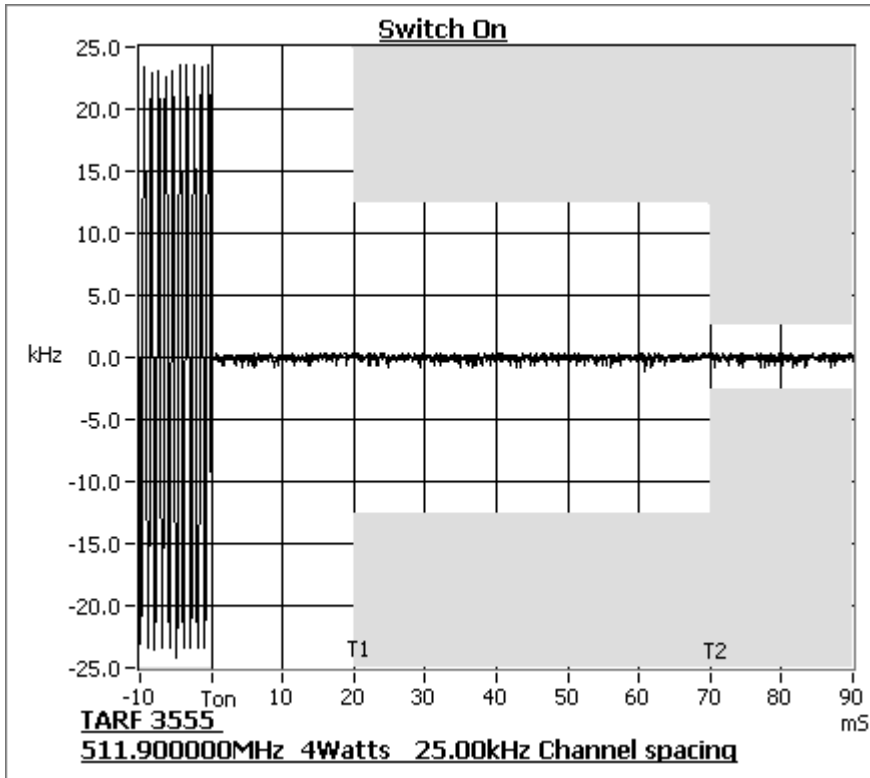

TRANSMITTER FREQUENCY STABILITY - TEMPERATURE

SPECIFICATION: FCC 47 CFR 2.1055 (a) (1)

RSS-119 5.3

GUIDE: TIA/EIA-603D 2.2.2

MEASUREMENT PROCEDURE:

1. Refer Annex A for equipment set up.
2. The EUT was tested for frequency error from -30° C to +50° C in 10° C increments
3. The frequency error was recorded in parts per million (ppm).

MEASUREMENT RESULTS:

See the plots on the following pages for 12.5 kHz channel spacing.

450.1 MHz

Temperature (°C)	Frequency (Hz)	Error (ppm)
-30	46	0.1
-20	49	0.11
-10	59	0.13
0	-9	-0.02
10	21	0.05
20	53	0.12
30	43	0.1
40	55	0.12
50	108	0.24

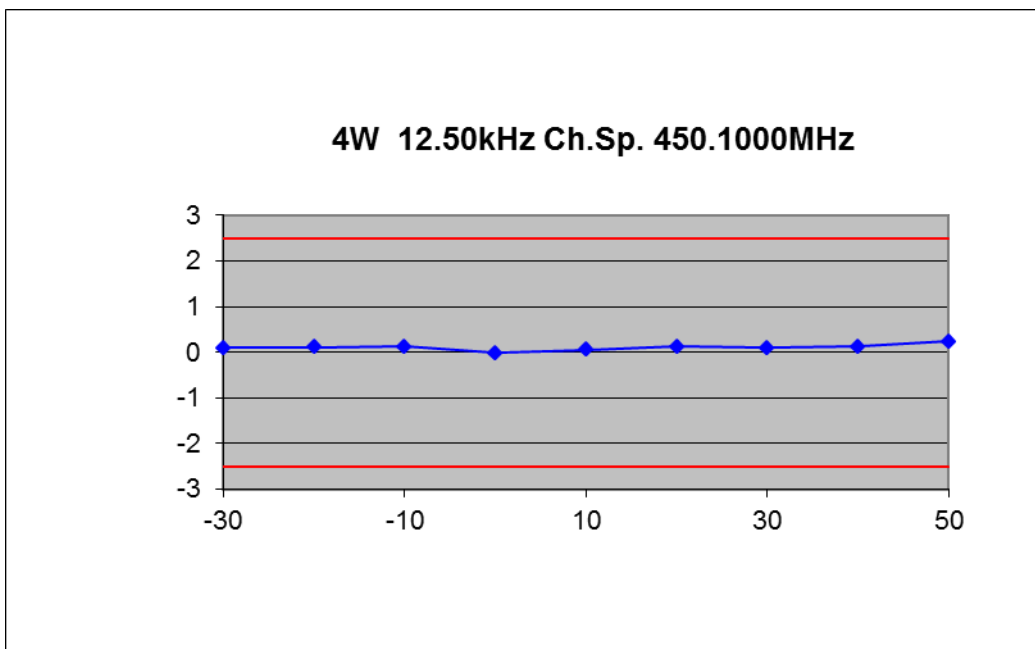

Transmitter Frequency Stability - Temperature

459.9 MHz

Temperature (°C)	Frequency (Hz)	Error (ppm)
-30	50	0.11
-20	52	0.11
-10	54	0.12
0	-11	-0.02
10	23	0.05
20	52	0.11
30	43	0.09
40	58	0.13
50	114	0.25

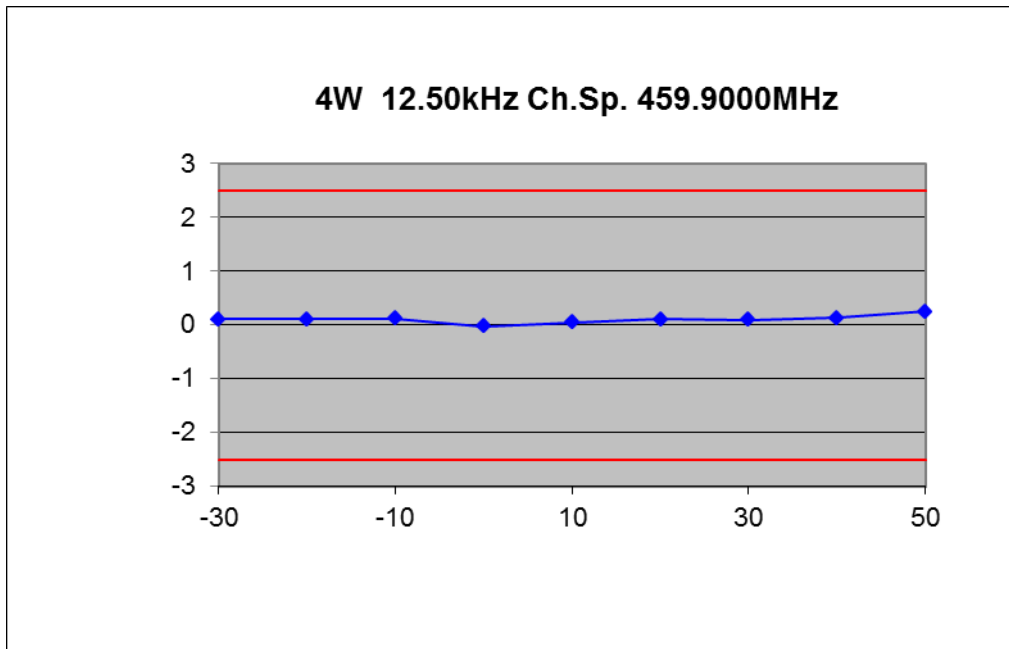

Transmitter Frequency Stability - Temperature

469.9 MHz

Temperature (°C)	Frequency (MHz)	Error (ppm)
-30	57	0.12
-20	65	0.14
-10	52	0.11
0	-6	-0.01
10	34	0.07
20	59	0.13
30	47	0.1
40	69	0.15
50	129	0.27

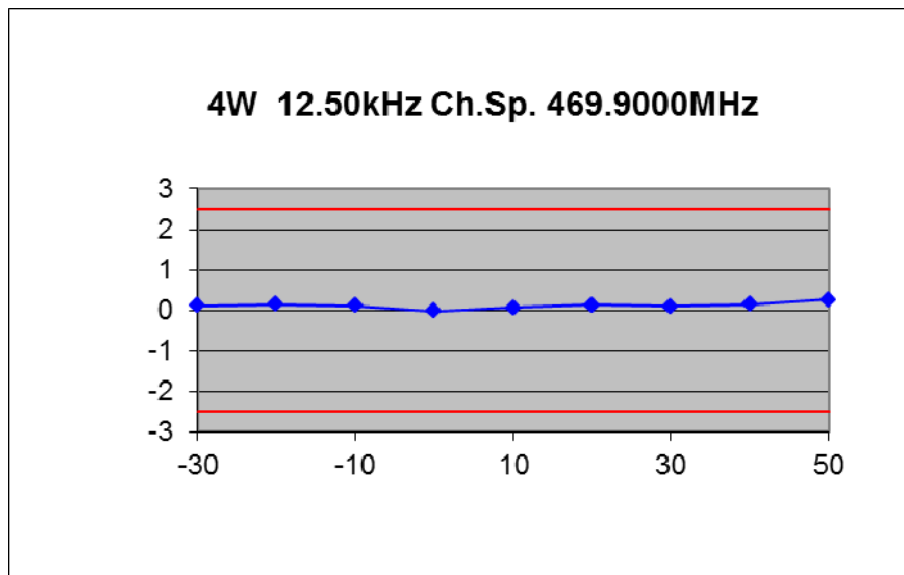

Transmitter Frequency Stability - Temperature

511.9 MHz

Temperature (°C)	Frequency (MHz)	Error (ppm)
-30	57	0.11
-20	70	0.14
-10	43	0.08
0	-7	-0.01
10	38	0.07
20	62	0.12
30	50	0.1
40	78	0.15
50	143	0.28

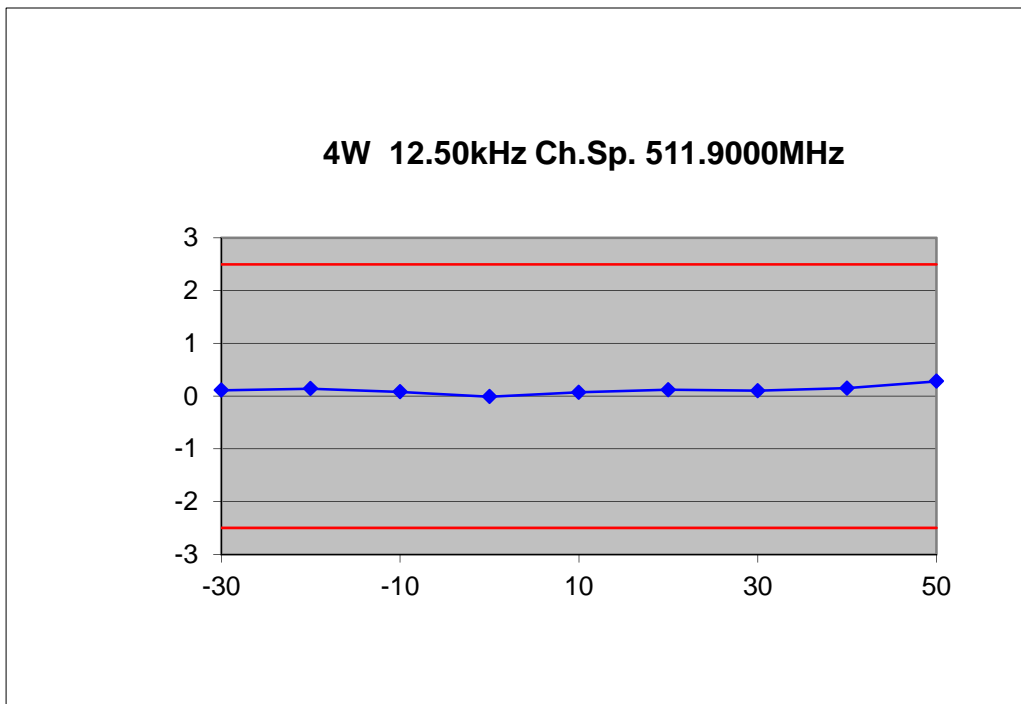

Transmitter Frequency Stability - Temperature

LIMIT:		FCC 47 CFR 90.213	RSS-119 5.3
Channel Spacing (kHz)		Frequency Error (ppm)	
12.5		2.5	
25.0		5.0	

TRANSMITTER FREQUENCY STABILITY - VOLTAGE

SPECIFICATION: FCC 47 CFR 2.1055 (d) (1)

RSS-119 5.3

GUIDE: TIA/EIA-603D 2.2.2

MEASUREMENT PROCEDURE:

1. Refer Annex A for equipment set up.
2. The EUT was tested for frequency error at an input voltage to the radio of 85% to 115%.
3. The frequency error was recorded in parts per million (ppm).

MEASUREMENT RESULTS:

Voltage	FREQUENCY ERROR (ppm) for 12.5 kHz			
	450.1 MHz	459.9 MHz	469.9 MHz	511.9 MHz
7.5 V _{DC}	0.04	0.06	0.08	0.07
6.4 V _{DC}	0.05	0.07	0.08	0.07

LIMIT CLAUSES: FCC 47 CFR 90.213

RSS-119 5.3

Channel Spacing (kHz)	Frequency Error (ppm)
12.5	2.5
25.0	5.0

RECEIVER SPURIOUS EMISSIONS (CONDUCTED)

SPECIFICATION: RSS-119 5.11

GUIDE: TIA/EIA-603D 2.1.2

MEASUREMENT PROCEDURE:

1. Refer Annex A for Equipment set up diagram.
2. The frequency range examined was from 30 MHz to 3 times highest tunable frequency.
3. Spurious emissions which were attenuated more than 20 dB below the limit were not recorded.

450.1 MHz Receive		
Emission Frequency (MHz)	Level (nW)	Level (dBm)
~	~	~
No emissions were detected within 20 dB of Limit.		

459.9 MHz Receive		
Emission Frequency (MHz)	Level (nW)	Level (dBm)
~	~	~
No emissions were detected within 20 dB of Limit.		

469.9 MHz Receive		
Emission Frequency (MHz)	Level (nW)	Level (dBm)
~	~	~
No emissions were detected within 20 dB of Limit.		

511.9 MHz Receive		
Emission Frequency (MHz)	Level (nW)	Level (dBm)
~	~	~
No emissions were detected within 20 dB of Limit.		

LIMIT CLAUSE: RSS-Gen 6(b)

LIMIT	30 → 1000 MHz	2 nW	- 57 dBm
	> 1000 MHz	5 nW	- 53 dBm

TEST EQUIPMENT LIST

No#	Equipment Type	Information	Manufacturer	Model No	Serial No#	Tait ID	Cal Due
31	Antenna	18GHz DRG	Emco	DRG3115	9512-4638	E3560	6-Mar-16
32	Antenna	18GHz DRG	Emco	DRG3115	2084	E3076	6-Mar-16
128	Antenna	Log Periodic	Schwarzbeck	VUSLP	9111-219	E4147	
148	Antenna	Reverb - 1-18GHz DRG	Schwarzbeck	BBHA9120 D	9120D-885	E4857	
149	Antenna	Reverb - 1-18GHz DRG	Schwarzbeck	BBHA9120 D	9120D-884	E4858	
107	Coax Cable	OATS Tower Cable	Intelcom	RG214	OATS1	E4621	13-Oct-14
108	Coax Cable	OATS Turntable Cable	Intelcom	RG215	OATS2	E4622	13-Oct-14
117	Coax Cable	2m Black	Suhner	RG214HF/Nm/Nm/2000	TeltestBlack5	E4850	15-Oct-14
118	Coax Cable	2m Black	Suhner	RG214HF/Nm/Nm/2000	TeltestBlack6	E4849	16-Oct-14
134	Coax Cable	Reverb - 4.5m Multiflex 141	TeltestBlue6	MF 141	TeltestBlue6	E4843	16-Oct-14
135	Coax Cable	Reverb - 2m Multiflex 141	TeltestBlue5	MF 141	TeltestBlue5	E4844	16-Oct-14
136	Coax Cable	Reverb - 2m Multiflex 141	TeltestBlue4	MF 141	TeltestBlue4	E4845	15-Oct-14
137	Coax Cable	Reverb - 1m Multiflex 141	TeltestBlue3	MF 141	TeltestBlue3	E4846	17-Oct-14
138	Coax Cable	Reverb - 1m Multiflex 141	TeltestBlue2	MF 141	TeltestBlue2	E4847	17-Oct-14
139	Coax Cable	Reverb - 1m Multiflex 141	TeltestBlue1	MF 141	TeltestBlue1	E4848	17-Oct-14
18	Environ. Chamber	Chest	Contherm	Chest	E3397	E3397	2-Aug-15
19	Environ. Chamber	Chest	Contherm	Chest	E3397	E3397	5-Aug-14
90	Modulation Analyser	TREVA2	Hewlett Packard	HP8901B (Opt 002)	3704A05837	E3786	19-Oct-14
109	OATS	Antenna Tower	Electrometrics	EM-4720-2	112	E4447	
110	OATS	Controller	Electrometrics	EM-4700	119	E4445	
111	OATS	Turntable	Electrometrics	EM-4704A	105	E4446	
16	Oscilloscope	100MHz Digital	Tektronics	TDS340	B013611	E3585	16-Oct-14
28	Power Supply	TREVA2 60V/25A	Agilent	N5767A	US09F4901H	E4656	16-Oct-14
38	RF Amplifier	+21.7 dB 1GHz	Tait	ZFL-1000LN	E3660	E3360	16-Jan-15
150	RF Amplifier	Pre-amplifier	Agilent	87405C	MY47010688	E4941	18-Oct-14
48	RF Attenuator	10dB 50W	Weinschel	24-10-34	AZ0401	E3388	17-Oct-14
49	RF Attenuator	20dB 50W	Weinschel	24-20-44	AW1266	E3562	17-Oct-14
50	RF Attenuator	20dB 25W	Weinschel	33-20-33	BD5871	E3673	18-Oct-14
51	RF Attenuator	TREVA2 20dB 150W	Weinschel	40-20-33	CJ405	E3733	21-Oct-14
97	RF Attenuator	TREVA2 3dB	Weinschel	Model 1	BL9950	E4080	
35	RF Chamber	S-LINE TEM CELL	Rohde & Schwarz	1089.9296.02	338232/003	E3636	31-Aug-15
145	RF Chamber	Reverb - Stirrer controller for reverb chamber	Teseq	Stirrer Controller	29765.1	E4854	
146	RF Chamber	Reverb - 0.5 - 18GHz Reverberation Chamber	Teseq	RVC XS	29765	E4855	
101	RF Combiner	TREVA2	Minicircuits	ZFSC-4-1	-	E4084	
3	Signal Generator	Analog 4GHz	Agilent	E4422B	GB40050320	E3788	8-May-14
93	Signal Generator	TREVA2 Analog 3.3GHz	Rohde & Schwarz	SML03 1090.3000.13	100597	E4050	17-Oct-14
33	Spectrum Analyser	26.5GHz	Agilent	PXAN9030A	MY49432161	E4907	30-Mar-14
66	Spectrum Analyser	13.2GHz	Hewlett Packard	HP8562E	3821A00779	E3715	18-Oct-14
133	TREVA2		Teltest	-	2	-	23-Apr-14

NOTE: Items without calibration dates are calibrated immediately before use, or set using calibrated instruments.

ANNEX A – TEST SETUP DETAILS

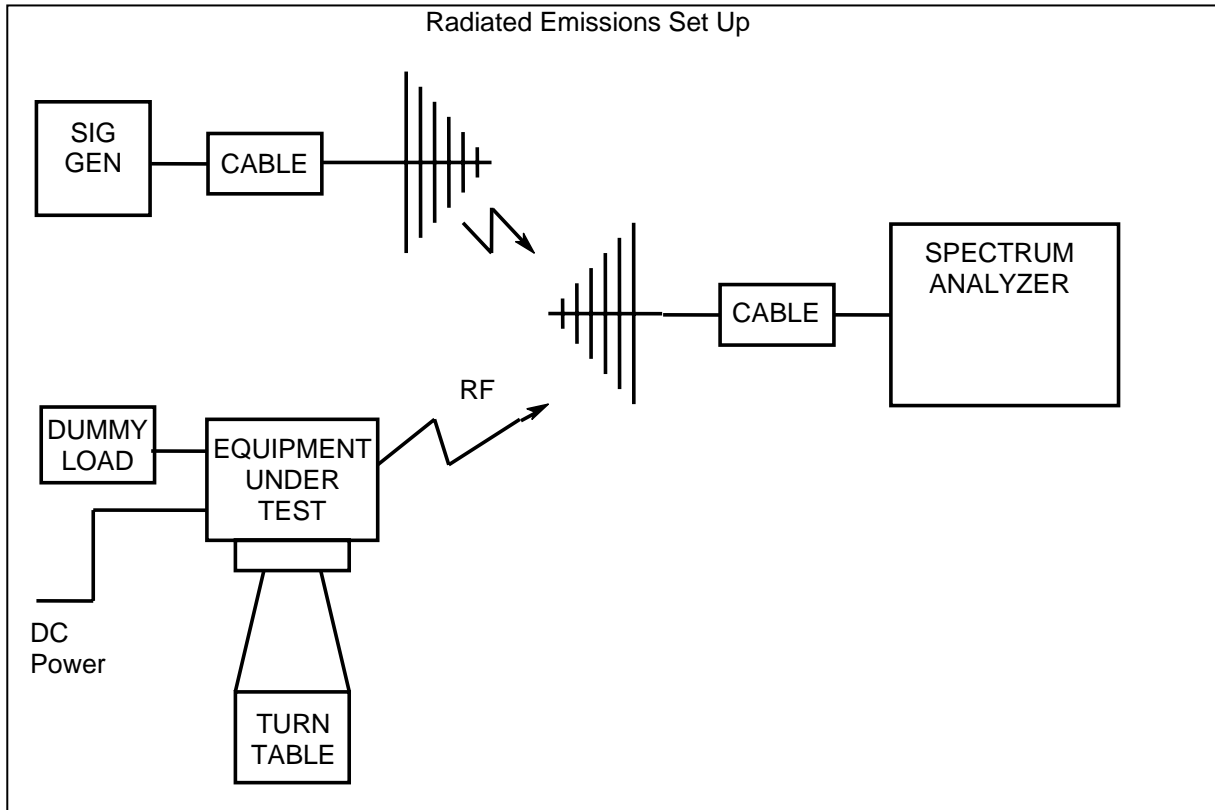

All other testing is performed using the Teltest Radio **EVAL**uation system (TREVA), which is configured as shown below. The Spectrum Analyser is connected to the EUT via the attenuator network for Conducted Emissions testing, and Occupied Bandwidth.

