

# RF Exposure Lab

802 N. Twin Oaks Valley Road, Suite 105 • San Marcos, CA 92069 • U.S.A.

TEL (760) 471-2100 • FAX (760) 471-2121

<http://www.rfexposurelab.com>

## CERTIFICATE OF COMPLIANCE SAR EVALUATION

Tait International LTD  
245 Wooldridge Road  
Christchurch 8051, New Zealand

Dates of Test: October 11-12, 2018  
Test Report Number: SAR.20181004

FCC ID:	CASTPDH5D
IC Certificate:	737A-TPDH5D
Model(s):	TPDH5D
Test Sample:	Engineering Unit Same as Production
Serial Number:	25695131
Equipment Type:	Push-To-Talk Handheld Radio for Occupational Use
Classification:	Portable Transmitter Next to Face and Body
TX Frequency Range:	406 – 470 MHz; 2402 – 2480 MHz
Frequency Tolerance:	± 0.5 ppm
Maximum RF Output:	450 MHz – 36.02 dBm; 2450 MHz – 12.04 dBm Conducted
Signal Modulation:	FM
Body Worn Accessories:	Model T03-00038-0005, T03-00038-0007, T03-00038-0009, T03-00038-0016, T03-00038-0017, T03-00038-0018, T03-00038-0021, T03-00038-0022, T03-00038-0023, T03-00038-0028, T03-00038-0033, T03-00038-0034, T03-00038-0037, TPA-CA-201, TPA-CA-208
Audio Accessories:	Model T03-00045-CFAA, T03-00045-DMAA, T03-00045-FRAA, T03-00046-EFAA, T03-00046-FAAA, T03-00046-GEAA, T03-00047-AAAA, T03-00047-CBAA, T03-00120-HAAE, T952-051
Antenna:	Model TPA-AN-011, TPA-AN-013
Battery:	Model T03-00011-AAAA, T03-00011-CAAA, T03-00011-DAAA
Application Type:	Certification
FCC Rule Parts:	Part 2, 90
KDB Test Methodology:	KDB 447498 D01 v06, KDB 643646 D01 v01r03, KDB 865664 D01 v01r04, KDB 865664 D02 v01r01
Industry Canada:	RSS-102 Issue 5, Safety Code 6
Maximum SAR Value:	2.41 W/kg for Face; 6.48 W/kg for Body Reported
Simultaneous SAR Value:	0.43 for Face; 0.94 for Body Limit Ratio
Separation Distance:	25 mm for Face; 0 mm for Body

This wireless mobile and/or portable device has been shown to be compliant for localized specific absorption rate (SAR) for uncontrolled environment/general exposure limits specified in ANSI/IEEE Std. C95.1-1992 and had been tested in accordance with the measurement procedures specified in IEEE 1528-2013 and EN/IEC 62209:2010 (See test report).

I attest to the accuracy of the data. All measurements were performed by myself or were made under my supervision and are correct to the best of my knowledge and belief. I assume full responsibility for the completeness of these measurements and vouch for the qualifications of all persons taking them.

RF Exposure Lab, LLC certifies that no party to this application is subject to a denial of Federal benefits that includes FCC benefits pursuant to Section 5301 of the Anti-Drug Abuse Act of 1988, 21 U.S.C. 853(a).



Jay M. Moulton  
Vice President



Testing Cert. # 2387.01

## Table of Contents

1.	Introduction .....	3
	SAR Definition [5].....	4
2.	SAR Measurement Setup.....	5
	Robotic System.....	5
	System Hardware.....	5
	System Electronics.....	6
	Probe Measurement System.....	6
3.	Probe and Dipole Calibration.....	14
4.	Phantom & Simulating Tissue Specifications.....	15
	Head & Body Simulating Mixture Characterization .....	15
5.	ANSI/IEEE C95.1 – 1992 RF Exposure Limits [2].....	16
	Uncontrolled Environment .....	16
	Controlled Environment.....	16
6.	Measurement Uncertainty .....	17
7.	System Validation.....	18
	Tissue Verification.....	18
	Test System Verification.....	18
8.	SAR Test Data Summary .....	19
	Procedures Used To Establish Test Signal .....	19
	Device Test Condition .....	19
	Radio Body Test .....	21
	Radio Body Test .....	23
	SAR Data Summary – Head SAR Face Measurements .....	28
	SAR Data Summary – Body SAR Measurements .....	29
	SAR Data Summary – Simultaneous Evaluation .....	30
9.	Test Equipment List.....	31
10.	Conclusion .....	32
11.	References.....	33
	Appendix A – System Validation Plots and Data .....	34
	Appendix B – SAR Test Data Plots .....	40
	Appendix C – SAR Test Setup Photos .....	43
	Appendix D – Probe Calibration Data Sheets.....	53
	Appendix E – Dipole Calibration Data Sheets .....	65
	Appendix F – Phantom Calibration Data Sheets .....	74
	Appendix G – Validation Summary.....	76

## 1. Introduction

This measurement report shows compliance of the Tait International LTD Model(s) TPDH5D FCC ID: CASTPDH5D with FCC Part 2, 1093, ET Docket 93-62 Rules for mobile and portable devices and IC Certificate: 737A-TPDH5D with RSS102 Issue 5 & Safety Code 6. The FCC have adopted the guidelines for evaluating the environmental effects of radio frequency radiation in ET Docket 93-62 on August 6, 1996 to protect the public and workers from the potential hazards of RF emissions due to FCC regulated portable devices. [1], [6]

The test results recorded herein are based on a single type test of Tait International LTD Model TPDH5D and therefore apply only to the tested sample.

The test procedures, as described in ANSI C95.1 – 1999 Standard for Safety Levels with Respect to Human Exposure to Radio Frequency Electromagnetic Fields, 3 kHz to 300 GHz [2], ANSI C95.3 – 2002 Recommended Practice for the Measurement of Potentially Hazardous Electromagnetic Fields [3], , IEEE Std.1528 – 2013 Recommended Practice [4], and Industry Canada Safety Code 6 Limits of Human Exposure to Radiofrequency Electromagnetic Fields in the Frequency Range from 3kHz to 300 GHz were employed.

The following table indicates all the wireless technologies operating in the Model TPDH5D PTT. The table also shows the tolerance for the power level for each mode.

Band	Technology	Class	Nominal Power dBm	Setpoint Nominal Power dBm	Tolerance dBm	Lower Tolerance dBm	Upper Tolerance dBm
450 MHz	FM	N/A	N/A	N/A	N/A	N/A	36.02
2450 MHz	Bluetooth	N/A	N/A	N/A	N/A	N/A	12.04

**SAR Definition [5]**

Specific Absorption Rate is defined as the time derivative (rate) of the incremental energy ( $dW$ ) absorbed by (dissipated in) an incremental mass ( $dm$ ) contained in a volume element ( $dV$ ) of a given density ( $\rho$ ).

$$SAR = \frac{d}{dt} \left( \frac{dW}{dm} \right) = \frac{d}{dt} \left( \frac{dW}{\rho dV} \right)$$

SAR is expressed in units of watts per kilogram (W/kg). SAR can be related to the electric field at a point by

$$SAR = \frac{\sigma |E|^2}{\rho}$$

where:

$\sigma$  = conductivity of the tissue (S/m)

$\rho$  = mass density of the tissue (kg/m<sup>3</sup>)

$E$  = rms electric field strength (V/m)

## 2. SAR Measurement Setup

### Robotic System

These measurements are performed using the DASY52 automated dosimetric assessment system. The DASY52 is made by Schmid & Partner Engineering AG (SPEAG) in Zurich, Switzerland and consists of high precision robotics system (Staubli), robot controller, Intel Core2 computer, near-field probe, probe alignment sensor, and the generic twin phantom containing the brain equivalent material. The robot is a six-axis industrial robot performing precise movements to position the probe to the location (points) of maximum electromagnetic field (EMF) (see Fig. 2.1).

### System Hardware

A cell controller system contains the power supply, robot controller teach pendant (Joystick), and a remote control used to drive the robot motors. The PC consists of the HP Intel Core2 computer with Windows XP system and SAR Measurement Software DASY52, A/D interface card, monitor, mouse, and keyboard. The Staubli Robot is connected to the cell controller to allow software manipulation of the robot. A data acquisition electronic (DAE) circuit that performs the signal amplification, signal multiplexing, AD-conversion, offset measurements, mechanical surface detection, collision detection, etc. is connected to the Electro-optical coupler (EOC). The EOC performs the conversion from the optical into digital electric signal of the DAE and transfers data to the PC plug-in card.

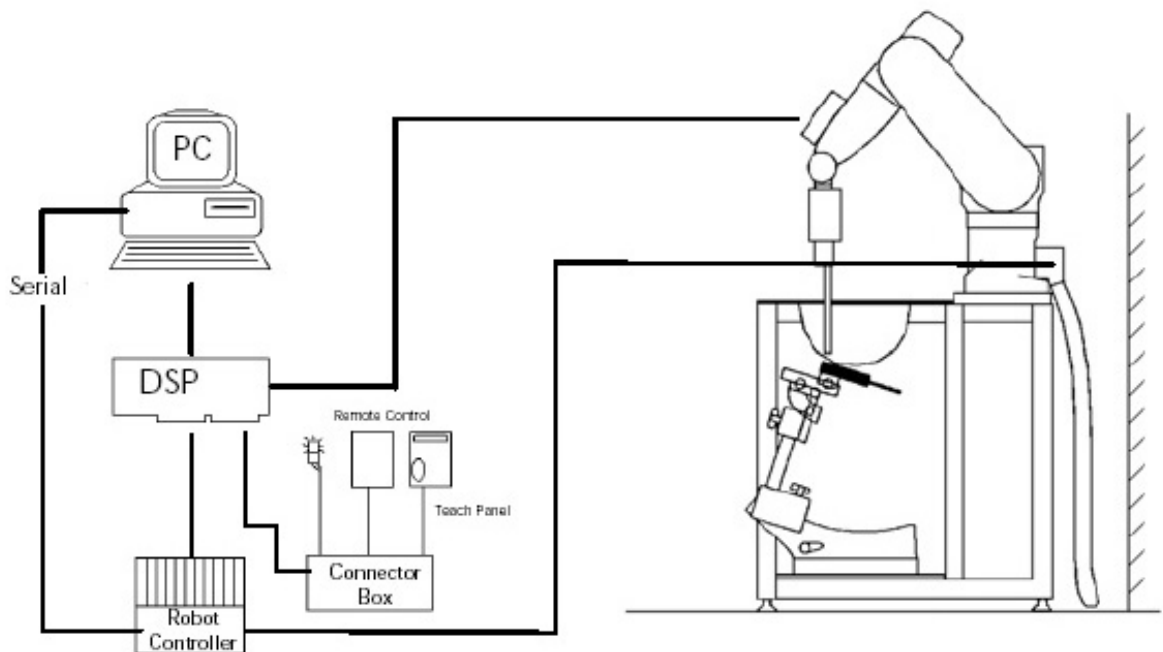

**Figure 2.1 SAR Measurement System Setup**

## System Electronics

The DAE4 consists of a highly sensitive electrometer-grade preamplifier with auto-zeroing, a channel and gain-switching multiplexer, a fast 16 bit AD-converter and a command decoder and control logic unit. Transmission to the PC-card is accomplished through an optical downlink for data and status information and an optical uplink for commands and clock lines. The mechanical probe mounting device includes two different sensor systems for frontal and sidewise probe contacts. They are also used for mechanical surface detection and probe collision detection. The robot uses its own controller with a built in VME-bus computer. The system is described in detail in.

## Probe Measurement System

The SAR measurements were conducted with the dosimetric probe ES3DV3, designed in the classical triangular configuration (see Fig. 2.2) and optimized for dosimetric evaluation. The probe is constructed using the thick film technique; with printed resistive lines on ceramic substrates. The probe is equipped with an optical multi fiber line ending at the front of the probe tip. (see Fig. 2.3) It is connected to the EOC box on the robot arm and provides an automatic detection of the phantom surface. Half of the fibers are connected to a pulsed infrared transmitter, the other half to a synchronized receiver. As the probe approaches the surface, the reflection from the surface produces a coupling from the transmitting to the receiving fibers. This reflection increases first during the approach, reaches maximum and then decreases. If the probe is flatly touching the surface, the coupling is zero. The distance of the coupling maximum to the surface is independent of the surface reflectivity and largely independent of the surface to probe angle. The DASY52 software reads the reflection during a software approach and looks for the maximum using a 2nd order fitting. The approach is stopped at reaching the maximum.



**DAE System**

**Probe Specifications**

**Calibration:** In air from 10 MHz to 6.0 GHz  
In brain and muscle simulating tissue at Frequencies of 450 MHz, 835 MHz, 1750 MHz, 1900 MHz, 2450 MHz, 2600 MHz, 3500 MHz, 5200 MHz, 5300 MHz, 5600 MHz, 5800 MHz

**Frequency:** 10 MHz to 6 GHz

**Linearity:**  $\pm 0.2$ dB (30 MHz to 6 GHz)

**Dynamic:** 10 mW/kg to 100 W/kg

**Range:** Linearity:  $\pm 0.2$ dB

**Dimensions:** Overall length: 330 mm

**Tip length:** 20 mm

**Body diameter:** 12 mm

**Tip diameter:** 2.5 mm

**Distance from probe tip to sensor center:** 1 mm

**Application:** SAR Dosimetry Testing  
Compliance tests of wireless device

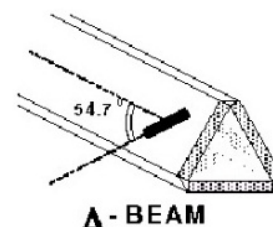

Figure 2.2 Triangular Probe Configurations



Figure 2.3 Probe Thick-Film Technique



## Probe Calibration Process

### Dosimetric Assessment Procedure

Each probe is calibrated according to a dosimetric assessment procedure described in with accuracy better than +/- 10%. The spherical isotropy was evaluated with the procedure described in and found to be better than +/-0.25dB. The sensitivity parameters (Norm X, Norm Y, Norm Z), the diode compression parameter (DCP) and the conversion factor (Conv F) of the probe is tested.

### Free Space Assessment

The free space E-field from amplified probe outputs is determined in a test chamber. This is performed in a TEM cell for frequencies below 1 GHz, and in a waveguide above 1GHz for free space. For the free space calibration, the probe is placed in the volumetric center of the cavity at the proper orientation with the field. The probe is then rotated 360 degrees until the three channels show the maximum reading. The power density readings equates to 1 mW/cm<sup>2</sup>.

### Temperature Assessment \*

E-field temperature correlation calibration is performed in a flat phantom filled with the appropriate simulated brain tissue. The measured free space E-field in the medium, correlates to temperature rise in a dielectric medium. For temperature correlation calibration a RF transparent thermistor based temperature probe is used in conjunction with the E-field probe

$$SAR = C \frac{\Delta T}{\Delta t}$$

$$SAR = \frac{|E|^2 \cdot \sigma}{\rho}$$

where:

where:

$\Delta t$  = exposure time (30 seconds),

$\sigma$  = simulated tissue conductivity,

C = heat capacity of tissue (brain or muscle),

$\rho$  = Tissue density (1.25 g/cm<sup>3</sup> for brain tissue)

$\Delta T$  = temperature increase due to RF exposure.

SAR is proportional to  $\Delta T / \Delta t$ , the initial rate of tissue heating, before thermal diffusion takes place.

Now it's possible to quantify the electric field in the simulated tissue by equating the thermally derived SAR to the E- field;

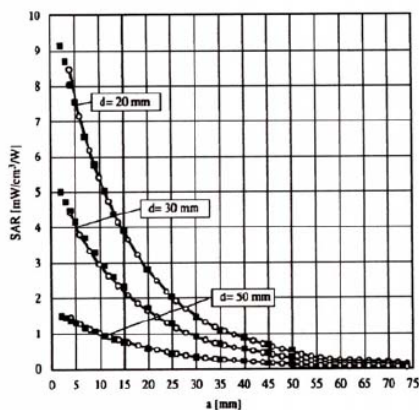

**Figure 2.4 E-Field and Temperature Measurements at 900MHz**



**Figure 2.5 E-Field and Temperature Measurements at 1800MHz**



## Data Extrapolation

The DASY52 software automatically executes the following procedures to calculate the field units from the microvolt readings at the probe connector. The first step of the evaluation is a linearization of the filtered input signal to account for the compression characteristics of the detector diode. The compensation depends on the input signal, the diode type and the DC-transmission factor from the diode to the evaluation electronics. If the exciting field is pulsed, the crest factor of the signal must be known to correctly compensate for peak power. The formula for each channel can be given like below;

$$V_i = U_i + U_i^2 \cdot \frac{cf}{dcp_i}$$

with  $V_i$  = compensated signal of channel i (i=x,y,z)  
 $U_i$  = input signal of channel i (i=x,y,z)  
 $cf$  = crest factor of exciting field (DASY parameter)  
 $dcp_i$  = diode compression point (DASY parameter)

From the compensated input signals the primary field data for each channel can be evaluated:

E-field probes:

$$E_i = \sqrt{\frac{V_i}{Norm_i \cdot ConvF}}$$

with  $V_i$  = compensated signal of channel i (i = x,y,z)  
 $Norm_i$  = sensor sensitivity of channel i (i = x,y,z)  
 $\mu V/(V/m)^2$  for E-field probes  
 $ConvF$  = sensitivity of enhancement in solution  
 $E_i$  = electric field strength of channel i in V/m

The RSS value of the field components gives the total field strength (Hermetian magnitude):

$$E_{tot} = \sqrt{E_x^2 + E_y^2 + E_z^2}$$

The primary field data are used to calculate the derived field units.

$$SAR = E_{tot}^2 \cdot \frac{\sigma}{\rho \cdot 1000}$$

with SAR = local specific absorption rate in W/g  
 $E_{tot}$  = total field strength in V/m  
 $\sigma$  = conductivity in [mho/m] or [Siemens/m]  
 $\rho$  = equivalent tissue density in g/cm<sup>3</sup>

The power flow density is calculated assuming the excitation field to be a free space field.

$$P_{free} = \frac{E_{tot}^2}{3770}$$

with  $P_{pwe}$  = equivalent power density of a plane wave in W/cm<sup>2</sup>  
 $E_{tot}$  = total electric field strength in V/m

## Scanning procedure

- The DASY installation includes predefined files with recommended procedures for measurements and system check. They are read-only document files and destined as fully defined but unmeasured masks. All test positions (head or body-worn) are tested with the same configuration of test steps differing only in the grid definition for the different test positions.
- The „reference“ and „drift“ measurements are located at the beginning and end of the batch process. They measure the field drift at one single point in the liquid over the complete procedure. The indicated drift is mainly the variation of the DUT's output power and should vary max. +/- 5 %.
- The highest integrated SAR value is the main concern in compliance test applications. These values can mostly be found at the inner surface of the phantom and cannot be measured directly due to the sensor offset in the probe. To extrapolate the surface values, the measurement distances to the surface must be known accurately. A distance error of 0.5mm could produce SAR errors of 6% at 1800 MHz. Using predefined locations for measurements is not accurate enough. Any shift of the phantom (e.g., slight deformations after filling it with liquid) would produce high uncertainties. For an automatic and accurate detection of the phantom surface, the DASY5 system uses the mechanical surface detection. The detection is always at touch, but the probe will move backward from the surface the indicated distance before starting the measurement.
- The „area scan“ measures the SAR above the DUT or verification dipole on a parallel plane to the surface. It is used to locate the approximate location of the peak SAR with 2D spline interpolation. The robot performs a stepped movement along one grid axis while the local electrical field strength is measured by the probe. The probe is touching the surface of the SAM during acquisition of measurement values. The scan uses different grid spacings for different frequency measurements. Standard grid spacing for head measurements in frequency ranges  $\leq 2$ GHz is 15 mm in x - and y- dimension. For higher frequencies a finer resolution is needed, thus for the grid spacing is reduced according the following table:

Area scan grid spacing for different frequency ranges	
Frequency range	Grid spacing
$\leq 2$ GHz	$\leq 15$ mm
2 – 4 GHz	$\leq 12$ mm
4 – 6 GHz	$\leq 10$ mm

Grid spacing and orientation have no influence on the SAR result. For special applications where the standard scan method does not find the peak SAR within the grid, e.g. mobile phones with flip cover, the grid can be adapted in orientation. Results of this coarse scan are shown in annex B.

- A „zoom scan“ measures the field in a volume around the 2D peak SAR value acquired in the previous „coarse“ scan. It uses a fine meshed grid where the robot moves the probe in steps along all the 3 axis (x,y and z-axis) starting at the bottom of the Phantom. The grid spacing for the cube measurement is varied according to the measured frequency range, the dimensions are given in the following table:

<b>Zoom scan grid spacing and volume for different frequency ranges</b>			
Frequency range	Grid spacing for x, y axis	Grid spacing for z axis	Minimum zoom scan volume
≤ 2 GHz	≤ 8 mm	≤ 5 mm	≥ 30 mm
2 – 3 GHz	≤ 5 mm	≤ 5 mm	≥ 28 mm
3 – 4 GHz	≤ 5 mm	≤ 4 mm	≥ 28 mm
4 – 5 GHz	≤ 4 mm	≤ 3 mm	≥ 25 mm
5 – 6 GHz	≤ 4 mm	≤ 2 mm	≥ 22 mm

DASY is also able to perform repeated zoom scans if more than 1 peak is found during area scan. In this document, the evaluated peak 1g and 10g averaged SAR values are shown in the 2D-graphics in annex B. Test results relevant for the specified standard (see section 3) are shown in table form in section 7.

## Spatial Peak SAR Evaluation

The spatial peak SAR - value for 1 and 10 g is evaluated after the Cube measurements have been done. The basis of the evaluation are the SAR values measured at the points of the fine cube grid consisting of all points in the three directions x, y and z. The algorithm that finds the maximal averaged volume is separated into three different stages.

- The data between the dipole center of the probe and the surface of the phantom are extrapolated. This data cannot be measured since the center of the dipole is 1 to 2.7 mm away from the tip of the probe and the distance between the surface and the lowest measuring point is about 1 mm (see probe calibration sheet). The extrapolated data from a cube measurement can be visualized by selecting 'Graph Evaluated'.
- The maximum interpolated value is searched with a straight-forward algorithm. Around this maximum the SAR - values averaged over the spatial volumes (1g or 10 g) are computed using the 3d-spline interpolation algorithm. If the volume cannot be evaluated (i.e., if a part of the grid was cut off by the boundary of the measurement area) the evaluation will be started on the corners of the bottom plane of the cube.
- All neighbouring volumes are evaluated until no neighbouring volume with a higher average value is found.

## Extrapolation

The extrapolation is based on a least square algorithm [W. Gander, Computermathematik, p.168-180]. Through the points in the first 3 cm along the z-axis, polynomials of order four are calculated. These polynomials are then used to evaluate the points between the surface and the probe tip. The points, calculated from the surface, have a distance of 1 mm from each other.

## Interpolation

The interpolation of the points is done with a 3d-Spline. The 3d-Spline is composed of three one-dimensional splines with the "Not a knot"-condition [W. Gander, Computermathematik, p.141-150] (x, y and z -direction) [Numerical Recipes in C, Second Edition, p.123ff ].

## Volume Averaging

At First the size of the cube is calculated. Then the volume is integrated with the trapezoidal algorithm. 8000 points (20x20x20) are interpolated to calculate the average.

## Advanced Extrapolation

DASY uses the advanced extrapolation option which is able to compensate boundary effects on E-field probes.

**SAM PHANTOM**

The SAM Twin Phantom V4.0 is constructed of a fiberglass shell integrated in a wooden table. The shape of the shell is based on data from an anatomical study designed to determine the maximum exposure in at least 90% of all users. It enables the dosimetric evaluation of left and right hand phone usage as well as body mounted usage at the flat phantom region. A cover prevents the evaporation of the liquid. Reference markings on the Phantom allow the complete setup of all predefined phantom positions and measurement grids by manually teaching three points in the robot. (see Fig. 2.6)

**Phantom Specification**

**Phantom:** SAM Twin Phantom (V4.0)  
**Shell Material:** Vivac Composite  
**Thickness:**  $2.0 \pm 0.2$  mm

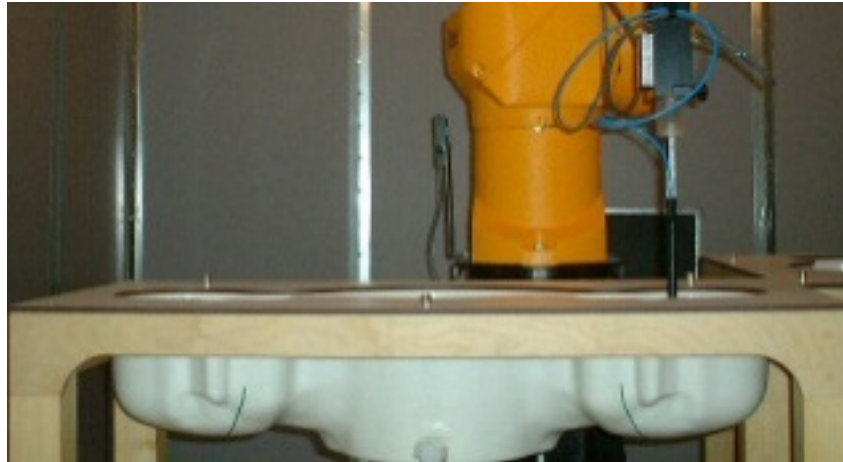

**Figure 2.6 SAM Twin Phantom**

**Device Holder for Transmitters**

In combination with the SAM Twin Phantom V4.0 the Mounting Device (see Fig. 2.7), enables the rotation of the mounted transmitter in spherical coordinates whereby the rotation point is the ear opening. The devices can be easily, accurately, and repeatedly positioned according to the FCC, CENELEC, IEC and IEEE specifications. The device holder can be locked at different phantom locations (left head, right head, flat phantom).



**Figure 2.7 Mounting Device**

Note: A simulating human hand is not used due to the complex anatomical and geometrical structure of the hand that may produce infinite number of configurations. To produce the worst-case condition (the hand absorbs antenna output power), the hand is omitted during the tests.

### **3. Probe and Dipole Calibration**

**See Appendix D and E.**

## 4. Phantom & Simulating Tissue Specifications

### Head & Body Simulating Mixture Characterization

The head and body mixtures consist of the material based on the table listed below. The mixture is calibrated to obtain proper dielectric constant (permittivity) and conductivity of the desired tissue. Body tissue parameters that have not been specified in IEEE1528-2013 are derived from the issue dielectric parameters computed from the 4-Cole-Cole equations.

**Table 4.1 Typical Composition of Ingredients for Tissue**

Ingredients		Simulating Tissue	
		450 MHz Head	450 MHz Body
Mixing Percentage			
Water		38.56	51.16
Sugar		56.32	46.78
Salt		3.95	1.49
HEC		0.98	0.52
Bactericide		0.19	0.05
DGBE		0.00	0.00
Dielectric Constant	Target	43.50	56.70
Conductivity (S/m)	Target	0.87	0.94



## 5. ANSI/IEEE C95.1 – 1992 RF Exposure Limits [2]

### Uncontrolled Environment

Uncontrolled Environments are defined as locations where there is the exposure of individuals who have no knowledge or control of their exposure. The general population/uncontrolled exposure limits are applicable to situations in which the general public may be exposed or in which persons who are exposed as a consequence of their employment may not be made fully aware of the potential for exposure or cannot exercise control over their exposure. Members of the general public would come under this category when exposure is not employment-related; for example, in the case of a wireless transmitter that exposes persons in its vicinity.

### Controlled Environment

Controlled Environments are defined as locations where there is exposure that may be incurred by persons who are aware of the potential for exposure, (i.e. as a result of employment or occupation). In general, occupational/controlled exposure limits are applicable to situations in which persons are exposed as a consequence of their employment, who have been made fully aware of the potential for exposure and can exercise control over their exposure. This exposure category is also applicable when the exposure is of a transient nature due to incidental passage through a location where the exposure levels may be higher than the general population/uncontrolled limits, but the exposed person is fully aware of the potential for exposure and can exercise control over his or her exposure by leaving the area or by some other appropriate means.

**Table 5.1 Human Exposure Limits**

	UNCONTROLLED ENVIRONMENT General Population (W/kg) or (mW/g)	CONTROLLED ENVIROMENT Professional Population (W/kg) or (mW/g)
SPATIAL PEAK SAR <sup>1</sup> Head	1.60	8.00
SPATIAL AVERAGE SAR <sup>2</sup> Whole Body	0.08	0.40
SPATIAL PEAK SAR <sup>3</sup> Hands, Feet, Ankles, Wrists	4.00	20.00

<sup>1</sup> The Spatial Peak value of the SAR averaged over any 1 gram of tissue (defined as a tissue volume in the shape of a cube) and over the appropriate averaging time.

<sup>2</sup> The Spatial Average value of the SAR averaged over the whole body.

<sup>3</sup> The Spatial Peak value of the SAR averaged over any 10 grams of tissue (defined as a tissue volume in the shape of a cube) and over the appropriate averaging time.

## 6. Measurement Uncertainty

Measurement uncertainty table is not required per KDB 865664 D01 v01r04 section 2.8.2 page 12. SAR measurement uncertainty analysis is required in the SAR report only when the highest measured SAR in a frequency band is  $\geq 1.5$  W/kg for 1-g SAR. The equivalent ratio (1.5/1.6) should be applied to extremity and occupational exposure conditions. The highest reported value is less than 1.5 W/kg. Therefore, the measurement uncertainty table is not required.

## 7. System Validation

### Tissue Verification

**Table 7.1 Measured Tissue Parameters**

		450 MHz Head		450 MHz Body	
Date(s)		Oct. 12, 2018		Oct. 11, 2018	
Liquid Temperature (°C)	20.0	Target	Measured	Target	Measured
Dielectric Constant: $\epsilon$		43.50	43.55	56.70	56.66
Conductivity: $\sigma$		0.87	0.88	0.94	0.93

See Appendix A for data printout.

### Test System Verification

Prior to assessment, the system is verified to the  $\pm 10\%$  of the specifications at the test frequency by using the system kit. Power is normalized to 1 watt. (Graphic Plots Attached,  $P_{IN}=100$  mW)

**Table 7.2 System Dipole Validation Target & Measured**

	Test Frequency	Targeted SAR <sub>1g</sub> (W/kg)	Measure SAR <sub>1g</sub> (W/kg)	Tissue Used for Verification	Deviation (%)	Plot
12-Oct-2018	450 MHz	4.50	4.55	Head	+ 1.11	1
11-Oct-2018	450 MHz	4.53	4.57	Body	+ 0.88	2

See Appendix A for data plots.

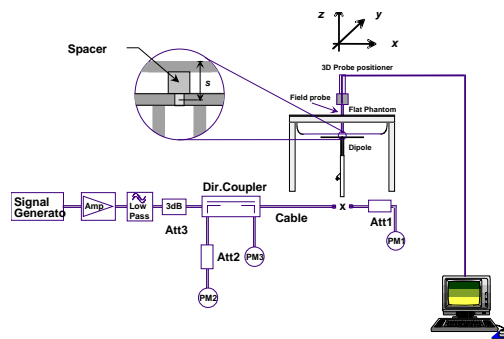

**Figure 7.1 Dipole Validation Test Setup**

## 8. SAR Test Data Summary

### See Measurement Result Data Pages

See Appendix B for SAR Test Data Plots.  
See Appendix C for SAR Test Setup Photos.

### Procedures Used To Establish Test Signal

The device was either placed into simulated transmit mode using the manufacturer's test codes or the actual transmission is activated through a base station simulator or similar equipment. See data pages for actual procedure used in measurement.

### Device Test Condition

The power drift of each test is measured at the start of the test and again at the end of the test. The drift is calculated returned in dBs. The drift is calculated into the resultant SAR value on the data sheet for each test.

The TPDH5D was tested in the face position with the front of the device 25 mm away from the flat phantom. The TPDH5D was then tested in the body position with the body accessory in contact with the flat phantom. The audio accessory (T03-00045-FRAA) was used for all body measurements. All other audio accessories have been excluded per KDB 643646 D01 v01r03 section A2. All the audio accessories are 50 ohm connections to the radio and the standard audio accessory was used for all measurements next to the body per KDB 643646 D01 v01r03 section A2. For each of the tests conducted, the device was set to continuously transmit at a maximum output power on the channel specified in the test data. The SAR was scaled to 50% duty cycle per KDB 643646 D01 v01r03. All test reductions were reduced based on the reductions in KDB 643646 D01 v01r03. See pages 26-27 for a table of test reductions.

The Bluetooth testing was excluded from SAR testing due to the low power of the transmitter. For the FCC, the exclusion was based on the calculation in KDB447498 v06 section 4.3.1 a). The following is the formula for the Bluetooth transmitter.

$$[(16 \text{ mW})/(17 \text{ mm})]^* \sqrt{2.48} = 1.48 \text{ which is equal to or less than } 3.0$$

For ISED, the exclusion is based on RSS-102 Issue 5 section 2.5.1 table 1. For devices evaluated to the controlled environment limit of 8.0 W/kg, the numbers in the table are multiplied by 5. Therefore, for a separation distance of 15 mm in the table, the exclusion limit is  $(15 \text{ mW} * 5) = 75 \text{ mW}$ . The Bluetooth transmitter has a maximum transmit power of 16 mW which is below the 75 mW threshold.

Battery B and Battery C are identical batteries. The only difference is the manufacturer is different for each part number. Therefore, the testing was conducted with the two batteries interchanged.

Accessory	Description	Part Number
Battery A	Li-Ion, 1880 mAh	T03-00011-AAAA
Battery B	Li-Ion, 2400 mAh	T03-00011-CAAA
Battery C	Li-Ion, 2400 mAh	T03-00011-DAAA
Antenna A	¼ Wave Whip (400-470 MHz)	TPA-AN-011
Antenna B	Helical (400-470 MHz)	TPA-AN-013
Audio Accessory A	Spkr Mic Storm IP68 E-Button 2.5mm-Jack	T03-00045-CFAA
Audio Accessory B	Spkr Mic Genesis IP68 E-Button	T03-00045-DMAA
Audio Accessory C	Spkr Mic Medium-Weight	T03-00045-FRAA
Audio Accessory D	Headset Behind-Head Boom-Mic Finger	T03-00046-EFAA
Audio Accessory E	Headset Heavy-Duty Overhead	T03-00046-FAAA
Audio Accessory F	Headset Hurricane II Behind Head	T03-00046-GEAA
Audio Accessory G	Wire Surveillance Kit	T03-00047-AAAA
Audio Accessory H	Covert Kit Earhook Lapel Mic	T03-00047-CBAA
Audio Accessory I	Earphone Transparent D-Ring Hi-Vol	T03-00120-HAAE
Audio Accessory J	Earphone In-Ear	T952-051
Body Worn Accessory A	Belt Clip 55mm	TPA-CA-201
Body Worn Accessory B	Belt Loop for D-Clip 75mm	TPA-CA-208
Body Worn Accessory C	Carry Case Heavy Duty Leather 4Key Spring Clip	T03-00038-0005
Body Worn Accessory D	Carry Case Heavy Duty Leather 16Key D-Stud Belt Loop	T03-00038-0007
Body Worn Accessory E	Carry Case Heavy Duty Leather 16Key Belt Loop	T03-00038-0009
Body Worn Accessory F	Carry Case Nylon 16Key D-Stud Belt Loop	T03-00038-0016
Body Worn Accessory G	Carry Case Nylon 16Key Belt Loop	T03-00038-0017
Body Worn Accessory H	Carry Case Nylon 16Key Use Battery Clip	T03-00038-0018
Body Worn Accessory I	Carry Case Soft Leather 16Key Use Battery Clip	T03-00038-0021
Body Worn Accessory J	Belt Loop for D-Stud 55mm	T03-00038-0022
Body Worn Accessory K	Spring Clip for D-Stud 40mm	T03-00038-0023
Body Worn Accessory L	Carry Case Nylon 4Key D-Stud Chest Harness	T03-00038-0028
Body Worn Accessory M	Carry Case Polyester Green 16Key Use Battery Clip	T03-00038-0033
Body Worn Accessory N	Shoulder Strap Carry Case Heavy Duty Leather	T03-00038-0034
Body Worn Accessory O	Carry Case Heavy Duty Leather 16Key Belt Loop D-rings	T03-00038-0037

Audio Accessory C was chosen for the testing body worn radio configuration. Audio Accessory A-B and D-J are excluded. The following tables shows all combinations with the tested combination marked yes.

### Radio Face Test

Antenna A		Antenna B	
Battery A	Battery B/C	Battery A	Battery B/C
Yes	Yes	Yes	Yes

### Radio Body Test

Audio Accessory	Antenna A							
	Audio Accessory A		Audio Accessory B		Audio Accessory C		Audio Accessory D	
	Bat A	Bat B/C	Bat A	Bat B/C	Bat A	Bat B/C	Bat A	Bat B/C
Body Worn A	No	No	No	No	Yes	Yes	No	No
Body Worn B	No	No	No	No	No	No	No	No
Body Worn C	No	No	No	No	No	No	No	No
Body Worn D	No	No	No	No	No	No	No	No
Body Worn E	No	No	No	No	Yes	Yes	No	No
Body Worn F	No	No	No	No	No	No	No	No
Body Worn G	No	No	No	No	No	No	No	No
Body Worn H	No	No	No	No	No	No	No	No
Body Worn I	No	No	No	No	No	No	No	No
Body Worn J	No	No	No	No	No	No	No	No
Body Worn K	No	No	No	No	No	No	No	No
Body Worn L	No	No	No	No	No	No	No	No
Body Worn M	No	No	No	No	No	No	No	No
Body Worn N	No	No	No	No	No	No	No	No
Body Worn O	No	No	No	No	No	No	No	No

Audio Accessory	Antenna A							
	Audio Accessory E		Audio Accessory F		Audio Accessory G		Audio Accessory H	
	Bat A	Bat B/C	Bat A	Bat B/C	Bat A	Bat B/C	Bat A	Bat B/C
Body Worn A	No	No	No	No	No	No	No	No
Body Worn B	No	No	No	No	No	No	No	No
Body Worn C	No	No	No	No	No	No	No	No
Body Worn D	No	No	No	No	No	No	No	No
Body Worn E	No	No	No	No	No	No	No	No
Body Worn F	No	No	No	No	No	No	No	No
Body Worn G	No	No	No	No	No	No	No	No
Body Worn H	No	No	No	No	No	No	No	No
Body Worn I	No	No	No	No	No	No	No	No
Body Worn J	No	No	No	No	No	No	No	No
Body Worn K	No	No	No	No	No	No	No	No
Body Worn L	No	No	No	No	No	No	No	No
Body Worn M	No	No	No	No	No	No	No	No
Body Worn N	No	No	No	No	No	No	No	No
Body Worn O	No	No	No	No	No	No	No	No

Audio Accessory	Antenna A			
	Audio Accessory I		Audio Accessory J	
	Bat A	Bat B/C	Bat A	Bat B/C
Body Worn A	No	No	No	No
Body Worn B	No	No	No	No
Body Worn C	No	No	No	No
Body Worn D	No	No	No	No
Body Worn E	No	No	No	No
Body Worn F	No	No	No	No
Body Worn G	No	No	No	No
Body Worn H	No	No	No	No
Body Worn I	No	No	No	No
Body Worn J	No	No	No	No
Body Worn K	No	No	No	No
Body Worn L	No	No	No	No
Body Worn M	No	No	No	No
Body Worn N	No	No	No	No
Body Worn O	No	No	No	No



### Radio Body Test

Audio Accessory	Antenna B							
	Audio Accessory A		Audio Accessory B		Audio Accessory C		Audio Accessory D	
	Bat A	Bat B/C	Bat A	Bat B/C	Bat A	Bat B/C	Bat A	Bat B/C
Body Worn A	No	No	No	No	Yes	Yes	No	No
Body Worn B	No	No	No	No	No	No	No	No
Body Worn C	No	No	No	No	No	No	No	No
Body Worn D	No	No	No	No	No	No	No	No
Body Worn E	No	No	No	No	Yes	Yes	No	No
Body Worn F	No	No	No	No	No	No	No	No
Body Worn G	No	No	No	No	No	No	No	No
Body Worn H	No	No	No	No	No	No	No	No
Body Worn I	No	No	No	No	No	No	No	No
Body Worn J	No	No	No	No	No	No	No	No
Body Worn K	No	No	No	No	No	No	No	No
Body Worn L	No	No	No	No	No	No	No	No
Body Worn M	No	No	No	No	No	No	No	No
Body Worn N	No	No	No	No	No	No	No	No
Body Worn O	No	No	No	No	No	No	No	No

Audio Accessory	Antenna B							
	Audio Accessory E		Audio Accessory F		Audio Accessory G		Audio Accessory H	
	Bat A	Bat B/C	Bat A	Bat B/C	Bat A	Bat B/C	Bat A	Bat B/C
Body Worn A	No	No	No	No	No	No	No	No
Body Worn B	No	No	No	No	No	No	No	No
Body Worn C	No	No	No	No	No	No	No	No
Body Worn D	No	No	No	No	No	No	No	No
Body Worn E	No	No	No	No	No	No	No	No
Body Worn F	No	No	No	No	No	No	No	No
Body Worn G	No	No	No	No	No	No	No	No
Body Worn H	No	No	No	No	No	No	No	No
Body Worn I	No	No	No	No	No	No	No	No
Body Worn J	No	No	No	No	No	No	No	No
Body Worn K	No	No	No	No	No	No	No	No
Body Worn L	No	No	No	No	No	No	No	No
Body Worn M	No	No	No	No	No	No	No	No
Body Worn N	No	No	No	No	No	No	No	No
Body Worn O	No	No	No	No	No	No	No	No

Audio Accessory	Antenna B			
	Audio Accessory I		Audio Accessory J	
	Bat A	Bat B/C	Bat A	Bat B/C
Body Worn A	No	No	No	No
Body Worn B	No	No	No	No
Body Worn C	No	No	No	No
Body Worn D	No	No	No	No
Body Worn E	No	No	No	No
Body Worn F	No	No	No	No
Body Worn G	No	No	No	No
Body Worn H	No	No	No	No
Body Worn I	No	No	No	No
Body Worn J	No	No	No	No
Body Worn K	No	No	No	No
Body Worn L	No	No	No	No
Body Worn M	No	No	No	No
Body Worn N	No	No	No	No
Body Worn O	No	No	No	No

UHF		
Freq	Channel	Power (dB)
406.1	1	35.45
422.1	2	35.49
438.1	3	35.54
454.1	4	35.52
469.9	5	35.47

Per KDB 447498 D01 v06 page 7 section 6) pages 7-8, the number of channels required to be tested is as follows:

$F_{high} = 470$  MHz

$F_c = 438$  MHz

$F_{low} = 406$  MHz

$N_c = \text{Round} \{ [100(f_{high} - f_{low})/f_c]^{0.5} \times (f_c/100)^{0.2} \} = \text{Round} \{ [100(470-406)/438]^{0.5} \times (438/100)^{0.2} \} = 5$

Therefore, for the frequency band from 406 MHz to 470 MHz, 5 channels are required for testing.

Band	Mode	Channel	Frequency (MHz)	Data Rate	Avg Power (dBm)	Tune-up Pwr (dBm)
2450 MHz	Bluetooth	0	2402	Basic Rate GFSK	11.36	12.04
		39	2441		11.52	12.04
		78	2480		11.49	12.04

Head SAR – In Front of Face (Handset)					
Antenna	Channel Freq. (MHz)	Battery A <sup>1</sup>		Battery B/C <sup>1</sup>	
		Measured Power (dBm)	Reported SAR (W/kg)	Measured Power (dBm)	Reported SAR (W/kg)
A <sup>1</sup> 400 – 470 MHz	406.1	35.45	<sup>2</sup>	35.45	<sup>2</sup>
	422.1	35.49	<sup>2</sup>	35.49	<sup>2</sup>
	438.1	34.54	2.27	34.54	2.41
	454.1	35.52	<sup>2</sup>	35.52	<sup>2</sup>
	469.9	35.47	<sup>2</sup>	35.47	<sup>2</sup>
B <sup>1</sup> 400 – 470 MHz	406.1	35.45	<sup>2</sup>	35.45	<sup>2</sup>
	422.1	35.49	<sup>2</sup>	35.49	<sup>2</sup>
	438.1	34.54	2.22	34.54	2.22
	454.1	35.52	<sup>2</sup>	35.52	<sup>2</sup>
	469.9	35.47	<sup>2</sup>	35.47	<sup>2</sup>

<sup>1</sup>See Accessory table on page 20 of this report.

<sup>2</sup>Measurement was reduced.

Body SAR (Handset)					
Antenna	Channel Freq. (MHz)	Battery A <sup>1</sup>			
		Audio Accessory C <sup>1</sup>			
		Body Worn E <sup>1</sup>		Body Worn A <sup>1</sup>	
		Measured Power (dBm)	Reported SAR (W/kg)	Measured Power (dBm)	Reported SAR (W/kg)
A <sup>1</sup> 400 – 470 MHz	406.1	35.45	6.48	35.45	5.02
	422.1	35.49	5.10	35.49	4.51
	438.1	34.54	4.61	34.54	4.20
	454.1	35.52	5.35	35.52	4.85
	469.9	35.47	4.46	35.47	4.05
B <sup>1</sup> 400 – 470 MHz	406.1	35.45	<sup>2</sup>	35.45	<sup>2</sup>
	422.1	35.49	<sup>2</sup>	35.49	<sup>2</sup>
	438.1	34.54	3.43	34.54	2.97
	454.1	35.52	<sup>2</sup>	35.52	<sup>2</sup>
	469.9	35.47	<sup>2</sup>	35.47	<sup>2</sup>

<sup>1</sup>See Accessory table on page 20 of this report.

<sup>2</sup>Measurement was reduced.

Body SAR (Handset)					
Antenna	Channel Freq. (MHz)	Battery B/C <sup>1</sup>			
		Audio Accessory C <sup>1</sup>			
		Body Worn E <sup>1</sup>		Body Worn A <sup>1</sup>	
		Measured Power (dBm)	Reported SAR (W/kg)	Measured Power (dBm)	Reported SAR (W/kg)
A <sup>1</sup> 400 – 470 MHz	406.1	35.45	6.46	35.45	<sup>2</sup>
	422.1	35.49	4.67	35.49	<sup>2</sup>
	438.1	34.54	4.29	34.54	3.47
	454.1	35.52	5.80	35.52	<sup>2</sup>
	469.9	35.47	4.17	35.47	<sup>2</sup>
B <sup>1</sup> 400 – 470 MHz	406.1	35.45	<sup>2</sup>	35.45	<sup>2</sup>
	422.1	35.49	<sup>2</sup>	35.49	<sup>2</sup>
	438.1	34.54	3.26	34.54	2.38
	454.1	35.52	<sup>2</sup>	35.52	<sup>2</sup>
	469.9	35.47	<sup>2</sup>	35.47	<sup>2</sup>

<sup>1</sup>See Accessory table on page 20 of this report.

<sup>2</sup>Measurement was reduced.

**SAR Data Summary – Head SAR Face Measurements**

**MEASUREMENT RESULTS**

Gap	Plot	Conf.	Battery	Frequency		Mod.	Ant.	End Power (dBm)	Drift (dB)	Measured SAR (W/kg)	Adjusted SAR (W/kg)	SAR (W/kg) 50% Duty Cycle
				MHz	Ch.							
25 mm	-----	Radio	A	438.1	3	FM	A	35.54	-0.22	3.86	4.54	2.27
	-----			438.1	3	FM	B	35.54	-0.25	3.76	4.45	2.22
	1		B/C	438.1	3	FM	A	35.54	-0.24	4.08	4.82	2.41
	-----			438.1	3	FM	B	35.54	-0.15	3.84	4.44	2.22

**Head**  
**8.0 W/kg (mW/g)**  
 averaged over 1 gram

1. Battery is fully charged for all tests.  
 Power Measured  Conducted  ERP  EIRP
2. SAR Measurement  
 Phantom Configuration  Left Head  Eli4  Right Head  
 SAR Configuration  Head  Body
3. Test Signal Call Mode  Test Code  Base Station Simulator
4. Test Configuration  With Belt Clip  Without Belt Clip  N/A
5. Tissue Depth is at least 15.0 cm



Jay M. Moulton  
 Vice President

The adjusted SAR value was calculated by first scaling the SAR value up by the drift. This value was then scaled up based on the difference of the upper end of the tolerance (36.02 dB) and the measured conducted power. The resultant value is then multiplied by 0.5 to give the SAR value at 50% duty cycle.

**SAR Data Summary – Body SAR Measurements**

**MEASUREMENT RESULTS**

Gap	Plot	Body Worn Acc.	Battery	Frequency		Mod.	Ant.	End Power (dBm)	Drift (dB)	Measured SAR (W/kg)	Adjusted SAR (W/kg)	SAR (W/kg) 50% Duty Cycle
				MHz	Ch.							
0 mm	2	E	A	406.1	1	FM	A	35.45	-0.26	10.70	12.95	6.48
	-----			422.1	2	FM		35.49	-0.21	8.61	10.21	5.10
	-----			438.1	3	FM		35.54	-0.24	7.81	9.22	4.61
	-----			454.1	4	FM		35.52	-0.22	9.07	10.71	5.35
	-----			469.9	5	FM		35.47	-0.23	7.46	8.93	4.46
	-----			438.1	3	FM		B	35.54	-0.26	5.78	6.85
	-----	406.1		1	FM	A	35.45	-0.19	8.43	10.04	5.02	
	-----	422.1		2	FM		35.49	-0.24	7.56	9.03	4.51	
	-----	438.1		3	FM		35.54	-0.23	7.13	8.40	4.20	
	-----	454.1		4	FM		35.52	-0.20	8.25	9.69	4.85	
	-----	469.9		5	FM		35.47	-0.21	6.79	8.09	4.05	
	-----	438.1		3	FM		B	35.54	-0.24	5.02	5.93	2.97
	-----	406.1	1	FM	A	35.45	-0.25	10.70	12.92	6.46		
	-----	422.1	2	FM		35.49	-0.23	7.83	9.33	4.67		
	-----	438.1	3	FM		35.54	-0.27	7.21	8.57	4.29		
	-----	454.1	4	FM		35.52	-0.26	9.74	11.60	5.80		
	-----	469.9	5	FM		35.47	-0.21	6.99	8.33	4.17		
	-----	438.1	3	FM		B	35.54	-0.20	5.57	6.51	3.26	
	-----	438.1	3	FM	A	35.54	-0.29	5.81	6.94	3.47		
	-----	438.1	3	FM	B	35.54	-0.26	4.01	4.75	2.38		
-----	Repeated			406.1	1	FM	A	35.45	-0.20	10.60	12.66	6.33

**Body**  
**8.0 W/kg (mW/g)**  
 averaged over 1 gram

- Battery is fully charged for all tests.  
 Power Measured  Conducted  ERP  EIRP
- SAR Measurement  
 Phantom Configuration  Left Head  Eli4  Right Head  
 SAR Configuration  Head  Body
- Test Signal Call Mode  Test Code  Base Station Simulator
- Test Configuration  With Belt Clip  Without Belt Clip  N/A
- Tissue Depth is at least 15.0 cm

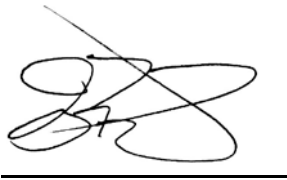

Jay M. Moulton  
 Vice President

The adjusted SAR value was calculated by first scaling the SAR value up by the drift. This value was then scaled up based on the difference of the upper end of the tolerance (36.02 dB) and the measured conducted power. The resultant value is then multiplied by 0.5 to give the SAR value at 50% duty cycle.



## SAR Data Summary – Simultaneous Evaluation

MEASUREMENT RESULTS								
Config.	Frequency		Modulation	Frequency		Modulation	SAR <sub>1</sub>	SAR <sub>2</sub>
	MHz	Ch.		MHz	Ch.			
Head	438.1	3	FM	2440	39	GFSK	2.41	0.20
Body	406.1	3	FM	2440	39	GFSK	6.48	0.20

The calculated value for the Bluetooth radio is based on KDB447498 D01 v06 section 4.3.2 b) 1). Below is the formula used.

$[(\text{max. power, mW}) / (\text{min. distance, mm})] * [\sqrt{f_{\text{(GHz)}}/x}]$  where  $x=7.5$  for 1 g SAR

$[16 \text{ mW}/17\text{mm}] * [\sqrt{2.48/7.5}] = 0.20$

For a device with one transmitter used in a controlled environment and the second transmitter used in an uncontrolled environment, the ratio of the two transmitters to the respective limit must be less than 1.0. Below are the calculations.

$(2.41/8.0) + (0.20/1.6) = 0.43$

$(6.48/8.0) + (0.20/1.6) = 0.94$

Both configurations are less than or equal to 1.0; therefore, simultaneous Tx meets the requirements of the FCC guidelines.

## 9. Test Equipment List

**Table 9.1 Equipment Specifications**

Type	Calibration Due Date	Calibration Done Date	Serial Number
Staubli Robot TX60L	N/A	N/A	F07/55M6A1/A/01
Measurement Controller CS8c	N/A	N/A	1012
ELI4 Flat Phantom	N/A	N/A	1065
Device Holder	N/A	N/A	N/A
Data Acquisition Electronics 4	04/13/2019	04/13/2018	1416
SPEAG E-Field Probe ES3DV3	02/19/2019	02/19/2018	3311
Speag Validation Dipole D450V3	01/14/2019	01/14/2016	1085
Agilent N1911A Power Meter	05/20/2019	03/20/2017	GB45100254
Agilent N1922A Power Sensor	06/21/2019	06/21/2017	MY45240464
Advantest R3261A Spectrum Analyzer	03/26/2019	03/20/2017	31720068
Agilent (HP) 8350B Signal Generator	03/26/2019	03/20/2017	2749A10226
Agilent (HP) 83525A RF Plug-In	03/26/2019	03/20/2017	2647A01172
Agilent (HP) 8753C Vector Network Analyzer	03/26/2019	03/20/2017	3135A01724
Agilent (HP) 85047A S-Parameter Test Set	03/26/2019	03/20/2017	2904A00595
Anritsu MT8820C	03/30/2019	03/30/2017	6201176199
Agilent 778D Dual Directional Coupler	07/27/2019	07/27/2017	MY48220184
MiniCircuits BW-N20W5+ Fixed 20 dB Attenuator	N/A	N/A	N/A
MiniCircuits SPL-10.7+ Low Pass Filter	N/A	N/A	R8979513746
Apral Dielectric Probe Assembly	N/A	N/A	0011
Head Equivalent Matter (450 MHz)	N/A	N/A	N/A
Body Equivalent Matter (450 MHz)	N/A	N/A	N/A

## 10. Conclusion

The SAR measurement indicates that the EUT complies with the RF radiation exposure limits of the FCC/IC. These measurements are taken to simulate the RF effects exposure under worst-case conditions. Precise laboratory measures were taken to assure repeatability of the tests. The tested device complies with the requirements in respect to all parameters subject to the test. The test results and statements relate only to the item(s) tested.

Please note that the absorption and distribution of electromagnetic energy in the body is a very complex phenomena that depends on the mass, shape, and size of the body; the orientation of the body with respect to the field vectors; and, the electrical properties of both the body and the environment. Other variables that may play a substantial role in possible biological effects are those that characterize the environment (e.g. ambient temperature, air velocity, relative humidity, and body insulation) and those that characterize the individual (e.g. age, gender, activity level, debilitation, or disease). Because innumerable factors may interact to determine the specific biological outcome of an exposure to electromagnetic fields, any protection guide shall consider maximal amplification of biological effects as a result of field-body interactions, environmental conditions, and physiological variables.

## 11. References

- [1] Federal Communications Commission, ET Docket 93-62, Guidelines for Evaluating the Environmental Effects of Radio Frequency Radiation, August 1996
- [2] ANSI/IEEE C95.1 – 1992, American National Standard Safety Levels with respect to Human Exposure to Radio Frequency Electromagnetic Fields, 300kHz to 100GHz, New York: IEEE, 1992.
- [3] ANSI/IEEE C95.3 – 2002, IEEE Recommended Practice for the Measurement of Potentially Hazardous Electromagnetic Fields – RF and Microwave, New York: IEEE, 2002.
- [4] International Electrotechnical Commission, IEC 62209-2 (Edition 1.0), Human Exposure to radio frequency fields from hand-held and body mounted wireless communication devices – Human models, instrumentation, and procedures – Part 2: Procedure to determine the specific absorption rate (SAR) for wireless communication devices used in close proximity to the human body (frequency range of 30 MHz to 6 GHz), March 2010.
- [5] IEEE Standard 1528 – 2013, IEEE Recommended Practice for Determining the Peak-Spatial Average Specific Absorption Rate (SAR) in the Human Head from Wireless Communication Devices: Measurement Techniques, June 2013.
- [6] Industry Canada, RSS – 102 Issue 5, Radio Frequency Exposure Compliance of Radiocommunication Apparatus (All Frequency Bands), March 2015.
- [7] Health Canada, Safety Code 6, Limits of Human Exposure to Radiofrequency Electromagnetic Fields in the Frequency Range from 3kHz to 300 GHz, 2009.

## Appendix A – System Validation Plots and Data

### Limits for Head

```
*****  
Test Result for UIM Dielectric Parameter  
Fri 12/Oct/2018  
Freq Frequency(GHz)  
FCC_eH Limits for Head Epsilon  
FCC_sH Limits for Head Sigma  
Test_e Epsilon of UIM  
Test_s Sigma of UIM  
*****  
Freq          FCC_eH FCC_sH Test_e Test_s  
0.4000         44.10  0.87  44.16  0.87  
0.4061         44.027 0.87  44.081 0.87*  
0.4100         43.98  0.87  44.03  0.87  
0.4200         43.86  0.87  43.90  0.87  
0.4221         43.835 0.87  43.875 0.872*  
0.4300         43.74  0.87  43.78  0.88  
0.4381         43.643 0.87  43.683 0.88*  
0.4400         43.62  0.87  43.66  0.88  
0.4500         43.50  0.87  43.55  0.88  
0.4541         43.48  0.87  43.517 0.884*  
0.4600         43.45  0.87  43.47  0.89  
0.4699         43.401 0.87  43.411 0.89*  
0.4700         43.40  0.87  43.41  0.89  
0.4800         43.34  0.87  43.35  0.90
```

\* value intepolated

**Limits for Body**

\*\*\*\*\*

Test Result for UIM Dielectric Parameter

Thu 11/Oct/2018

Freq Frequency(GHz)

FCC\_eH Limits for Head Epsilon

FCC\_sH Limits for Head Sigma

FCC\_eB Limits for Body Epsilon

FCC\_sB Limits for Body Sigma

Test\_e Epsilon of UIM

Test\_s Sigma of UIM

\*\*\*\*\*

Freq	FCC_eB	FCC_sB	Test_e	Test_s
0.4000	57.20	0.94	57.23	0.91
0.4061	57.139	0.94	57.157	0.91*
0.4100	57.10	0.94	57.11	0.91
0.4200	57.00	0.94	56.99	0.92
0.4221	56.979	0.94	56.967	0.92*
0.4300	56.90	0.94	56.88	0.92
0.4381	56.819	0.94	56.791	0.928*
0.4400	56.80	0.94	56.77	0.93
0.4500	56.70	0.94	56.66	0.93
0.4541	56.684	0.94	56.627	0.93*
0.4600	56.66	0.94	56.58	0.93
0.4699	56.62	0.94	56.521	0.94*
0.4700	56.62	0.94	56.52	0.94
0.4800	56.58	0.94	56.47	0.94

\* value interpolated

# RF Exposure Lab

## Plot 1

**DUT: Dipole 450 MHz D450V2; Type: D450V2; Serial: D450V2 - SN:1085**

Communication System: CW; Frequency: 450 MHz; Duty Cycle: 1:1  
Medium: HSL450; Medium parameters used:  $f = 450$  MHz;  $\sigma = 0.88$  S/m;  $\epsilon_r = 43.55$ ;  $\rho = 1000$  kg/m<sup>3</sup>  
Phantom section: Flat Section

Test Date: Date: 10/12/2018; Ambient Temp: 23 °C; Tissue Temp: 21 °C

Probe: ES3DV3 – SN3311; ConvF(7.11, 7.11, 7.11); Calibrated: 2/15/2018;  
Sensor-Surface: 3mm (Mechanical Surface Detection)  
Electronics: DAE4 Sn1416; Calibrated: 4/13/2018  
Phantom: ELI v4.0; Type: QDOVA001BB; Serial: 1065  
Measurement SW: DASY52, Version 52.10 (0); SEMCAD X Version 14.6.10 (7417)

### Procedure Notes:

**450 MHz Head/Verification/Area Scan (7x15x1):** Measurement grid: dx=15mm, dy=15mm  
Maximum value of SAR (measured) = 0.560 W/kg

**450 MHz Head/Verification/Zoom Scan (5x5x7)/Cube 0:** Measurement grid: dx=8mm, dy=8mm, dz=5mm  
Reference Value = 24.573 V/m; Power Drift = -0.01 dB  
Peak SAR (extrapolated) = 0.739 W/kg  
**SAR(1 g) = 0.455 W/kg; SAR(10 g) = 0.319 W/kg**  
Maximum value of SAR (measured) = 0.566 W/kg

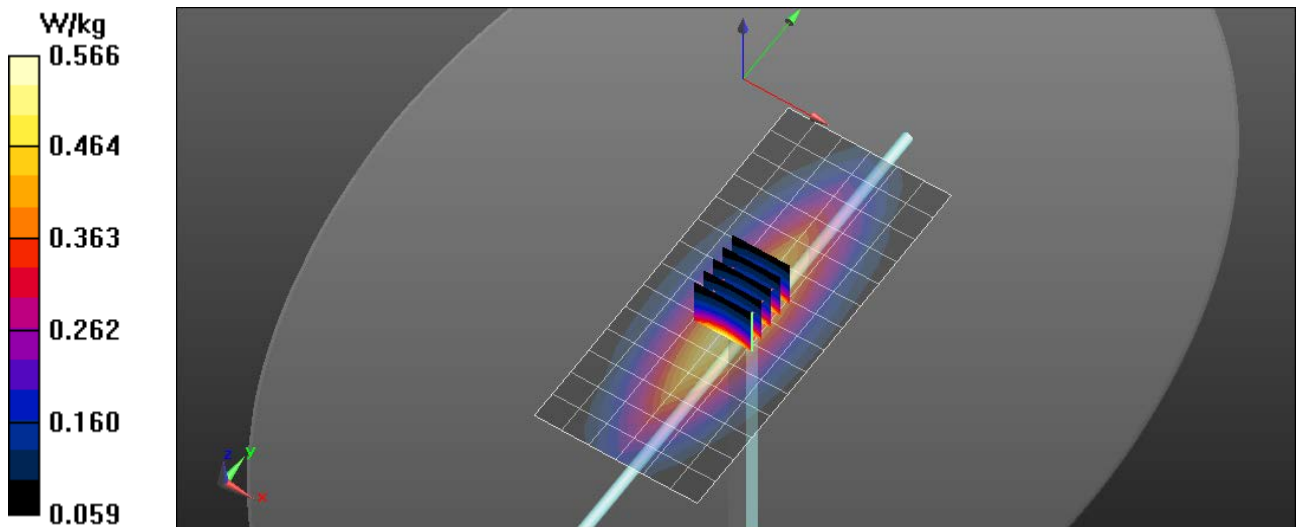

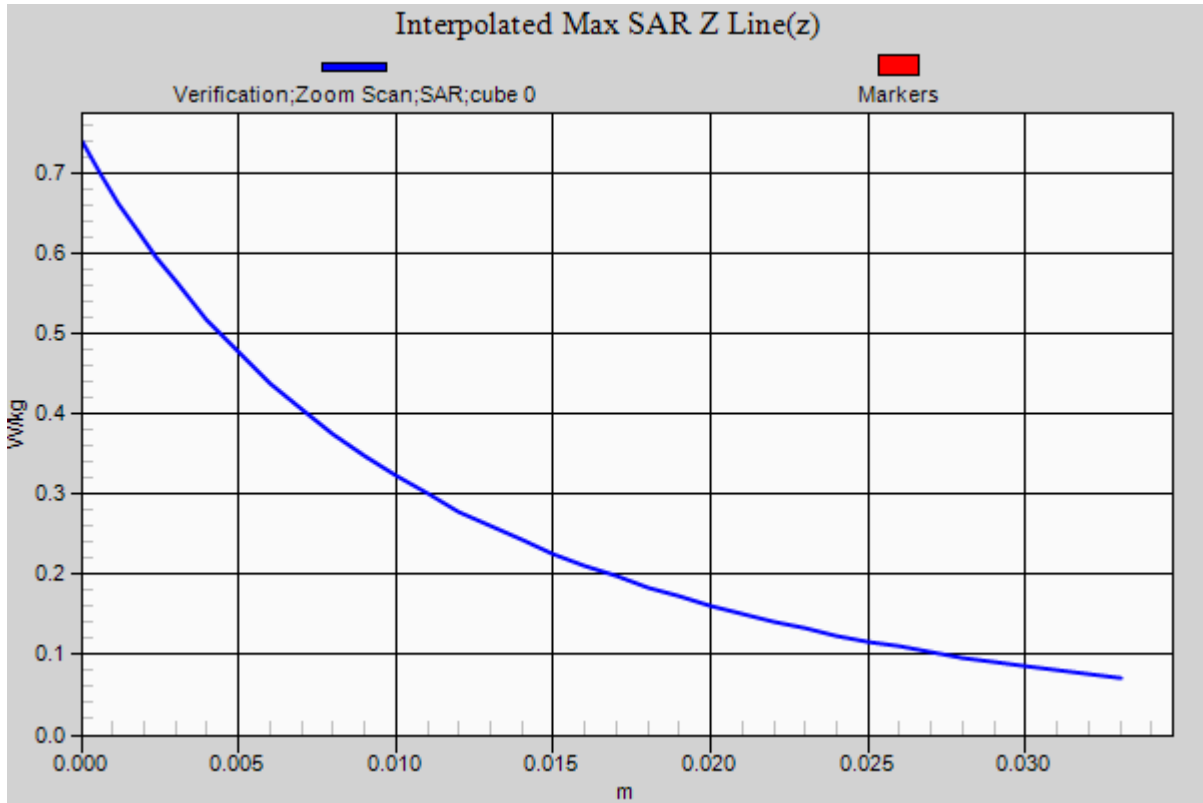



# RF Exposure Lab

## Plot 2

**DUT: Dipole 450 MHz D450V2; Type: D450V2; Serial: D450V2 - SN:1085**

Communication System: CW; Frequency: 450 MHz; Duty Cycle: 1:1  
 Medium: MSL450; Medium parameters used:  $f = 450$  MHz;  $\sigma = 0.93$  S/m;  $\epsilon_r = 56.66$ ;  $\rho = 1000$  kg/m<sup>3</sup>  
 Phantom section: Flat Section

Test Date: Date: 10/11/2018; Ambient Temp: 23 °C; Tissue Temp: 21 °C

Probe: ES3DV3 – SN3311; ConvF(7.24, 7.24, 7.24); Calibrated: 2/15/2018;  
 Sensor-Surface: 3mm (Mechanical Surface Detection)  
 Electronics: DAE4 Sn1416; Calibrated: 4/13/2018  
 Phantom: ELI v4.0; Type: QDOVA001BB; Serial: 1065  
 Measurement SW: DASY52, Version 52.10 (0); SEMCAD X Version 14.6.10 (7417)

### Procedure Notes:

**450 MHz Body/Verification/Area Scan (7x15x1):** Measurement grid: dx=15mm, dy=15mm  
 Maximum value of SAR (measured) = 0.513 W/kg

**450 MHz Body/Verification/Zoom Scan (5x5x7)/Cube 0:** Measurement grid: dx=8mm, dy=8mm, dz=5mm  
 Reference Value = 24.573 V/m; Power Drift = -0.01 dB  
 Peak SAR (extrapolated) = 0.729 W/kg  
**SAR(1 g) = 0.457 W/kg; SAR(10 g) = 0.297 W/kg**  
 Maximum value of SAR (measured) = 0.523 W/kg

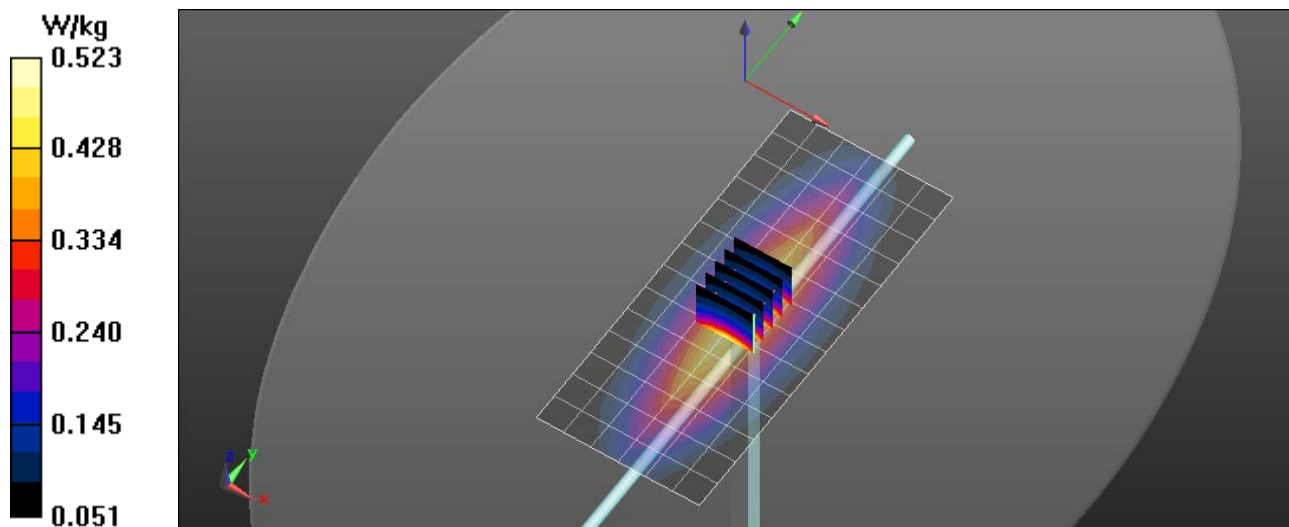

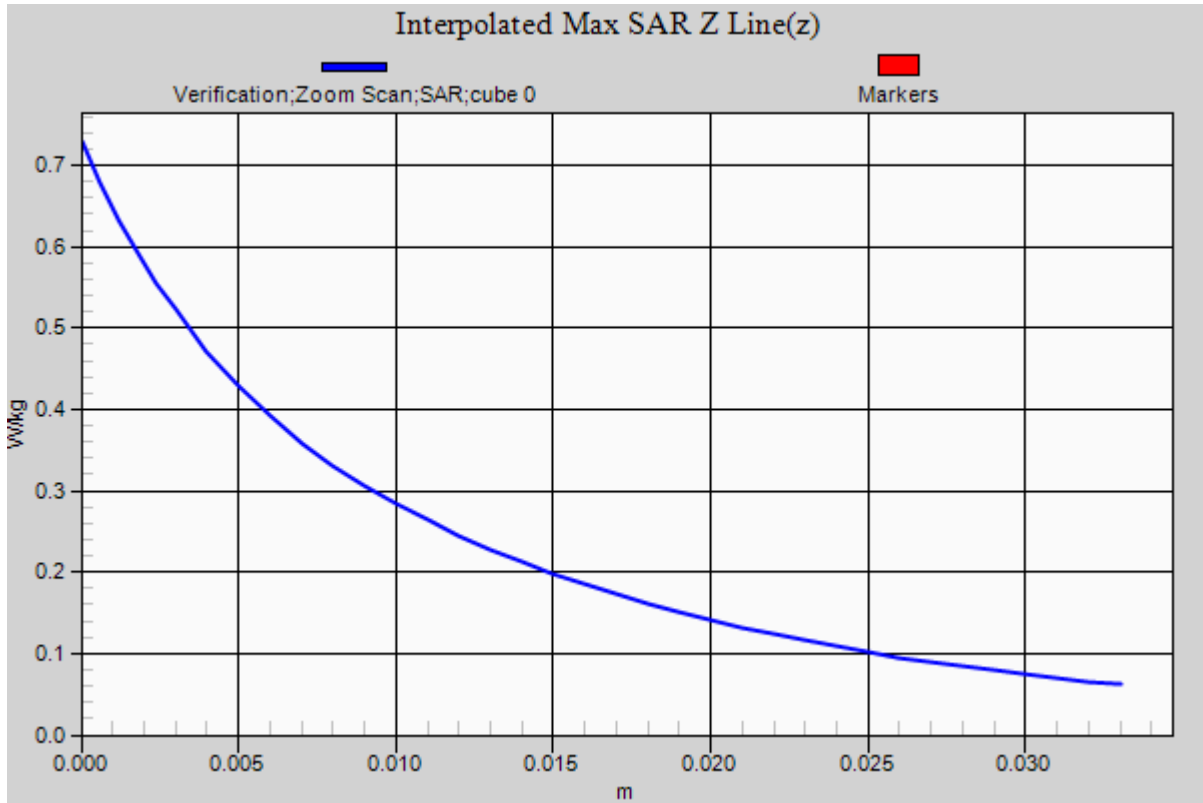

## **Appendix B – SAR Test Data Plots**

# RF Exposure Lab

## Plot 1

**DUT: TPDH5D; Type: PTT; Serial: 25695131**

Communication System: FM; Frequency: 438.1 MHz; Duty Cycle: 1:1  
Medium: HSL450; Medium parameters used (interpolated):  $f = 438.1$  MHz;  $\sigma = 0.88$  S/m;  $\epsilon_r = 43.683$ ;  $\rho = 1000$  kg/m<sup>3</sup>  
Phantom section: Flat Section

Test Date: Date: 10/12/2018; Ambient Temp: 23 °C; Tissue Temp: 21 °C

Probe: ES3DV3 - SN3311; ConvF(7.22, 7.22, 7.22); Calibrated: 2/15/2017;  
Sensor-Surface: 3mm (Mechanical Surface Detection)  
Electronics: DAE4 Sn1416; Calibrated: 4/13/2018  
Phantom: ELI v4.0; Type: QDOVA001BB; Serial: 1065  
Measurement SW: DASY52, Version 52.10 (0); SEMCAD X Version 14.6.10 (7417)

### Procedure Notes:

**Face/Ant 011, Ext Bat 438.1/Area Scan (7x21x1):** Measurement grid: dx=15mm, dy=15mm

[Info: Interpolated medium parameters used for SAR evaluation.](#)

Maximum value of SAR (measured) = 4.64 W/kg

**Face/Ant 011, Ext Bat 438.1/Zoom Scan (5x5x7)/Cube 0:** Measurement grid: dx=8mm, dy=8mm, dz=5mm

Reference Value = 67.77 V/m; Power Drift = -0.24 dB

Peak SAR (extrapolated) = 5.78 W/kg

**SAR(1 g) = 4.08 W/kg; SAR(10 g) = 2.98 W/kg**

[Info: Interpolated medium parameters used for SAR evaluation.](#)

Maximum value of SAR (measured) = 4.58 W/kg

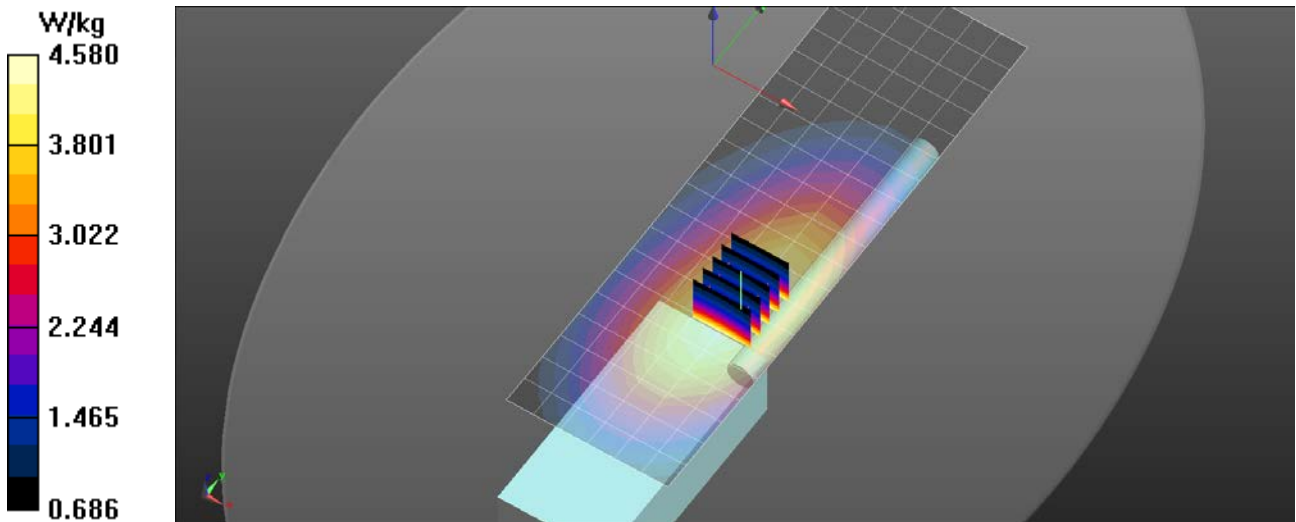

# RF Exposure Lab

## Plot 2

**DUT: TPDH5D; Type: PTT; Serial: 25695131**

Communication System: FM; Frequency: 406.1 MHz; Duty Cycle: 1:1  
 Medium: MSL450; Medium parameters used (interpolated):  $f = 406.1$  MHz;  $\sigma = 0.91$  S/m;  $\epsilon_r = 57.157$ ;  $\rho = 1000$  kg/m<sup>3</sup>  
 Phantom section: Flat Section

Test Date: Date: 10/11/2018; Ambient Temp: 23 °C; Tissue Temp: 21 °C

Probe: ES3DV3 - SN3311; ConvF(7.32, 7.32, 7.32); Calibrated: 2/15/2017;  
 Sensor-Surface: 3mm (Mechanical Surface Detection)  
 Electronics: DAE4 Sn1416; Calibrated: 4/13/2018  
 Phantom: ELI v4.0; Type: QDOVA001BB; Serial: 1065  
 Measurement SW: DASY52, Version 52.10 (0); SEMCAD X Version 14.6.10 (7417)

### Procedure Notes:

**Body/Ant 011, Std Bat Belt Loop 406.1/Area Scan (7x21x1):** Measurement grid: dx=15mm, dy=15mm

[Info: Interpolated medium parameters used for SAR evaluation.](#)

Maximum value of SAR (measured) = 11.7 W/kg

**Body/Ant 011, Std Bat Belt Loop 406.1/Zoom Scan (5x5x7)/Cube 0:** Measurement grid: dx=8mm, dy=8mm, dz=5mm

Reference Value = 99.44 V/m; Power Drift = -0.26 dB

Peak SAR (extrapolated) = 16.2 W/kg

**SAR(1 g) = 10.7 W/kg; SAR(10 g) = 7.46 W/kg**

[Info: Interpolated medium parameters used for SAR evaluation.](#)

Maximum value of SAR (measured) = 12.3 W/kg

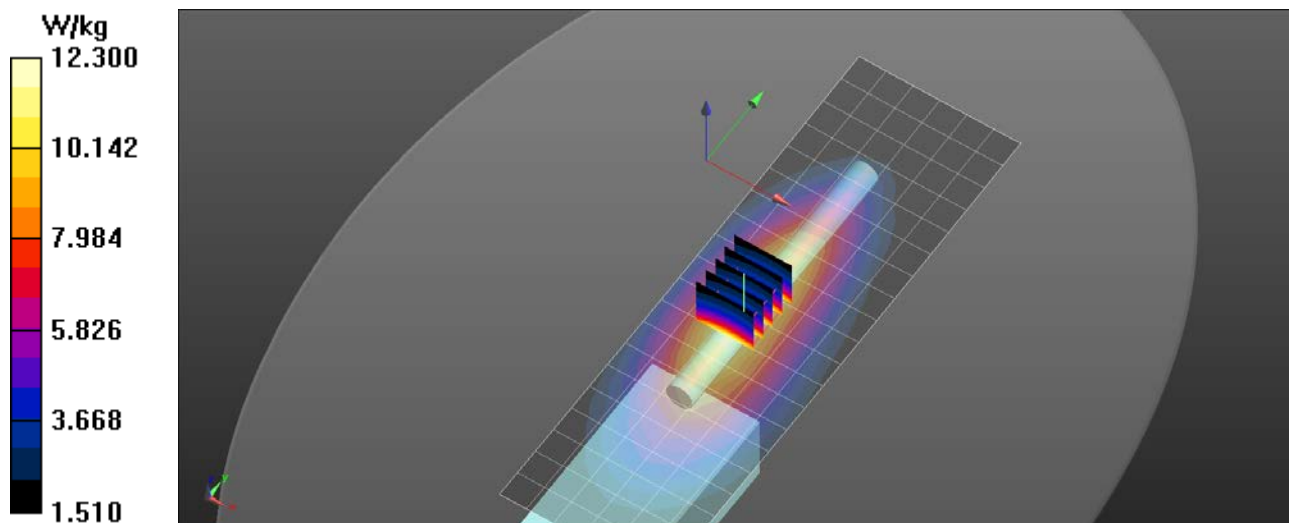

## Appendix C – SAR Test Setup Photos

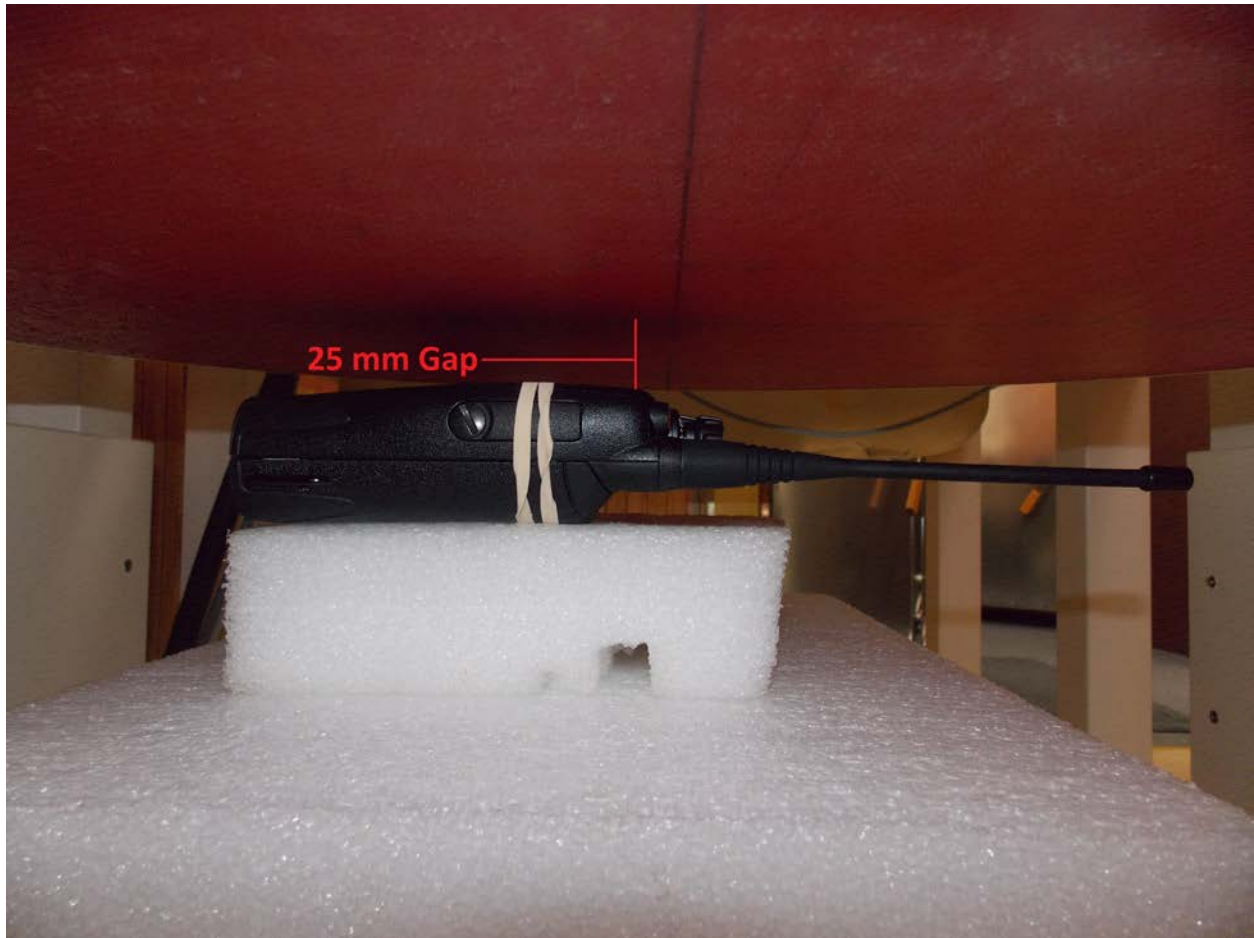

**Handset Face Ant B Configuration**



**Handset with Antenna B, Audio C and  
Body E Accessories Configuration**





**Handset with Antenna B, Audio C and  
Body A Accessories Configuration**





**Front of Device**



**Back of Device**



**Battery (A & B)**



**Body Worn Accessories (E)**





**Body Worn Accessories (A)**





**Audio Accessory (C)**



**Antennas (A, B)**

## **Appendix D – Probe Calibration Data Sheets**



*Jm*

**Calibration Laboratory of  
Schmid & Partner  
Engineering AG**  
Zeughausstrasse 43, 8004 Zurich, Switzerland



**S** Schweizerischer Kalibrierdienst  
**S** Service suisse d'étalonnage  
**S** Servizio svizzero di taratura  
**S** Swiss Calibration Service

Accredited by the Swiss Accreditation Service (SAS)  
**The Swiss Accreditation Service is one of the signatories to the EA  
Multilateral Agreement for the recognition of calibration certificates**

Accreditation No.: **SCS 0108**

Client **RF Exposure Lab**

Certificate No: **ES3-3311\_Feb18**

## CALIBRATION CERTIFICATE

Object **ES3DV3 - SN:3311**

Calibration procedure(s) **QA CAL-01.v9, QA CAL-12.v9, QA CAL-23.v5, QA CAL-25.v6  
Calibration procedure for dosimetric E-field probes**

Calibration date: **February 19, 2018**

This calibration certificate documents the traceability to national standards, which realize the physical units of measurements (SI).  
The measurements and the uncertainties with confidence probability are given on the following pages and are part of the certificate.

All calibrations have been conducted in the closed laboratory facility: environment temperature (22 ± 3)°C and humidity < 70%.

Calibration Equipment used (M&TE critical for calibration)

Primary Standards	ID	Cal Date (Certificate No.)	Scheduled Calibration
Power meter NRP	SN: 104778	04-Apr-17 (No. 217-02521/02522)	Apr-18
Power sensor NRP-Z91	SN: 103244	04-Apr-17 (No. 217-02521)	Apr-18
Power sensor NRP-Z91	SN: 103245	04-Apr-17 (No. 217-02525)	Apr-18
Reference 20 dB Attenuator	SN: S5277 (20x)	07-Apr-17 (No. 217-02528)	Apr-18
Reference Probe ES3DV2	SN: 3013	30-Dec-17 (No. ES3-3013_Dec17)	Dec-18
DAE4	SN: 660	21-Dec-17 (No. DAE4-660_Dec17)	Dec-18
Secondary Standards	ID	Check Date (in house)	Scheduled Check
Power meter E4419B	SN: GB41293874	06-Apr-16 (in house check Jun-16)	In house check: Jun-18
Power sensor E4412A	SN: MY41498087	06-Apr-16 (in house check Jun-16)	In house check: Jun-18
Power sensor E4412A	SN: 000110210	06-Apr-16 (in house check Jun-16)	In house check: Jun-18
RF generator HP 8648C	SN: US3642U01700	04-Aug-99 (in house check Jun-16)	In house check: Jun-18
Network Analyzer HP 8753E	SN: US37390585	18-Oct-01 (in house check Oct-17)	In house check: Oct-18

Calibrated by:	Name <b>Jeton Kastrati</b>	Function <b>Laboratory Technician</b>	Signature 
Approved by:	Name <b>Katja Pokovic</b>	Function <b>Technical Manager</b>	Signature 

Issued: February 20, 2018

This calibration certificate shall not be reproduced except in full without written approval of the laboratory.



Accredited by the Swiss Accreditation Service (SAS)

Accreditation No.: **SCS 0108**

The Swiss Accreditation Service is one of the signatories to the EA  
Multilateral Agreement for the recognition of calibration certificates

**Glossary:**

TSL	tissue simulating liquid
NORM <sub>x,y,z</sub>	sensitivity in free space
ConvF	sensitivity in TSL / NORM <sub>x,y,z</sub>
DCP	diode compression point
CF	crest factor (1/duty_cycle) of the RF signal
A, B, C, D	modulation dependent linearization parameters
Polarization $\varphi$	$\varphi$ rotation around probe axis
Polarization $\vartheta$	$\vartheta$ rotation around an axis that is in the plane normal to probe axis (at measurement center), i.e., $\vartheta = 0$ is normal to probe axis
Connector Angle	information used in DASY system to align probe sensor X to the robot coordinate system

**Calibration is Performed According to the Following Standards:**

- a) IEEE Std 1528-2013, "IEEE Recommended Practice for Determining the Peak Spatial-Averaged Specific Absorption Rate (SAR) in the Human Head from Wireless Communications Devices: Measurement Techniques", June 2013
- b) IEC 62209-1, "Measurement procedure for the assessment of Specific Absorption Rate (SAR) from hand-held and body-mounted devices used next to the ear (frequency range of 300 MHz to 6 GHz)", July 2016
- c) IEC 62209-2, "Procedure to determine the Specific Absorption Rate (SAR) for wireless communication devices used in close proximity to the human body (frequency range of 30 MHz to 6 GHz)", March 2010
- d) KDB 865664, "SAR Measurement Requirements for 100 MHz to 6 GHz"

**Methods Applied and Interpretation of Parameters:**

- **NORM<sub>x,y,z</sub>**: Assessed for E-field polarization  $\vartheta = 0$  ( $f \leq 900$  MHz in TEM-cell;  $f > 1800$  MHz: R22 waveguide). NORM<sub>x,y,z</sub> are only intermediate values, i.e., the uncertainties of NORM<sub>x,y,z</sub> does not affect the E<sup>2</sup>-field uncertainty inside TSL (see below *ConvF*).
- **NORM(f)<sub>x,y,z</sub>** = NORM<sub>x,y,z</sub> \* *frequency\_response* (see Frequency Response Chart). This linearization is implemented in DASY4 software versions later than 4.2. The uncertainty of the frequency response is included in the stated uncertainty of *ConvF*.
- **DCP<sub>x,y,z</sub>**: DCP are numerical linearization parameters assessed based on the data of power sweep with CW signal (no uncertainty required). DCP does not depend on frequency nor media.
- **PAR**: PAR is the Peak to Average Ratio that is not calibrated but determined based on the signal characteristics
- **A<sub>x,y,z</sub>; B<sub>x,y,z</sub>; C<sub>x,y,z</sub>; D<sub>x,y,z</sub>; VR<sub>x,y,z</sub>**: A, B, C, D are numerical linearization parameters assessed based on the data of power sweep for specific modulation signal. The parameters do not depend on frequency nor media. VR is the maximum calibration range expressed in RMS voltage across the diode.
- **ConvF and Boundary Effect Parameters**: Assessed in flat phantom using E-field (or Temperature Transfer Standard for  $f \leq 800$  MHz) and inside waveguide using analytical field distributions based on power measurements for  $f > 800$  MHz. The same setups are used for assessment of the parameters applied for boundary compensation (alpha, depth) of which typical uncertainty values are given. These parameters are used in DASY4 software to improve probe accuracy close to the boundary. The sensitivity in TSL corresponds to NORM<sub>x,y,z</sub> \* *ConvF* whereby the uncertainty corresponds to that given for *ConvF*. A frequency dependent *ConvF* is used in DASY version 4.4 and higher which allows extending the validity from  $\pm 50$  MHz to  $\pm 100$  MHz.
- **Spherical isotropy (3D deviation from isotropy)**: in a field of low gradients realized using a flat phantom exposed by a patch antenna.
- **Sensor Offset**: The sensor offset corresponds to the offset of virtual measurement center from the probe tip (on probe axis). No tolerance required.
- **Connector Angle**: The angle is assessed using the information gained by determining the NORM<sub>x</sub> (no uncertainty required).

# Probe ES3DV3

## SN:3311

Manufactured: July 5, 2011  
Calibrated: February 19, 2018

Calibrated for DASY/EASY Systems  
(Note: non-compatible with DASY2 system!)

## DASY/EASY - Parameters of Probe: ES3DV3 - SN:3311

### Basic Calibration Parameters

	Sensor X	Sensor Y	Sensor Z	Unc (k=2)
Norm ( $\mu\text{V}/(\text{V}/\text{m})^2$ ) <sup>A</sup>	1.23	1.03	0.46	$\pm 10.1 \%$
DCP (mV) <sup>B</sup>	105.4	103.7	98.9	

### Modulation Calibration Parameters

UID	Communication System Name		A dB	B dB $\sqrt{\mu\text{V}}$	C	D dB	VR mV	Unc <sup>E</sup> (k=2)
0	CW	X	0.0	0.0	1.0	0.00	183.8	$\pm 3.0 \%$
		Y	0.0	0.0	1.0		187.8	
		Z	0.0	0.0	1.0		173.2	

The reported uncertainty of measurement is stated as the standard uncertainty of measurement multiplied by the coverage factor  $k=2$ , which for a normal distribution corresponds to a coverage probability of approximately 95%.

<sup>A</sup> The uncertainties of Norm X,Y,Z do not affect the  $E^2$ -field uncertainty inside TSL (see Pages 5 and 6).

<sup>B</sup> Numerical linearization parameter: uncertainty not required.

<sup>E</sup> Uncertainty is determined using the max. deviation from linear response applying rectangular distribution and is expressed for the square of the field value.

## DASY/EASY - Parameters of Probe: ES3DV3 - SN:3311

### Calibration Parameter Determined in Head Tissue Simulating Media

f (MHz) <sup>C</sup>	Relative Permittivity <sup>F</sup>	Conductivity (S/m) <sup>F</sup>	ConvF X	ConvF Y	ConvF Z	Alpha <sup>G</sup>	Depth <sup>G</sup> (mm)	Unc (k=2)
150	52.3	0.76	7.61	7.61	7.61	0.10	1.30	± 13.3 %
220	49.0	0.81	7.60	7.60	7.60	0.10	1.30	± 13.3 %
300	45.3	0.87	7.48	7.48	7.48	0.06	1.40	± 13.3 %
450	43.5	0.87	7.11	7.11	7.11	0.20	1.40	± 13.3 %
600	42.7	0.88	6.75	6.75	6.75	0.11	1.60	± 13.3 %
1640	40.2	1.31	5.59	5.59	5.59	0.62	1.27	± 12.0 %
2450	39.2	1.80	4.75	4.75	4.75	0.76	1.34	± 12.0 %

<sup>C</sup> Frequency validity above 300 MHz of ± 100 MHz only applies for DASY v4.4 and higher (see Page 2), else it is restricted to ± 50 MHz. The uncertainty is the RSS of the ConvF uncertainty at calibration frequency and the uncertainty for the indicated frequency band. Frequency validity below 300 MHz is ± 10, 25, 40, 50 and 70 MHz for ConvF assessments at 30, 64, 128, 150 and 220 MHz respectively. Above 5 GHz frequency validity can be extended to ± 110 MHz.

<sup>F</sup> At frequencies below 3 GHz, the validity of tissue parameters ( $\epsilon$  and  $\sigma$ ) can be relaxed to ± 10% if liquid compensation formula is applied to measured SAR values. At frequencies above 3 GHz, the validity of tissue parameters ( $\epsilon$  and  $\sigma$ ) is restricted to ± 5%. The uncertainty is the RSS of the ConvF uncertainty for indicated target tissue parameters.

<sup>G</sup> Alpha/Depth are determined during calibration. SPEAG warrants that the remaining deviation due to the boundary effect after compensation is always less than ± 1% for frequencies below 3 GHz and below ± 2% for frequencies between 3-6 GHz at any distance larger than half the probe tip diameter from the boundary.

## DASY/EASY - Parameters of Probe: ES3DV3 - SN:3311

### Calibration Parameter Determined in Body Tissue Simulating Media

f (MHz) <sup>C</sup>	Relative Permittivity <sup>F</sup>	Conductivity (S/m) <sup>F</sup>	ConvF X	ConvF Y	ConvF Z	Alpha <sup>G</sup>	Depth <sup>G</sup> (mm)	Unc (k=2)
150	61.9	0.80	7.22	7.22	7.22	0.12	1.30	± 13.3 %
220	60.2	0.86	7.16	7.16	7.16	0.10	1.30	± 13.3 %
300	58.2	0.92	7.28	7.28	7.28	0.09	1.40	± 13.3 %
450	56.7	0.94	7.24	7.24	7.24	0.12	1.40	± 13.3 %
600	56.1	0.95	6.76	6.76	6.76	0.11	1.60	± 13.3 %
1640	53.7	1.42	5.37	5.37	5.37	0.42	1.77	± 12.0 %
2450	52.7	1.95	4.58	4.58	4.58	0.77	1.24	± 12.0 %

<sup>C</sup> Frequency validity above 300 MHz of ± 100 MHz only applies for DASY v4.4 and higher (see Page 2), else it is restricted to ± 50 MHz. The uncertainty is the RSS of the ConvF uncertainty at calibration frequency and the uncertainty for the indicated frequency band. Frequency validity below 300 MHz is ± 10, 25, 40, 50 and 70 MHz for ConvF assessments at 30, 64, 128, 150 and 220 MHz respectively. Above 5 GHz frequency validity can be extended to ± 110 MHz.

<sup>F</sup> At frequencies below 3 GHz, the validity of tissue parameters ( $\epsilon$  and  $\sigma$ ) can be relaxed to ± 10% if liquid compensation formula is applied to measured SAR values. At frequencies above 3 GHz, the validity of tissue parameters ( $\epsilon$  and  $\sigma$ ) is restricted to ± 5%. The uncertainty is the RSS of the ConvF uncertainty for indicated target tissue parameters.

<sup>G</sup> Alpha/Depth are determined during calibration. SPEAG warrants that the remaining deviation due to the boundary effect after compensation is always less than ± 1% for frequencies below 3 GHz and below ± 2% for frequencies between 3-6 GHz at any distance larger than half the probe tip diameter from the boundary.

# Frequency Response of E-Field (TEM-Cell:ifi110 EXX, Waveguide: R22)

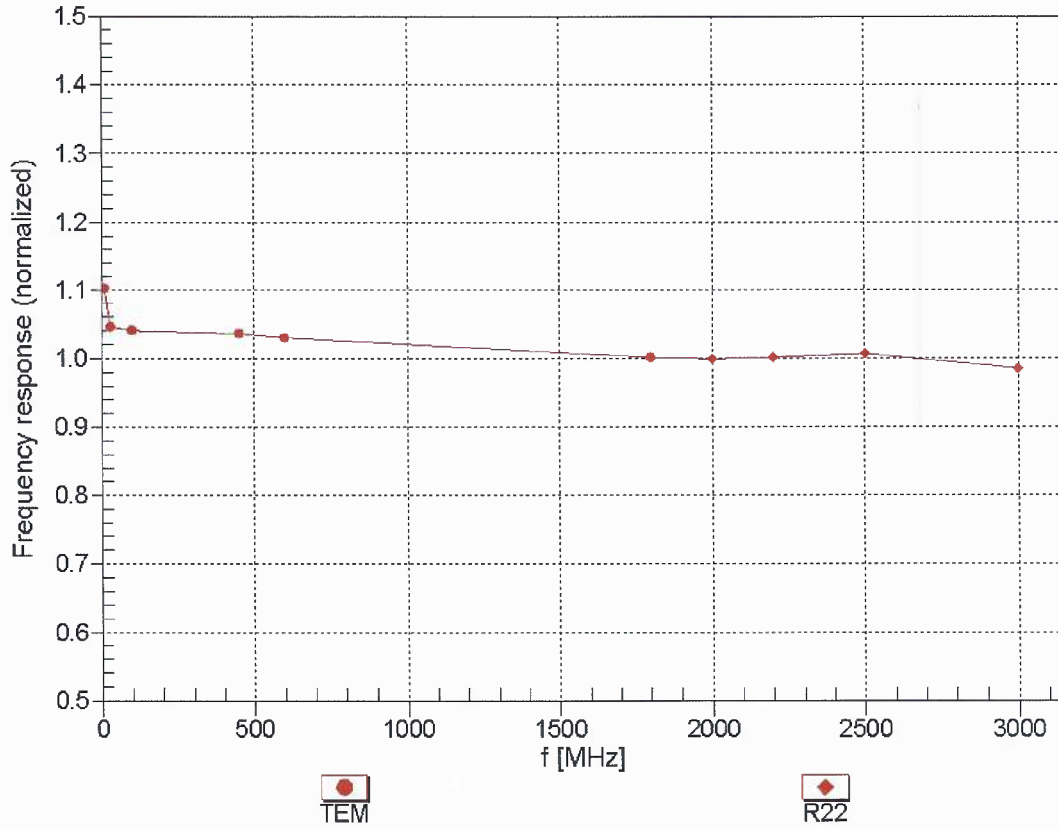

Uncertainty of Frequency Response of E-field:  $\pm 6.3\%$  (k=2)

# Receiving Pattern ( $\phi$ ), $\theta = 0^\circ$

f=600 MHz,TEM

f=1800 MHz,R22

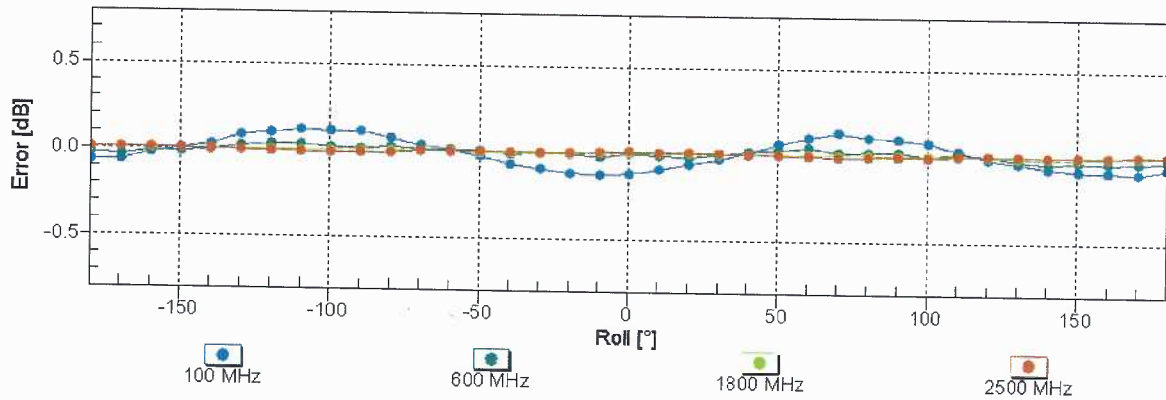
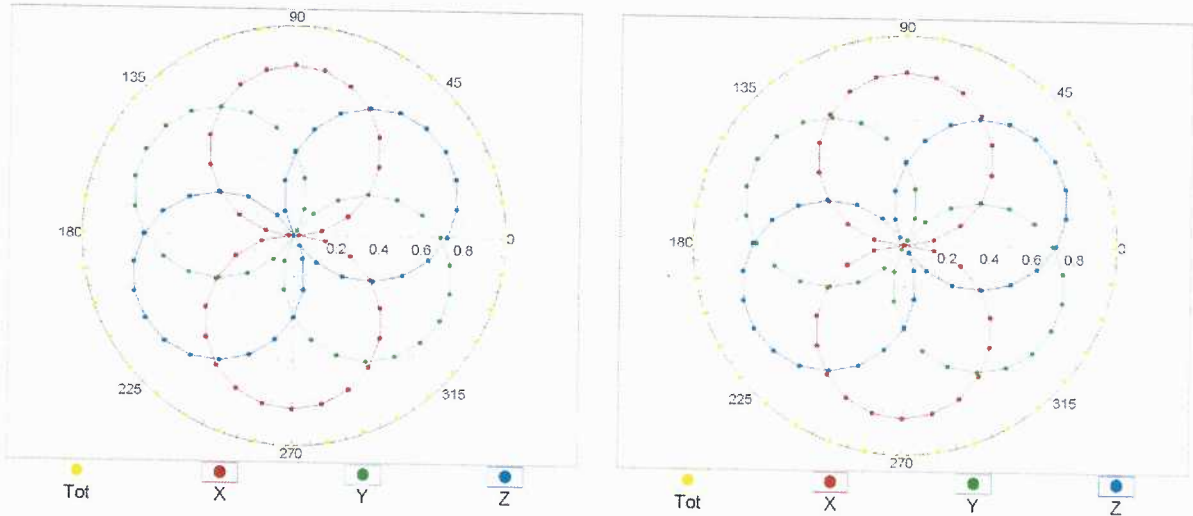

Uncertainty of Axial Isotropy Assessment:  $\pm 0.5\%$  ( $k=2$ )



### Dynamic Range $f(\text{SAR}_{\text{head}})$ (TEM cell, $f_{\text{eval}} = 1900 \text{ MHz}$ )

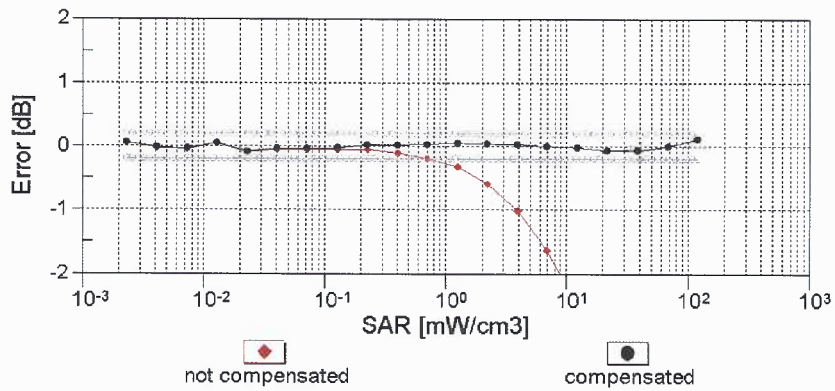
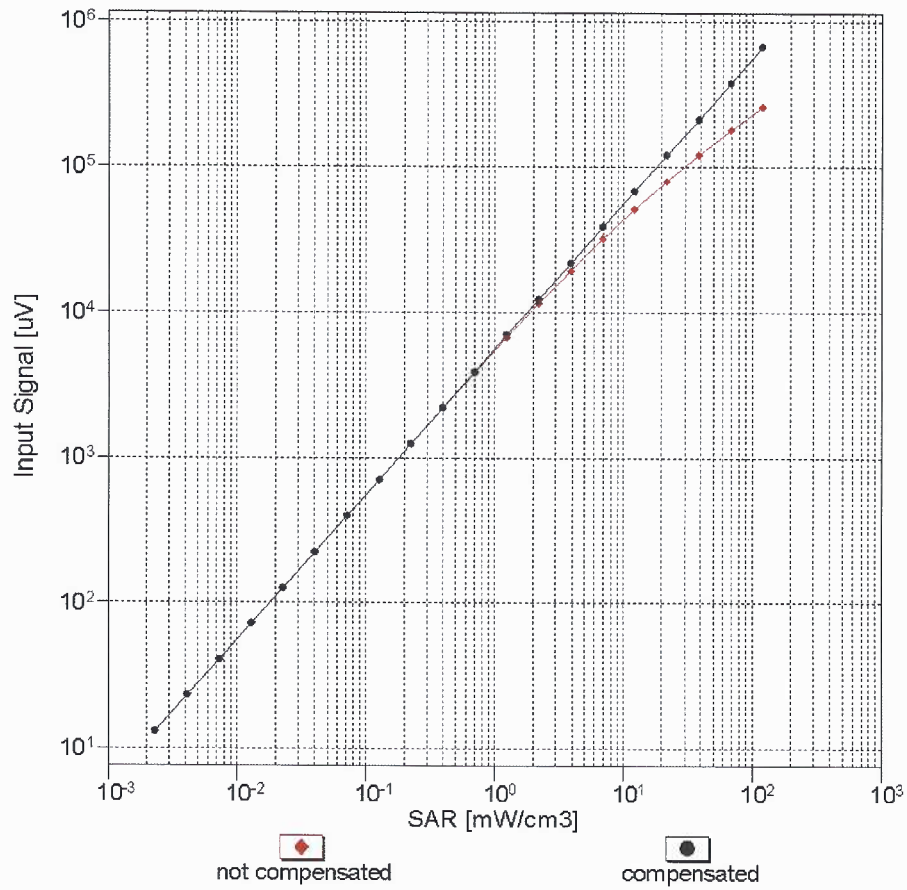

Uncertainty of Linearity Assessment:  $\pm 0.6\%$  ( $k=2$ )

# Conversion Factor Assessment

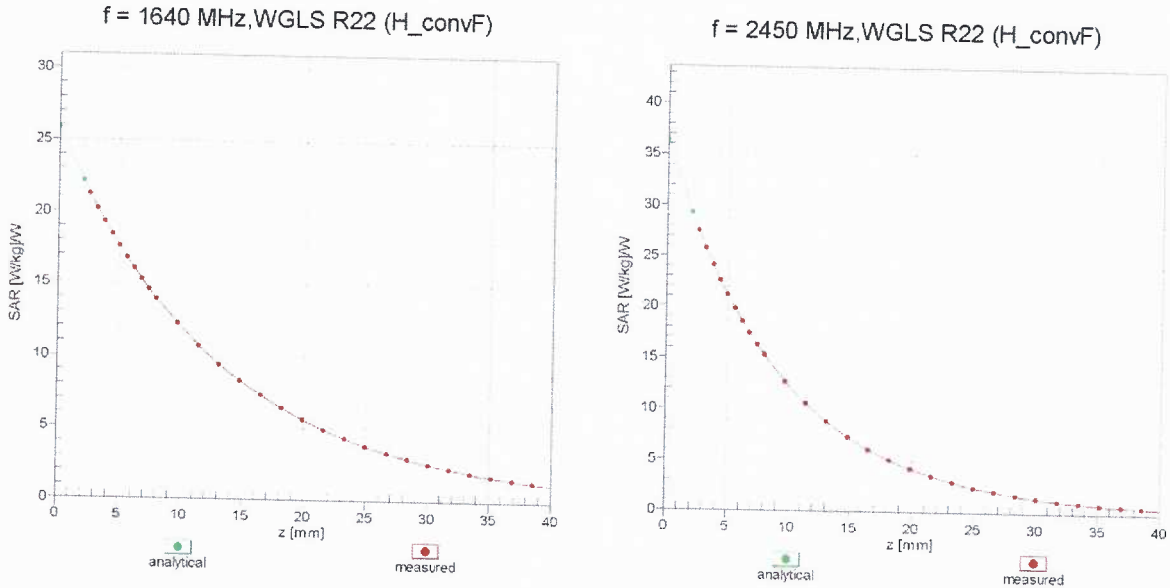

## Deviation from Isotropy in Liquid Error ( $\phi, \theta$ ), f = 900 MHz

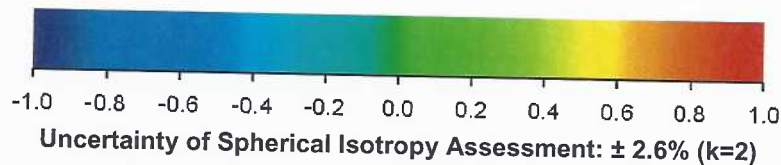
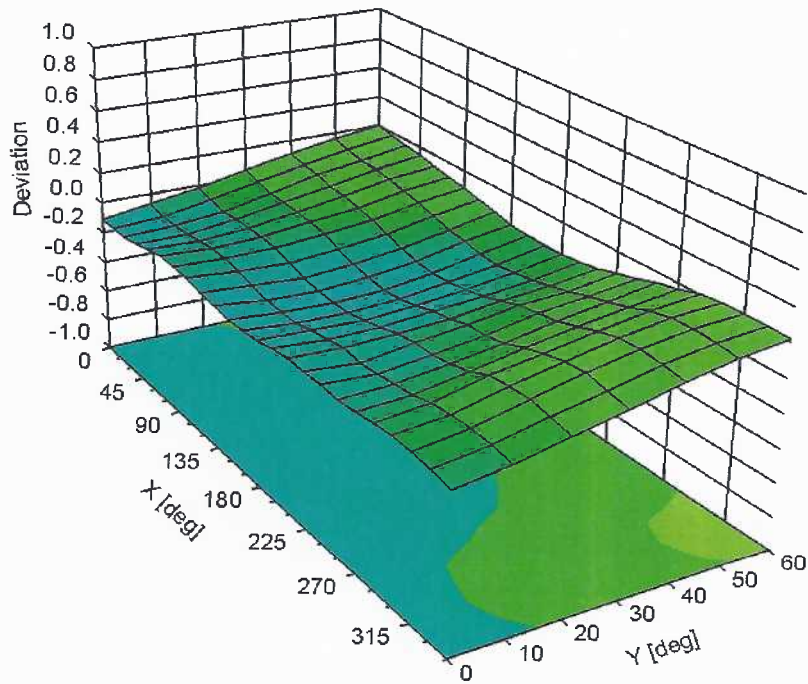

## DASY/EASY - Parameters of Probe: ES3DV3 - SN:3311

### Other Probe Parameters

Sensor Arrangement	Triangular
Connector Angle (°)	60.4
Mechanical Surface Detection Mode	enabled
Optical Surface Detection Mode	disabled
Probe Overall Length	337 mm
Probe Body Diameter	10 mm
Tip Length	10 mm
Tip Diameter	4 mm
Probe Tip to Sensor X Calibration Point	2 mm
Probe Tip to Sensor Y Calibration Point	2 mm
Probe Tip to Sensor Z Calibration Point	2 mm
Recommended Measurement Distance from Surface	3 mm

## Appendix E – Dipole Calibration Data Sheets

gm

**Calibration Laboratory of  
Schmid & Partner  
Engineering AG**  
Zeughausstrasse 43, 8004 Zurich, Switzerland



**S** Schweizerischer Kalibrierdienst  
**C** Service suisse d'étalonnage  
**S** Servizio svizzero di taratura  
**S** Swiss Calibration Service

Accredited by the Swiss Accreditation Service (SAS)  
**The Swiss Accreditation Service is one of the signatories to the EA  
Multilateral Agreement for the recognition of calibration certificates**

**Accreditation No.: SCS 0108**

**Client RF Exposure Lab**

**Certificate No: D450V3-1085\_Jan16**

## CALIBRATION CERTIFICATE

**Object D450V3 - SN: 1085**

**Calibration procedure(s) QA CAL-15.v8  
Calibration procedure for dipole validation kits below 700 MHz**

**Calibration date: January 14, 2016**

This calibration certificate documents the traceability to national standards, which realize the physical units of measurements (SI).  
The measurements and the uncertainties with confidence probability are given on the following pages and are part of the certificate.

All calibrations have been conducted in the closed laboratory facility: environment temperature (22 ± 3)°C and humidity < 70%.

Calibration Equipment used (M&TE critical for calibration)

Primary Standards	ID #	Cal Date (Certificate No.)	Scheduled Calibration
Power meter E4419B	GB41293874	01-Apr-15 (No. 217-02128)	Mar-16
Power sensor E4412A	MY41498087	01-Apr-15 (No. 217-02128)	Mar-16
Reference 3 dB Attenuator	SN: S5054 (3c)	01-Apr-15 (No. 217-02129)	Mar-16
Reference 20 dB Attenuator	SN: S5058 (20k)	01-Apr-15 (No. 217-02131)	Mar-16
Type-N mismatch combination	SN: 5047.2 / 06327	01-Apr-15 (No. 217-02134)	Mar-16
Reference Probe ET3DV6	SN: 1507	31-Dec-15 (No. ET3-1507_Dec15)	Dec-16
DAE4	SN: 654	08-Jul-15 (No. DAE4-654_Jul15)	Jul-16
Secondary Standards	ID #	Check Date (in house)	Scheduled Check
RF generator HP 8648C	US3642U01700	04-Aug-99 (in house check Apr-13)	In house check: Apr-16
Network Analyzer HP 8753E	US37390585 S4206	18-Oct-01 (in house check Oct-15)	In house check: Oct-16

**Calibrated by:** Name **Leif Klysner** Function **Laboratory Technician**

Signature

**Approved by:** Name **Katja Pokovic** Function **Technical Manager**

Issued: January 18, 2016

This calibration certificate shall not be reproduced except in full without written approval of the laboratory.



Accredited by the Swiss Accreditation Service (SAS)

Accreditation No.: **SCS 0108**

The Swiss Accreditation Service is one of the signatories to the EA  
Multilateral Agreement for the recognition of calibration certificates

### Glossary:

TSL	tissue simulating liquid
ConvF	sensitivity in TSL / NORM x,y,z
N/A	not applicable or not measured

### Calibration is Performed According to the Following Standards:

- IEEE Std 1528-2013, "IEEE Recommended Practice for Determining the Peak Spatial-Averaged Specific Absorption Rate (SAR) in the Human Head from Wireless Communications Devices: Measurement Techniques", June 2013
- IEC 62209-1, "Procedure to measure the Specific Absorption Rate (SAR) for hand-held devices used in close proximity to the ear (frequency range of 300 MHz to 3 GHz)", February 2005
- IEC 62209-2, "Procedure to determine the Specific Absorption Rate (SAR) for wireless communication devices used in close proximity to the human body (frequency range of 30 MHz to 6 GHz)", March 2010
- KDB 865664, "SAR Measurement Requirements for 100 MHz to 6 GHz"

### Additional Documentation:

- DASY4/5 System Handbook

### Methods Applied and Interpretation of Parameters:

- Measurement Conditions:** Further details are available from the Validation Report at the end of the certificate. All figures stated in the certificate are valid at the frequency indicated.
- Antenna Parameters with TSL:** The dipole is mounted with the spacer to position its feed point exactly below the center marking of the flat phantom section, with the arms oriented parallel to the body axis.
- Feed Point Impedance and Return Loss:** These parameters are measured with the dipole positioned under the liquid filled phantom. The impedance stated is transformed from the measurement at the SMA connector to the feed point. The Return Loss ensures low reflected power. No uncertainty required.
- Electrical Delay:** One-way delay between the SMA connector and the antenna feed point. No uncertainty required.
- SAR measured:** SAR measured at the stated antenna input power.
- SAR normalized:** SAR as measured, normalized to an input power of 1 W at the antenna connector.
- SAR for nominal TSL parameters:** The measured TSL parameters are used to calculate the nominal SAR result.

The reported uncertainty of measurement is stated as the standard uncertainty of measurement multiplied by the coverage factor  $k=2$ , which for a normal distribution corresponds to a coverage probability of approximately 95%.

## Measurement Conditions

DASY system configuration, as far as not given on page 1.

<b>DASY Version</b>	DASY5	V52.8.8
<b>Extrapolation</b>	Advanced Extrapolation	
<b>Phantom</b>	ELI4 Flat Phantom	Shell thickness: $2 \pm 0.2$ mm
<b>Distance Dipole Center - TSL</b>	15 mm	with Spacer
<b>Zoom Scan Resolution</b>	dx, dy, dz = 5 mm	
<b>Frequency</b>	450 MHz $\pm$ 1 MHz	

## Head TSL parameters

The following parameters and calculations were applied.

	Temperature	Permittivity	Conductivity
<b>Nominal Head TSL parameters</b>	22.0 °C	43.5	0.87 mho/m
<b>Measured Head TSL parameters</b>	(22.0 $\pm$ 0.2) °C	44.2 $\pm$ 6 %	0.90 mho/m $\pm$ 6 %
<b>Head TSL temperature change during test</b>	< 0.5 °C	----	----

## SAR result with Head TSL

<b>SAR averaged over 1 cm<sup>3</sup> (1 g) of Head TSL</b>	Condition	
SAR measured	250 mW input power	1.15 W/kg
SAR for nominal Head TSL parameters	normalized to 1W	<b>4.50 W/kg <math>\pm</math> 18.1 % (k=2)</b>

<b>SAR averaged over 10 cm<sup>3</sup> (10 g) of Head TSL</b>	condition	
SAR measured	250 mW input power	0.770 W/kg
SAR for nominal Head TSL parameters	normalized to 1W	<b>3.02 W/kg <math>\pm</math> 17.6 % (k=2)</b>

## Body TSL parameters

The following parameters and calculations were applied.

	Temperature	Permittivity	Conductivity
<b>Nominal Body TSL parameters</b>	22.0 °C	56.7	0.94 mho/m
<b>Measured Body TSL parameters</b>	(22.0 $\pm$ 0.2) °C	56.9 $\pm$ 6 %	0.95 mho/m $\pm$ 6 %
<b>Body TSL temperature change during test</b>	< 0.5 °C	----	----

## SAR result with Body TSL

<b>SAR averaged over 1 cm<sup>3</sup> (1 g) of Body TSL</b>	Condition	
SAR measured	250 mW input power	1.14 W/kg
SAR for nominal Body TSL parameters	normalized to 1W	<b>4.53 W/kg <math>\pm</math> 18.1 % (k=2)</b>

<b>SAR averaged over 10 cm<sup>3</sup> (10 g) of Body TSL</b>	condition	
SAR measured	250 mW input power	0.748 W/kg
SAR for nominal Body TSL parameters	normalized to 1W	<b>2.97 W/kg <math>\pm</math> 17.6 % (k=2)</b>

## Appendix (Additional assessments outside the scope of SCS 0108)

### Antenna Parameters with Head TSL

Impedance, transformed to feed point	57.6 $\Omega$ - 3.4 j $\Omega$
Return Loss	- 22.2 dB

### Antenna Parameters with Body TSL

Impedance, transformed to feed point	54.3 $\Omega$ - 8.2 j $\Omega$
Return Loss	- 21.1 dB

### General Antenna Parameters and Design

Electrical Delay (one direction)	1.348 ns
----------------------------------	----------

After long term use with 100W radiated power, only a slight warming of the dipole near the feedpoint can be measured.

The dipole is made of standard semirigid coaxial cable. The center conductor of the feeding line is directly connected to the second arm of the dipole. The antenna is therefore short-circuited for DC-signals. On some of the dipoles, small end caps are added to the dipole arms in order to improve matching when loaded according to the position as explained in the "Measurement Conditions" paragraph. The SAR data are not affected by this change. The overall dipole length is still according to the Standard.

No excessive force must be applied to the dipole arms, because they might bend or the soldered connections near the feedpoint may be damaged.

### Additional EUT Data

Manufactured by	SPEAG
Manufactured on	October 10, 2012

#### Extended Calibration

Usage of SAR dipoles calibrated less than 3 years ago but more than 1 year ago were confirmed in maintaining return loss (<-20 dB, within 20% of prior calibration) and impedance (within 5 ohm from prior calibration) requirements per extended calibrations in KDB Publication 865664 D01 v01r04.

D450V2 SN:1085 - Head						
Date of Measurement	Return Loss (dB)	$\Delta\%$	Impedance ( $\Omega$ )	$\Delta\Omega$	Impedance Imaginary (j $\Omega$ )	$\Delta\Omega$
1/14/2016	-22.2		57.6		-3.4	
1/17/2017	-21.9	-1.4	58.2	0.6	-3.1	0.3
1/15/2018	-22.6	1.8	58.3	0.7	-3.6	-0.2
D450V2 SN:1085 - Body						
Date of Measurement	Return Loss (dB)	$\Delta\%$	Impedance ( $\Omega$ )	$\Delta\Omega$	Impedance Imaginary (j $\Omega$ )	$\Delta\Omega$
1/14/2016	-21.1		54.3		-8.2	
1/17/2017	-22.2	5.2	55.3	1.0	-7.5	0.7
1/15/2018	-21.6	2.4	53.9	-0.4	-7.9	0.3



# DASY5 Validation Report for Head TSL

Date: 11.01.2016

Test Laboratory: SPEAG, Zurich, Switzerland

**DUT: Dipole 450 MHz; Type: D450V3; Serial: D450V3 - SN: 1085**

Communication System: UID 0 - CW; Frequency: 450 MHz

Medium parameters used:  $f = 450$  MHz;  $\sigma = 0.9$  S/m;  $\epsilon_r = 44.2$ ;  $\rho = 1000$  kg/m<sup>3</sup>

Phantom section: Flat Section

Measurement Standard: DASY5 (IEEE/IEC/ANSI C63.19-2011)

DASY52 Configuration:

- Probe: ET3DV6 - SN1507; ConvF(6.58, 6.58, 6.58); Calibrated: 31.12.2015;
- Sensor-Surface: 4mm (Mechanical Surface Detection)
- Electronics: DAE4 Sn654; Calibrated: 08.07.2015
- Phantom: ELI v4.0; Type: QDOVA001BB; Serial: TP:1003
- DASY52 52.8.8(1258); SEMCAD X 14.6.10(7372)

## Dipole Calibration for Head Tissue/d=15mm, Pin=250mW/Zoom Scan (7x7x7)/Cube 0:

Measurement grid: dx=5mm, dy=5mm, dz=5mm

Reference Value = 39.28 V/m; Power Drift = -0.03 dB

Peak SAR (extrapolated) = 1.66 W/kg

**SAR(1 g) = 1.15 W/kg; SAR(10 g) = 0.770 W/kg**

Maximum value of SAR (measured) = 1.24 W/kg

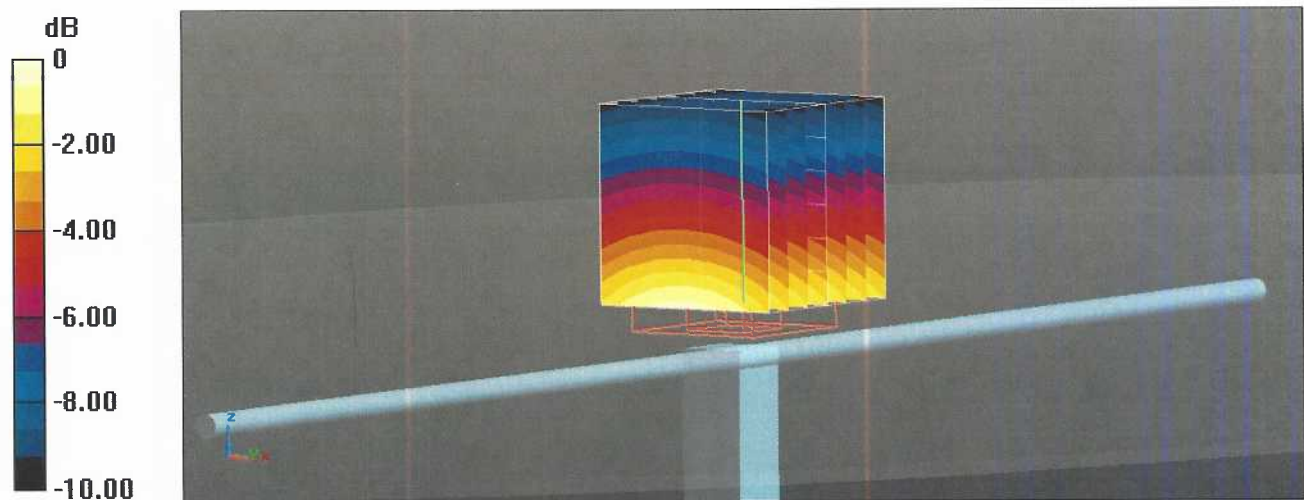

# Impedance Measurement Plot for Head TSL

11 Jan 2016 15:59:39

CH1 S11 1 U FS 1: 57.611  $\Omega$  -3.4121  $\Omega$  103.65 pF 450.000 000 MHz

\*  
Del  
Cor

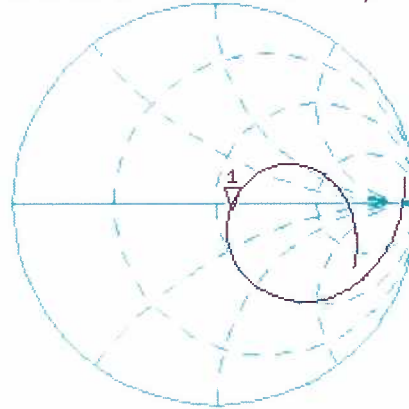

Avg  
16

H1d

CH2 S11 LOG 5 dB/REF -20 dB 1:-22.212 dB 450.000 000 MHz

Cor

Avg  
16

H1d

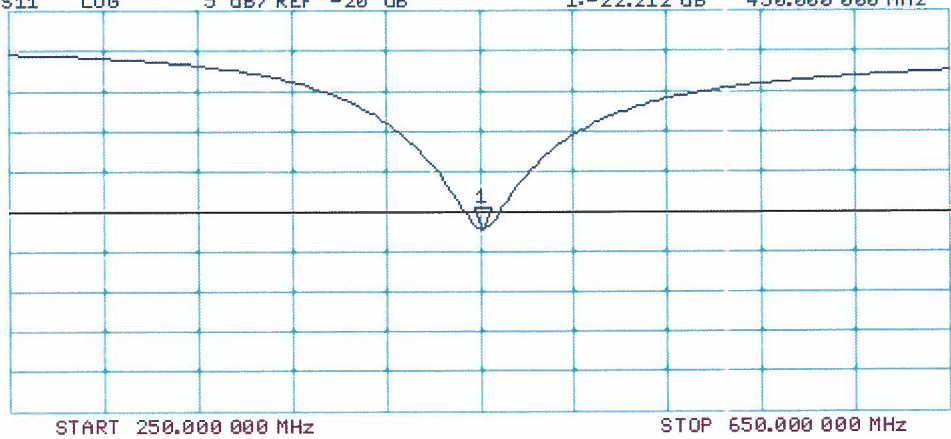

## DASY5 Validation Report for Body TSL

Date: 14.01.2016

Test Laboratory: SPEAG, Zurich, Switzerland

**DUT: Dipole 450 MHz; Type: D450V3; Serial: D450V3 - SN: 1085**

Communication System: UID 0 - CW; Frequency: 450 MHz

Medium parameters used:  $f = 450$  MHz;  $\sigma = 0.95$  S/m;  $\epsilon_r = 56.9$ ;  $\rho = 1000$  kg/m<sup>3</sup>

Phantom section: Flat Section

Measurement Standard: DASY5 (IEEE/IEC/ANSI C63.19-2011)

DASY52 Configuration:

- Probe: ET3DV6 - SN1507; ConvF(6.99, 6.99, 6.99); Calibrated: 31.12.2015;
- Sensor-Surface: 4mm (Mechanical Surface Detection)
- Electronics: DAE4 Sn654; Calibrated: 08.07.2015
- Phantom: ELI v4.0; Type: QDOVA001BB; Serial: TP:1003
- DASY52 52.8.8(1258); SEMCAD X 14.6.10(7372)

### Dipole Calibration for Body Tissue/d=15mm, Pin=250mW/Zoom Scan (7x7x7)/Cube 0:

Measurement grid: dx=5mm, dy=5mm, dz=5mm

Reference Value = 36.96 V/m; Power Drift = -0.05 dB

Peak SAR (extrapolated) = 1.79 W/kg

**SAR(1 g) = 1.14 W/kg; SAR(10 g) = 0.748 W/kg**

Maximum value of SAR (measured) = 1.21 W/kg

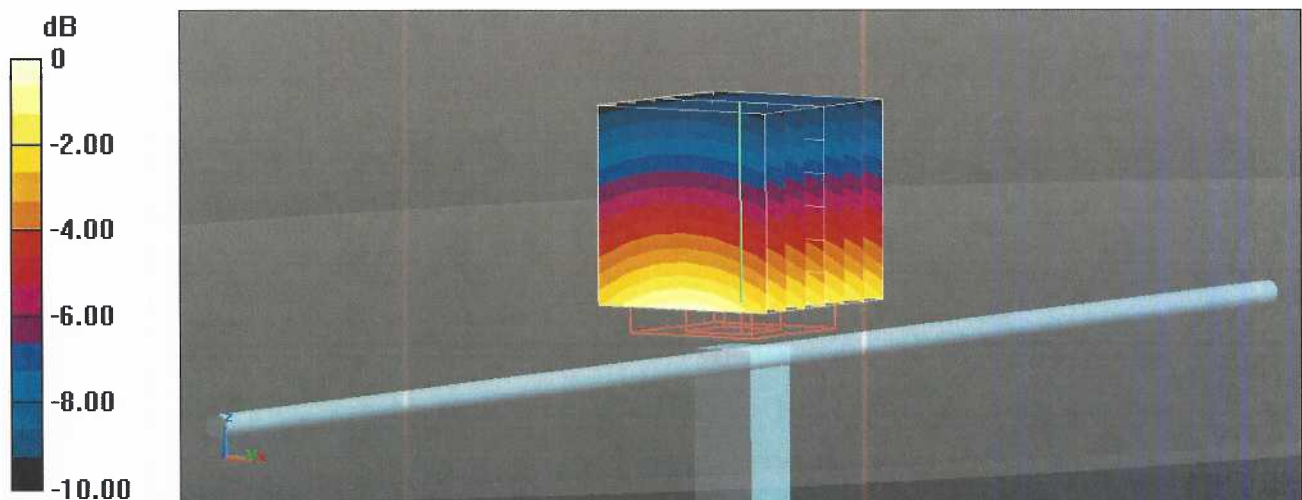

0 dB = 1.21 W/kg = 0.83 dBW/kg

# Impedance Measurement Plot for Body TSL

14 Jan 2016 15:48:31

CH1 S11 1 U FS 1: 54.336  $\Omega$  -8.1914  $\Omega$  43.177 pF 450.000 000 MHz

\*  
De1  
Cor  
Avg  
16  
H1d

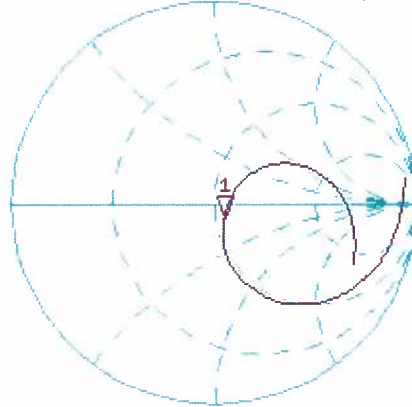

CH2 S11 LOG 5 dB/REF -20 dB 1:-21.056 dB 450.000 000 MHz

De1  
Cor  
Avg  
16  
H1d

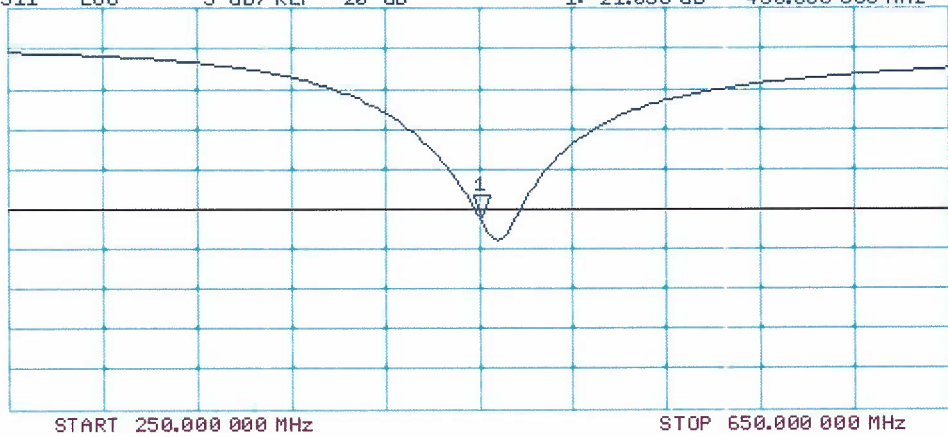

## **Appendix F – Phantom Calibration Data Sheets**

Zeughausstrasse 43, 8004 Zurich, Switzerland  
 Phone +41 44 245 9700, Fax +41 44 245 9779  
 info@speag.com, http://www.speag.com

## Certificate of Conformity / First Article Inspection

Item	Oval Flat Phantom ELI 4.0
Type No	QD OVA 001 B
Series No	1003 and higher
Manufacturer	Untersee Composites Knebelstrasse 8 CH-8268 Mannenbach, Switzerland

### Tests

Complete tests were made on the prototype units QD OVA 001 AA 1001, QD OVA 001 AB 1002, pre-series units QD OVA 001 BA 1003-1005 as well as on the series units QD OVA 001 BB, 1006 ff.

Test	Requirement	Details	Units tested
Material thickness	Compliant with the standard requirements	Bottom plate: 2.0mm +/- 0.2mm	all
Material parameters	Dielectric parameters for required frequencies	< 6 GHz: Rel. permittivity = 4 +/-1, Loss tangent ≤ 0.05	Material sample
Material resistivity	The material has been tested to be compatible with the liquids defined in the standards if handled and cleaned according to the instructions.	DGBE based simulating liquids. Observe Technical Note for material compatibility.	Equivalent phantoms, Material sample
Shape	Thickness of bottom material, Internal dimensions, Sagging compatible with standards from minimum frequency	Bottom elliptical 600 x 400 mm Depth 190 mm, Shape is within tolerance for filling height up to 155 mm, Eventual sagging is reduced or eliminated by support via DUT	Prototypes, Sample testing

### Standards

- [1] CENELEC EN 50361-2001, « Basic standard for the measurement of the Specific Absorption Rate related to human exposure to electromagnetic fields from mobile phones (300 MHz – 3 GHz) », July 2001
- [2] IEEE 1528-2003, "Recommended Practice for Determining the Peak Spatial-Average Specific Absorption Rate (SAR) in the Human Head from Wireless Communications Devices: Measurement Techniques, December 2003
- [3] IEC 62209 – 1, "Specific Absorption Rate (SAR) in the frequency range of 300 MHz to 3 GHz – Measurement Procedure, Part 1: Hand-held mobile wireless communication devices", February 2005
- [4] IEC 62209 – 2, Draft, "Human Exposure to Radio Frequency Fields from Handheld and Body-Mounted Wireless Communication Devices – Human models, Instrumentation and Procedures – Part 2: Procedure to determine the Specific Absorption Rate (SAR) in the head and body for 30 MHz to 6 GHz Handheld and Body-Mounted Devices used in close proximity to the Body.", February 2005
- [5] OET Bulletin 65, Supplement C, "Evaluating Compliance with FCC Guidelines for Human Exposure to Radiofrequency Electromagnetic Fields", Edition January 2001

Based on the tests above, we certify that this item is in compliance with the standards [1] to [5] if operated according to the specific requirements and considering the thickness. The dimensions are fully compliant with [4] from 30 MHz to 6 GHz. For the other standards, the minimum lower frequency limit is limited due to the dimensional requirements ([1]: 450 MHz, [2]: 300 MHz, [3]: 800 MHz, [5]: 375 MHz) and possibly further by the dimensions of the DUT.

Date 28.4.2008

Signature / Stamp

**s p e a g**  
 Schmid & Partner Engineering AG  
 Zeughausstrasse 43, 8004 Zurich, Switzerland  
 Phone +41 44 245 9700, Fax +41 44 245 9779  
 info@speag.com; http://www.speag.com

## Appendix G – Validation Summary

Per FCC KDB 865664 D02 v01r02, SAR system validation status should be documented to confirm measurement accuracy. The SAR systems (including SAR probes, system components and software versions) used for this device were validated against its performance specifications prior to the SAR measurements. Reference dipoles were used with the required tissue equivalent media for system validation according to the procedures outlined in FCC KDB 865664 D01 v01r04 and IEEE 1528-2013. Since SAR probe calibrations are frequency dependent, each probe calibration point was validated at a frequency within the valid frequency range of the probe calibration point using the system that normally operates with the probe for routine SAR measurements and according to the required tissue equivalent media.

A tabulated summary of the system validation status including the validation date(s), measurement frequencies, SAR probes and tissue dielectric parameters has been included.

**Table G-1  
SAR System Validation Summary**

SAR System #	Freq. (MHz)	Date	Probe S/N	Probe Type	Probe Cal. Point	Cond. ( $\sigma$ )	Perm. ( $\epsilon_r$ )	CW Validation			Modulation Validation			
								Sens-itivity	Probe Linearity	Probe Isotropy	Modulation Type	Duty Factor	PAR	
2	450	10/12/2018	3311	ES3DV3	450	Head	0.88	43.55	Pass	Pass	Pass	FM	N/A	Pass
2	450	10/11/2018	3311	ES3DV3	450	Body	0.93	56.66	Pass	Pass	Pass	FM	N/A	Pass