

LABORATORY TEST REPORT
RADIO PERFORMANCE MEASUREMENTS

for the

TPDB1C Handportable Transceiver

Tested in accordance with:

FCC 47 CFR Parts 22 and 90

RSS-119 Issue 12
RSS-Gen Issue 4

Report Revision: 1
Issue Date: 22 January 2018

PREPARED BY: Alf Schinkelshoek

Test Technician

CHECKED & APPROVED BY: M. C. James

Laboratory Technical Manager



IANZ
ACCREDITED LABORATORY

FCC LISTING REGISTRATION: 838288
OATS IC LISTING REGISTRATION: SITE# 737A-1

All tests reported herein have been performed in accordance with the laboratory's scope of accreditation.

This document must not be reproduced except in full, without the written permission of the Compliance Laboratory Manager

TELTEST Laboratories (A Division of Tait Communications)
PO Box 1645, 558 Wairakei Road, Christchurch, New Zealand.

Telephone: 64 3 358 3399
FAX: 64 3 359 4632

FCC ID: CASTPDB1C
IC : 737A-TPDB1C

Page 1 of 127

Report Revision: 1
Issue Date: 22 January 2018

TABLE OF CONTENTS

REVISION.....	3
INTRODUCTION.....	4
STATEMENT OF COMPLIANCE.....	5
MODULATION TYPES, NECESSARY BANDWIDTH & EMISSION DESIGNATORS.....	6
TEST RESULTS.....	8
TRANSMITTER OUTPUT POWER (CONDUCTED).....	8
TRANSMITTER AUDIO FREQUENCY RESPONSE - PRE-EMPHASIS.....	10
TRANSMITTER MODULATION LIMITING.....	15
TRANSMITTER OCCUPIED BANDWIDTH AND SPECTRUM MASKS.....	20
TRANSMITTER SPURIOUS EMISSIONS (CONDUCTED).....	75
TRANSMITTER SPURIOUS EMISSIONS (RADIATED).....	95
TRANSIENT FREQUENCY BEHAVIOR.....	101
TRANSMITTER FREQUENCY STABILITY - TEMPERATURE.....	120
TRANSMITTER FREQUENCY STABILITY - VOLTAGE.....	122
RECEIVER SPURIOUS EMISSIONS (CONDUCTED).....	123
TEST EQUIPMENT LIST.....	125
ANNEX A – TEST SETUP DETAILS.....	127

REVISION

Date	Revision	Comments
22 January 2018	1	Initial test report

INTRODUCTION

Type approval testing of the TPDB1C, 5 Watt, Hand portable transceiver in order to demonstrate compliance with FCC 47 Parts 22 & 90, and RSS-119 Issue 12 & RSS-Gen Issue 4. This radio supports analogue, digital FFSK, Digital Mobile Radio (DMR), APCO P25 phase-1 and APCO P25 phase-2 modulations.

REPORT PREPARED FOR

Tait Ltd
245 Wooldridge Road
Harewood
Christchurch 8051
New Zealand

DESCRIPTION OF SAMPLE

Manufacturer: Tait Limited
Equipment: Handportable Transceiver
Type: TPDB1C
Product Code: T03-00072-BCAB
Serial Number(s): 25939660
Frequency range: 136 → 174 MHz
Transmit Power: 5 W

Modulation		Channel Spacing	Speech Channels	Symbol Rate (symbols/sec)	Data Rate (bps)
Analogue FM		12.5 kHz	1	-	-
FFSK	Fast Frequency Shift Keying	12.5 kHz	-	1200	1200
		12.5 kHz	-	2400	2400
Digital Mobile Radio (DMR)	4 Level FSK (2 slot TDMA) (ETSI TS102 361-1)	12.5 kHz	2	4800	9600
APCO P25 Phase 1	C4FM (TIA 102)	12.5 kHz	1	4800	9600
APCO P25 Phase 2	H-CPM (2 slot TDMA) (TIA 102)	12.5 kHz	2	6000	12000

HARDWARE & SOFTWARE

Quantity: 1

	Analogue, FFSK and DMR tests	P25 tests
Hardware ID	TPDB1X-C000_0008	TPDB2X-B100_0001
Boot Code	QPD1B_S00_3.01.03.0001	QPD2B_S00_3.03.00.0002
DSP	QPD1A_E00_2.15.02.0066	QPD2A_A02ML_2.12.00.0603
Radio Application	QPD1F_E00_2.15.02.0066	QPD2F_A00ML_2.12.00.0603
FPGA Image	QI93P_E00_2.15.02.0066	QPD2G_S01_1.12.00.0004

TEST CONDITIONS

All testing was performed between 03 → 16 January 2018, and under the following conditions:

Ambient temperature: 15°C → 30°C
Relative Humidity: 20% → 75%
Standard Test Voltage: 7.5 V_{DC}

STATEMENT OF COMPLIANCE

We, TELTEST LABORATORIES of 558 Wairakei Road, Christchurch, New Zealand, declare under our sole responsibility that the product:

Equipment: Hand portable Transceiver
Type: TPDB1C
Product Code: T03-00072-BCAB
Serial Number(s): 25939660
Quantity: 1

to which this declaration relates, is in conformity with the following standards:

FCC 47 CFR Parts 22 and 90

RSS-119 Issue 12, RSS-Gen Issue 4 & ICES003 Issue 5

Signature:



M. C. James
Laboratory Technical Manager

Date:

7 February 2017

MODULATION TYPES, NECESSARY BANDWIDTH & EMISSION DESIGNATORS

MODULATION TYPES:

F3E	Analogue Frequency Modulation (FM)	
F2D	FFSK	1200 bps and 2400 bps
FXW	DMR Digital Voice	9600 bps
FXD	DMR Digital Data	9600 bps
F1E, F7E	P25 phase 1 Digital Voice	9600 bps
F1D, F7D	P25 phase 1 Digital Data	9600 bps
F1W	P25 phase 2 Digital Voice / Data	12000 bps

CHANNEL SPACING: 12.5 kHz

EMISSION DESIGNATORS:

	12.5 kHz
Analog FM	11K0F3E
FFSK Data 1200 bps	6K60F2D
FFSK Data 2400 bps	7K80F2D
Digital Voice DMR	7K60FXW
Digital Data DMR	7K60FXD
Digital Voice P25 phase 1	8K10F1E
Digital Data P25 phase 1	8K10F1D
Digital Voice P25 phase 2	8K10F1W
Digital Data P25 phase 2	8K10F1W

CALCULATIONS

Equation: $B_n = 2M + 2Dk$

(M is highest modulating frequency; D is peak allowable deviation; k is a constant of 1 for FM)

Analogue Voice 12.5 kHz Bandwidth

Necessary bandwidth

M = 3.0 kHz

D = 2.5 kHz

$$B_n = (2 \times 3.0) + (2 \times 2.5) \times 1$$

$$= 11.0 \text{ kHz}$$

Emission Designator

11K0F3E

F3E represents an FM voice transmission

Fast Frequency Shift Keying (FFSK – 1200 bps) 12.5 kHz Bandwidth

Necessary bandwidth

M = 1.8 kHz

D = 1.5 kHz (60% of peak deviation)

$$B_n = (2 \times 1.8) + (2 \times 1.5) \times 1$$

$$= 6.6 \text{ kHz}$$

Emission Designator

6K60F2D

F2D represents a FM data transmission with the use of a modulating sub carrier

Fast Frequency Shift Keying (FFSK – 2400 bps) 12.5 kHz Bandwidth

Necessary bandwidth

M = 2.4 kHz

D = 1.5 kHz (60% of peak deviation)

$$B_n = (2 \times 2.4) + (2 \times 1.5) \times 1$$

$$= 7.8 \text{ kHz}$$

Emission Designator

7K80F2D

F2D represents a FM data transmission with the use of a modulating sub carrier

Emission Designators – Continued

Digital Voice 12.5 kHz Bandwidth DMR

99% bandwidth
= 7.6 kHz

Emission Designator
7K60FXW

FXW represents a FM Time Division Multiple Access (TDMA) combination of data and telephony

Digital Data 12.5 kHz Bandwidth DMR

99% bandwidth
= 7.6 kHz

Emission Designator
7K60FXD

FXD represents FM Time Division Multiple Access (TDMA) data only

Digital Voice 12.5 kHz Bandwidth P25 phase 1

99% bandwidth
= 8.1 kHz

Emission Designator
8K10F1E

F1E represents a digital FM voice transmission

Digital Data 12.5 kHz Bandwidth P25 phase 1

99% bandwidth
= 8.1 kHz

Emission Designator
8K10F1D

F1D represents an digital FM data transmission

Digital Voice 12.5 kHz Bandwidth P25 phase 2

99% bandwidth
= 8.1 kHz

Emission Designator
8K10F1W

F1W represents a single FM telephony channel

Digital Data 12.5 kHz Bandwidth P25 phase 2

99% bandwidth
= 8.1 kHz

Emission Designator
8K10F1W

F1W represents digital FM data transmission

TEST RESULTS

TRANSMITTER OUTPUT POWER (CONDUCTED)

SPECIFICATION: FCC 47 CFR 2.1046
RSS-119 5.4

GUIDE: TIA/EIA-603D 2.2.1

MEASUREMENT PROCEDURE:

1. Refer Annex A for Equipment set up.
2. The coaxial attenuator has an impedance of 50 Ohms.
3. The unmodulated output power was measured with an RF Power meter.

MEASUREMENT RESULTS:

Manufacturer's Rated Output Power:

Switchable: 5 W and 1 W

Nominal 5 W	Measured	Variation (%)	Variation (dB)
138.1 MHz	5.1	1.3	0.1
143.9 MHz	5.0	0.8	0.0
148.1 MHz	5.0	0.6	0.0
149.8 MHz	5.0	0.4	0.0
152.1 MHz	5.0	0.3	0.0
153.1 MHz	5.0	-0.1	0.0
158.1 MHz	5.0	-0.6	0.0
161.1 MHz	5.0	-0.7	0.0
173.1 MHz	5.0	-0.9	0.0
Measurement Uncertainty		± 0.6 dB	

Transmitter Output Power (Conducted) - continued

Nominal 1 W	Measured	Variation (%)	Variation (dB)
138.1 MHz	1.0	2.0	0.1
143.9 MHz	1.0	2.5	0.1
148.1 MHz	1.0	1.4	0.1
149.8 MHz	1.0	1.6	0.1
152.1 MHz	1.0	0.5	0.0
153.1 MHz	1.0	1.3	0.1
158.1 MHz	1.0	-2.0	-0.1
161.1 MHz	1.0	-0.4	0.0
173.1 MHz	1.0	2.7	0.1
Measurement Uncertainty		± 0.6 dB	

LIMIT CLAUSES:

FCC 47 CFR 90.205 (s)

The output power shall not exceed by more than 20%... the manufacturer's rated output power for the particular transmitter specifically listed on the authorization.

RSS-119 5.4

The output power shall be within ±1.0 dB of the manufacturer's rated power.

TRANSMITTER AUDIO FREQUENCY RESPONSE - PRE-EMPHASIS

SPECIFICATION: FCC 47 CFR 2.1047 (a)

GUIDE: TIA/EIA-603D 2.2.6

MEASUREMENT PROCEDURE:

1. Refer Annex A for Equipment set up.
2. An audio input tone of 1000 Hz was applied with the level set to obtain 20% of maximum deviation. This was used as the 0 dB reference point.
3. The AF was varied while the audio level was held constant.
4. The response in dB relative to 1000 Hz was measured.

MEASUREMENT RESULTS:

See the plots on the following pages for 12.5 kHz channel spacing tested at 5 W transmit power.

LIMIT CLAUSE: TIA/EIA-603D 3.2.6

MEASUREMENT UNCERTAINTY: $\pm 1.5\%$

SPECIFICATION: FCC CFR 2.1047 (a)

Tx FREQUENCY: 138.1 MHz

12.5 kHz Channel Spacing

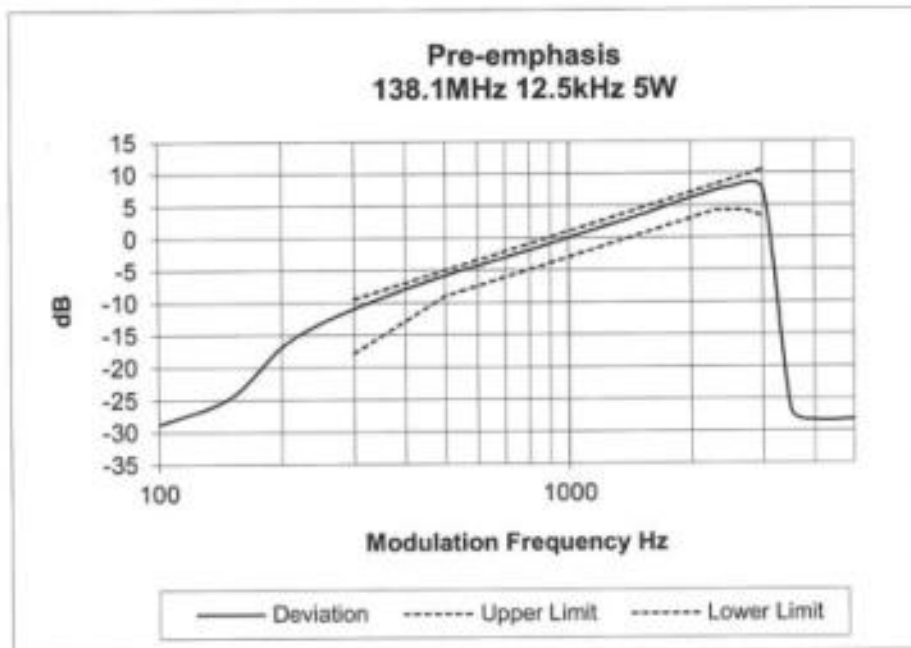

Transmitter Audio Frequency Response – Pre-emphasis

SPECIFICATION: FCC CFR 2.1047 (a)

Tx FREQUENCY: 143.9 MHz

12.5 kHz Channel Spacing

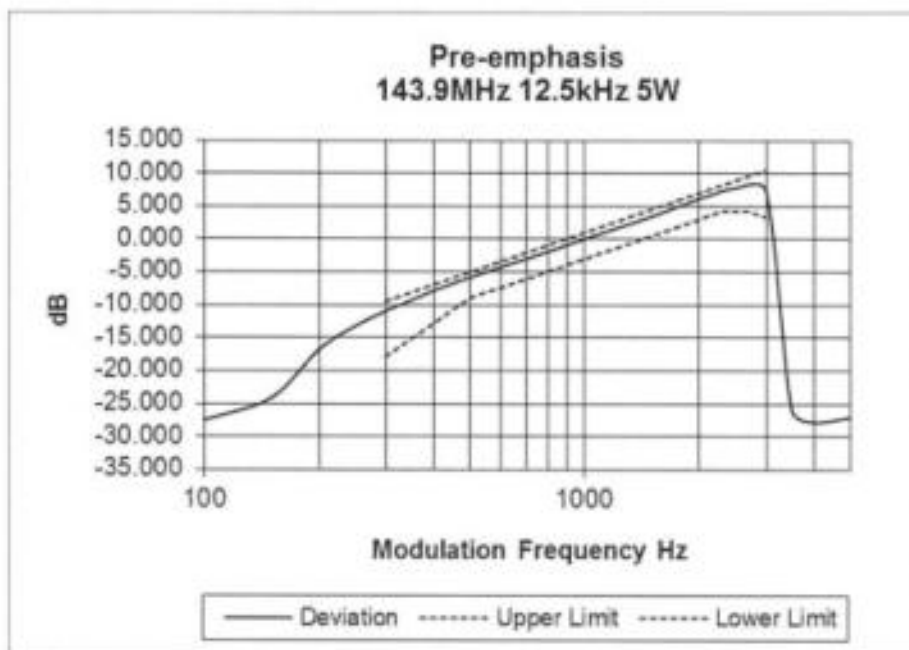

SPECIFICATION: FCC CFR 2.1047 (a)

Tx FREQUENCY: 148.1 MHz

12.5 kHz Channel Spacing

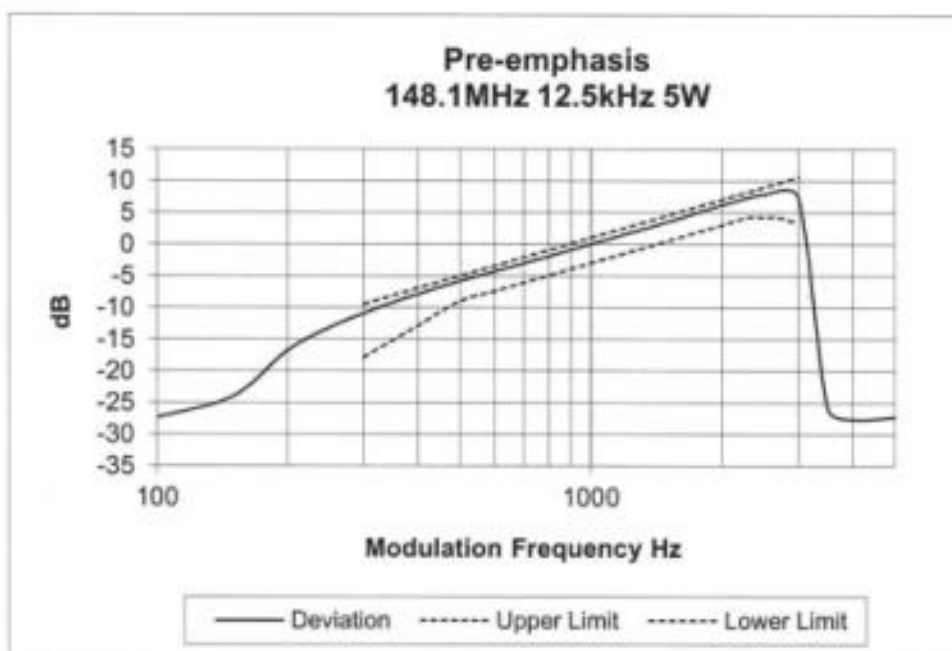

Transmitter Audio Frequency Response – Pre-emphasis

SPECIFICATION: FCC CFR 2.1047 (a)

Tx FREQUENCY: 149.8 MHz

12.5 kHz Channel Spacing

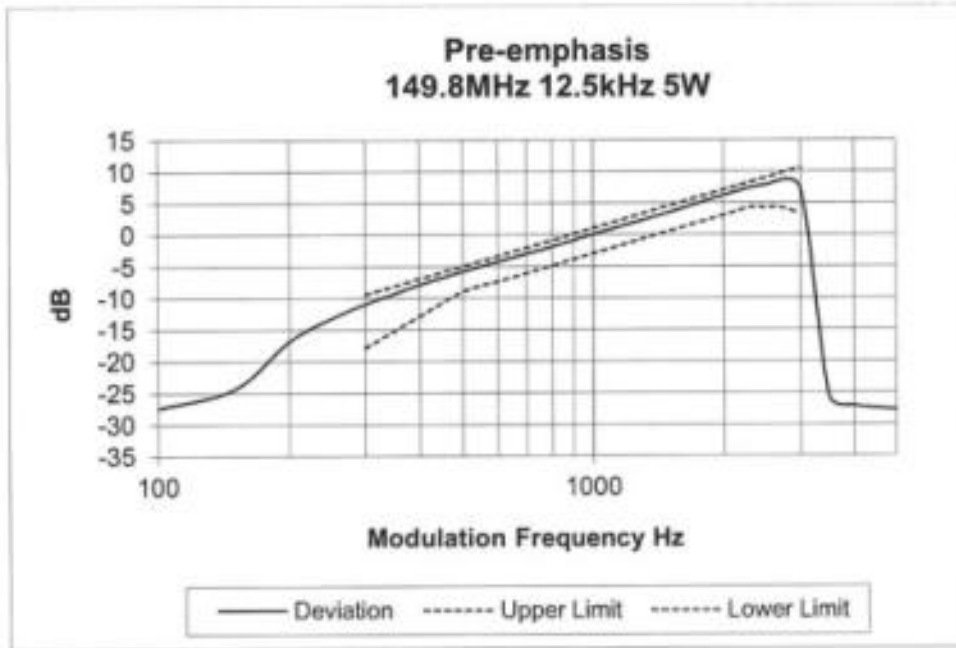

SPECIFICATION: FCC CFR 2.1047 (a)

Tx FREQUENCY: 152.1 MHz

12.5 kHz Channel Spacing

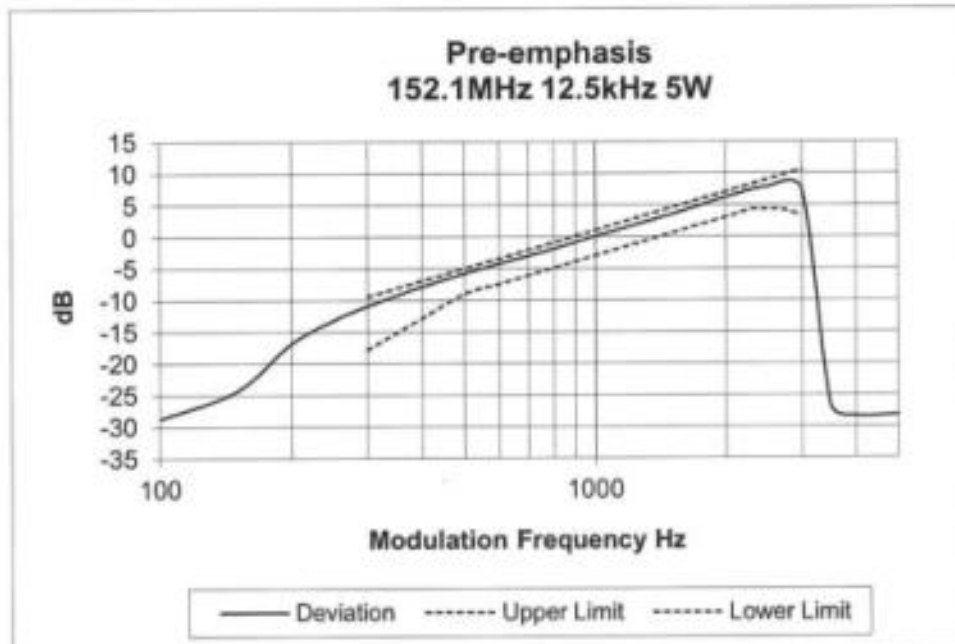

Transmitter Audio Frequency Response – Pre-emphasis

SPECIFICATION: FCC CFR 2.1047 (a)

Tx FREQUENCY: 153.1 MHz

12.5 kHz Channel Spacing

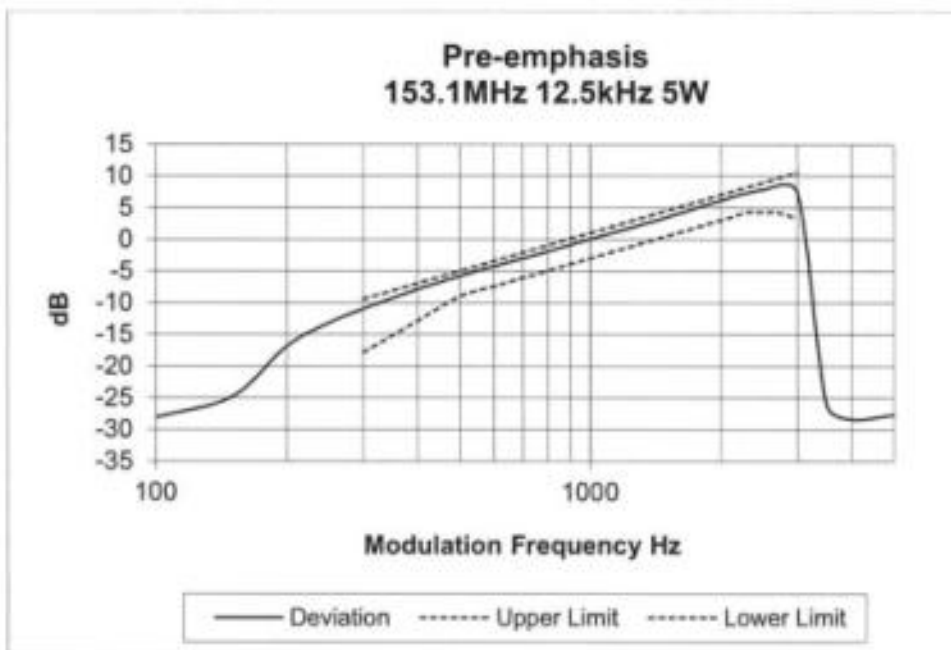

SPECIFICATION: FCC CFR 2.1047 (a)

Tx FREQUENCY: 158.1 MHz

12.5 kHz Channel Spacing

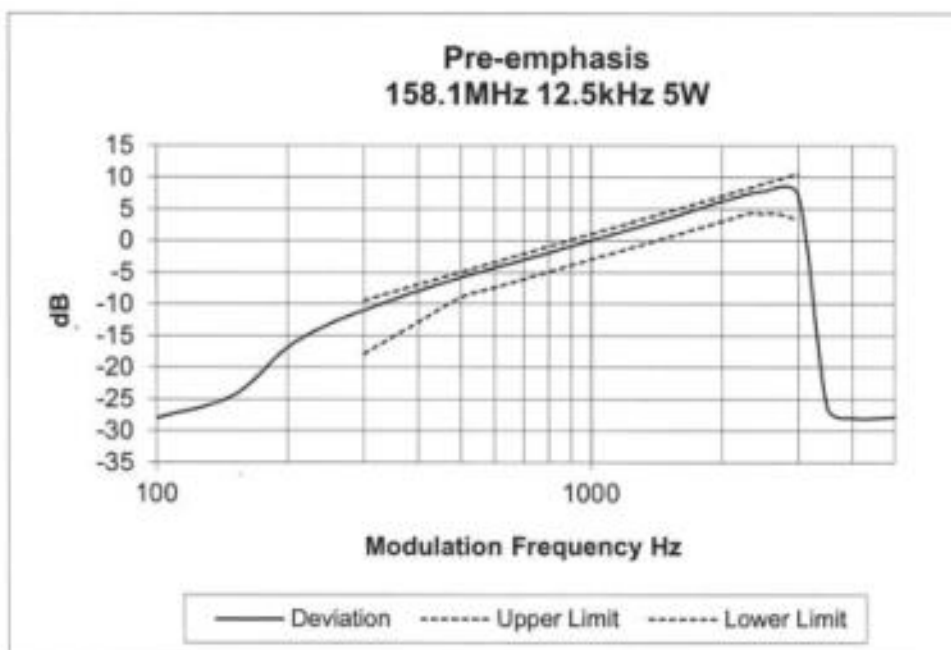

Transmitter Audio Frequency Response – Pre-emphasis

SPECIFICATION: FCC CFR 2.1047 (a)

Tx FREQUENCY: 161.1 MHz

12.5 kHz Channel Spacing

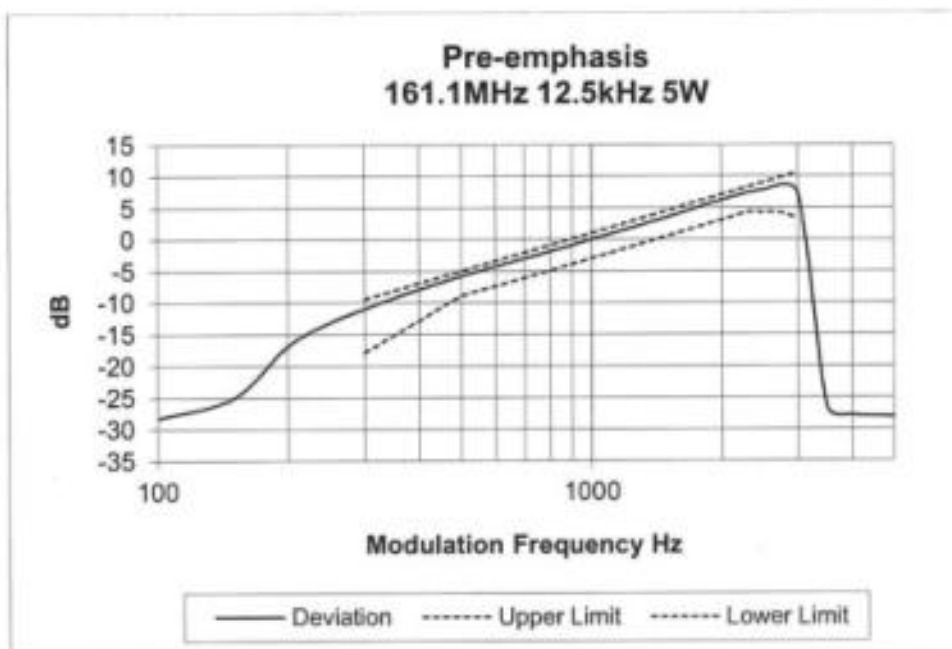

SPECIFICATION: FCC CFR 2.1047 (a)

Tx FREQUENCY: 173.1 MHz

12.5 kHz Channel Spacing

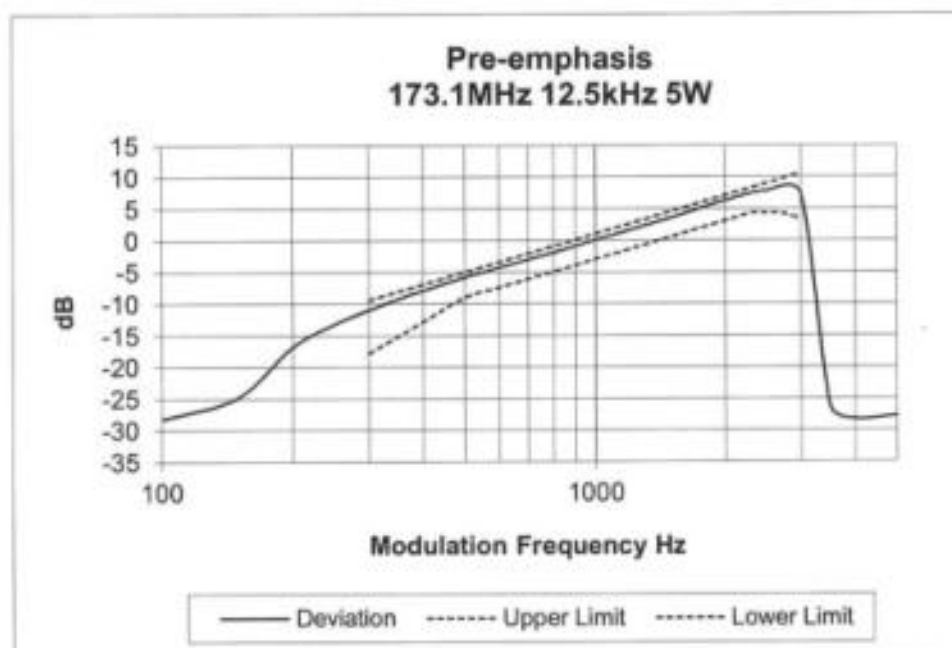

TRANSMITTER MODULATION LIMITING

SPECIFICATION: FCC 47 CFR 2.1047 (b)

GUIDE: TIA/EIA-603D 2.2.3

MEASUREMENT PROCEDURE:

1. Refer Annex A for Equipment set up.
2. The modulation response was measured at three audio frequencies while varying the input level.
3. Measurements were made for both Positive and Negative Deviation.

MEASUREMENT RESULTS:

See the plots on the following pages for 12.5 kHz channel spacing.

LIMIT CLAUSE: TIA/EIA-603D 1.3.4.4

MEASUREMENT UNCERTAINTY: $\pm 1.5\%$

Tx FREQUENCY: 138.1 MHz

12.5 kHz Channel Spacing

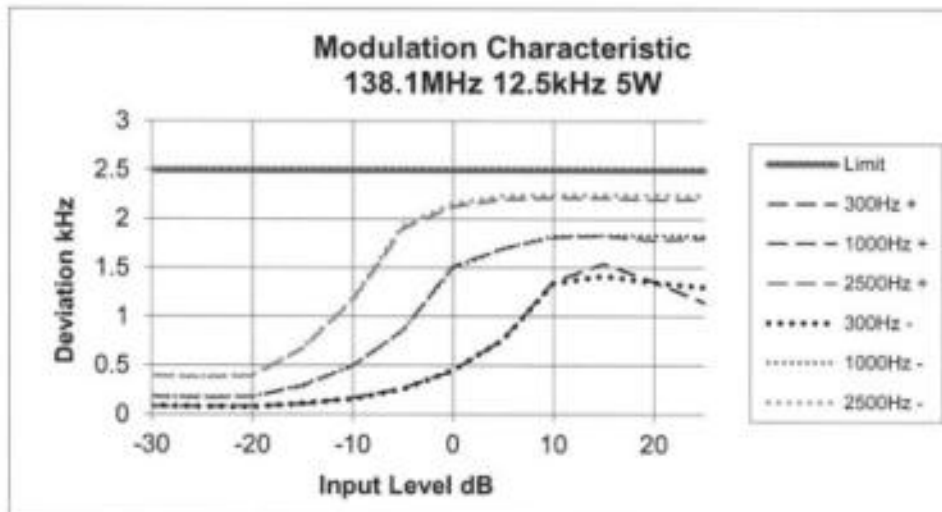

Transmitter Modulation Limiting

SPECIFICATION: FCC CFR 2.1047 (b)

Tx FREQUENCY: 143.9 MHz

12.5 kHz Channel Spacing

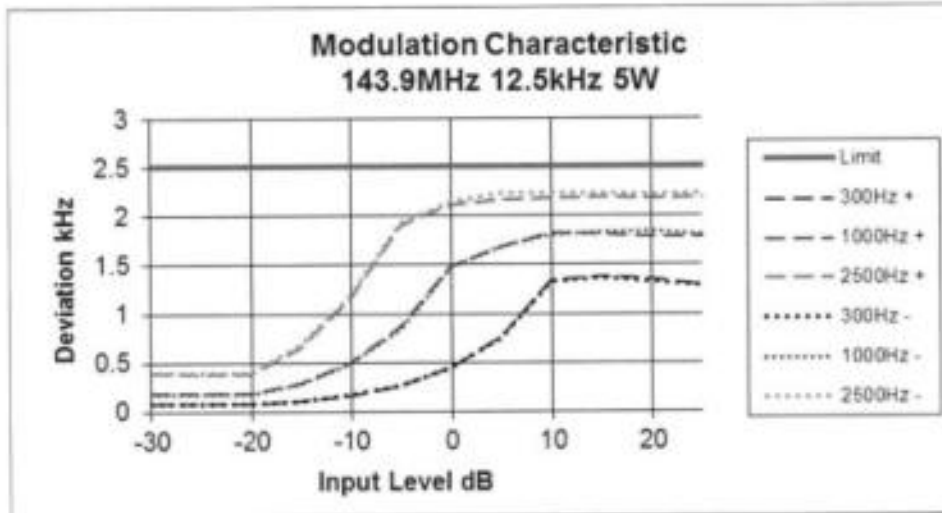

Transmitter Modulation Limiting

SPECIFICATION: FCC CFR 2.1047 (b)

Tx FREQUENCY: 148.1 MHz

12.5 kHz Channel Spacing

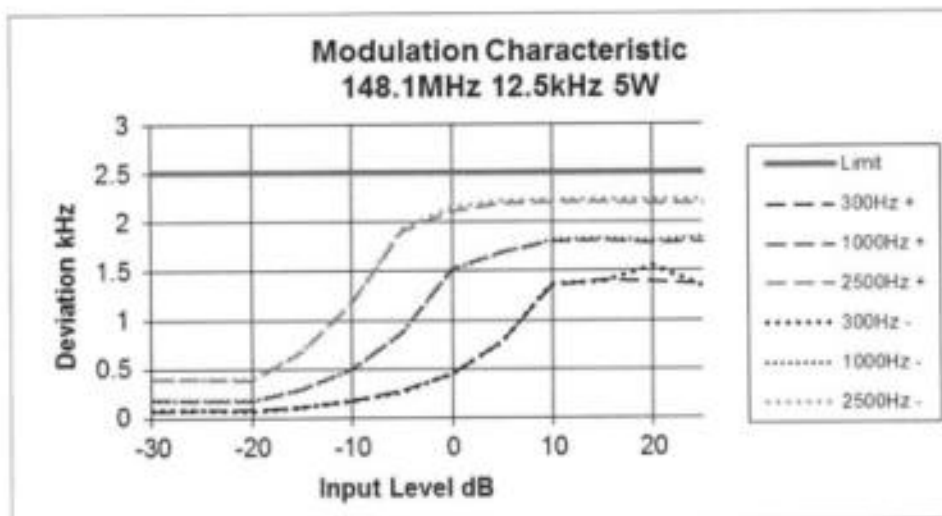

Transmitter Modulation Limiting

SPECIFICATION: FCC CFR 2.1047 (b)

Tx FREQUENCY: 149.8 MHz

12.5 kHz Channel Spacing

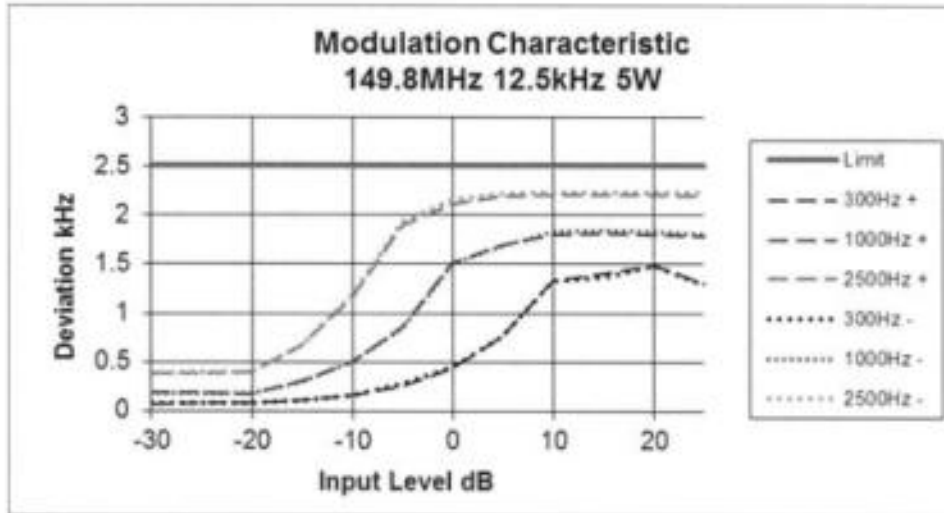

Transmitter Modulation Limiting

SPECIFICATION: FCC CFR 2.1047 (b)

Tx FREQUENCY: 152.1 MHz

12.5 kHz Channel Spacing

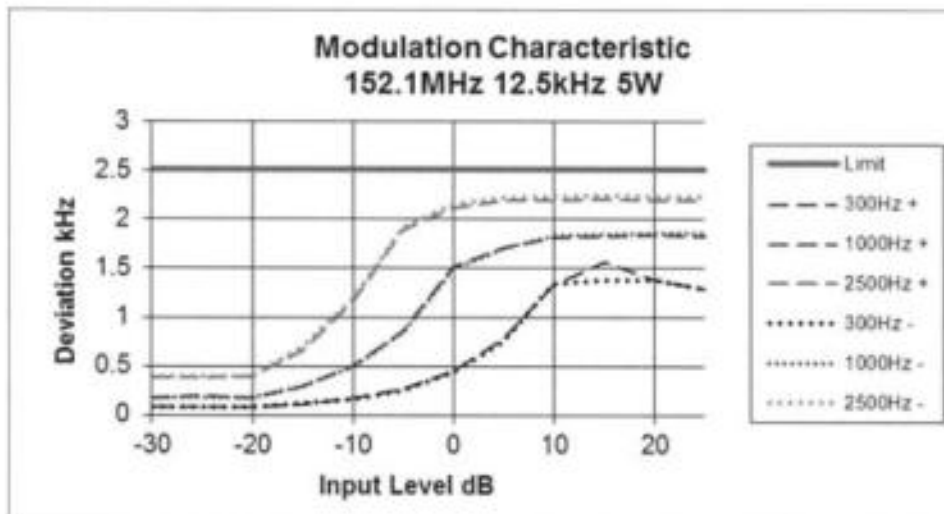

Transmitter Modulation Limiting

SPECIFICATION: FCC CFR 2.1047 (b)

Tx FREQUENCY: 153.1 MHz

12.5 kHz Channel Spacing

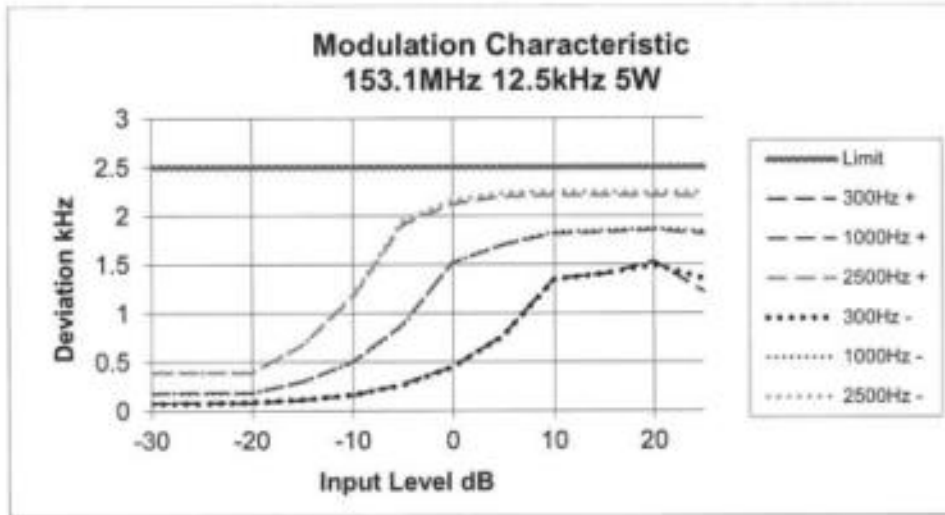

Transmitter Modulation Limiting

SPECIFICATION: FCC CFR 2.1047 (b)

Tx FREQUENCY: 158.1 MHz

12.5 kHz Channel Spacing

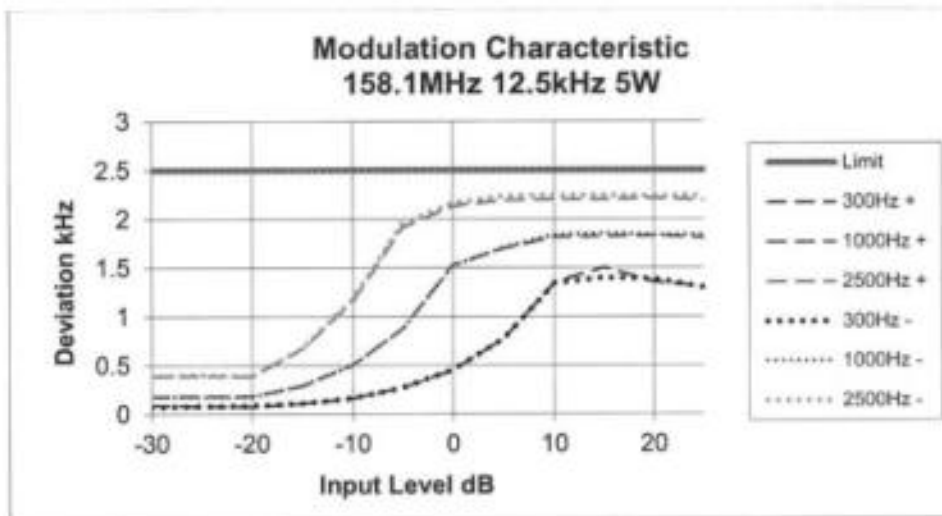

Transmitter Modulation Limiting

SPECIFICATION: FCC CFR 2.1047 (b)

Tx FREQUENCY: 161.1 MHz

12.5 kHz Channel Spacing

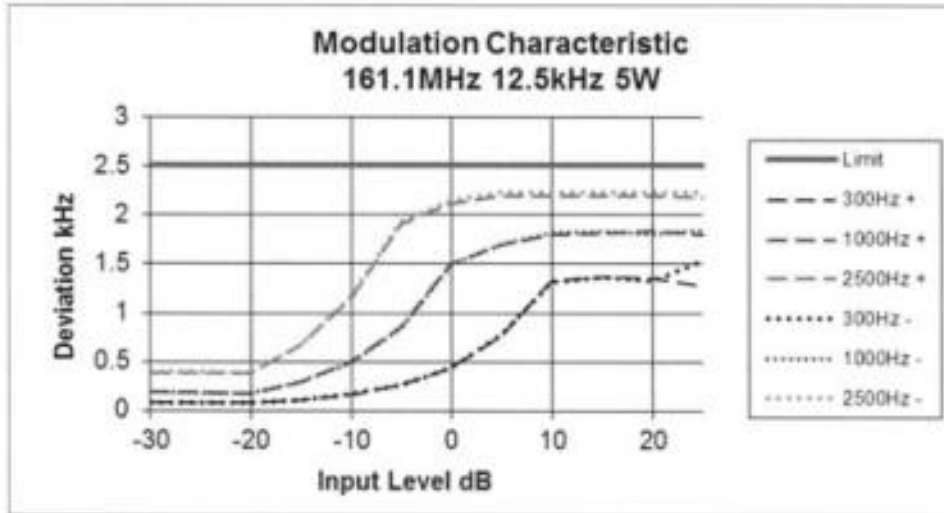

Transmitter Modulation Limiting

SPECIFICATION: FCC CFR 2.1047 (b)

Tx FREQUENCY: 173.1 MHz

12.5 kHz Channel Spacing

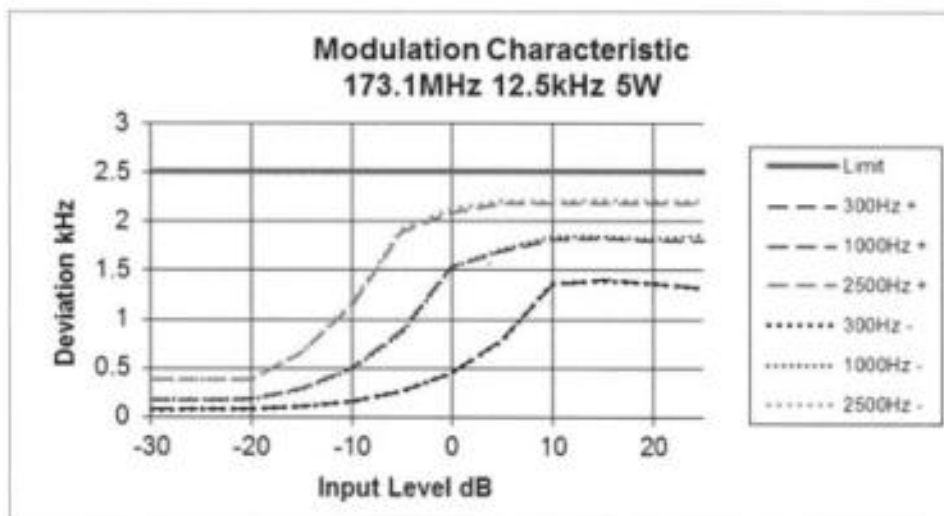

TRANSMITTER OCCUPIED BANDWIDTH AND SPECTRUM MASKS

SPECIFICATION: FCC 47 CFR 2.1049 (c) RSS-119 5.5
GUIDE: TIA/EIA-603D 2.2.11 (Analog)
TIA-102.CAAA-C 2.2.5 (Digital)

MEASUREMENT PROCEDURE:

1. Refer Annex A for Equipment Set up.
2. For analog measurements: The EUT was modulated by a 2500 Hz tone at an input level 16 dB above a level that produced 50% deviation. The input level was established at the frequency of maximum response of the audio modulating circuit.
For Data measurements: The EUT was modulated with an internally generated pseudo random bit sequence at the appropriate Baud rates.
3. The Occupied Bandwidth was measured on the Spectrum Analyser, with bandwidth settings as follows.

Emission Mask D – Resolution Bandwidth = 100 Hz, Video Bandwidth = 1 kHz

MEASUREMENT RESULTS:

See the plots on the following pages for 12.5 kHz channel spacing.

MEASUREMENT UNCERTAINTY 95% $\pm 0.65\text{dB}$

LIMIT CLAUSE:	FCC 47 CFR 90.210	RSS-119 5.5
EMISSION MASKS		
Emission Mask D	12.5 kHz Channel Spacing	Analog, FFSK, Digital Voice/data
DATA SPEED		
Digital Voice/Data	12.5 kHz Channel Spacing	9600 bps & 12000 bps
FFSK	12.5 kHz Channel Spacing	1200 bps & 2400 bps

Occupied Bandwidth and Spectrum Masks

ANALOG VOICE

SPECIFICATION: FCC CFR 2.1049 (c) RSS-119 5.5

Tx FREQUENCY: 138.1 MHz 5 W 12.5 kHz Channel Spacing

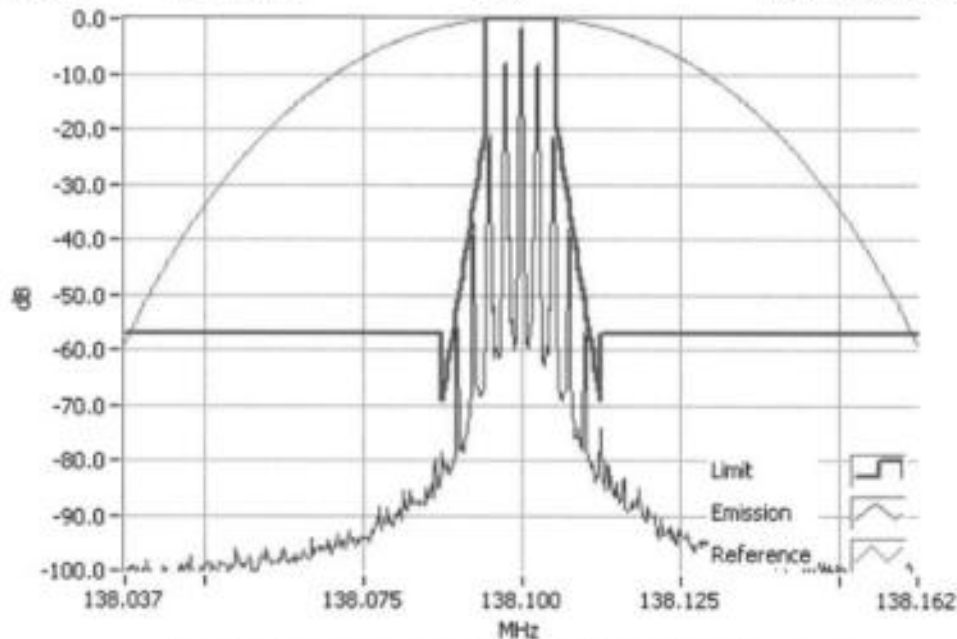

Analogue Modulation 138.1000MHz Mask D 5W
RBW=100Hz, VBW=1000Hz, Detector Mode=Peak
Result=Pass

Tx FREQUENCY: 138.1 MHz 1 W 12.5 kHz Channel Spacing

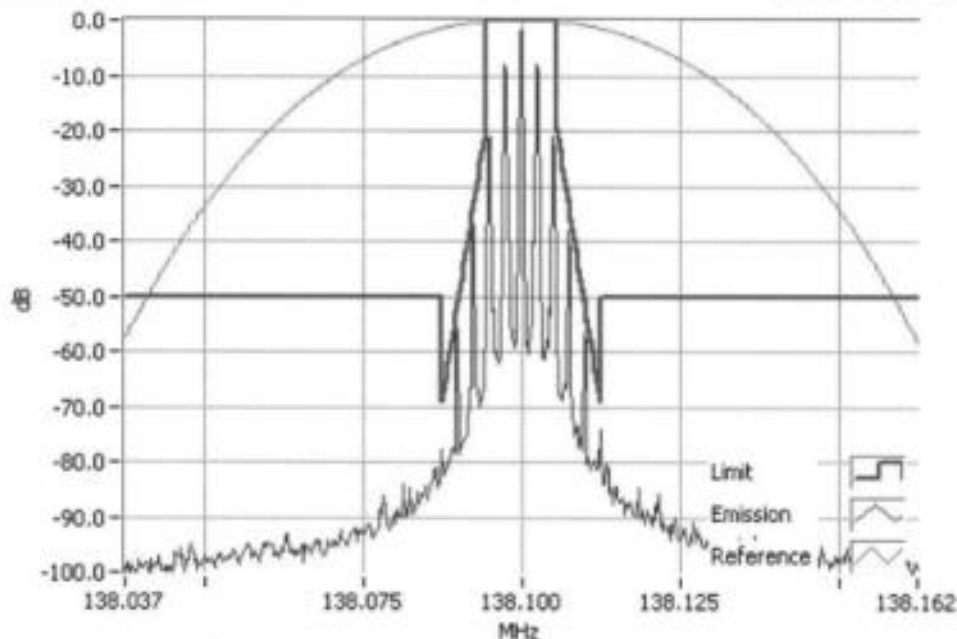

Analogue Modulation 138.1000MHz Mask D 1W
RBW=100Hz, VBW=1000Hz, Detector Mode=Peak
Result=Pass

Occupied Bandwidth and Spectrum Masks

ANALOG VOICE

SPECIFICATION: FCC CFR 2.1049 (c) RSS-119 5.5

Tx FREQUENCY: 143.9 MHz 5 W 12.5 kHz Channel Spacing

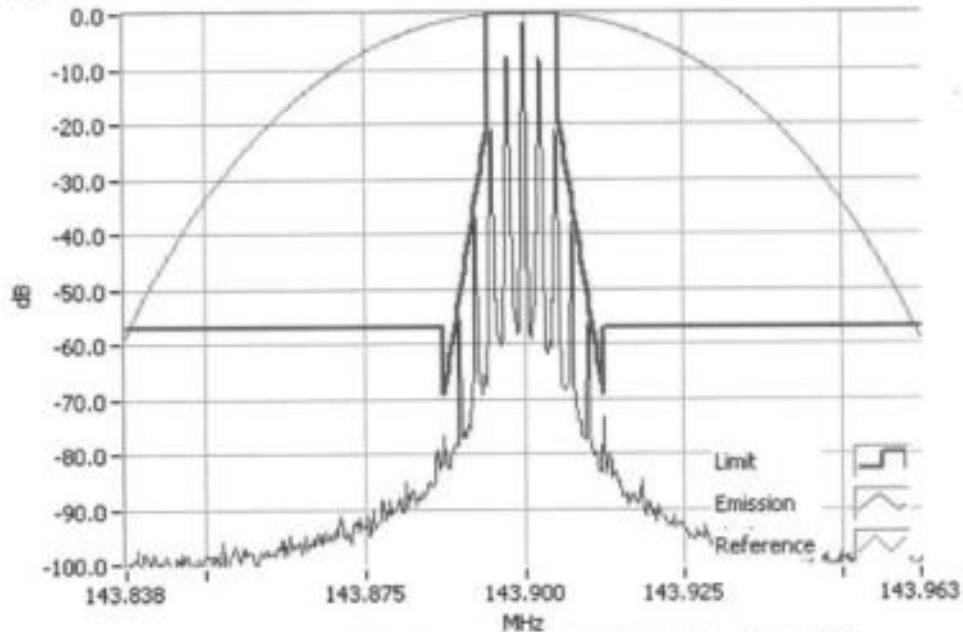

Analogue Modulation 143.9000MHz Mask D 5W
RBW=100Hz, VBW=1000Hz, Detector Mode=Peak
Result=Pass

Tx FREQUENCY: 143.9 MHz 1 W 12.5 kHz Channel Spacing

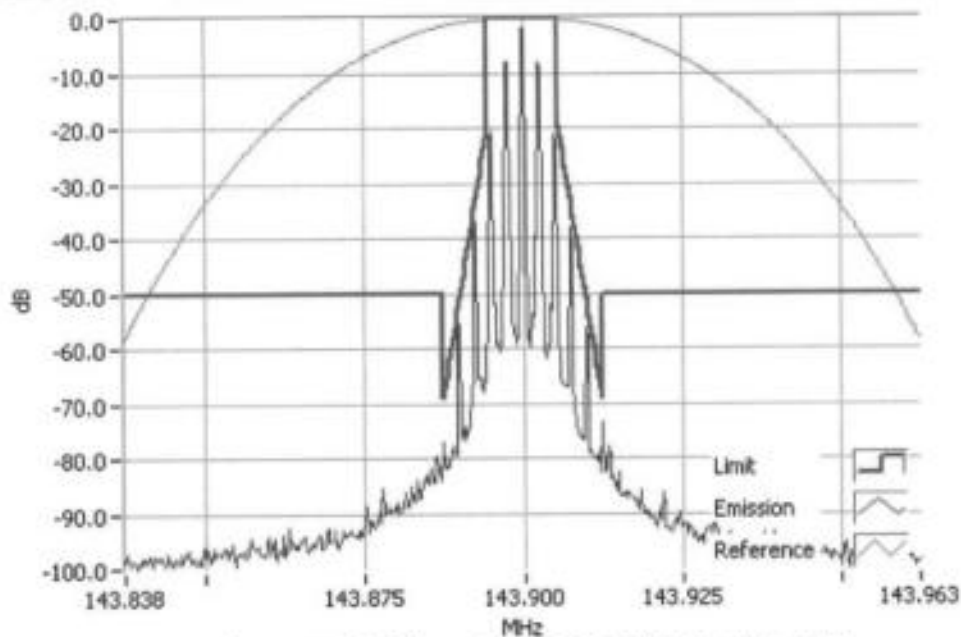

Analogue Modulation 143.9000MHz Mask D 1W
RBW=100Hz, VBW=1000Hz, Detector Mode=Peak
Result=Pass

Occupied Bandwidth and Spectrum Masks

ANALOG VOICE

SPECIFICATION: FCC CFR 2.1049 (c) RSS-119 5.5

Tx FREQUENCY: 148.1 MHz 5 W 12.5 kHz Channel Spacing

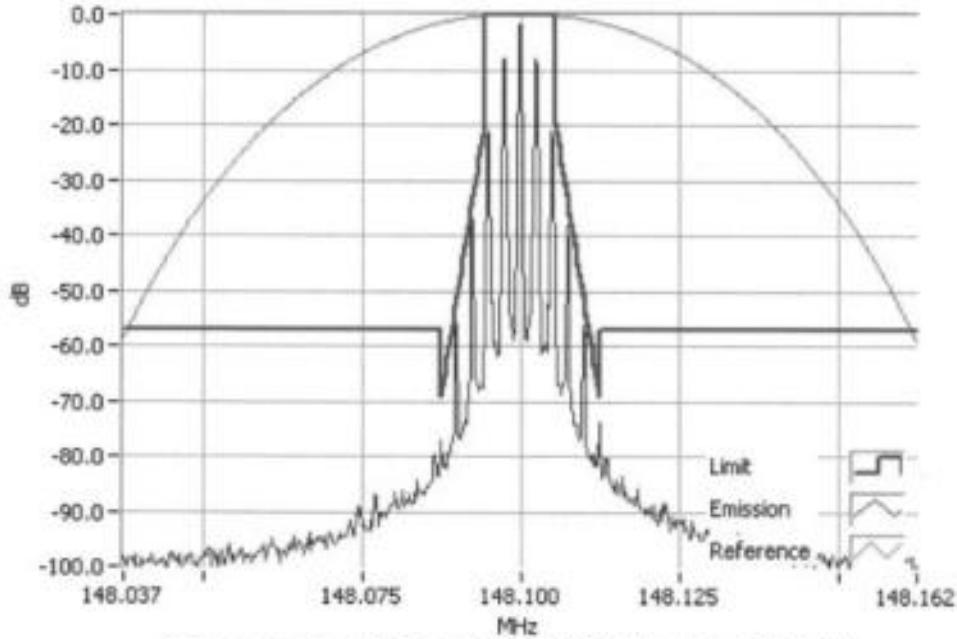

Analogue Modulation 148.1000MHz Mask D 5W
RBW=100Hz, VBW=1000Hz, Detector Mode=Peak
Result=Pass

Tx FREQUENCY: 148.1 MHz 1 W 12.5 kHz Channel Spacing

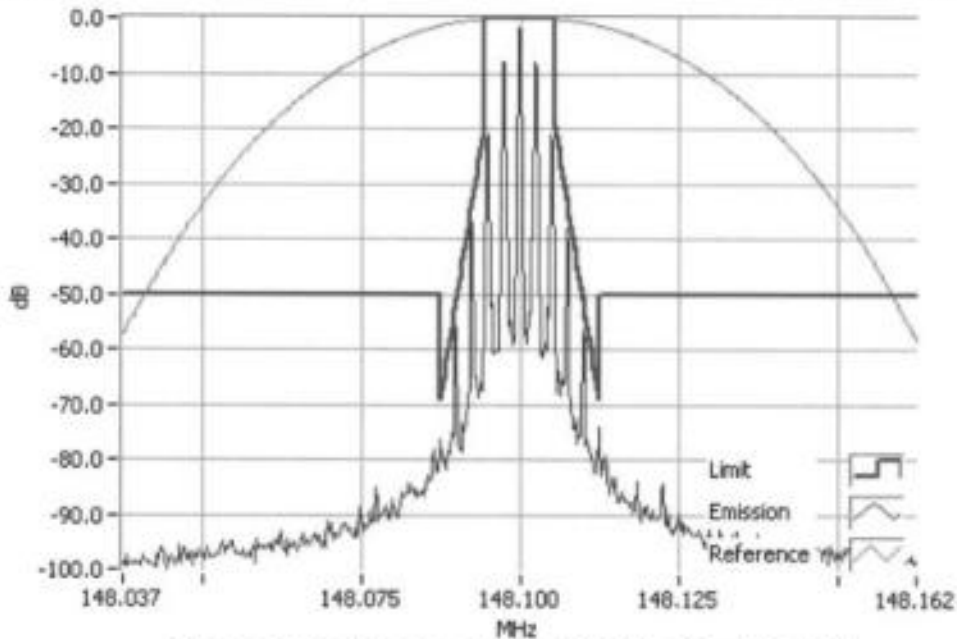

Analogue Modulation 148.1000MHz Mask D 1W
RBW=100Hz, VBW=1000Hz, Detector Mode=Peak
Result=Pass

Occupied Bandwidth and Spectrum Masks

ANALOG VOICE

SPECIFICATION: FCC CFR 2.1049 (c) RSS-119 5.5

Tx FREQUENCY: 149.8 MHz 5 W 12.5 kHz Channel Spacing

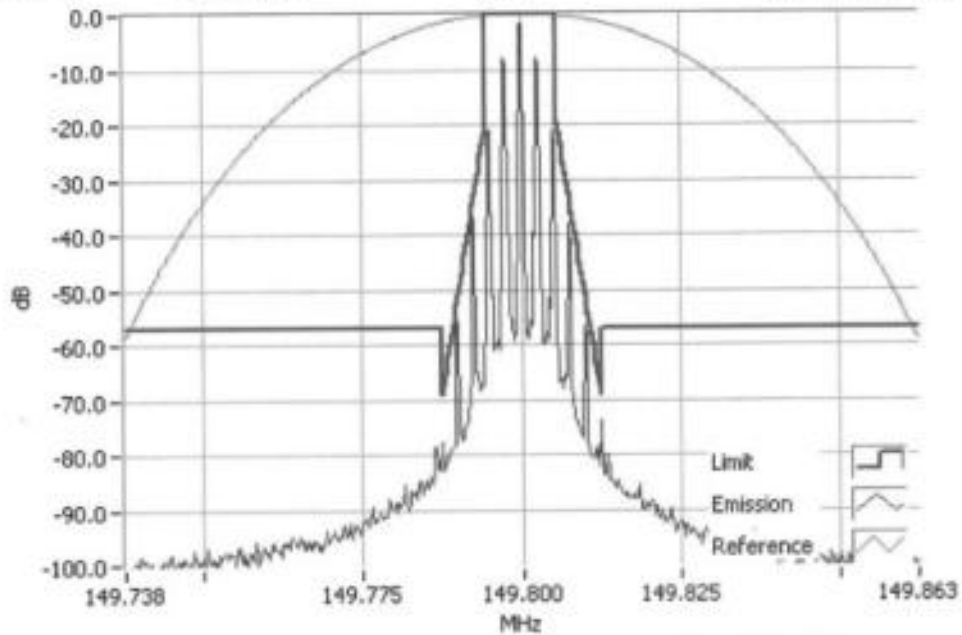

Analogue Modulation 149.8000MHz Mask D 5W
RBW=100Hz, VBW=1000Hz, Detector Mode=Peak
Result=Pass

Tx FREQUENCY: 149.8 MHz 1 W 12.5 kHz Channel Spacing

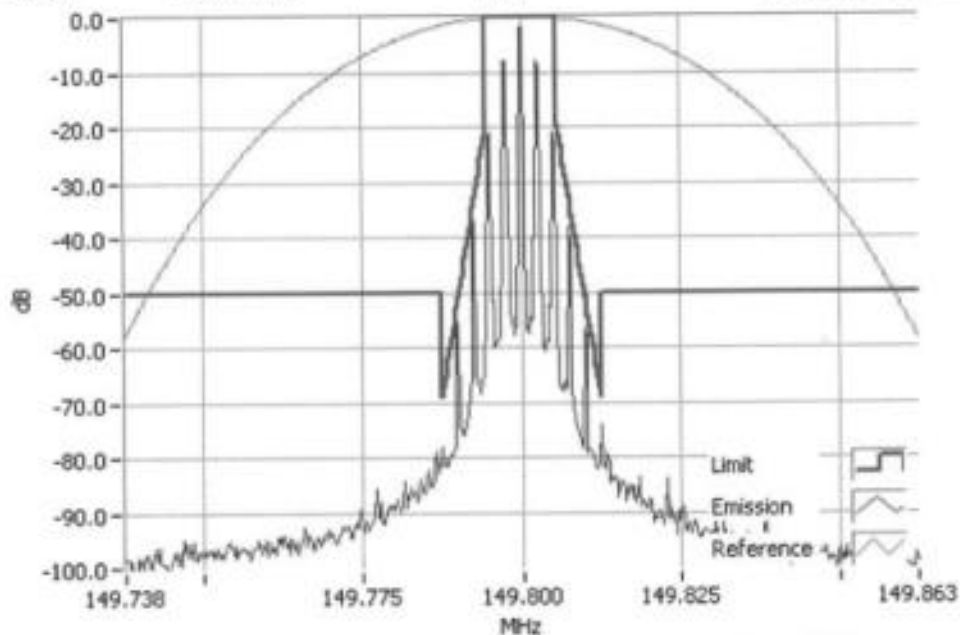

Analogue Modulation 149.8000MHz Mask D 1W
RBW=100Hz, VBW=1000Hz, Detector Mode=Peak
Result=Pass

Occupied Bandwidth and Spectrum Masks

ANALOG VOICE

SPECIFICATION: FCC CFR 2.1049 (c) RSS-119 5.5

Tx FREQUENCY: 152.1 MHz 5 W 12.5 kHz Channel Spacing

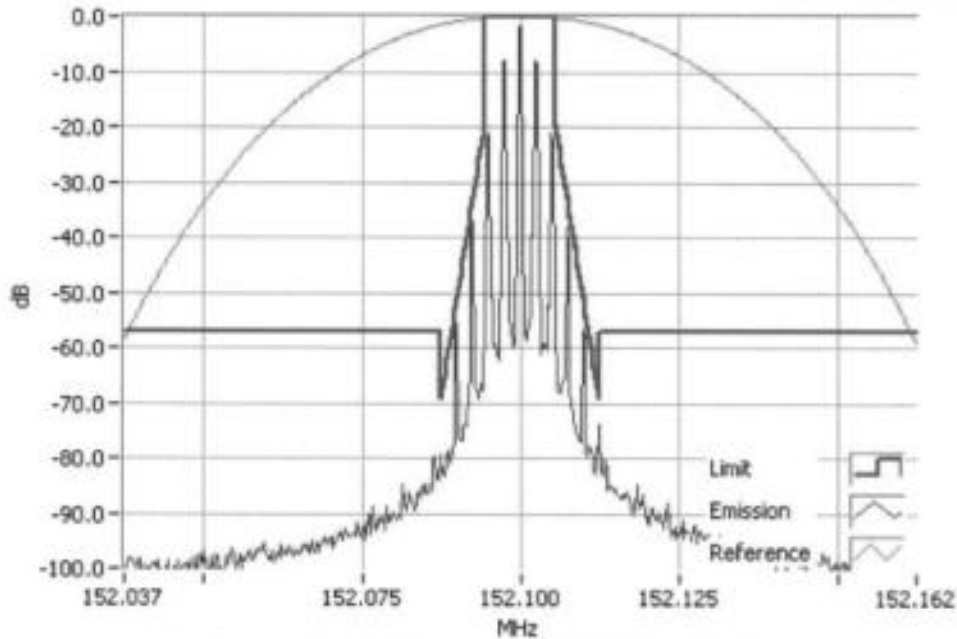

Analogue Modulation 152.1000MHz Mask D 5W
RBW=100Hz, VBW=1000Hz, Detector Mode=Peak
Result=Pass

Tx FREQUENCY: 152.1 MHz 1 W 12.5 kHz Channel Spacing

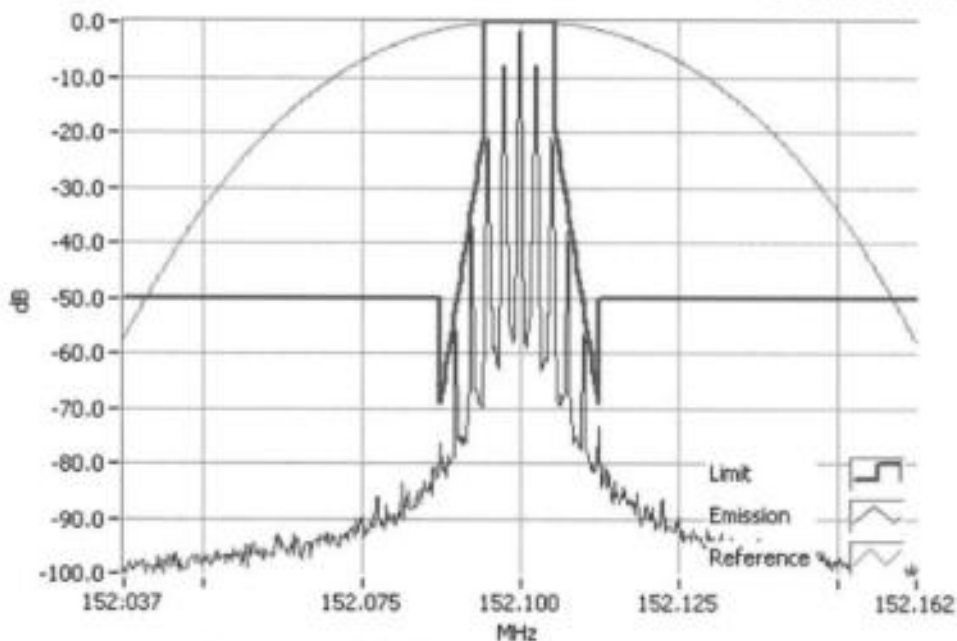

Analogue Modulation 152.1000MHz Mask D 1W
RBW=100Hz, VBW=1000Hz, Detector Mode=Peak
Result=Pass

Occupied Bandwidth and Spectrum Masks

ANALOG VOICE

SPECIFICATION: FCC CFR 2.1049 (c) RSS-119 5.5

Tx FREQUENCY: 153.1 MHz 5 W 12.5 kHz Channel Spacing

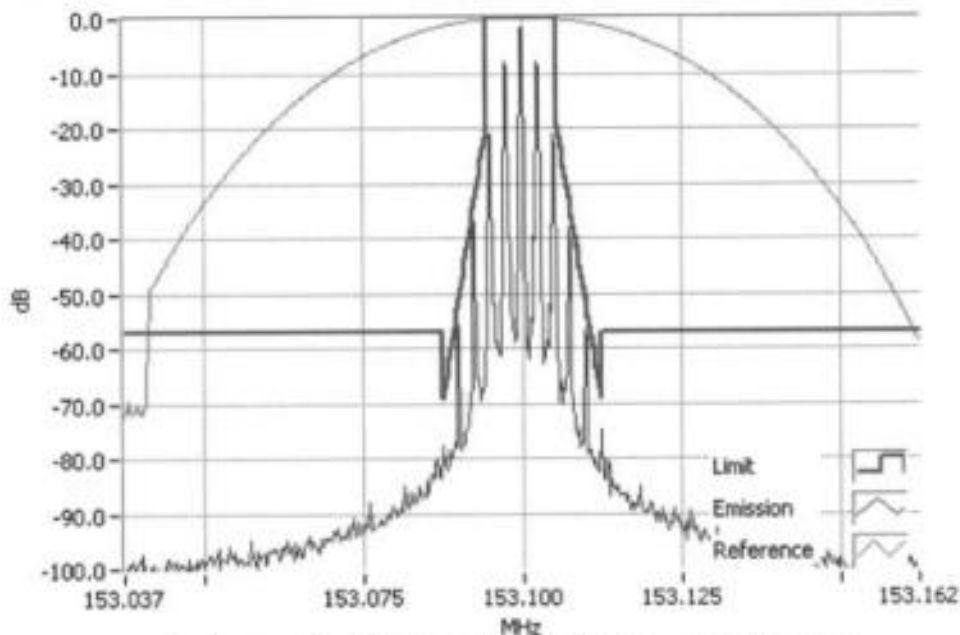

Analogue Modulation 153.1000MHz Mask D 5W
RBW=100Hz, VBW=1000Hz, Detector Mode=Peak
Result=Pass

Tx FREQUENCY: 153.1 MHz 1 W 12.5 kHz Channel Spacing

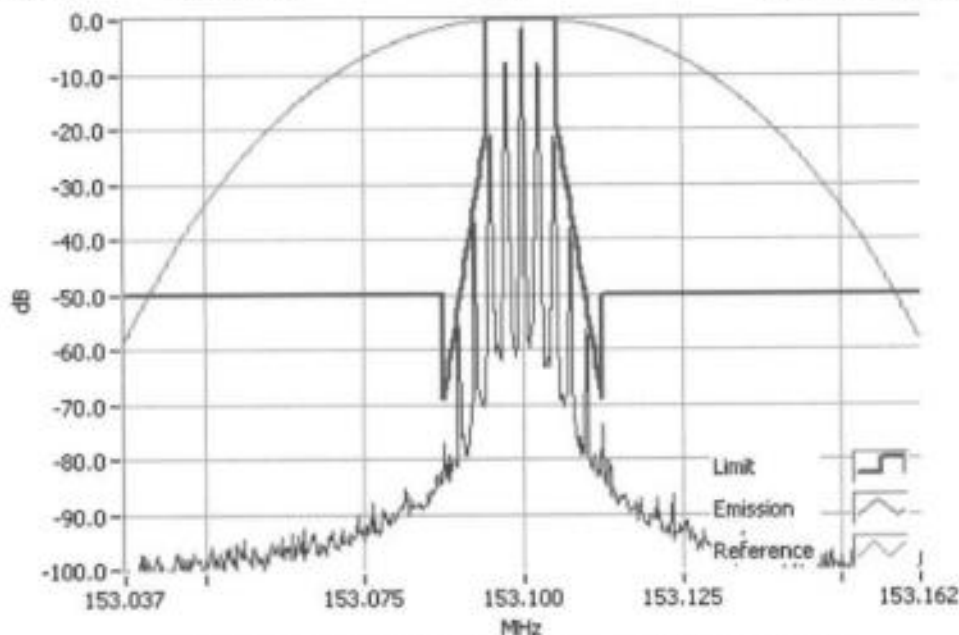

Analogue Modulation 153.1000MHz Mask D 1W
RBW=100Hz, VBW=1000Hz, Detector Mode=Peak
Result=Pass

Occupied Bandwidth and Spectrum Masks

ANALOG VOICE

SPECIFICATION: FCC CFR 2.1049 (c) RSS-119 5.5

Tx FREQUENCY: 158.1 MHz 5 W 12.5 kHz Channel Spacing

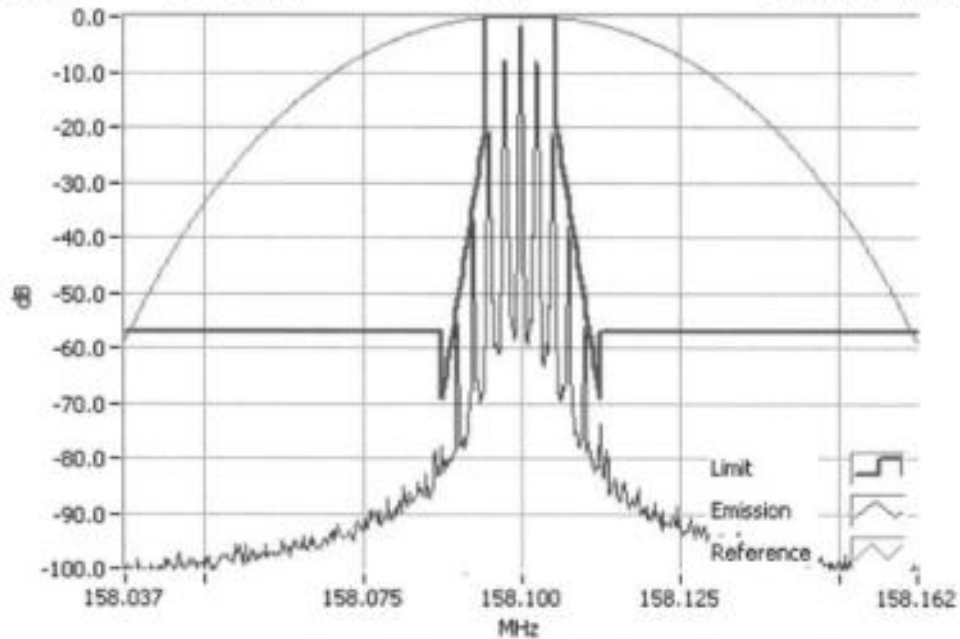

Analogue Modulation 158.1000MHz Mask D 5W
RBW=100Hz, VBW=1000Hz, Detector Mode=Peak
Result=Pass

Tx FREQUENCY: 158.1 MHz 1 W 12.5 kHz Channel Spacing

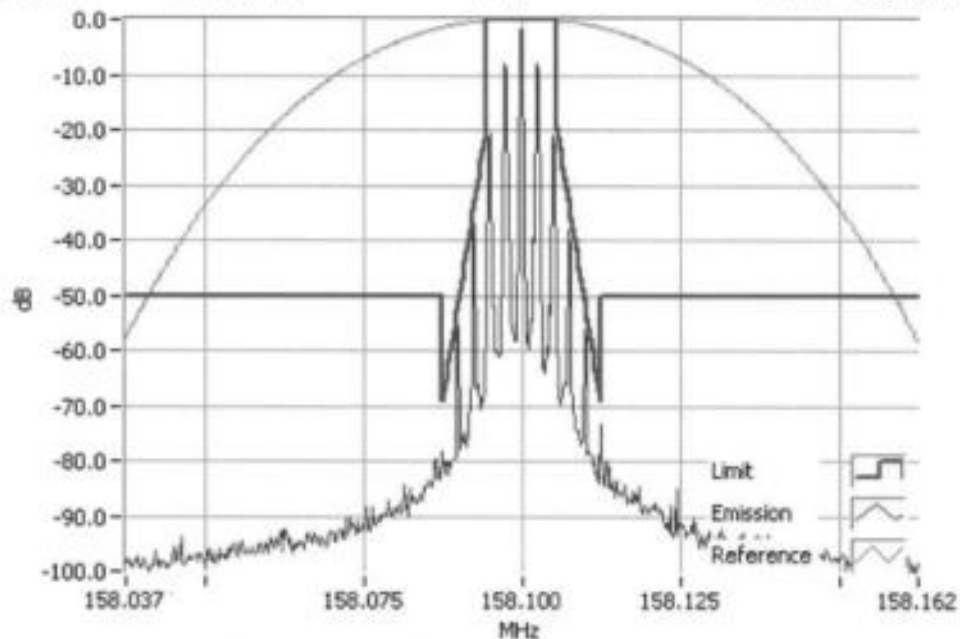

Analogue Modulation 158.1000MHz Mask D 1W
RBW=100Hz, VBW=1000Hz, Detector Mode=Peak
Result=Pass

Occupied Bandwidth and Spectrum Masks

ANALOG VOICE

SPECIFICATION: FCC CFR 2.1049 (c) RSS-119 5.5

Tx FREQUENCY: 161.1 MHz 5 W 12.5 kHz Channel Spacing

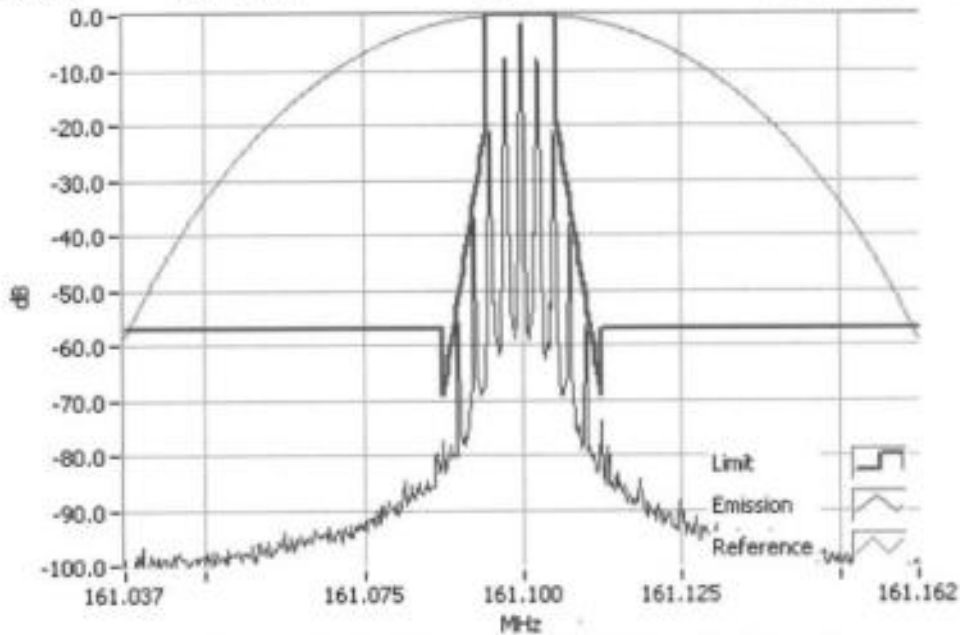

Analogue Modulation 161.1000MHz Mask D 5W
RBW=100Hz, VBW=1000Hz, Detector Mode=Peak
Result=Pass

Tx FREQUENCY: 161.1 MHz 1 W 12.5 kHz Channel Spacing

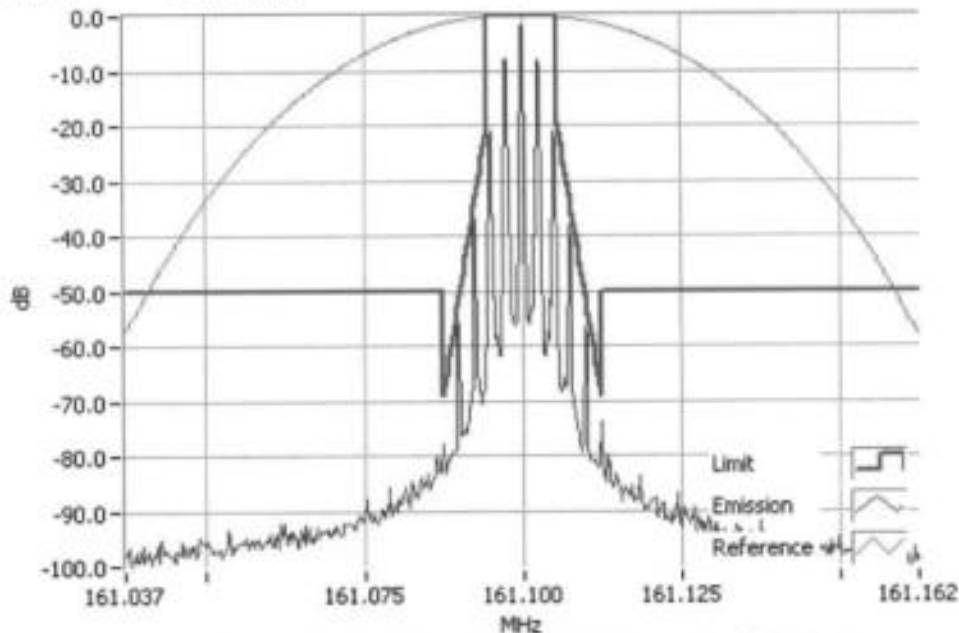

Analogue Modulation 161.1000MHz Mask D 1W
RBW=100Hz, VBW=1000Hz, Detector Mode=Peak
Result=Pass

Occupied Bandwidth and Spectrum Masks

ANALOG VOICE

SPECIFICATION: FCC CFR 2.1049 (c) RSS-119 5.5

Tx FREQUENCY: 173.1 MHz 5 W 12.5 kHz Channel Spacing

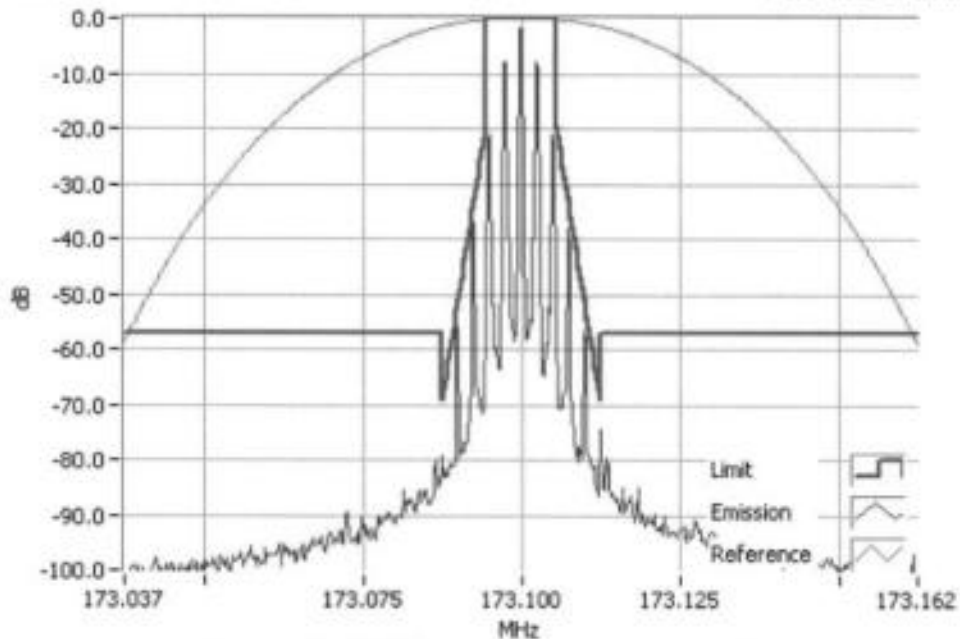

Analogue Modulation 173.1000MHz Mask D 5W
RBW=100Hz, VBW=1000Hz, Detector Mode=Peak
Result=Pass

Tx FREQUENCY: 173.1 MHz 1 W 12.5 kHz Channel Spacing

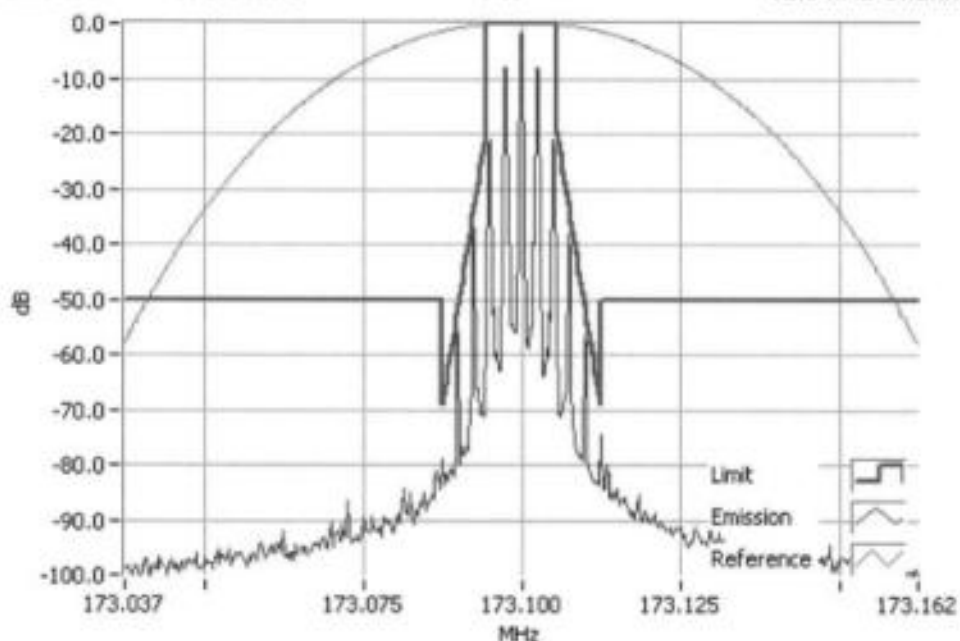

Analogue Modulation 173.1000MHz Mask D 1W
RBW=100Hz, VBW=1000Hz, Detector Mode=Peak
Result=Pass

Occupied Bandwidth and Spectrum Masks

FFSK 1200 bps

SPECIFICATION: FCC CFR 2.1049 (c) RSS-119 5.5

Tx FREQUENCY: 138.1 MHz 5 W 12.5 kHz Channel Spacing

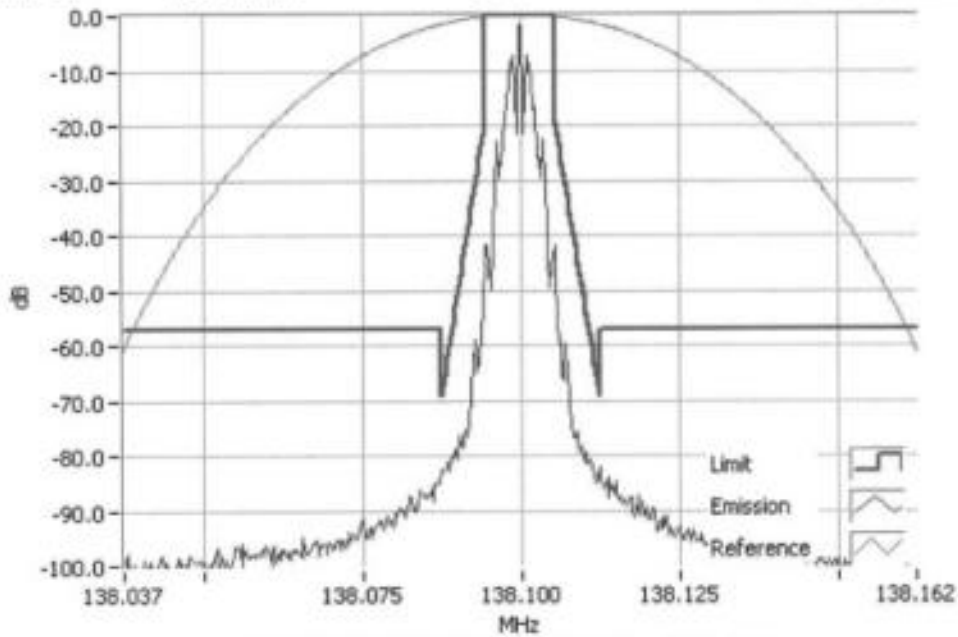

FFSK 1200 138.1000MHz Mask D 5W
RBW=100Hz, VBW=1000Hz, Detector Mode=Peak
Result=Pass

Tx FREQUENCY: 138.1 MHz 1 W 12.5 kHz Channel Spacing

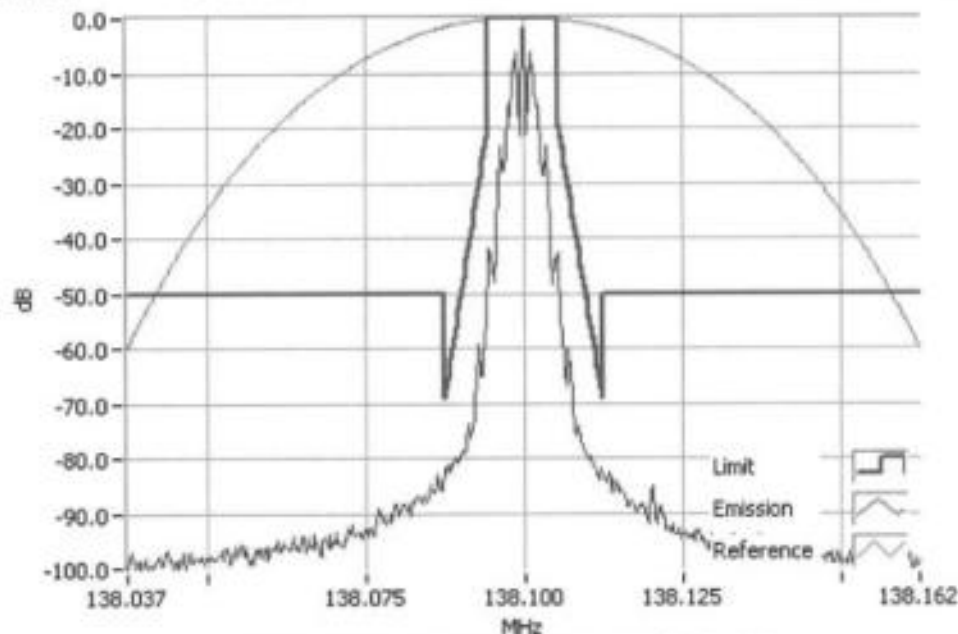

FFSK 1200 138.1000MHz Mask D 1W
RBW=100Hz, VBW=1000Hz, Detector Mode=Peak
Result=Pass

Occupied Bandwidth and Spectrum Masks

FFSK 1200 bps

SPECIFICATION: FCC CFR 2.1049 (c) RSS-119 5.5

Tx FREQUENCY: 143.9 MHz 5 W 12.5 kHz Channel Spacing

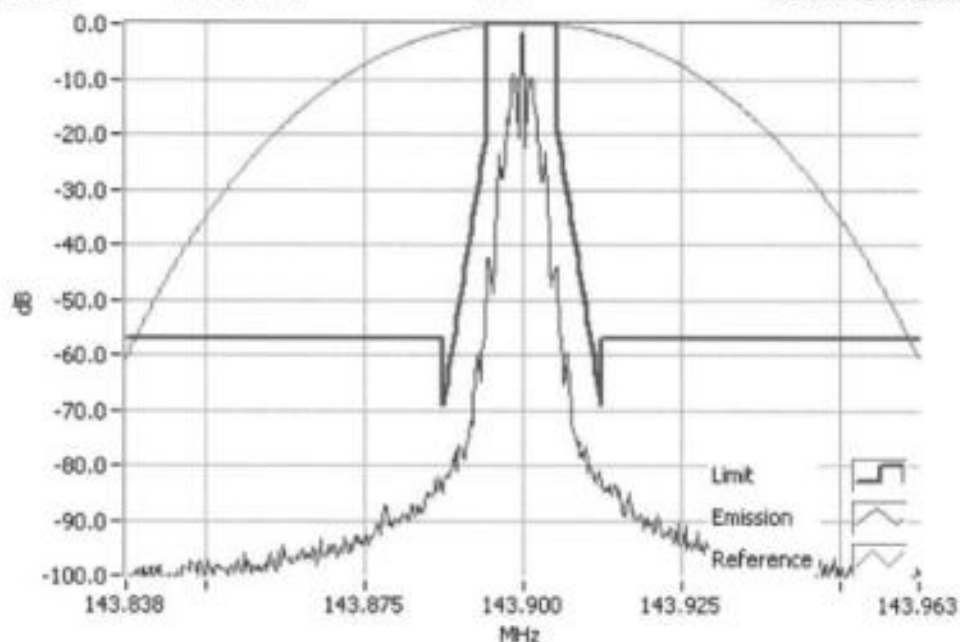

FFSK 1200 143.9000MHz Mask D 5W
RBW=100Hz, VBW=1000Hz, Detector Mode=Peak
Result=Pass

Tx FREQUENCY: 143.9 MHz 1 W 12.5 kHz Channel Spacing

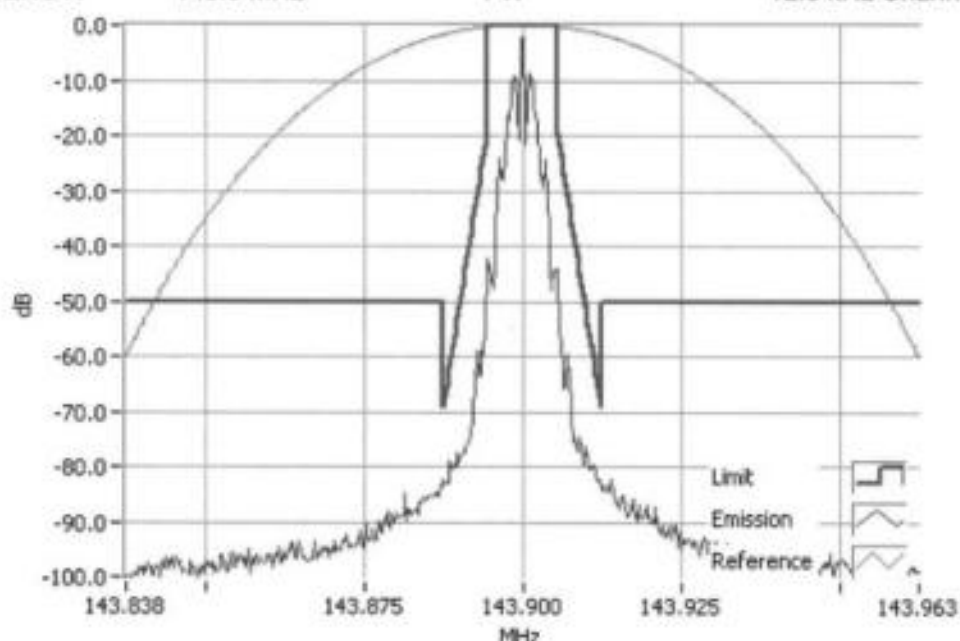

FFSK 1200 143.9000MHz Mask D 1W
RBW=100Hz, VBW=1000Hz, Detector Mode=Peak
Result=Pass

Occupied Bandwidth and Spectrum Masks

FFSK 1200 bps

SPECIFICATION: FCC CFR 2.1049 (c) RSS-119 5.5

Tx FREQUENCY: 148.1 MHz 5 W 12.5 kHz Channel Spacing

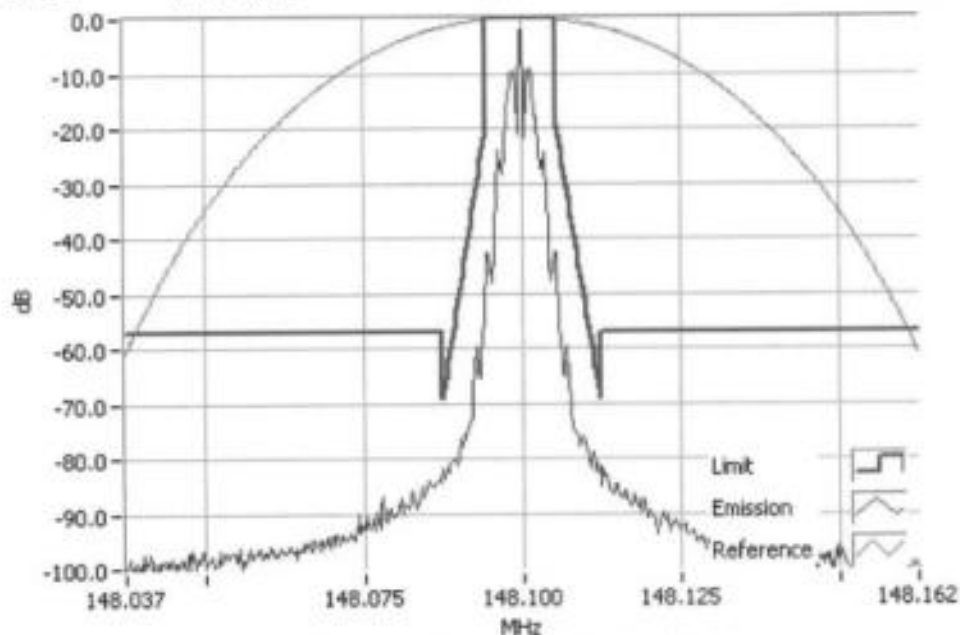

FFSK 1200 148.1000MHz Mask D 5W
RBW=100Hz, VBW=1000Hz, Detector Mode=Peak
Result=Pass

Tx FREQUENCY: 148.1 MHz 1 W 12.5 kHz Channel Spacing

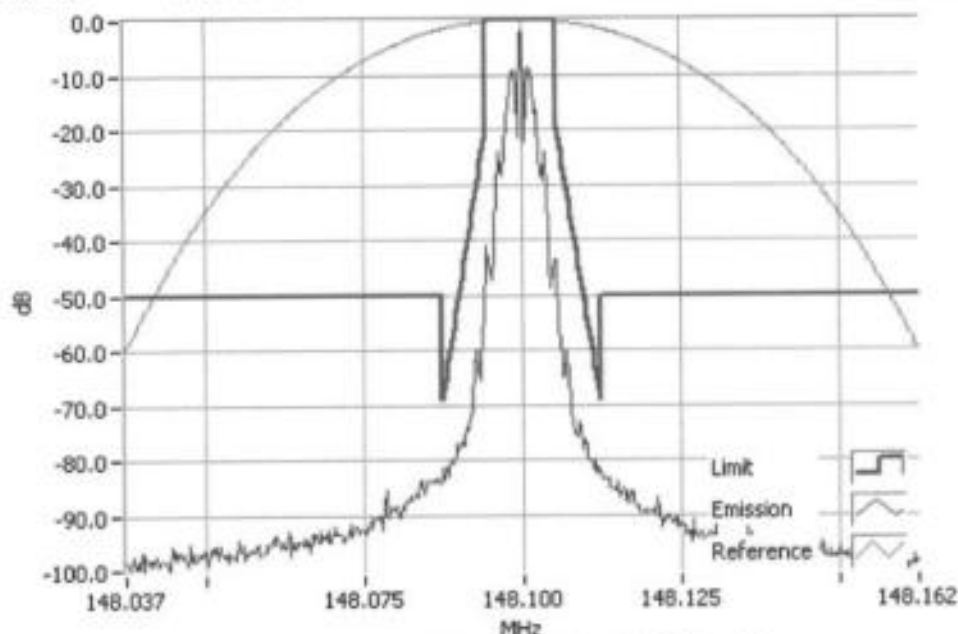

FFSK 1200 148.1000MHz Mask D 1W
RBW=100Hz, VBW=1000Hz, Detector Mode=Peak
Result=Pass

Occupied Bandwidth and Spectrum Masks

FFSK 1200 bps

SPECIFICATION: FCC CFR 2.1049 (c) RSS-119 5.5

Tx FREQUENCY: 149.8 MHz 5 W 12.5 kHz Channel Spacing

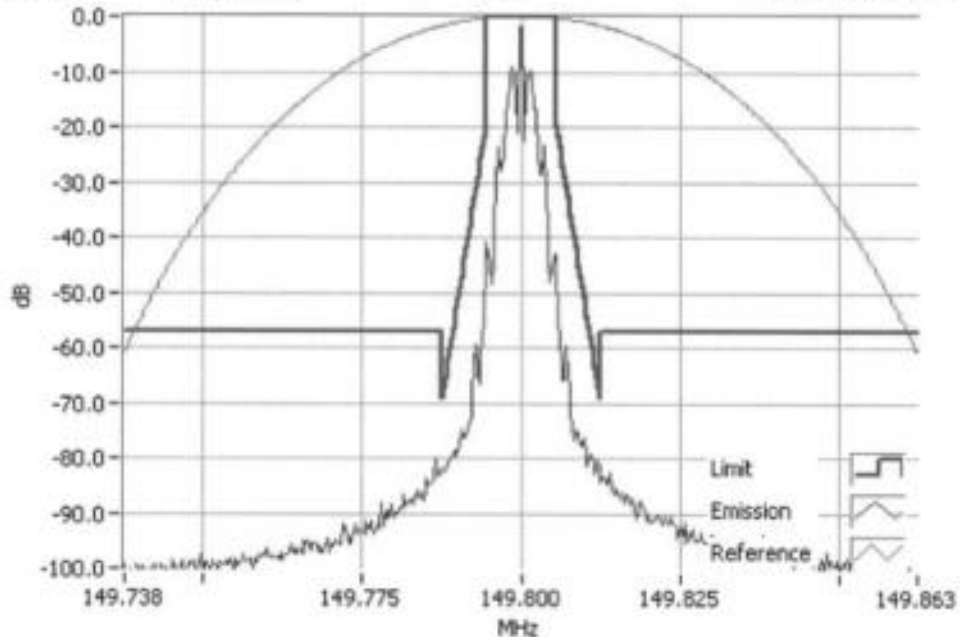

FFSK 1200 149.8000MHz Mask D 5W
RBW=100Hz, VBW=1000Hz, Detector Mode=Peak
Result=Pass

Tx FREQUENCY: 149.8 MHz 1 W 12.5 kHz Channel Spacing

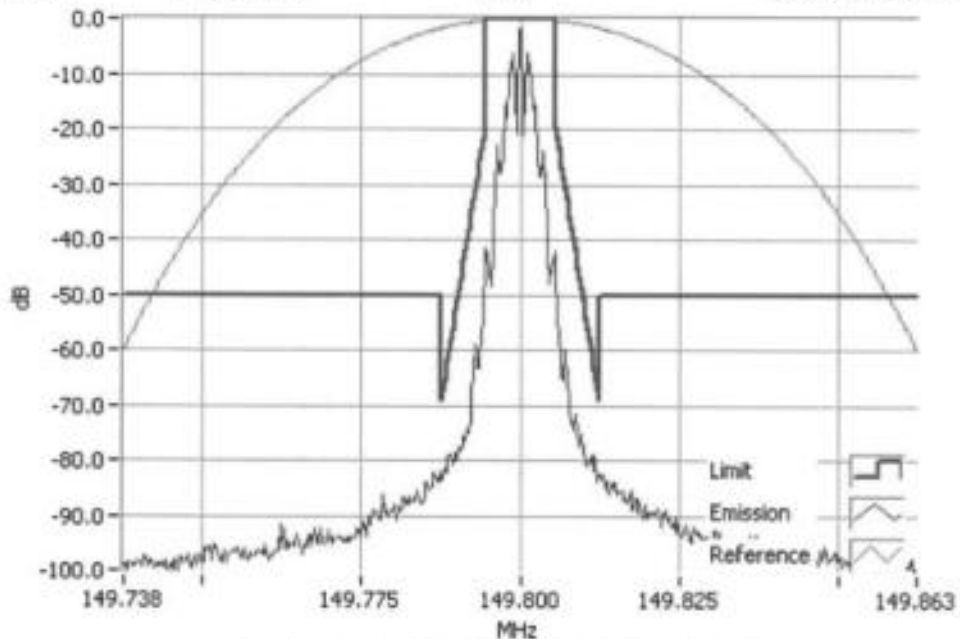

FFSK 1200 149.8000MHz Mask D 1W
RBW=100Hz, VBW=1000Hz, Detector Mode=Peak
Result=Pass

Occupied Bandwidth and Spectrum Masks

FFSK 1200 bps

SPECIFICATION: FCC CFR 2.1049 (c) RSS-119 5.5

Tx FREQUENCY: 152.1 MHz 5 W 12.5 kHz Channel Spacing

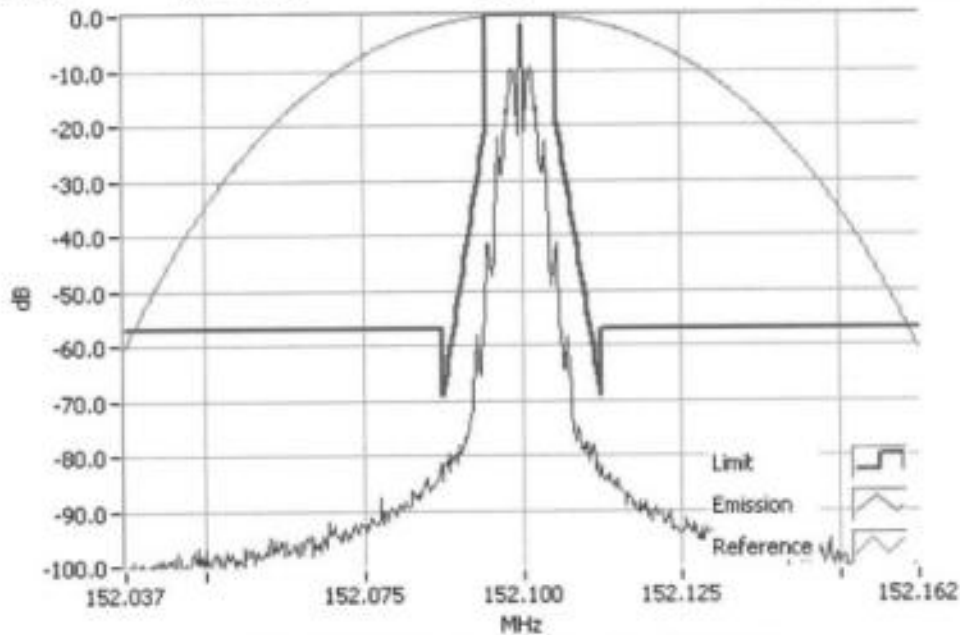

FFSK 1200 152.1000MHz Mask D 5W
RBW=100Hz, VBW=1000Hz, Detector Mode=Peak
Result=Pass

Tx FREQUENCY: 152.1 MHz 1 W 12.5 kHz Channel Spacing

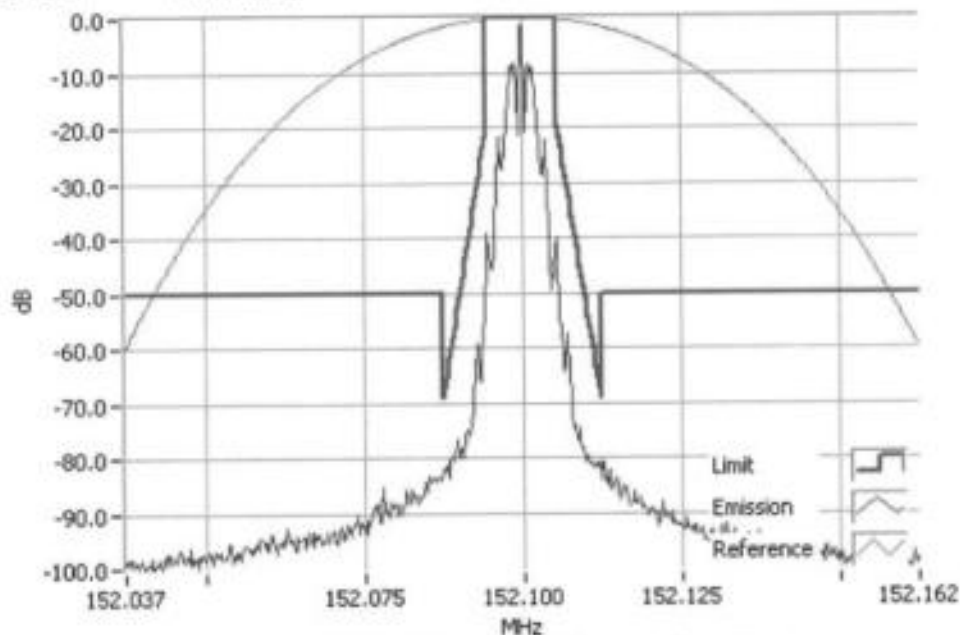

FFSK 1200 152.1000MHz Mask D 1W
RBW=100Hz, VBW=1000Hz, Detector Mode=Peak
Result=Pass

Occupied Bandwidth and Spectrum Masks

FFSK 1200 bps

SPECIFICATION: FCC CFR 2.1049 (c) RSS-119 5.5

Tx FREQUENCY: 153.1 MHz 5 W 12.5 kHz Channel Spacing

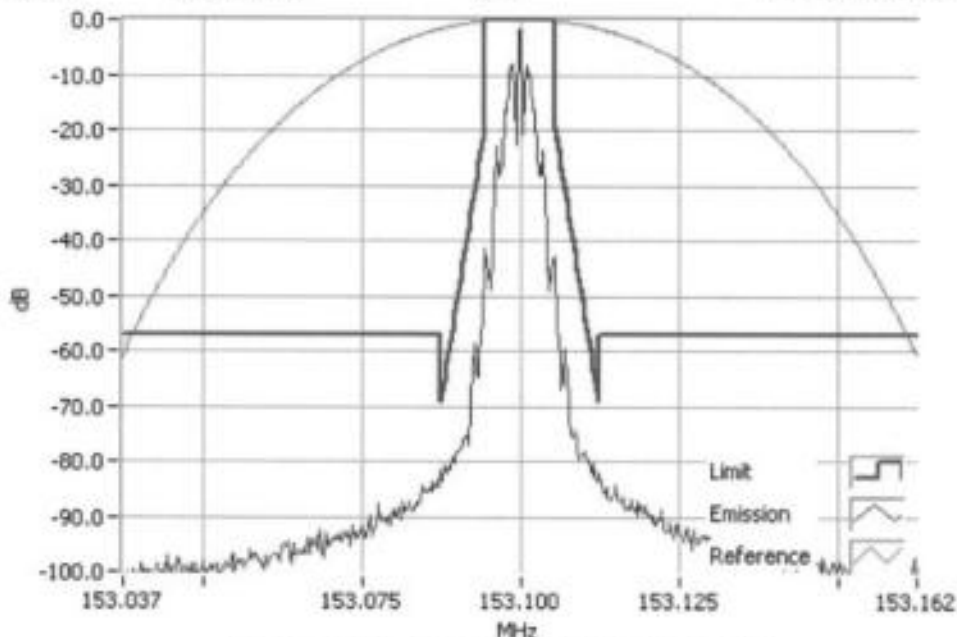

FFSK 1200 153.1000MHz Mask D 5W
RBW=100Hz, VBW=1000Hz, Detector Mode=Peak
Result=Pass

Tx FREQUENCY: 153.1 MHz 1 W 12.5 kHz Channel Spacing

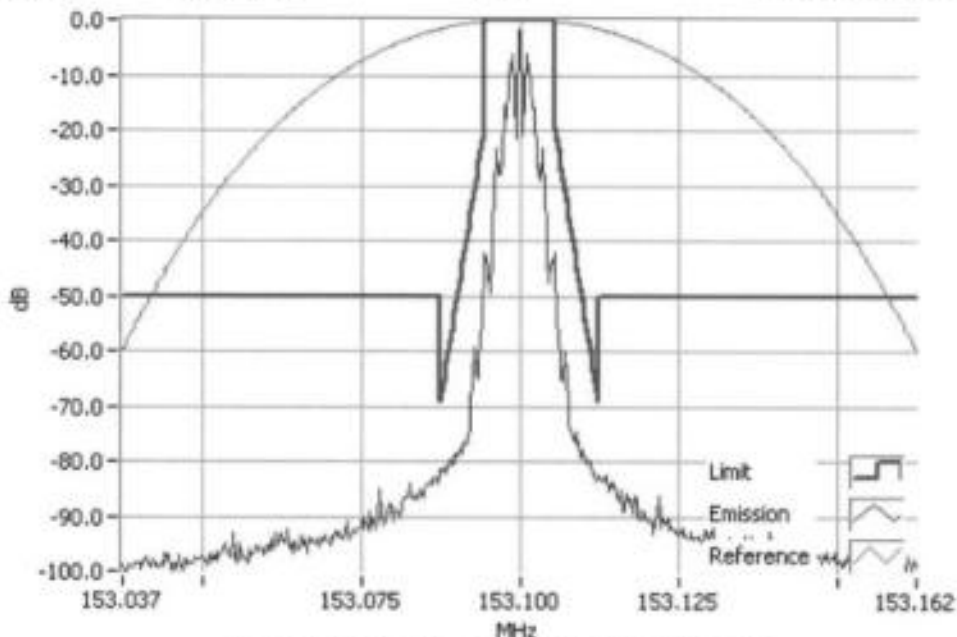

FFSK 1200 153.1000MHz Mask D 1W
RBW=100Hz, VBW=1000Hz, Detector Mode=Peak
Result=Pass

Occupied Bandwidth and Spectrum Masks

FFSK 1200 bps

SPECIFICATION: FCC CFR 2.1049 (c) RSS-119 5.5

Tx FREQUENCY: 158.1 MHz 5 W 12.5 kHz Channel Spacing

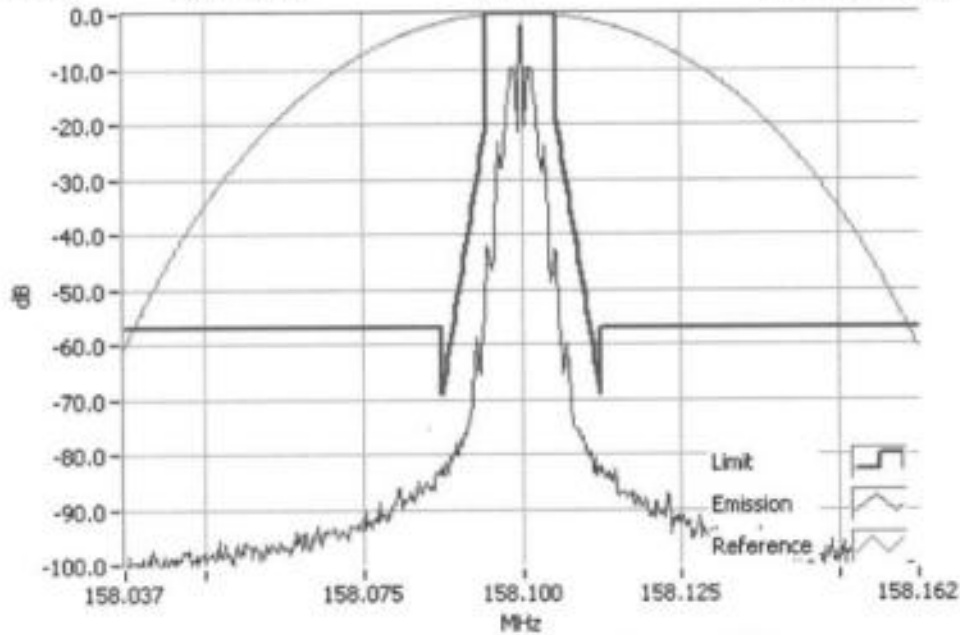

FFSK 1200 158.1000MHz Mask D 5W
RBW=100Hz, VBW=1000Hz, Detector Mode=Peak
Result=Pass

Tx FREQUENCY: 158.1 MHz 1 W 12.5 kHz Channel Spacing

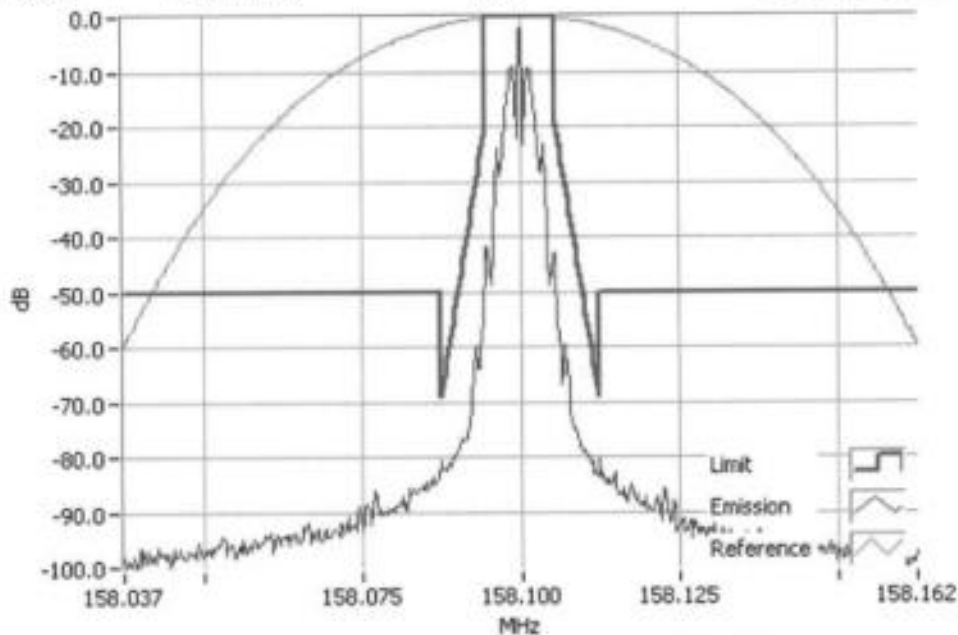

FFSK 1200 158.1000MHz Mask D 1W
RBW=100Hz, VBW=1000Hz, Detector Mode=Peak
Result=Pass

Occupied Bandwidth and Spectrum Masks

FFSK 1200 bps

SPECIFICATION: FCC CFR 2.1049 (c) RSS-119 5.5

Tx FREQUENCY: 161.1 MHz 5 W 12.5 kHz Channel Spacing

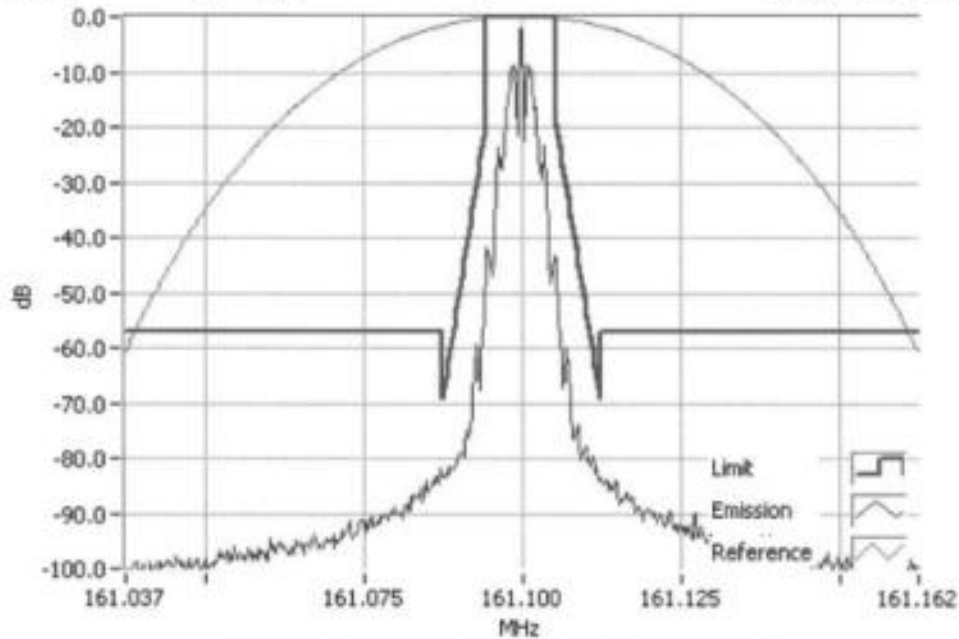

FFSK 1200 161.1000MHz Mask D 5W
RBW=100Hz, VBW=1000Hz, Detector Mode=Peak
Result=Pass

Tx FREQUENCY: 161.1 MHz 1 W 12.5 kHz Channel Spacing

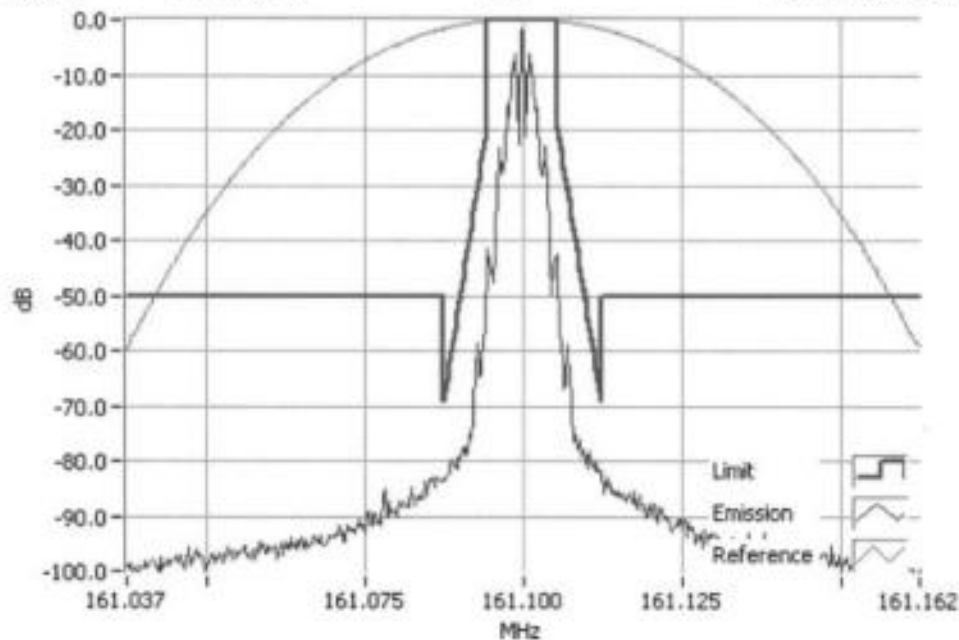

FFSK 1200 161.1000MHz Mask D 1W
RBW=100Hz, VBW=1000Hz, Detector Mode=Peak
Result=Pass

Occupied Bandwidth and Spectrum Masks

FFSK 1200 bps

SPECIFICATION: FCC CFR 2.1049 (c) RSS-119 5.5

Tx FREQUENCY: 173.1 MHz 5 W 12.5 kHz Channel Spacing

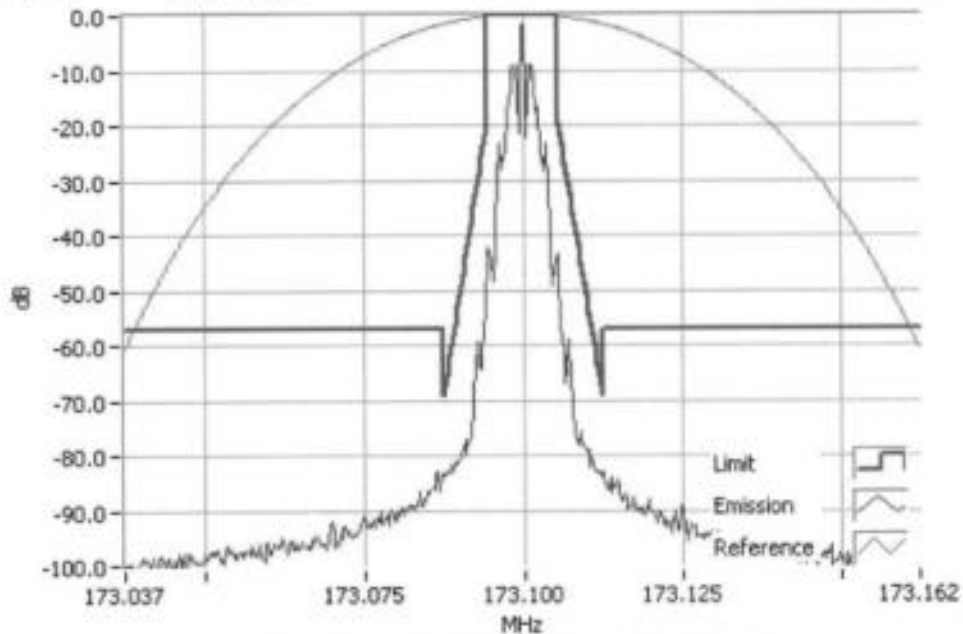

FFSK 1200 173.1000MHz Mask D 5W
RBW=100Hz, VBW=1000Hz, Detector Mode=Peak
Result=Pass

Tx FREQUENCY: 173.1 MHz 1 W 12.5 kHz Channel Spacing

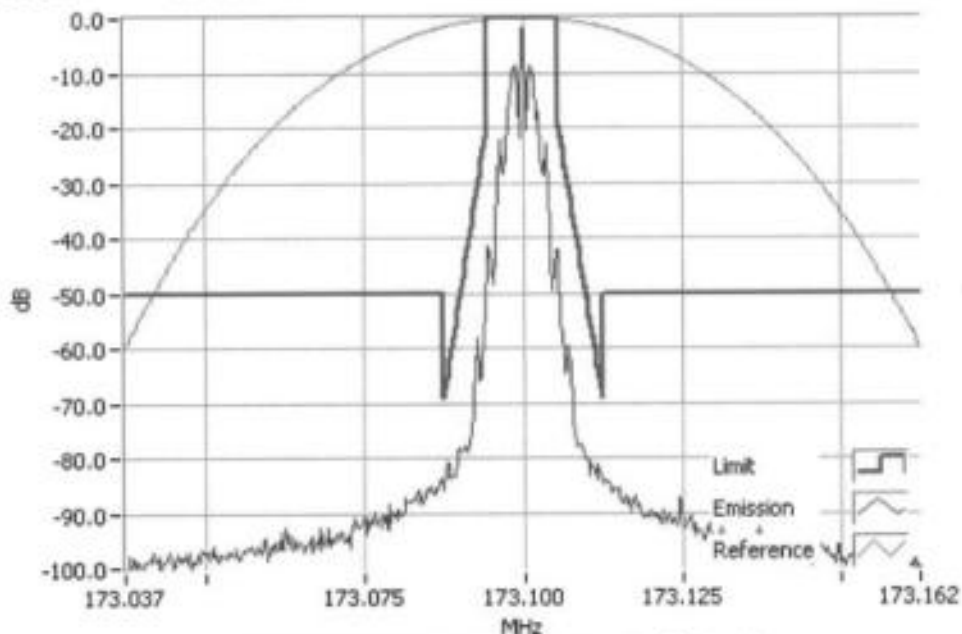

FFSK 1200 173.1000MHz Mask D 1W
RBW=100Hz, VBW=1000Hz, Detector Mode=Peak
Result=Pass

Occupied Bandwidth and Spectrum Masks

FFSK 2400 bps

SPECIFICATION: FCC CFR 2.1049 (c) RSS-119 5.5

Tx FREQUENCY: 138.1 MHz 5 W 12.5 kHz Channel Spacing

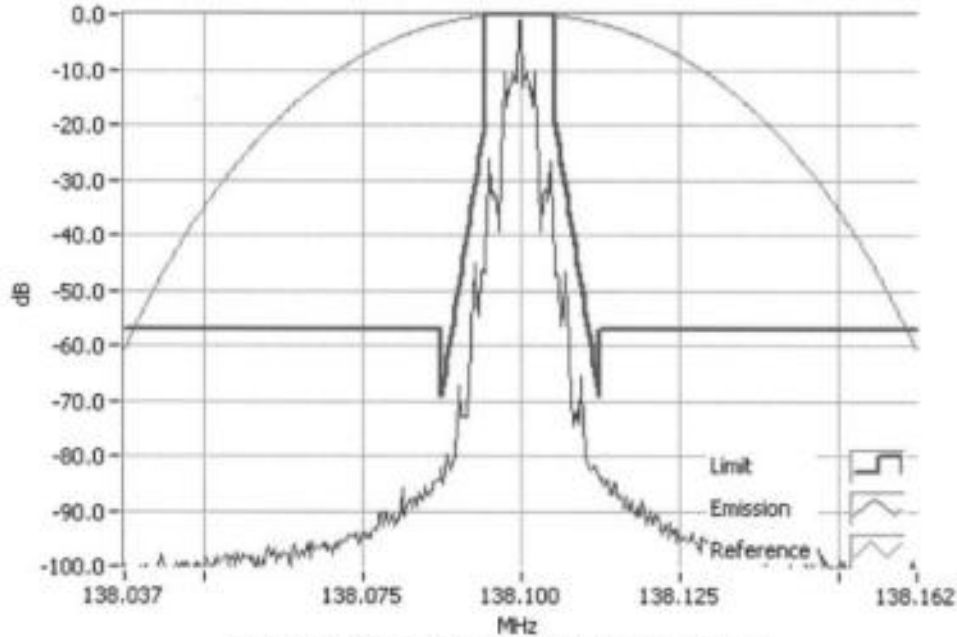

FFSK 2400 138.1000MHz Mask D 5W
RBW=100Hz, VBW=1000Hz, Detector Mode=Peak
Result=Pass

Tx FREQUENCY: 138.1 MHz 1 W 12.5 kHz Channel Spacing

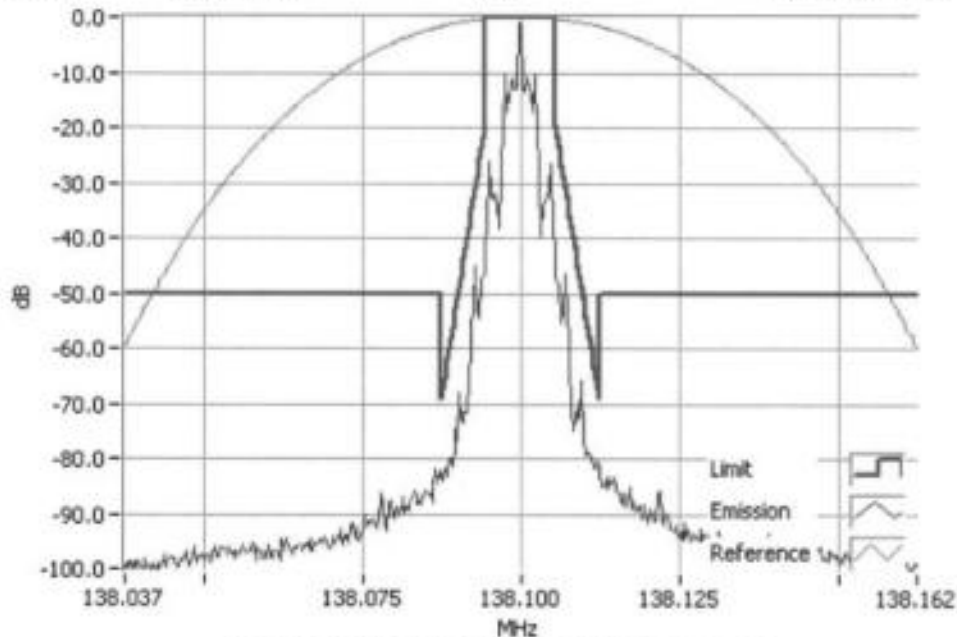

FFSK 2400 138.1000MHz Mask D 1W
RBW=100Hz, VBW=1000Hz, Detector Mode=Peak
Result=Pass

Occupied Bandwidth and Spectrum Masks

FFSK 2400 bps

SPECIFICATION: FCC CFR 2.1049 (c) RSS-119 5.5

Tx FREQUENCY: 143.9 MHz 5 W 12.5 kHz Channel Spacing

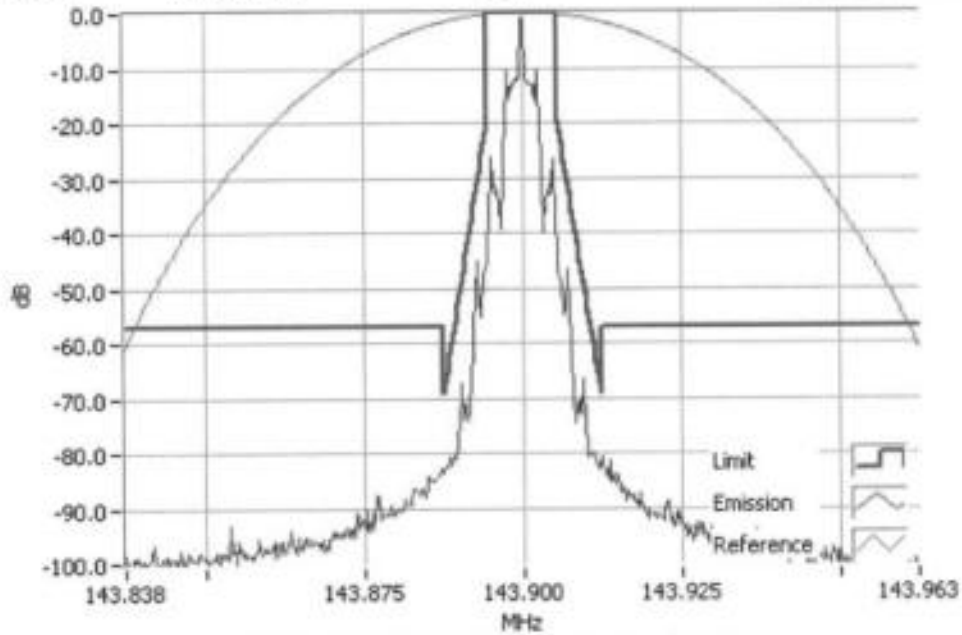

FFSK 2400 143.9000MHz Mask D 5W
RBW=100Hz, VBW=1000Hz, Detector Mode=Peak
Result=Pass

Tx FREQUENCY: 143.9 MHz 1 W 12.5 kHz Channel Spacing

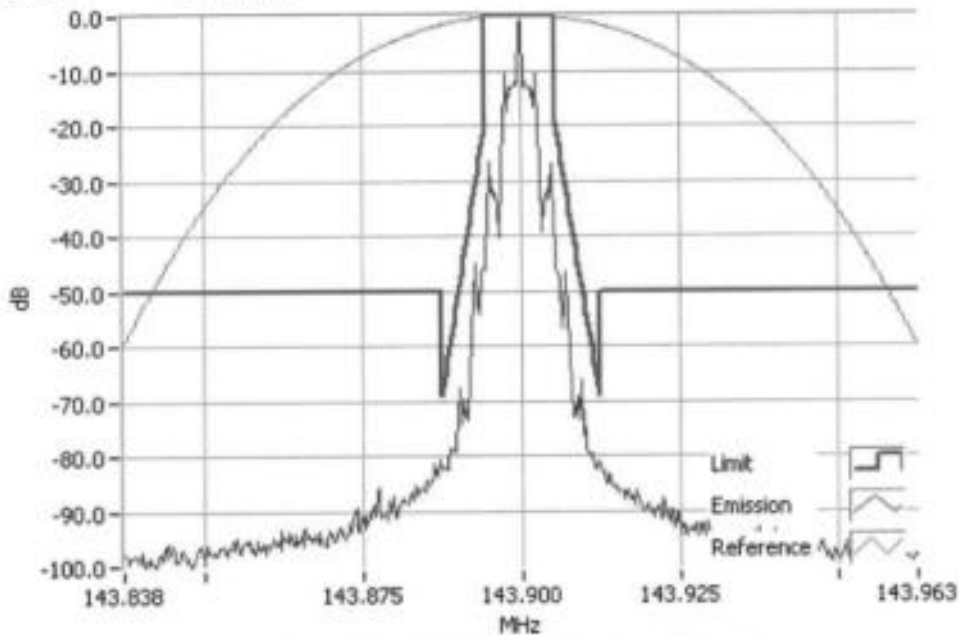

FFSK 2400 143.9000MHz Mask D 1W
RBW=100Hz, VBW=1000Hz, Detector Mode=Peak
Result=Pass

Occupied Bandwidth and Spectrum Masks

FFSK 2400 bps

SPECIFICATION: FCC CFR 2.1049 (c) RSS-119 5.5

Tx FREQUENCY: 148.1 MHz 5 W 12.5 kHz Channel Spacing

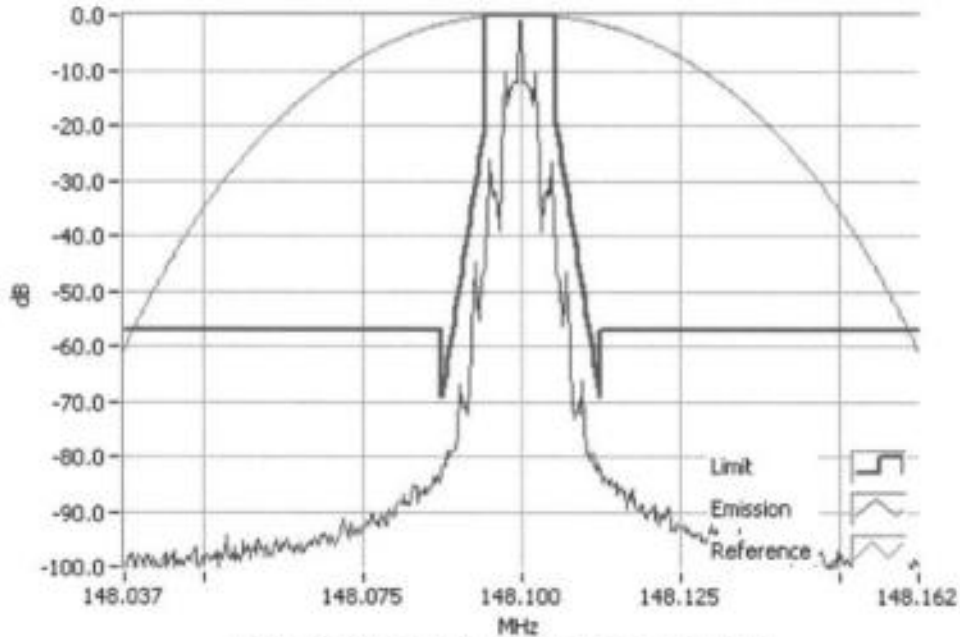

FFSK 2400 148.1000MHz Mask D 5W
RBW=100Hz, VBW=1000Hz, Detector Mode=Peak
Result=Pass

Tx FREQUENCY: 148.1 MHz 1 W 12.5 kHz Channel Spacing

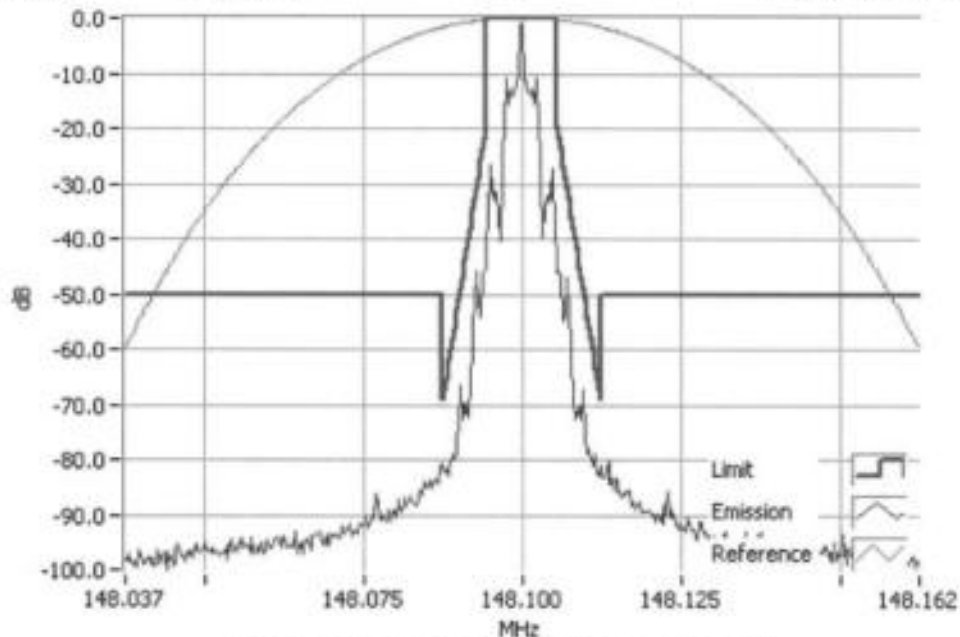

FFSK 2400 148.1000MHz Mask D 1W
RBW=100Hz, VBW=1000Hz, Detector Mode=Peak
Result=Pass

Occupied Bandwidth and Spectrum Masks

FFSK 2400 bps

SPECIFICATION: FCC CFR 2.1049 (c) RSS-119 5.5

Tx FREQUENCY: 149.8 MHz 5 W 12.5 kHz Channel Spacing

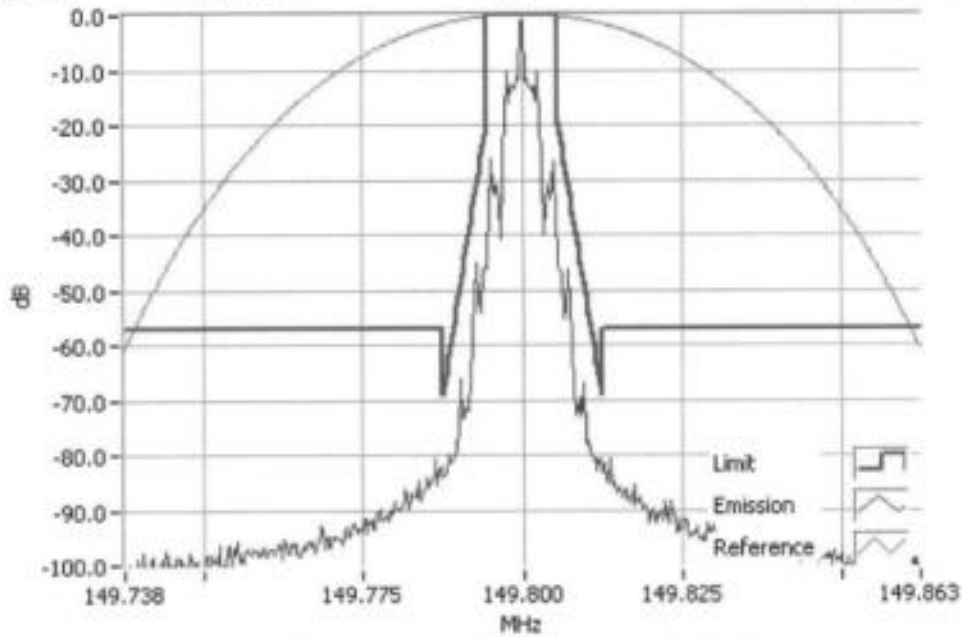

FFSK 2400 149.8000MHz Mask D 5W
RBW=100Hz, VBW=1000Hz, Detector Mode=Peak
Result=Pass

Tx FREQUENCY: 149.8 MHz 1 W 12.5 kHz Channel Spacing

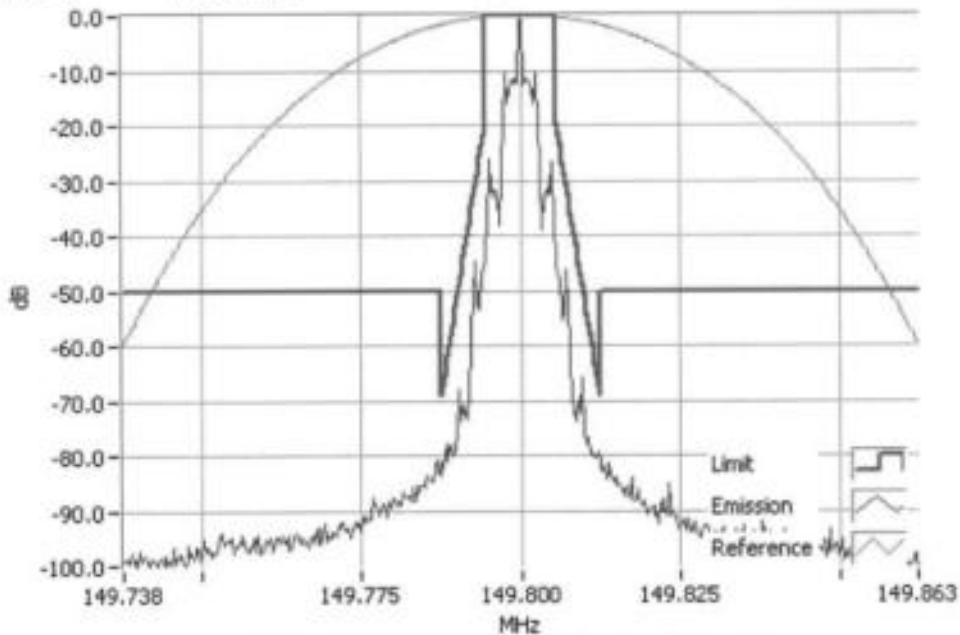

FFSK 2400 149.8000MHz Mask D 1W
RBW=100Hz, VBW=1000Hz, Detector Mode=Peak
Result=Pass

Occupied Bandwidth and Spectrum Masks

FFSK 2400 bps

SPECIFICATION: FCC CFR 2.1049 (c) RSS-119 5.5

Tx FREQUENCY: 152.1 MHz 5 W 12.5 kHz Channel Spacing

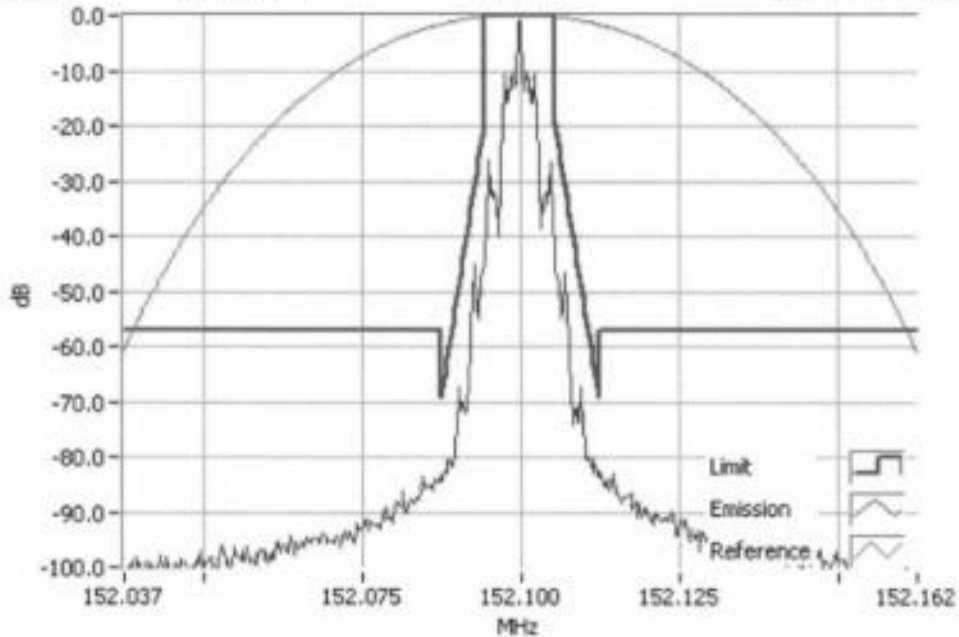

FFSK 2400 152.1000MHz Mask D 5W
RBW=100Hz, VBW=1000Hz, Detector Mode=Peak
Result=Pass

Tx FREQUENCY: 152.1 MHz 1 W 12.5 kHz Channel Spacing

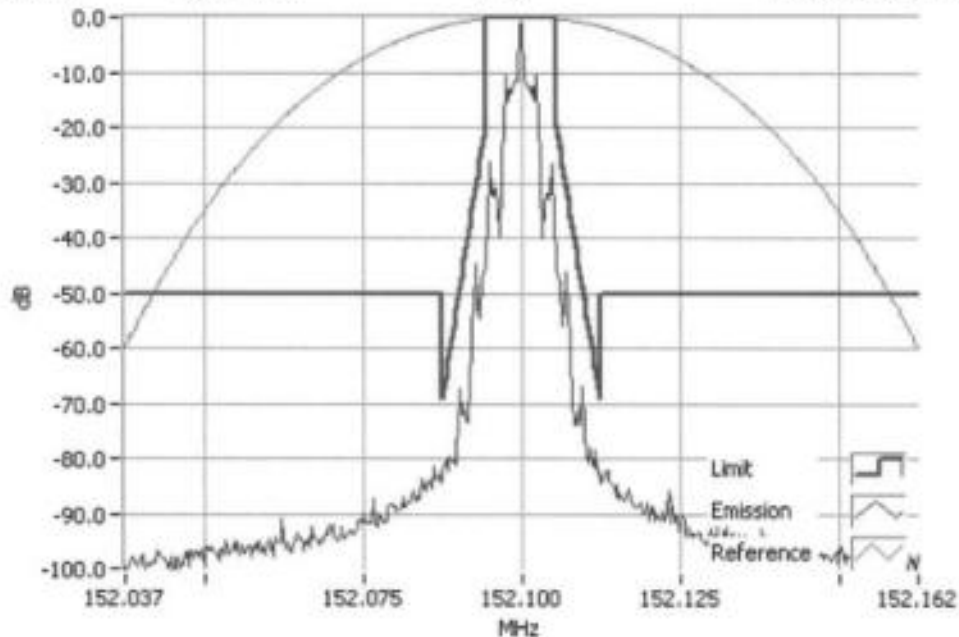

FFSK 2400 152.1000MHz Mask D 1W
RBW=100Hz, VBW=1000Hz, Detector Mode=Peak
Result=Pass

Occupied Bandwidth and Spectrum Masks

FFSK 2400 bps

SPECIFICATION: FCC CFR 2.1049 (c) RSS-119 5.5

Tx FREQUENCY: 153.1 MHz 5 W 12.5 kHz Channel Spacing

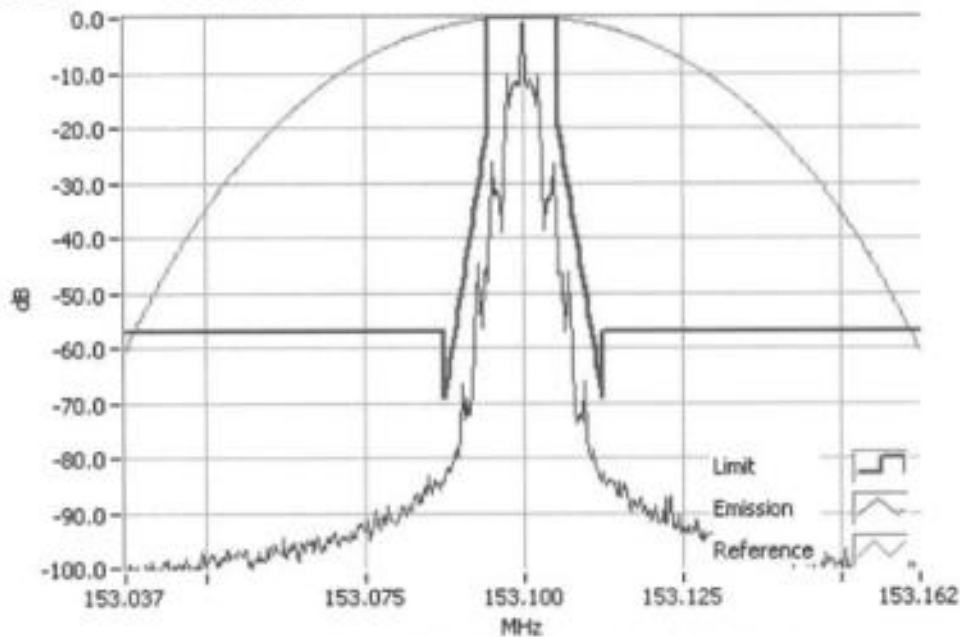

FFSK 2400 153.1000MHz Mask D 5W
RBW=100Hz, VBW=1000Hz, Detector Mode=Peak
Result=Pass

Tx FREQUENCY: 153.1 MHz 1 W 12.5 kHz Channel Spacing

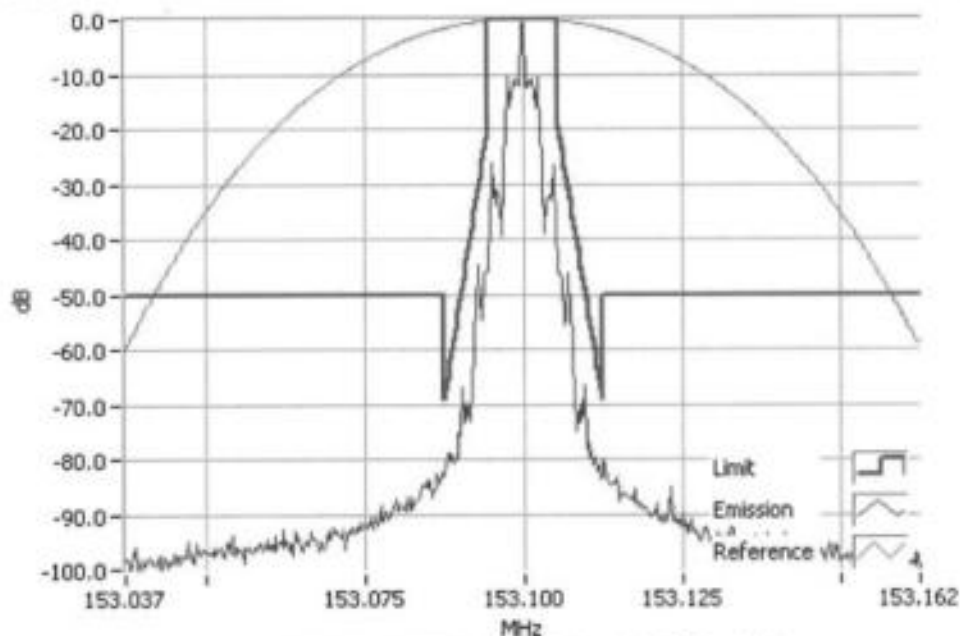

FFSK 2400 153.1000MHz Mask D 1W
RBW=100Hz, VBW=1000Hz, Detector Mode=Peak
Result=Pass

Occupied Bandwidth and Spectrum Masks

FFSK 2400 bps

SPECIFICATION: FCC CFR 2.1049 (c) RSS-119 5.5

Tx FREQUENCY: 158.1 MHz 5 W 12.5 kHz Channel Spacing

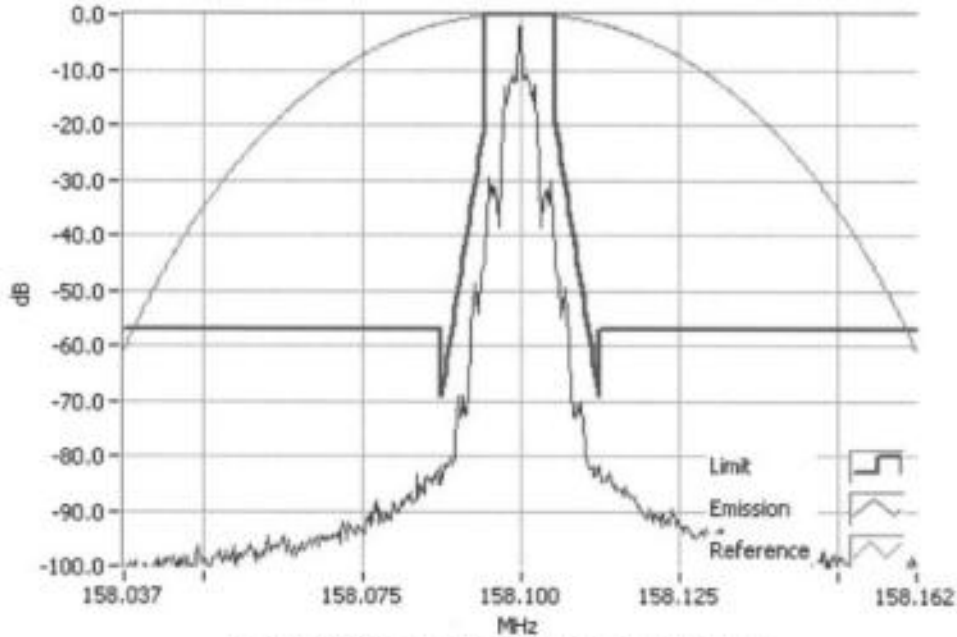

FFSK 2400 158.1000MHz Mask D 5W
RBW=100Hz, VBW=1000Hz, Detector Mode=Peak
Result=Pass

Tx FREQUENCY: 158.1 MHz 1 W 12.5 kHz Channel Spacing

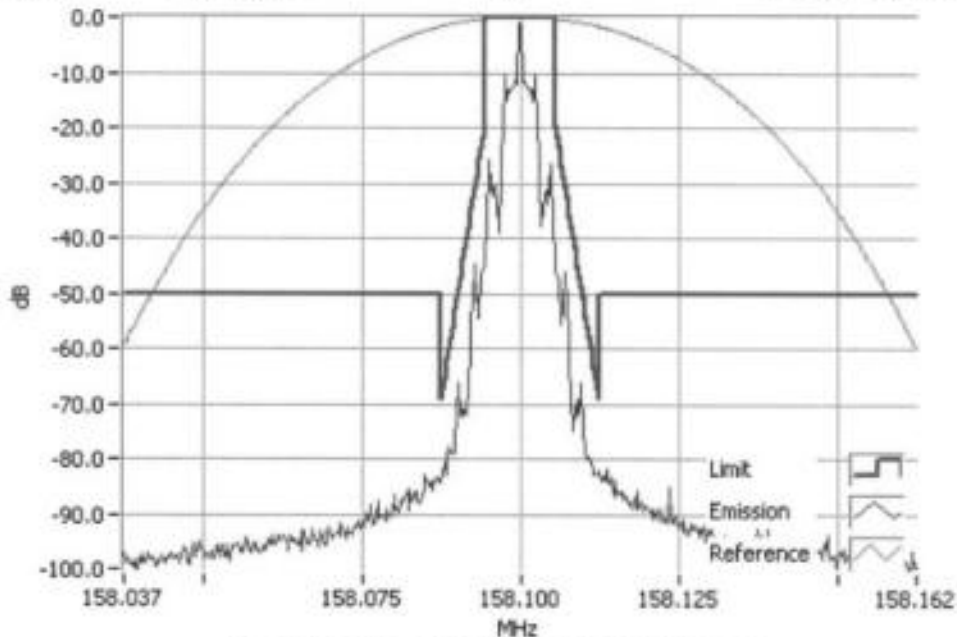

FFSK 2400 158.1000MHz Mask D 1W
RBW=100Hz, VBW=1000Hz, Detector Mode=Peak
Result=Pass

Occupied Bandwidth and Spectrum Masks

FFSK 2400 bps

SPECIFICATION: FCC CFR 2.1049 (c) RSS-119 5.5

Tx FREQUENCY: 161.1 MHz 5 W 12.5 kHz Channel Spacing

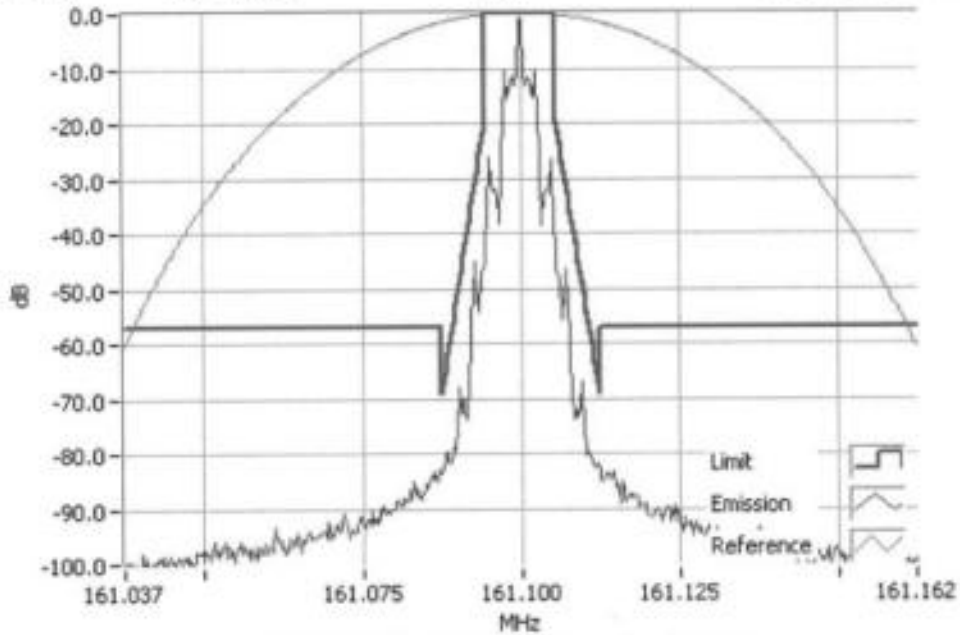

FFSK 2400 161.1000MHz Mask D 5W
RBW=100Hz, VBW=1000Hz, Detector Mode=Peak
Result=Pass

Tx FREQUENCY: 161.1 MHz 1 W 12.5 kHz Channel Spacing

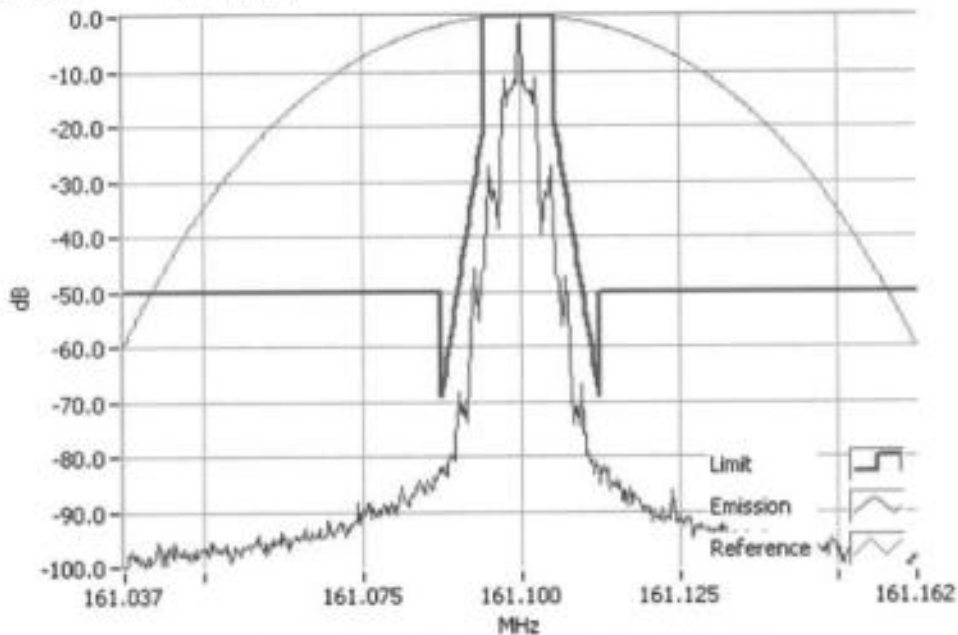

FFSK 2400 161.1000MHz Mask D 1W
RBW=100Hz, VBW=1000Hz, Detector Mode=Peak
Result=Pass

Occupied Bandwidth and Spectrum Masks

FFSK 2400 bps

SPECIFICATION: FCC CFR 2.1049 (c) RSS-119 5.5

Tx FREQUENCY: 173.1 MHz 5 W 12.5 kHz Channel Spacing

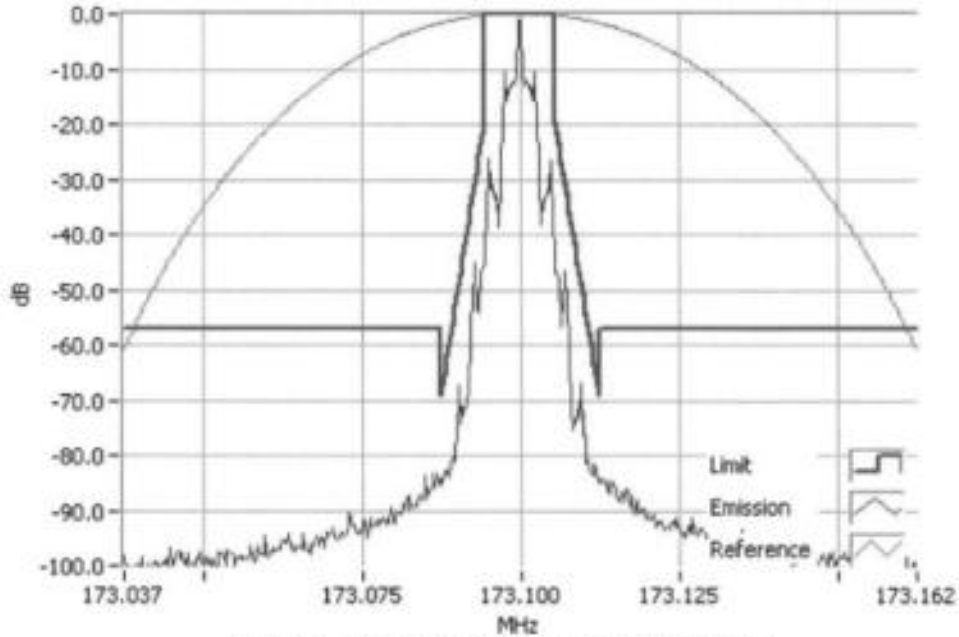

FFSK 2400 173.1000MHz Mask D 5W
RBW=100Hz, VBW=1000Hz, Detector Mode=Peak
Result=Pass

Tx FREQUENCY: 173.1 MHz 1 W 12.5 kHz Channel Spacing

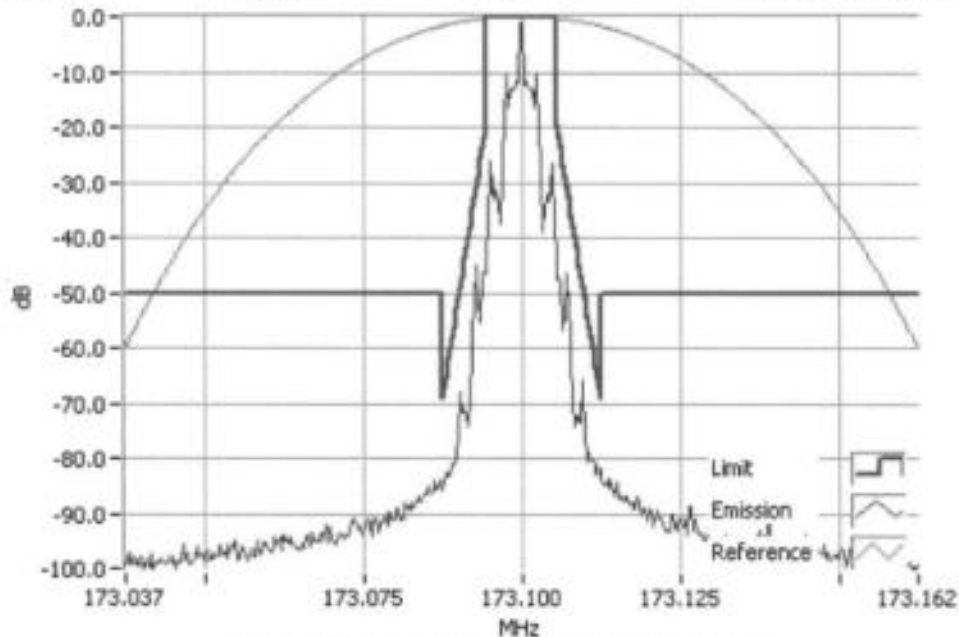

FFSK 2400 173.1000MHz Mask D 1W
RBW=100Hz, VBW=1000Hz, Detector Mode=Peak
Result=Pass

Occupied Bandwidth and Spectrum Masks

DMR

SPECIFICATION: FCC CFR 2.1049 (c) RSS-119 5.5

Tx FREQUENCY: 138.1 MHz 5 W 12.5 kHz Channel Spacing

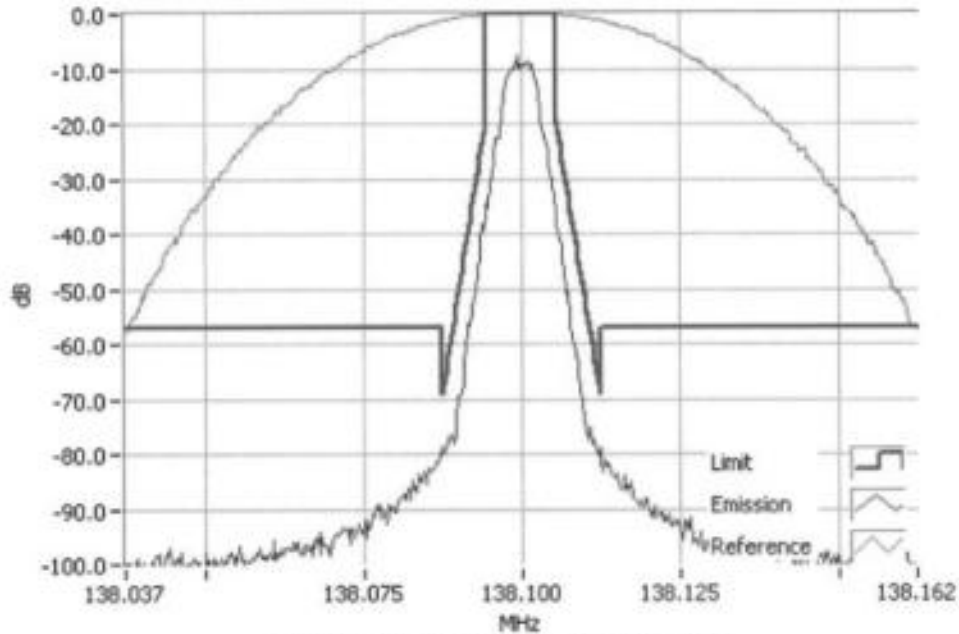

DMR 138.1000MHz Mask D 5W
RBW=100Hz, VBW=1000Hz, Detector Mode=Peak
Result=Pass

Tx FREQUENCY: 138.1 MHz 1 W 12.5 kHz Channel Spacing

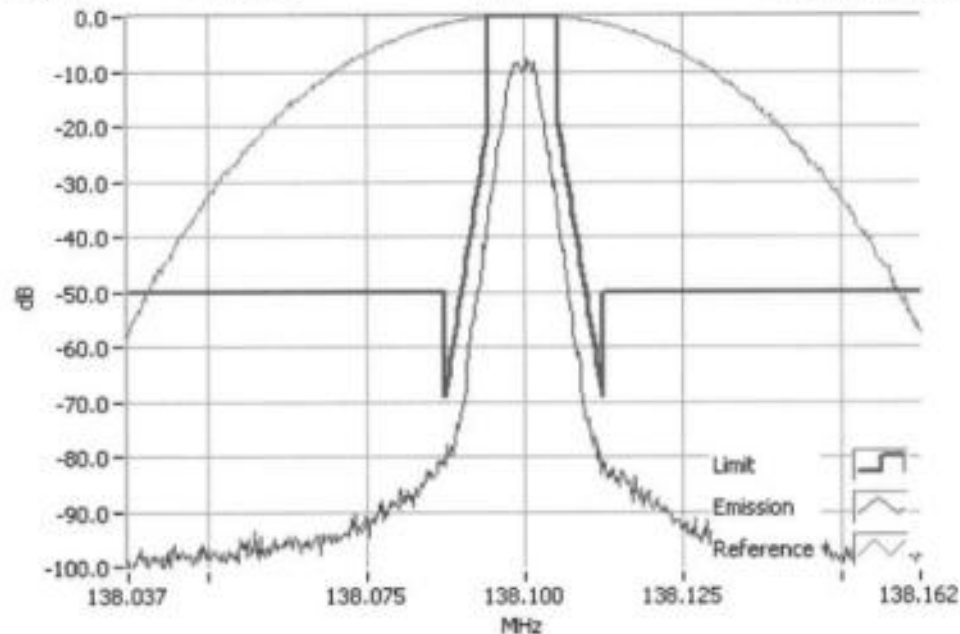

DMR 138.1000MHz Mask D 1W
RBW=100Hz, VBW=1000Hz, Detector Mode=Peak
Result=Pass

Occupied Bandwidth and Spectrum Masks

DMR

SPECIFICATION: FCC CFR 2.1049 (c) RSS-119 5.5

Tx FREQUENCY: 143.9 MHz 5 W 12.5 kHz Channel Spacing

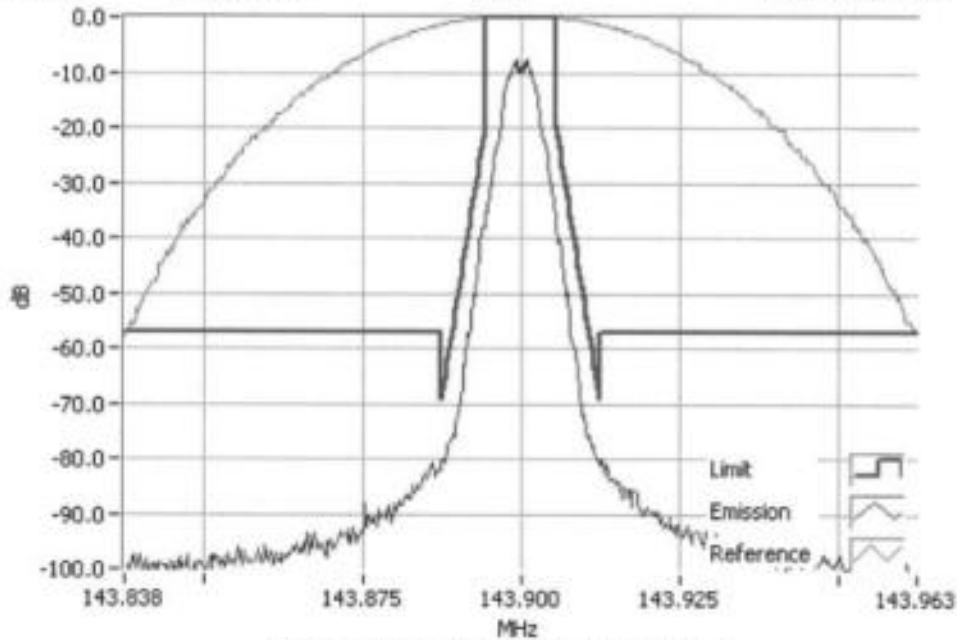

DMR 143.9000MHz Mask D 5W
RBW=100Hz, VBW=1000Hz, Detector Mode=Peak
Result=Pass

Tx FREQUENCY: 143.9 MHz 1 W 12.5 kHz Channel Spacing

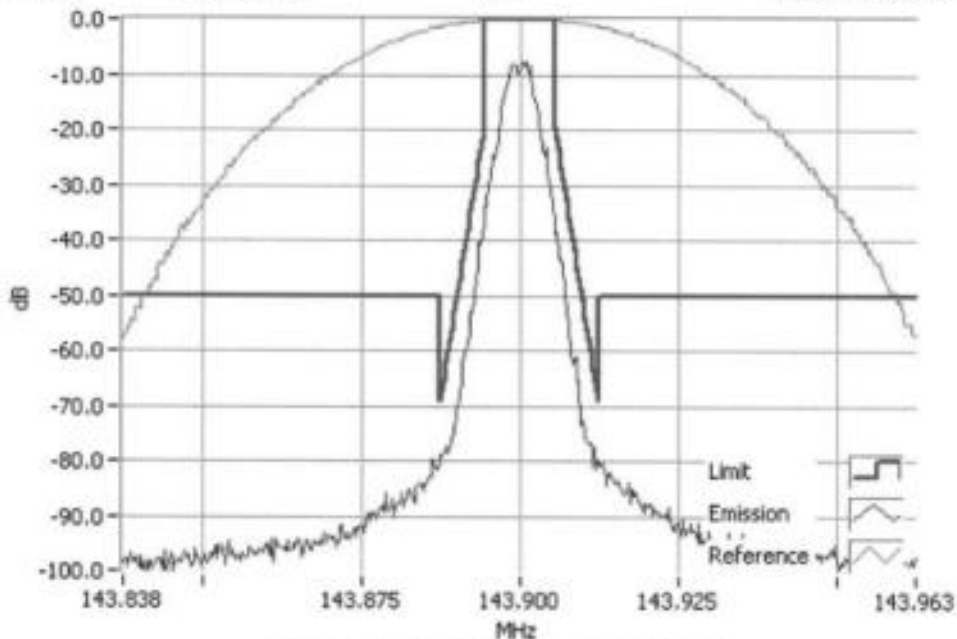

DMR 143.9000MHz Mask D 1W
RBW=100Hz, VBW=1000Hz, Detector Mode=Peak
Result=Pass

Occupied Bandwidth and Spectrum Masks

DMR

SPECIFICATION: FCC CFR 2.1049 (c) RSS-119 5.5

Tx FREQUENCY: 148.1 MHz 5 W 12.5 kHz Channel Spacing

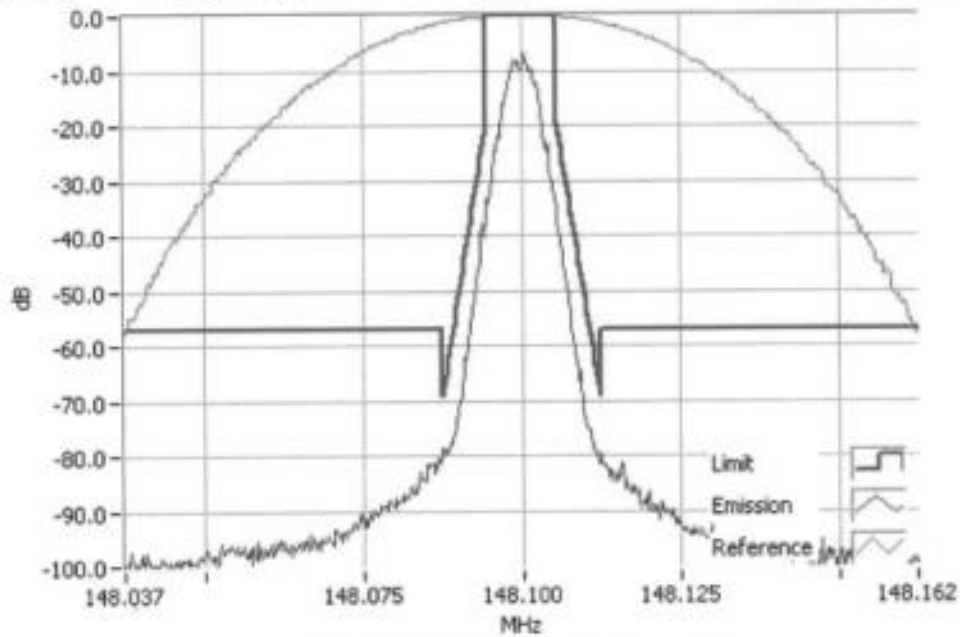

DMR 148.1000MHz Mask D 5W
RBW=100Hz, VBW=1000Hz, Detector Mode=Peak
Result=Pass

Tx FREQUENCY: 148.1 MHz 1 W 12.5 kHz Channel Spacing

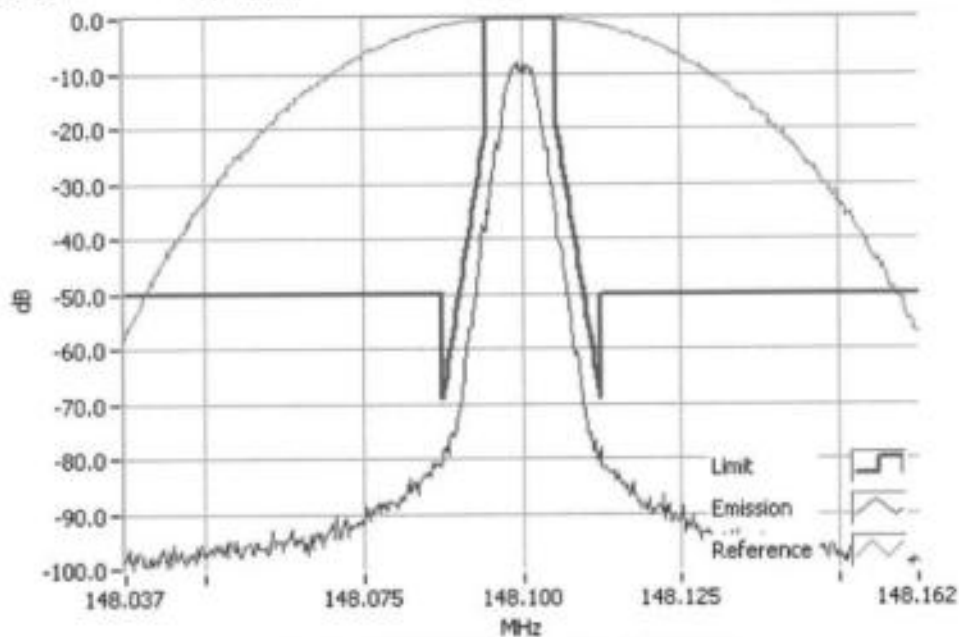

DMR 148.1000MHz Mask D 1W
RBW=100Hz, VBW=1000Hz, Detector Mode=Peak
Result=Pass

Occupied Bandwidth and Spectrum Masks

DMR

SPECIFICATION: FCC CFR 2.1049 (c) RSS-119 5.5

Tx FREQUENCY: 149.8 MHz 5 W 12.5 kHz Channel Spacing

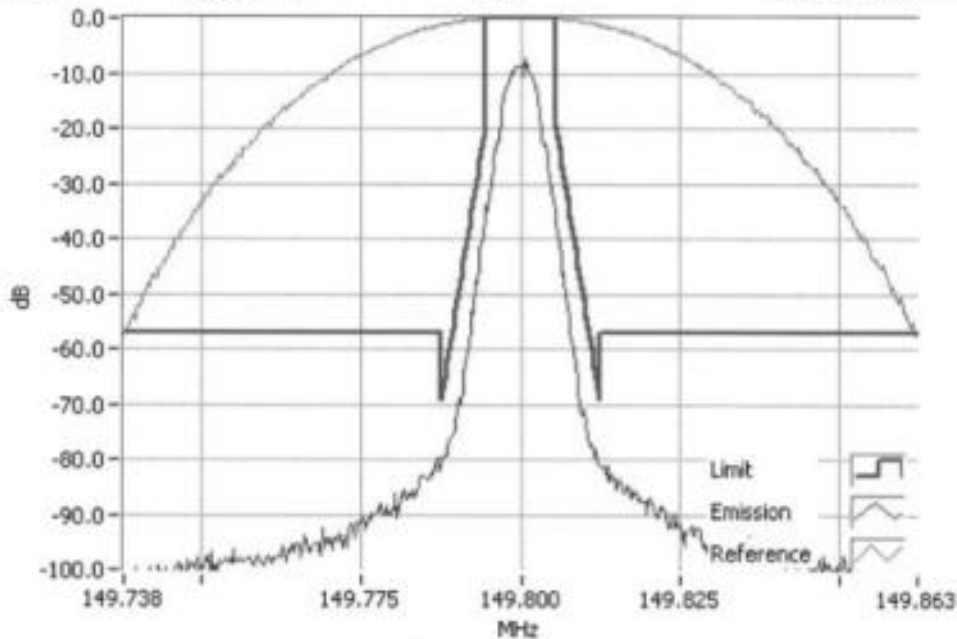

Tx FREQUENCY: 149.8 MHz 1 W 12.5 kHz Channel Spacing

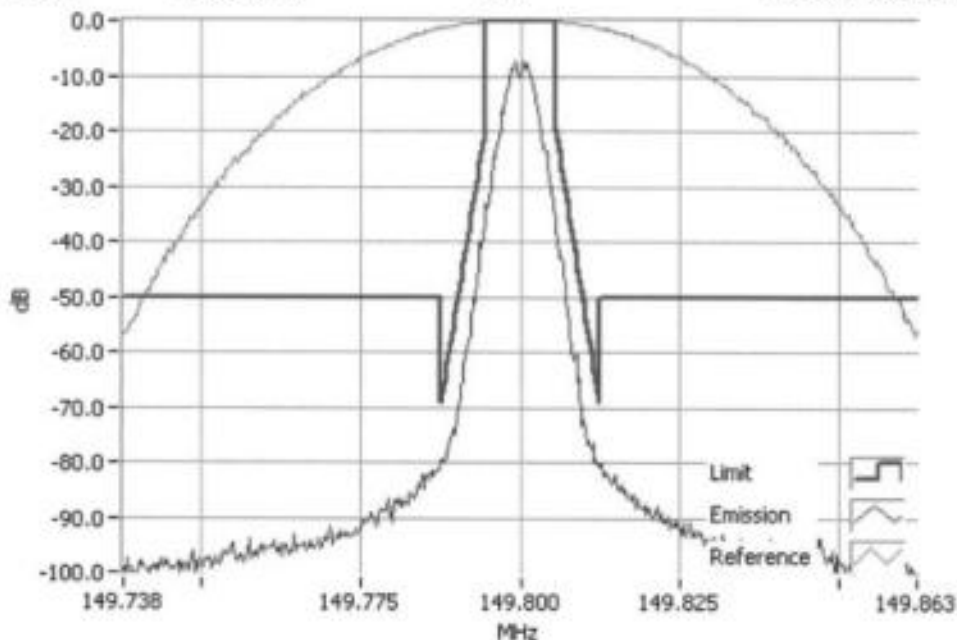

Occupied Bandwidth and Spectrum Masks

DMR

SPECIFICATION: FCC CFR 2.1049 (c) RSS-119 5.5

Tx FREQUENCY: 152.1 MHz 5 W 12.5 kHz Channel Spacing

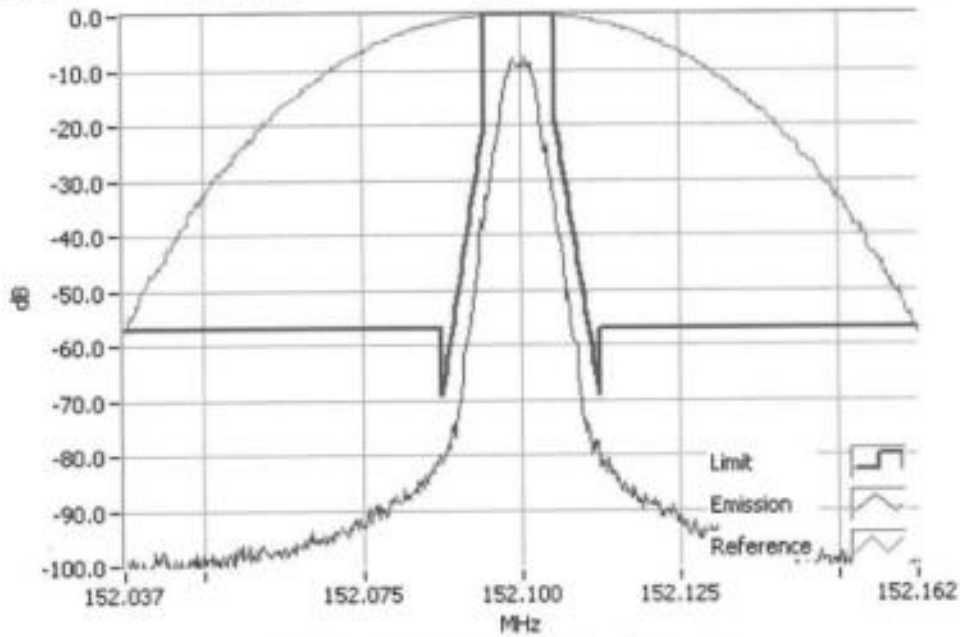

DMR 152.1000MHz Mask D 5W
RBW=100Hz, VBW=1000Hz, Detector Mode=Peak
Result=Pass

Tx FREQUENCY: 152.1 MHz 1 W 12.5 kHz Channel Spacing

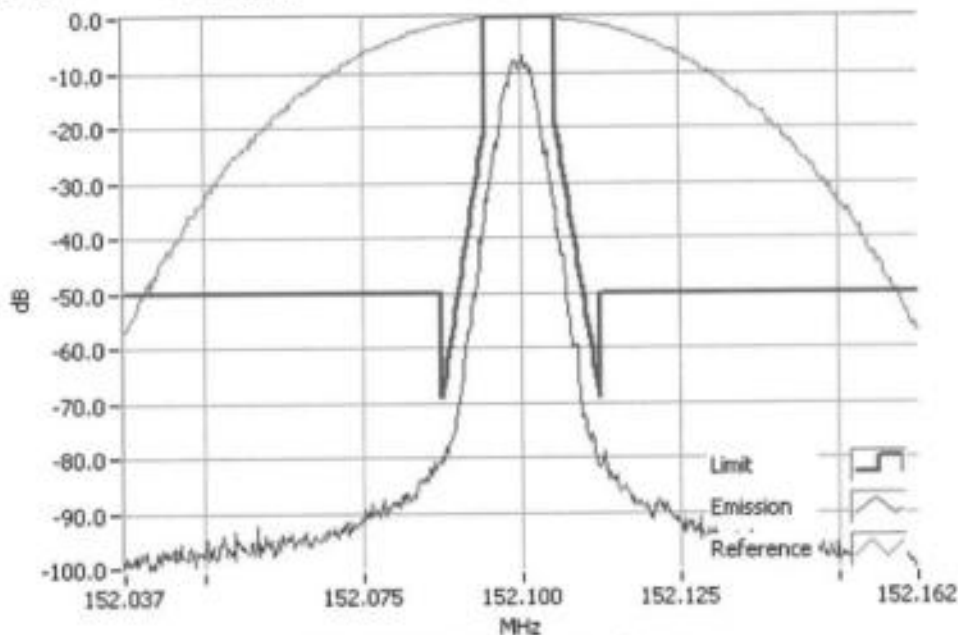

DMR 152.1000MHz Mask D 1W
RBW=100Hz, VBW=1000Hz, Detector Mode=Peak
Result=Pass

Occupied Bandwidth and Spectrum Masks

DMR

SPECIFICATION: FCC CFR 2.1049 (c) RSS-119 5.5

Tx FREQUENCY: 153.1 MHz 5 W 12.5 kHz Channel Spacing

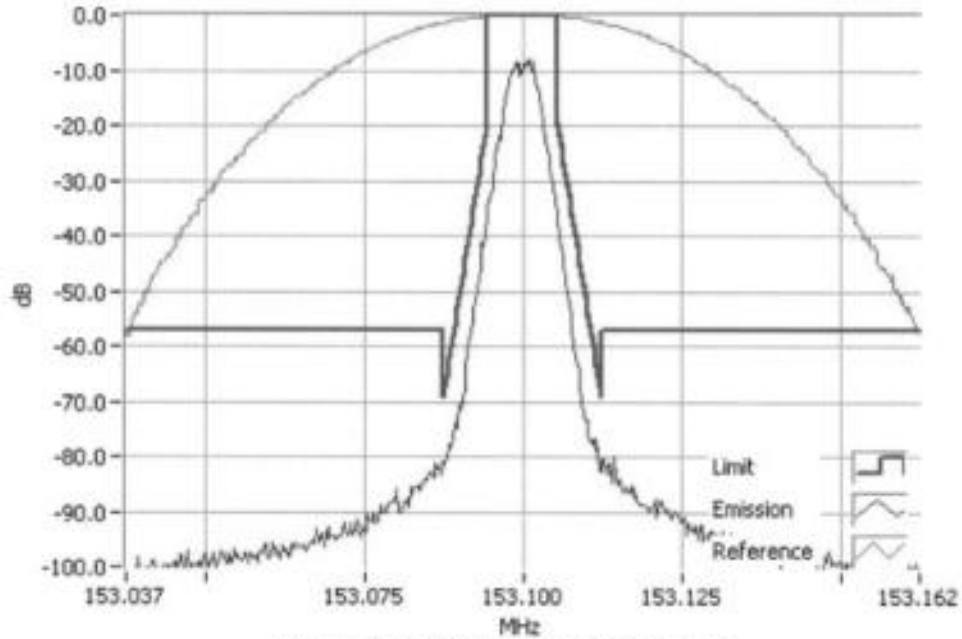

DMR 153.1000MHz Mask D 5W
RBW=100Hz, VBW=1000Hz, Detector Mode=Peak
Result=Pass

Tx FREQUENCY: 153.1 MHz 1 W 12.5 kHz Channel Spacing

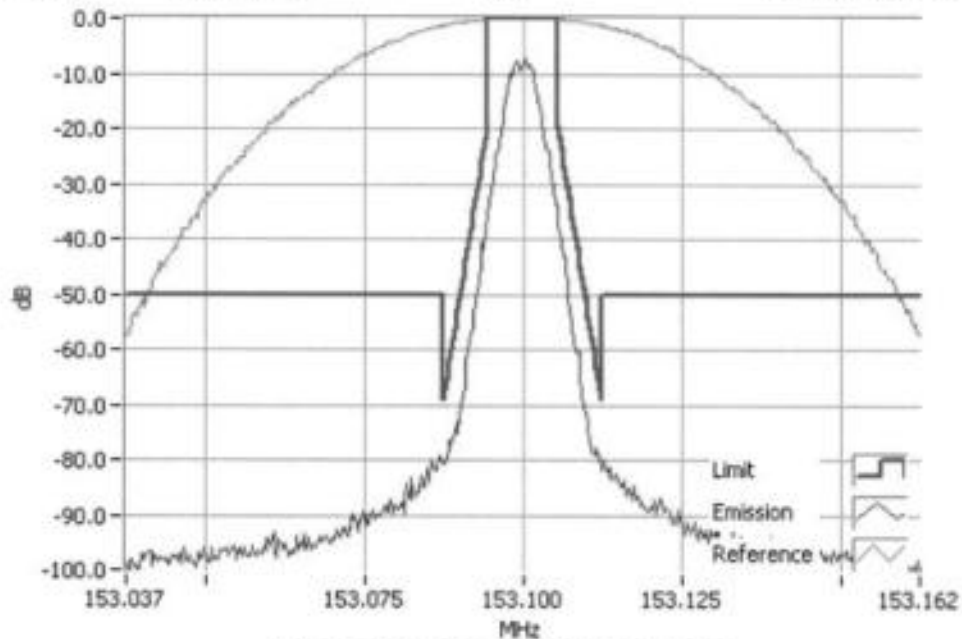

DMR 153.1000MHz Mask D 1W
RBW=100Hz, VBW=1000Hz, Detector Mode=Peak
Result=Pass

Occupied Bandwidth and Spectrum Masks

DMR

SPECIFICATION: FCC CFR 2.1049 (c) RSS-119 5.5

Tx FREQUENCY: 158.1 MHz 5 W 12.5 kHz Channel Spacing

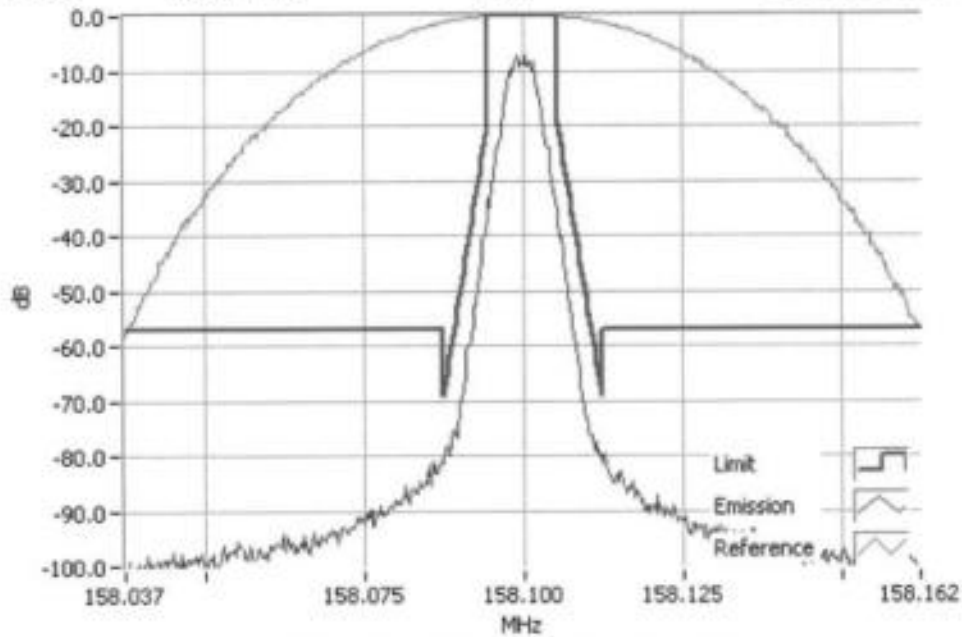

DMR 158.1000MHz Mask D 5W
RBW=100Hz, VBW=1000Hz, Detector Mode=Peak
Result=Pass

Tx FREQUENCY: 158.1 MHz 1 W 12.5 kHz Channel Spacing

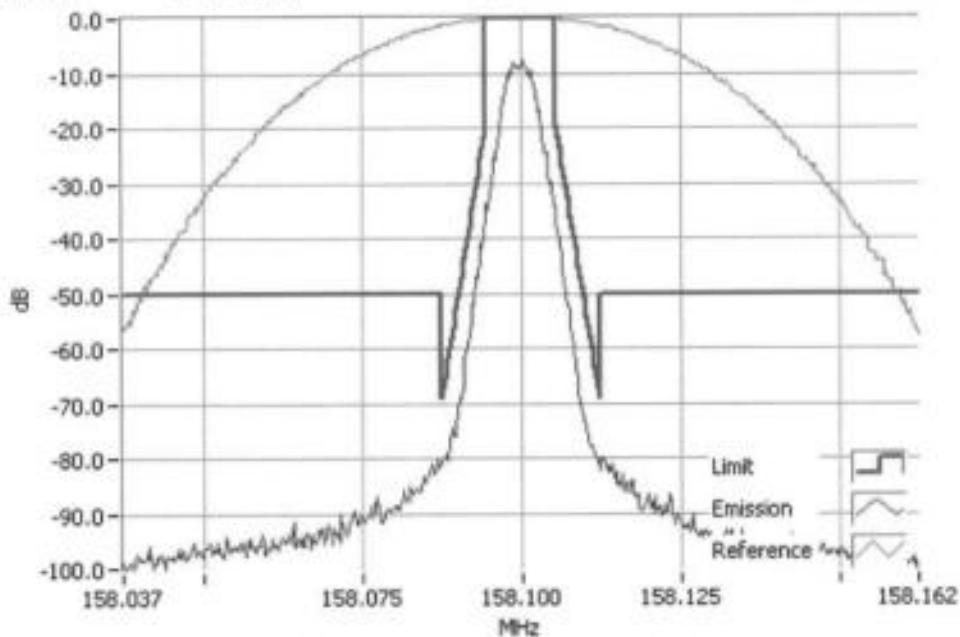

DMR 158.1000MHz Mask D 1W
RBW=100Hz, VBW=1000Hz, Detector Mode=Peak
Result=Pass

Occupied Bandwidth and Spectrum Masks

DMR

SPECIFICATION: FCC CFR 2.1049 (c) RSS-119 5.5

Tx FREQUENCY: 161.1 MHz 5 W 12.5 kHz Channel Spacing

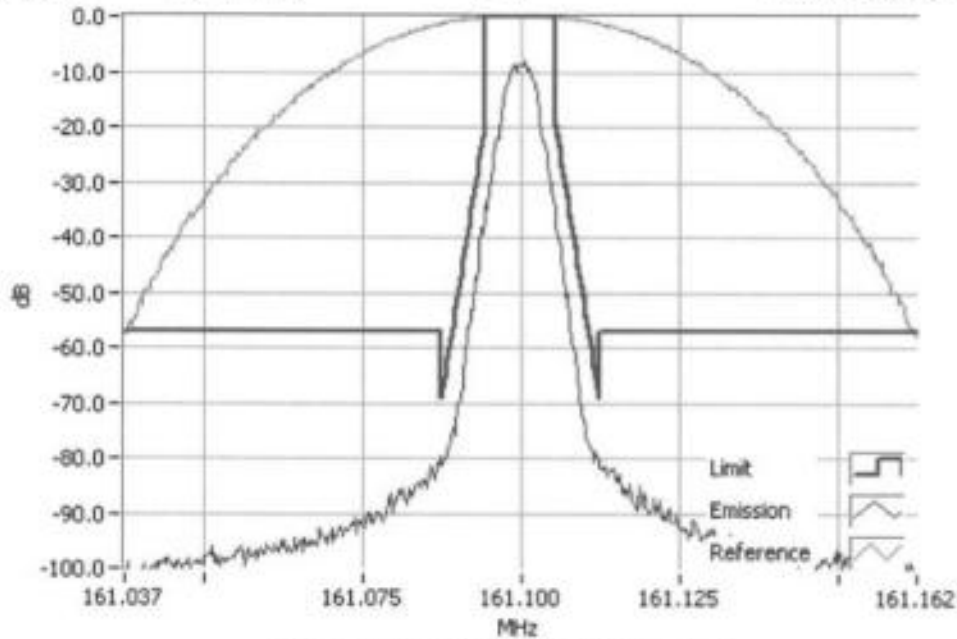

DMR 161.1000MHz Mask D 5W
RBW=100Hz, VBW=1000Hz, Detector Mode=Peak
Result=Pass

Tx FREQUENCY: 161.1 MHz 1 W 12.5 kHz Channel Spacing

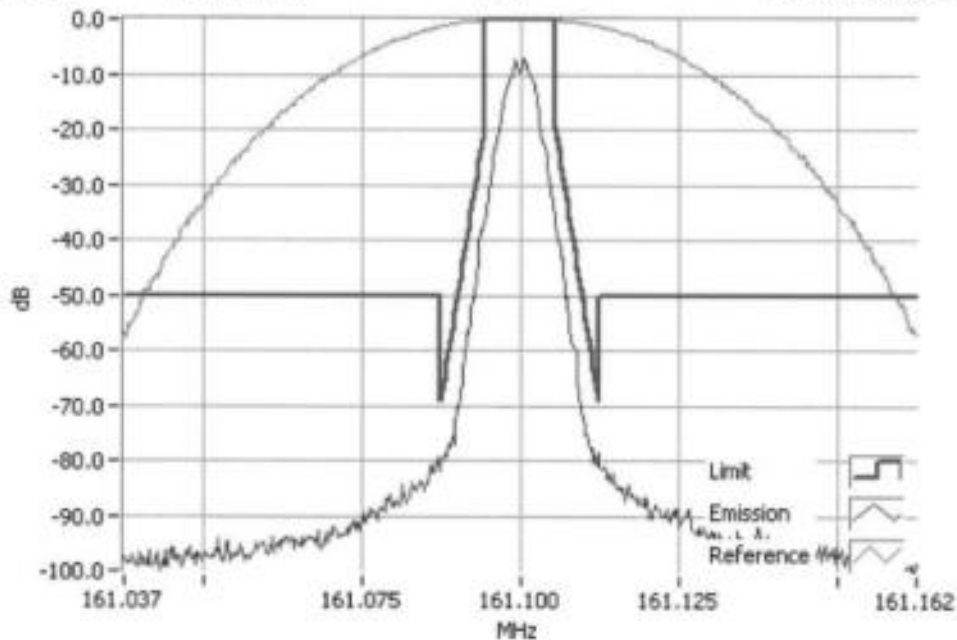

DMR 161.1000MHz Mask D 1W
RBW=100Hz, VBW=1000Hz, Detector Mode=Peak
Result=Pass

Occupied Bandwidth and Spectrum Masks

DMR

SPECIFICATION: FCC CFR 2.1049 (c) RSS-119 5.5

Tx FREQUENCY: 173.1 MHz 5 W 12.5 kHz Channel Spacing

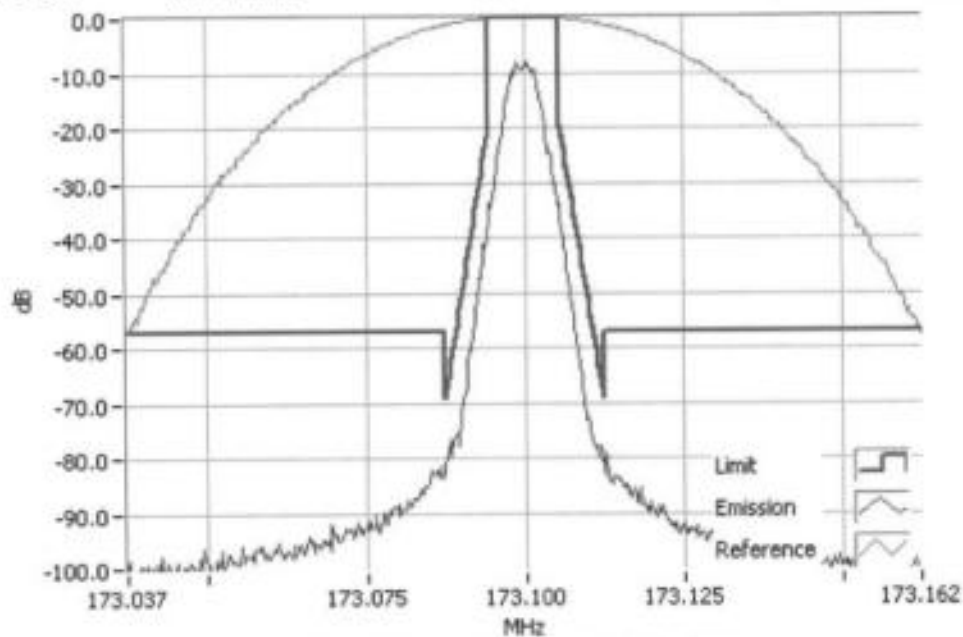

DMR 173.1000MHz Mask D 5W
RBW=100Hz, VBW=1000Hz, Detector Mode=Peak
Result=Pass

Tx FREQUENCY: 173.1 MHz 1 W 12.5 kHz Channel Spacing

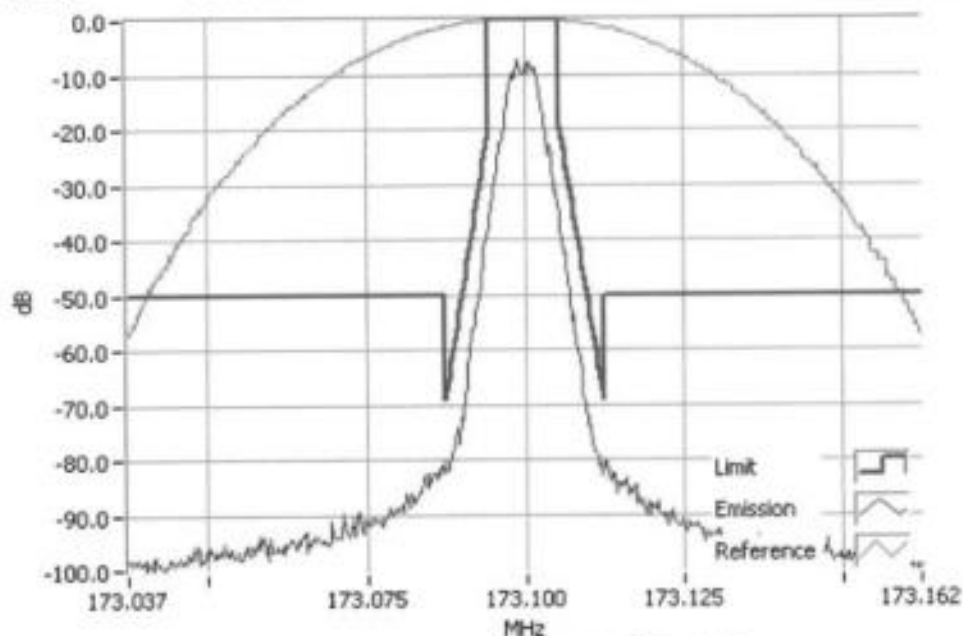

DMR 173.1000MHz Mask D 1W
RBW=100Hz, VBW=1000Hz, Detector Mode=Peak
Result=Pass

Occupied Bandwidth and Spectrum Masks

APCO P25 phase-1

SPECIFICATION: FCC CFR 2.1049 (c) RSS-119 5.5

Tx FREQUENCY: 138.1 MHz 5 W 12.5 kHz Channel Spacing

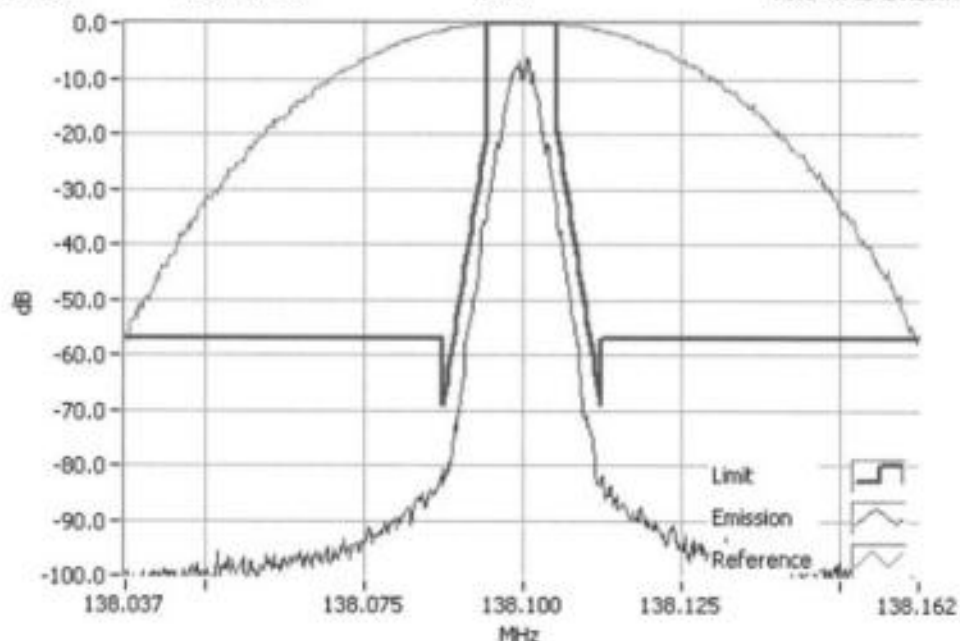

P25 Ph 1 138.1000MHz Mask D 5W
RBW=100Hz, VBW=1000Hz, Detector Mode=Peak
Result=Pass

Tx FREQUENCY: 138.1 MHz 1 W 12.5 kHz Channel Spacing

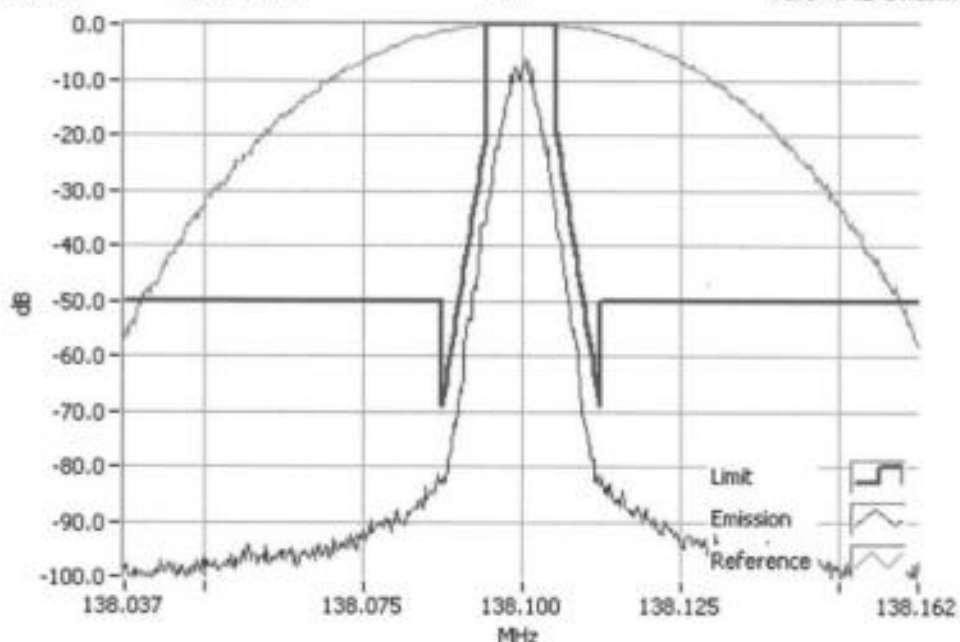

P25 Ph 1 138.1000MHz Mask D 1W
RBW=100Hz, VBW=1000Hz, Detector Mode=Peak
Result=Pass

Occupied Bandwidth and Spectrum Masks

APCO P25 phase-1

SPECIFICATION: FCC CFR 2.1049 (c) RSS-119 5.5

Tx FREQUENCY: 143.9 MHz 5 W 12.5 kHz Channel Spacing

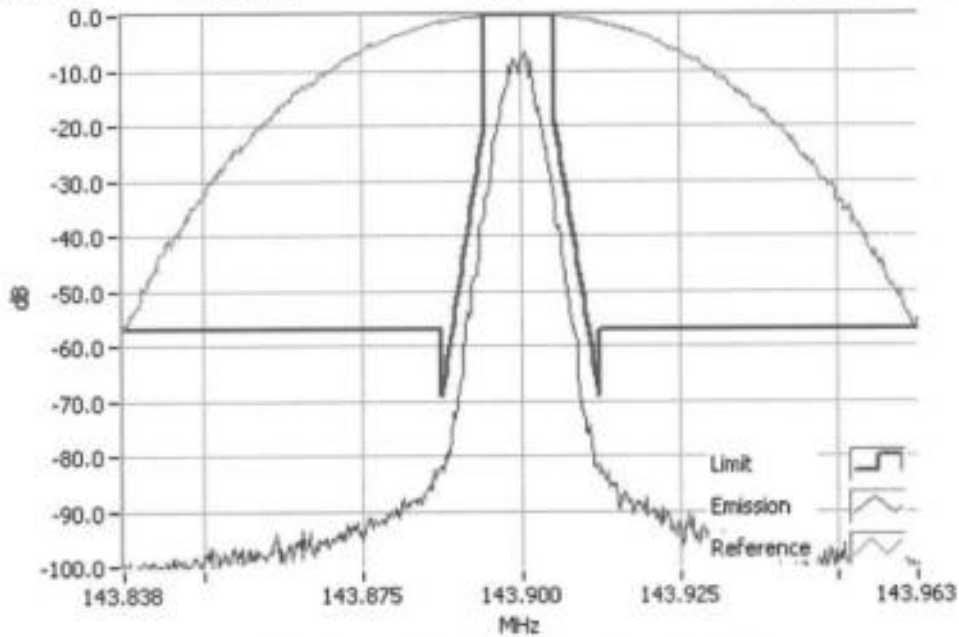

P25 Ph 1 143.9000MHz Mask D 5W
RBW=100Hz, VBW=1000Hz, Detector Mode=Peak
Result=Pass

Tx FREQUENCY: 143.9 MHz 1 W 12.5 kHz Channel Spacing

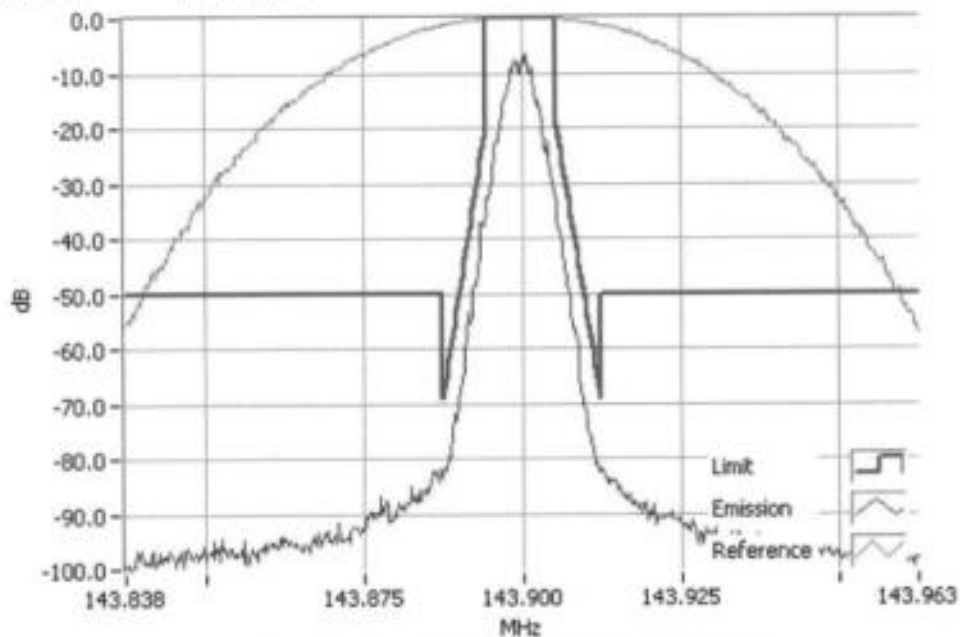

P25 Ph 1 143.9000MHz Mask D 1W
RBW=100Hz, VBW=1000Hz, Detector Mode=Peak
Result=Pass

Occupied Bandwidth and Spectrum Masks

APCO P25 phase-1

SPECIFICATION: FCC CFR 2.1049 (c) RSS-119 5.5

Tx FREQUENCY: 148.1 MHz 5 W 12.5 kHz Channel Spacing

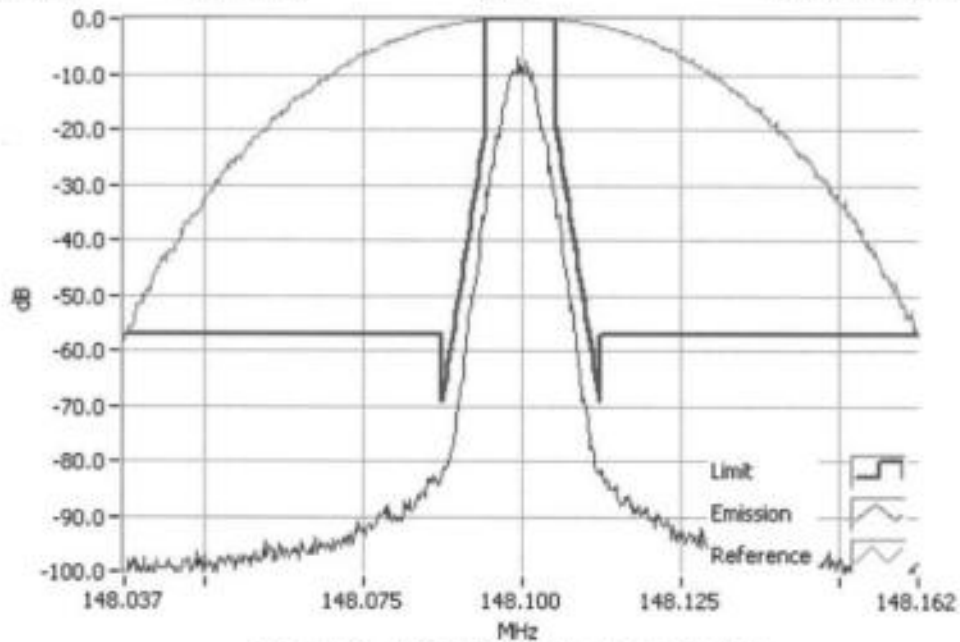

P25 Ph 1 148.1000MHz Mask D 5W
RBW=100Hz, VBW=1000Hz, Detector Mode=Peak
Result=Pass

Tx FREQUENCY: 148.1 MHz 1 W 12.5 kHz Channel Spacing

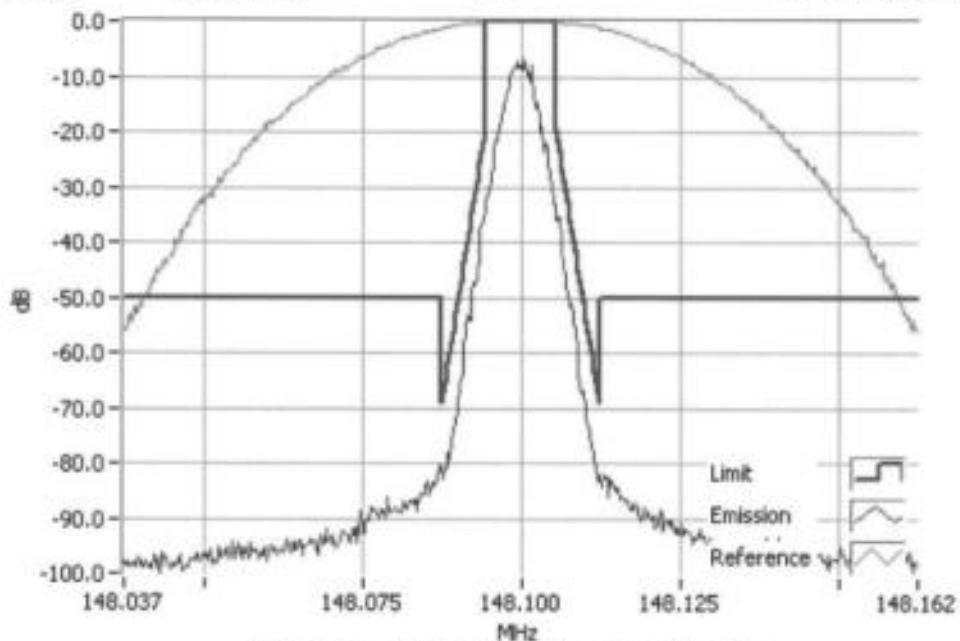

P25 Ph 1 148.1000MHz Mask D 1W
RBW=100Hz, VBW=1000Hz, Detector Mode=Peak
Result=Pass

Occupied Bandwidth and Spectrum Masks

APCO P25 phase-1

SPECIFICATION: FCC CFR 2.1049 (c) RSS-119 5.5

Tx FREQUENCY: 149.8 MHz 5 W 12.5 kHz Channel Spacing

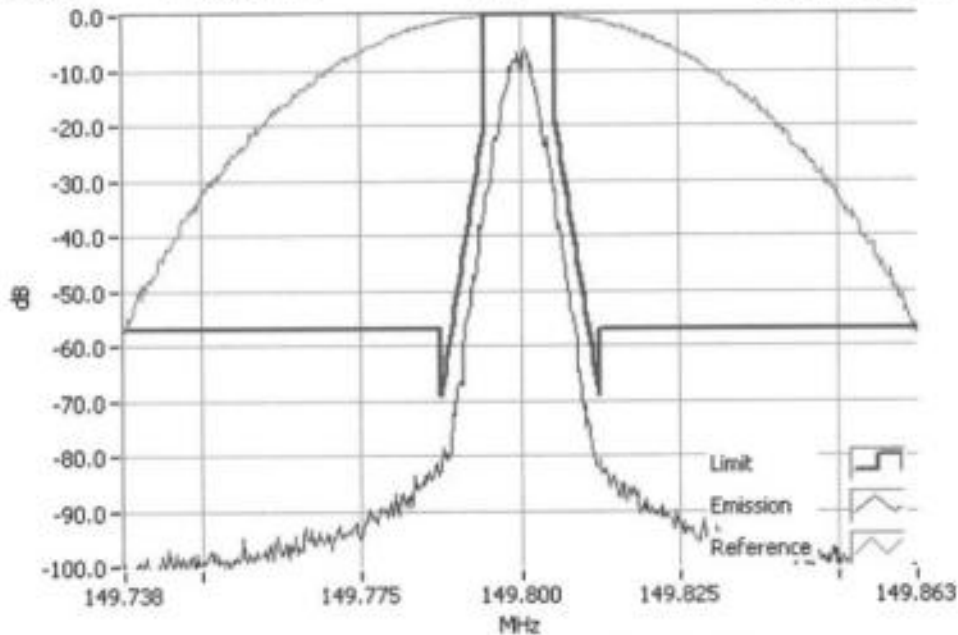

P25 Ph 1 149.8000MHz Mask D 5W
RBW=100Hz, VBW=1000Hz, Detector Mode=Peak
Result=Pass

Tx FREQUENCY: 149.8 MHz 1 W 12.5 kHz Channel Spacing

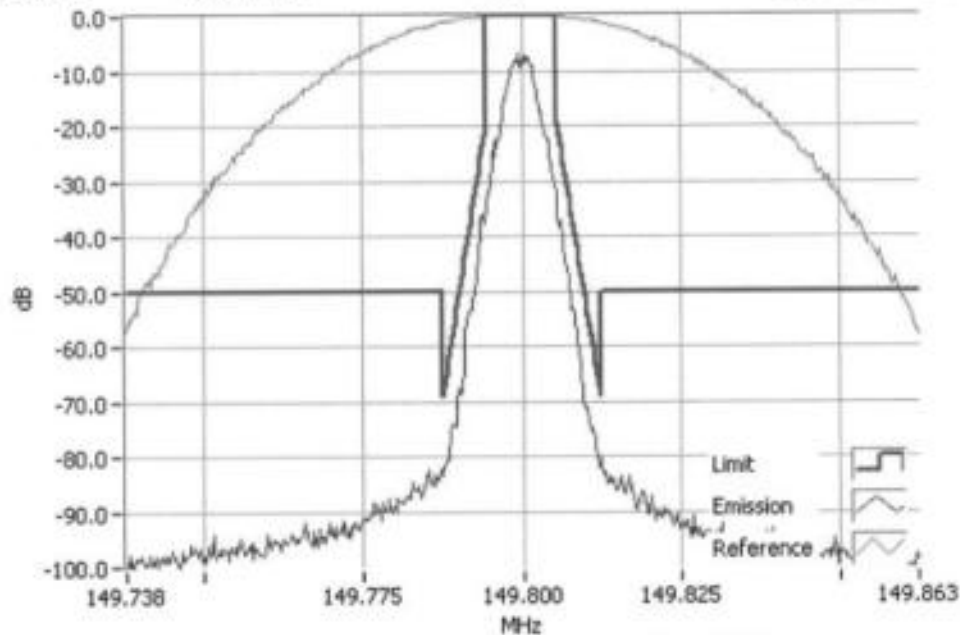

P25 Ph 1 149.8000MHz Mask D 1W
RBW=100Hz, VBW=1000Hz, Detector Mode=Peak
Result=Pass

Occupied Bandwidth and Spectrum Masks

APCO P25 phase-1

SPECIFICATION: FCC CFR 2.1049 (c) RSS-119 5.5

Tx FREQUENCY: 152.1 MHz 5 W 12.5 kHz Channel Spacing

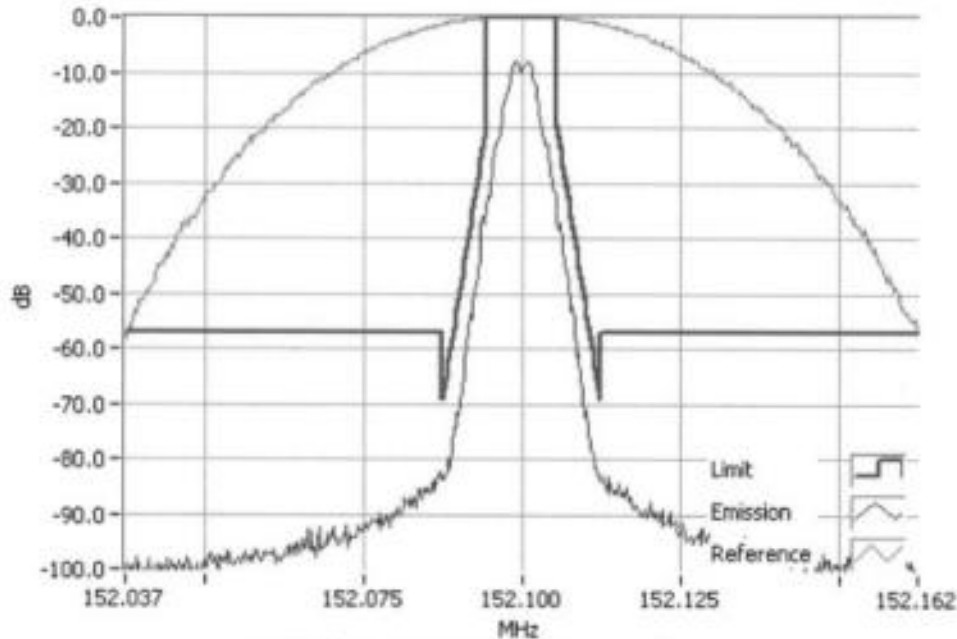

P25 Ph 1 152.1000MHz Mask D 5W
RBW=100Hz, VBW=1000Hz, Detector Mode=Peak
Result=Pass

Tx FREQUENCY: 152.1 MHz 1 W 12.5 kHz Channel Spacing

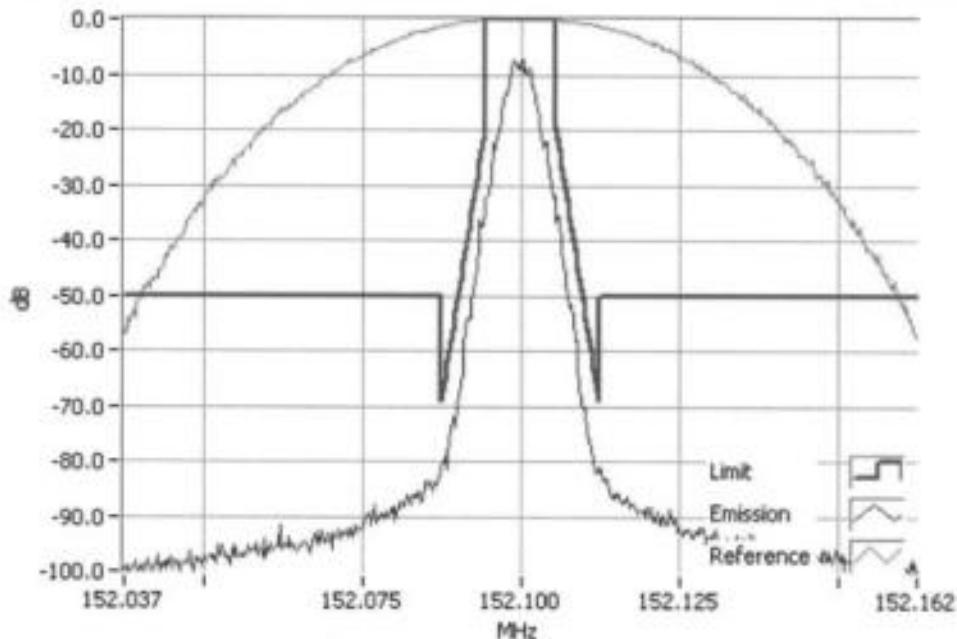

P25 Ph 1 152.1000MHz Mask D 1W
RBW=100Hz, VBW=1000Hz, Detector Mode=Peak
Result=Pass

Occupied Bandwidth and Spectrum Masks

APCO P25 phase-1

SPECIFICATION: FCC CFR 2.1049 (c) RSS-119 5.5

Tx FREQUENCY: 153.1 MHz 5 W 12.5 kHz Channel Spacing

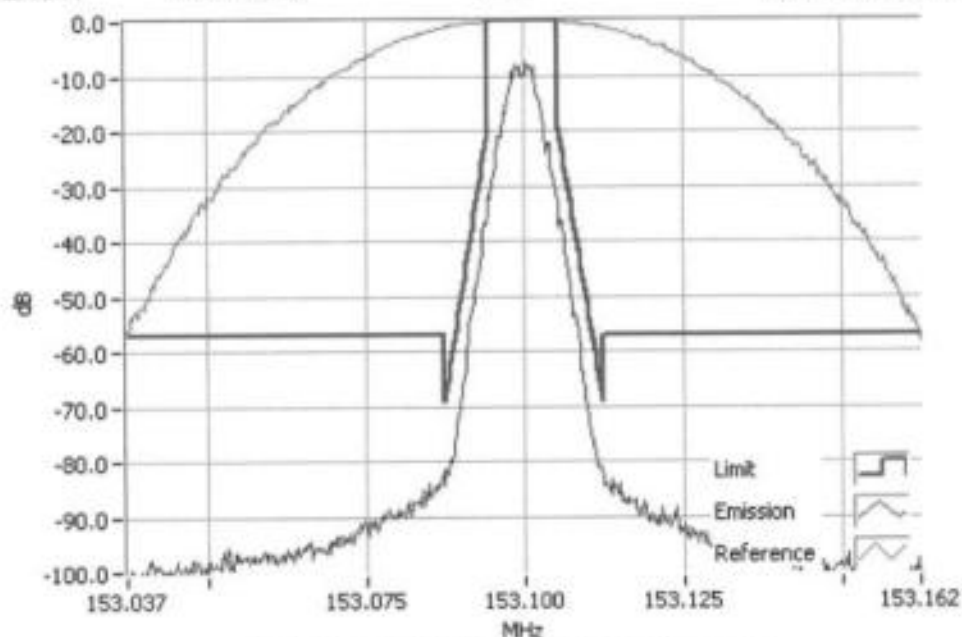

P25 Ph 1 153.1000MHz Mask D 5W
RBW=100Hz, VBW=1000Hz, Detector Mode=Peak
Result=Pass

Tx FREQUENCY: 153.1 MHz 1 W 12.5 kHz Channel Spacing

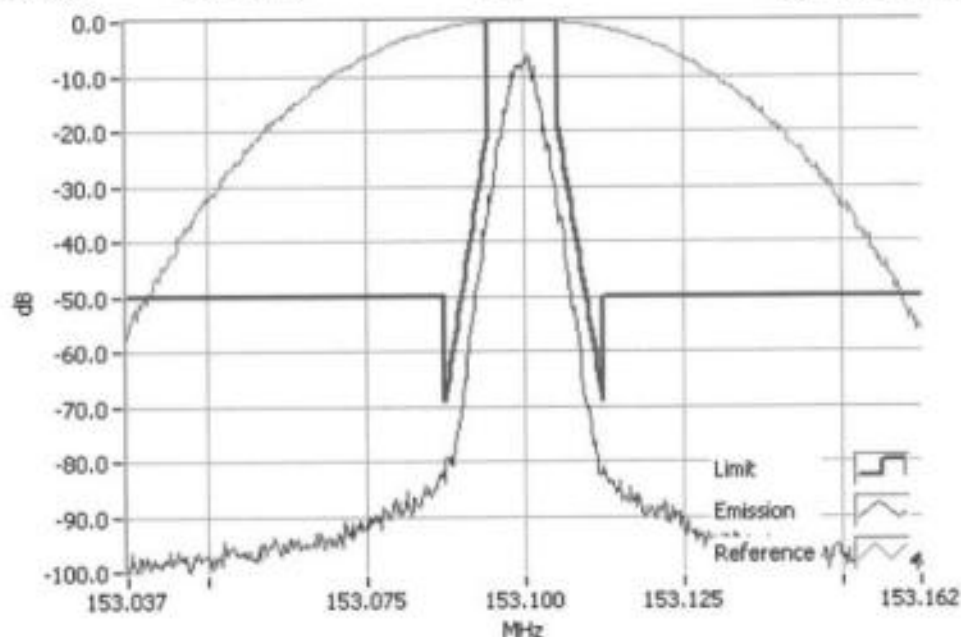

P25 Ph 1 153.1000MHz Mask D 1W
RBW=100Hz, VBW=1000Hz, Detector Mode=Peak
Result=Pass

Occupied Bandwidth and Spectrum Masks

APCO P25 phase-1

SPECIFICATION: FCC CFR 2.1049 (c) RSS-119 5.5

Tx FREQUENCY: 158.1 MHz 5 W 12.5 kHz Channel Spacing

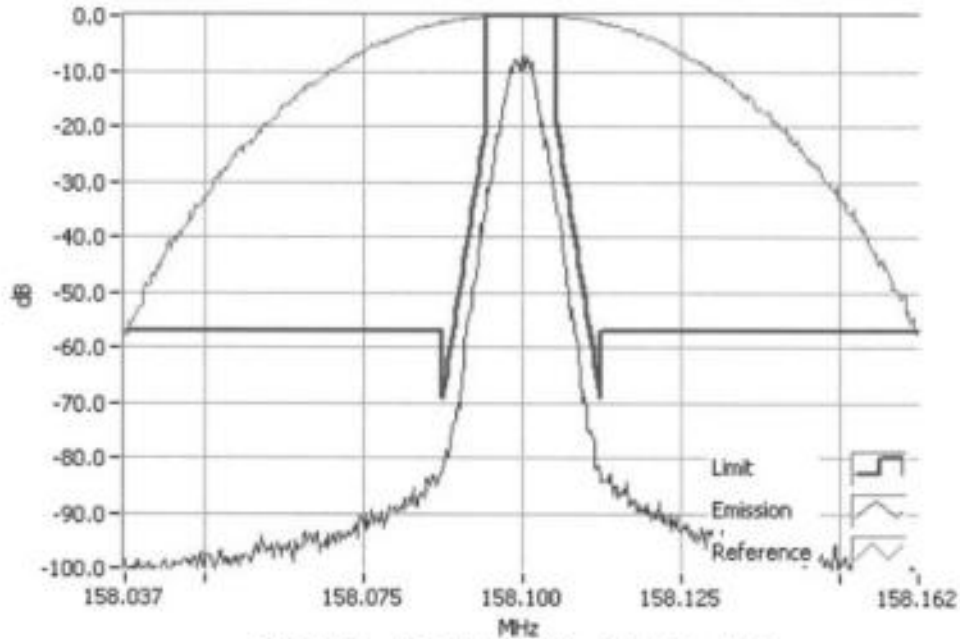

P25 Ph 1 158.1000MHz Mask D 5W
RBW=100Hz, VBW=1000Hz, Detector Mode=Peak
Result=Pass

Tx FREQUENCY: 158.1 MHz 1 W 12.5 kHz Channel Spacing

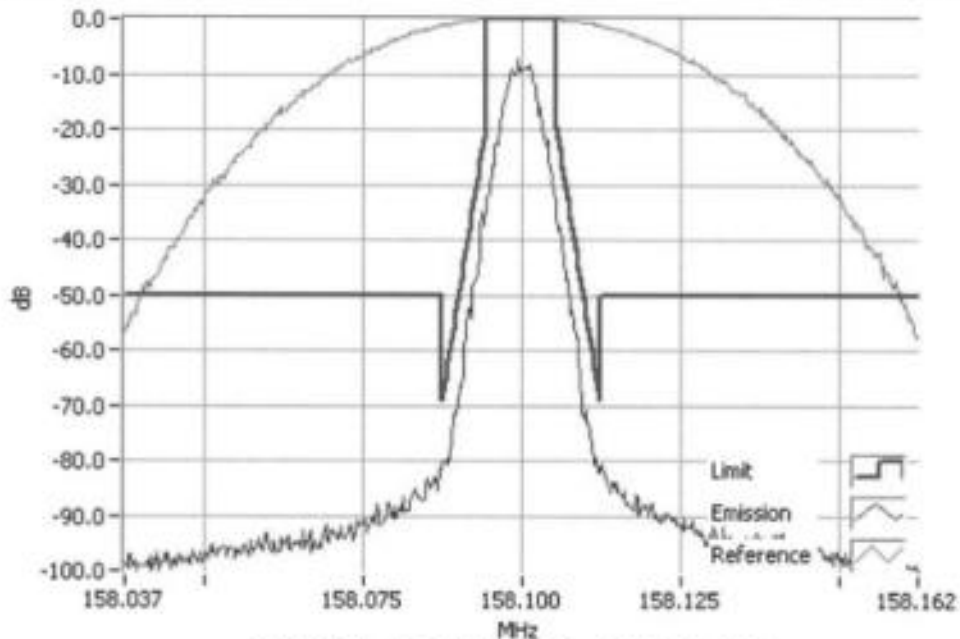

P25 Ph 1 158.1000MHz Mask D 1W
RBW=100Hz, VBW=1000Hz, Detector Mode=Peak
Result=Pass

Occupied Bandwidth and Spectrum Masks

APCO P25 phase-1

SPECIFICATION: FCC CFR 2.1049 (c) RSS-119 5.5

Tx FREQUENCY: 161.1 MHz 5 W 12.5 kHz Channel Spacing

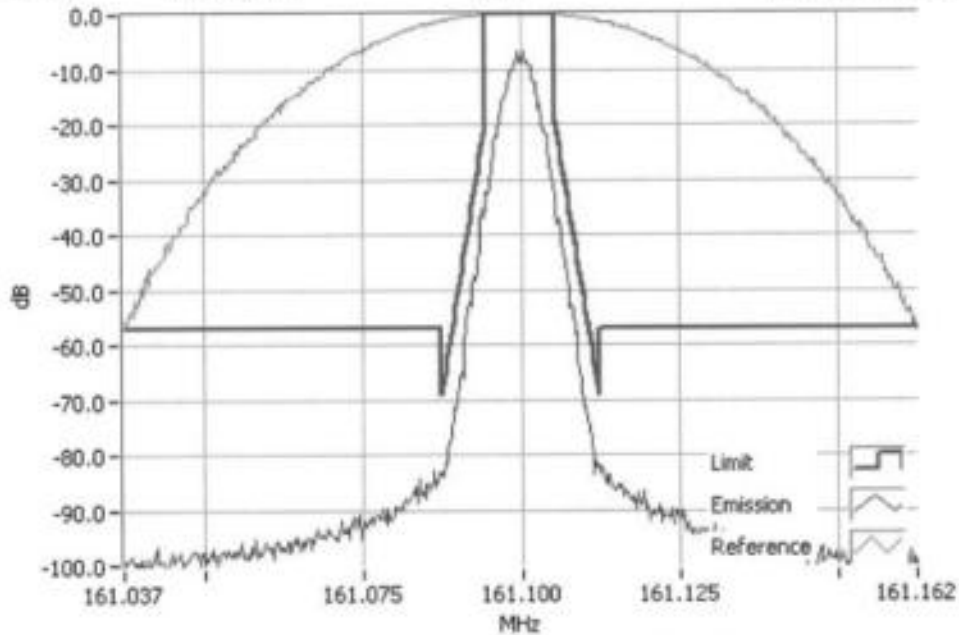

P25 Ph 1 161.1000MHz Mask D 5W
RBW=100Hz, VBW=1000Hz, Detector Mode=Peak
Result=Pass

Tx FREQUENCY: 161.1 MHz 1 W 12.5 kHz Channel Spacing

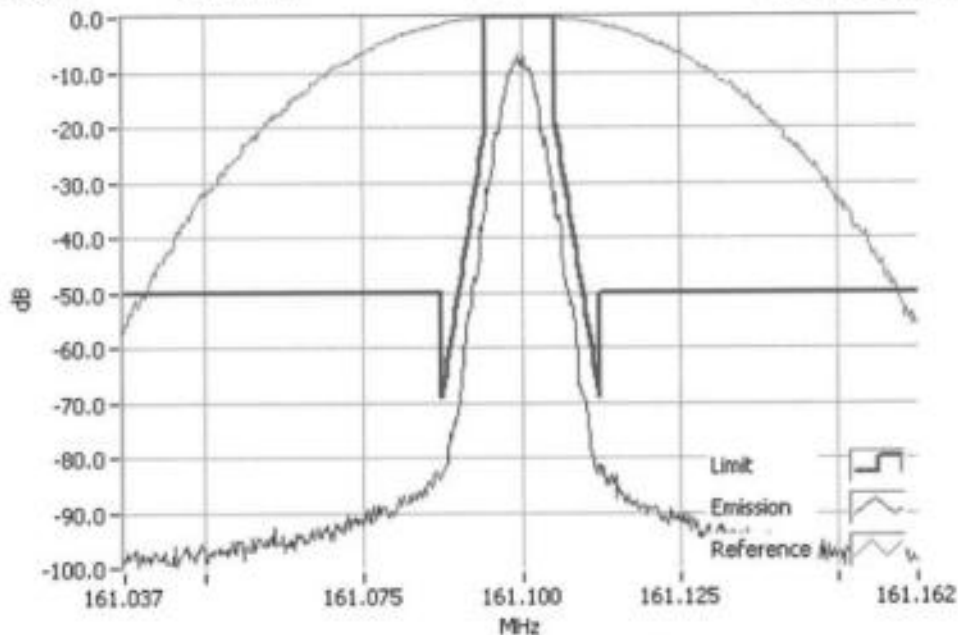

P25 Ph 1 161.1000MHz Mask D 1W
RBW=100Hz, VBW=1000Hz, Detector Mode=Peak
Result=Pass

Occupied Bandwidth and Spectrum Masks

APCO P25 phase-1

SPECIFICATION: FCC CFR 2.1049 (c) RSS-119 5.5

Tx FREQUENCY: 173.1 MHz 5 W 12.5 kHz Channel Spacing

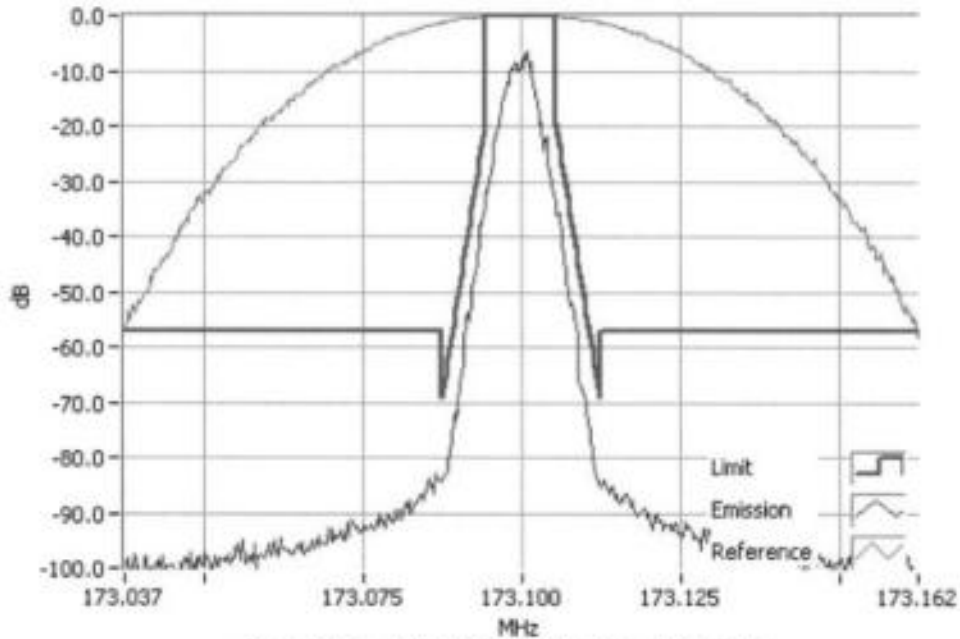

P25 Ph 1 173.1000MHz Mask D 5W
RBW=100Hz, VBW=1000Hz, Detector Mode=Peak
Result=Pass

Tx FREQUENCY: 173.1 MHz 1 W 12.5 kHz Channel Spacing

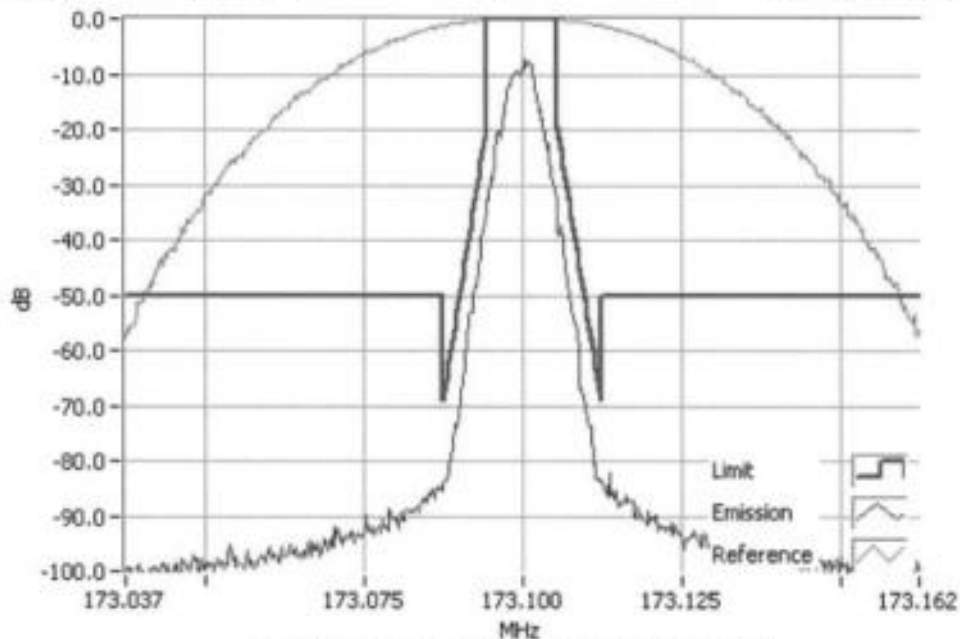

P25 Ph 1 173.1000MHz Mask D 1W
RBW=100Hz, VBW=1000Hz, Detector Mode=Peak
Result=Pass

Occupied Bandwidth and Spectrum Masks

APCO P25 phase-2

SPECIFICATION: FCC CFR 2.1049 (c) RSS-119 5.5

Tx FREQUENCY: 138.1 MHz 5 W 12.5 kHz Channel Spacing

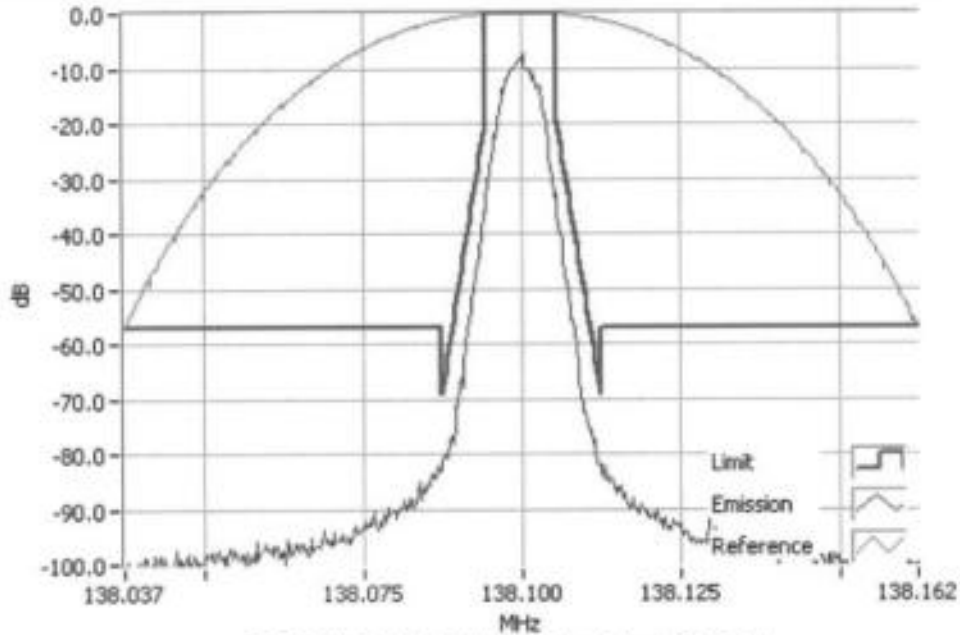

P25 Ph 2 138.1000MHz Mask D 5W
RBW=100Hz, VBW=1000Hz, Detector Mode=Peak
Result=Pass

Tx FREQUENCY: 138.1 MHz 1 W 12.5 kHz Channel Spacing

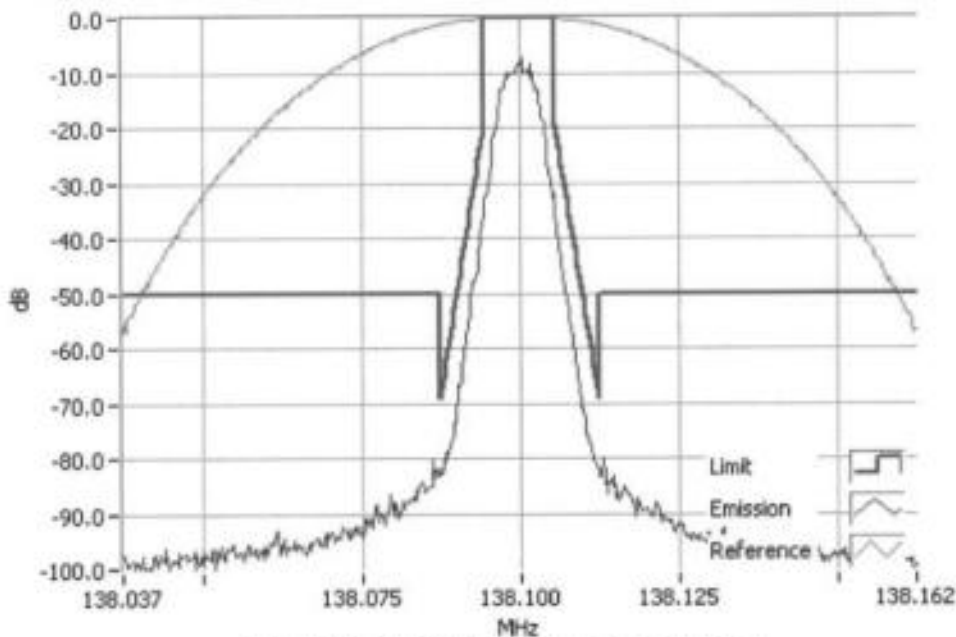

P25 Ph 2 138.1000MHz Mask D 1W
RBW=100Hz, VBW=1000Hz, Detector Mode=Peak
Result=Pass

Occupied Bandwidth and Spectrum Masks

APCO P25 phase-2

SPECIFICATION: FCC CFR 2.1049 (c) RSS-119 5.5

Tx FREQUENCY: 143.9 MHz 5 W 12.5 kHz Channel Spacing

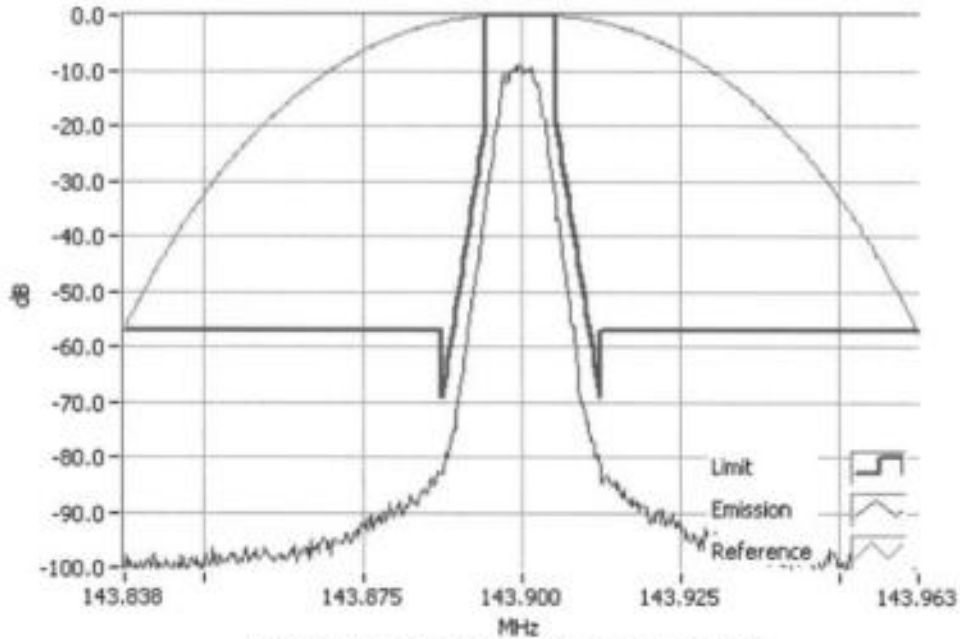

P25 Ph 2 143.9000MHz Mask D 5W
RBW=100Hz, VBW=1000Hz, Detector Mode=Peak
Result=Pass

Tx FREQUENCY: 143.9 MHz 1 W 12.5 kHz Channel Spacing

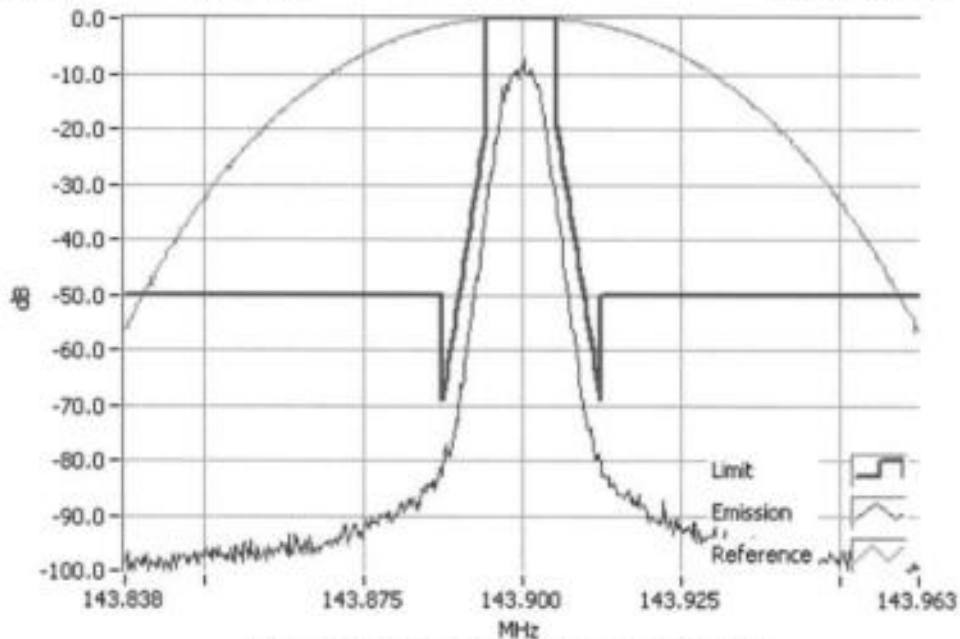

P25 Ph 2 143.9000MHz Mask D 1W
RBW=100Hz, VBW=1000Hz, Detector Mode=Peak
Result=Pass

Occupied Bandwidth and Spectrum Masks

APCO P25 phase-2

SPECIFICATION: FCC CFR 2.1049 (c) RSS-119 5.5

Tx FREQUENCY: 148.1 MHz 5 W 12.5 kHz Channel Spacing

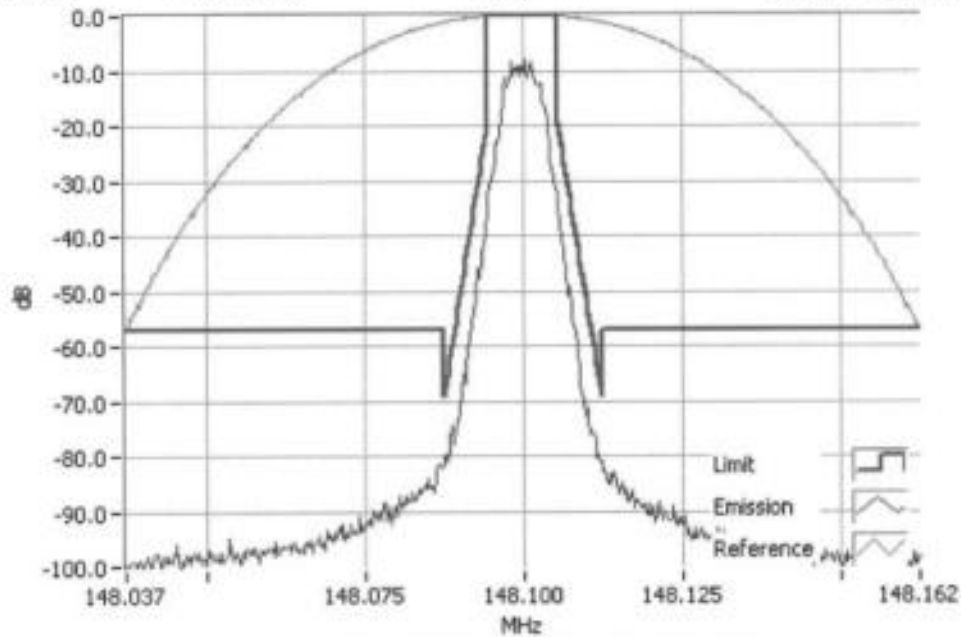

P25 Ph 2 148.1000MHz Mask D 5W
RBW=100Hz, VBW=1000Hz, Detector Mode=Peak
Result=Pass

Tx FREQUENCY: 148.1 MHz 1 W 12.5 kHz Channel Spacing

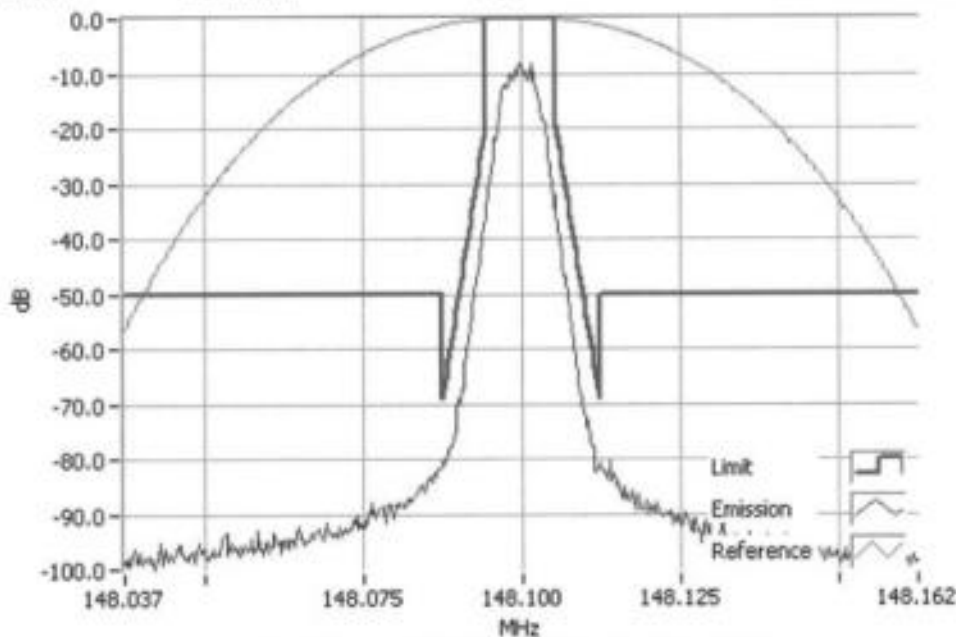

P25 Ph 2 148.1000MHz Mask D 1W
RBW=100Hz, VBW=1000Hz, Detector Mode=Peak
Result=Pass

Occupied Bandwidth and Spectrum Masks

APCO P25 phase-2

SPECIFICATION: FCC CFR 2.1049 (c) RSS-119 5.5

Tx FREQUENCY: 149.8 MHz 5 W 12.5 kHz Channel Spacing

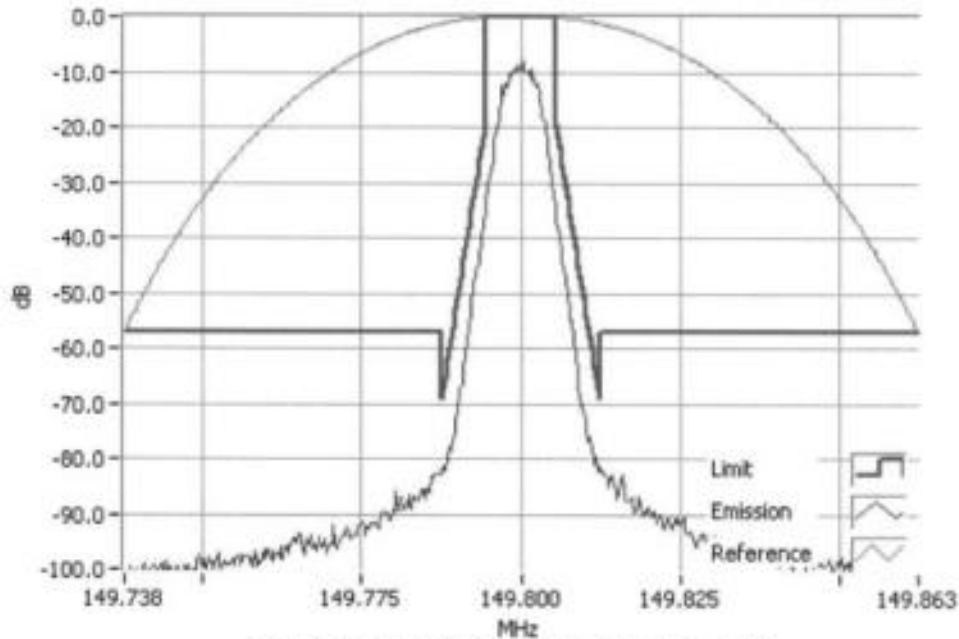

P25 Ph 2 149.8000MHz Mask D 5W
RBW=100Hz, VBW=1000Hz, Detector Mode=Peak
Result=Pass

Tx FREQUENCY: 149.8 MHz 1 W 12.5 kHz Channel Spacing

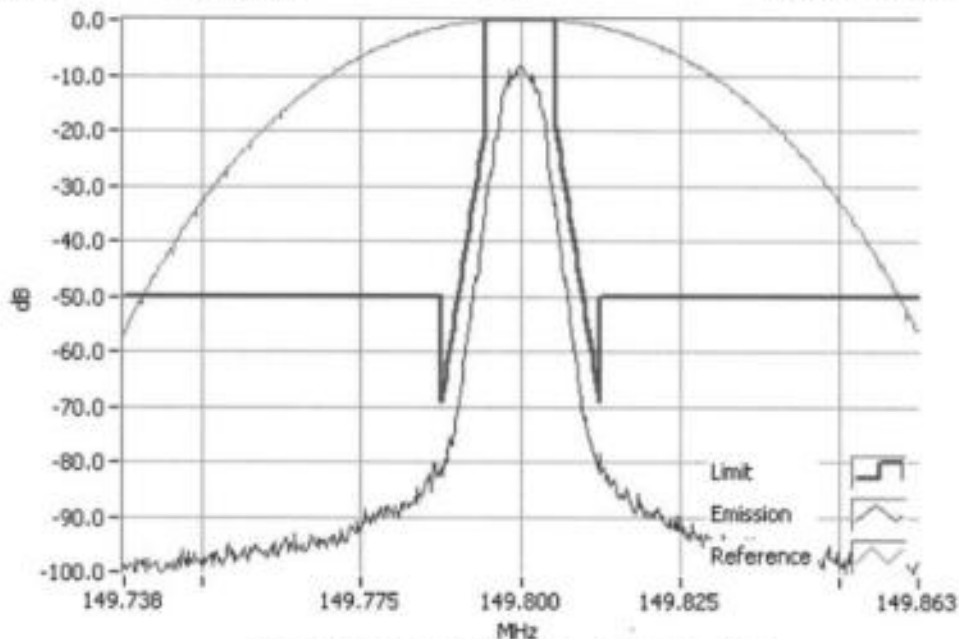

P25 Ph 2 149.8000MHz Mask D 1W
RBW=100Hz, VBW=1000Hz, Detector Mode=Peak
Result=Pass

Occupied Bandwidth and Spectrum Masks

APCO P25 phase-2

SPECIFICATION: FCC CFR 2.1049 (c) RSS-119 5.5

Tx FREQUENCY: 152.1 MHz 5 W 12.5 kHz Channel Spacing

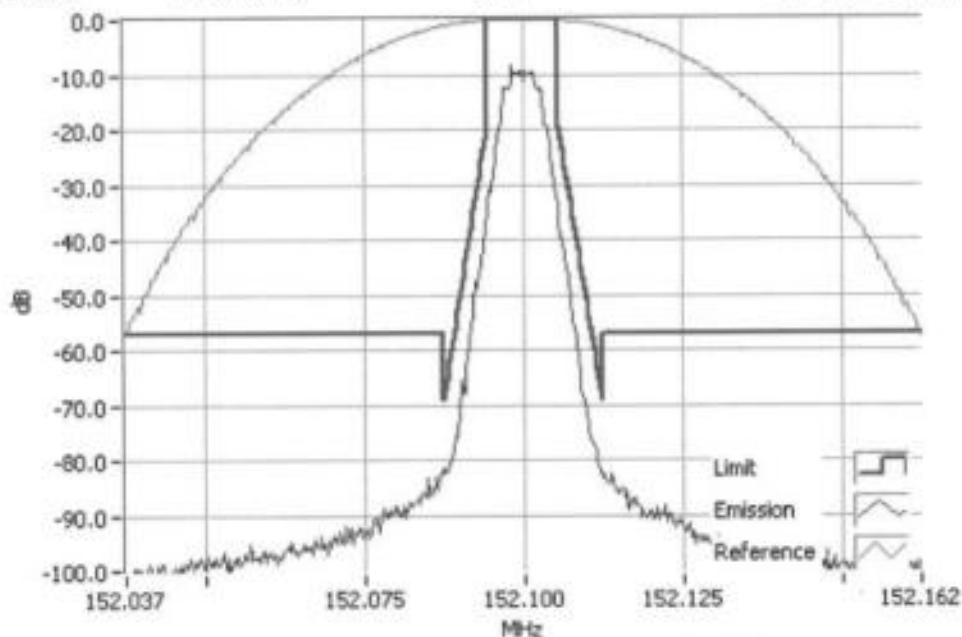

P25 Ph 2 152.1000MHz Mask D 5W
RBW=100Hz, VBW=1000Hz, Detector Mode=Peak
Result=Pass

Tx FREQUENCY: 152.1 MHz 1 W 12.5 kHz Channel Spacing

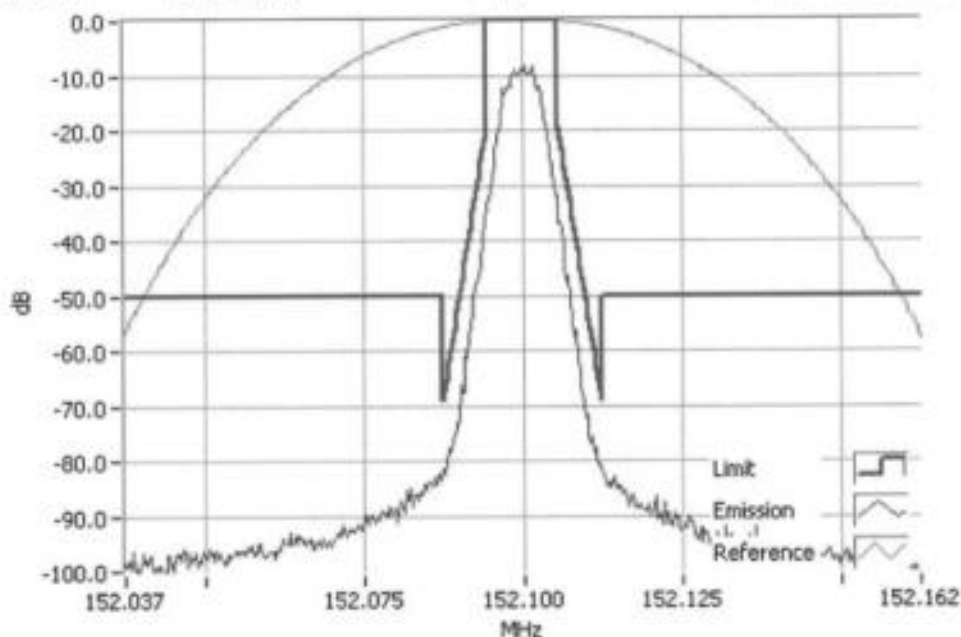

P25 Ph 2 152.1000MHz Mask D 1W
RBW=100Hz, VBW=1000Hz, Detector Mode=Peak
Result=Pass

Occupied Bandwidth and Spectrum Masks

APCO P25 phase-2

SPECIFICATION: FCC CFR 2.1049 (c) RSS-119 5.5

Tx FREQUENCY: 153.1 MHz 5 W 12.5 kHz Channel Spacing

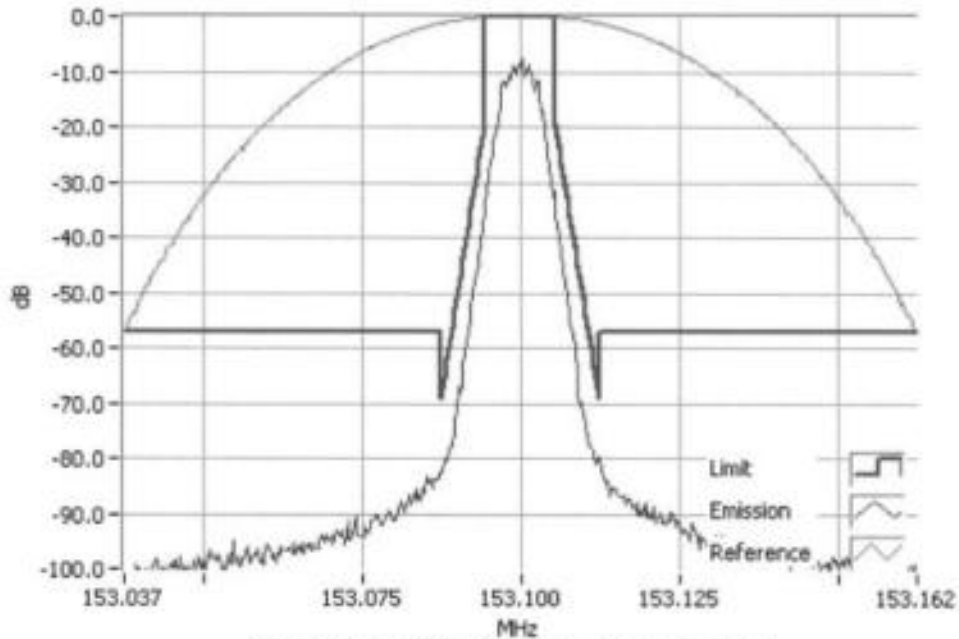

P25 Ph 2 153.1000MHz Mask D 5W
RBW=100Hz, VBW=1000Hz, Detector Mode=Peak
Result=Pass

Tx FREQUENCY: 153.1 MHz 1 W 12.5 kHz Channel Spacing

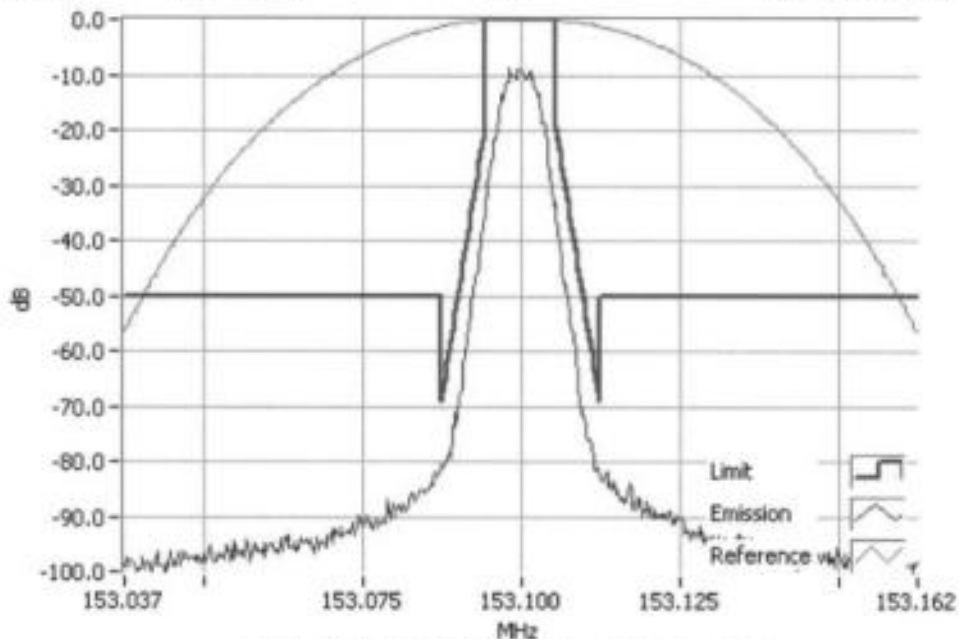

P25 Ph 2 153.1000MHz Mask D 1W
RBW=100Hz, VBW=1000Hz, Detector Mode=Peak
Result=Pass

Occupied Bandwidth and Spectrum Masks

APCO P25 phase-2

SPECIFICATION: FCC CFR 2.1049 (c) RSS-119 5.5

Tx FREQUENCY: 158.1 MHz 5 W 12.5 kHz Channel Spacing

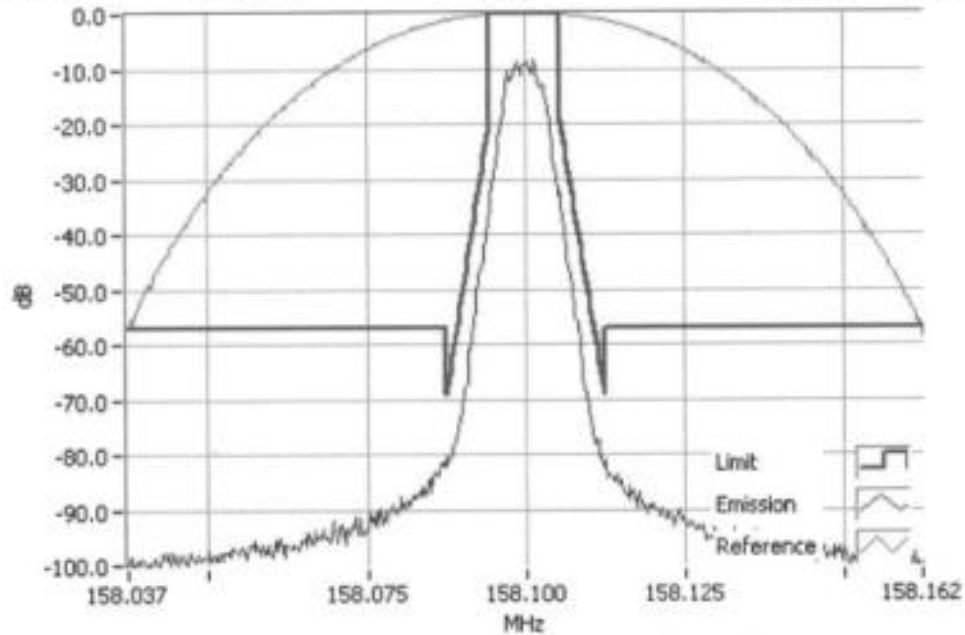

P25 Ph 2 158.1000MHz Mask D 5W
RBW=100Hz, VBW=1000Hz, Detector Mode=Peak
Result=Pass

Tx FREQUENCY: 158.1 MHz 1 W 12.5 kHz Channel Spacing

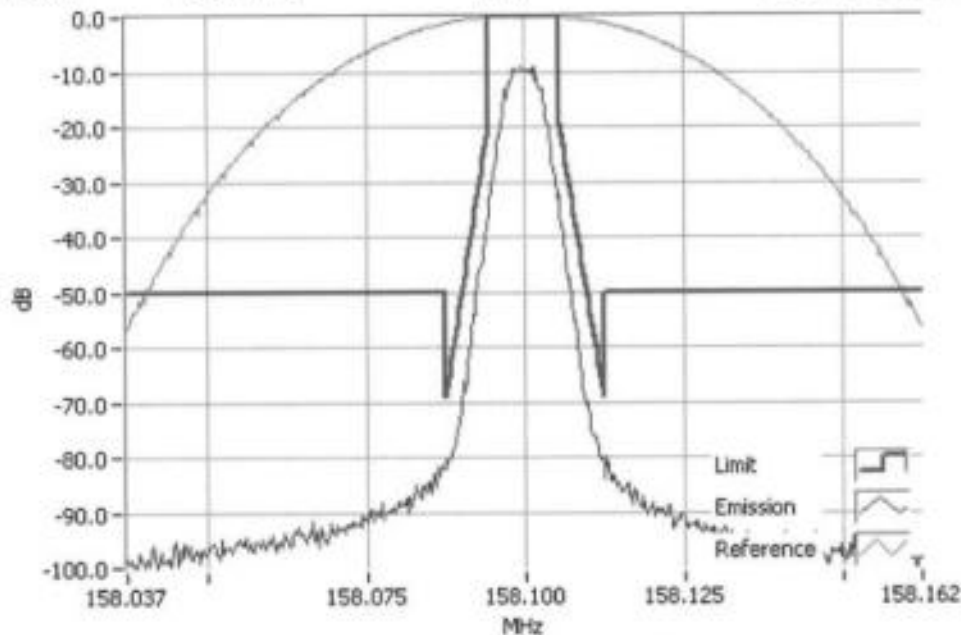

P25 Ph 2 158.1000MHz Mask D 1W
RBW=100Hz, VBW=1000Hz, Detector Mode=Peak
Result=Pass

Occupied Bandwidth and Spectrum Masks

APCO P25 phase-2

SPECIFICATION: FCC CFR 2.1049 (c) RSS-119 5.5

Tx FREQUENCY: 161.1 MHz 5 W 12.5 kHz Channel Spacing

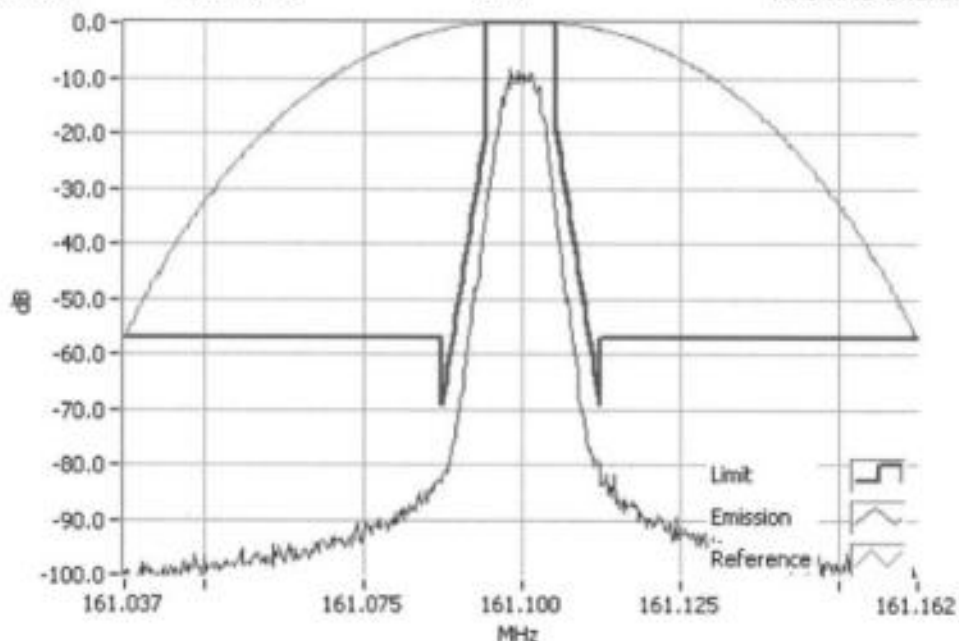

P25 Ph 2 161.1000MHz Mask D 5W
RBW=100Hz, VBW=1000Hz, Detector Mode=Peak
Result=Pass

Tx FREQUENCY: 161.1 MHz 1 W 12.5 kHz Channel Spacing

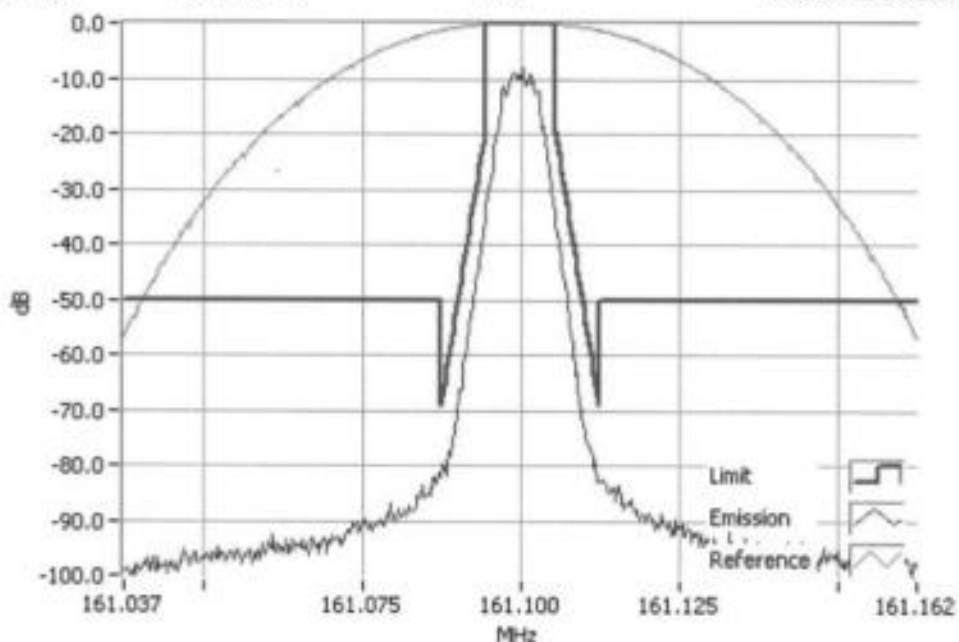

P25 Ph 2 161.1000MHz Mask D 1W
RBW=100Hz, VBW=1000Hz, Detector Mode=Peak
Result=Pass

Occupied Bandwidth and Spectrum Masks

APCO P25 phase-2

SPECIFICATION: FCC CFR 2.1049 (c) RSS-119 5.5

Tx FREQUENCY: 173.1 MHz 5 W 12.5 kHz Channel Spacing

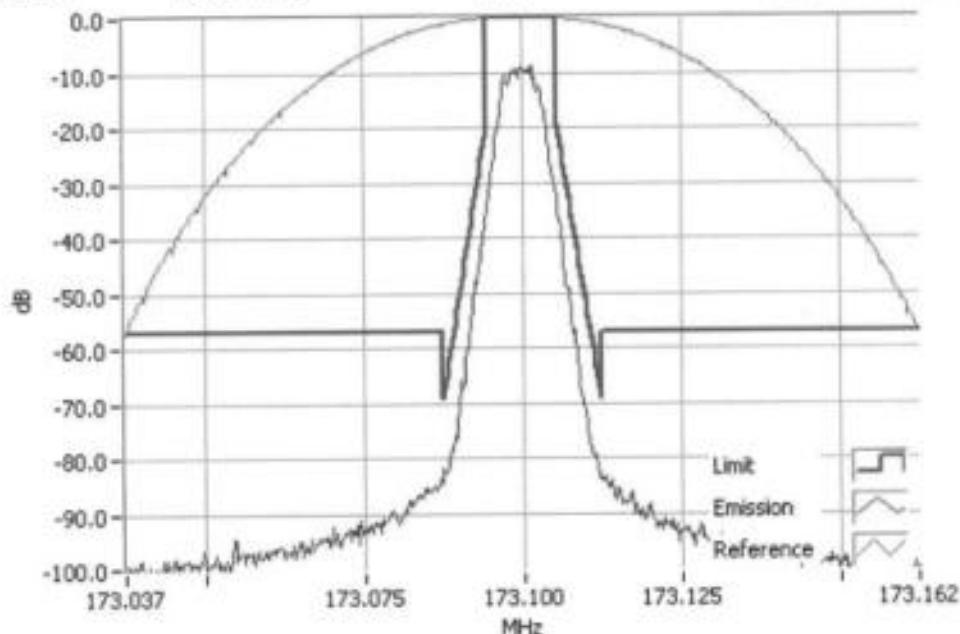

P25 Ph 2 173.1000MHz Mask D 5W
RBW=100Hz, VBW=1000Hz, Detector Mode=Peak
Result=Pass

Tx FREQUENCY: 173.1 MHz 1 W 12.5 kHz Channel Spacing

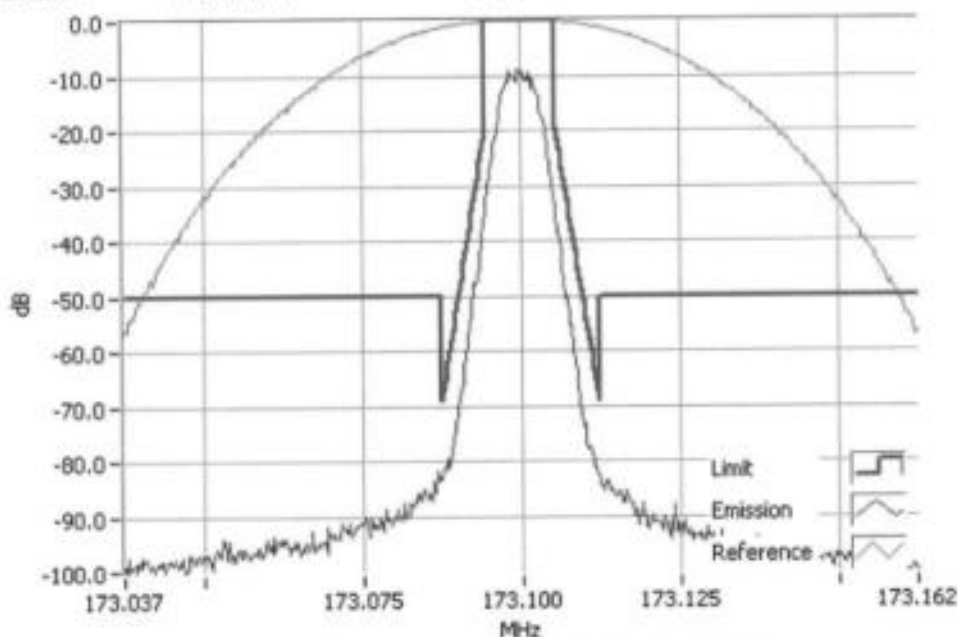

P25 Ph 2 173.1000MHz Mask D 1W
RBW=100Hz, VBW=1000Hz, Detector Mode=Peak
Result=Pass

TRANSMITTER SPURIOUS EMISSIONS (CONDUCTED)

SPECIFICATIONS: FCC 47 CFR 2.1051

RSS-119 5.8

GUIDE: TIA/EIA-603D 2.2.13

MEASUREMENT PROCEDURE:

1. Refer Annex A for equipment set up.
2. The frequency range examined was from the lowest frequency generated within the EUT, to a frequency higher than the 10th Harmonic: 100 kHz to Fc-BW
Fc+ BW to 10Fc GHz
3. A Pre-scan is performed with a resolution bandwidth of 1 kHz, and a video bandwidth of 3 kHz. If any emissions are found to be within 20 dB of the limit a second measurement is made with the carrier modulated, and a resolution bandwidth of 10 kHz, and a video bandwidth of 30 kHz.

Spurious emissions which were attenuated by more than 20 dB below the limit were not recorded.

A photograph of the test set-up is included below.

MEASUREMENT RESULTS:

See the tables and plots on the following pages for 12.5 kHz channel spacing.

LIMIT CLAUSES: FCC 47 CFR 90.210

RSS-119 5.8

Photo: Conducted Emissions Test Setup



Spurious Emissions (Tx Conducted)

SPECIFICATION: FCC CFR 2.1051

RSS-119 5.8

12.5 kHz Channel Spacing 138.1 MHz @ 5 W Emission Mask D

Emission Frequency (MHz)	Level (dBm)	Level (dBc)
-	-	-

12.5 kHz Channel Spacing 138.1 MHz @ 1 W Emission Mask D

Emission Frequency (MHz)	Level (dBm)	Level (dBc)
-	-	-
Measurement Uncertainty:	≤2.75 GHz ± 3.0 dB	
No emissions were detected at a level greater than 20 dB below the limit.		

TELTEST Laboratories
Tait Ltd
Report Number 3865



Spurious Emissions (Tx Conducted)

SPECIFICATION: FCC CFR 2.1051

RSS-119 5.8

12.5 kHz Channel Spacing 143.9 MHz @ 5 W Emission Mask D

Emission Frequency (MHz)	Level (dBm)	Level (dBc)
-	-	-

12.5 kHz Channel Spacing 143.9 MHz @ 1 W Emission Mask D

Emission Frequency (MHz)	Level (dBm)	Level (dBc)
-	-	-
Measurement Uncertainty:	≤2.75 GHz ± 3.0 dB	
No emissions were detected at a level greater than 20 dB below the limit.		

TELTEST Laboratories
Tait Ltd
Report Number 3865



Spurious Emissions (Tx Conducted)

SPECIFICATION: FCC CFR 2.1051

RSS-119 5.8

12.5 kHz Channel Spacing

148.1 MHz @ 5 W

Emission Mask D

Emission Frequency (MHz)	Level (dBm)	Level (dBc)
-	-	-

12.5 kHz Channel Spacing

148.1 MHz @ 1 W

Emission Mask D

Emission Frequency (MHz)	Level (dBm)	Level (dBc)
-	-	-
Measurement Uncertainty:	≤ 2.75 GHz ± 3.0 dB	
No emissions were detected at a level greater than 20 dB below the limit.		

TELTEST Laboratories
Tait Ltd
Report Number 3865



Spurious Emissions (Tx Conducted)

SPECIFICATION: FCC CFR 2.1051

RSS-119 5.8

12.5 kHz Channel Spacing 149.8 MHz @ 5 W Emission Mask D

Emission Frequency (MHz)	Level (dBm)	Level (dBc)
-	-	-

12.5 kHz Channel Spacing 149.8 MHz @ 1 W Emission Mask D

Emission Frequency (MHz)	Level (dBm)	Level (dBc)
-	-	-
Measurement Uncertainty:	≤2.75 GHz ± 3.0 dB	
No emissions were detected at a level greater than 20 dB below the limit.		

TELTEST Laboratories
 Tait Ltd
 Report Number 3865

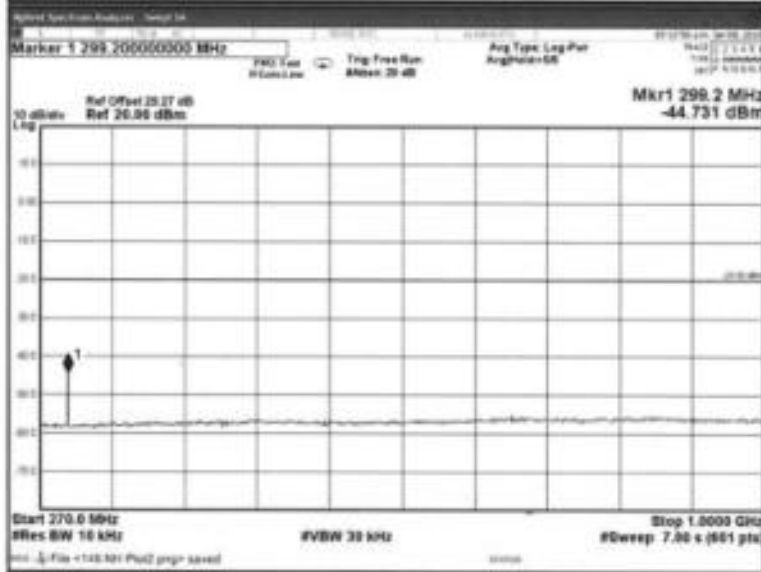

Spurious Emissions (Tx Conducted)

SPECIFICATION: FCC CFR 2.1051

RSS-119 5.8

12.5 kHz Channel Spacing

152.1 MHz @ 5 W

Emission Mask D

Emission Frequency (MHz)	Level (dBm)	Level (dBc)
-	-	-

12.5 kHz Channel Spacing

152.1 MHz @ 1 W

Emission Mask D

Emission Frequency (MHz)	Level (dBm)	Level (dBc)
-	-	-
Measurement Uncertainty:	±2.75 GHz ± 3.0 dB	
No emissions were detected at a level greater than 20 dB below the limit.		

TELTEST Laboratories
Tait Ltd
Report Number 3865



Spurious Emissions (Tx Conducted)

SPECIFICATION: FCC CFR 2.1051

RSS-119 5.8

12.5 kHz Channel Spacing

153.1 MHz @ 5 W

Emission Mask D

Emission Frequency (MHz)	Level (dBm)	Level (dBc)
-	-	-

12.5 kHz Channel Spacing

153.1 MHz @ 1 W

Emission Mask D

Emission Frequency (MHz)	Level (dBm)	Level (dBc)
-	-	-

Measurement Uncertainty: ≤ 2.75 GHz ± 3.0 dB

No emissions were detected at a level greater than 20 dB below the limit.

TELTEST Laboratories
Tait Ltd
Report Number 3865

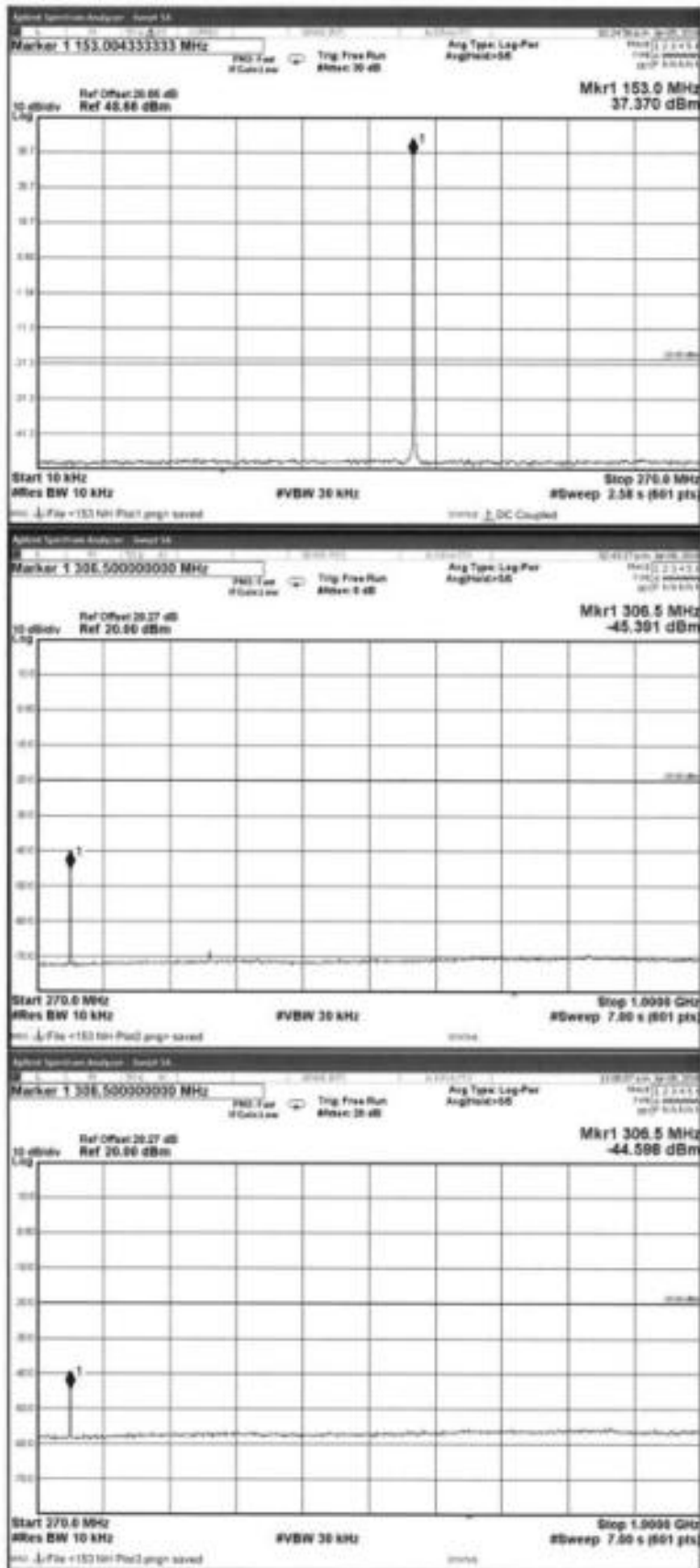

Spurious Emissions (Tx Conducted)

SPECIFICATION: FCC CFR 2.1051

RSS-119 5.8

12.5 kHz Channel Spacing

158.1 MHz @ 5 W

Emission Mask D

Emission Frequency (MHz)	Level (dBm)	Level (dBc)
-	-	-

12.5 kHz Channel Spacing

158.1 MHz @ 1 W

Emission Mask D

Emission Frequency (MHz)	Level (dBm)	Level (dBc)
-	-	-
Measurement Uncertainty:	≤ 2.75 GHz ± 3.0 dB	
No emissions were detected at a level greater than 20 dB below the limit.		

TELTEST Laboratories
Tait Ltd
Report Number 3865



Spurious Emissions (Tx Conducted)

SPECIFICATION: FCC CFR 2.1051

RSS-119 5.8

12.5 kHz Channel Spacing

161.1 MHz @ 5 W

Emission Mask D

Emission Frequency (MHz)	Level (dBm)	Level (dBc)
-	-	-

12.5 kHz Channel Spacing

161.1 MHz @ 1 W

Emission Mask D

Emission Frequency (MHz)	Level (dBm)	Level (dBc)
-	-	-
Measurement Uncertainty:	≤ 2.75 GHz ± 3.0 dB	
No emissions were detected at a level greater than 20 dB below the limit.		

TELTEST Laboratories
Tait Ltd
Report Number 3865



Spurious Emissions (Tx Conducted)

SPECIFICATION: FCC CFR 2.1051

RSS-119 5.8

12.5 kHz Channel Spacing 173.1 MHz @ 5 W Emission Mask D

Emission Frequency (MHz)	Level (dBm)	Level (dBc)
-	-	-

12.5 kHz Channel Spacing 173.1 MHz @ 1 W Emission Mask D

Emission Frequency (MHz)	Level (dBm)	Level (dBc)
-	-	-
Measurement Uncertainty:	±2.75 GHz ± 3.0 dB	
No emissions were detected at a level greater than 20 dB below the limit.		

TELTEST Laboratories
Tait Ltd
Report Number 3865



Spurious Emissions (Tx Conducted)

SPECIFICATION: FCC CFR 2.1051 RSS-119 5.8
LIMITS: FCC 47 CFR 90.210 RSS-119 5.8

Carrier Output Power	Emission Mask D 12.5 kHz Channel Spacing $50 + 10 \text{ Log}_{10}(P_{Wmax})$	
	5 W	-20 dBm
1 W	-20 dBm	-50 dBc

TRANSMITTER SPURIOUS EMISSIONS (RADIATED)

SPECIFICATION: FCC 47 CFR 2.1053

GUIDE: TIA/EIA-603D 2.2.12

MEASUREMENT PROCEDURE:

Initial Scan:

1. The EUT is placed in the S-Line TEM cell and emissions are measured from 30 MHz to 800 MHz. Any emission within 20 dB of the limit is then re-tested on the OATS.
2. The EUT is placed in the reverberation chamber and emissions are measured from 800 MHz to the upper frequency required. Any emission within 20 dB of the limit is then re-tested on the OATS.
3. The harmonics emissions up to the 6th harmonic of the fundamental frequency are measured on the OATS

OATS Measurement:

1. The EUT is placed on a wooden turntable at a distance of three metres from the test antenna. The output terminal is connected to an RF dummy load.
2. The test antenna is raised from 1 m to 4 m to obtain a maximum reading; the turntable is then rotated through 360° to obtain the maximum response of each spurious emission. Valid emissions are determined by switching the EUT on and off.
3. The EUT is then replaced by a signal generator and substitution antenna to make measurements by the substitution method.

MEASUREMENT RESULTS:

See the tables on the following pages

LIMIT CLAUSE: FCC 47 CFR 90.210

Spurious Emissions (Tx Radiated) - Continued

SPECIFICATION: FCC CFR 2.1053

12.5 kHz Channel Spacing 138.1 MHz @ 5 W Emission Mask D

Emission Frequency (MHz)	Level (dBm)	Level (dBc)
-	-	-

12.5 kHz Channel Spacing 138.1 MHz @ 1 W Emission Mask D

Emission Frequency (MHz)	Level (dBm)	Level (dBc)
-	-	-
Measurement Uncertainty	± 4.6 dB	
No emissions were detected at a level greater than 20 dB below the limit.		

12.5 kHz Channel Spacing 143.9 MHz @ 5 W Emission Mask D

Emission Frequency (MHz)	Level (dBm)	Level (dBc)
-	-	-

12.5 kHz Channel Spacing 143.9 MHz @ 1 W Emission Mask D

Emission Frequency (MHz)	Level (dBm)	Level (dBc)
-	-	-
Measurement Uncertainty	± 4.6 dB	
No emissions were detected at a level greater than 20 dB below the limit.		

12.5 kHz Channel Spacing 148.1 MHz @ 5 W Emission Mask D

Emission Frequency (MHz)	Level (dBm)	Level (dBc)
-	-	-

12.5 kHz Channel Spacing 148.1 MHz @ 1 W Emission Mask D

Emission Frequency (MHz)	Level (dBm)	Level (dBc)
-	-	-
Measurement Uncertainty	± 4.6 dB	
No emissions were detected at a level greater than 20 dB below the limit.		

Spurious Emissions (Tx Radiated) - Continued

12.5 kHz Channel Spacing 149.8 MHz @ 5 W Emission Mask D

Emission Frequency (MHz)	Level (dBm)	Level (dBc)
-	-	-

12.5 kHz Channel Spacing 149.8 MHz @ 1 W Emission Mask D

Emission Frequency (MHz)	Level (dBm)	Level (dBc)
-	-	-
Measurement Uncertainty	± 4.6 dB	
No emissions were detected at a level greater than 20 dB below the limit.		

12.5 kHz Channel Spacing 152.1 MHz @ 5 W Emission Mask D

Emission Frequency (MHz)	Level (dBm)	Level (dBc)
-	-	-

12.5 kHz Channel Spacing 152.1 MHz @ 1 W Emission Mask D

Emission Frequency (MHz)	Level (dBm)	Level (dBc)
-	-	-
Measurement Uncertainty	± 4.6 dB	
No emissions were detected at a level greater than 20 dB below the limit.		

12.5 kHz Channel Spacing 153.1 MHz @ 5 W Emission Mask D

Emission Frequency (MHz)	Level (dBm)	Level (dBc)
-	-	-

12.5 kHz Channel Spacing 153.1 MHz @ 1 W Emission Mask D

Emission Frequency (MHz)	Level (dBm)	Level (dBc)
-	-	-
Measurement Uncertainty	± 4.6 dB	
No emissions were detected at a level greater than 20 dB below the limit.		

Spurious Emissions (Tx Radiated) - Continued

12.5 kHz Channel Spacing 158.1 MHz @ 5 W Emission Mask D

Emission Frequency (MHz)	Level (dBm)	Level (dBc)
-	-	-

12.5 kHz Channel Spacing 158.1 MHz @ 1 W Emission Mask D

Emission Frequency (MHz)	Level (dBm)	Level (dBc)
-	-	-
Measurement Uncertainty	± 4.6 dB	
No emissions were detected at a level greater than 20 dB below the limit.		

12.5 kHz Channel Spacing 161.1 MHz @ 5 W Emission Mask D

Emission Frequency (MHz)	Level (dBm)	Level (dBc)
-	-	-

12.5 kHz Channel Spacing 161.1 MHz @ 1 W Emission Mask D

Emission Frequency (MHz)	Level (dBm)	Level (dBc)
-	-	-
Measurement Uncertainty	± 4.6 dB	
No emissions were detected at a level greater than 20 dB below the limit.		

12.5 kHz Channel Spacing 173.1 MHz @ 5 W Emission Mask D

Emission Frequency (MHz)	Level (dBm)	Level (dBc)
-	-	-

12.5 kHz Channel Spacing 173.1 MHz @ 1 W Emission Mask D

Emission Frequency (MHz)	Level (dBm)	Level (dBc)
-	-	-
Measurement Uncertainty	± 4.6 dB	
No emissions were detected at a level greater than 20 dB below the limit.		

Spurious Emissions (Tx Radiated) - Continued

LIMITS: FCC CFR 2.1053

Carrier Output Power	Emission Mask D 12.5 kHz Channel Spacing $50 + 10 \log_{10}(P_{\text{Watts}})$	
5 W	-20 dBm	-57.0 dBc
1 W	-20 dBm	-50 dBc

Open Area Test Site Results:

12.5 kHz Channel Spacing 138.1 MHz @ 5 W Emission Mask D

Harmonics Emission Frequency (MHz)	Level (dBm)	Level (dBc)
276.200000	-82.71	-119.71
414.300000	-54.12	-91.12
552.400000	-73.53	-110.53
690.500000	-75.15	-112.15
828.600000	-82.59	-119.59
966.700000	-77.65	-114.65
Measurement Uncertainty	± 4.6 dB	

SAMPLE CALCULATION:

Emission Frequency (MHz)	Measurement					Result	
	Reference	Substitution				dBm	nW
Reference Level (dBm)	Sig-gen Level	Cable and Attenuat or Gain	Antenna Gain (dBd)	Path and Boresight corrections			
414.000000	-81.80	-39.69	-14.27	-0.35	0.19	-54.12	3.8
		A	B	C	D	E	

Result (E) = A+B+C+D

Photo: OATS Setup



TRANSIENT FREQUENCY BEHAVIOR

SPECIFICATION: FCC 47 CFR 90.214 RSS-119 5.9

GUIDE: TIA/EIA-603D 2.2.19

MEASUREMENT PROCEDURE:

1. Refer Annex A for equipment set up.
2. Measurements and plots were made following the TIA/EIA procedure.

MEASUREMENT RESULTS:

See the tables and plots on the following pages for 12.5 kHz channel spacing.

LIMIT CLAUSES: FCC 47 CFR 90.214 RSS-119 5.9

Transient Frequency Behaviour

SPECIFICATION: FCC 47 CFR 90.214

RSS-119 5.9

Tx FREQUENCY: 138.1 MHz 5 W

12.5 kHz Channel Spacing

138.1 MHz @ 5 W Tx

TRANSIENT RESPONSE PERIOD	CARRIER PEAK VARIATION FROM NORMAL	
	Key ON (kHz)	Key OFF (kHz)
t1	-1.3	N/A
t2	-1.1	N/A
t3	N/A	-0.3

Confirm that during periods t1 and t3 the frequency difference does not exceed the value of one channel separation.	YES	NO
	✓	<input type="checkbox"/>
Confirm that during the period t2 the frequency difference does not exceed half a channel separation.	YES	NO
	✓	<input type="checkbox"/>
Confirm that during the period t2 to t3 the frequency difference does not exceed the frequency error limit.	YES	NO
	✓	<input type="checkbox"/>

Measurement Uncertainty: Frequency \pm 130 Hz; Time \pm 0.2%

LIMIT: FCC 47 CFR 90.214

TRANSIENT PERIODS	FREQUENCY RANGE	
	150 MHz – 174 MHz	421 MHz – 512 MHz
t1 (ms)	5 ms	10 ms
t2 (ms)	20 ms	25 ms
t3 (ms)	5 ms	10 ms

LIMIT: RSS-119 5.9

Transient Frequency Behaviour for Equipment Designed to Operate on 12.5 kHz Channels			
TRANSIENT PERIODS	Maximum Frequency Difference	FREQUENCY RANGE	
		138 – 174 MHz	406.1 – 470 MHz
t1 (ms)	\pm 12.5 kHz	5 ms	10 ms
t2 (ms)	\pm 6.25 kHz	20 ms	25 ms
t3 (ms)	\pm 12.5 kHz	5 ms	10 ms

Note: RSS-119 5.9 - If the transmitter carrier output power rating is 6 Watts or less, the frequency difference during the time periods t1 and t3 may exceed the maximum frequency difference for these time periods.

Transient Frequency Behaviour

SPECIFICATION: FCC 47 CFR 90.214

RSS-119 5.9

TX FREQUENCY: 138.1 MHz

5 W

12.5 kHz Channel Spacing

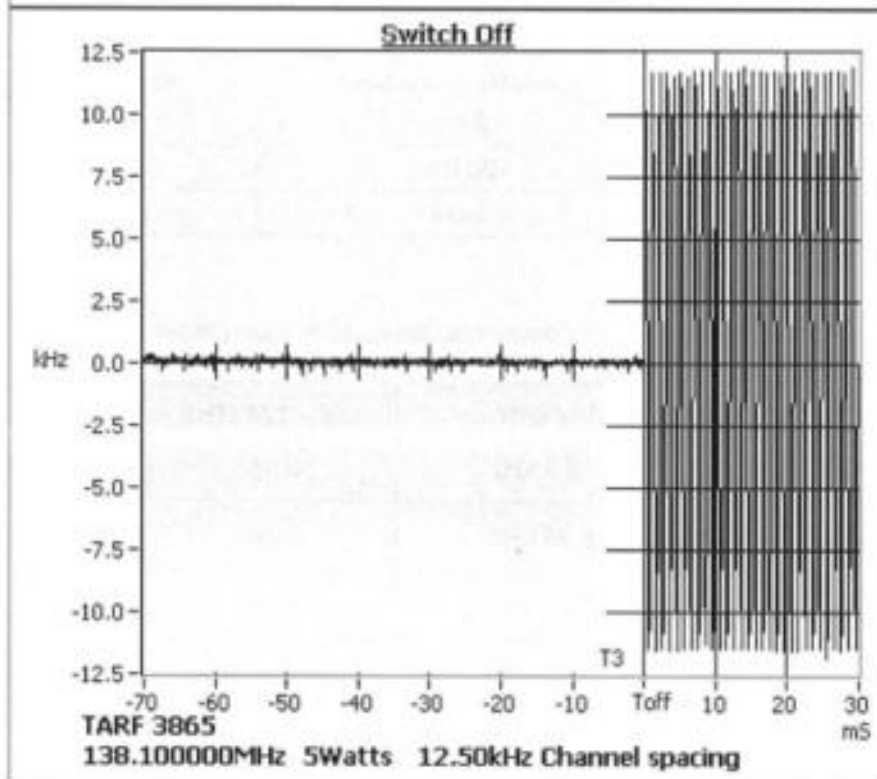
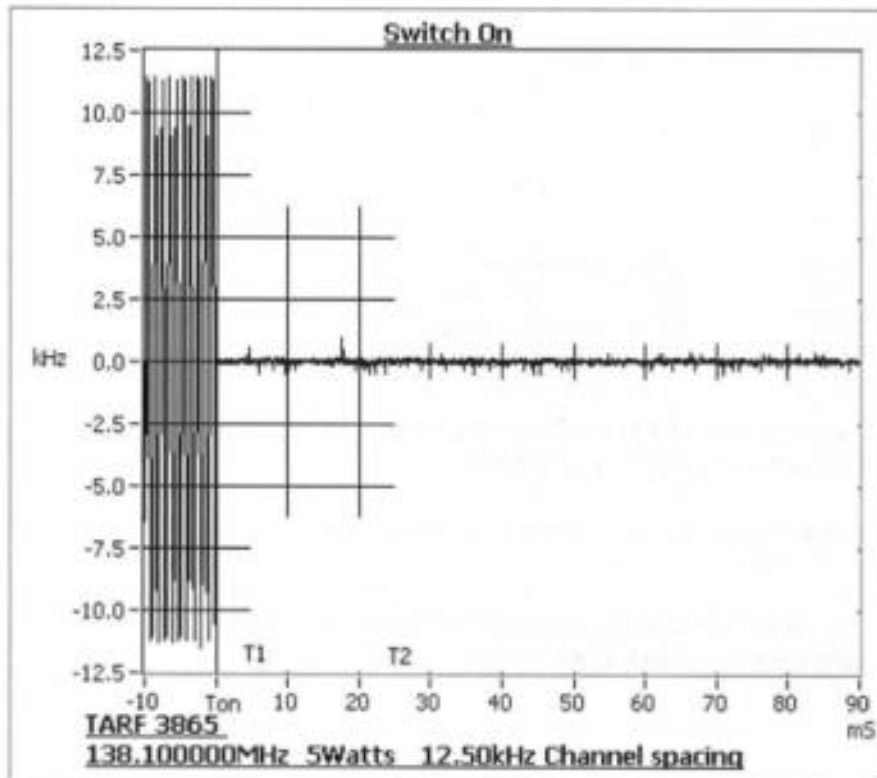

Transient Frequency Behaviour

SPECIFICATION: FCC 47 CFR 90.214

TXH FREQUENCY: 143.9 MHz 5 W 12.5 kHz Channel Spacing

143.9 MHz @ 5 W Tx

TRANSIENT RESPONSE PERIOD	CARRIER PEAK VARIATION FROM NORMAL	
	Key ON (kHz)	Key OFF (kHz)
t1	-1.3	N/A
t2	-0.5	N/A
t3	N/A	-0.3

Confirm that during periods t1 and t3 the frequency difference does not exceed the value of one channel separation.	YES	NO
	✓	<input type="checkbox"/>
Confirm that during the period t2 the frequency difference does not exceed half a channel separation.	YES	NO
	✓	<input type="checkbox"/>
Confirm that during the period t2 to t3 the frequency difference does not exceed the frequency error limit.	YES	NO
	✓	<input type="checkbox"/>

Measurement Uncertainty: Frequency \pm 130 Hz; Time \pm 0.2%

LIMIT: FCC 47 CFR 90.214

TRANSIENT PERIODS	FREQUENCY RANGE	
	150 MHz – 174 MHz	421 MHz – 512 MHz
t1 (ms)	5 ms	10 ms
t2 (ms)	20 ms	25 ms
t3 (ms)	5 ms	10 ms

LIMIT: RSS-119 5.9

Transient Frequency Behaviour for Equipment Designed to Operate on 12.5 kHz Channels			
TRANSIENT PERIODS	Maximum Frequency Difference	FREQUENCY RANGE	
		138 – 174 MHz	406.1 – 470 MHz
t1 (ms)	\pm 12.5 kHz	5 ms	10 ms
t2 (ms)	\pm 6.25 kHz	20 ms	25 ms
t3 (ms)	\pm 12.5 kHz	5 ms	10 ms

Note: RSS-119 5.9 - If the transmitter carrier output power rating is 6 Watts or less, the frequency difference during the time periods t1 and t3 may exceed the maximum frequency difference for these time periods,

Transient Frequency Behavior

SPECIFICATION: FCC 47 CFR 90.214

Tx FREQUENCY: 143.9 MHz 5 W 12.5 kHz Channel Spacing

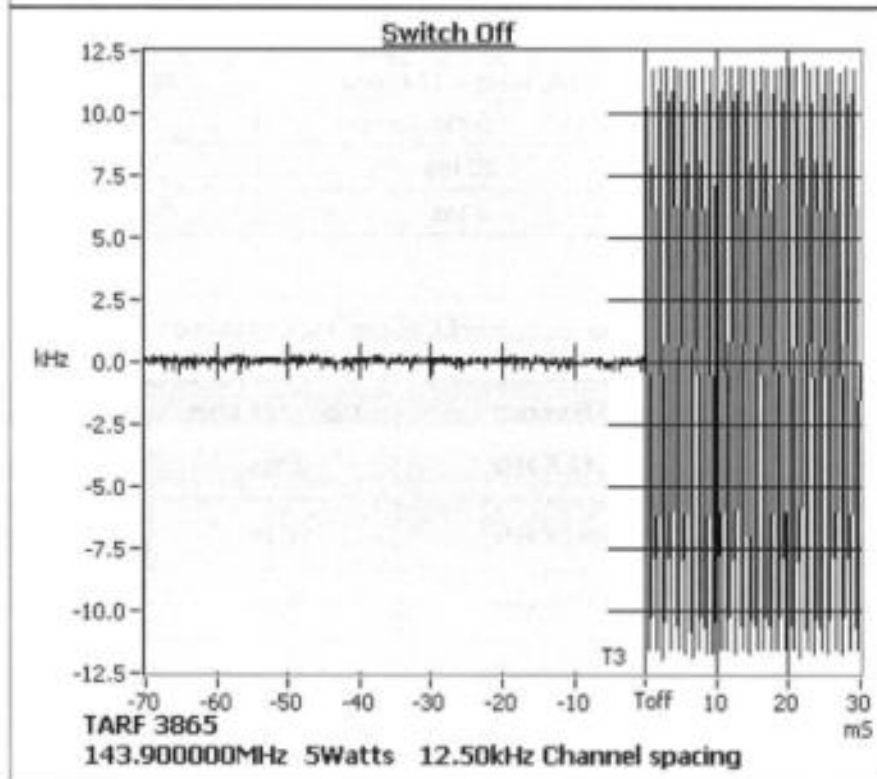
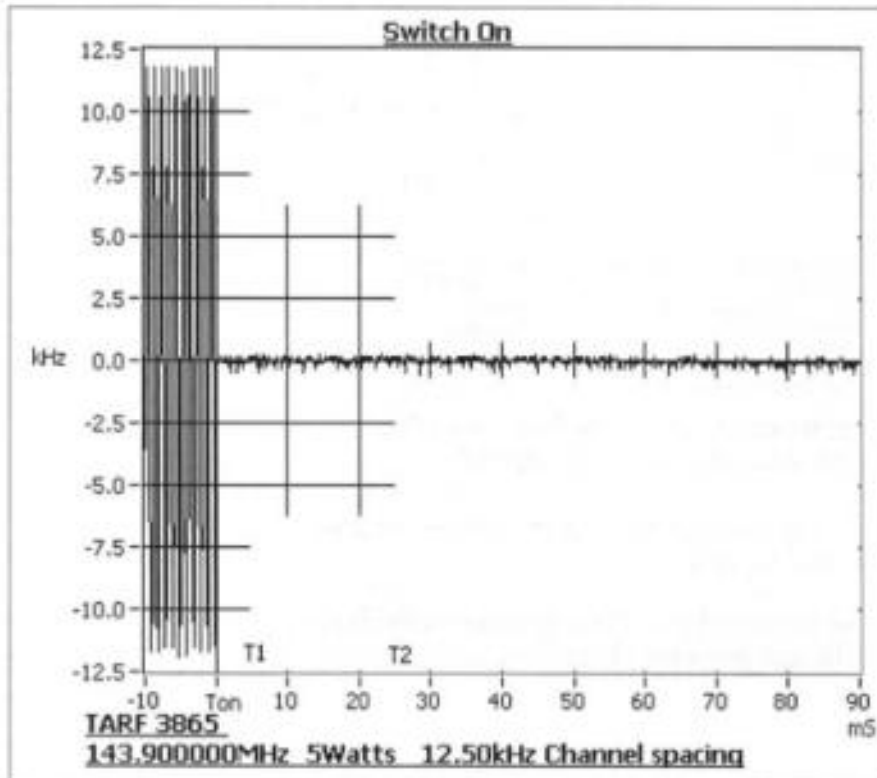

Transient Frequency Behaviour

SPECIFICATION: FCC 47 CFR 90.214

RSS-119 5.9

Tx FREQUENCY: 148.1 MHz 5 W

12.5 kHz Channel Spacing

148.1 MHz @ 5 W Tx

TRANSIENT RESPONSE PERIOD	CARRIER PEAK VARIATION FROM NORMAL	
	Key ON (kHz)	Key OFF (kHz)
t1	0.6	N/A
t2	-0.4	N/A
t3	N/A	-0.4

Confirm that during periods t1 and t3 the frequency difference does not exceed the value of one channel separation.	YES	NO
	✓	<input type="checkbox"/>
Confirm that during the period t2 the frequency difference does not exceed half a channel separation.	YES	NO
	✓	<input type="checkbox"/>
Confirm that during the period t2 to t3 the frequency difference does not exceed the frequency error limit.	YES	NO
	✓	<input type="checkbox"/>

Measurement Uncertainty: Frequency \pm 130 Hz; Time \pm 0.2%

LIMIT: FCC 47 CFR 90.214

TRANSIENT PERIODS	FREQUENCY RANGE	
	150 MHz – 174 MHz	421 MHz – 512 MHz
t1 (ms)	5 ms	10 ms
t2 (ms)	20 ms	25 ms
t3 (ms)	5 ms	10 ms

LIMIT: RSS-119 5.9

Transient Frequency Behaviour for Equipment Designed to Operate on 12.5 kHz Channels			
TRANSIENT PERIODS	Maximum Frequency Difference	FREQUENCY RANGE	
		138 – 174 MHz	406.1 – 470 MHz
t1 (ms)	\pm 12.5 kHz	5 ms	10 ms
t2 (ms)	\pm 6.25 kHz	20 ms	25 ms
t3 (ms)	\pm 12.5 kHz	5 ms	10 ms

Note: RSS-119 5.9 - If the transmitter carrier output power rating is 6 Watts or less, the frequency difference during the time periods t1 and t3 may exceed the maximum frequency difference for these time periods.

Transient Frequency Behaviour

SPECIFICATION: FCC 47 CFR 90.214

RSS-119 5.9

Tx FREQUENCY: 148.1 MHz

5 W

12.5 kHz Channel Spacing

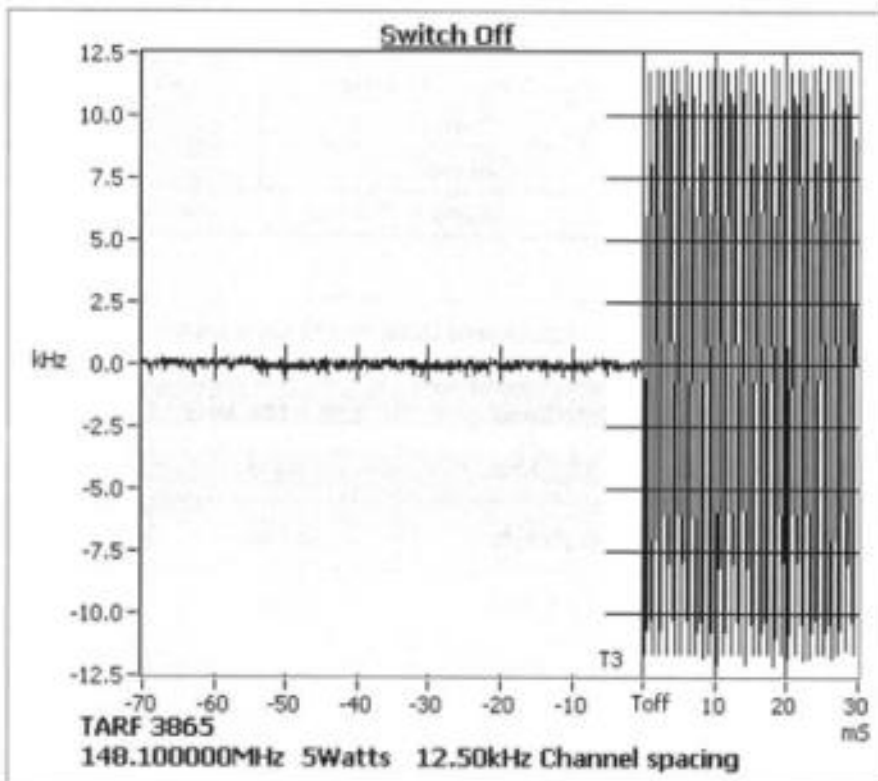
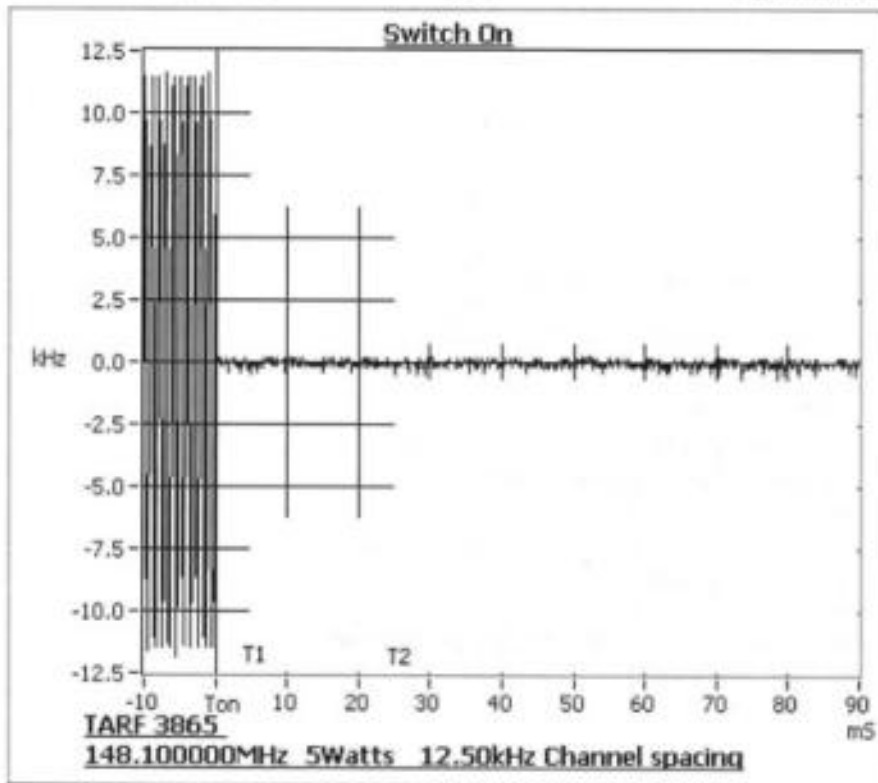

Transient Frequency Behaviour

SPECIFICATION: FCC 47 CFR 90.214

RSS-119 5.9

Tx FREQUENCY: 149.8 MHz 5 W

12.5 kHz Channel Spacing

148.1 MHz @ 5 W Tx

TRANSIENT RESPONSE PERIOD	CARRIER PEAK VARIATION FROM NORMAL	
	Key ON (kHz)	Key OFF (kHz)
t1	-0.6	N/A
t2	-0.7	N/A
t3	N/A	-0.3

Confirm that during periods t1 and t3 the frequency difference does not exceed the value of one channel separation.	YES	NO
	✓	<input type="checkbox"/>
Confirm that during the period t2 the frequency difference does not exceed half a channel separation.	YES	NO
	✓	<input type="checkbox"/>
Confirm that during the period t2 to t3 the frequency difference does not exceed the frequency error limit.	YES	NO
	✓	<input type="checkbox"/>

Measurement Uncertainty: Frequency \pm 130 Hz; Time \pm 0.2%

LIMIT: FCC 47 CFR 90.214

TRANSIENT PERIODS	FREQUENCY RANGE	
	150 MHz – 174 MHz	421 MHz – 512 MHz
t1 (ms)	5 ms	10 ms
t2 (ms)	20 ms	25 ms
t3 (ms)	5 ms	10 ms

LIMIT: RSS-119 5.9

Transient Frequency Behaviour for Equipment Designed to Operate on 12.5 kHz Channels			
TRANSIENT PERIODS	Maximum Frequency Difference	FREQUENCY RANGE	
		138 – 174 MHz	406.1 – 470 MHz
t1 (ms)	\pm 12.5 kHz	5 ms	10 ms
t2 (ms)	\pm 6.25 kHz	20 ms	25 ms
t3 (ms)	\pm 12.5 kHz	5 ms	10 ms

Note: RSS-119 5.9 - If the transmitter carrier output power rating is 6 Watts or less, the frequency difference during the time periods t1 and t3 may exceed the maximum frequency difference for these time periods.

Transient Frequency Behaviour

SPECIFICATION: FCC 47 CFR 90.214

RSS-119 5.9

Tx FREQUENCY: 149.8 MHz

5 W

12.5 kHz Channel Spacing

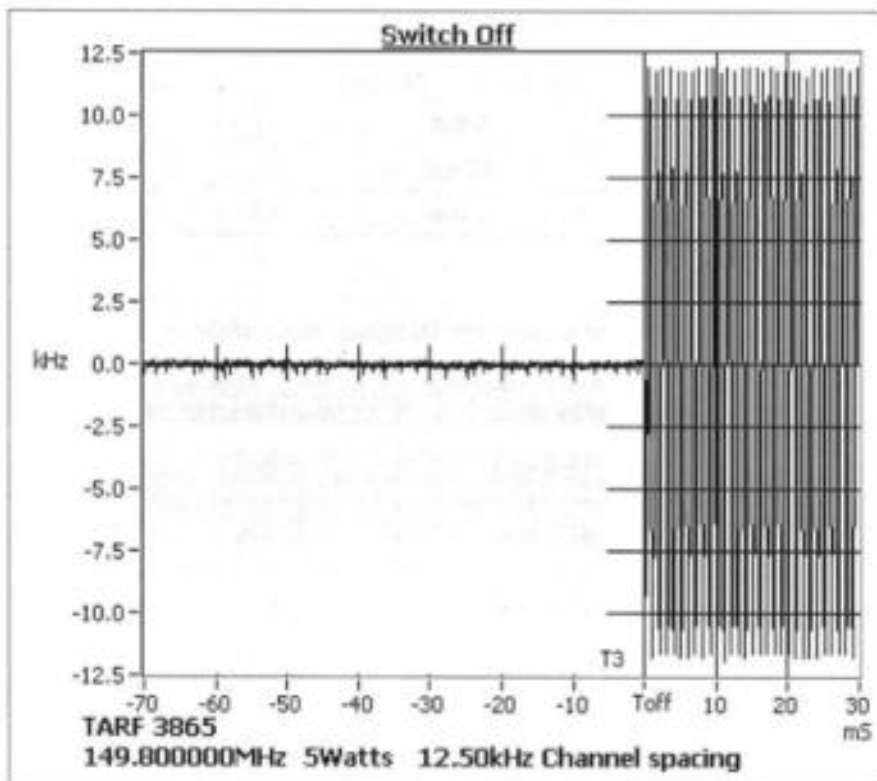
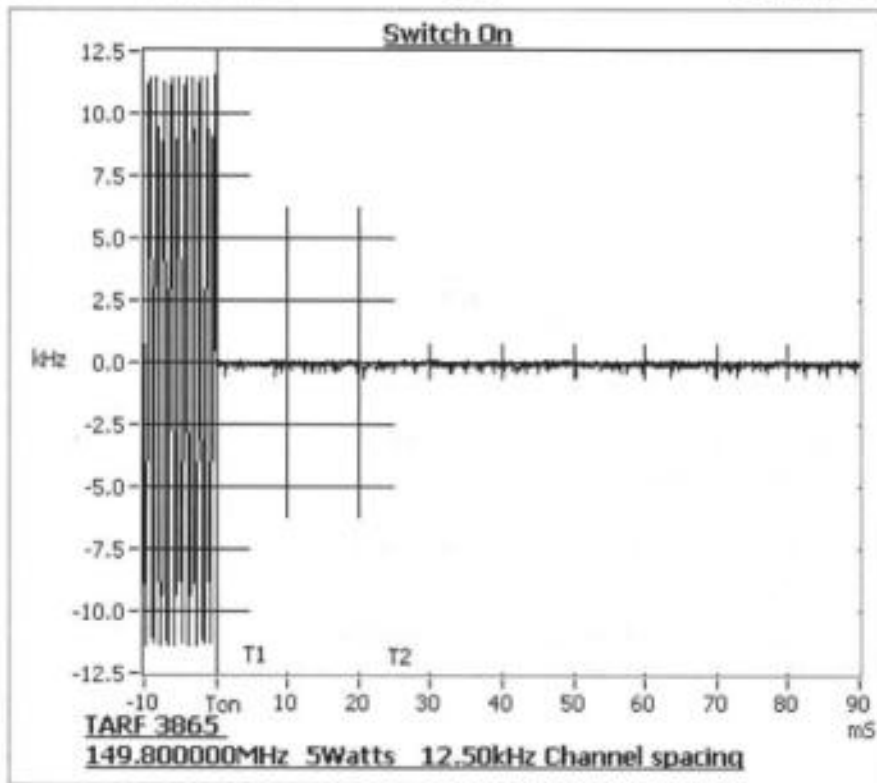

Transient Frequency Behaviour

SPECIFICATION: FCC 47 CFR 90.214

RSS-119 5.9

Tx FREQUENCY: 152.1 MHz 5 W

12.5 kHz Channel Spacing

152.1 MHz @ 5 W Tx

TRANSIENT RESPONSE PERIOD	CARRIER PEAK VARIATION FROM NORMAL	
	Key ON (kHz)	Key OFF (kHz)
t1	-0.6	N/A
t2	-0.7	N/A
t3	N/A	-0.3

Confirm that during periods t1 and t3 the frequency difference does not exceed the value of one channel separation.	YES	NO
	✓	<input type="checkbox"/>
Confirm that during the period t2 the frequency difference does not exceed half a channel separation.	YES	NO
	✓	<input type="checkbox"/>
Confirm that during the period t2 to t3 the frequency difference does not exceed the frequency error limit.	YES	NO
	✓	<input type="checkbox"/>

Measurement Uncertainty: Frequency ± 130 Hz; Time ± 0.2%

LIMIT: FCC 47 CFR 90.214

TRANSIENT PERIODS	FREQUENCY RANGE	
	150 MHz – 174 MHz	421 MHz – 512 MHz
t1 (ms)	5 ms	10 ms
t2 (ms)	20 ms	25 ms
t3 (ms)	5 ms	10 ms

LIMIT: RSS-119 5.9

Transient Frequency Behaviour for Equipment Designed to Operate on 12.5 kHz Channels			
TRANSIENT PERIODS	Maximum Frequency Difference	FREQUENCY RANGE	
		138 – 174 MHz	406.1 – 470 MHz
t1 (ms)	± 12.5 kHz	5 ms	10 ms
t2 (ms)	± 6.25 kHz	20 ms	25 ms
t3 (ms)	± 12.5 kHz	5 ms	10 ms

Note: RSS-119 5.9 - If the transmitter carrier output power rating is 6 Watts or less, the frequency difference during the time periods t1 and t3 may exceed the maximum frequency difference for these time periods.

Transient Frequency Behaviour

SPECIFICATION: FCC 47 CFR 90.214

RSS-119 5.9

Tx FREQUENCY: 152.1 MHz

5 W

12.5 kHz Channel Spacing

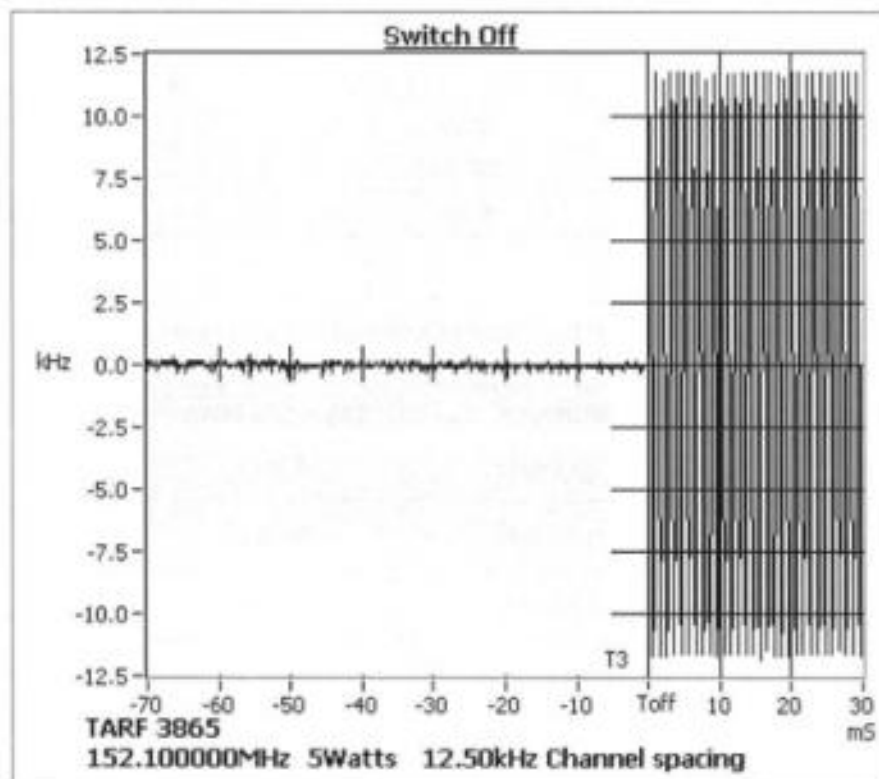
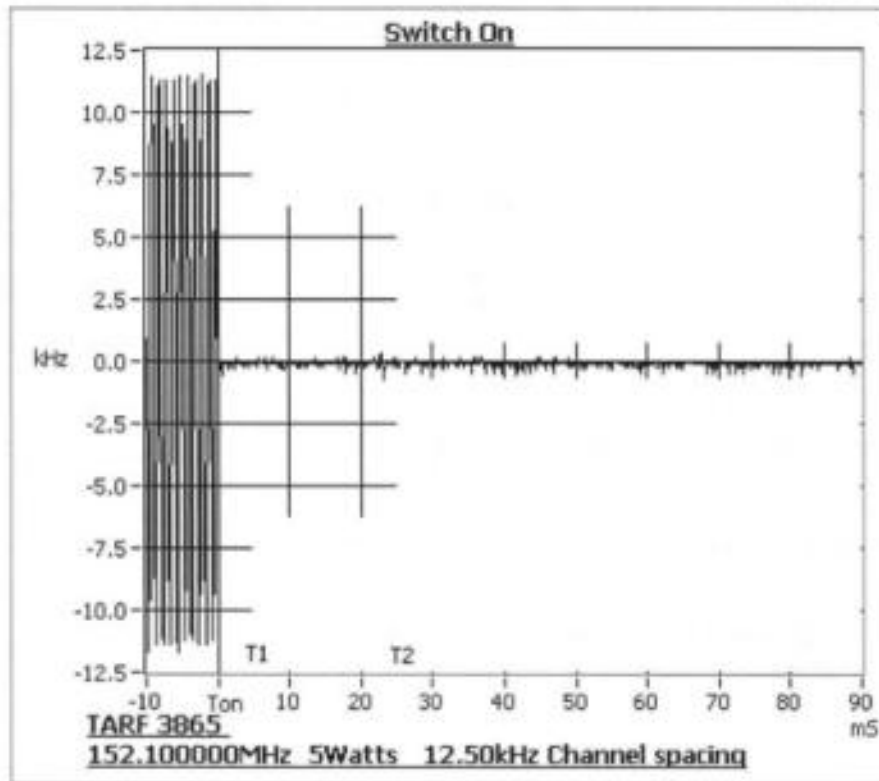

Transient Frequency Behaviour

SPECIFICATION: FCC 47 CFR 90.214

RSS-119 5.9

Tx FREQUENCY: 153.1 MHz 5 W

12.5 kHz Channel Spacing

153.1 MHz @ 5 W Tx

TRANSIENT RESPONSE PERIOD	CARRIER PEAK VARIATION FROM NORMAL	
	Key ON (kHz)	Key OFF (kHz)
t1	-3.7	N/A
t2	-0.6	N/A
t3	N/A	-0.6

Confirm that during periods t1 and t3 the frequency difference does not exceed the value of one channel separation.	YES	NO
	✓	<input type="checkbox"/>
Confirm that during the period t2 the frequency difference does not exceed half a channel separation.	YES	NO
	✓	<input type="checkbox"/>
Confirm that during the period t2 to t3 the frequency difference does not exceed the frequency error limit.	YES	NO
	✓	<input type="checkbox"/>

Measurement Uncertainty: Frequency \pm 130 Hz; Time \pm 0.2%

LIMIT: FCC 47 CFR 90.214

TRANSIENT PERIODS	FREQUENCY RANGE	
	150 MHz – 174 MHz	421 MHz – 512 MHz
t1 (ms)	5 ms	10 ms
t2 (ms)	20 ms	25 ms
t3 (ms)	5 ms	10 ms

LIMIT: RSS-119 5.9

Transient Frequency Behaviour for Equipment Designed to Operate on 12.5 kHz Channels			
TRANSIENT PERIODS	Maximum Frequency Difference	FREQUENCY RANGE	
		138 – 174 MHz	406.1 – 470 MHz
t1 (ms)	\pm 12.5 kHz	5 ms	10 ms
t2 (ms)	\pm 6.25 kHz	20 ms	25 ms
t3 (ms)	\pm 12.5 kHz	5 ms	10 ms

Note: RSS-119 5.9 - If the transmitter carrier output power rating is 6 Watts or less, the frequency difference during the time periods t1 and t3 may exceed the maximum frequency difference for these time periods.

Transient Frequency Behaviour

SPECIFICATION: FCC 47 CFR 90.214

RSS-119 5.9

Tx FREQUENCY: 153.1 MHz

5 W

12.5 kHz Channel Spacing

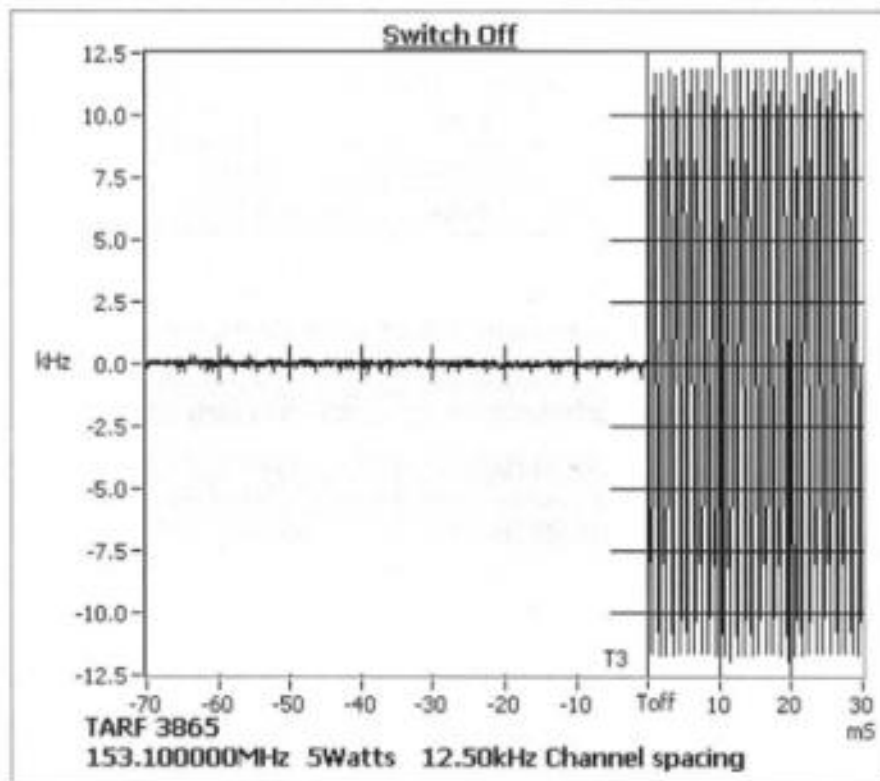
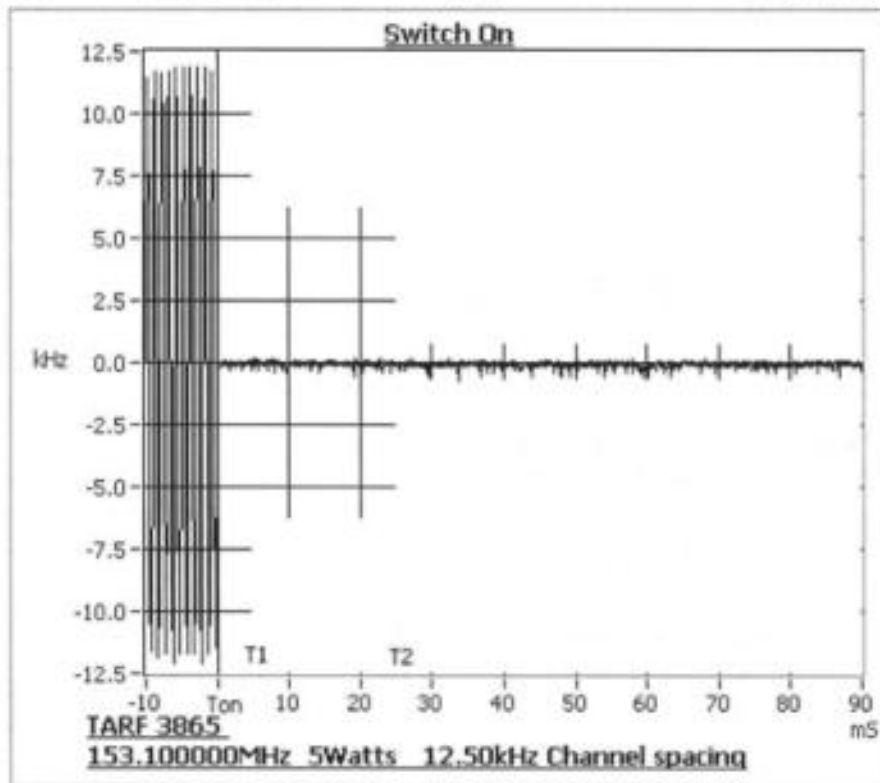

Transient Frequency Behaviour

SPECIFICATION: FCC 47 CFR 90.214

RSS-119 5.9

Tx FREQUENCY: 158.1 MHz 5 W

12.5 kHz Channel Spacing

158.1 MHz @ 5 W Tx

TRANSIENT RESPONSE PERIOD	CARRIER PEAK VARIATION FROM NORMAL	
	Key ON (kHz)	Key OFF (kHz)
t1	7.4	N/A
t2	-0.6	N/A
t3	N/A	-0.3

Confirm that during periods t1 and t3 the frequency difference does not exceed the value of one channel separation.	YES	NO
	✓	<input type="checkbox"/>
Confirm that during the period t2 the frequency difference does not exceed half a channel separation.	YES	NO
	✓	<input type="checkbox"/>
Confirm that during the period t2 to t3 the frequency difference does not exceed the frequency error limit.	YES	NO
	✓	<input type="checkbox"/>

Measurement Uncertainty: Frequency \pm 130 Hz; Time \pm 0.2%

LIMIT: FCC 47 CFR 90.214

TRANSIENT PERIODS	FREQUENCY RANGE	
	150 MHz – 174 MHz	421 MHz – 512 MHz
t1 (ms)	5 ms	10 ms
t2 (ms)	20 ms	25 ms
t3 (ms)	5 ms	10 ms

LIMIT: RSS-119 5.9

Transient Frequency Behaviour for Equipment Designed to Operate on 12.5 kHz Channels			
TRANSIENT PERIODS	Maximum Frequency Difference	FREQUENCY RANGE	
		138 – 174 MHz	406.1 – 470 MHz
t1 (ms)	\pm 12.5 kHz	5 ms	10 ms
t2 (ms)	\pm 6.25 kHz	20 ms	25 ms
t3 (ms)	\pm 12.5 kHz	5 ms	10 ms

Note: RSS-119 5.9 - If the transmitter carrier output power rating is 6 Watts or less, the frequency difference during the time periods t1 and t3 may exceed the maximum frequency difference for these time periods.

Transient Frequency Behaviour

SPECIFICATION: FCC 47 CFR 90.214

RSS-119 5.9

Tx FREQUENCY: 158.1 MHz

5 W

12.5 kHz Channel Spacing

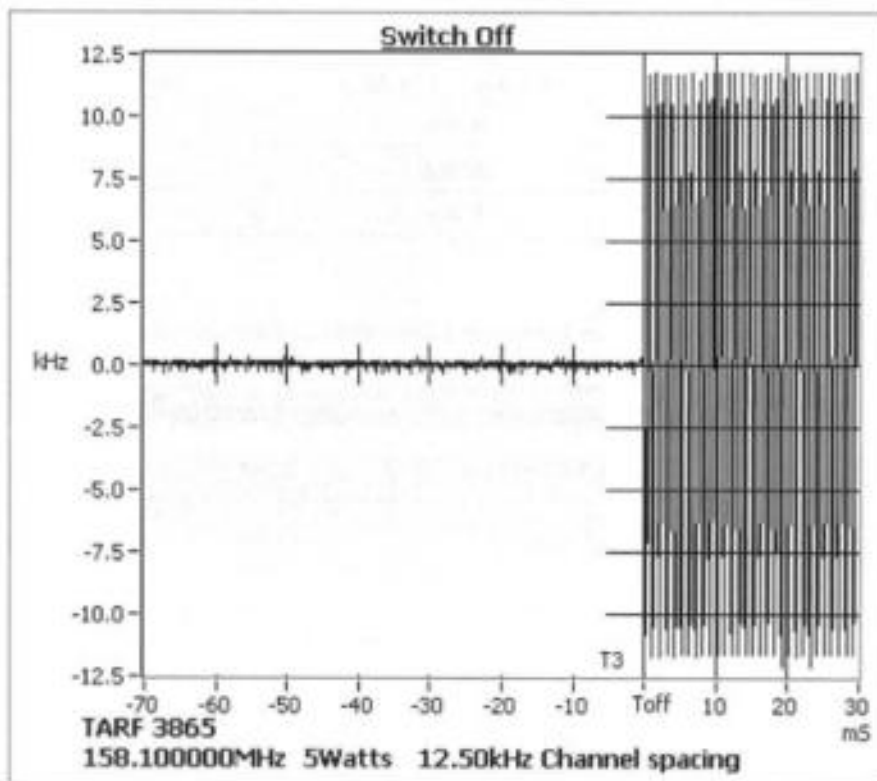
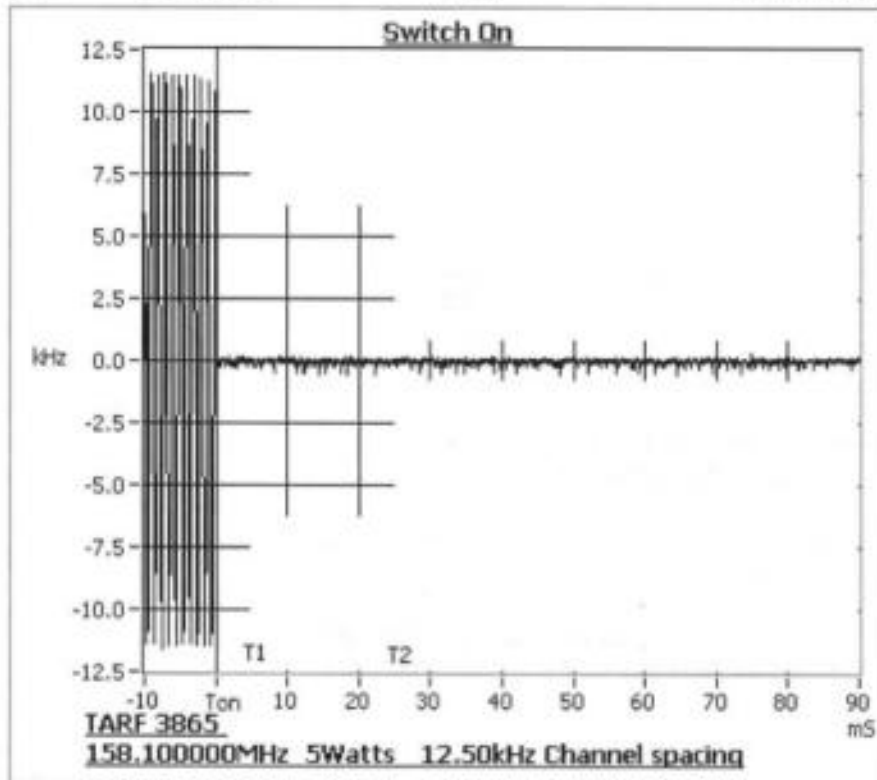

Transient Frequency Behaviour

SPECIFICATION: FCC 47 CFR 90.214

RSS-119 5.9

Tx FREQUENCY: 161.1 MHz 5 W

12.5 kHz Channel Spacing

161.1 MHz @ 5 W Tx

TRANSIENT RESPONSE PERIOD	CARRIER PEAK VARIATION FROM NORMAL	
	Key ON (kHz)	Key OFF (kHz)
t1	4.1	N/A
t2	0.9	N/A
t3	N/A	0.5

Confirm that during periods t1 and t3 the frequency difference does not exceed the value of one channel separation.	YES	NO
	✓	<input type="checkbox"/>
Confirm that during the period t2 the frequency difference does not exceed half a channel separation.	YES	NO
	✓	<input type="checkbox"/>
Confirm that during the period t2 to t3 the frequency difference does not exceed the frequency error limit.	YES	NO
	✓	<input type="checkbox"/>

Measurement Uncertainty: Frequency \pm 130 Hz; Time \pm 0.2%

LIMIT: FCC 47 CFR 90.214

TRANSIENT PERIODS	FREQUENCY RANGE	
	150 MHz – 174 MHz	421 MHz – 512 MHz
t1 (ms)	5 ms	10 ms
t2 (ms)	20 ms	25 ms
t3 (ms)	5 ms	10 ms

LIMIT: RSS-119 5.9

Transient Frequency Behaviour for Equipment Designed to Operate on 12.5 kHz Channels			
TRANSIENT PERIODS	Maximum Frequency Difference	FREQUENCY RANGE	
		138 – 174 MHz	406.1 – 470 MHz
t1 (ms)	\pm 12.5 kHz	5 ms	10 ms
t2 (ms)	\pm 6.25 kHz	20 ms	25 ms
t3 (ms)	\pm 12.5 kHz	5 ms	10 ms

Note: RSS-119 5.9 - If the transmitter carrier output power rating is 6 Watts or less, the frequency difference during the time periods t1 and t3 may exceed the maximum frequency difference for these time periods.

Transient Frequency Behaviour

SPECIFICATION: FCC 47 CFR 90.214

RSS-119 5.9

Tx FREQUENCY: 161.1 MHz

5 W

12.5 kHz Channel Spacing

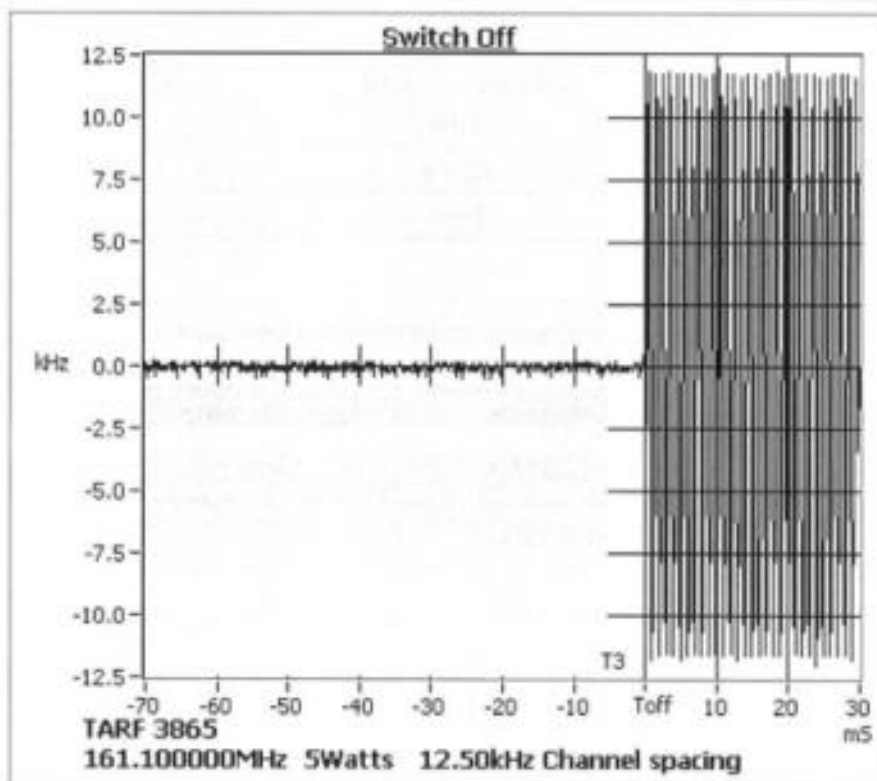
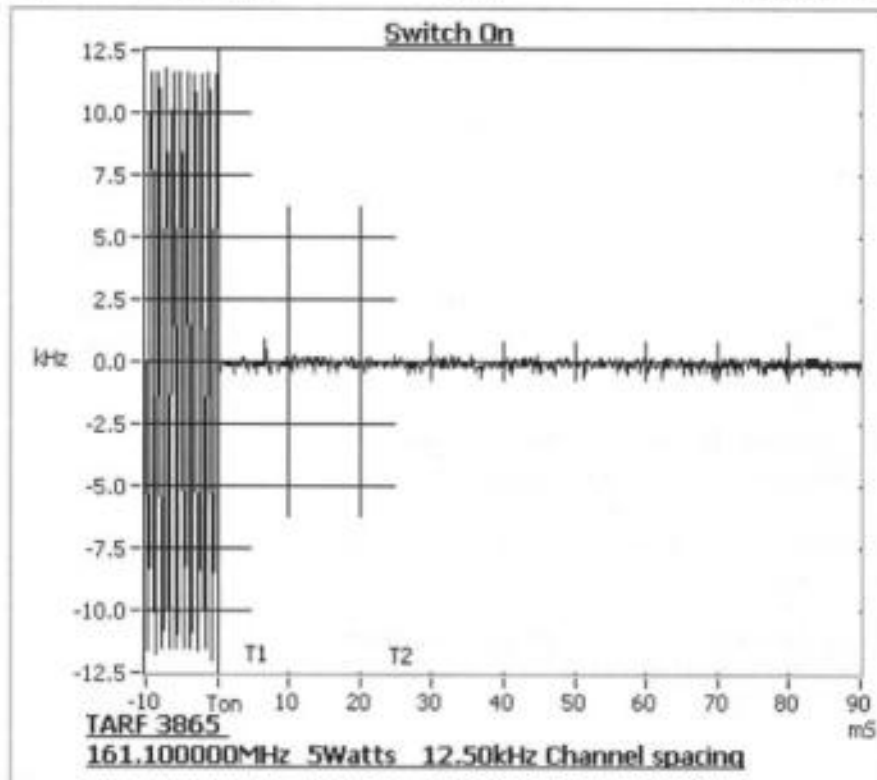

Transient Frequency Behaviour

SPECIFICATION: FCC 47 CFR 90.214

RSS-119 5.9

Tx FREQUENCY: 173.1 MHz 5 W

12.5 kHz Channel Spacing

173.1 MHz @ 5 W Tx

TRANSIENT RESPONSE PERIOD	CARRIER PEAK VARIATION FROM NORMAL	
	Key ON (kHz)	Key OFF (kHz)
t1	-1.0	N/A
t2	-0.6	N/A
t3	N/A	0.4

Confirm that during periods t1 and t3 the frequency difference does not exceed the value of one channel separation.	YES	NO
	✓	<input type="checkbox"/>
Confirm that during the period t2 the frequency difference does not exceed half a channel separation.	YES	NO
	✓	<input type="checkbox"/>
Confirm that during the period t2 to t3 the frequency difference does not exceed the frequency error limit.	YES	NO
	✓	<input type="checkbox"/>

Measurement Uncertainty: Frequency ± 130 Hz; Time ± 0.2%

LIMIT: FCC 47 CFR 90.214

TRANSIENT PERIODS	FREQUENCY RANGE	
	150 MHz – 174 MHz	421 MHz – 512 MHz
t1 (ms)	5 ms	10 ms
t2 (ms)	20 ms	25 ms
t3 (ms)	5 ms	10 ms

LIMIT: RSS-119 5.9

Transient Frequency Behaviour for Equipment Designed to Operate on 12.5 kHz Channels			
TRANSIENT PERIODS	Maximum Frequency Difference	FREQUENCY RANGE	
		138 – 174 MHz	406.1 – 470 MHz
t1 (ms)	± 12.5 kHz	5 ms	10 ms
t2 (ms)	± 6.25 kHz	20 ms	25 ms
t3 (ms)	± 12.5 kHz	5 ms	10 ms

Note: RSS-119 5.9 - If the transmitter carrier output power rating is 6 Watts or less, the frequency difference during the time periods t1 and t3 may exceed the maximum frequency difference for these time periods.

Transient Frequency Behaviour

SPECIFICATION: FCC 47 CFR 90.214

RSS-119 5.9

Tx FREQUENCY: 173.1 MHz

5 W

12.5 kHz Channel Spacing

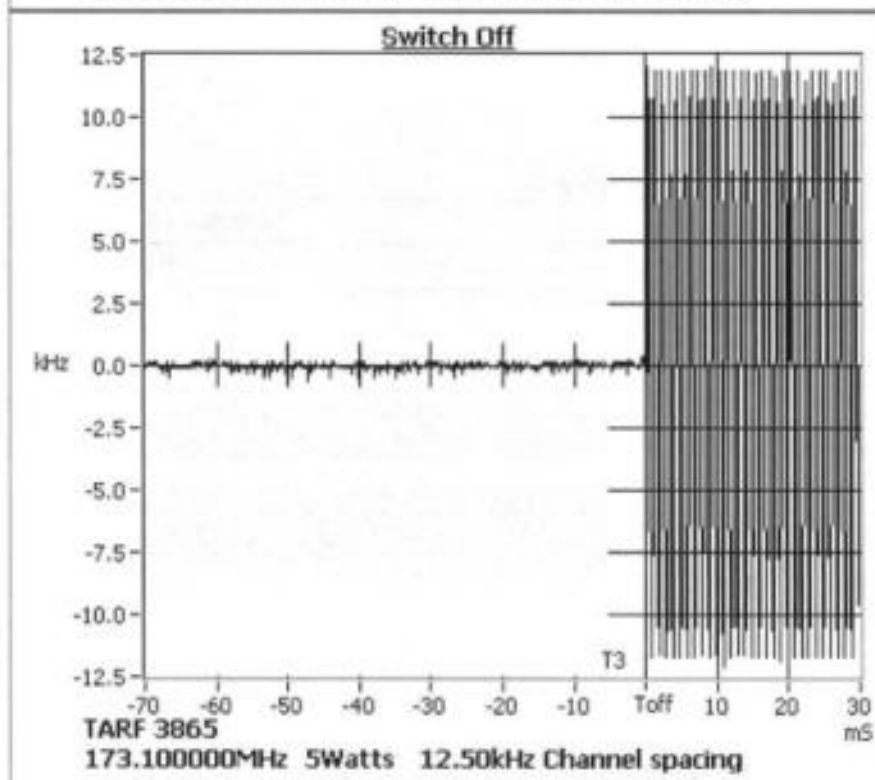
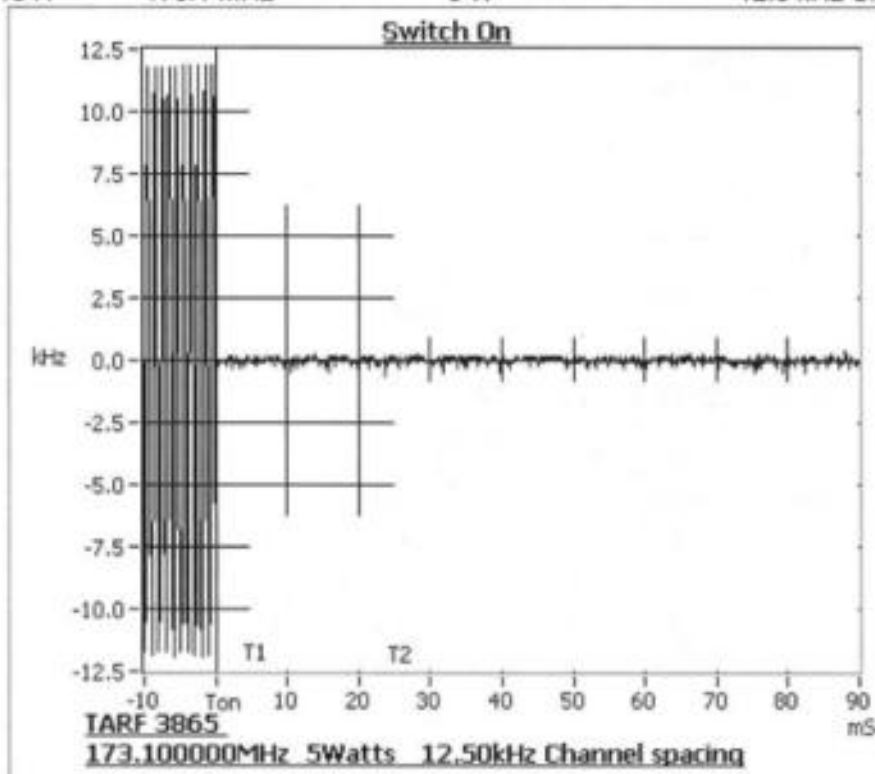

TRANSMITTER FREQUENCY STABILITY - TEMPERATURE

SPECIFICATION: FCC 47 CFR 2.1055 (a) (1)

RSS-119 5.3

GUIDE: TIA/EIA-603D 2.2.2

MEASUREMENT PROCEDURE:

1. Refer Annex A for equipment set up.
2. The EUT was tested for frequency error from -30° C to +50° C in 10° C increments
3. The frequency error was recorded in parts per million (ppm).

MEASUREMENT RESULTS:

See the plots on the following pages for 12.5 kHz channel spacing.

Temperature (°C)	Error (ppm)								
	138.1 MHz	143.9 MHz	148.1 MHz	149.8 MHz	152.1 MHz	153.1 MHz	158.1 MHz	161.1 MHz	173.1 MHz
-30	-0.17	-0.17	-0.18	-0.18	-0.18	-0.2	-0.2	-0.22	-0.23
-20	-0.27	-0.26	-0.24	-0.23	-0.22	-0.21	-0.2	-0.2	-0.18
-10	-0.17	-0.14	-0.14	-0.14	-0.14	-0.14	-0.15	-0.14	-0.16
0	-0.19	-0.17	-0.16	-0.15	-0.14	-0.13	-0.12	-0.12	-0.1
10	-0.07	-0.06	-0.03	-0.02	-0.01	0.01	0.01	0.02	0.02
20	0.04	0.04	0.05	0.05	0.06	0.06	0.05	0.06	0.06
30	0.01	0.01	0.02	0.01	0.02	0.01	0.01	0.02	0.01
40	-0.02	-0.02	0	-0.01	0.01	0.01	0.02	0.02	0.03
50	0.06	0.06	0.09	0.09	0.11	0.12	0.13	0.14	0.14
Measurement Uncertainty				$\pm 7 \times 10^{-8}$					

LIMIT: FCC 47 CFR 90.213

RSS-119 5.3

Channel Spacing (kHz)	Frequency Error (ppm)
12.5	5.0

Transmitter Frequency Stability - Temperature

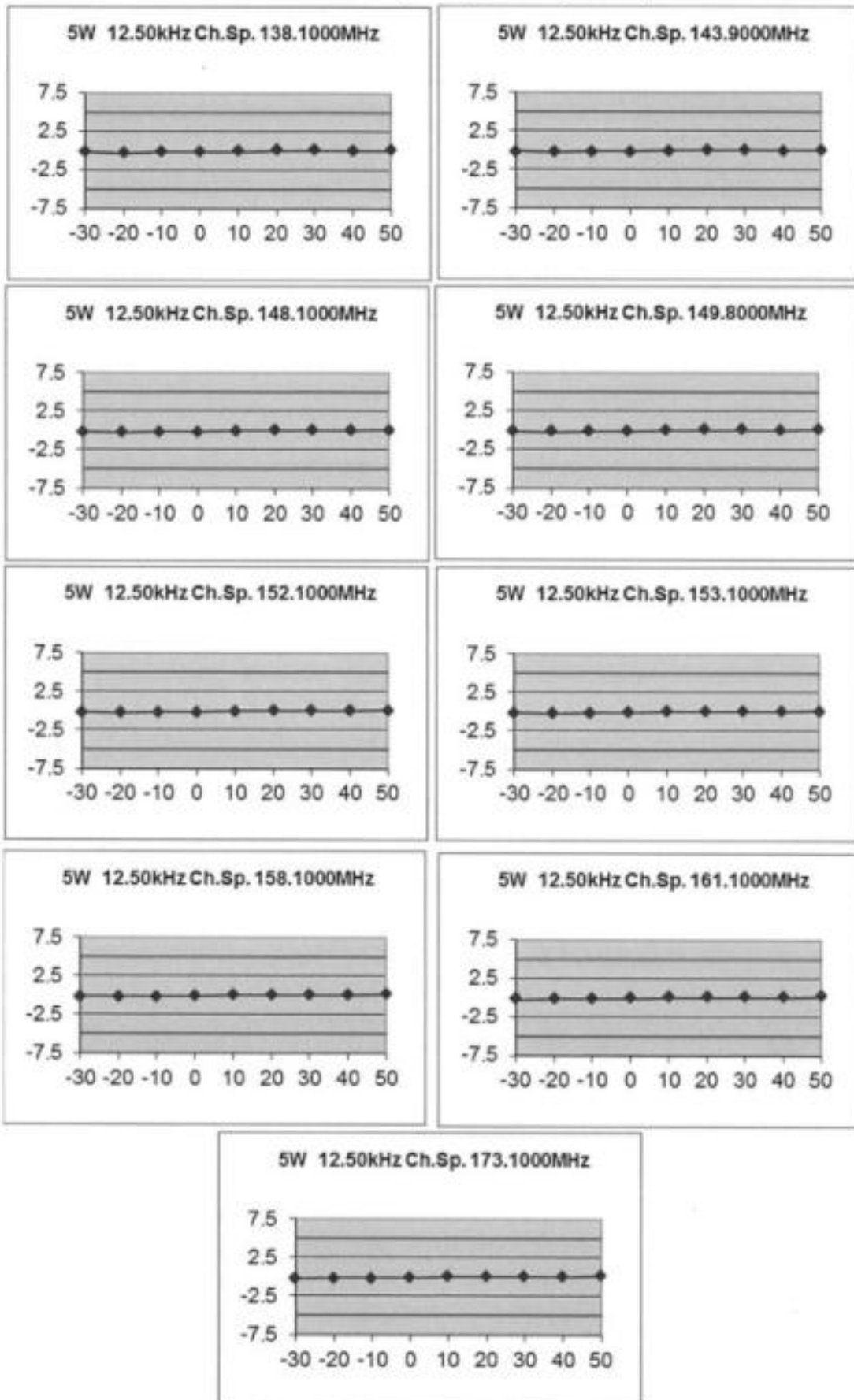

TRANSMITTER FREQUENCY STABILITY - VOLTAGE

SPECIFICATION: FCC 47 CFR 2.1055 (d) (1)

RSS-119 5.3

GUIDE: TIA/EIA-603D 2.2.2

MEASUREMENT PROCEDURE:

1. Refer Annex A for equipment set up.
2. The EUT was tested for frequency error at an input voltage to the radio of Portable nominal battery voltage and battery end point.
3. The frequency error was recorded in parts per million (ppm).

MEASUREMENT RESULTS:

	FREQUENCY ERROR (ppm) for 12.5 kHz	
	7.5 V _{DC}	6.375 V _{DC}
138.1 MHz	0.01	0.03
143.9 MHz	0.03	0.03
148.1 MHz	0.05	0.04
149.8 MHz	0.03	0.03
152.1 MHz	0.03	0.05
153.1 MHz	0.04	0.04
158.1 MHz	0.03	0.04
161.1 MHz	0.02	0.03
173.1 MHz	-0.07	0.03
Measurement Uncertainty		$\pm 7 \times 10^{-6}$

LIMIT CLAUSES: FCC 47 CFR 90.213 RSS-119 5.3

Channel Spacing (kHz)	Frequency Error (ppm)
12.5	5.0

RECEIVER SPURIOUS EMISSIONS (CONDUCTED)

SPECIFICATION: RSS-119 5.11

GUIDE: TIA/EIA-603D 2.1.2

MEASUREMENT PROCEDURE:

1. Refer Annex A for Equipment set up diagram.
2. The frequency range examined was from 30 MHz to 3 times highest tunable frequency.
3. Spurious emissions which were attenuated more than 20 dB below the limit were not recorded.

138.1 MHz Receive		
Emission Frequency (MHz)	Level (nW)	Level (dBm)
-	-	-
Measurement Uncertainty	≤ 2.75 GHz ± 3.0 dB	
No emissions were detected within 20 dB of Limit.		

143.9 MHz Receive		
Emission Frequency (MHz)	Level (nW)	Level (dBm)
-	-	-
Measurement Uncertainty	≤ 2.75 GHz ± 3.0 dB	
No emissions were detected within 20 dB of Limit.		

148.1 MHz Receive		
Emission Frequency (MHz)	Level (nW)	Level (dBm)
-	-	-
Measurement Uncertainty	≤ 2.75 GHz ± 3.0 dB	
No emissions were detected within 20 dB of Limit.		

149.8 MHz Receive		
Emission Frequency (MHz)	Level (nW)	Level (dBm)
-	-	-
Measurement Uncertainty	≤ 2.75 GHz ± 3.0 dB	
No emissions were detected within 20 dB of Limit.		

Receiver Spurious Emissions (Conducted) – Continued

152.1 MHz Receive		
Emission Frequency (MHz)	Level (nW)	Level (dBm)
-	-	-
Measurement Uncertainty	≤ 2.75 GHz ± 3.0 dB	
No emissions were detected within 20 dB of Limit.		

153.1 MHz Receive		
Emission Frequency (MHz)	Level (nW)	Level (dBm)
-	-	-
Measurement Uncertainty	≤ 2.75 GHz ± 3.0 dB	
No emissions were detected within 20 dB of Limit.		

158.1 MHz Receive		
Emission Frequency (MHz)	Level (nW)	Level (dBm)
-	-	-
Measurement Uncertainty	≤ 2.75 GHz ± 3.0 dB	
No emissions were detected within 20 dB of Limit.		

161.1 MHz Receive		
Emission Frequency (MHz)	Level (nW)	Level (dBm)
-	-	-
Measurement Uncertainty	≤ 2.75 GHz ± 3.0 dB	
No emissions were detected within 20 dB of Limit.		

173.1 MHz Receive		
Emission Frequency (MHz)	Level (nW)	Level (dBm)
-	-	-
Measurement Uncertainty	≤ 2.75 GHz ± 3.0 dB	
No emissions were detected within 20 dB of Limit.		

Receiver Spurious Emissions (Conducted) – Continued

LIMIT CLAUSE: RSS-Gen 6(b)

LIMIT	30 → 1000 MHz	2 nW	- 57 dBm
	> 1000 MHz	5 nW	- 53 dBm

TEST EQUIPMENT LIST

Equipment Type	Information	Manufacturer	Model No	Serial No#	Tait ID	Cal Due
Signal Generator	Analog 1GHz	Hewlett Packard	HP8648A	3430U00344	E3579	25-Sep-18
Signal Generator	Analog 4GHz	Agilent	E4422B	GB40050320	E3788	28-Sep-18
Signal Generator	Digital 3GHz	Agilent	E4438C	MY45093154	E4600	14-Oct-18
Power Supply	TREVA2 60V/25A	Agilent	N5767A	US09F4901H	E4656	7-Oct-19
Antenna	Reference Dipoles	Emco	3121C DB1	9510-1164	E3559	14-Apr-19
Antenna	18GHz DRG	Emco	DRG3115	9512-4638	E3560	15-May-20
Spectrum Analyser	26.5GHz	Agilent	PXA N9030A	MY49432161	E4907	18-Oct-18
RF Chamber	S-LINE TEM CELL	Rohde & Schwarz	1089.9296.02	338232/003	E3636	
Coax cable	OATS Turntable Cable 2	Intelcom	RG215	OATS3	E4995	1-Jan-19
RF Attenuator	20dB 25W	Weinschel	33-20-33	BD5871	E3673	20-Dec-18
RF Attenuator	TREVA2 20dB 150W	Weinschel	40-20-33	CJ405	E3733	20-Dec-18
Coax Cable	2m Black	Suhner	RG214HF/Nm/Nm/2000	TeltestBlack2	E4623	20-Dec-18
Coax Cable	2m Black	Suhner	RG214HF/Nm/Nm/2000	TeltestBlack3	E4624	20-Dec-18
Audio Analyser	TREVA2	Hewlett Packard	HP8903B	2818A04275	E3710	6-Oct-18
Spectrum Analyser	13.2GHz	Hewlett Packard	HP8562E	3821A00779	E3715	2-Oct-18
Power Supply	60V/50A/1000W	Hewlett Packard	HP6012B	2524A00616	E3712	30-Sep-19
Modulation Analyser	TREVA2	Hewlett Packard	HP8901B (Opt 002)	3704A05837	E3786	4-Oct-18
Signal Generator	TREVA2 Analog 3.3GHz	Rohde & Schwarz	SML03 1090.3000.13	100597	E4050	10-Oct-18
RF Attenuator	TREVA2 3dB	Weinschel	Model 1	BL9950	E4080	20-Dec-18
Spectrum Analyser	13.2GHz	Agilent	E4445A	MY42510072	E4139	15-Oct-18
Coax Cable	OATS Turntable Cable 1	Intelcom	RG214	OATS1	E4621	1-Jan-19
Coax Cable	OATS Tower Cable	Intelcom	RG214	OATS2	E4622	1-Jan-19
OATS	Antenna Tower	Electrometrics	EM-4720-2	112	E4447	
OATS	Controller	Electrometrics	EM-4700	119	E4445	
OATS	Turntable	Electrometrics	EM-4704A	105	E4446	
RF Attenuator	30dB 350W	Weinschel	67-30-33	BR0531	E4280	20-Dec-18
Antenna	Log Periodic	Schwarzbeck	VUSLP	9111-219	E4617	
Coax Cable	Reverb - 4.5m Multiflex 141	TeltestBlue6	MF 141	TeltestBlue6	E4843	20-Dec-18
Coax Cable	Reverb - 1m Multiflex 141	TeltestBlue2	MF 141	TeltestBlue2	E4847	20-Dec-18
RF	0.2 to 4GHz	Ophir	5161FE	1044	E4851	

TELTEST Laboratories
Tait Ltd
Report Number 3865

Amplifier	15W					
Power Meter	Reverb - USB interface for NRT Z44	Rohde & Schwarz	NRT Z5	100586	E4852	
Power Meter	Reverb - 0.2 - 4GHz directional power meter	Rohde & Schwarz	NRT Z44	105151	E4853	11-Oct-18
RF Chamber	Reverb - Stirrer controller for reverb chamber	Teseq	Stirrer Controller	29765.1	E4854	
RF Chamber	Reverb - 0.5 - 18GHz Reverberation Chamber	Teseq	RVC XS	29765	E4855	
Antenna	Reverb - 1-18GHz DRG	Schwarzbeck	BBHA 9120 D	9120D-885	E4857	
Antenna	Reverb - 1-18GHz DRG	Schwarzbeck	BBHA 9120 D	9120D-884	E4858	
RF Amplifier	Pre-amplifier	Agilent	87405C	MY47010688	E4941	9-Oct-18
Power Supply	60V/25A	Agilent	N5767A	3111A05573	E4979	10-Oct-18
Coax Cable	2m Black	Suhner	RG214HF/Nm/Nm/2000	TeltestBlack8	E5005	1-Jan-19
Testware	S-Line Radiated Emissions		May 2016			
Testware	Reverb		28 May 2015			
Testware	Frequency Vs Temperature		May 2016	-	-	
Testware	Occupied Bandwidth		5/10/2012	-	-	
Testware	Radiated Emissions		September 2015	-	-	
Testware	Reverb Emissions		28 May 2015	-	-	
Testware	Sideband Spectrum		August 2015	-	-	
Testware	TREVA		December 2015	-	-	

* NOTE: Items without calibration dates are calibrated immediately before use, or set using calibrated instruments.

ANNEX A – TEST SETUP DETAILS

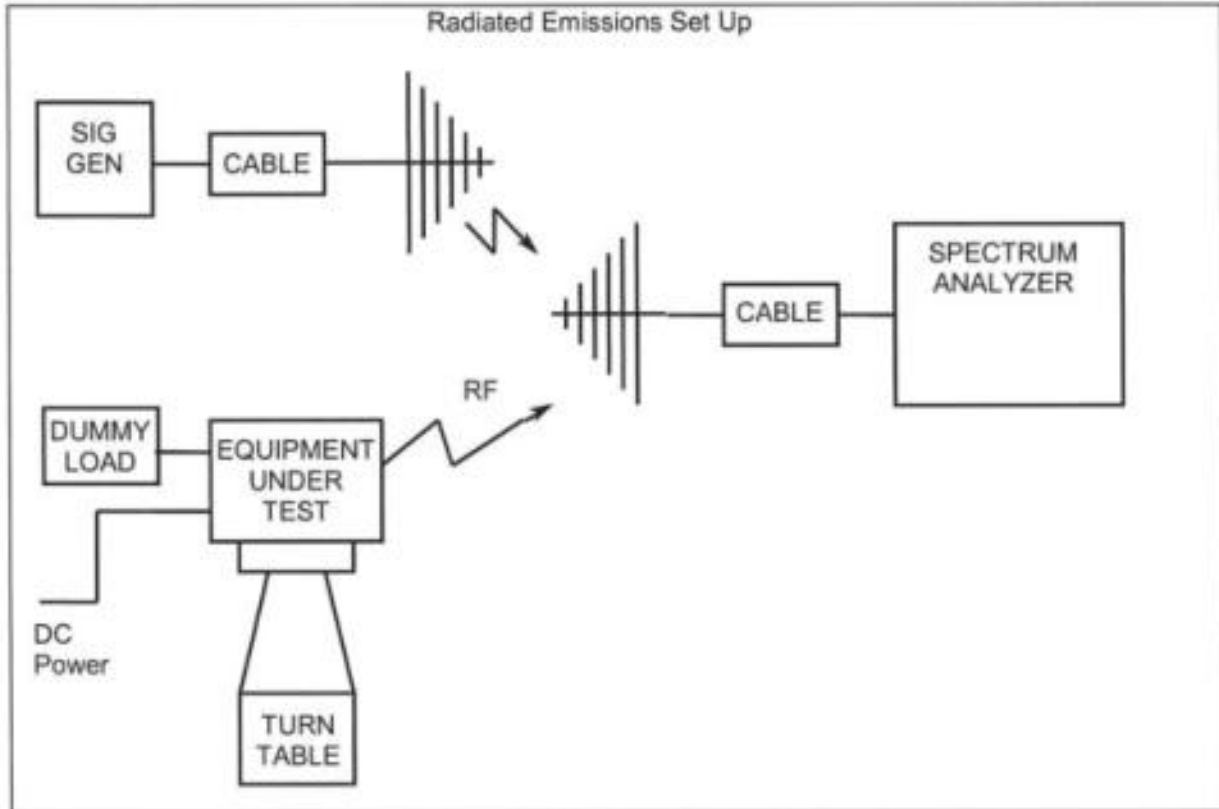

All other testing is performed using the Teltest Radio EVALuation system (TREVA), which is configured as shown below. The Spectrum Analyser is connected to the EUT via the attenuator network for Conducted Emissions testing, and Occupied Bandwidth.

