

# TM9300 DMR Mobile Radios User's Guide

MMB-00001-02 · Issue 2 · October 2013





# Contents

	<b>For your safety</b> .....	<b>7</b>
	<b>Menu maps</b> .....	<b>16</b>
<b>1</b>	<b>About this guide</b> .....	<b>18</b>
	Safety warnings used in this guide .....	18
	Related documentation.....	19
<b>2</b>	<b>Getting started</b> .....	<b>20</b>
	About DMR digital radios.....	21
	About the radio controls.....	22
	Understanding the radio display .....	25
	Understanding the radio indicators.....	27
	Using function keys to access frequently used features.....	29
	Navigating the radio's menus .....	30
	Using the alphanumeric keys to search a list .....	32
<b>3</b>	<b>Basic operation</b> .....	<b>33</b>
	Turning the radio on and off .....	34
	Adjusting the speaker volume .....	35
	Locking and unlocking the keypad .....	36
	Changing the radio's operating mode.....	37
<b>4</b>	<b>Operating in trunked mode</b> .....	<b>38</b>
	Checking that your network is available .....	39
	Changing your network.....	39
	Making a preset call.....	40
	About trunked zones and workgroups .....	42
	About emergency operation .....	45
	Dialing a PABX number .....	47
	Dialing a PSTN number.....	47
	Receiving a call .....	48
	Re-establishing a call .....	49
	Checking missed calls .....	50
	About status messages .....	52
	About trunked text messages .....	54
	Placing the radio in do-not-disturb mode.....	57
	Calls to conventional channels or conventional groups..	58
<b>5</b>	<b>Dialing calls in trunked mode</b> .....	<b>59</b>
	MPT 1343 dialing.....	60
	Nokia ANN fleet calls.....	62
	Accessing common trunking functions .....	64
<b>6</b>	<b>Operating in conventional mode</b> .....	<b>66</b>

Selecting a zone.....	67
Selecting a channel.....	68
Selecting a group.....	69
Checking that a channel is clear.....	70
Making a call.....	71
Making a call using the address book.....	72
Making a local call.....	73
Connecting to a telephone network.....	74
Making an emergency call.....	76
Sending a status message.....	76
Transmitting at low power.....	77
Ending active calls.....	78
Activating the repeater before a call.....	79
Communicating directly with other radios.....	80
Receiving a call.....	81
Receiving a text message.....	81
Hearing faint and noisy signals.....	82
Using the radio in different repeater areas.....	83
Scanning a group of channels.....	84
<b>7 GPS location services.....</b>	<b>91</b>
About GPS location information.....	92
About GPS status information.....	92
Viewing GPS information.....	93
<b>8 Loneworker monitoring.....</b>	<b>94</b>
Activating loneworker monitoring.....	94
Responding to a loneworker alarm.....	95
<b>9 Customizing radio settings.....</b>	<b>96</b>
Changing the volume of all audible indicators.....	97
Changing the volume of keypress tones.....	97
Changing to quiet operation.....	98
Changing to silent operation.....	98
Changing the external alert option.....	99
Turning on backlighting.....	99
Adjusting the display contrast.....	101
<b>10 Troubleshooting.....</b>	<b>102</b>
About troubleshooting.....	103
Checking the version of your radio.....	104
General care.....	105
<b>Directive 1999/5/CE Declaration of Conformity</b>	<b>106</b>
<b>Tait Software Licence Agreement.....</b>	<b>107</b>

## Copyright and trademarks

All information contained in this document is the property of Tait Limited. All rights reserved. This document may not, in whole or in part, be copied, photocopied, reproduced, translated, stored, or reduced to any electronic medium or machine-readable form, without prior written permission from Tait Limited.

The word TAIT and the TAIT logo are trademarks of Tait Limited.

All trade names referenced are the service mark, trademark or registered trademark of the respective manufacturers.

## Disclaimer

There are no warranties extended or granted by this document. Tait Limited accepts no responsibility for damage arising from use of the information contained in the document or of the equipment and software it describes. It is the responsibility of the user to ensure that use of such information, equipment and software complies with the laws, rules and regulations of the applicable jurisdictions.

## Enquiries and comments

If you have any enquiries regarding this document, or any comments, suggestions and notifications of errors, please contact your regional Tait office.

## Updates of manual and equipment

In the interests of improving the performance, reliability or servicing of the equipment, Tait Limited reserves the right to update the equipment or this document or both without prior notice.

## Intellectual property rights

This product may be protected by one or more patents or designs of Tait Limited together with their international equivalents, pending patent or design applications, and registered trade marks: NZ409837, NZ409838, NZ415277, NZ415278, NZ508806, NZ508807, NZ511155, NZ516280/NZ519742, NZ520650/NZ537902, NZ521450, NZ524369, NZ524378, NZ524509, NZ524537, NZ530819, NZ534475, NZ534692, NZ537434, NZ547713, NZ569985, NZ577009, NZ579051, NZ579364, NZ580361/NZ601933, NZ584534, NZ586889, AU2003281447, AU2004216984, AU2010212364, AU11677/2008, AU13745/2008,

CN200930004199.5, CN1031871, CN1070368,  
CN200930004200.4, CN200930009301.0,  
CN201110141630, CN201110253742.1, EU000915475-  
0001, EU000915475-0002, GB2413249, US5,745,840,  
US7,649,893, US7,758,996, US7,937,661, US8,301,682,  
US10/597339, US29/401234, US29/401235,  
US61/218015, US61/236663, US61/323437.

This product may also be made under license under one or more of the following U.S. Patents: 5,146,497, 5,148,482, 5,164,986, 5,185,795, 5,185,796, 5,271,017, 5,377,229 and 5,502,767.

The AMBE+2™ voice coding Technology embodied in this product is protected by intellectual property rights including patent rights, copyrights and trade secrets of Digital Voice Systems, Inc. This voice coding Technology is licensed solely for use within this Communications Equipment. The user of this Technology is explicitly prohibited from attempting to decompile, reverse engineer, or disassemble the Object Code, or in any other way convert the Object Code into a human-readable form. Protected by U.S. Patents 5,870,405, 5,826,222, 5,754,974, 5,701,390, 5,715,365, 5,649,050, 5,630,011, 5,581,656, 5,517,511, 5,491,772, 5,247,579, 5,226,084 and 5,195,166.

## Environmental responsibilities



Tait Limited is an environmentally responsible company which supports waste minimization, material recovery and restrictions in the use of hazardous materials.

The European Union's Waste Electrical and Electronic Equipment (WEEE) Directive requires that this product be disposed of separately from the general waste stream when its service life is over. For more information about how to dispose of your unwanted Tait product, visit the Tait WEEE website at [www.taitradio.com/weee](http://www.taitradio.com/weee). Please be environmentally responsible and dispose through the original supplier, or contact Tait Limited.

Tait Limited also complies with the Restriction of the Use of Certain Hazardous Substances in Electrical and Electronic Equipment (RoHS) Directive in the European Union.

In China, we comply with the Measures for Administration of the Pollution Control of Electronic Information Products. We will comply with environmental requirements in other markets as they are introduced.

# For your safety

Before using your radio, please read the following important safety and compliance information.

## Radio frequency exposure information

For your own safety and to ensure you comply with the Federal Communication Commission's (FCC) radio frequency (RF) exposure guidelines, please read the following information before using this radio.

### Using this radio

You should use this radio only for work-related purposes (it is not authorized for any other use) and if you are fully aware of, and can exercise control over, your exposure to RF energy. To prevent exceeding FCC RF exposure limits, you must control the amount and duration of RF that you and other people are exposed to.

It is also important that you:

- Do not remove the RF Exposure label from the radio.
- Ensure this RF exposure information accompanies the radio when it is transferred to other users.
- Do not use the radio if you do not adhere to the guidelines on controlling your exposure to RF.

### Controlling your exposure to RF energy

This radio emits radio frequency (RF) energy or radio waves primarily when calls are made. RF is a form of electromagnetic energy (as is sunlight), and there are recommended levels of maximum RF exposure.

To control your exposure to RF and comply with the maximum exposure limits for occupational/controlled environments, follow these guidelines:

- Do not talk (transmit) on the radio more than the rated transmit duty cycle. This is important because the radio radiates more energy when it is transmitting than when it is receiving.
- While you are transmitting (talking or sending data) on the radio, you must ensure that there is always a distance of 35 inches (0.9m) between people and the antenna. This is the minimum safe distance.
- Use the radio only with Tait-approved antennas and attachments, and make only authorized modifications to the antenna otherwise you could damage the radio and violate FCC regulations.

For more information on what RF energy is and how to control your exposure to it, visit the FCC website at [www.fcc.gov/oet/rfsafety/rf-faqs.html](http://www.fcc.gov/oet/rfsafety/rf-faqs.html).

## **Health Canada warning statement**

The installer of this radio equipment must ensure that the antenna is located or pointed such that it does not emit an RF field in excess of Health Canada limits for the general population; consult Safety Code 6, obtainable from the Health Canada's website <http://www.hc-sc.gc.ca>.

## **Compliance with RF energy exposure standards**

This two-way radio complies with these RF energy exposure standards and guidelines:

- United States Federal Communications Commission, Code of Federal Regulations; 47 CFR §§ 1.1307, 1.1310, and 2.1091.
- American National Standards Institute (ANSI) / Institute of Electrical and Electronic Engineers (IEEE) C95.1-1992.
- Institute of Electrical and Electronic Engineers (IEEE) C95.1-1999 Edition.



- European Directive 2004/40/EC on minimum health and safety requirements regarding the exposure of workers to the risks arising from physical agents (electromagnetic fields).

This radio complies with the IEEE and ICNIRP exposure limits for occupational/controlled RF exposure environments at operating duty factors of up to 50% talk to 50% listen.

## **Conformité aux normes d'exposition à l'énergie RF**

Cette radio émetteur-récepteur se conforme aux normes et aux règlements d'exposition à l'énergie RF :

- La Commission fédérale de la communication des Etats-Unis, Code de règlements fédéraux (CFR) Titre 47 Sections 1.1307, 1.1310 et 2.1091 (radios mobiles) ou 2.1093 (radios portatives).
- American National Standards Institute (ANSI) / Institute of Electrical and Electronic Engineers (IEEE) C95. 1-1992.
- Institute of Electrical and Electronic Engineers (IEEE) C95.1-1999 Edition.
- La directive européenne 2004/40/EC concernant les prescriptions minimales de sécurité et de santé relatives à l'exposition des travailleurs aux risques dus aux agents physiques (champs électromagnétiques).

Cette radio se conforme aux limites d'exposition de l'IEEE (FCC) et ICNIRP pour les environnements d'exposition au rayonnement RF professionnel et contrôlé aux cycles de marche de 50% en mode transmission et 50% en mode réception.

## Radio frequency emissions limits in the USA

Part 15 of the FCC Rules imposes RF emission limits on receivers. This radio complies with Part 15 of the FCC Rules. Operation is subject to the condition that this device does not cause harmful interference.

## Radio frequency emissions limits in the Canada

This device complies with Industry Canada licence exempt RSS standard(s). Operation is subject to the following two conditions: (1) this device may not cause interference, and (2) this device must accept any interference, including interference that may cause undesired operation of the device.

Le présent appareil est conforme aux CNR d'Industrie Canada applicables aux appareils radio exempts de licence. L'exploitation est autorisée aux deux conditions suivantes : (1) l'appareil ne doit pas produire de brouillage, et (2) l'utilisateur de l'appareil doit accepter tout brouillage radioélectrique subi, même si le brouillage est susceptible d'en compromettre le fonctionnement.

## USA public safety bands (764–776 MHz and 794–806 MHz)

The Code of Federal Regulations (CFR) Title 47 Subpart R deals with the use of frequencies in the 764 to 776 MHz and 794 to 806 MHz bands.

### Low-power channels

This radio complies with §90.531 (b) (3) and §90.531 (b) (4) of 47 CFR. These sections state that only low-power transmission is permitted on the following channels:

- Regional Planning channels, as defined in §90.531 (b) (3).

- Itinerant channels, as defined in §90.531 (b) (4).

## Use of encryption

This radio complies with §90.553 (a) of 47 CFR. This states that:

- Encryption is not permitted on the nationwide Interoperability calling channels. These channels are defined in §90.531 (b) (1) (ii).
- Radios using encryption must have a readily accessible switch or control to allow the radio user to disable encryption.

## EMC regulatory compliance in Australia

- 📍 N46 This product meets all ACMA regulatory requirements for electromagnetic compatibility (EMC). For more information about EMC compliance, visit the ACMA website at [www.acma.gov.au](http://www.acma.gov.au).

## Frequency band reserved for distress beacons

Frequency band 406 to 406.1 MHz is reserved for use by distress beacons. Transmissions should not be made within this frequency band.

## Health, safety and electromagnetic compatibility in Europe

In the European Community, radio and telecommunications equipment is regulated by Directive 1999/5/EC, also known as the Radio and Telecommunications Terminal Equipment (R&TTE) directive. The requirements of this directive include protection of health and safety of users, as well as electromagnetic compatibility.

## Intended purpose of product

This product is an FM radio transceiver. It is intended for radiocommunication in the Private Mobile Radio (PMR) or Public Access Mobile Radio (PAMR) services, to be used in all member states of the European Union (EU) and states within the European Economic Area (EEA).

## Restrictions

This product can be programmed to transmit on frequencies that are not harmonized throughout the EU/EEA, and will require a licence to operate in each member state.

This product can be programmed for frequencies or emissions that may make its use illegal. Where applicable, a license must be obtained before this product is used. All license requirements must be observed. Limitations may apply to transmitter power, operating frequency, channel spacing, and emission.

## Declaration of conformity

Brief Declarations of Conformity appear on [page 106](#) of this booklet. To download the formal declaration of conformity, go to [www.taitradio.com/eudoc](http://www.taitradio.com/eudoc).

## Interference with electronic devices



**Warning** Some electronic devices may be prone to malfunction due to the lack of protection from RF energy that is present when your radio is transmitting.

Examples of electronic devices that may be affected by RF energy are:

- aircraft electronic systems
- vehicular electronic systems such as fuel injection, anti-skid brakes, and cruise control
- medical devices such as pacemakers and hearing aids

- medical equipment in hospitals or health care facilities.

Switch off the radio before boarding an aircraft. Using your radio while in the air is not permitted.

Consult the manufacturer (or its representative) of any such electronic devices to determine whether electronic circuits in those devices will perform normally when the radio is transmitting.



**Warning** If you have a pacemaker, immediately turn off the radio if you suspect it is interfering with the pacemaker.

If there is interference between your hearing aid and the radio, please discuss an alternative solution with the hearing aid manufacturer.

## Potentially explosive atmospheres and blasting areas



**Warning** Unless the radio is specifically certified for use in a potentially explosive atmosphere, turn off the radio before entering such an atmosphere. An explosion could cause serious injury or death. Examples of potentially explosive atmospheres include filling stations, and any environment where there are flammable liquids, gases, or dusts.



**Warning** Turn off the radio before approaching blasting caps, a blasting area, or any area where you are instructed to turn off a two-way radio. Obey all signs and instructions. Interference with blasting operations could cause serious injury or death.

## Radio installation and operation in vehicles



**Warning** Keep the radio away from airbags and airbag deployment areas. Do not install, charge, or place a radio near such areas. An activated airbag can propel a portable radio with sufficient force to cause serious injury to vehicle occupants. An airbag

may not perform to specification if obstructed by a radio.



**Warning** To avoid damage to existing wiring, airbags, fuel tanks, fuel and brake lines, or battery cables, refer to the installation guide for the radio, and to the vehicle manufacturer's manual, before installing electronic equipment in the vehicle.

Using a handheld microphone or a radio while driving a vehicle may violate the laws and legislation that apply in your country or state. Please check the vehicle regulations in your area.

## Radio protection when charging the vehicle battery

Always remove the fuses from the radio power cable before charging the vehicle battery, connecting a second battery, or using power from another vehicle (e.g. when jump-starting the vehicle).

## Electromagnetic compatibility in European vehicles

In the European Community, radio equipment fitted to automotive vehicles is regulated by Directive 72/245/EEC and its amendments. The requirements of this directive cover the electromagnetic compatibility of electrical or electronic equipment fitted to automotive vehicles.

To meet the requirements of Directive 72/245/EEC and its amendments, installation of this product in a vehicle must be performed according to the instructions provided by the vehicle manufacturer

**Notice** Failure to install the product correctly may void the vehicle's type-approval. The owner could be held responsible for any damage resulting from vehicle failure that can be attributed to RF energy interfering with the vehicle systems.

# Unapproved modifications or changes to radio

The radio is designed to satisfy the applicable compliance regulations. Do not make modifications or changes to the radio that are not expressly approved by Tait. Failure to do so could invalidate compliance requirements and void the user's authority to operate the radio.

## High radio surface temperatures



**Caution** The bottom surface of the radio and the heatsink fins can become hot during prolonged operation. Do not touch these parts of the radio.

## EN 60950 requirements (25 watt mobiles)

This radio complies with the European Union standard EN 60950 when operated up to the rated 33% duty cycle of two minutes transmit and four minutes receive, and with ambient temperatures of 30°C or lower.



**Caution** Operation outside these limits may cause the external temperature of the radio to rise higher than this standard permits.

# Menu maps

This section shows the menus and submenus that may be programmed for your radio. Some features are controlled by software licenses and may not be available with your model.

## Main menu (trunked mode)

- Preset calls**
- Set zone**
- Set workgroup**
- Go to homegroup**
- Scanning**
- Send**
  - Status
  - Text message
    - Preset message
    - Edit message
    - New message
  - Dispatcher call
  - Broadcast call
    - Send group
    - Send to preset
    - Send to dialed
  - Conference call
    - Send group
    - Send to preset
    - Send to dialed
  - Priority call
    - Send dispatcher
    - Send to preset
    - Send to dialed
  - Emergency call
    - Send dispatcher
    - Send to preset
    - Send to dialed
- Workgroup setup\***
  - My Workgroups\*\*
  - Set homegroup
  - Subscribe all
  - Unsubscribe all

## Radio settings

- Functions
  - Scrambler
  - Lock radio
  - VOX
  - VOX sensitivity
- Call settings
  - Call queuing
  - Do not disturb
- Extra features
  - Lone worker
- Alert settings
  - External alert
  - Indicator level
  - Keypress tones
  - Quiet operation
  - Silent operation
- Display settings
  - Backlight level
  - Backlighting
  - Contrast adjust
  - Channel display
  - RSSI
- Radio info
  - Trunked ID
  - Key settings
  - Multi head info
  - Version info
  - Customer info
  - Serial number

## Call groups

## GPS info

## Change network

## Change mode

## Diagnostics

\*This menu item may appear as 'Group select'

\*\* This menu item may appear as 'Edit groups'.



## **Main menu (conventional mode)**

**Channels**

**Zones**

**Address book**

**Local calls**

**Set status**

**Dial radio call**

**Dial patch call**

**Radio settings**

Functions

Scrambler

Lock radio

Low power tx

Monitor

Squelch o'ride

VOX

VOX sensitivity

Repeater

Talkaround

Call settings

Ignore 2-tone

Extra features

Lone worker

Alert settings

External alert

Indicator level

Keypress tones

Quiet operation

Silent operation

Display settings

Backlight level

Backlighting

Contrast adjust

RSSI

Radio info

Key settings

Multi head info

Version info

Customer info

Serial number

**Advanced**

Program groups

Set scan key

**GPS info**

**Change mode**

# 1 About this guide

This user's guide provides information about TM9300 mobile radios.

The radio behavior described in this guide applies to radios with firmware version 1.02. To check the radio's firmware version, see "[Checking the version of your radio](#)" on page 104. If your radio does not operate as you expect, contact your radio provider for assistance.

## Safety warnings used in this guide

Please follow exactly any instruction that appears in the text as an 'alert'. An alert provides necessary safety information as well as instruction in the proper use of the product. This user's guide uses the following types of alert:



**Warning** This alert is used when there is a hazardous situation which, if not avoided, could result in death or serious injury.



**Caution** This alert is used when there is a hazardous situation which, if not avoided, could result in minor or moderate injury.

**Notice** This alert is used to highlight information that is required to ensure procedures are performed correctly. Incorrectly performed procedures could result in equipment damage or malfunction.



This icon is used to draw your attention to information that may improve your understanding of the equipment or procedure.

# Related documentation

The following documentation is also available for your Tait radio, which you can access from the Tait Technical Support website (<http://support.taitradio.com>):

- *Safety and Compliance Information*—supplied with each radio. (The same information is included in this user's guide.)
- *Installation Guide*—covers installing TM9300 mobile radios, microphones, antennas, emergency switches, and external alert devices.
- *Accessory installation instructions*—may be supplied with an accessory.

## 2 Getting started

This section gives an overview of your DMR radio, describes the radio's controls and indicators, and explains how the radio menus are organized.

### **This section covers:**

- [About DMR digital radios](#)
- [About the radio controls](#)
- [Understanding the radio display](#)
- [Understanding the radio indicators](#)
- [Using function keys to access frequently used features](#)
- [Navigating the radio's menus](#)
- [Using the alphanumeric keys to search a list](#)

# About DMR digital radios

Your digital radio may be programmed for DMR (digital) trunking, MPT (analog) trunking, or both (dual mode). Dual mode networks are able to receive both digital and analog calls. Fully-featured conventional analog operation is also available.

You may notice differences between digital and analog calls in terms of:

- static noise in low signal areas, and
- radio coverage in marginal reception areas.

## Lack of static noise

On digital networks there is no static noise, even in low signal areas. This lack of static is because your digital radio removes the 'noise' from the call, so that you hear only clear voice.

## Coverage

With digital networks, a call remains clear and then drops off quickly at the border of a coverage area. The reason for this is that a digital call is either received or it isn't. With analog networks, the background noise in a call gets progressively worse when you are in fringe areas or even slightly outside normal coverage areas.

# About the radio controls

The radio controls are the PTT key, volume control, on/off key, scroll keys, selection keys and function keys. Some keys have functions assigned to both short and long key presses:

- a short key press is less than one second, and
- a long key press is more than one second.

The radio controls and their functions are described in the following sections.

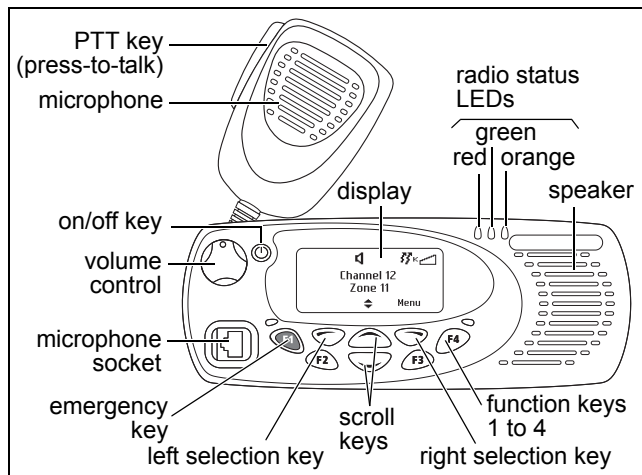

Name	Function
PTT key	Press and hold to transmit and release to listen
Volume control	Rotate to change the speaker volume
On/off key	Turn the radio on or off with a long press
Left and right selection keys	Action determined by the text above the selection key
Scroll keys	Scroll up and down through a list of menu options, scroll left and right in messages, or select the Quick Access menu
Emergency key	Activates emergency mode
Function keys	Programmed for frequently used options

# About the keypad microphone

Your radio may have a keypad microphone installed. The keypad microphone has a PTT key as well as alphanumeric keys, two scroll keys, and left and right selection keys.

The PTT key, the scroll keys and the selection keys all work in the same way as those on the radio control head (see ["About the radio controls"](#)).

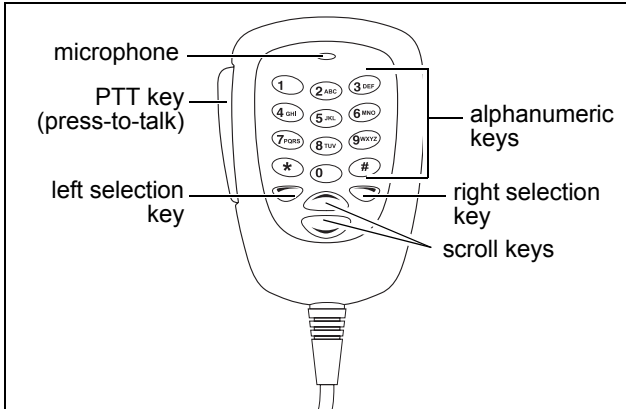

# About the hand-held control head

Your radio may have a hand-held control head installed, to enable you to operate the radio at a distance from the radio body.

The keys and controls work in the same way as those on the standard control head, with the exception of the PTT and volume up and down keys. The hand-held control head also has two additional function keys.

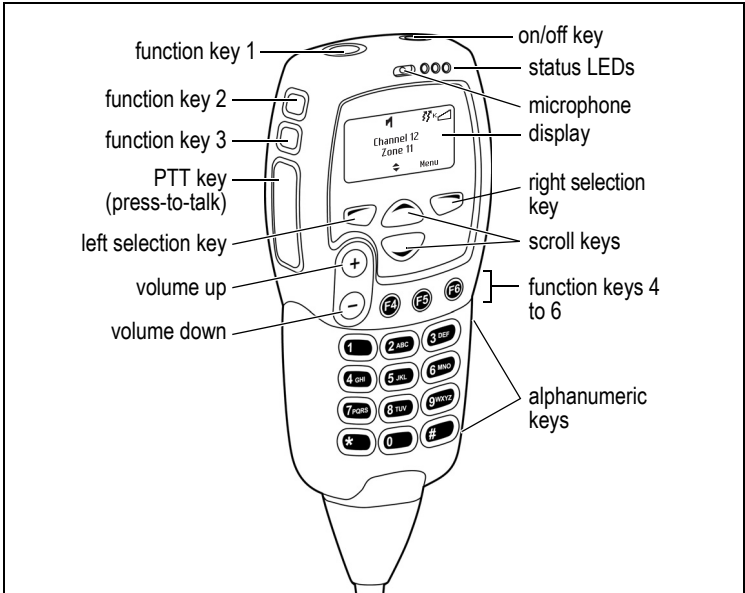























# Understanding the radio display

The messages and icons you see on your radio display depend on the mode in which your radio is operating and the way it is programmed.

## Radio display icons

These are some of the icons you may see on your radio display:

Icon	Meaning
	Scanning: your radio is monitoring a group of channels or workgroups for activity
	External alert: external alert is turned on
	Silent operation: your radio's audible tones have been turned off
	Low-power transmit: your radio is set to transmit on low power
	Transmit: your radio is transmitting
	Scrambler: the voice-inversion scrambler is turned on (analog channels only)
	Signal strength indicator: the more bars, the stronger the signal being received by the radio
	Scrolling: you can use  or  to move through a list, or access a Quick Reference menu
<b>Trunked mode icons</b>	
	Scanning: scanning has been turned off
	Homegroup: your radio has been returned to the homegroup using the homegroup toggle function key
	Call queuing: call queuing is turned on
	Call queuing: there are calls in the call queue
	Network: your radio is registered on a trunked network Flashing: your radio is attempting to register on a trunked network
	Trunking: your radio has established a call and you are now able to speak to the other party

Icon	Meaning
<b>Conventional mode icons</b>	
	Monitor or squelch override: monitor or squelch override is turned on
	Scanning: your radio is monitoring a group of channels for activity, and the currently selected channel is a member of the scan group.
	Repeater talkaround: your radio is operating in repeater talkaround mode, or you are on a simplex channel
	Text message: there is no text message in the call queue
	Text message: there is a text message in the call queue
K	Zone: this letter represents the zone in which your radio is operating, where A is zone 1, Z is zone 26 (for example, K represents zone 11)

# Understanding the radio indicators





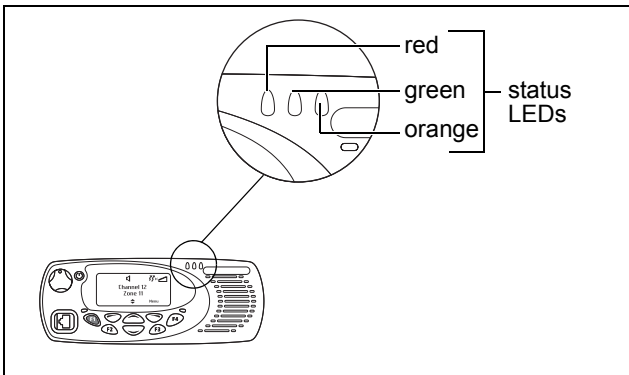

The status LED indicators and the radio's audible tones—together with the radio display—all combine to give you information about the state of your radio.

The most common way the indicators work is described in the following sections.

 The way these indicators behave may be affected by the way your radio is programmed.

## Status indicators



Color		Meaning
Red (transmit)		On: your radio is transmitting
		Flashing: your transmit timer is about to expire
Green (receive)		On: the current channel is busy
		Flashing: you have received a call or monitor is active
Orange (network)		Off: No service
		Flashing: Limited service (no inter-site or fixed network services are available)
		On: Full service For more information see <a href="#">"Checking that your network is available"</a> on page 38.

## Audible tones

The radio uses audible tones to alert you to its status:

- Radio controls and keypress tones—the tones and beeps you hear when you press your radio's keys or use the controls.
- Incoming call tone—when the radio is receiving a call.
- Warning tones—when there is an error.



**Warning** If quiet or silent mode is turned on, you will not hear any alert tones.

Some of the more common audible tones are described below:

Tone	Meaning
One short beep	<ul style="list-style-type: none"><li>■ Valid keypress: the action you have attempted is permitted</li><li>■ Function activated: a function has been turned on (using either the Main menu or a function key)</li></ul>
One long, low-pitched beep	<ul style="list-style-type: none"><li>■ Invalid keypress: the action you have attempted is not permitted</li><li>■ Transmission inhibited: you have attempted to transmit, but for some reason you cannot make a call at this time</li></ul>
One short, low-pitched beep	Function deactivated: a function has been turned off (using either the Main menu or a function key)
Two short beeps	Radio turned on: the radio is powered on and ready to use

# Using function keys to access frequently used features

The function keys provide access to some of the features you use most often. These features are assigned to the function keys when the radio is programmed. Some keys may have a feature associated with both a short key press and a long key press.

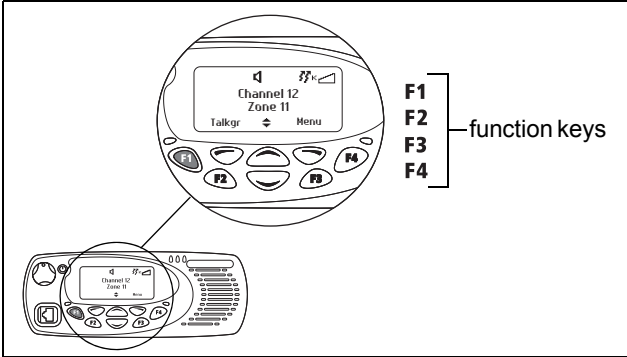

## Viewing the function key settings

Use the Main menu to check the features assigned to your radio's function keys:

- 1 Press **Menu** and select **Radio settings > Radio info > Key settings**.
- 2 In the Key Settings menu, scroll through the list of function keys.
- 3 Press **Select** to view details of the function associated with a particular function key.

The example shown is for a function key programmed to turn backlighting on and off.



- 4 Press **Back** to return to the Key Settings menu.

# Navigating the radio's menus

Your radio has a number of menus, each containing lists or submenus. The menus available depend on the way your radio is programmed.

## Using the Main menu

To access the Main menu, press the right selection key whenever **Menu** appears above it.

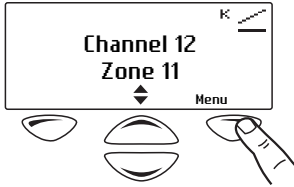

Use the scroll keys to move through the menu list.

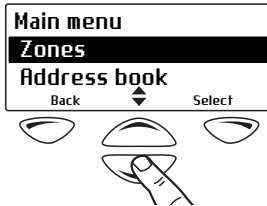

When the menu you want is highlighted, press **Select** to open the menu you have chosen.

-  To quickly exit the menu system, press and hold the left selection key when the word **Cancel** or **Back** appears above it.

# Accessing frequently used menus

Depending on how your radio is programmed, you may have two different Quick Access menus. One Quick Access menu is displayed when you press a scroll key, and the other when you press the left selection key. These give you easy access to the menus you use most often.

## Using the scroll key Quick Access menu

There are two ways to use this Quick Access menu:

- Use the scroll keys to scroll through a list of zones or channels.
- Press the scroll keys and the Quick Access menu appears.

In this example, the Channels menu is the Quick Access menu. Use the scroll keys to go directly to the Channels menu.

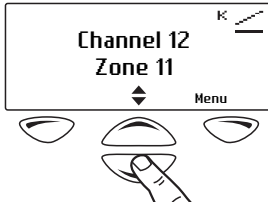

The Channels menu, with a list of your available channels, is now displayed.

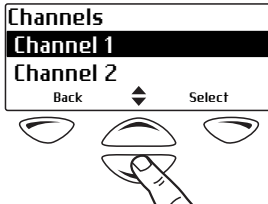

## Using the left selection key Quick Access menu

The text above the left selection key corresponds to the Quick Access menu, for example, Zones.

To use this Quick Access menu:

- Press the left selection key and the associated menu appears.

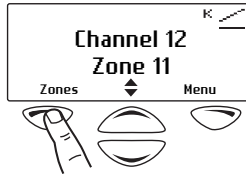

## Using the alphanumeric keys to search a list



This feature is only available for radios with alphanumeric keys.

If a blinking cursor appears when you select a list, you are able to search for the menu item you want using the alphanumeric keys. This is of particular benefit if you have a large number of items in a list.

Lists that you may be able to search are channels, zones, workgroups, and preset calls.

- To search a list, enter the required name using the keypad.



# 3 Basic operation

This section describes the basic operation of your radio.

**This section covers:**

- [Turning the radio on and off](#)
- [Adjusting the speaker volume](#)
- [Locking and unlocking the keypad](#)
- [Changing the radio's operating mode](#)

# Turning the radio on and off

Long press the on/off key to turn the radio either on or off.

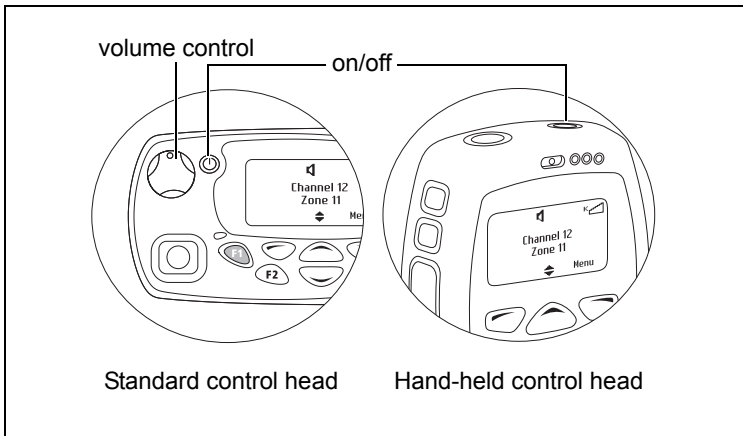

When the radio is first turned on, the red, green, and orange LEDs flash briefly, and the radio gives two short beeps. A brief message may appear on the display.

## Security lock on power-up feature

Your radio may be automatically locked each time it is powered-up. If the message **Enter PIN** appears on the display, enter your assigned PIN (personal identification number). See [“Unlocking the radio”](#) below.

### Locking the radio

- 1 Press **Menu** and select **Radio settings > Functions > Lock radio**. (Depending on how your radio is programmed, you may be able to press a function key to turn radio lock on and off.)
- 2 Scroll to either **On** or **Off** and press **Select**. (The current setting is highlighted.)

The radio is now locked, and the message **Enter PIN** appears on the display.

The radio remains locked until the correct sequence of keys is pressed. If you forget the unlock sequence or you do not know it, contact your radio provider for assistance.

### **Unlocking the radio**

- To unlock your radio, use the unlock sequence you have been given. (This is a pre-programmed sequence of four keys.)

## **Adjusting the speaker volume**

### **Standard control head**

Rotate the volume control clockwise to increase the speaker volume and counterclockwise to decrease the volume. The raised dot indicates the current volume setting.

### **Hand-held control head**

Press ⊕ to increase the speaker volume, and ⊖ to decrease the volume.

- ⓘ The volume control also changes the volume level of the radio's audible indicators.

# Locking and unlocking the keypad

The keypad lock feature prevents you from pressing a key accidentally. The number of keys that are locked depends on the way your radio is programmed.

If you receive a call while the keypad is locked, press any key to answer.

To lock the keypad:

- Press and hold the right selection key for about one second.

The message **Keypad locked** briefly appears on the display, and **Unlock** appears above the right selection key, in place of **Menu**.

When any of the locked keys are pressed, the message **Keypad lock active** appears.

To unlock the keypad:

- Press and hold the right selection key for about one second.

# Changing the radio's operating mode

The way your radio performs basic functions, such as sending and receiving calls, depends on the operating mode of your network. The two operating modes that may be available on your radio are:

- trunked mode (see ["Operating in trunked mode" on page 38](#)), and
- conventional mode (see ["Operating in conventional mode" on page 66](#)).

To change your operating mode:

- 1 Press **Menu** and select **Change mode**.

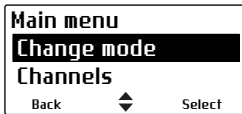

(Depending on how your radio is programmed, you may be able to press a function key to change mode.)

- 2 Select **Yes** to confirm your selection, and your radio now shows the default display for either trunked or conventional.

The following examples show typical default displays for trunked and conventional modes.



trunked mode

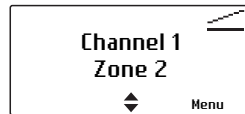

conventional mode

# 4 Operating in trunked mode

This section explains how your radio operates on a DMR (digital), MPT (analog) or dual-mode trunked network.



These features are controlled by software licenses (SFE) and may not be available with your radio.



Your radio must have trunking functionality programmed before it can operate in DMR or MPT trunked mode.

## **This section covers:**

- [Checking that your network is available](#)
- [Changing your network](#)
- [Making a preset call](#)
- [About trunked zones and workgroups](#)
- [About emergency operation](#)
- [Dialing a PABX number](#)
- [Dialing a PSTN number](#)
- [Receiving a call](#)
- [Re-establishing a call](#)
- [Checking missed calls](#)
- [About status messages](#)
- [About trunked text messages](#)
- [Placing the radio in do-not-disturb mode](#)
- [Calls to conventional channels or conventional groups](#)

# Checking that your network is available

Check that the orange LED is glowing and the network icon  appears in the display. These are the indications that your radio has access to a trunked network.

If the network icon is flashing and **No service** appears on the display, your radio is attempting to access the trunked network. If this icon remains flashing, your radio may be out of the network coverage area.

If **Limited service** appears on the display, one of the network sites or the connection between the network sites has been interrupted. You can still make calls to radios covered by the same site but not to radios to other sites.

## Changing your network

Your radio may be programmed to operate in up to four completely separate trunking networks, either DMR (digital), MPT (analog) or both (dual mode). You may wish to change networks because you are out of the network coverage area, or you need to have access to another trunking network.

To change your radio's operating network, you may be able to either use the Main menu or dial the new network using the alphanumeric keys.

 Changing your radio's workgroup may also change the network in which you are operating. See ["Selecting a workgroup" on page 43](#).

### Using the Main menu

- 1 Press **Menu** and select **Change network**.

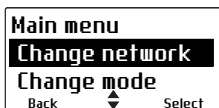

- 2 In the Change Network menu, scroll through the list of networks until the network you want appears.
- 3 Press **Select**.

The radio will restart and display the name of the new network.

## Dialing a new network



This feature is only available for radios with alphanumeric keys.

- 1 Dial **\*700#** to display the name of the current trunked network.
- 2 Dial **\*70n#** to change to a new network, where **n** is the number of the new network (1 to 4).

The radio will restart and display name of the new network.

## Making a preset call

The preset calls programmed for your radio may be to other radios, to PABX extensions or to PSTN numbers.

- 1 Press **Menu** and select **Preset calls**.



(Depending on how your radio is programmed, you may be able to use a function key, or left selection key to select the Preset Calls menu.)

- 2 In the Preset Calls menu, scroll through the list of calls until the call you want appears, then press **Send**.

While the call is being setup, you can cancel the call by pressing **Clear**.



## Dialing a preset call

 This feature is only available for radios with alphanumeric keys.

The preset calls programmed for your radio can be dialed if you know the number associated with the preset call.

- 1 Dial **p**, where **p** is the number of the preset call.

If your preset call number is the same as a call to another radio, then you need to dial a leading **0**.

For example, dial **23#** to call radio 23 and dial **023#** for preset call number 23.

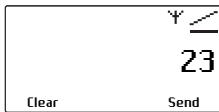

- 2 Press **Send** or the **#** or PTT key.

While the call is being setup, you can cancel the call by pressing **Clear**.

# About trunked zones and workgroups

Trunked zones and workgroups are used to manage the calls on the trunked system. Zones typically define geographic areas (towns, suburbs or counties), or branches of an organization. Workgroups span multiple zones, and typically define functions, work areas or job roles.

When your radio belongs to a workgroup, it is said to be 'subscribed', and you receive all calls directed to that group of users. A group's members are dynamic, in that a group only contains radios that are currently registered on the system and subscribed to the same group.



Your radio may be programmed to use different names for a 'zone' and 'workgroup'. For example, 'district' or 'area' may be used in place of zone, and 'role' or 'group' may be used in place of workgroup.

## Selecting a zone

- 1 Press **Menu** and select **Set zone**.

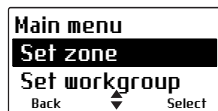

(Depending on how your radio is programmed, you may be able to use the scroll keys or left selection key to select a zone.)

- 2 In the Set Zone menu, scroll through the list of zones until the zone you want appears.
- 3 Press **Select**.
- 4 Check that orange LED is glowing and the network icon 'F' appears on the display.

## Selecting a workgroup

- 1 Press **Menu** and select **Set workgroup**.



(Depending on how your radio is programmed, you may be able to use the scroll keys or left selection key to select a workgroup.)

- 2 In the Set Workgroup menu, scroll through the list of workgroups until the workgroup you want appears.
- 3 Press **Select**.
- 4 Check that orange LED is glowing and the network icon  appears on the display.

## Making a call to a workgroup

Different types of calls may be associated with your workgroups. These calls can be individual calls, preset calls, broadcast calls (no response permitted), or conference calls.

To make a call to a workgroup:

- 1 Select the required zone. See ["Selecting a zone" on page 42](#).
- 2 Select the required workgroup. See ["Selecting a workgroup" on page 43](#).
- 3 Press the PTT key, and a call to that workgroup is made.

## Selecting the homegroup

Your 'homegroup' is the workgroup in which your radio usually operates. To return to your homegroup at any time, you may be able to use the main menu, or use a function key.

## Using the Main menu

- 1 Press **Menu** and select **Go to homegroup**.



- 2 Press **Select**, and the radio now shows your homegroup in the default display.

## Using a function key

You may be able to use a function key to toggle between your homegroup, and the currently selected zone and workgroup.

- Press the function key programmed for your homegroup.

The radio now shows your homegroup in the default display, along with the homegroup icon .



The homegroup icon only appears if you use a function key to select your homegroup.

## Scanning workgroups

The 'My Workgroups' list comprises the current workgroup, the homegroup, and other programmed groups. When scanning is active, the radio will receive activity from any subscribed groups in the My Workgroups list.

To activate scanning:

- 1 Press **Menu** and select **Scanning**.



(Depending on how your radio is programmed, you may be able to use a function key to select scanning.)

- 2 Scroll to **On** (or **Off**) and press **Select**.

# About emergency operation

In an emergency you may be able to summon help by sending an emergency call. After making the call, your radio may be programmed to enter emergency mode. While emergency mode is active, your radio may cycle between receive and transmit, so that your dispatcher or the called party can hear any activity near your radio.

On most networks, an emergency call takes precedence over other call types, and existing calls are cleared down so that the emergency call can proceed.

To make an emergency call from your radio, you may be able to either:

- make a preset emergency call,
- dial the emergency call using the alphanumeric keys, or
- use a function key programmed for emergency mode.

## Making a preset emergency call

To make a preset emergency call from your radio, you may be able to either use a programmed function key, use the main menu, or use your quick access menu.

- 1 Select your preset emergency call.

See ["Making a preset call" on page 40](#).

- 2 Press **Send**.



An emergency call is now sent to the emergency location that has been programmed for your radio.

## Dialing an emergency call

 This feature is only available for radios with alphanumeric keys.

- 1 Dial \*9.
- 2 Press Send or the  or PTT key.

An emergency call is now sent to the emergency location that has been programmed for your radio.

 If you wish to send an emergency call to another radio, you may be able to dial \*9\*n then press the  or PTT key. In this case, **n** is the radio unit number you wish to send the emergency call to and may be a two- or three-digit number.

## Activating emergency mode

You can activate emergency mode using a function key programmed for emergency mode. Alternatively, you may be able to activate emergency mode using a hidden switch or panic button. Once emergency mode is activated, your radio makes an emergency call to your dispatcher or some other predetermined location. The radio then enters emergency mode.

While emergency mode is active, your radio may cycle between receive and transmit, so that your dispatcher can hear any activity near the radio.

## Cancelling emergency mode

Reset the radio to normal operation at any time by turning the radio off and then on.

 Emergency mode may be programmed to end after a fixed period of time. In this case, there is no need to turn the radio off and then on in order to return the radio to normal operation.

# Dialing a PABX number

 This feature is only available for radios with alphanumeric keys.

To dial a PABX extension:

- 1 Dial **n**, where **n** is the PABX extension you wish to call.
- 2 Press **Send** or the  or PTT key.

The call details appear on the display. While the call is being setup, you can cancel the call by pressing Clear.

# Dialing a PSTN number

 This feature is only available for radios with alphanumeric keys.

To dial a PSTN number:

- 1 Dial **0n**, where **n** is the PSTN number you wish to call.

 The numbers you dial before the 0 depend on the way your network operates.

- 2 Press **Send** or the  or PTT key.

The call details appear on the display. While the call is being setup, you can cancel the call by pressing Clear.

# Receiving a call

When you receive a call, your radio displays the caller's identity and responds in one of two ways, depending on the way it was programmed and the way your network operates.

- On-air call setup: The radio gives a ring and automatically accepts the call. The  icon appears in the display.
- Full off-air call setup (FOACSU): When a call is received, the radio rings like a telephone.

To accept the call, press **Answer**. The radio gives a beep and the  icon appears in the display. You may also be able to accept the call if you briefly press the PTT key or lift the microphone off the microphone clip.

Once the  icon appears, you can proceed with the call, as follows:

- 1 Hold the microphone about 5 cm (2 inches) from your mouth.
- 2 Press and hold the PTT key to transmit.
- 3 Speak clearly into the microphone and release the PTT key when you have finished talking.

While you are transmitting, the red LED glows and  appears in the display.

- 4 End the call by placing your microphone back onto its hook or by pressing Clear. The network may also end the call if neither you nor the other party transmits for a predetermined time or if your call time limit is exceeded.

## Call time limit

In trunked mode, the length of your call may be limited by the network or by your radio. Your radio may be programmed to display the time remaining for your call.



# Re-establishing a call

The last number recall, unanswered call and callback functions allow you to re-establish calls using the PTT key.

## Last number recall

When an outgoing call has ended, the message **Last call to** and the called unit's identity may appear on the display.

To make a call to that person again, briefly press the PTT key.

## Unanswered call

When an incoming call is missed, the message **Missed call** and the caller's identity may appear in the display.

To return the call, briefly press the PTT key.

## Callback

When an incoming call has been ended, the message **Last call from** and the caller's identity may appear in the display.

To make a call to that person, briefly press the PTT key.

# Checking missed calls

If you have missed an incoming call, it may be stored in the call queue, so that you can return the call later. Information about the last missed call is shown on the display and the queued call icon  appears.

In the example below, the last call received was a status message from Car 1. This call is the first of three calls stored in the call queue.

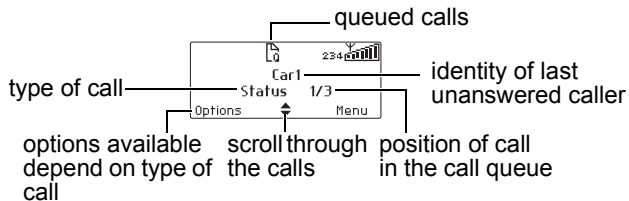

## Accessing the call queue

- 1 Use the scroll keys to move through the calls in the call queue until the call you want appears.
- 2 Press **Options** to open the call options menu.

The options available for the call depend on the type of call it is. If the call is a voice call, select **Call** to return the call or **Delete** to delete the call.

If the call is a status message or a text message, then select **View** to read the message.

## Changing your call queuing setting

Your radio may be programmed so that you are able to change call queuing to 'unanswered'. Unanswered call queuing means that all status and text messages are immediately queued. Incoming voice calls are only queued if they are unanswered.

If your radio has alphanumeric keys, you may be able to change your call queuing setting using the keypad.

To activate call queuing:

- press **Menu** and select **Radio settings > Call settings > Call queuing** and choose **On**,
- press the function key programmed for Call queuing, or
- dial **\*48** then press the **#** or PTT key.

The message **Call queuing activated** appears.

To change call queuing to unanswered call queuing:

- press **Menu** and select **Radio settings > Call settings > Call queuing** and choose **Off**,
- press the function key programmed for Call queuing, or
- dial **#48** then press the **#** or PTT key.

The message **Call queuing deactivated** appears.

# About status messages

A status message is sent to another party to indicate your current activity or location, such as “en route” or “at lunch”. If the radio receiving your message has been programmed with the same status messages, it will decode and display your message. If you receive a status message, the message is automatically queued, since a response is not expected.

## Selecting a status message

- 1 Press **Menu** and select **Send > Status**.
- 2 In the Status menu, scroll through the list of status messages until the message you want appears.

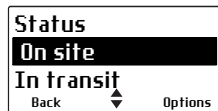

## Sending a status message

- 1 When you have chosen a message, press **Options** and the Send To menu opens.
- 2 In the Send To menu, scroll through the list of options until the choice you want appears.



If your radio has alphanumeric keys, you can choose the option **Dialed**, then dial the number of the party you wish to call.

- 3 Press **Send**.

The call details appear on the display. While the call is being setup, you can cancel the call by pressing Clear.

## Dialing a status message

If your radio has alphanumeric keys, the status messages programmed for your radio can be dialed. To dial the message, you need to know the number associated with the status message.

To dial a status message:

- 1 Dial **\*0s\*n**, where **s** is the number of the status message and **n** is the radio unit number you wish to send the message to.
- 2 Alternatively, dial **\*0s\*p**, where **p** is the number of a preset call. See ["Dialing a preset call" on page 41](#) for more information.
- 3 Press **Send** or the **#** or PTT key.

The call details appear on the display. While the call is being setup, you can cancel the call by pressing Clear.

# About trunked text messages

Your radio may be programmed so that you can send text messages. The three options for creating text messages are selecting a preset text message, editing a draft text message, or creating a new text message.











 To either edit or enter a text message, your radio must have alphanumeric keys.

## Using the alphanumeric keys to enter text

When the alphanumeric keys are used to enter a text message, they have special functions.

- Use the **#** key to select the type of text entry: upper and lower case characters (**ABC**, **abc**), initial capitals (**Abc**), or numbers (**123**).
- Use the left selection key (**Clear**) to delete a character from the display.
- Use the scroll keys to move through a message.

Repeated presses of these keys will give you the characters shown in the following table.

Key	Characters	Key	Characters
	. , ? ! - / 1		P Q R S 7
	A B C 2		T U V 8
	D E F 3		W X Y Z 9
	G H I 4		space 0
	J K L 5		
	M N O 6		

In the example below, a preset text message has been selected, and is being edited.

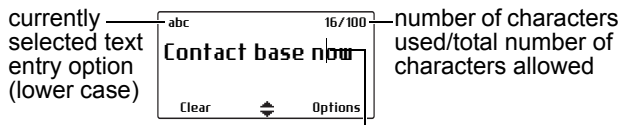

cursor: shows current point of text entry

## Sending a preset text message

- 1 Press **Menu** and select **Send > Text message > Preset message**.



In the Preset Message menu, a short label representing each message is displayed.

- 2 Scroll through the list of preset message labels until the one you want appears.



- 3 Press **Select**, and the text message you have chosen is now displayed.

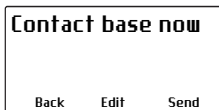

- 4 Press **Send** to send the message, or **Edit** to change the message.

## Editing a draft text message

- 1 Press **Menu** and select **Send > Text message > Edit message**.

In the Edit Message menu, a short label representing a message is displayed.

- 2 Use the scroll keys to move through the characters. Use the alphanumeric keys to add characters and the **Clear** key to delete them.



- 3 When the message is complete, press **Options** and select **Send**.

## Creating a new text message

- 1 Press **Menu** and select **Send > Text message > New message**.

The last text message you sent may be displayed.

- 2 In the New Message menu, modify the last text message you sent, or enter the new text message using the alphanumeric keys.
- 3 When the message is complete, press **Options** and select **Send**.

## Sending a text message

- 1 When you have chosen or entered a message, press **Options** and the Text Options menu opens.

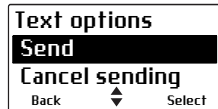

- 2 In the Text Options menu, scroll through the list of options until the choice you want appears.

(If your radio has alphanumeric keys, you may be able to dial the number of the party you wish to call.)

- 3 Press **Select**.

The call details appear on the display. While the call is being setup, you can cancel the call by pressing **Clear**.



# Placing the radio in do-not-disturb mode

If you do not want calls for a while, you can place the radio in do-not-disturb mode, so that incoming calls can be ignored. You can make outgoing calls in the usual way.

 While do-not-disturb mode is active, incoming calls cannot be stored in the call queue.

## Using a function key

- 1 Press the function key programmed for do not disturb, to activate the do-not-disturb function.

The message **Do not disturb activated** appears on the display. Your radio will now ignore all incoming calls.

- 2 To deactivate the do-not-disturb function, press the do-not-disturb function key again.

The message **Do not disturb deactivated** appears on the display.

## Using the Main menu

- 1 Press **Menu** and select **Radio Settings > Call Settings > Do not disturb**.
- 2 In the Do Not Disturb menu, choose **On**.
- 3 Press **Select**.

The message **Do not disturb activated** appears on the display. Your radio will now ignore all incoming calls.

# Calls to conventional channels or conventional groups

You may be able to dial conventional channels or groups, using **101** to **110**. The channels or groups called using these numbers are programmed for your radio.

To call a conventional channel or group:

- 1 Dial the number for the channel or group you wish to call.
- 2 Press **Send** or the  or PTT key.

Your radio switches to the conventional channel programmed for that number.

# 5 Dialing calls in trunked mode

If your radio has alphanumeric keys, you can make dialed calls from your radio. The numbers you dial and dialing features available depend on the way your radio is programmed and the way your network operates. Contact your radio provider for further assistance.

## **This section covers:**

- [MPT 1343 dialing](#)
- [Nokia ANN fleet calls](#)
- [Accessing common trunking functions](#)

# MPT 1343 dialing

If your MPT or DMR trunked network uses the MPT 1343 dialing scheme, your radio's unique number on the network consists of:

- a three-digit prefix,
- a four-digit fleet number, and
- a two- or three-digit radio unit number.

You may also be part of a group, with a two- or three-digit group number.

## Finding your radio's MPT number

To find your radio's full MPT number:

- 1 Dial **\*700**.
- 2 Press the **#** or PTT key.

The name associated with your network and your radio's full MPT number appears.

The number is in the form:

Prefix 300	Fleet 3078	Radio unit number 234
---------------	---------------	--------------------------

# MPT 1343 dialed calls

The following table summarizes the way you dial calls to other radios and groups of radios and gives an example of each type of call.

 In the following examples, the final # may be replaced by a short press of the PTT key.

Call to	Dialing code and example			
Radio <b>23</b> in the same fleet as you	Radio unit number 23		#	
Radio <b>234</b> in the same fleet as you	Radio unit number 234		#	
Radio <b>23</b> in fleet <b>3078</b> with the same prefix as you	Fleet 3078	Radio unit number 23	#	
Radio <b>234</b> in fleet <b>3078</b> with the same prefix as you	Fleet 3078	Radio unit number 234	#	
Radio <b>234</b> in fleet <b>3078</b> with a different prefix to you ( <b>300</b> )	Prefix 300	Fleet 3078	Radio unit number 234	#
Group <b>92</b> in the same fleet as you	Group 92		#	
Group <b>923</b> in the same fleet as you	Group 923		#	

# Nokia ANN fleet calls

If your trunked network uses Nokia ANN dialing, the numbers you dial depend on your fleet size. Fleets are defined as either large, small or mini. Your radio's unique number on the network consists of:

- a lead number **7**, **8** or **9**, depending on the fleet size,
- a zero-, one-, two- or three-digit prefix,
- a one- or two-digit fleet number, and
- a two- or three-digit radio unit number.

See your radio provider or network administrator for Nokia ANN call details.

## Finding your radio's Nokia ANN number

To find your radio's full Nokia ANN number:

- 1** Dial **\*700**.
- 2** Press the **#** or PTT key.

The name associated with your network and your radio's full Nokia ANN number appears.

The number is in the form:

Lead 7	Prefix 34	Fleet 2	Radio unit number 209
-----------	--------------	------------	--------------------------

# Nokia ANN dialed calls

The following table summarizes the way you dial calls to other radios and gives an example of each type of call.

 In the following examples, the final # may be replaced by a short press of the PTT key.

Call to	Dialing code and example
Radio <b>23</b> in the same fleet as you	Radio unit number 23 #
Group <b>923</b> in the same fleet as you	Group 923 #
<b>Large fleet:</b>	
Call to radio <b>234</b> in fleet <b>1</b> with the same prefix as you	Lead 7 Fleet 1 Radio unit number 234 #
Call to radio <b>235</b> in fleet <b>2</b> with a different prefix to you ( <b>32</b> )	Lead 7 Prefix 32 Fleet 2 Radio unit number 235 #
Call to radio <b>236</b> in fleet <b>2</b> with the same lead and prefix <sup>1</sup>	Fleet 2 Radio unit number 236 #
<b>Small fleet:</b>	
Call to radio <b>23</b> in fleet <b>51</b> with the same prefix as you	Lead 7 Fleet 51 Radio unit number 23 #
Call to radio <b>24</b> in fleet <b>52</b> with a different prefix to you ( <b>126</b> )	Lead 7 Prefix 126 Fleet 52 Radio unit number 24 #
Call to radio <b>25</b> in fleet <b>53</b> with the same lead and prefix <sup>1</sup>	Fleet 53 Radio unit number 25 #
<b>Mini fleet:</b>	
Call to radio <b>23</b> in fleet <b>80</b> with the same prefix as you	Lead 7, 8 or 9 Fleet 80 Radio unit number 23 #
Call to radio <b>24</b> in fleet <b>81</b> with a different prefix to you ( <b>3</b> )	Lead 7, 8 or 9 Prefix 3 Fleet 81 Radio unit number 24 #
Call to radio <b>25</b> in fleet <b>81</b> with the same lead and prefix <sup>1</sup>	Fleet 81 Radio unit number 25 #

1. If 4-digit-dialing is configured in the programming application.

# Accessing common trunking functions

The following tables explain how you can access special MPT or DMR trunking functions using the \* and # keys. The availability of these functions is dependant on the way your radio is programmed and the way your network operates.



In the following examples, the final # may be replaced by a short press of the PTT key.

## \*... # functions

Dialing code	Functions	Example
#	Accept an incoming FOACSU call	
*#	Clear call or displayed item, or decline an incoming FOACSU call	
*0#	Request base dispatcher to call you back	
#0#	Cancel request	
*0*n#	Request another dispatcher to call you back	*0*234#
#0*n#	Cancel request	#0*234#
*0s*n#	Status call to radio <b>n</b> ( <b>s</b> = status 0 to 31, MPT, or 0 to 127, DMR)	*015*23#
*0s#	Status call to dispatcher	*015#
g#	Conference call to group <b>g</b>	92#
*11*g#	Broadcast call to group <b>g</b>	*11*92#
*41*n#	Divert own calls to radio <b>n</b>	*41*23#
#41#	Cancel divert	
*41*0n#	Divert own calls to PSTN <b>n</b>	*41*03456798#
#41#	Cancel divert	
*44*n*m# <sup>1</sup>	Divert 3rd party calls <b>n</b> to <b>m</b>	*44*23*21#
44*n# <sup>1</sup>	Cancel divert of 3rd party calls	#44*23#
*441*m#	Divert of speech calls to <b>m</b>	*441*21#
#441#	Cancel divert of speech calls	#441#
*442*m#	Divert of packet data calls to <b>m</b>	*441*21#
#442#	Cancel divert of packet data calls	#441#
*451#	Cancel incoming call diversions (speech only)	
*452#	Cancel incoming call diversions (packet data only)	
*453# <sup>2</sup>	Cancel incoming call diversions (SDM only)	
*454# <sup>2</sup>	Cancel incoming call diversions (status only)	
*48#	Queue incoming calls	
#48#	Cancel queue	



**\* ... # functions**

Dialing code	Functions	Example
<b>*49#</b>	Do not disturb	
<b>#49#</b>	Cancel do not disturb	
<b>*491#</b>	DMR: Do not disturb (SDM calls) MPT: Do not disturb (voice calls only)	
<b>#491#</b>	DMR: Cancel do not disturb (SDM calls) MPT: Cancel do not disturb (voice calls only)	
<b>*492#</b>	Do not disturb—data calls only	
<b>#492#</b>	Cancel do not disturb—data calls only	
<b>*50*n#</b>	Select channel <b>n</b> (site-select diagnostic function, enabled during programming)	
<b>#50#</b>	Resume normal channel hunting (site-select diagnostic function, enabled during programming)	
<b>*700#</b>	Display the current network and your full radio number	
<b>*70n#</b>	Change to network <b>n</b> (1 to 4)	<b>*702#</b>
<b>*8*n#</b> <sup>3</sup>	Priority call (highest) to radio <b>n</b>	<b>*8*23#</b>
<b>*8*g#</b> <sup>3</sup>	Priority conference call (highest) to group <b>g</b>	<b>*8*923#</b>
<b>*81*n#</b> <sup>3</sup>	Priority call (highest) to radio <b>n</b>	<b>*81*23#</b>
<b>*81*g#</b> <sup>3</sup>	Priority conference call (highest) to group <b>g</b>	<b>*81*923#</b>
<b>*82*n#</b> <sup>3</sup>	Priority call (high) to radio <b>n</b>	<b>*82*23#</b>
<b>*82*g#</b> <sup>3</sup>	Priority conference call (high) to group <b>g</b>	<b>*82*923#</b>
<b>*83*n#</b> <sup>3</sup>	Priority call (medium) to radio <b>n</b>	<b>*83*23#</b>
<b>*83*g#</b> <sup>3</sup>	Priority conference call (medium) to group <b>g</b>	<b>*83*923#</b>
<b>*9*n#</b>	Emergency call to radio <b>n</b>	<b>*9*23#</b>
<b>*9*g#</b>	Emergency conference call to group <b>g</b>	<b>*9*923#</b>
<b>**n#</b>	Abbreviated dialed codes (1-49) (MPT only)	<b>**3#</b>

1. MPT only.
2. DMR only.
3. DMR has three priority levels and MPT has one priority level.  
\*8 and \*81 are interchangeable. Dialing \*82 or \*83 in MPT mode has the same effect as dialing \*8 or \*81.

# 6 Operating in conventional mode

This section explains how to operate your radio on a conventional network. This includes how to make and receive different types of calls, use your radio in different repeater areas, and scan a group of channels for activity.

## **This section covers:**

- [Selecting a zone](#)
- [Selecting a channel](#)
- [Selecting a group](#)
- [Checking that a channel is clear](#)
- [Making a call](#)
- [Making a call using the address book](#)
- [Making a local call](#)
- [Connecting to a telephone network](#)
- [Making an emergency call](#)
- [Sending a status message](#)
- [Transmitting at low power](#)
- [Ending active calls](#)
- [Activating the repeater before a call](#)
- [Communicating directly with other radios](#)
- [Receiving a call](#)
- [Hearing faint and noisy signals](#)
- [Using the radio in different repeater areas](#)
- [Scanning a group of channels](#)

# Selecting a zone

A zone is a collection of channels and groups. When you select a zone, only the channels and groups assigned to that zone are available.

- 1 Press **Menu** and select **Zones**.



(Depending on how your radio is programmed, you may be able to use the scroll keys or left selection key to select the Zones menu.)

- 2 In the Zones menu, scroll through the list of zones until the one you want appears.

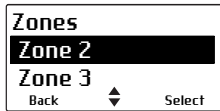

- 3 Press **Select**, and the zone indication appears either below the channel information, beside the RSSI icon, or in both positions.

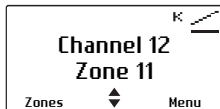

# Selecting a channel

- 1 Press **Menu** and select **Channels**.



(Depending on how your radio is programmed, you may be able to use the scroll keys or left selection key to select the Channels menu.)

- 2 In the Channels menu, scroll through the list of channels until the channel you want appears.

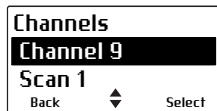

- 3 Press **Select**, and the programmed channel is now shown on the display.

## Dialing a channel



This feature is only available for radios with alphanumeric keys.

- 1 Dial the number associated with the channel using the alphanumeric keys.



- 2 Press **Select**, and the programmed channel is now shown on the display.

# Selecting a group

A group is a collection of channels that are grouped together for either scanning or voting. In the Channels menu, the group is shown as being a single channel item, e.g. "Scan1".

The sections ["Using the radio in different repeater areas" on page 83](#) and ["Scanning a group of channels" on page 84](#) explain how your radio operates once a scan group or voting group has been selected.

## Using the Main menu

- 1 Press **Menu** and select **Channels**.



(Depending on how your radio is programmed, you may be able to use a function key, the scroll keys or left selection key to select a group.)

- 2 In the Channels menu, scroll through the list of channels and groups until the group you want appears.

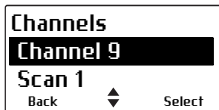

- 3 Press **Select**, and the programmed group is now shown on the display. The orange LED glows and the scanning icon  appears on the display.

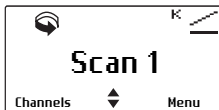

## Dialing a group

-  This feature is only available for radios with alphanumeric keys.

To dial the group number from the default display:

- 1 Dial the number associated with the group using the alphanumeric keys.



- 2 Press **Select**, and the programmed group is now shown on the display. The orange LED glows and the scanning icon  appears on the display.

## Checking that a channel is clear

Monitor allows you to override some or all of the radio's mutes, and hear if there is any traffic on a channel. For analog channels, this is so that you can check that the channel is clear before you make a call.

-  Your radio may be programmed to activate monitor whenever the microphone is off the microphone clip.

### Turning monitor on and off

- 1 Press **Menu** and select **Radio settings** > **Functions** > **Monitor**.

(Depending on how your radio is programmed, you may be able to press a function key to toggle monitor on and off.)

- 2 Scroll to **On** (or **Off**) and press **Select**.

While monitor is on, the green LED flashes slowly and the monitor icon  appears in the display.

-  Your radio may be programmed so that monitor turns off automatically after a short time.

# Making a call

- 1 Select the required channel or scan group.
  -  You may need to select the zone you want first, then select the channel or group from that zone.
- 2 Check that the channel is clear. If the green LED is glowing, the channel is busy and you may not be able to transmit.
- 3 Once the channel is clear (the green LED is off), lift the microphone off the microphone clip.
- 4 Hold the microphone about 5 cm (2 inches) from your mouth.
- 5 Press and hold the PTT key to transmit.
- 6 Speak clearly into the microphone and release the PTT key when you have finished talking.

While you are transmitting, the red LED glows and the transmit icon  appears on the display.

## Limiting call time

Your radio may limit the amount of time you can talk (transmit) continuously. This is known as the 'transmit timer' or 'time-out timer' and allows other radio users to make calls on that channel.

The radio warns you before the transmit timer expires by beeping three times. The red status LED flashes and the message **Transmit timeout imminent** appears in the display.

If the transmit timer has timed out, you must release the PTT before you can transmit again.

-  Your radio may be unable to transmit for a short time after the transmit timer has expired.

# Making a call using the address book

The Address Book menu has a programmed list of calls, which can be made from any channel or zone. Address-book calls may also be used to send status information, such as “at lunch” or “on site”, or to change to a channel or group.

## Using the Main menu

- 1 Press **Menu** and select **Address book**.



(Depending on how your radio is programmed, you may be able to use the scroll keys, left selection key or a function key to select the Address Book menu.)

- 2 In the Address Book menu, scroll through the list of calls until the call you want appears.
- 3 Press **Send**.

The call details appear on the display, the red LED glows, and  appears on the display.



# Making a local call

Each channel on your radio may have one or more local calls programmed.

## Using the Main menu

- 1 Select the required channel.
- 2 Press **Menu** and select **Local calls**.

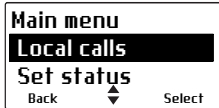

- 3 In the Local Calls menu, scroll through the list of local calls until the call you want appears.
- 4 Press **Send**.

The call details appear on the display, the red LED glows, and  appears on the display.

## Using the Quick Access menu

- 1 Select the required channel.
- 2 Press one of the scroll keys or the left selection key to open the Local Calls menu.
- 3 Scroll through the list of local calls until the call you want appears.
- 4 Press **Send**.

The call details appear on the display, the red LED glows, and  appears on the display.

## Dialing a local call



This feature is only available for radios with alphanumeric keys.

To make a local call to another radio or group of radios:

- 1 Select the required channel.
- 2 Press **Menu** and select **Dial radio call**.

Alternatively, your radio may be programmed so a local call can be dialed directly from the default display. In this case, you can start dialing the call without selecting the menu option.

A series of **X** and **S** characters may appear, prompting you to dial over them.

**3** Dial the number using the alphanumeric keys.



Your radio may be programmed so you can dial group tones using the \* and # keys. Dial \* to fill one **X**. Dial # to fill the current **X** and all subsequent **X** characters in the current burst.

**4** Press **Send** (if the Send option appears).

The call details appear on the display, the red LED glows, and  appears on the display.

When the called party receives your call, the message **Ack received** may appear on the display.

## Connecting to a telephone network

You may be able to use your radio to connect to a telephone network. This type of call is known as a DTMF patch call.

To make a DTMF patch call, you may be able to either:

- use a programmed function key,
- use the Main menu to dial the call,
- make a local call (see ["Making a local call" on page 73](#)), or
- use your address book (see ["Making a call using the address book" on page 72](#)).

## Using a function key

 Depending on how DTMF patch calls are programmed, some or the following steps may not be necessary.

- 1 Select the required channel.
- 2 Press the function key programmed for DTMF patch call.  
Your radio may send tones to capture the line.
- 3 Press **Send**, or press the function key a second time, to send the preset number.  
You may hear telephone dialing and ringing tones.
- 4 Proceed with your call.
- 5 Press **End**, or give a long press on the function key, to end the call.  
Your radio may send tones to release the line.

## Using the Main menu

 This feature is only available for radios with alphanumeric keys.

To dial a DTMF patch call by using the Main menu:

 Depending on how DTMF patch calls are programmed, some or the following steps may not be necessary.

- 1 Select the required channel.
- 2 Press **Menu** and select **Dial patch call**.
- 3 Dial the required number using the alphanumeric keys.
- 4 Press **Send**.  
Your radio may send tones to capture the line.
- 5 Press **Send** to send the number dialed in step 3.  
You may hear telephone dialing and ringing tones.
- 6 Proceed with your call.

- 7 Once the call has finished, press **End**.

Your radio may send tones to release the line.

## Making an emergency call

You may be able to activate emergency mode by using a programmed function key.

- 1 Press the function key programmed for Emergency Mode and an emergency call is sent to your dispatcher, or some other predetermined location.

While emergency mode is active, your radio may cycle between receive and transmit, so that your dispatcher can hear any activity near the radio. Alternatively, your radio may appear to turn off but will actually remain in emergency mode.

- 2 Reset the radio to normal operation at any time by turning the radio off and then on.



Emergency mode may be programmed to end after a fixed period of time. In this case, there is no need to turn the radio off and then on in order to return the radio to normal operation.

## Sending a status message

Your radio may be able to maintain a record of your current status. This status may be sent with outgoing calls programmed to contain status information. If the radio receiving your message has been programmed with the same status messages, it will decode and display your message. The message indicates your current activity or location, such as “en route” or “at lunch”.

To change your current status:

- 1 Press **Menu** and select **Set status**.



- 2 In the Set Status menu, scroll through the list of status messages until the message you want appears.
- 3 Press **Select**. The message **Status updated** appears on the display.

## Transmitting at low power

If you are using your radio in conditions where signal strength is high, you can reduce the drain on your vehicle battery by transmitting at low power.

When low power transmit is turned on,  appears in the display and calls are made at low power rather than at the programmed power setting.

Some channels may always transmit at low power.

To turn low power transmit on or off for all channels:

### Using the Main Menu

- 1 Press **Menu** and select **Radio settings > Functions > Low power tx**.

(Depending on how your radio is programmed, you may be able to press a function key to turn low power transmit on or off.)

- 2 Scroll to **On** (or **Off**) and press **Select**. (The current setting is highlighted.)

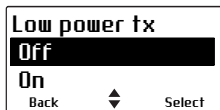

The message **Low power tx activated** (or **deactivated**) appears in the display.

## Using a function key

- 1 Press the function key programmed for low-power transmit to transmit at low power on your current channel.

The message **Low power tx activated** appears briefly, and the low-power transmit icon  appears on the display.

- 2 Press the low-power transmit function key again to turn low-power transmit off, and the message **Low power tx deactivated** appears on the display.

## Ending active calls

You may have a function key programmed to either end the current call, or end the current call and all other active calls in your group. This can be done either by:

- using the function key programmed for reset monitor to end your current call,
- using the function key programmed for call cleardown to end your current call and all other calls in your group, or
- using the function key programmed for both reset monitor and call cleardown.

### Using a function key to end your current call

- Press the function key programmed for reset monitor. The radio's monitor is turned off, ending your current call.

The green LED stops flashing, and the monitor icon  disappears from the display.

### Using a function key to end all active calls

- Press the function key programmed for call cleardown and monitor is turned off for all radios in your radio group.

The green LED stops flashing, and the monitor icon  disappears from the display.

### **Using the function key programmed for reset monitor/call cleardown to end active calls**

The function key programmed for reset monitor may be programmed so that a short key press ends your current call, and a long key press ends all active calls in your group.

## **Activating the repeater before a call**

A repeater-access tone is sent to activate the repeater before a call is made, so that the start of the call is not lost.

To send a repeater-access tone, you may be able to either use the PTT key, or use a programmed function key.

### **Using the PTT key**

- 1 Press the PTT key and the repeater-access tone for the current channel is sent.

The call details appear on the display, the red LED glows, and  appears on the display. You may also hear signaling tones.

- 2 Press and hold the PTT and proceed with your call.

### **Using a function key**

- 1 Press the function key programmed for sending a repeater-access tone, and the repeater-access tone for the current channel is sent.

The call details appear on the display, the red LED glows, and  appears on the display. You may also hear signaling tones.

- 2 Press and hold the PTT and proceed with your call.

# Communicating directly with other radios

You can bypass the radio repeater and communicate directly with another radio. This feature is known as repeater talkaround. You can do this, for example, when you are out of range of the repeater, or if the repeater is busy or stops working. While repeater talkaround is active, all transmissions are made on the receive frequency of the channel you are on.

To activate repeater talkaround, you may be able to either use a programmed function key, or use the Main menu.

## Using the Main menu

- 1 Select the required channel.
- 2 Press **Menu** and select **Radio settings > Functions > Talkaround**.
- 3 In the Talkaround menu, choose **On**.
- 4 Press **Select**. The message **Talkaround activated** appears briefly, and the repeater talkaround icon  appears on the display.
- 5 Proceed with your call.
- 6 To turn repeater talkaround off, either change the channel, or choose **Off** in the Talkaround menu.

## Using a function key

- 1 Select the required channel.
- 2 Press the programmed function key to turn repeater talkaround on. The message **Talkaround activated** appears briefly, and the repeater talkaround icon  appears on the display.
- 3 Proceed with your call.
- 4 To turn repeater talkaround off, either change the channel, or press the function key again.





# Receiving a call

When there is valid activity on your radio's currently selected channel or group, the radio then unmutes and you can hear the call.

If the incoming call contains special signaling that matches the signaling programmed for your radio, the green LED flashes and your radio may give a ringing tone.

# Receiving a text message

Your radio may be able to display received text messages in conventional mode. If programmed, the queuing icon  (empty queue) or  (message in queue) is always shown in the default display while in conventional mode.

## Viewing a text message

When a text message is received, the radio sounds two short high-pitched beeps. If the radio is currently showing the default display, the message appears immediately.

To view a message that does not appear immediately:

- 1 Navigate to the default display.
- 2 Press **Queue**.

To delete the message, press **Delete**. The message **Queue empty** appears on the display.

If you want to leave the message in the queue, press **Back**.

-  The conventional call queue only retains one message. If a new message is received while there is an old message left in the queue, the old message will be replaced.

# Hearing faint and noisy signals

Your radio's squelch allows the radio to unmute only when the strength of the incoming signal is above a predetermined threshold. This means that only signals of reasonable intelligibility are made audible. To make faint and noisy signals audible, use the squelch override function to unmute the radio.

To activate squelch override, you may be able to either use the Main menu, or a programmed function key.

## Using the Main menu

- 1 Press **Menu** and select **Radio Settings > Functions > Squelch o'ride**.



- 2 In the Squelch Override menu, choose **On**.
- 3 Press **Select**.

The message **Squelch override activated** appears on the display.

While squelch override is on, the green LED flashes continually, and the squelch override icon ◀ appears on the display.

## Using a function key

- 1 Press the function key programmed for squelch override to unmute the radio.

The message **Squelch override activated** appears on the display.

While squelch override is on, the green LED flashes continually, and the squelch override icon ◀ appears on the display.

- 2 To turn squelch override off, press the squelch override function key again.

## Using the function key programmed for monitor

The function key programmed for monitor may be programmed so that a short key press turns monitor on, and a long key press turns squelch override on.

To activate squelch override:

- Press and hold the function key programmed for monitor to override the radio's squelch.

The message **Squelch override activated** appears on the display.

While squelch override is on, the green LED flashes continually, and the squelch override icon  appears on the display.

Squelch override remains on until there is a further long key press.

## Using the radio in different repeater areas

Your radio may have a group of channels programmed as a voting group. The channels in the voting group all carry the same traffic, but from different repeaters. As your radio moves in and out of different repeater coverage areas, the best communication channel is automatically selected for you to use, until a better communications channel is selected.

This channel is known as the 'home' channel, and will be the channel you make and receive calls on. While voting is active, the orange LED glows and the scanning icon  appears on the display.

The section "[Selecting a group](#)" on page 69 explains how to select a group. A group can be either a voting or a scanning group.

## Suspending a channel from a voting group

You may be able to use the function key programmed for nuisance delete to temporarily delete one of the channels from the voting group.

When that voting group is next selected, or after the radio has been turned off and then on, the deleted channel is again part of the voting group.

Alternatively, the function key programmed for voting may be programmed so that a short key press turns on voting, and a long key press activates nuisance delete.

- Press and hold the function key programmed for voting to remove the current channel from the voting group.

If the operation has been successful, the message **Channel nuisance deleted** appears on the display.

## Scanning a group of channels

The scan function is used to monitor a programmed group of channels, looking for activity. While the radio is scanning for activity, the orange LED glows and the scanning icon  appears on the display. When activity is detected on a channel in the scan group, the radio stops on that channel. The orange LED begins flashing, the radio unmutes and you can hear the call. Scanning resumes once the channel is no longer busy.

The section "[Selecting a group](#)" on page 69 explains how to activate scanning.

## **Standard and background scanning**

The two types of scanning that may be available on your radio are standard scanning, and background scanning. Background scan can only be activated by using a function key programmed for background scan. It differs from standard scanning in that the channel that was selected when background scan was activated is also included as a scan-group member.

## **Making a call while scanning**

If you wish to make a call while your radio is scanning:

- 1** Lift the microphone off the microphone clip.
- 2** Press the PTT key to transmit. If the orange LED is flashing, or background scan is active, your radio will now call the currently selected channel.
- 3** If standard scan is active and there has been no recent activity on the channel (the orange LED is glowing rather than flashing), then the channel that is called depends on the way your radio has been programmed. The possible options are:
  - your radio calls a predetermined channel e.g. your dispatcher,
  - your radio calls the channel where activity was last detected, or
  - your radio calls the last free channel.
- 4** When the called party responds, proceed with your conversation.

## **Changing the background scan group assigned to a function key**

You can change the background scan group assigned to the function key programmed for group scanning or for scanning/nuisance delete.

- 1 Press **Menu** and select **Advanced > Set scan key**.

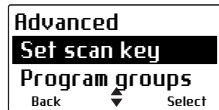

- 2 In the Set Scan Key menu, scroll through the list of background scan groups until the group you want appears.
- 3 Press **Select**.

The message **Scan key scans new group** appears on the display.

The next time you activate background scan, the new group will be your background scan group.

### **Suspending a channel from a scanning group**

If a member channel of a scan group is busy for a long time and you do not wish to hear the conversation, you may be able to use the function key programmed for nuisance delete to temporarily delete it from the scan group.

When the scan group is next selected, or after the radio has been turned off and then on, the deleted channel is again part of the scan group.

Alternatively, the function key programmed for scanning may be programmed so that a short key press turns on scanning, and a long key press activates nuisance delete.

- Press and hold the function key programmed for scanning to remove the current channel from the scanning group.

If the operation has been successful, the message **Channel deleted from group** appears on the display.

## Adding or deleting member channels of a group

Your radio may be programmed so you can add or delete channels in a voting or scanning group. Changes made are permanent, and will remain after restarting the radio.

1 Select the group. See ["Selecting a group" on page 69](#).

2 Press **Edit**.

If there is no edit option for the left selection key, the group cannot be changed.

Alternatively, you may be able to edit groups by pressing **Menu** and selecting **Advanced > Program groups**, then select the group you wish to edit.

3 In the Edit Group menu, choose **Add channel** or **Delete channel**.

4 Press **Select**.

5 Press the scroll keys to select the channel that you want to add or delete.

6 Press **OK**.

If successful, the message **Channel added** or **Channel deleted** appears.



To check the new group details, press **Back** and select the **Group members** menu option.

## Changing a group's transmit channel

You may be able to change the transmit channel of a standard scanning group. The transmit channel is identified by the  $T_x$  icon.

1 Select the group. See ["Selecting a group" on page 69](#).

2 Press **Edit**.

If there is no edit option for the left selection key, the group cannot be changed.

Alternatively, you may be able to edit groups by pressing **Menu** and selecting **Advanced > Program groups**, then select the group you wish to edit.

- 3 In the Edit Group menu, choose **Change tx**.
- 4 Press **Select**.
- 5 Press the scroll keys to select the new transmit channel.
- 6 Press **OK**.

If successful, the message **Tx channel changed** appears.



To check the new group details, press **Back** and select the **Group members** menu option. The new transmit channel has the  $T_x$  icon next to it.

## Changing a group's first or second priority channel

You may be able to change the priority channels of a scanning group. Priority channels are scanned more frequently than other channels in the group. If valid activity is found on another channel, the radio continues to scan the priority channel or channels at regular intervals. The first priority channel is identified by the  $P_1$  icon, and the second priority channel is identified by the  $P_2$  icon.

- 1 Select the group. See ["Selecting a group" on page 69](#).
- 2 Press **Edit**.

If there is no edit option for the left selection key, the group cannot be changed.

Alternatively, you may be able to edit groups by pressing **Menu** and selecting **Advanced > Program groups**, then select the group you wish to edit.

- 3 In the Edit Group menu, choose **Change P1** or **Change P2**.



- 4 Press **Select**.
- 5 Press the scroll keys to select the new priority channel.
- 6 Press **OK**.

If successful, the message **P1 channel changed** or **P2 channel changed** appears.



To check the new group details, press **Back** and select the **Group members** menu option. The new priority channel has the  $P_1$  or  $P_2$  icon next to it.

### Icon and messages that may appear when changing group details

The following icons may appear when viewing group membership details, adding or deleting channels from a group, or changing a group's transmit or priority channels.

Icon	Meaning
$T_X$	This channel is used to transmit on when there has been no recent activity. You cannot delete this channel (it will not appear under <b>Delete channel</b> ).
$P_1$	This channel is the group's first priority channel. You cannot delete this channel (it will not appear under <b>Delete channel</b> ).
$P_2$	This channel is the group's second priority channel. You cannot delete this channel (it will not appear under <b>Delete channel</b> ).
+	There is more than one instance of this channel in the group (the channel will be scanned more often). If you delete this channel, the radio will attempt to delete all instances of the channel.

The following messages may appear when using nuisance delete to temporarily delete a channel from a group, when adding or deleting channels from a group, or changing a group's transmit or priority channels.

<b>Message</b>	<b>Meaning</b>
<b>Scanning not on</b>	You cannot use nuisance delete to temporarily delete a channel from a group, as there is no group currently selected.
<b>No channel captured</b>	You cannot use nuisance delete to temporarily delete a channel from the group, as there is no channel currently captured (the orange LED is glowing and not flashing).
<b>Not enough channels in group</b>	You cannot use nuisance delete to temporarily delete the channel from the group, as the captured channel is the last remaining group member.
<b>Cannot delete channel</b>	You cannot use nuisance delete to temporarily delete the channel from the group. The captured channel may be the selected channel in a background scan group.
<b>Cannot delete priority chan</b>	You cannot use nuisance delete to temporarily delete the channel from the group, as the captured channel is a priority channel.
<b>Only two channels in group</b>	You cannot delete a channel from the group, as there would be only one group member left.
<b>No items in list</b>	The action you are attempting is not allowed. Either: <ul style="list-style-type: none"> <li>■ the group does not have a preset transmit channel or priority channels programmed, or</li> <li>■ you have added all the channels in the zone to the current group.</li> </ul>
<b>Group full</b>	You cannot add any more channels to the group, as the maximum number of members (50) has been reached.

# 7 GPS location services

This section explains how to use the GPS location services that may be available on your radio.

 This feature is controlled by a software license (SFE) and may not be available with your radio.

## **This section covers:**

- [About GPS location information](#)
- [About GPS status information](#)
- [Viewing GPS information](#)

# About GPS location information

If your radio is connected to an external GPS receiver, you can view GPS location information such as latitude and longitude, true course, speed, and coordinated universal time. Your radio can also display universal transverse mercator (UTM) information such as the UTM zone, and northing and easting coordinates.

Your radio may also be set up to send GPS information.

# About GPS status information

In the GPS Info menu, GPS status information appears at the top right of the display.

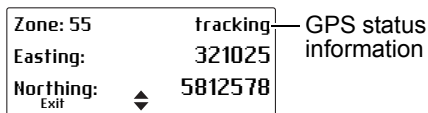

The following GPS status information appears at the top right of the display. Status information shown on a hand-held control head is shown in brackets [ ].

- **tracking [trk]**: the GPS receiver is displaying up-to-date satellite information.
- **stored**: the GPS receiver is having trouble connecting to satellites and the radio is displaying stored information that may not be current.
- **lost cnx [no cnx]**: the radio has lost serial communications with the GPS receiver.

# Viewing GPS information

- 1 Press **Menu** and select **Location Svs > GPS Info**.

(Depending on how your radio is programmed, you may be able to press a function key to access the GPS Info menu.)

GPS information is now shown on the display, if it is available.

Zone: 55	tracking
Easting:	321025
Northing:	5812578
Exit	◆

- 2 Use the scroll keys to view more GPS information.

GPS Info	tracking
S	37°49'00.0"
E	144°58'00.0"
Exit	◆



GPS Info	tracking
Course:	010°
Speed:	045km/h
Exit	◆

- 3 Press **Exit** to exit the GPS display.

GPS Info	tracking
UTC time:	02:07:33
Exit	◆

In certain situations, your radio may automatically exit the GPS display.

## 8 Loneworker monitoring

Loneworker monitoring is a safety feature for people who work alone. Loneworker monitoring may be programmed to be on or off at all times, or can be switched on and off by the user using a programmed function key or the menu.

A loneworker alarm is activated, if there has been no user activity for a predetermined time.

When the predetermined time has expired, an audible warning is given and you have a predetermined time to respond to the loneworker situation.

If you are unable to respond, the radio either enters emergency mode or (in trunked mode) sends a status update to a predetermined person or talkgroup.

### Activating loneworker monitoring

- 1 Press **Menu** and select **Radio Settings > Extra features > Loneworker**. (Depending on how your radio is programmed, you may be able to press a function key to turn loneworker monitoring on and off.)



- 2 In the Loneworker menu, choose **On**.

A vertical scroll bar on the right-hand side of the display indicates the remaining activity timeout.

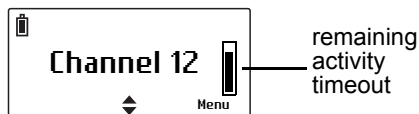

# Responding to a loneworker alarm

If you hear a beep to indicate that the radio is expecting a response from you to acknowledge that you are safe. The message “Loneworker awaiting” and a horizontal scroll bar appear indicating the remaining time until an emergency action is triggered.

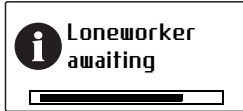

- Press any key.

Otherwise the radio will activate emergency mode or (in trunked mode) send a status update.

## Delaying the emergency action (conventional mode only)

In conventional mode, an additional emergency entry delay may be programmed which allows you to press a scroll key within a programmed time (usually 10 seconds) after the response time expires to delay the emergency action.

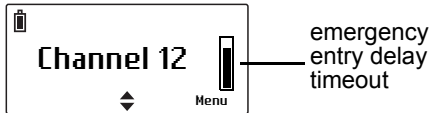

You now have the opportunity to turn the radio off and one to cancel the loneworker alarm.

- ⓘ The emergency action can be delayed only once.

# 9 Customizing radio settings

This section describes the ways in which you can customize your radio.



These features are common to radios operating in either trunked or conventional mode.

## **This section covers:**

- [Changing the volume of all audible indicators](#)
- [Changing the volume of keypress tones](#)
- [Changing to quiet operation](#)
- [Changing to silent operation](#)
- [Changing the external alert option](#)
- [Turning on backlighting](#)
- [Adjusting the display contrast](#)



# Changing the volume of all audible indicators

You can set the volume of all the audible indicators to either high or low. Audible tones include incoming call tones, warning tones and confirmation tones.

To change the volume of your radio's audible tones:

- 1 Press **Menu** and select **Radio settings > Alert settings > Indicator level**.

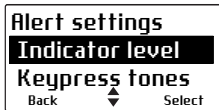

(Depending on how your radio is programmed, you may be able to press a function key to change the level of indicators.)

- 2 Scroll to **High** (or **Low**) and press **Select**.

# Changing the volume of keypress tones

Whenever you press the radio keys, the keypress tones give you an audible indication as to whether or not your action is allowed. A short, medium-pitched beep indicates that an action is allowed. A long, low-pitched beep indicates that the action is not allowed.

To change the volume of your radio's keypress tones:

- 1 Press **Menu** and select **Radio settings > Alert settings > Keypress tones**.

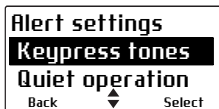

- 2 Scroll to either **Off**, **Low** or **High** and press **Select**.

# Changing to quiet operation

When quiet operation is on, keypress tones and confirmation tones are turned off. Incoming call tones, signaling tones and warning tones all remain audible.

To turn quiet operation on or off:

- 1 Press **Menu** and select **Radio settings** > **Alert settings** > **Quiet operation**.

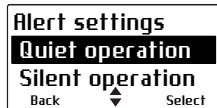

(Depending on how your radio is programmed, you may be able to press a function key to toggle quiet operation on and off.)

- 2 Scroll to **On** (or **Off**) and press **Select**.

# Changing to silent operation

When silent operation is on, all the radio's audible tones are turned off, and only channel traffic can be heard.

To turn silent operation on or off:

- 1 Press **Menu** and select **Radio settings** > **Alert settings** > **Silent operation**.

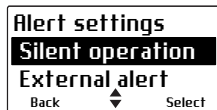

- 2 In the Silent Operation menu, scroll to either **On** or **Off** and press **Select**.

(Depending on how your radio is programmed, you may be able to press a function key to toggle silent operation on and off.)

While silent operation is on, the 🚫 icon appears in the display.

# Changing the external alert option

If you are away from your radio and unable to answer calls immediately, an external alert, such as a car horn, may activate when you receive a call. The external alert continues for a period of time and is then turned off.

To turn external alert on or off:

- 1 Press **Menu** and select **Radio settings** > **Alert settings** > **External alert**.

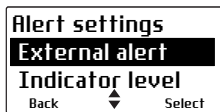

(Depending on how your radio is programmed, you may be able to press a function key to toggle external alert on and off.)

- 2 Scroll to either **On** or **Off** and press **Select**.

# Turning on backlighting

Whenever a key is pressed or a call is received, the keypad and display light up automatically. Backlighting only remains on for a few seconds, unless there is further radio activity. When backlighting is turned on, it remains on until the setting is changed to **Off**, regardless of radio activity.

To turn backlighting on or off:

- 1 Press **Menu** and select **Radio settings** > **Display settings** > **Backlighting**.



(Depending on how your radio is programmed, you may be able to press a function key to toggle backlighting on and off.)

- 2 Scroll to either **On** or **Off** and press **Select**.

## Turning backlighting on momentarily

You may be able to use a programmed function key to turn backlighting on momentarily.

- Press the assigned function key to turn backlighting on. Backlighting remains on for a few seconds, and then turns off.

Alternatively, the function key may be programmed so that:

- a short key press turns backlighting on momentarily, and
- a long key press turns backlighting on, and it remains on until there is a further long key press.

## Adjusting the backlighting level

The radio's display can also be made either darker or lighter, to suit your working conditions.

To change the level of the backlighting:

- 1 Press **Menu** and select **Radio settings** > **Display settings** > **Backlight level**.



- 2 Scroll to either **Low**, **Medium** or **High**, and press **Select**.

# Adjusting the display contrast

To change the contrast of your radio display to suit the lighting conditions that you are working in:

- 1 Press **Menu** and select **Radio settings** > **Display settings** > **Contrast adjust**.



- 2 Use the scroll keys to adjust the display contrast to the level you want.



- 3 Press **Save** to save this setting.

# 10 Troubleshooting

This section describes troubleshooting procedures, and basic maintenance.

## **This section covers:**

- [About troubleshooting](#)
- [When your radio won't turn on](#)
- [Identifying the radio's audible tones](#)
- [Checking the version of your radio](#)
- [Removing the microphone](#)
- [General care](#)

# About troubleshooting

If you are experiencing difficulty operating your radio, you may find the following sections helpful. Consult your radio provider for assistance, if necessary.

## When your radio won't turn on

If the red, green and orange LEDs on the control head do not light up when the radio is turned on, it is probable that power is not reaching the radio. Check the following:

- Is the power connector firmly plugged into the rear of the radio?
- Are the in-line fuses in good condition?
- Is the power cable securely connected to the vehicle battery or power supply?

If all appears to be in order, but your radio still fails to operate properly, contact your radio provider for further assistance.

## Identifying the radio's audible tones

The radio's audible tones can help you identify a potential problem:

<b>Audible tone</b>	<b>Meaning</b>
One short, high-pitched beep	The radio has been made inoperable ('stunned' or 'inhibited') by your service provider.
Two short beeps	The radio has been made operable ('revived' or 'uninhibited') by your service provider.
Two low-pitched beeps	The radio's temperature is high. (The radio will continue to operate.)

---

<b>Audible tone</b>	<b>Meaning</b>
Two high-pitched beeps	The radio's temperature is in the very high range; all calls will now be at low power. If the radio's temperature rises above this range, calls will be inhibited.  Turn off the radio and allow it to cool down.
Continuous low-pitched tone	Radio system error: a system error has occurred and the radio may be inoperable. Contact your radio provider.

---

## Checking the version of your radio

Your radio provider may ask you for the hardware and firmware version of your radio, for troubleshooting purposes.

### Using the Main menu

- 1 Press **Menu** and select **Radio info > Version info**.
- 2 Scroll to the version information you want to view and press **Select**.

### Using the PTT key (not with hand-held control head)

- Hold down the PTT key and turn on the radio.

The firmware and hardware versions, and your radio's frequency band is briefly displayed.



# Removing the microphone

- i** For information on installing or removing your radio from a vehicle, refer to the *Installation Guide*.

- 1 Using your thumb or forefinger, lift up one of the corners of the microphone grommet and firmly (but gently) pull that corner until the seal comes away from the cavity.

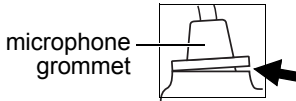

**Notice** Remove the grommet carefully as it serves two important functions. Firstly, it prevents damage to the microphone socket due to movement of the microphone cord, and secondly, it ensures that the control head is sealed against water, dust, and other environmental hazards.

- 2 Repeat to expose another corner.
- 3 Pull the exposed corners back and slide the grommet up the cable to reveal the microphone plug.
- 4 Remove the plug from the microphone socket.

## General care

Your radio requires no regular maintenance other than ensuring that all the cables and connections are secure, and that no damage has occurred to the antenna or wiring.

To prevent permanent damage to the radio cover, do not allow the radio to come into contact with detergents, alcohol, aerosol sprays or petroleum-based products.

If you need to clean the radio cover, use a cloth dampened with clean water. Do not immerse the radio in fluids.

# Directive 1999/5/CE Declaration of Conformity

## **da Dansk**

Undertegnede Tait Limited erklærer herved, at følgende udstyr TMBB1A & TMBH5A overholder de væsentlige krav og øvrige relevante krav i direktiv 1999/5/EF.

Se endvidere: [www.taitradio.com/eudoc/](http://www.taitradio.com/eudoc/)

## **de Deutsch**

Hiermit erklärt Tait Limited die Übereinstimmung der Geräte TMBB1A & TMBH5A mit den grundlegenden Anforderungen und den anderen relevanten Festlegungen der Richtlinie 1999/5/EG.

Siehe auch: [www.taitradio.com/eudoc/](http://www.taitradio.com/eudoc/)

## **el Ελληνικά**

Η Tait Limited δηλώνει ότι το TMBB1A & TMBH5A συμμορφώνεται προς τις ουσιώδεις απαιτήσεις και τις λοιπές σχετικές διατάξεις της Οδηγίας 1999/5/ΕΚ. Βλέπε επίσης: [www.taitradio.com/eudoc/](http://www.taitradio.com/eudoc/)

## **en English**

Tait Limited declares that this TMBB1A & TMBH5A complies with the essential requirements and other relevant provisions of Directive 1999/5/EC.

See also: [www.taitradio.com/eudoc/](http://www.taitradio.com/eudoc/)

## **es Español**

Por medio de la presente Tait Limited declara que las radios TMBB1A & TMBH5A cumplen con los requisitos esenciales y cualesquiera otras disposiciones aplicables o exigibles de la Directiva 1999/5/CE. Véase también:

[www.taitradio.com/eudoc/](http://www.taitradio.com/eudoc/)

## **fi Suomi**

Tait Limited vakuuttaa täten että TMBB1A & TMBH5A tyyppinen laite on direktiivin 1999/5/EY oleellisten vaatimusten ja sitä koskevien direktiivin muiden ehtojen mukainen.

Katso: [www.taitradio.com/eudoc/](http://www.taitradio.com/eudoc/)

## **fr Français**

Par la présente, Tait Limited déclare que les appareils TMBB1A & TMBH5A sont conformes aux exigences essentielles et aux autres dispositions pertinentes de la directive 1999/5/CE.

Voir aussi: [www.taitradio.com/eudoc/](http://www.taitradio.com/eudoc/)

## **it Italiano**

Con la presente Tait Limited dichiara che questo TMBB1A & TMBH5A è conforme ai requisiti essenziali ed alle altre disposizioni pertinenti stabilite dalla direttiva 1999/5/CE.

Vedi anche: [www.taitradio.com/eudoc/](http://www.taitradio.com/eudoc/)

## **nl Nederlands**

Hierbij verklaart Tait Limited dat het toestel TMBB1A & TMBH5A in overeenstemming is met de essentiële eisen en de andere relevante bepalingen van richtlijn 1999/5/EG.

Zie ook: [www.taitradio.com/eudoc/](http://www.taitradio.com/eudoc/)

## **pt Português**

Tait Limited declara que este TMBB1A & TMBH5A está conforme com os requisitos essenciais e outras provisões da Directiva 1999/5/CE.

Veja também: [www.taitradio.com/eudoc/](http://www.taitradio.com/eudoc/)

## **sv Svensk**

Härmed intygar Tait Limited att denna TMBB1A & TMBH5A står i överensstämmelse med de väsentliga egenskapskrav och övriga relevanta bestämmelser som framgår av direktiv 1999/5/EG.

Se även: [www.taitradio.com/eudoc/](http://www.taitradio.com/eudoc/)

# Tait Software Licence Agreement

This Software License Agreement ("Agreement") is between you ("Licensee") and Tait Limited ("Tait"). By using any of the Software items embedded and pre-loaded in the related Tait Designated Product, included on CD, downloaded from the Tait website, or provided in any other form, you agree to be bound by the terms of this Agreement. If you do not agree to the terms of this Agreement, do not install or use any of the Software. If you install or use any of the Software, that will be deemed to be acceptance of the terms of this Agreement.

For good and valuable consideration, the parties agree as follows:

## SECTION 1 DEFINITIONS

**"Confidential Information"** means all or any information supplied to or received by Licensee from Tait, whether before or after installation or use and whether directly or indirectly pertaining to the Software and Documentation supplied by Tait, including without limitation all information relating to the Designated Products, hardware, software; copyright, design registrations, trademarks; operations, processes, and related business affairs of Tait; and including any other goods or property supplied by Tait to Licensee pursuant to the terms of this Agreement.

**"Designated Products"** means products provided by Tait to Licensee with which or for which the Software and Documentation is licensed for use.

**"Documentation"** means product and software documentation that specifies technical and performance features and capabilities; user, operation, and training manuals for the Software; and

all physical or electronic media upon which such information is provided.

**"Executable Code"** means Software in a form that can be run in a computer and typically refers to machine language, which is comprised of native instructions the computer carries out in hardware. Executable code may also refer to programs written in interpreted languages that require additional software to actually execute.

**"Intellectual Property Rights"** and **"Intellectual Property"** mean the following or their substantial equivalents or counterparts, recognized by or through action before any governmental authority in any jurisdiction throughout the world and including, but not limited to all rights in patents, patent applications, inventions, copyrights, trademarks, trade secrets, trade names, and other proprietary rights in or relating to the Software and Documentation; including any adaptations, corrections, de-compilations, disassemblies, emulations, enhancements fixes, modifications, translations and updates to or derivative works from, the Software or Documentation, whether made by Tait or another party, or any improvements that result from Tait processes or, provision of information services.

**"Licensee"** means any individual or entity that has accepted the terms of this License.

**"Open Source Software"** means software with freely obtainable source code and license for modification, or permission for free distribution.

**"Open Source Software License"** means the terms or conditions under which the Open Source Software is licensed.

**“Person”** means any individual, partnership, corporation, association, joint stock company, trust, joint venture, limited liability company, governmental authority, sole proprietorship, or other form of legal entity recognized by a governmental authority.

**“Security Vulnerability”** means any flaw or weakness in system security procedures, design, implementation, or internal controls that if exercised (accidentally triggered or intentionally exploited) could result in a security breach such that data is compromised, manipulated, or stolen, or a system is damaged.

**“Software”** (i) means proprietary software in executable code format, and adaptations, translations, de-compilations, disassemblies, emulations, or derivative works of such software; (ii) means any modifications, enhancements, new versions and new releases of the software provided by Tait; and (iii) may contain one or more items of software owned by a third-party supplier. The term "Software" does not include any third-party software provided under separate license or not licensable under the terms of this Agreement.

**“Source Code”** means software expressed in human readable language necessary for understanding, maintaining, modifying, correcting, and enhancing any software referred to in this Agreement and includes all states of that software prior to its compilation into an executable programme.

**“Tait”** means Tait Limited and includes its Affiliates.

## **SECTION 2 SCOPE**

This Agreement contains the terms and conditions of the license Tait is providing to Licensee, and of Licensee's use of the Software and Documentation. Tait and Licensee enter into this Agreement in

connection with Tait delivery of certain proprietary Software and/or products containing embedded or pre-loaded proprietary Software.

## **SECTION 3 GRANT OF LICENSE**

3.1. Subject to the provisions of this Agreement and the payment of applicable license fees, Tait grants to Licensee a personal, limited, non-transferable (except as permitted in Section 7), and non-exclusive license to use the Software in executable code form, and the Documentation, solely in connection with Licensee's use of the Designated Products for the useful life of the Designated Products. This Agreement does not grant any rights to source code.

3.2. If the Software licensed under this Agreement contains or is derived from Open Source Software, the terms and conditions governing the use of such Open Source Software are in the Open Source Software Licenses of the copyright owner and not in this Agreement. If there is a conflict between the terms and conditions of this Agreement and the terms and conditions of the any applicable Open Source Software Licenses, the terms and conditions of the Open Source Software Licenses will take precedence. For information about Open Source Components contained in Tait products and the related Open Source licenses, see:

<http://support.taitradio.com/go/opensource>

## **SECTION 4 LIMITATIONS ON USE**

4.1. Licensee may use the Software only for Licensee's internal business purposes and only in accordance with the Documentation. Any other use of the Software is strictly prohibited. Without limiting the general nature of these restrictions, Licensee will not make the Software available for use by

third parties on a "time sharing," "application service provider," "service bureau" basis, or for any other similar commercial rental or sharing arrangement.

4.2. Licensee will not, and will not directly or indirectly allow or enable any third party to: (i) reverse engineer, disassemble, extract components, decompile, reprogram, or otherwise reduce the Software or any portion thereof to a human perceptible form or otherwise attempt to recreate the source code; (ii) modify, adapt, create derivative works of, or merge the Software; (iii) copy, reproduce, distribute, lend, or lease the Software or Documentation to any third party; (iv) grant any sublicense or other rights in the Software or Documentation to any third party; (v) take any action that would cause the Software or Documentation to be placed in the public domain; (vi) remove, or in any way alter or obscure any copyright notice or other notice of Tait or third-party licensor's proprietary rights; (vii) provide, copy, transmit, disclose, divulge or make the Software or Documentation available to, or permit the use of the Software by, any third party or on any machine except as expressly authorized by this Agreement; or (viii) use, or permit the use of, the Software in a manner that would result in the production of a copy of the Software by any means whatsoever other than what is permitted in this Agreement. Licensee may make one copy of the Software to be used solely for archival, back-up, or disaster recovery purposes; provided that Licensee may not operate that copy of the Software at the same time as the original Software is being operated. Licensee may make as many copies of the Documentation as it may reasonably require for the internal use of the Software.

4.3. Unless otherwise authorized by Tait in writing, Licensee will not, and

will not enable or allow any third party to: (i) install a copy of the Software on more than one unit of a Designated Product; or (ii) copy or transfer Software installed on one unit of a Designated Product to any other device. Licensee may temporarily transfer Software installed on a Designated Product to another device if the Designated Product is inoperable or malfunctioning. Temporary transfer of the Software to another device must be discontinued when the original Designated Product is returned to operation and the Software must be removed from the other device.

4.4. Licensee will maintain, during the term of this Agreement and for a period of two years thereafter, accurate records relating to this license grant to verify compliance with this Agreement. Tait, or a third party nominated by Tait, may inspect Licensee's premises, books and records, upon reasonable prior notice to Licensee, during Licensee's normal business hours and subject to Licensee's facility and security regulations. Tait is responsible for the payment of all expenses and costs of the inspection, provided that Licensee shall indemnify Tait for all costs (including audit costs and legal costs on a solicitor client basis) if Licensee has breached the terms of this Agreement. Any information obtained by Tait during the course of the inspection will be kept in strict confidence by Tait and used solely for the purpose of verifying Licensee's compliance with the terms of this Agreement.

## **SECTION 5 OWNERSHIP AND TITLE**

Tait, its licensors, and its suppliers retain all of their Intellectual Property Rights in and to the Software and Documentation, in any form. No rights are granted to Licensee under this Agreement by implication, estoppel or

otherwise, except for those rights which are expressly granted to Licensee in this Agreement. All Intellectual Property developed, originated, or prepared by Tait in connection with providing the Software, Designated Products, Documentation, or related services, remains vested exclusively in Tait, and Licensee will not have any shared development or other Intellectual Property Rights.

## **SECTION 6 LIMITED WARRANTY; DISCLAIMER OF WARRANTY**

6.1. The commencement date and the term of the Software warranty will be a period of one (1) year from Tait shipment of the Software. If Licensee is not in breach of any obligations under this Agreement, Tait warrants that the unmodified Software, when used properly and in accordance with the Documentation and this Agreement, will be free from a reproducible defect that eliminates the functionality or successful operation of a feature critical to the primary functionality or successful operation of the Software. Whether a defect has occurred will be determined solely by Tait. Tait does not warrant that Licensee's use of the Software or the Designated Products will be uninterrupted, error-free, completely free of Security Vulnerabilities, or that the Software or the Designated Products will meet Licensee's particular requirements. Tait makes no representations or warranties with respect to any third-party software included in the Software.

6.2 Tait sole obligation to Licensee, and Licensee's exclusive remedy under this warranty, is to use reasonable efforts to remedy any material Software defect covered by this warranty. These efforts will involve either replacing the media or attempting to correct significant,

demonstrable program or documentation errors or Security Vulnerabilities. If Tait cannot correct the defect within a reasonable time, then at Tait option, Tait will replace the defective Software with functionally equivalent Software, license to Licensee substitute Software which will accomplish the same objective, or terminate the license and refund Licensee's paid license fee. If Tait investigation of the perceived defect reveals that no such defect in fact exists, Tait may recover its costs in respect of such investigation from Licensee.

6.3. Tait disclaims any and all other warranties relating to the Software or Documentation other than the express warranties set forth in this Section 6. Warranties in Section 6 are in lieu of all other warranties whether express or implied, oral or written, and including without limitation any and all implied warranties of condition, title, non-infringement, merchantability, or fitness for a particular purpose or use by Licensee (whether Tait knows, has reason to know, has been advised of, or is otherwise aware of any such purpose or use), whether arising by law, by reason of custom or usage of trade, or by course of dealing. In addition, Tait disclaims any warranty to any person other than Licensee with respect to the Software or Documentation.

## **SECTION 7 TRANSFERS**

7.1. Licensee will not transfer the Software or Documentation to any third party without specific prior written consent from Tait. Tait may withhold such consent or at its own discretion make the consent conditional upon the transferee paying applicable license fees and agreeing to be bound by this Agreement.

7.2. In the case of a value-added reseller or distributor of Tait Designated Products, the consent

referred to in Section 7.1 may be contained in a Tait Reseller or Tait Distributor Agreement.

7.3. If the Designated Products are Tait vehicle-mounted mobile products or hand-carried portable radio products and Licensee transfers ownership of the Tait mobile or portable radio products to a third party, Licensee may assign its right to use the Software which is embedded in or furnished for use with the radio products and the related Documentation; provided that Licensee transfers all copies of the Software and Documentation to the transferee.

7.4. For the avoidance of any doubt, Section 7.3 excludes TaitNet Infrastructure, or the products listed at any time under network products at: <http://www.taitradio.com>.

7.5. If Licensee, as a contractor or subcontractor (integrator), is purchasing Tait Designated Products and licensing Software not for its own internal use but for end use only by a Customer, the Licensee may transfer such Software, but only if a) Licensee transfers all copies of such Software and the related Documentation to the transferee and b) Licensee has first obtained from its Customer (and, if Licensee is acting as a subcontractor, from the interim transferee(s) and from the ultimate end user sub license) an enforceable sublicense agreement that prohibits any other transfer and that contains restrictions substantially identical to the terms set forth in this Software License Agreement. Except as stated in the foregoing, Licensee and any transferee(s) authorised by this Section may not otherwise transfer or make available any Tait Software to any third party nor permit any party to do so. Licensee will, on request, make available evidence reasonably satisfactory to Tait demonstrating compliance with all the foregoing.

## **SECTION 8 TERM AND TERMINATION**

8.1. Licensee's right to use the Software and Documentation will commence when the Designated Products are supplied by Tait to Licensee and will continue for the life of the Designated Products with which or for which the Software and Documentation are supplied, unless Licensee breaches this Agreement, in which case this Agreement and Licensee's right to use the Software and Documentation may be terminated immediately upon notice by Tait.

8.2. Within thirty (30) days after termination of this Agreement, Licensee must certify in writing to Tait that all copies of the Software have been removed or deleted from the Designated Products and that all copies of the Software and Documentation have been returned to Tait or destroyed by Licensee and are no longer in use by Licensee.

8.3. Licensee acknowledges that Tait made a considerable investment of resources in the development, marketing, and distribution of the Software and Documentation and that Licensee's breach of this Agreement will result in irreparable harm to Tait for which monetary damages would be inadequate. If Licensee breaches this Agreement, Tait may terminate this Agreement and be entitled to all available remedies at law or in equity including immediate injunctive relief and repossession of all non-embedded Software and associated Documentation. Licensee shall pay all Tait costs (on an indemnity basis) for the enforcement of the terms of this Agreement.

## **SECTION 9 CONFIDENTIALITY**

Licensee acknowledges that the Software and Documentation contain proprietary and Confidential Information valuable to Tait and are

Tait trade secrets, and Licensee agrees to respect the confidentiality of the information contained in the Software and Documentation.

## **SECTION 10 LIMITATION OF LIABILITY**

10.1. In no circumstances shall Tait be under any liability to Licensee, or any other person whatsoever, whether in Tort (including negligence), Contract (except as expressly provided in this Agreement), Equity, under any Statute, or otherwise at law for any losses or damages whether general, special, exemplary, punitive, direct, indirect, or consequential arising out of or in connection with any use or inability of using the Software.

10.2. Licensee's sole remedy against Tait will be limited to breach of contract and Tait sole and total liability for any such claim shall be limited at the option of Tait to the repair or replacement of the Software or the refund of the purchase price of the Software.

## **SECTION 11 GENERAL**

11.1. COPYRIGHT NOTICES. The existence of a copyright notice on the Software will not be construed as an admission or presumption of publication of the Software or public disclosure of any trade secrets associated with the Software.

11.2. COMPLIANCE WITH LAWS. Licensee acknowledges that the Software may be subject to the laws and regulations of the jurisdiction covering the supply of the Designated Products and will comply with all applicable laws and regulations, including export laws and regulations, of that country.

11.3. ASSIGNMENTS AND SUBCONTRACTING. Tait may assign its rights or subcontract its obligations under this Agreement, or encumber or sell its rights in any Software, without prior notice to, or consent of, Licensee.

11.4. GOVERNING LAW. This Agreement shall be subject to and construed in accordance with New Zealand law and disputes between the parties concerning the provisions hereof shall be determined by the New Zealand Courts of Law. Provided however Tait may at its election bring proceedings for breach of the terms hereof or for the enforcement of any judgment in relation to a breach of the terms hereof in any jurisdiction Tait considers fit for the purpose of ensuring compliance with the terms hereof or obtaining relief for breach of the terms hereof.

11.5. THIRD-PARTY BENEFICIARIES. This Agreement is entered into solely for the benefit of Tait and Licensee. No third party has the right to make any claim or assert any right under this Agreement, and no third party is deemed a beneficiary of this Agreement. Notwithstanding the foregoing, any licensor or supplier of third-party software included in the Software will be a direct and intended third-party beneficiary of this Agreement.

11.6. SURVIVAL. Sections 4, 5, 6.3, 7, 8, 9, 10, and 11 survive the termination of this Agreement.

11.7. ORDER OF PRECEDENCE. In the event of inconsistencies between this Agreement and any other Agreement between the parties, the parties agree that, with respect to the specific subject matter of this Agreement, this Agreement prevails.

11.8. SECURITY. Tait uses reasonable means in the design and writing of its own Software and the acquisition of third-party Software in order to limit Security Vulnerabilities. While no software can be guaranteed to be free from Security Vulnerabilities, if a Security Vulnerability is discovered, Tait will take the steps specified in Section 6 of this Agreement.



11.9. EXPORT. Licensee will not transfer, directly or indirectly, any Designated Product, Documentation or Software furnished hereunder or the direct product of such Documentation or Software to any country for which New Zealand or any other applicable country requires an export license or other governmental approval without first obtaining such license or approval.

11.10. SEVERABILITY. In the event that any part or parts of this Agreement shall be held illegal or null and void by any court or administrative body of competent jurisdiction, such determination shall not affect the remaining terms which shall remain in full force and effect as if such part or parts held to be illegal or void had not been included in this Agreement. Tait may replace the invalid or unenforceable provision with a valid and enforceable provision that achieves the original intent and economic effect of this Agreement.

11.11. CONSUMER GUARANTEES. Licensee acknowledges that the licenses supplied in terms of this agreement are supplied to Licensee in business, and that the guarantees and other provisions of prevailing consumer protection legislation shall not apply.

11.12. WHOLE AGREEMENT. Licensee acknowledges that it has read this Agreement, understands it and agrees to be bound by its terms and conditions. Licensee also agrees that, subject only to the express terms of any other agreement between Tait and Licensee to the contrary, this is the complete and exclusive statement of the Agreement between it and Tait in relation to the Software. This Agreement supersedes any proposal or prior agreement, oral or written, and any other communications between Licensee and Tait relating to the Software and the Designated Products.





