

LABORATORY TEST REPORT
RADIO PERFORMANCE MEASUREMENTS

for the

TMBC0A Mobile Transceiver

Tested in accordance with:

FCC 47 CFR Part 90

Report Revision: 1

Issue Date: 20 April 2018

PREPARED BY: L. M. White

Test Technician

CHECKED & APPROVED BY: M. C. James

Laboratory Technical Manager



IANZ
ACCREDITED LABORATORY

FCC REGISTRATION: 838288

All tests reported herein have been performed in accordance with the laboratory's scope of accreditation.

This document must not be reproduced except in full, without the written permission of the Compliance Laboratory Manager

TELTEST Laboratories (A Division of Tait Communications)
PO Box 1645, 558 Wairakei Road, Christchurch, New Zealand.

Telephone: 64 3 358 3399
FAX: 64 3 359 4632

TABLE OF CONTENTS

REVISION.....	3
INTRODUCTION	4
STATEMENT OF COMPLIANCE.....	5
MODULATION TYPES, NECESSARY BANDWIDTH & EMISSION DESIGNATORS	6
TEST RESULTS	7
TRANSMITTER OUTPUT POWER (CONDUCTED).....	7
TRANSMITTER AUDIO FREQUENCY RESPONSE - PRE-EMPHASIS	8
TRANSMITTER MODULATION LIMITING.....	9
TRANSMITTER OCCUPIED BANDWIDTH AND SPECTRUM MASKS	10
TRANSMITTER SPURIOUS EMISSIONS (CONDUCTED)	15
TRANSMITTER SPURIOUS EMISSIONS (RADIATED).....	19
TRANSIENT FREQUENCY BEHAVIOR	22
TRANSMITTER FREQUENCY STABILITY - TEMPERATURE	24
TRANSMITTER FREQUENCY STABILITY - VOLTAGE.....	25
TEST EQUIPMENT LIST	26
ANNEX A – TEST SETUP DETAILS	28

REVISION

Date	Revision	Comments
20 April 2018	1	Initial test report

INTRODUCTION

Type approval testing of the TMBC0A, 25 Watt, Mobile transceiver in order to demonstrate compliance with FCC 47 Part 90 for 173.2-173.4 MHz. This is a Class 2 permissive change to extend the frequency range of this product. The previous FCC Grant for this product is FCCID: CASTMBC0A 220-222 MHz to CFR part 90 (test report Timco 1424AUT17), and a previous class 2 permissive change added 217-220 MHz to part 80 (test report Timco 1976UT17).

This radio supports analogue, digital FFSK and Digital Mobile Radio (DMR) modulations.

REPORT PREPARED FOR

Tait Ltd
245 Wooldridge Road
Harewood
Christchurch 8051
New Zealand

DESCRIPTION OF SAMPLE

Manufacturer: Tait Limited
Equipment: Handportable Transceiver
Type: TMBC0A
Product Code: T02-00012-CBAA
Serial Number(s): 20466893
Frequency range: 173 → 225 MHz
Transmit Power: 25 W

Modulation		Channel Spacing	Speech Channels	Symbol Rate (symbols/sec)	Data Rate (bps)
Analogue FM		12.5 kHz	1	-	-
FFSK	Fast Frequency Shift Keying	12.5 kHz	-	1200	1200
		12.5 kHz	-	2400	2400
Digital Mobile Radio (DMR)	4 Level FSK (2 slot TDMA) (ETSI TS102 361-1)	12.5 kHz	2	4800	9600

HARDWARE & SOFTWARE

Quantity: 1

	Analogue, FFSK and DMR tests	Target Hardware
Hardware ID	TMBC12-0100_0007	Head
Boot Code	QCB1B_S00_3.01.03.0001	Head
Radio Application	QCB1F_S00_1.01.08.1023	Head
FPGA Image	QCB1G_S01_1.12.00.0003	Head
Hardware ID	TMBB12-C000_0008	Torso
Boot Code	QMB1B_S00_3.01.03.0001	Torso
DSP	QMB1A_E00_2.17.05.0082	Torso
Radio Application	QMB1F_E00_2.17.05.0082	Torso
Firmware Package	QI93M_E00_2.17.05.0082	Torso
FPGA Image	QMB1G_S01_1.12.00.0003	Torso

TEST CONDITIONS

All testing was performed between 16 → 19 April 2018, and under the following conditions:

Ambient temperature: 15°C → 30°C
Relative Humidity: 20% → 75%
Standard Test Voltage: 13.8 V_{DC}

STATEMENT OF COMPLIANCE

We, TELTEST LABORATORIES of 558 Wairakei Road, Christchurch, New Zealand, declare under our sole responsibility that the product:

Equipment: Mobile Transceiver
Type: TMBC0A
Product Code: T02-00012-CBAA
Serial Number(s): 20466893
Quantity: 1

to which this declaration relates, is in conformity with the following standards:

FCC 47 CFR Part 90

Signature: 

M. C. James
Laboratory Technical Manager

Date: 20 April 2018

MODULATION TYPES, NECESSARY BANDWIDTH & EMISSION DESIGNATORS

MODULATION TYPES:

F3E	Analogue Frequency Modulation (FM)	
F2D	FFSK	1200 bps and 2400 bps
FXW	DMR Digital Voice	9600 bps
FXD	DMR Digital Data	9600 bps

CHANNEL SPACINGS: 12.5 kHz

EMISSION DESIGNATORS:

	12.5 kHz
Analog FM	11K0F3E
FFSK Data 1200 bps	6K60F2D
FFSK Data 2400 bps	7K80F2D
Digital Voice DMR	7K60FXW
Digital Data DMR	7K60FXD

CALCULATIONS

Equation: $B_n = 2M + 2Dk$

(M is highest modulating frequency; D is peak allowable deviation; k is a constant of 1 for FM)

Analog Voice 12.5 kHz Bandwidth

Necessary bandwidth

M = 3.0 kHz

D = 2.5 kHz

$$B_n = (2 \times 3.0) + (2 \times 2.5) \times 1$$

$$= 11.0 \text{ kHz}$$

Emission Designator

11K0F3E

F3E represents an FM voice transmission

Fast Frequency Shift Keying (FFSK – 1200 bps) 12.5 kHz Bandwidth

Necessary bandwidth

M = 1.8 kHz

D = 1.5 kHz (60% of peak deviation)

$$B_n = (2 \times 1.8) + (2 \times 1.5) \times 1$$

$$= 6.6 \text{ kHz}$$

Emission Designator

6K60F2D

F2D represents a FM data transmission with the use of a modulating sub carrier

Fast Frequency Shift Keying (FFSK – 2400 bps) 12.5 kHz Bandwidth

Necessary bandwidth

M = 2.4 kHz

D = 1.5 kHz (60% of peak deviation)

$$B_n = (2 \times 2.4) + (2 \times 1.5) \times 1$$

$$= 7.8 \text{ kHz}$$

Emission Designator

7K80F2D

F2D represents a FM data transmission with the use of a modulating sub carrier

Digital Voice 12.5 kHz Bandwidth DMR

99% bandwidth

= 7.6 kHz

FXW represents a FM Time Division Multiple Access (TDMA) combination of data and telephony

Emission Designator

7K60FXW

Digital Data 12.5 kHz Bandwidth DMR

99% bandwidth

= 7.6 kHz

FXD represents FM Time Division Multiple Access (TDMA) data only

Emission Designator

7K60FXD

TEST RESULTS

TRANSMITTER OUTPUT POWER (CONDUCTED)

SPECIFICATION: FCC 47 CFR 2.1046

GUIDE: TIA/EIA-603D 2.2.1

MEASUREMENT PROCEDURE:

1. Refer Annex A for Equipment set up.
2. The coaxial attenuator has an impedance of 50 Ohms.
3. The unmodulated output power was measured with an RF Power meter.

MEASUREMENT RESULTS:

Manufacturer's Rated Output Power:

Switchable: 25 W and 1 W

Nominal 25 W	173.3 MHz
Measured	27.1
Variation (%)	8.5

Nominal 1 W	173.3 MHz
Measured	1.0
Variation (%)	4.7
Measurement Uncertainty	± 0.6 dB

LIMIT CLAUSE:

FCC 47 CFR 90.205 (s)

The output power shall not exceed by more than 20%... the manufacturer's rated output power for the particular transmitter specifically listed on the authorization.

TRANSMITTER AUDIO FREQUENCY RESPONSE - PRE-EMPHASIS

SPECIFICATION: FCC 47 CFR 2.1047 (a)

GUIDE: TIA/EIA-603D 2.2.6

MEASUREMENT PROCEDURE:

1. Refer Annex A for Equipment set up.
2. An audio input tone of 1000 Hz was applied with the level set to obtain 20% of maximum deviation. This was used as the 0 dB reference point.
3. The AF was varied while the audio level was held constant.
4. The response in dB relative to 1000 Hz was measured.

MEASUREMENT RESULTS:

See the plot below for 12.5 kHz channel spacing tested at 25 W transmit power.

LIMIT CLAUSE: TIA/EIA-603D 3.2.6

MEASUREMENT UNCERTAINTY: $\pm 1.5\%$

Tx FREQUENCY: 173.3 MHz

12.5 kHz Channel Spacing

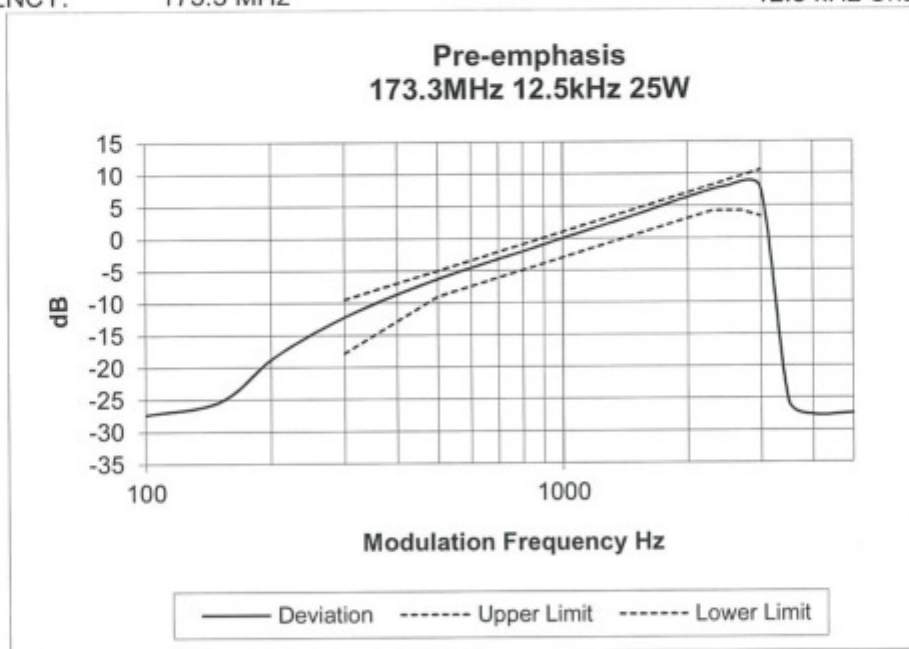

TRANSMITTER MODULATION LIMITING

SPECIFICATION: FCC 47 CFR 2.1047 (b)

GUIDE: TIA/EIA-603D 2.2.3

MEASUREMENT PROCEDURE:

1. Refer Annex A for Equipment set up.
2. The modulation response was measured at three audio frequencies while varying the input level.
3. Measurements were made for both Positive and Negative Deviation.

MEASUREMENT RESULTS:

See the plot below for 12.5 kHz channel spacing.

LIMIT CLAUSE: TIA/EIA-603D 1.3.4.4

MEASUREMENT UNCERTAINTY: $\pm 1.5\%$

Tx FREQUENCY: 173.3 MHz

12.5 kHz Channel Spacing

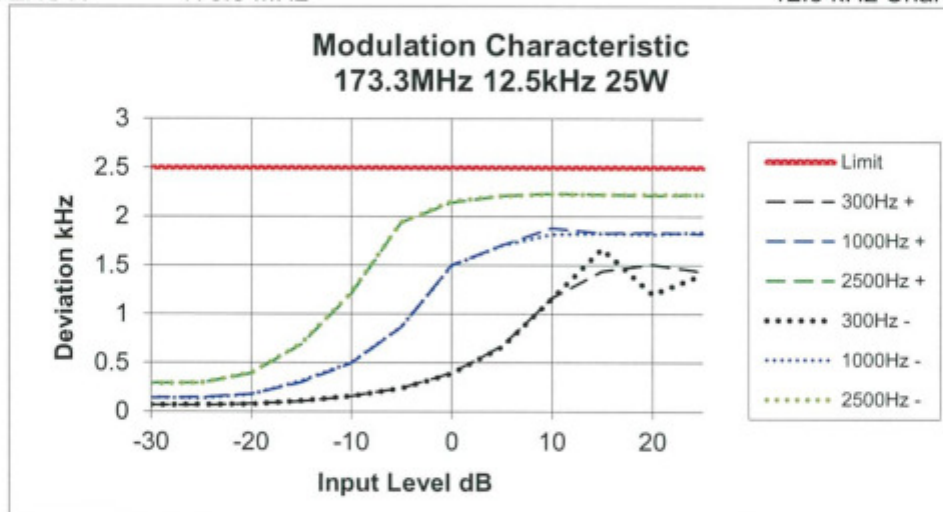

TRANSMITTER OCCUPIED BANDWIDTH AND SPECTRUM MASKS

SPECIFICATION: FCC 47 CFR 2.1049 (c)

GUIDE: TIA/EIA-603D 2.2.11 (Analog)
TIA-102.CAAA-C 2.2.5 (Digital)

MEASUREMENT PROCEDURE:

1. Refer Annex A for Equipment Set up.
2. For analog measurements: The EUT was modulated by a 2500 Hz tone at an input level 16 dB above a level that produced 50% deviation. The input level was established at the frequency of maximum response of the audio modulating circuit.
For Data measurements: The EUT was modulated with an internally generated pseudo random bit sequence at the appropriate Baud rates.
3. The Occupied Bandwidth was measured on the Spectrum Analyser, with bandwidth settings as follows.

Emission Mask D – Resolution Bandwidth = 100 Hz, Video Bandwidth = 1 kHz

MEASUREMENT RESULTS:

See the plots on the following pages for 12.5 kHz channel spacing.

MEASUREMENT UNCERTAINTY 95% $\pm 0.65\text{dB}$

LIMIT CLAUSE: FCC 47 CFR 90.210

EMISSION MASKS

Emission Mask D 12.5 kHz Channel Spacing Analog, FFSK, Digital Voice/Data

DATA SPEED

Digital Voice/Data 12.5 kHz Channel Spacing 9600 bps
FFSK 12.5 kHz Channel Spacing 1200 bps & 2400 bps

Occupied Bandwidth and Spectrum Masks

ANALOG VOICE

SPECIFICATION: FCC CFR 2.1049 (c)

Tx FREQUENCY: 173.3 MHz 25 W 12.5 kHz Channel Spacing

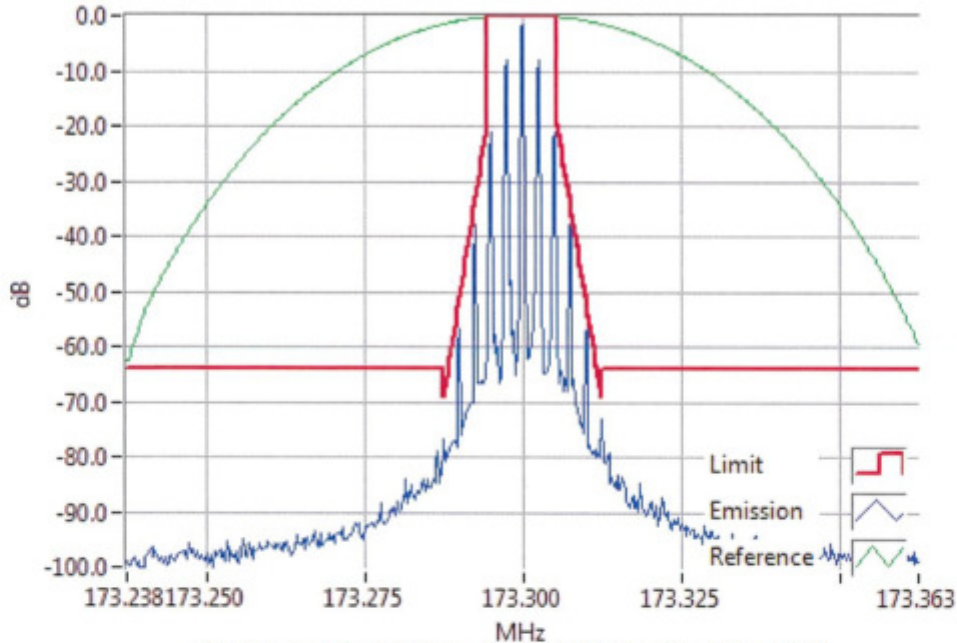

Analogue Modulation 173.3000MHz Mask D 25W
RBW=100Hz, VBW=1000Hz, Detector Mode=Peak
Result=Pass

Tx FREQUENCY: 173.3 MHz 1 W 12.5 kHz Channel Spacing

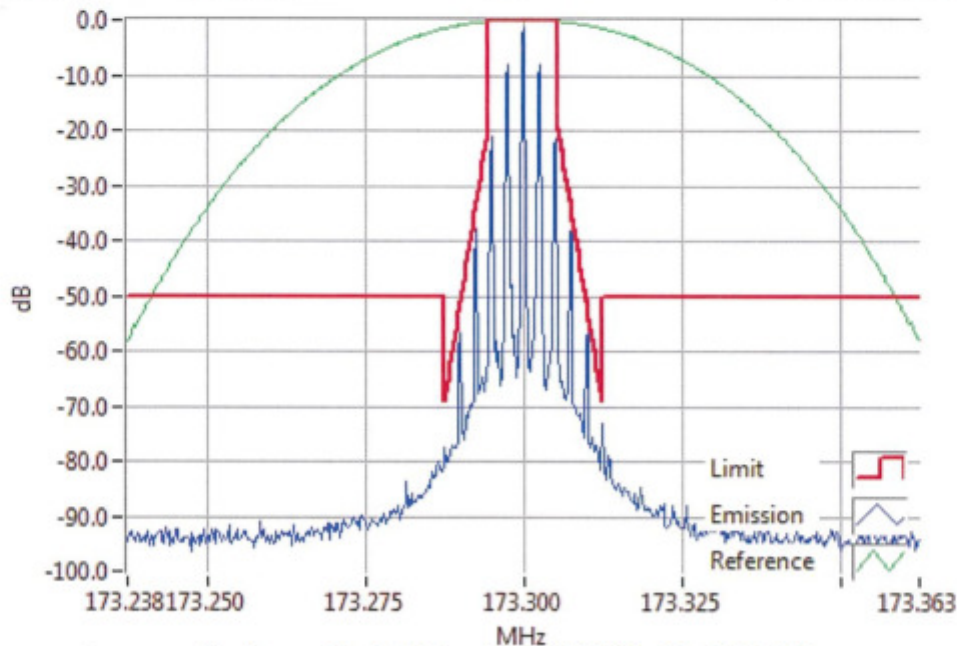

Analogue Modulation 173.3000MHz Mask D 1W
RBW=100Hz, VBW=1000Hz, Detector Mode=Peak
Result=Pass

Occupied Bandwidth and Spectrum Masks

FFSK 1200 bps

SPECIFICATION: FCC CFR 2.1049 (c)

Tx FREQUENCY: 173.3 MHz 25 W 12.5 kHz Channel Spacing

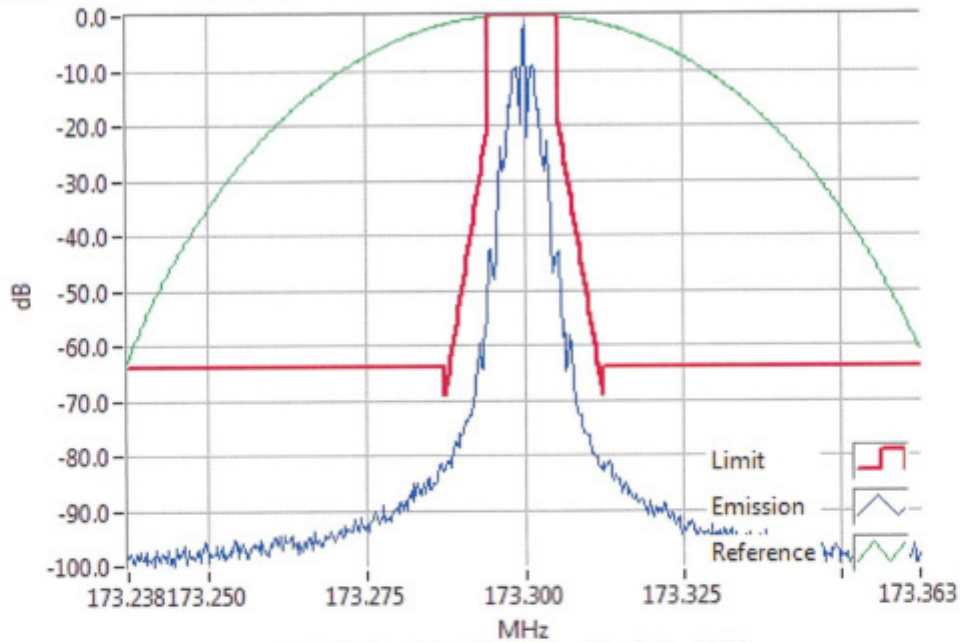

FFSK1200 173.3000MHz Mask D 25W
RBW=100Hz, VBW=1000Hz, Detector Mode=Peak
Result=Pass

Tx FREQUENCY: 173.3 MHz 1 W 12.5 kHz Channel Spacing

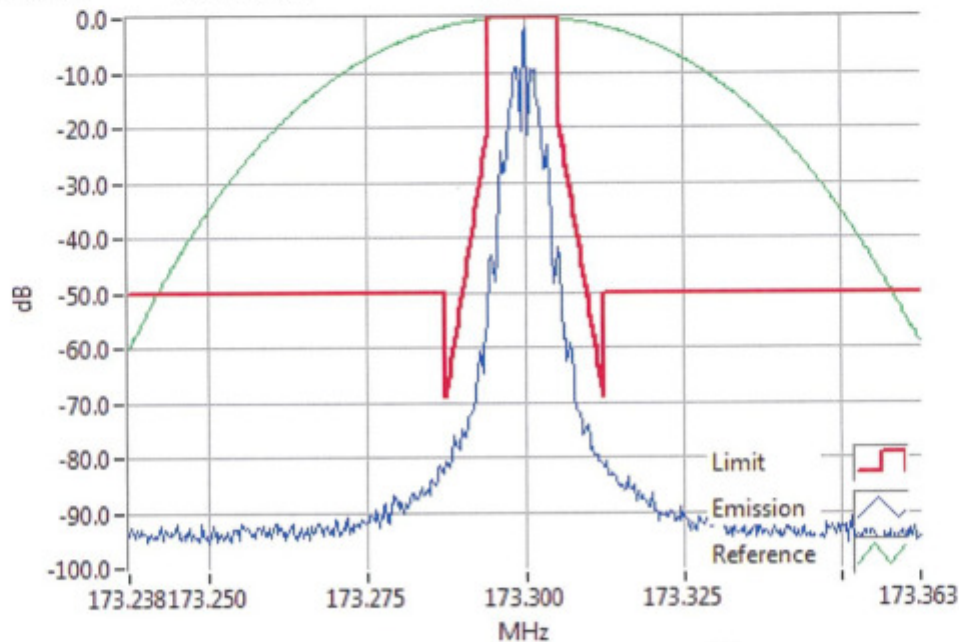

FFSK1200 173.3000MHz Mask D 1W
RBW=100Hz, VBW=1000Hz, Detector Mode=Peak
Result=Pass

Occupied Bandwidth and Spectrum Masks

FFSK 2400 bps

SPECIFICATION: FCC CFR 2.1049 (c)

Tx FREQUENCY: 173.3 MHz 25 W 12.5 kHz Channel Spacing

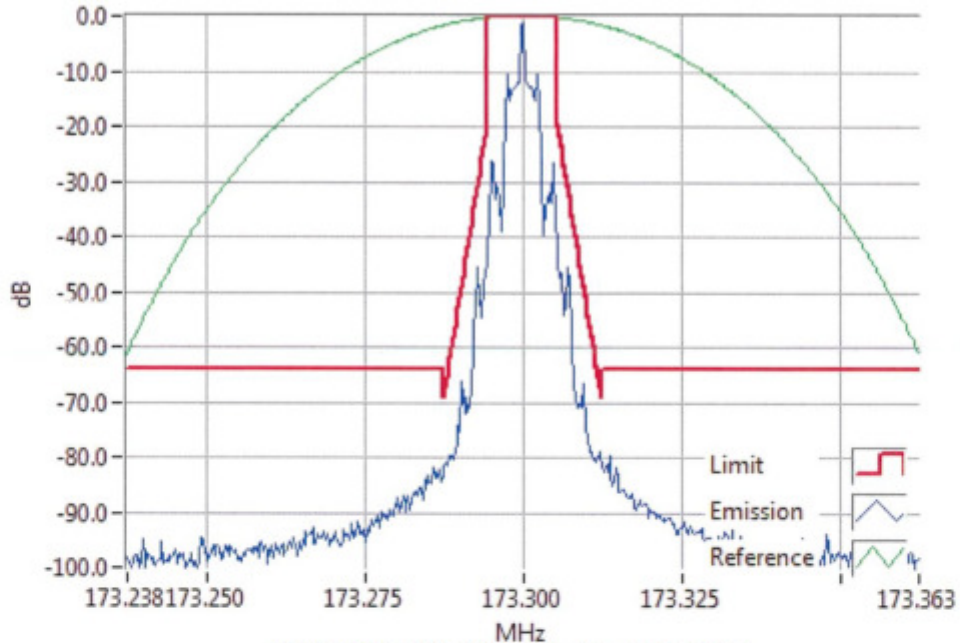

FFSK2400 173.3000MHz Mask D 25W
RBW=100Hz, VBW=1000Hz, Detector Mode=Peak
Result=Pass

Tx FREQUENCY: 173.3 MHz 1 W 12.5 kHz Channel Spacing

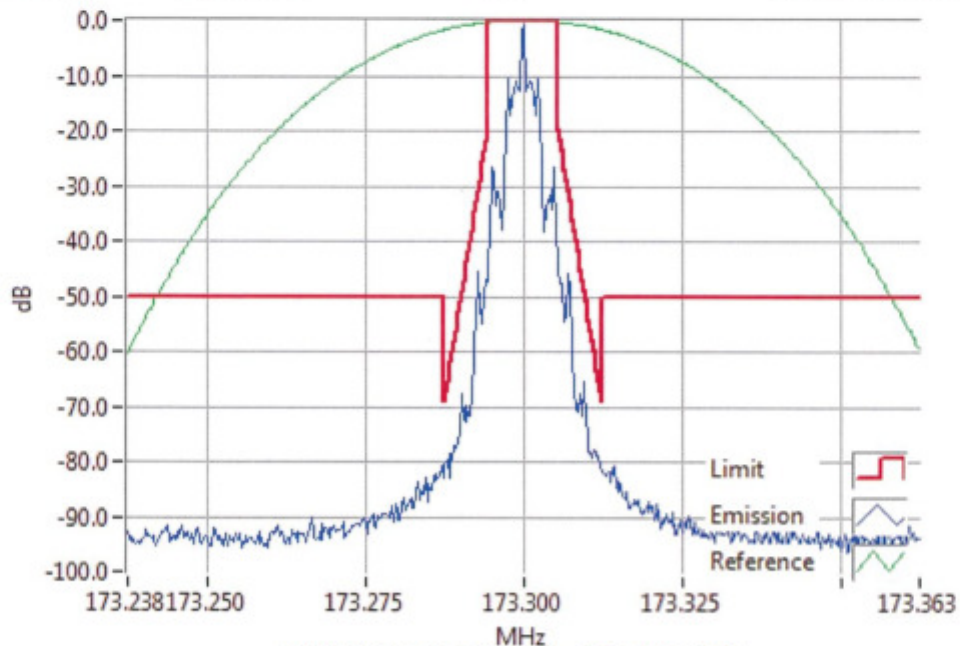

FFSK2400 173.3000MHz Mask D 1W
RBW=100Hz, VBW=1000Hz, Detector Mode=Peak
Result=Pass

Occupied Bandwidth and Spectrum Masks

DMR

SPECIFICATION: FCC CFR 2.1049 (c)

Tx FREQUENCY: 173.3 MHz 25 W 12.5 kHz Channel Spacing

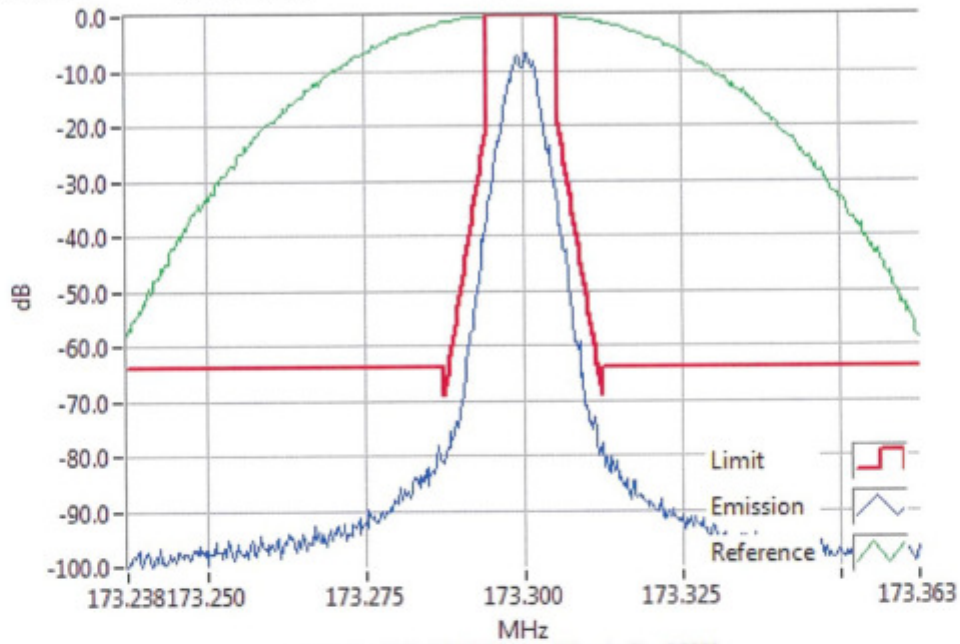

DMR 173.3000MHz Mask D 25W
RBW=100Hz, VBW=1000Hz, Detector Mode=Peak
Result=Pass

Tx FREQUENCY: 173.3 MHz 1 W 12.5 kHz Channel Spacing

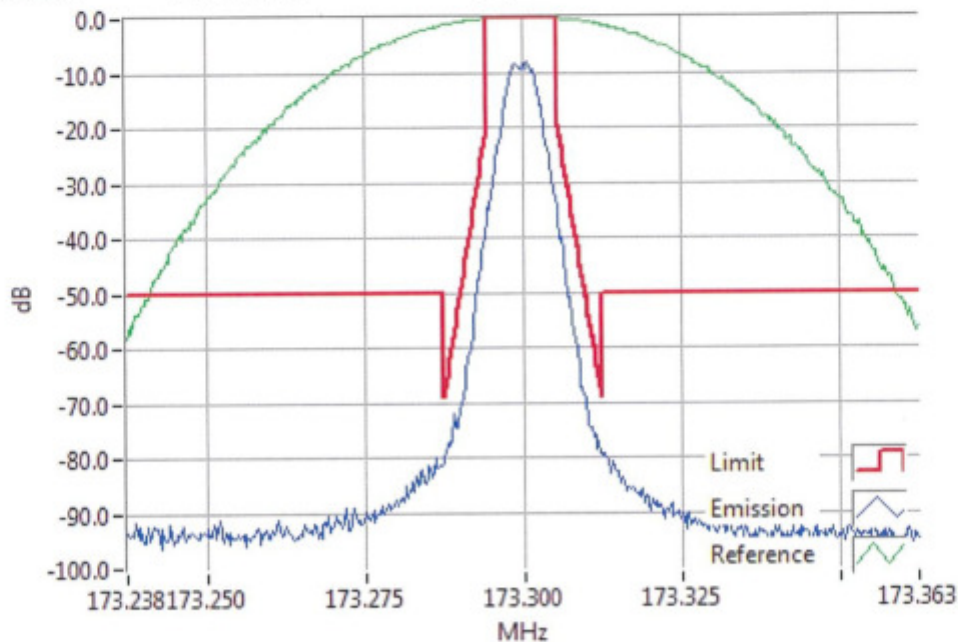

DMR 173.3000MHz Mask D 1W
RBW=100Hz, VBW=1000Hz, Detector Mode=Peak
Result=Pass

TRANSMITTER SPURIOUS EMISSIONS (CONDUCTED)

SPECIFICATIONS: FCC 47 CFR 2.1051

GUIDE: TIA/EIA-603D 2.2.13

MEASUREMENT PROCEDURE:

1. Refer Annex A for equipment set up.
2. The frequency range examined was from the lowest frequency generated within the EUT, to a frequency higher than the 10th Harmonic: 100 kHz to $F_c - BW$
 $F_c + BW$ to 10 F_c GHz
3. A Pre-scan is performed with a resolution bandwidth of 1 kHz, and a video bandwidth of 3 kHz. If any emissions are found to be within 20 dB of the limit a second measurement is made with the carrier modulated, and a resolution bandwidth of 10 kHz, and a video bandwidth of 30 kHz.

Spurious emissions which were attenuated by more than 20 dB below the limit were not recorded.

A photograph of the test set-up is included below.

MEASUREMENT RESULTS:

See the tables and plots on the following pages for 12.5 kHz channel spacing.

LIMIT CLAUSE: FCC 47 CFR 90.210

Photo: Conducted Emissions Test Setup



Spurious Emissions (Tx Conducted)

SPECIFICATION: FCC CFR 2.1051

12.5 kHz Channel Spacing 173.3 MHz @ 25 W Emission Mask D

Emission Frequency (MHz)	Level (dBm)	Level (dBc)
~	~	~

12.5 kHz Channel Spacing 173.3 MHz @ 1 W Emission Mask D

Emission Frequency (MHz)	Level (dBm)	Level (dBc)
~	~	~
Measurement Uncertainty:	≤ 2.75 GHz ± 3.0 dB	
No emissions were detected at a level greater than 20 dB below the limit.		

Spurious Emissions (Tx Conducted)
12.5 kHz Channel Spacing 173.3 MHz @ 25 W

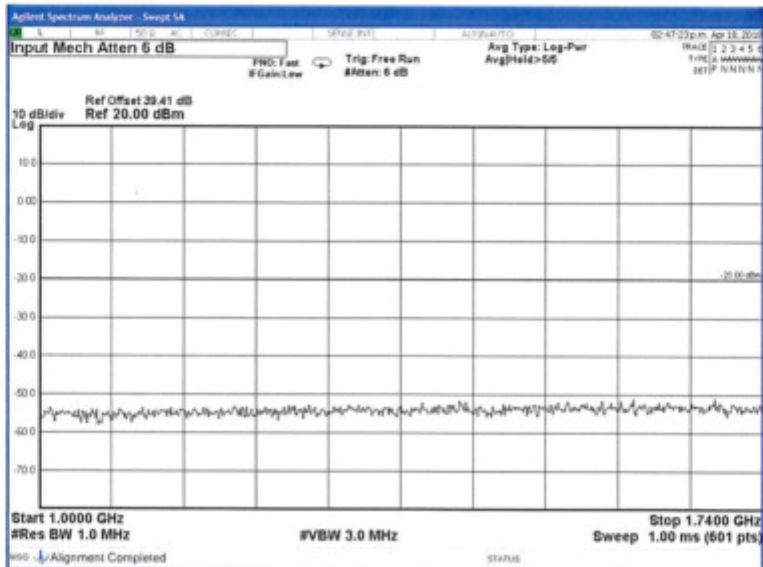
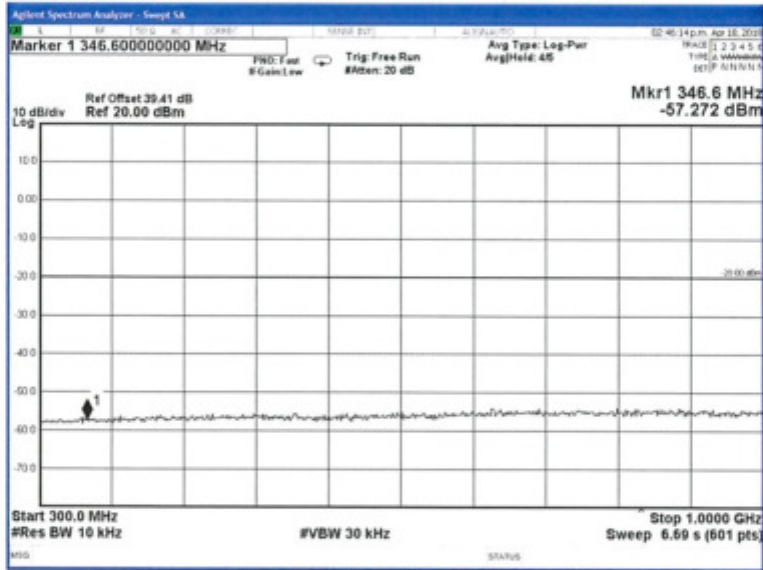
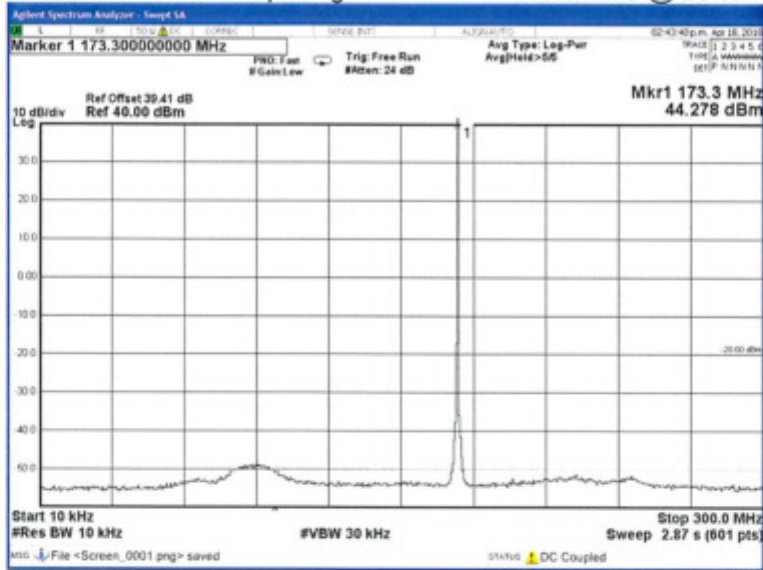

Spurious Emissions (Tx Conducted)

SPECIFICATION: FCC CFR 2.1051

LIMITS: FCC 47 CFR 90.210

Carrier Output Power	Emission Mask D 12.5 kHz Channel Spacing $50 + 10 \text{ Log}_{10} (P_{\text{Watts}})$	
	25 W	-20 dBm
1 W	-20 dBm	-50 dBc

TRANSMITTER SPURIOUS EMISSIONS (RADIATED)

SPECIFICATION: FCC 47 CFR 2.1053

GUIDE: TIA/EIA-603D 2.2.12

MEASUREMENT PROCEDURE:

Initial Scan:

1. The EUT is placed in the S-Line TEM cell and emissions are measured from 30 MHz to 800 MHz. Any emission within 20 dB of the limit is then re-tested on the OATS.
2. The EUT is placed in the reverberation chamber and emissions are measured from 800 MHz to the upper frequency required. Any emission within 20 dB of the limit is then re-tested on the OATS.
3. The harmonics emissions up to the 6th harmonic of the fundamental frequency are measured on the OATS

OATS Measurement:

1. The EUT is placed on a wooden turntable at a distance of three metres from the test antenna. The output terminal is connected to an RF dummy load.
2. The test antenna is raised from 1 m to 4 m to obtain a maximum reading; the turntable is then rotated through 360° to obtain the maximum response of each spurious emission. Valid emissions are determined by switching the EUT on and off.
3. The EUT is then replaced by a signal generator and substitution antenna to make measurements by the substitution method.

MEASUREMENT RESULTS:

See the tables on the following page

LIMIT CLAUSE: FCC 47 CFR 90.210

Spurious Emissions (Tx Radiated)

SPECIFICATION: FCC CFR 2.1053

12.5 kHz Channel Spacing 173.3 MHz @ 25 W Emission Mask D

Emission Frequency (MHz)	Level (dBm)	Level (dBc)
~	~	~

12.5 kHz Channel Spacing 173.3 MHz @ 1 W Emission Mask D

Emission Frequency (MHz)	Level (dBm)	Level (dBc)
~	~	~
Measurement Uncertainty	± 4.6 dB	
No emissions were detected at a level greater than 20 dB below the limit.		

LIMITS: FCC CFR 2.1053

Carrier Output Power	Emission Mask D 12.5 kHz Channel Spacing $50 + 10 \text{ Log}_{10} (P_{\text{Watts}})$	
25 W	-20 dBm	-64 dBc
1 W	-20 dBm	-50 dBc

Tx Radiated Emissions - Continued

Open Area Test Site Results:

12.5 kHz Channel Spacing

173.3 MHz @ 25 W

Emission Mask D

Harmonics Emission Frequency (MHz)	Level (dBm)	Level (dBc)
346.6	-58.69	-102.69
519.9	-75.56	-119.56
693.2	-56.31	-100.31
866.5	-54.50	-98.50
1039.8	-66.29	-110.29
1213.1	-58.89	-102.89
Measurement Uncertainty	± 4.6 dB	

Sample Calculation	Measurement					Result	
	Reference	Substitution					
	Emission Frequency (MHz)	Reference Level (dBm)	Sig-gen Level	Cable and Attenuator Gain	Antenna Gain (dBd)	Path and Boresight corrections	dBm
346.6	-83.11	-44.83	-14.16	-0.35	0.65	-58.69	1.35
		A	B	C	D	E	

Result (E) = A+B+C+D

Photo: OATS Setup



TRANSIENT FREQUENCY BEHAVIOR

SPECIFICATION: FCC 47 CFR 90.214

GUIDE: TIA/EIA-603D 2.2.19

MEASUREMENT PROCEDURE:

1. Refer Annex A for equipment set up.
2. Measurements and plots were made following the TIA/EIA procedure.

MEASUREMENT RESULTS:

See the tables and plots on the following pages for 12.5 kHz channel spacing.

LIMIT CLAUSE: FCC 47 CFR 90.214

SPECIFICATION: FCC 47 CFR 90.214

Tx FREQUENCY: 173.3 MHz 25 W 12.5 kHz Channel Spacing

173.3 MHz @ 25 W Tx

TRANSIENT RESPONSE PERIOD	CARRIER PEAK VARIATION FROM NORMAL	
	Key ON (kHz)	Key OFF (kHz)
t1	0.6	N/A
t2	-0.7	N/A
t3	N/A	-0.4

Confirm that during periods t1 and t3 the frequency difference does not exceed the value of one channel separation.	YES	NO
	✓	<input type="checkbox"/>
Confirm that during the period t2 the frequency difference does not exceed half a channel separation.	YES	NO
	✓	<input type="checkbox"/>
Confirm that during the period t2 to t3 the frequency difference does not exceed the frequency error limit.	YES	NO
	✓	<input type="checkbox"/>

Measurement Uncertainty: Frequency ± 130 Hz; Time ± 0.2%

LIMIT: FCC 47 CFR 90.214

TRANSIENT PERIODS	FREQUENCY RANGE	
	150 MHz – 174 MHz	421 MHz – 512 MHz
t1 (ms)	5 ms	10 ms
t2 (ms)	20 ms	25 ms
t3 (ms)	5 ms	10 ms

Transient Frequency Behaviour

SPECIFICATION: FCC 47 CFR 90.214

Tx FREQUENCY: 173.3 MHz 25 W 12.5 kHz Channel Spacing

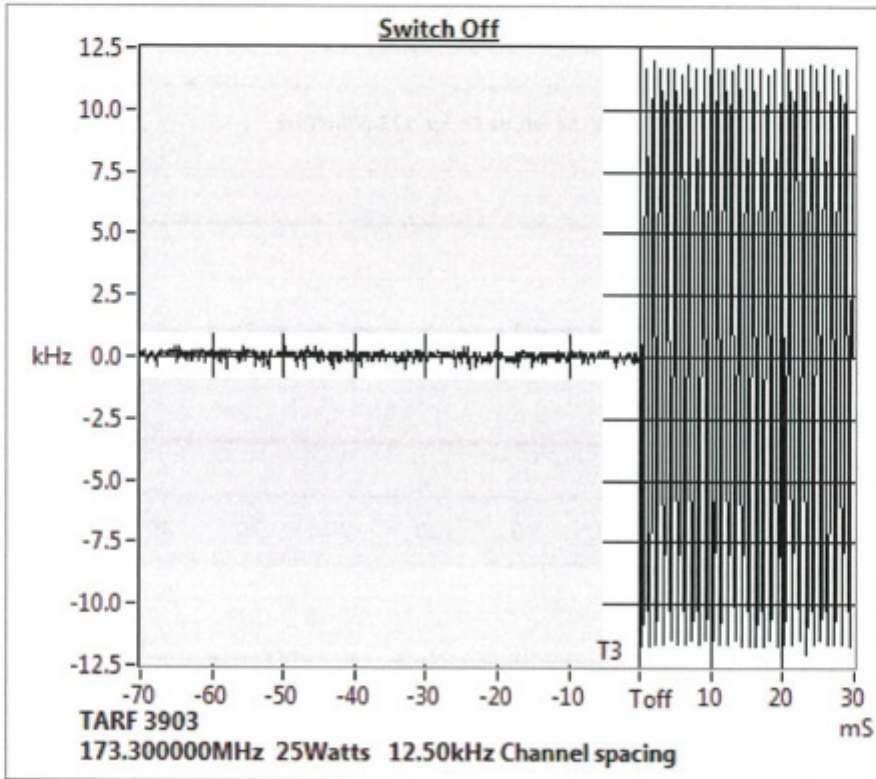
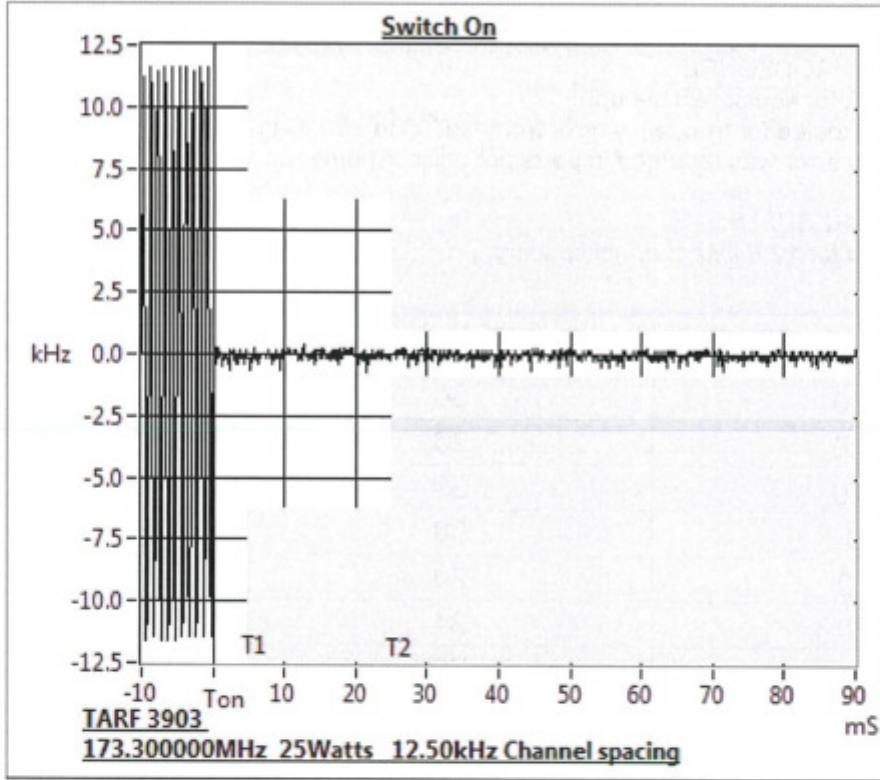

TRANSMITTER FREQUENCY STABILITY - TEMPERATURE

SPECIFICATION: FCC 47 CFR 2.1055 (a) (1)

GUIDE: TIA/EIA-603D 2.2.2

MEASUREMENT PROCEDURE:

1. Refer Annex A for equipment set up.
2. The EUT was tested for frequency error from -30°C to +50°C in 10° C increments
3. The frequency error was recorded in parts per million (ppm).

MEASUREMENT RESULTS:

See the plot below for 12.5 kHz channel spacing.

173.3 MHz

Temperature (°C)	Frequency (Hz)	Error (ppm)
-30	30	0.17
-20	26	0.15
-10	39	0.23
0	38	0.22
10	20	0.12
20	34	0.20
30	29	0.17
40	20	0.12
50	31	0.18
Measurement Uncertainty	$\pm 7 \times 10^{-8}$	

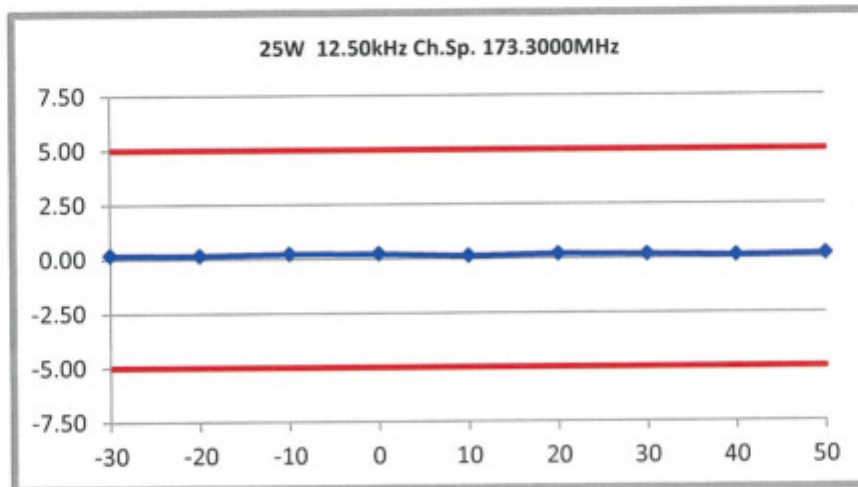

LIMIT: FCC 47 CFR 90.213

Channel Spacing (kHz)	Frequency Error (ppm)
12.5	5.0

TRANSMITTER FREQUENCY STABILITY - VOLTAGE

SPECIFICATION: FCC 47 CFR 2.1055 (d) (1)

GUIDE: TIA/EIA-603D 2.2.2

MEASUREMENT PROCEDURE:

1. Refer Annex A for equipment set up.
2. The EUT was tested for frequency error at an input voltage to the radio of 85% to 115%.
3. The frequency error was recorded in parts per million (ppm).

MEASUREMENT RESULTS:

Voltage	FREQUENCY ERROR (ppm) for 12.5 kHz
	173.3 MHz
13.80 V _{DC}	0.12
11.73 V _{DC}	0.11
15.87 V _{DC}	0.12
Measurement Uncertainty	$\pm 7 \times 10^{-8}$

LIMIT CLAUSE: FCC 47 CFR 90.213

Channel Spacing (kHz)	Frequency Error (ppm)
12.5	5.0

TEST EQUIPMENT LIST

Equipment Type	Information	Manufacturer	Model No	Serial No#	Tait ID	Cal Due
Antenna	Reference Dipoles	Emco	3121C DB1	9510-1164	E3559	14-Apr-19
Antenna	18GHz DRG	Emco	DRG3115	9512-4638	E3560	15-May-20
Antenna	Log Periodic	Schwarzbeck	VUSLP	9111-219	E4617	
Antenna	Reverb - 1-18GHz DRG	Schwarzbeck	BBHA 9120 D	9120D-885	E4857	
Antenna	Reverb - 1-18GHz DRG	Schwarzbeck	BBHA 9120 D	9120D-884	E4858	
Audio Analyser	TREVA2	Hewlett Packard	HP8903B	2818A04275	E3710	6-Oct-18
Coax Cable	2m Black	Suhner	RG214HF/Nm/ Nm/2000	TeltestBlack2	E4623	20-Dec-18
Coax Cable	2m Black	Suhner	RG214HF/Nm/ Nm/2000	TeltestBlack3	E4624	20-Dec-18
Coax Cable	OATS Turntable Cable 1	Intelcom	RG214	OATS1	E4621	1-Jan-19
Coax Cable	OATS Tower Cable	Intelcom	RG214	OATS2	E4622	1-Jan-19
Coax Cable	2m Black	Suhner	RG214HF/Nm/ Nm/2000	TeltestBlack5	E4850	20-Dec-18
Coax Cable	2m Black	Suhner	RG214HF/Nm/ Nm/2000	TeltestBlack6	E4849	20-Dec-18
Coax Cable	Reverb - 4.5m Multiflex 141	TeltestBlue6	MF 141	TeltestBlue6	E4843	20-Dec-18
Coax Cable	Reverb - 2m Multiflex 141	TeltestBlue5	MF 141	TeltestBlue5	E4844	20-Dec-18
Coax Cable	Reverb - 2m Multiflex 141	TeltestBlue4	MF 141	TeltestBlue4	E4845	20-Dec-18
Coax Cable	Reverb - 1m Multiflex 141	TeltestBlue2	MF 141	TeltestBlue2	E4847	20-Dec-18
Coax Cable	Reverb - 1m Multiflex 141	TeltestBlue1	MF 141	TeltestBlue1	E4848	20-Dec-18
Coax Cable	OATS Turntable Cable 2	Intelcom	RG215	OATS3	E4995	1-Jan-19
Coax Cable	2m Black	Suhner	RG214HF/Nm/ Nm/2000	TeltestBlack8	E5005	1-Jan-19
Environ. Chamber	Chest	Contherm	Chest	E3397	E3397	1-Aug-18
Modulation Analyser	TREVA2	Hewlett Packard	HP8901B (Opt 002)	3704A05837	E3786	4-Oct-18
Multimeter		Fluke	77	35069359	E3237	26-Sep-18
OATS	NSA	Tait				9-Jul-18
OATS	Antenna Tower	Electrometrics	EM-4720-2	112	E4447	
OATS	Controller	Electrometrics	EM-4700	119	E4445	
OATS	Turntable	Electrometrics	EM-4704A	105	E4446	
OATS	FCC Listing Registration			837095		8-May-19
Oscilloscope	100MHz Digital	Tektronics	TDS340	B013611	E3585	28-Sep-19
Power Meter	TREVA2 Power Head for HP8901	Hewlett Packard	HP11722A	2716A02037	1575	5-Oct-18
Power Supply		Rohde & Schwarz	NGS M32/10 192.0810.31	Fnr 434	E3556	20-Apr-18
Power Supply	TREVA2 60V/25A	Agilent	N5767A	US09F4901H	E4656	7-Oct-19
Power Supply	60V/50A/1000W	Hewlett Packard	HP6012B	2524A00616	E3712	30-Sep-19
Power Supply	60V/25A	Agilent	N5767A	3111A05573	E4979	10-Oct-18
RF Amplifier	+21.7 dB 1GHz	Tait	ZFL-1000LN	E3660	E3360	17-Apr-19
RF Amplifier	Pre-amplifier	Agilent	87405C	MY47010688	E4941	9-Oct-18
RF Attenuator	30dB 250W	Weinschel	45-30-34	JW663	E3386	20-Dec-18
RF Attenuator	10dB 150W	Weinschel	57-10-34	LB590	E3674	20-Dec-18
RF Attenuator	10dB 50W	Weinschel	24-10-34	AZ0401	E3388	20-Dec-18
RF Attenuator	20dB 50W	Weinschel	24-20-44	AW1266	E3562	20-Dec-18

TELTEST Laboratories
Tait Ltd
Report Number 3903

RF Attenuator	20dB 25W	Weinschel	33-20-33	BD5871	E3673	20-Dec-18
RF Attenuator	TREVA2 20dB 150W	Weinschel	40-20-33	CJ405	E3733	20-Dec-18
RF Attenuator	30dB 350W	Weinschel	67-30-33	BR0531	E4280	20-Dec-18
RF Attenuator	10dB 50W	Weinschel	24-10-34	BC3293	E4364	21-Dec-18
RF Attenuator	TREVA2 3dB	Weinschel	Model 1	BL9950	E4080	20-Dec-18
RF Chamber	S-LINE TEM CELL	Rohde & Schwarz	1089.9296.02	338232/003	E3636	
RF Chamber	Reverb - Stirrer controller for reverb chamber	Teseq	Stirrer Controller	29765.1	E4854	
RF Chamber	Reverb - 0.5 - 18GHz Reverberation Chamber	Teseq	RVC XS	29765	E4855	
RF Combiner	TREVA2	Minicircuits	ZFSC-4-1	-	E4084	
RF Combiner	Three port resistive	Weinschel	1506A	MD719	E5008	22-Aug-18
RF Load	50W	Weinschel	F1426	AE2490	E3624	20-Dec-18
Signal Generator	Analog 4GHz	Agilent	E4422B	GB40050320	E3788	28-Sep-18
Signal Generator	Analog 3.2GHz	Hewlett Packard	HP8648C	3443U00543	E3558	26-Sep-18
Spectrum Analyser	26.5GHz	Agilent	PXA N9030A	MY49432161	E4907	18-Oct-18
Spectrum Analyser	13.2GHz	Hewlett Packard	HP8562E	3821A00779	E3715	2-Oct-18
Spectrum Analyser	13.2GHz	Agilent	E4445A	MY42510072	E4139	15-Oct-18
Temp & Humidity Datalogger		Hobo	U21-011	10134275	E4980	
Testware	Conducted Emissions		16/12/2015	-	-	
Testware	Radiated Emissions		September 2015	-	-	
Testware	Reverb Emissions		28 May 2015	-	-	
Testware	Sideband Spectrum		February 2017	-	-	
Testware	S-Line Radiated Emissions		May 2016	-	-	
Testware	TREVA		December 2015	-	-	

NOTE: Items without calibration dates are calibrated immediately before use, or set using calibrated instruments.

ANNEX A – TEST SETUP DETAILS

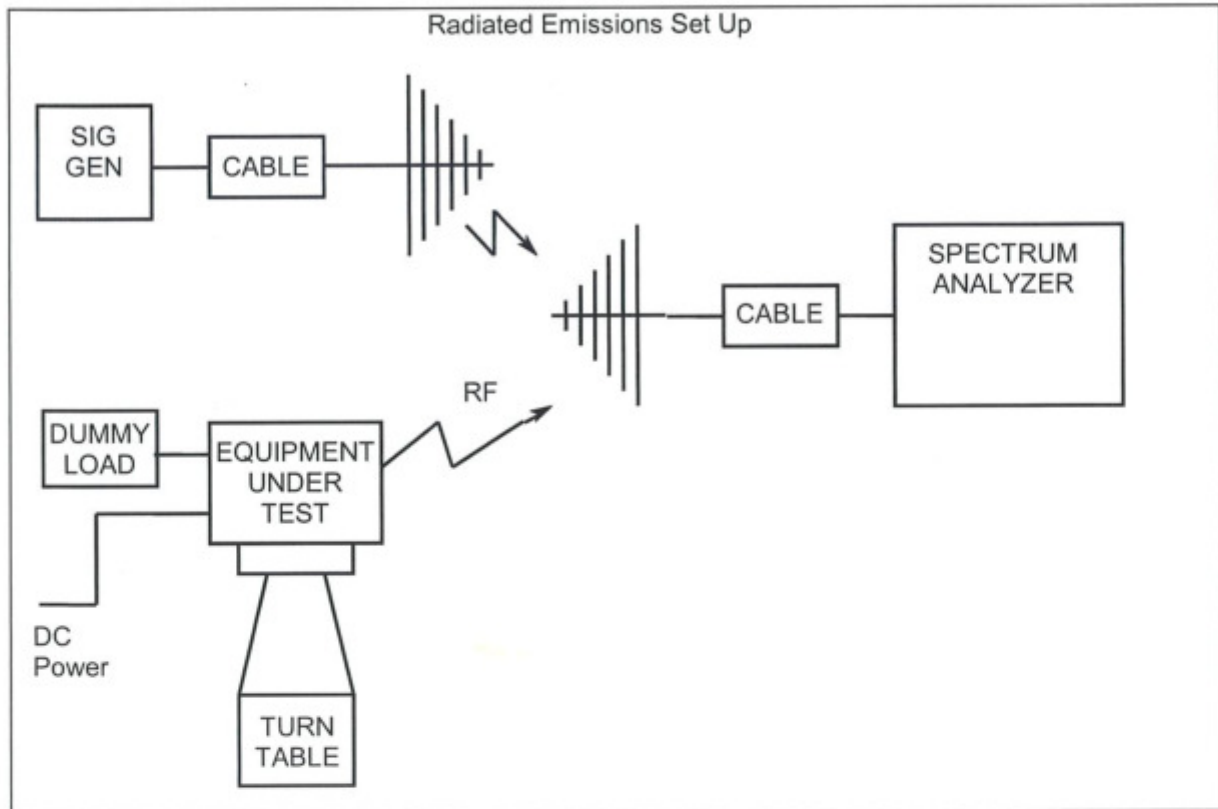

All other testing is performed using the Teltest Radio EVALuation system (TREVA), which is configured as shown below. The Spectrum Analyser is connected to the EUT via the attenuator network for Conducted Emissions testing, and Occupied Bandwidth.

