



TM8000
MOBILES

TM8110/TM8115
OPERATOR'S MANUAL



TAIT: THE RIGHT FIT

www.taitworld.com

Directive 1999/5/EC Declaration of Conformity

da Dansk

Undertegnede Tait Electronics Limited erklærer herved, at følgende udstyr TMAB1A & TMAH5A overholder de væsentlige krav og øvrige relevante krav i direktiv 1999/5/EF. Se endvidere: <http://eudocs.taitworld.com/>

de Deutsch

Hiermit erklärt Tait Electronics Limited die Übereinstimmung der Geräte TMAB1A & TMAH5A mit den grundlegenden Anforderungen und den anderen relevanten Festlegungen der Richtlinie 1999/5/EG.

Siehe auch: <http://eudocs.taitworld.com/>

el Ελληνικός

Με την παρουσία Tait Electronics Limited δηλώνει ότι TMAB1A & TMAH5A συμμορφώνεται προς τις ουσιαστικές απαιτήσεις και τις λοιπές σχετικές διατάξεις της οδηγίας 1999/5/EK.

βλέπε και: <http://eudocs.taitworld.com/>

en English

Tait Electronics Limited declares that this TMAB1A & TMAH5A complies with the essential requirements and other relevant provisions of Directive 1999/5/EC. See also: <http://eudocs.taitworld.com/>

es Español

Por medio de la presente Tait Electronics Limited declara que el TMAB1A & TMAH5A cumple con los requisitos esenciales y cualesquiera otras disposiciones aplicables o exigibles de la Directiva 1999/5/CE. Véase también: <http://eudocs.taitworld.com/>

fi Suomi

Tait Electronics Limited vakuuttaa täten että TMAB1A & TMAH5A tyyppinen laite on direktiivin 1999/5/EY oleellisten vaatimusten ja sitä koskevien direktiivin muiden ehtojen mukainen. Katso: <http://eudocs.taitworld.com/>

fr Français

Par la présente, Tait Electronics Limited déclare que les appareils TMAB1A & TMAH5A sont conformes aux exigences essentielles et aux autres dispositions pertinentes de la directive 1999/5/CE. Voir aussi: <http://eudocs.taitworld.com/>

it Italiano

Con la presente Tait Electronics Limited dichiara che questo TMAB1A & TMAH5A è conforme ai requisiti essenziali ed alle altre disposizioni pertinenti stabilite dalla direttiva 1999/5/CE. Vedi anche: <http://eudocs.taitworld.com/>

nl Nederlands

Hierbij verklaart Tait Electronics Limited dat het toestel TMAB1A & TMAH5A in overeenstemming is met de essentiële eisen en de andere relevante bepalingen van richtlijn 1999/5/EG. Zie ook: <http://eudocs.taitworld.com/>

pt Português

Tait Electronics Limited declara que este TMAB1A & TMAH5A está conforme com os requisitos essenciais e outras provisões da Directiva 1999/5/CE. Veja também: <http://eudocs.taitworld.com/>

sv Svensk

Härmed intygar Tait Electronics Limited att denna TMAB1A & TMAH5A står i överensstämmelse med de väsentliga egenskapskrav och övriga relevanta bestämmelser som framgår av direktiv 1999/5/EG. Se även: <http://eudocs.taitworld.com/>

Copyright and trademarks

All information contained in this document is the property of Tait Electronics Limited. All rights reserved. This document may not, in whole or in part, be copied, photocopied, reproduced, translated, stored, or reduced to any electronic medium or machine-readable form, without prior written permission from Tait Electronics Limited.

The word TAIT and the TAIT logo are trademarks of Tait Electronics Limited.

All trade names referenced are the service mark, trademark or registered trademark of the respective manufacturers.

Disclaimer

There are no warranties extended or granted by this document. Tait Electronics Limited accepts no responsibility for damage arising from use of the information contained in the document or of the equipment and software it describes. It is the responsibility of the user to ensure that use of such information, equipment and software complies with the laws, rules and regulations of the applicable jurisdictions.

Enquiries and comments

If you have any enquiries regarding this document, or any comments, suggestions and notifications of errors, please contact Technical Support.

Updates of manual and equipment

In the interests of improving the performance, reliability or servicing of the equipment, Tait Electronics Limited reserves the right to update the equipment or this document or both without prior notice.

Intellectual property rights

This product may be protected by one or more patents of Tait Electronics Limited together with their international equivalents, pending patent applications and registered trade marks: NZ508806, NZ508807, NZ509242, NZ509640, NZ509959, NZ510496, NZ511155, NZ511421, NZ516280/NZ519742, NZ520650/NZ537902, NZ521450, NZ522236, NZ524369, NZ524378, NZ524509, NZ524537, NZ524630, NZ530819, NZ534475, NZ534692, NZ535471, NZ537434, NZ546295, NZ547713, AU2003281447, AU2004216984, AU2005207405,

AU2005267972, CA2554213, CA2574670, EU1,532,866, EU1,599,792, EU05704655.9, GB23865476, GB2386010, GB2413249, GB2413445, US11/232716, US10/597339, US10/520827, US5,745,840, US10/547653, US10/546696, US10/546,697, US10/520827, US10/547964, US10/523952, US11/572700.

Environmental responsibilities

Tait Electronics Limited is an environmentally responsible company which supports waste minimization, material recovery and restrictions in the use of hazardous materials.



The European Union's Waste Electrical and Electronic Equipment (WEEE) Directive requires that this product be disposed of separately from the general waste stream when its service life is over. For more information about how to dispose of your unwanted Tait product, visit the Tait Electronics WEEE website at www.taitworld.com/weee. Please be environmentally responsible and dispose through the original supplier, or contact Tait Electronics Limited.

Tait Electronics Limited also complies with the Restriction of the Use of Certain Hazardous Substances in Electrical and Electronic Equipment (RoHS) Directive in both the European Union and China.

In China, we comply with the Measures for Administration of the Pollution Control of Electronic Information Products. We will comply with environmental requirements in other markets as they are introduced.

About this guide

This operator's manual provides information about the TM8110 and TM8115 mobile radios. If you need further assistance or your radio does not operate as you expect, contact your radio provider.



Website: For information about how to install your TM8100 radio, go to www.taitworld.com/technical.

For your safety

Before using your radio, please read the following important safety and compliance information.

Safety warnings used in this guide

Within this guide, the following conventions are used to alert you to important safety information:



Warning: There is a potential risk of death or serious injury.



Caution: There is the risk of minor or moderate injury to people.

Caution: “Caution” is used without the safety alert symbol when there is a risk of equipment damage or malfunction.

Radio frequency exposure information

For your own safety and to ensure you comply with the Federal Communication Commission’s (FCC) radio frequency (RF) exposure guidelines, please read the following information before using this radio.

Using this radio

You should use this radio only for work-related purposes (it is not authorized for any other use) and if you are fully aware of, and can exercise control over, your exposure to RF energy. To prevent exceeding FCC RF exposure limits, you must control the amount and duration of RF that you and other people are exposed to.

It is also important that you:

Note: Do not remove the RF exposure label from the radio.

- Ensure this RF exposure information accompanies the radio when it is transferred to other users.
- Do not use the radio if you do not adhere to the guidelines on controlling your exposure to RF.

Controlling your exposure to RF energy

This radio emits RF energy or radio waves primarily when calls are made. RF is a form of electromagnetic energy (as is sunlight), and there are recommended levels of maximum RF exposure.

To control your exposure to RF and comply with the maximum exposure limits for occupational/controlled environments, follow these guidelines:

- Do not talk (transmit) on the radio more than the rated transmit duty cycle. This is important because the radio radiates more energy when it is transmitting than when it is receiving.
- While you are transmitting (talking or sending data) on the radio, you must ensure that there is always a distance of 0.9m (35 inches) between people and the antenna. This is the minimum safe distance.
- Use the radio only with Tait-approved antennas and attachments, and make only authorized modifications to the antenna otherwise you could damage the radio and violate FCC regulations.



Website: For more information on what RF energy is and how to control your exposure to it, go to www.fcc.gov/oet/rfsafety/rf-faqs.html.

Compliance with RF energy exposure standards

This two-way radio complies with these RF energy exposure standards and guidelines:

- United States Federal Communications Commission, Code of Federal Regulations; 47 CFR 1.1307, 1.1310 and 2.1091
- American National Standards Institute (ANSI) / Institute of Electrical and Electronic Engineers (IEEE) C95. 1-1992
- Institute of Electrical and Electronic Engineers (IEEE) C95.1-1999 Edition.

This radio complies with the IEEE (FCC) and ICNIRP exposure limits for occupational/controlled RF exposure environments at operating duty factors of up to 50 % talk to 50 % listen.

Radio frequency emissions limits in the USA

Part 15 of the FCC Rules imposes RF emission limits on electronic equipment to prevent interference to reception of broadcast services.

This device complies with Part 15 of the FCC Rules. Operation is subject to the condition that this device does not cause harmful interference.

Note: Changes or modifications to this device that are not expressly approved by Tait Electronics Limited may make its use illegal.

Unapproved modifications or changes to radio

The radio is designed to satisfy the applicable compliance regulations. Do not make modifications or changes to the radio that are not expressly approved by Tait Electronics Limited. Failure to do so could invalidate compliance requirements and void the user's authority to operate the radio.

Health, safety and electromagnetic compatibility in Europe

In the European Union, radio and telecommunications equipment is regulated by Directive 1999/5/EC, also known as the Radio and Telecommunications Terminal Equipment (R&TTE) directive. The requirements of this directive include protection of health and safety of users, as well as electromagnetic compatibility.

Intended use

This product is an FM radio transceiver. It is intended for radiocommunication in the Private Mobile Radio (PMR) or Public Access Mobile Radio (PAMR) services, to be used in all member states of the European Union (EU) and states within the European Economic Area (EEA).

Restrictions

This product can be programmed to transmit on frequencies that are not harmonised throughout the EU/EEA, and will require a licence to operate in each member state.

This product can be programmed for frequencies or emissions that may make its use illegal. Where applicable, a license must be obtained before this product is used. All license requirements must be observed. Limitations may apply to transmitter power, operating frequency, channel spacing, and emission.

Declaration of conformity

Brief Declarations of Conformity appear on [page 3](#).



Website: To download the formal declaration of conformity, go to <http://eudocs.taitworld.com>.

A signed and dated paper copy of the declaration of conformity can be obtained from Tait Europe Limited.

Electromagnetic compatibility in European vehicles

In the European Community, radio equipment fitted to automotive vehicles is regulated by Directive 72/245/EEC, as amended by 95/54/EC. The requirements of this directive cover the electromagnetic compatibility of electrical or electronic equipment fitted to automotive vehicles.

Note: To meet the requirements of Directive 72/245/EEC (as amended by 95/54/EC) installation of this product in a vehicle must be performed according to the instructions provided, and any guidelines of the vehicle manufacturer.

EN 60950 requirements (25 watt radios)

This radio complies with the European Union standard EN 60950 when operated up to the rated 33% duty cycle of two minutes transmit and four minutes receive, and with ambient temperatures of 30°C or lower.



Caution: Operation outside these limits may cause the external temperature of the radio to rise higher than this standard permits.

Interference with electronic devices

Some electronic devices may be prone to malfunction due to the lack of protection from RF energy that is present when your radio is transmitting.

- Examples of electronic devices that may be affected by RF energy are:
 - vehicular electronic systems such as fuel injection, anti-skid brakes, and cruise control
 - medical devices such as hearing aids and pacemakers
 - medical equipment in hospitals or health care facilities.

Consult the manufacturer (or its representative) of the equipment to determine whether these electronic circuits will perform normally when the radio is transmitting.

Frequency band reserved for distress beacons

Frequency band 406 to 406.1 MHz is reserved for use by distress beacons. Transmissions should not be made within this frequency band.

Safe radio operation



Warning: Observe the following safe operating practices:

- Switch the radio off at petrol filling stations or near flammable liquids or gases.
- Switch the radio off in the vicinity of explosive devices and blasting zones.
- Using a handheld microphone or a radio while driving a vehicle may violate the laws and legislation that apply in your country or state. Please check the regulations in your area.

High radio surface temperatures

The bottom surface of the radio and the heatsink fins can become hot during prolonged operation. Do not touch these parts of the radio.

Radio protection when charging the vehicle battery

Always remove the fuses from the radio power cable before charging the vehicle battery, connecting a second battery or using power from another vehicle (e.g. when jump-starting the vehicle).

GPS operation

Tait Electronics Limited is not responsible for the operation or failure of operation of GPS satellites or the availability of GPS satellite signals.

Acknowledgement:

The radio uses an implementation of UTM conversion sourced (with permission) from Geoscience Australia (GA).

Radio controls

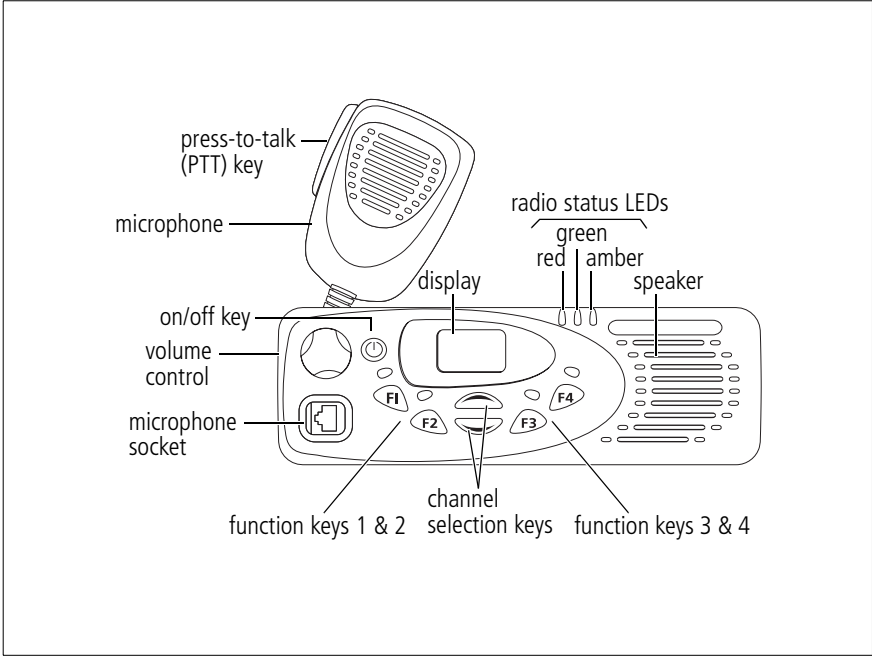

Contents

Directive 1999/5/EC Declaration of Conformity	3
Updates of manual and equipment	4
About this guide	5
For your safety	6
Safety warnings used in this guide	6
Radio frequency exposure information	6
Controlling your exposure to RF energy	7
Compliance with RF energy exposure standards	8
Radio frequency emissions limits in the USA	8
Unapproved modifications or changes to radio	8
Health, safety and electromagnetic compatibility in Europe	9
Electromagnetic compatibility in European vehicles	10
EN 60950 requirements (25 watt radios)	10
Interference with electronic devices	11
Frequency band reserved for distress beacons	11
Safe radio operation	11
High radio surface temperatures	12
Radio protection when charging the vehicle battery	12
GPS operation	12
Your radio's settings	13
Getting started	17
About the radio controls	17
Understanding the radio indicators	19
Basic operation	21
Turning the radio on and off	22
Unlocking your radio	22
Adjusting the speaker volume	22
Selecting a channel or group	22
Checking that a channel is clear	23

Activating the repeater before a call	24
Making a call	25
Making a preset call	26
Transmitting at low power	26
Making an emergency call	27
Ending all active calls	28
Communicating directly with other radios	29
Hearing faint and noisy signals	30
Using the radio in different repeater areas	31
Scanning a group of channels	32
Receiving a call	34
Customizing radio settings	35
Changing the external alert option	35
Changing the volume of all audible tones	35
Changing the volume of keypress tones	35
Changing to quiet operation	36
Changing to silent operation	36
Changing backlighting settings	36
Troubleshooting	37
When your radio won't turn on	37
Removing the microphone	37
Reinstalling the microphone	38
Removing the radio from the vehicle	38
Describing the radio's audible tones	39
Licence agreement	41

Getting started

This section provides a brief description of your radio's controls and indicators.

The following topics are covered in this section:

- [about the radio controls](#)
- [understanding the radio indicators](#)
- [status LED indicators](#)
- [audible tones](#)

About the radio controls

The radio controls are the PTT key, volume control, on/off key, scroll keys, channel selection keys and function keys. Some keys may have functions assigned to both short and long key presses:

- a short key press is less than one second, and
- a long key press is more than one second.

The radio controls and their functions are summarized in the following diagram and table.

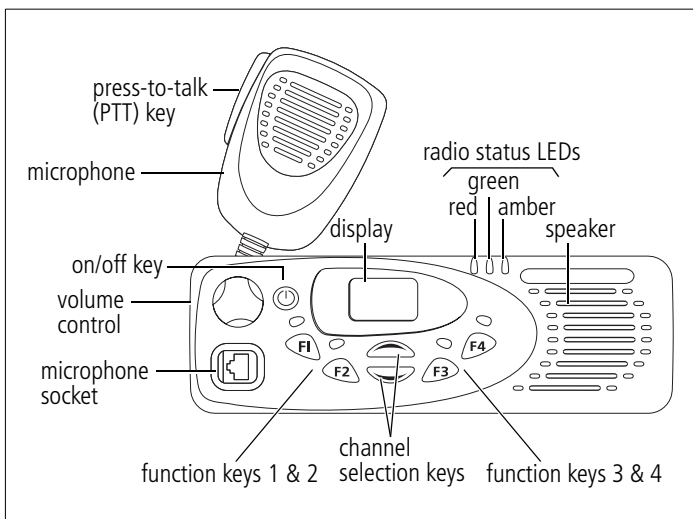

Symbol	Name	Function
	PTT key	Press and hold to transmit and release to listen
	Volume control	Rotate to change the speaker volume
Ⓞ	On/off key	Turn the radio on or off with a long press
⬆ ⬇ ⬆	Channel Selection keys	Move up and down through a list of channels and groups
	Function keys	Function keys with programmed options

Understanding the radio indicators

The status LED indicators and the radio's audible tones all combine to give you information about the state of your radio.

The most common way the indicators work is described in the following sections.

Note: The way these indicators behave may be affected by the way your radio is programmed.

Status LED indicators

LED	Meaning
red (transmit)	Glowing: your radio is transmitting Flashing: your transmit timer is about to expire, or your radio is stunned
green (receive)	Glowing: there is activity on the current channel, even though you may not be able to hear it Flashing: you have received a call with valid special signalling, or you have activated monitor or squelch override
amber (scanning or network)	Glowing: your radio is scanning a group of channels for activity or greatest signal strength Flashing: your radio has detected activity on a channel, and has halted on this channel

Audible tones

Note: If quiet or silent mode has been turned on, you will not hear any audible tones.

For a description of other tones you may hear, see [“Describing the radio’s audible tones” on page 39.](#)

Tone type	Meaning
one short beep after the power-up beeps	Radio locked: you need to enter a personal identification number (PIN) before you can use your radio
two short beeps	Radio turned on: the radio is powered on and ready to use
one short beep	Radio turned off: the radio is being powered off, or Valid key press: the action you have attempted is permitted, or Function activated: a function key has been pressed and that function has been activated
one long, low-pitched beep	Invalid key press: the action you have attempted is not permitted, or Transmission inhibited: you have attempted to transmit but for some reason transmission is not permitted at this time
one short, low-pitched beep	Function deactivated: a function key has been pressed and the corresponding function has been turned off
three short beeps	Channel now free: you were prevented from transmitting on a busy channel and that channel is now free
three beeps	Transmit timeout imminent: in 10 seconds your transmit timer will expire and your current transmission will be terminated

Basic operation

This section describes the basic operation of your radio.

The following topics are covered in this section:

- turning the radio on and off
- unlocking your radio
- adjusting the speaker volume
- selecting a channel or group
- checking that a channel is clear
- activating the repeater before a call
- making a call
- making a preset call
- transmitting at low power
- making an emergency call
- ending all active calls
- communicating directly with other radios
- hearing faint and noisy signals
- using the radio in different repeater areas
- scanning a group of channels
- receiving a call

Turning the radio on and off

Give a long press of the on/off key to turn the radio either on or off.

When the radio is first turned on, the red, green and amber LEDs flash briefly and the radio gives two short beeps.

Unlocking your radio

You may need to enter a personal identification number (PIN) before you can use your radio. If the display shows either — or — — after power-up, enter your assigned PIN.

Once you have entered your PIN correctly, the radio sounds two short beeps and normal operation is now possible.



If you do not know your PIN or if your radio gives a long, low-pitched beep, consult your radio provider or administrator.

Adjusting the speaker volume

Note: The volume control also changes the volume level of the radio's audible indicators.

Rotate the volume control clockwise to increase the speaker volume and counterclockwise to decrease the volume.

Selecting a channel or group

Use the channel selection keys  or  to scroll through the channel list until the channel or group you want is appears in the display.

A group can be either a voting group (see [“Using the radio in different repeater areas” on page 31](#)) or a scan group ([“Scanning a group of channels” on page 32](#)).

Checking that a channel is clear

You or your user group may be segregated from other user groups by special signalling. If an incoming call carries the special signalling tones specific to you or your user group, your radio's signalling mute opens and you can hear the call. These tones may not be audible.

The monitor function may allow you to override any special signalling on a channel, so that you can check that the channel is clear before you make a call.

Note: Your radio may be programmed to activate monitor whenever the microphone is off the microphone clip.

To activate monitor, you may be able to either:

- remove the microphone from the microphone clip, or
- use a programmed function key.

Activating monitor by using a function key

To activate monitor and hear any traffic on the channel:

- 1 Press the function key programmed for monitor.
While monitor is on, the green LED flashes slowly.
- 2 Press the monitor function key again to turn monitor off.
When monitor turns off, the green LED stops flashing.

Note: Your radio may be programmed so that monitor turns off automatically after a short time.

Activating the repeater before a call

A repeater-access tone is sent to activate the repeater before a call is made, so that the start of the call is not lost. To send a repeater-access tone, you may be able to either:

- use the PTT key, or
- use a programmed function key.

Sending a repeater-access tone using the PTT key

- 1 Press the PTT key.

The repeater-access tone for the current channel is sent, the red LED glows and you may also hear signalling tones.

- 2 Press and hold the PTT and proceed with your call.



Sending a repeater-access tone using a function key

- 1 Press the function key programmed for sending a repeater-access tone.

The repeater-access tone for the current channel is sent, the red LED glows and you may also hear signalling tones.

- 2 Press and hold the PTT and proceed with your call.

Making a call

- 1 Select the required channel or scan group using the channel selection keys  or .
- 2 Check that the channel is clear. If the green LED is glowing, the channel is busy and you may not be able to transmit.
- 3 Once the channel is clear (the green LED is off), lift the microphone off the microphone clip.
- 4 Hold the microphone about 5 cm (2 inches) from your mouth.
- 5 Press and hold the PTT key to transmit.
- 6 Speak clearly into the microphone and release the PTT key when you have finished talking.

While you are transmitting, the red LED glows.

Transmit timer

Your radio may have a transmit timer that limits the amount of time you can transmit continuously.

When the transmit timer is about to expire, the red LED flashes and the radio gives three beeps. You must release the PTT before you can transmit again.



Note: Your radio may be unable to transmit for a short time after the transmit timer has expired.

Making a preset call

You may be able to make preset calls to other radios by using a programmed function key. There are two types of preset calls that may be available:

- channel preset calls, or
- network preset calls.

Making a channel preset call

- 1 Select the required channel using the channel selection keys  or .
- 2 Press the assigned function key to make the call.

Alternatively, your radio may be programmed so that a preset call can be sent with a press of the PTT key. In this case, press the PTT key to make the preset call.
- 3 When the called party responds, proceed with your conversation.

Making a network preset call

Note: When making a network preset call, it is not necessary to change channels.

- 1 Press the assigned function key to make the call.
- 2 When the called party responds, proceed with your conversation.

Transmitting at low power

If you want to transmit at low power, you can override your radio's programmed power settings by using a function key programmed for low-power transmit.

To transmit at low power on your current channel:

- Press the function key programmed for low-power transmit.

When the function key is pressed again, transmission is at the programmed power level.

Making an emergency call

You may be able to activate emergency mode by using a programmed function key or a hidden emergency switch.

- 1 Press the function key programmed for Emergency Mode or the hidden emergency switch. An emergency call is sent to your dispatcher, or some other predetermined location.

While emergency mode is active, your radio may cycle between receive and transmit, so that your dispatcher can hear any activity near the radio. Alternatively, your radio may appear to turn off but will actually remain in emergency mode.

- 2 **Reset the radio to normal operation at any time by turning the radio off and then on.**

Note: Emergency mode may be programmed to end after a fixed period of time. In this case, there is no need to turn the radio off and then on in order to return the radio to normal operation.

Ending all active calls

You may have a function key programmed to either end the current call, or end the current call and all other active calls in your group.

This can be done either by:

- using the function key programmed for reset monitor to end your current call,
- using the function key programmed for call cleardown to end your current call and all other calls in your group, or
- using the function key programmed for both reset monitor and call cleardown.

Ending your current call by using a function key

- Press the function key programmed for reset monitor.

The radio's monitor is turned off, ending your current call and the green LED stops flashing.

Ending all active calls by using a function key

- Press the function key programmed for call cleardown.

Monitor is turned off for all radios in your radio group. Any call in progress or incoming call is ended and the green LED stops flashing.

Ending active calls by using the function key programmed for reset monitor/call cleardown

The function key programmed for reset monitor may be programmed so that:

- a short key press ends your current call, and
- a long key press ends all active calls in your group.

Communicating directly with other radios

You can bypass the radio repeater and communicate directly with another radio. This feature is known as repeater talkaround. You can do this, for example, when you are out of range of the repeater, or if the repeater is busy or stops working.

While repeater talkaround is active, all transmissions are made on the receive frequency of the channel you are on.

To activate repeater talkaround:

- 1 Select the required channel.
- 2 Press the programmed function key programmed for to turn repeater talkaround on.
- 3 Proceed with your call.
- 4 To turn repeater talkaround off, either change the channel or press the function key again.

Hearing faint and noisy signals

Your radio's squelch allows the radio to unmute only when the strength of the incoming signal is above a predetermined threshold. This means that only signals of reasonable intelligibility are made audible. To make faint and noisy signals audible, use the squelch override function to unmute the radio.

To activate squelch override and unmute the radio:

- Press the function key programmed for squelch override.

While squelch override is on, the green LED flashes continually.

Squelch override remains on until there is a further key press.

Turning squelch override on and off by using the function key programmed for monitor

The function key programmed for monitor may be programmed so that a short key press turns monitor on, and a long key press turns squelch override on.

To activate squelch override and unmute the radio:

- Press and hold the function key programmed for monitor.



While squelch override is on, the green LED flashes continually.

Squelch override remains on until there is a further long key press.

Using the radio in different repeater areas

Your radio may have a group of channels programmed as a voting group. The channels in the voting group all carry the same traffic, but from different repeaters. As your radio moves in and out of different repeater coverage areas, the best communication channel is automatically selected for you to use, until a better communications channel is selected.

While voting is active, the amber LED glows and the display shows:

- the transmit channel,
- the voting group number, or
-  or .

Activating voting

Voting can be activated by selecting a voting group (see [“Selecting a channel or group” on page 22](#)) or by using a function key programmed for voting.

Suspending a channel from a voting group

You may be able to use the function key programmed for nuisance delete to temporarily delete one of the channels from the voting group.

When that voting group is next selected, or after the radio has been turned off and then on, the deleted channel is again part of the voting group.



Alternatively, the function key programmed for voting may be programmed so that a short key press turns on voting, and a long key press activates nuisance delete.

- Press and hold the function key programmed for voting to remove the current channel from the voting group.

Scanning a group of channels

The scan function is used to monitor a programmed group of channels, looking for activity. While the radio is scanning for activity, the amber LED glows. When activity is detected on a channel in the scan group, the radio stops on that channel. The amber LED begins flashing, the radio unmutes and you can hear the call. Scanning resumes once the channel is no longer busy.

While scanning is active, the amber LED glows and the display shows:

- the transmit channel,
- the scan group number, or
-  or .

Standard and background scanning

The two types of scanning that may be available on your radio are standard scanning, and background scanning. Background scan can only be activated by using a function key programmed for background scan. It differs from standard scanning in that the channel that was selected when background scan was activated is also included as a scan-group member.

Activating scanning

Scanning can be activated by selecting a scan group (see [“Selecting a channel or group” on page 22](#)) or by using a function key programmed for scanning.

Making a call while scanning

If you wish to make a call while your radio is scanning:

- 1 Lift the microphone off the microphone clip.
- 2 Press the PTT key to transmit. If the amber LED is flashing, your radio will now call the currently selected channel.
- 3 If standard scan is active and there has been no recent activity on the channel (the amber LED is glowing rather than flashing), then the channel that is called depends on the way your radio has been programmed. The possible options are:
 - your radio calls a predetermined channel e.g. your dispatcher,
 - your radio calls the channel where activity was last detected, or
 - your radio calls the last free channel.
- 4 When the called party responds, proceed with your conversation.

Suspending a channel from a scanning group

If a member channel of a scan group is busy for a long time and you do not wish to hear the conversation, you may be able to use the function key programmed for nuisance delete to temporarily delete it from the scan group.

When the scan group is next selected, or after the radio has been turned off and then on, the deleted channel is again part of the scan group.

Alternatively, the function key programmed for scanning may be programmed so that:

- a short key press turns on scanning, and
- a long key press activates nuisance delete.

Press and hold the function key programmed for scanning to remove the current channel from the scanning group.

Receiving a call

When there is valid activity on your radio's currently selected channel or group, the radio then unmutes and you can hear the call.

If the incoming call contains special signalling that matches the signalling programmed for your radio, the green LED flashes and your radio may give a ringing tone.

Customizing radio settings

This section describes the ways in which you can customize your radio.

The following settings are described in this section:

- [changing the external alert option](#)
- [changing the volume of all audible tones](#)
- [changing the volume of keypress tones](#)
- [changing to quiet operation](#)
- [changing to silent operation](#)
- [changing backlighting settings](#)

Changing the external alert option

If you are away from your radio and unable to answer calls immediately, an external alert, such as a car horn, may activate when you receive a call. The external alert continues for a period of time and is then turned off.

To turn external alert on or off:

- Press the assigned function key.

Changing the volume of all audible tones

You can set the volume of all the audible tones to either high or low. Audible tones include incoming call tones, warning tones and confirmation tones.

To change the volume of your radio's audible tones:

- Press the assigned function key.

Changing the volume of keypress tones

Whenever you press the radio keys, the keypress tones give you an audible indication as to whether or not your action is allowed. A short, medium-pitched beep indicates that an action is allowed. A long, low-pitched beep indicates that the action is not allowed.

You may be able to use a function key to change the volume of your keypress tones in the following ways:

- Press the assigned function key to change the volume of your radio's keypress tones between high and low.
- Press the assigned function key to turn keypress tones either on or off.

Changing to quiet operation

When quiet operation is on, keypress tones and confirmation tones are turned off. Incoming call tones, signalling tones and warning tones all remain audible.

To turn quiet operation on or off:

- Press the assigned function key.

Changing to silent operation

When silent operation is on, all the radio's audible tones are turned off, and only channel traffic can be heard.

To turn silent operation on or off:

- Press the assigned function key.

Changing backlighting settings

Whenever a key is pressed or a call is received, the keypad and display light up automatically. Backlighting only remains on for a few seconds, unless there is further radio activity.

You may be able to use a function key to change the way your backlighting operates in the following ways:

- Press the assigned function key to turn backlighting on. Backlighting remains on for a few seconds, and then turns off.
- Press the assigned function key to turn backlighting on. Backlighting then remains on until there is a further key press
- Short press the assigned function key to turn backlighting on momentarily. Long press the assigned function key to turn backlighting on. Backlighting then remains on until there is a further long key press.

Troubleshooting

The following topics are covered in this section:

- [when your radio won't turn on](#)
- [removing the microphone](#)
- [reinstalling the microphone](#)
- [removing the radio from the vehicle](#)
- [describing the radio's audible tones](#)

When your radio won't turn on

If the red, green and amber LEDs on the control head do not light up when the radio is turned on, it is likely that no power is reaching the radio. Check the following:

- Is the power connector firmly plugged into the rear of the radio?
- Are the in-line fuses in good condition?
- Is the power cable securely connected to the vehicle battery or power supply?

If all appears to be in order, then contact your radio provider for further assistance.

Removing the microphone

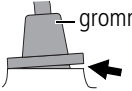
- 1 Using your thumb or forefinger, lift up one of the corners of the microphone grommet. Firmly (but gently) pull that corner until the seal comes away from the cavity. 
- 2 Repeat to expose another corner.
- 3 Pull the exposed corners back and slide the grommet up the microphone cable to reveal the microphone plug.
- 4 Remove the plug from the microphone socket.

Caution: The microphone grommet must be installed whenever the microphone is plugged into the microphone socket.

Reinstalling the microphone

Caution: The microphone grommet must be installed whenever the microphone is plugged into the microphone socket.

- 1 Plug the microphone into the microphone socket.
- 2 Slide the microphone grommet along the microphone cord and push two adjacent corners of the grommet into the microphone socket cavity.
- 3 Squeeze the grommet and push the remaining corners into position.
- 4 Check that the grommet is seated correctly in the cavity.



Removing the radio from the vehicle

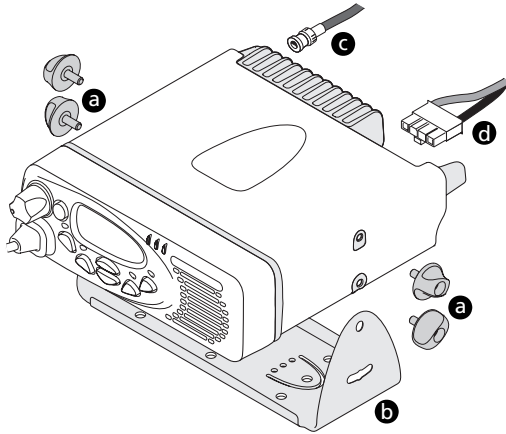

- 1 Switch off the radio.
- 2 Unscrew the four thumb screws **a** that secure the radio to the U-bracket **b**.
- 3 Carefully lift the radio clear of the U-bracket.
- 4 Disconnect the antenna **c** and power cable **d** from the rear of the radio.

Describing the radio's audible tones

The following table summarizes the radio's audible tones.

Action and tone	Meaning
two short beeps	Radio turned on: the radio is powered on and ready to use
one short beep after the power-up beeps	Radio locked: you need to enter your personal identity number (PIN) before you can use the radio
one long, low-pitched beep	Radio PIN entry unsuccessful: you need to re-enter your PIN
two short beeps	Radio PIN entry successful: the radio is now ready to use
one short beep	Function activated: a function key has been pressed and that function has been initiated, or radio turned off: the radio is powered off, or valid key press: the action you have attempted is permitted
one short, low-pitched beep	Function deactivated: a function key has been pressed and the corresponding function has been turned off
one long, low-pitched beep	Invalid key press: the action you have attempted is not permitted, or transmission inhibited: you have attempted to transmit but for some reason transmission is not permitted at this time
one short, high-pitched beep	Radio is stunned: the radio has been made inoperable by your service provider
two short beeps	Radio is revived: the radio has been made operable by your service provider
three beeps	Transmit timeout imminent: in 10 seconds your transmit timer will expire and your current transmission will be terminated
two low-pitched beeps	Radio's temperature is high: the radio's temperature is in the high-temperature range, but the radio will continue to operate

Action and tone Meaning

two high-pitched beeps	Radio's temperature is very high: the radio's temperature is in the very high temperature range and all transmissions will now be at low power; if the radio's temperature rises outside this range, transmissions will be inhibited, or antenna problem: your radio's antenna may be damaged or not connected; check the antenna connection at the rear of the radio and, if the problem continues, contact your service provider
continuous low-pitched tone	Radio system error: a system error has occurred and the radio may be inoperable. The display may show E , E1 or E2 .
two long low-high pitched tone pairs	Synthesizer is out-of-lock: the radio's synthesizer is out-of-lock on the current channel and you cannot operate on that channel. The display may show L or OL .

Licence agreement

This legal document is an Agreement between you (the "Licensee") and Tait Electronics Limited ("Tait"). By using any of the Software or Firmware items prior-installed in the related Tait product, included on CD or downloaded from the Tait website, (hereinafter referred to as "the Software or Firmware") you agree to be bound by the terms of this Agreement. If you do not agree to the terms of this Agreement, do not install and use any of the Software or Firmware. If you install and use any of the Software or Firmware that will be deemed to be acceptance of the terms of this licence agreement.

The terms of this Agreement shall apply subject only to any express written terms of agreement to the contrary between Tait and the Licensee.

LICENCE

TAIT GRANTS TO YOU AS LICENSEE THE NON-EXCLUSIVE RIGHT TO USE THE SOFTWARE OR FIRMWARE ON A SINGLE MACHINE PROVIDED YOU MAY ONLY:

- 1 COPY THE SOFTWARE OR FIRMWARE INTO ANY MACHINE READABLE OR PRINTED FORM FOR BACKUP PURPOSES IN SUPPORT OF YOUR USE OF THE PROGRAM ON THE SINGLE MACHINE (CERTAIN PROGRAMS, HOWEVER, MAY INCLUDE MECHANISMS TO LIMIT OR INHIBIT COPYING, THEY ARE MARKED "COPY PROTECTED"), PROVIDED THE COPYRIGHT NOTICE MUST BE REPRODUCED AND INCLUDED ON ANY SUCH COPY OF THE SOFTWARE OR FIRMWARE;
AND / OR
- 2 MERGE IT INTO ANOTHER PROGRAM FOR YOUR USE ON THE SINGLE MACHINE (ANY PORTION OF ANY SOFTWARE OR FIRMWARE MERGED INTO ANOTHER PROGRAM WILL CONTINUE TO BE SUBJECT TO THE TERMS AND CONDITIONS OF THIS AGREEMENT).

THE LICENSEE MAY NOT DUPLICATE, MODIFY, REVERSE COMPILE OR REVERSE ASSEMBLE ANY SOFTWARE OR FIRMWARE IN WHOLE OR PART.

IMPORTANT NOTICE

THE SOFTWARE OR FIRMWARE MAY CONTAIN OPEN SOURCE SOFTWARE COMPONENTS ("OPEN SOURCE COMPONENTS"). OPEN SOURCE COMPONENTS ARE EXCLUDED FROM THE TERMS OF THIS AGREEMENT EXCEPT AS EXPRESSLY STATED IN THIS AGREEMENT AND ARE COVERED BY THE TERMS OF THEIR RESPECTIVE LICENCES WHICH MAY EXCLUDE OR LIMIT ANY WARRANTY FROM OR LIABILITY OF THE DEVELOPERS AND/OR COPYRIGHT HOLDERS OF THE OPEN SOURCE COMPONENT FOR THE PERFORMANCE OF THOSE OPEN SOURCE COMPONENTS. YOU AGREE TO BE BOUND BY THE TERMS AND CONDITIONS OF EACH SUCH LICENCE. FOR MORE INFORMATION SEE: <http://support.taitworld.com/go/opensource>

TITLE TO SOFTWARE

THIS AGREEMENT DOES NOT CONSTITUTE A CONTRACT OF SALE IN RELATION TO THE SOFTWARE OR FIRMWARE SUPPLIED TO THE LICENSEE. NOT WITHSTANDING THE LICENSEE MAY OWN THE MAGNETIC OR OTHER PHYSICAL MEDIA ON WHICH THE SOFTWARE OR FIRMWARE WAS ORIGINALLY SUPPLIED, OR HAS SUBSEQUENTLY BEEN RECORDED OR FIXED, IT IS A FUNDAMENTAL TERM OF THIS AGREEMENT THAT AT ALL TIMES TITLE AND OWNERSHIP OF THE SOFTWARE OR FIRMWARE, WHETHER ON THE ORIGINAL MEDIA OR OTHERWISE, SHALL REMAIN VESTED IN TAIT OR THIRD PARTIES WHO HAVE GRANTED LICENCES TO TAIT.

TERM AND TERMINATION

THIS LICENCE SHALL BE EFFECTIVE UNTIL TERMINATED IN ACCORDANCE WITH THE PROVISIONS OF THIS AGREEMENT. THE LICENSEE MAY TERMINATE THIS LICENCE AT ANY TIME BY DESTROYING ALL COPIES OF THE SOFTWARE OR FIRMWARE AND ASSOCIATED WRITTEN MATERIALS. THIS LICENCE WILL BE TERMINATED AUTOMATICALLY AND WITHOUT NOTICE FROM TAIT IN THE EVENT THAT THE LICENSEE FAILS TO COMPLY WITH ANY TERM OR CONDITION OF THIS AGREEMENT. THE LICENSEE AGREES TO DESTROY ALL COPIES OF THE SOFTWARE OR FIRMWARE AND ASSOCIATED WRITTEN MATERIALS IN THE EVENT OF SUCH TERMINATION.

LIMITED WARRANTY

THE SOFTWARE OR FIRMWARE (INCLUDING OPEN SOURCE COMPONENTS) IS SUPPLIED BY TAIT AND ACCEPTED BY THE LICENSEE "AS IS" WITHOUT WARRANTY OF ANY KIND EITHER EXPRESSED OR IMPLIED, INCLUDING BUT NOT BEING LIMITED TO ANY IMPLIED WARRANTIES AS TO MERCHANTABILITY OR FITNESS FOR ANY PARTICULAR PURPOSE. THE LICENSEE ACKNOWLEDGES THAT THE SOFTWARE OR FIRMWARE (INCLUDING OPEN SOURCE COMPONENTS) IS USED BY IT IN BUSINESS AND ACCORDINGLY TO THE MAXIMUM EXTENT PERMITTED BY LAW NO TERMS OR WARRANTIES WHICH ARE IMPLIED BY LEGISLATION SHALL APPLY TO THIS AGREEMENT. TAIT DOES NOT WARRANT THAT THE FUNCTIONS CONTAINED IN THE SOFTWARE OR FIRMWARE (INCLUDING OPEN SOURCE COMPONENTS) WILL MEET THE LICENSEE'S REQUIREMENTS OR THAT THE OPERATION OF THE SOFTWARE OR FIRMWARE (INCLUDING OPEN SOURCE COMPONENTS) WILL BE UNINTERRUPTED OR ERROR FREE.

EXCLUSION OF LIABILITY

IN NO CIRCUMSTANCES SHALL TAIT BE UNDER ANY LIABILITY TO THE LICENSEE, OR ANY OTHER PERSON WHATSOEVER, WHETHER IN TORT (INCLUDING NEGLIGENCE), CONTRACT (EXCEPT AS EXPRESSLY PROVIDED IN THIS AGREEMENT), EQUITY, UNDER ANY STATUTE, OR OTHERWISE AT LAW FOR ANY LOSSES OR DAMAGES WHETHER GENERAL, SPECIAL, EXEMPLARY, PUNITIVE, DIRECT, INDIRECT OR CONSEQUENTIAL ARISING

ING OUT OF OR IN CONNECTION WITH ANY USE OR INABILITY OF USING THE SOFTWARE OR FIRMWARE (INCLUDING OPEN SOURCE COMPONENTS).

THE LICENSEE'S SOLE REMEDY AGAINST TAIT WILL BE LIMITED TO BREACH OF CONTRACT AND TAIT'S SOLE AND TOTAL LIABILITY FOR ANY SUCH CLAIM SHALL BE LIMITED AT THE OPTION OF TAIT TO THE REPAIR OR REPLACEMENT OF THE SOFTWARE OR FIRMWARE OR THE REFUND OF THE PURCHASE PRICE OF THE SOFTWARE OR FIRMWARE.

GENERAL

THE LICENSEE CONFIRMS THAT IT SHALL COMPLY WITH THE PROVISIONS OF LAW IN RELATION TO THE SOFTWARE OR FIRMWARE.

LAW AND JURISDICTION

THIS AGREEMENT SHALL BE SUBJECT TO AND CONSTRUED IN ACCORDANCE WITH NEW ZEALAND LAW AND DISPUTES BETWEEN THE PARTIES CONCERNING THE PROVISIONS HEREOF SHALL BE DETERMINED BY THE NEW ZEALAND COURTS OF LAW. PROVIDED HOWEVER TAIT MAY AT ITS ELECTION BRING PROCEEDINGS FOR BREACH OF THE TERMS HEREOF OR FOR THE ENFORCEMENT OF ANY JUDGEMENT IN RELATION TO A BREACH OF THE TERMS HEREOF IN ANY JURISDICTION TAIT CONSIDERS FIT FOR THE PURPOSE OF ENSURING COMPLIANCE WITH THE TERMS HEREOF OR OBTAINING RELIEF FOR BREACH OF THE TERMS HEREOF.

NO DEALINGS

THE LICENSEE MAY NOT SUBLICENSE, ASSIGN OR TRANSFER THE LICENCE OR THE PROGRAM EXCEPT AS EXPRESSLY PROVIDED IN THIS AGREEMENT. ANY ATTEMPT OTHERWISE TO SUBLICENSE, ASSIGN OR TRANSFER ANY OF THE RIGHTS, DUTIES OR OBLIGATIONS HEREUNDER IS VOID.

NO OTHER TERMS

THE LICENSEE ACKNOWLEDGES THAT IT HAS READ THIS AGREEMENT, UNDERSTANDS IT AND AGREES TO BE BOUND BY ITS TERMS AND CONDITIONS. THE LICENSEE FURTHER AGREES THAT SUBJECT ONLY TO ANY EXPRESS WRITTEN TERMS OF AGREEMENT TO THE CONTRARY BETWEEN TAIT AND THE LICENSEE THIS IS THE COMPLETE AND EXCLUSIVE STATEMENT OF THE AGREEMENT BETWEEN IT AND TAIT IN RELATION TO THE SOFTWARE OR FIRMWARE WHICH SUPERSEDES ANY PROPOSAL OR PRIOR AGREEMENT, ORAL OR WRITTEN AND ANY OTHER COMMUNICATIONS BETWEEN THE LICENSEE AND TAIT RELATING TO THE SOFTWARE OR FIRMWARE.

www.taitworld.com

03/2008
MMA-00006-02

