

TM8250 mobile
TM8255 mobile

User's Guide



www.taitworld.com



Directive 1999/5/EC Declaration of Conformity

da Dansk

Undertegnede Tait Electronics Limited erklærer herved, at følgende udstyr TMAA4C, TMAB1C, TMAH5C & TMAC0C overholder de væsentlige krav og øvrige relevante krav i direktiv 1999/5/EF.

Se endvidere: <http://eudocs.taitworld.com/>

de Deutsch

Hiermit erklärt Tait Electronics Limited die Übereinstimmung der Geräte TMAA4C, TMAB1C, TMAH5C & TMAC0C mit den grundlegenden Anforderungen und den anderen relevanten Festlegungen der Richtlinie 1999/5/EG.

Siehe auch: <http://eudocs.taitworld.com/>

el Ελληνικός

Με την παρουσία Tait Electronics Limited δηλώνει ότι TMAA4C, TMAB1C, TMAH5C & TMAC0C συμμορφώνεται προς τις ουσιαστικές απαιτήσεις και τις λοιπές σχετικές διατάξεις της οδηγίας 1999/5/ΕΚ. βλέπε και: <http://eudocs.taitworld.com/>

en English

Tait Electronics Limited declares that this TMAA4C, TMAB1C, TMAH5C & TMAC0C complies with the essential requirements and other relevant provisions of Directive 1999/5/EC.

See also: <http://eudocs.taitworld.com/>

es Español

Por medio de la presente Tait Electronics Limited declara que el TMAA4C, TMAB1C, TMAH5C & TMAC0C cumple con los requisitos esenciales y cualesquiera otras disposiciones aplicables o exigibles de la Directiva 1999/5/CE.

Vea también: <http://eudocs.taitworld.com/>

fi Suomi

Tait Electronics Limited vakuuttaa täten että TMAA4C, TMAB1C, TMAH5C & TMAC0C

tyyppinen laite on direktiivin 1999/5/EY oleellisten vaatimusten ja sitä koskevien direktiivin muiden ehtojen mukainen.

Katso: <http://eudocs.taitworld.com/>

fr Français

Par la présente, Tait Electronics Limited déclare que l'appareil TMAA4C, TMAB1C, TMAH5C & TMAC0C est conforme aux exigences essentielles et aux autres dispositions pertinentes de la directive 1999/5/CE.

Voir aussi: <http://eudocs.taitworld.com/>

it Italiano

Con la presente Tait Electronics Limited dichiara che questo TMAA4C, TMAB1C, TMAH5C & TMAC0C è conforme ai requisiti essenziali ed alle altre disposizioni pertinenti stabilite dalla direttiva 1999/5/CE.

Vedi anche: <http://eudocs.taitworld.com/>

nl Nederlands

Hierbij verklaart Tait Electronics Limited dat het toestel TMAA4C, TMAB1C, TMAH5C & TMAC0C in overeenstemming is met de essentiële eisen en de andere relevante bepalingen van richtlijn 1999/5/EG.

Zie ook: <http://eudocs.taitworld.com/>

pt Português

Tait Electronics Limited declara que este TMAA4C, TMAB1C, TMAH5C & TMAC0C está conforme com os requisitos essenciais e outras provisões da Directiva 1999/5/CE.

Veja também: <http://eudocs.taitworld.com/>

sv Svensk

Härmed intygar Tait Electronics Limited att denna TMAA4C, TMAB1C, TMAH5C & TMAC0C står i överensstämmelse med de väsentliga egenskapskrav och övriga relevanta bestämmelser som framgår av direktiv 1999/5/EG.

Se även: <http://eudocs.taitworld.com/>

Safety and compliance warnings

To our European customers:



Tait Electronics Limited is an environmentally responsible company which supports waste minimization and material recovery. The European Union's Waste Electrical and Electronic Equipment Directive requires that this product be disposed of separately from the general waste stream when its service life is over. Please be environmentally responsible and dispose through the original supplier, your local municipal waste "separate collection" service, or contact Tait Electronics Limited.

Radio frequency exposure information

For your own safety and to ensure you comply with the Federal Communication Commission's (FCC) radio frequency (RF) exposure guidelines, please read the following information before using this radio.

Using this radio

You should use this radio only for work-related purposes (it is not authorized for any other use) and if you are fully aware of, and can exercise control over, your exposure to RF energy. To prevent exceeding FCC RF exposure limits, you must control the amount and duration of RF that you and other people are exposed to.

It is also important that you:

- Do not remove the RF exposure label from the radio.
- Ensure this RF exposure information accompanies the radio when it is transferred to other users.
- Do not use the radio if you do not adhere to the guidelines on controlling your exposure to RF.

Controlling your exposure to RF energy

This radio emits RF energy or radio waves primarily when calls are made. RF is a form of electromagnetic energy (as is sunlight), and there are recommended levels of maximum RF exposure.

To control your exposure to RF and comply with the maximum exposure limits for occupational/controlled environments, follow these guidelines:

- Do not talk (transmit) on the radio more than the rated transmit duty cycle. This is important because the radio radiates more energy when it is transmitting than when it is receiving.
- While you are transmitting (talking or sending data) on the radio, you must ensure that there is always a distance of 0.9m (35 inches) between people and the antenna. This is the minimum safe distance.
- Use the radio only with Tait-approved antennas and attachments, and make only authorized modifications to the antenna otherwise you could damage the radio and violate FCC regulations.



Website: For more information on what RF energy is and how to control your exposure to it, go to <http://www.fcc.gov/oet/rfsafety/rf-faqs.html>.

Compliance with RF energy exposure standards

This two-way radio complies with these RF energy exposure standards and guidelines:

- United States Federal Communications Commission, Code of Federal Regulations; 47 CFR 1.1307, 1.1310 and 2.1091
- American National Standards Institute (ANSI) / Institute of Electrical and Electronic Engineers (IEEE) C95. 1-1992

- Institute of Electrical and Electronic Engineers (IEEE) C95.1-1999 Edition.

This radio complies with the IEEE (FCC) and ICNIRP exposure limits for occupational/controlled RF exposure environments at operating duty factors of up to 50 % talk to 50 % listen.

Radio frequency emissions limits in the USA

Part 15 of the FCC Rules imposes RF emission limits on electronic equipment to prevent interference to reception of broadcast services.

This device complies with Part 15 of the FCC Rules. Operation is subject to the condition that this device does not cause harmful interference.

Note: Changes or modifications to this device that are not expressly approved by Tait Electronics Limited may make its use illegal.

Health, safety and electromagnetic compatibility in Europe

In the European Community, radio and telecommunications equipment is regulated by Directive 1999/5/EC, also known as the Radio and Telecommunications Terminal Equipment (R&TTE) directive. The requirements of this directive include protection of health and safety of users, as well as electromagnetic compatibility.

Intended purpose of product

This product is an FM radio transceiver. Its intended purpose is for radio communication in Private Mobile Radio (PMR) services or Public Access Mobile Radio (PAMR) services.

Note: This product can be programmed for frequencies or emissions that may make its use illegal. Where applicable, a license must be obtained before this product is used. All license requirements must be observed. Limitations may apply to transmitter power, operating frequency, channel spacing, and emission.

Declaration of conformity

Brief Declarations of Conformity appear on [page 1](#).



Website: To download the formal declaration of conformity, go to <http://eudocs.taitworld.com/>.

A signed and dated paper copy of the declaration of conformity can be obtained from Tait Europe Limited.

Electromagnetic compatibility in European vehicles

In the European Community, radio equipment fitted to automotive vehicles is regulated by Directive 72/245/EEC, as amended by 95/54/EC. The requirements of this directive cover the electromagnetic compatibility of electrical or electronic equipment fitted to automotive vehicles.

Note: To meet the requirements of Directive 72/245/EEC (as amended by 95/54/EC) installation of this product in a vehicle must be performed according to the instructions provided, and any guidelines of the vehicle manufacturer.

EN 60950 requirements (25 watt radios)

This radio complies with the European Union standard EN 60950 when operated up to the rated 33% duty cycle of two minutes transmit and four minutes receive, and with ambient temperatures of 30°C or lower.



Caution: Operation outside these limits may cause the external temperature of the radio to rise higher than this standard permits.

Safe radio operation



Warning: Observe the following safe operating practices:

- Switch the radio off at petrol filling stations or near flammable liquids or gases.
- Switch the radio off in the vicinity of explosive devices and blasting zones.
- Using a handheld microphone or a radio while driving a vehicle may violate the laws and legislation that apply in your country or state. Please check the regulations in your area.

High radio surface temperatures

The bottom surface of the radio and the heatsink fins can become hot during prolonged operation. Do not touch these parts of the radio.

Radio protection when charging the vehicle battery

Always remove the fuses from the radio power cable before charging the vehicle battery, connecting a second battery or using power from another vehicle (e.g. when jump-starting the vehicle).

GPS operation

Tait Electronics Limited is not responsible for the operation or failure of operation of GPS satellites or the availability of GPS satellite signals.

Acknowledgement:

The radio uses an implementation of UTM conversion sourced (with permission) from Geoscience Australia (GA).

Your radio's settings

Use the following table to list your radio's programmed settings.

Function key settings

Conventional

Trunked

F1

F2

F3

F4

quick access
menus:





Frequently used channels and groups

ID/Number

Description

ID/Number

Description



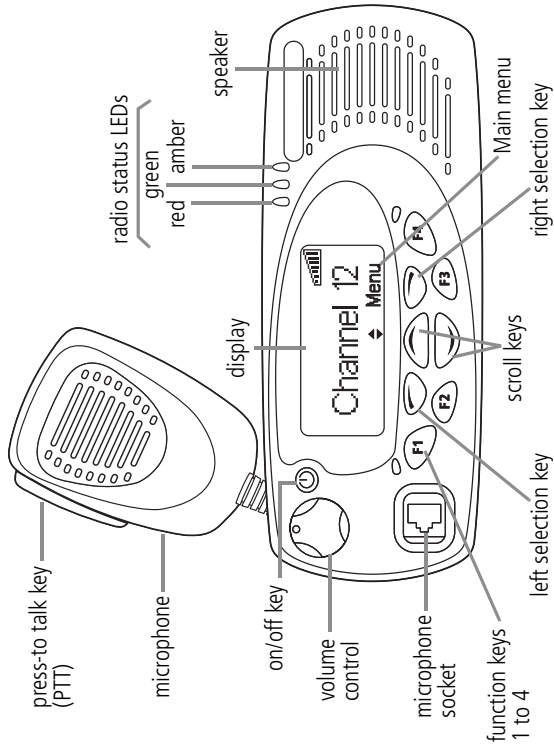



Navigating your radio's menus

Main menu: conventional mode

Note: Some of the menus shown below may not be available for your radio.

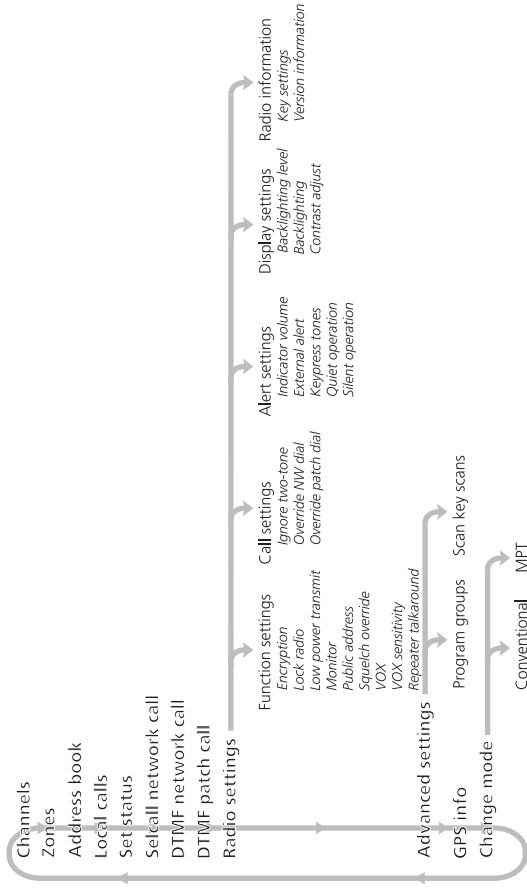

Main menu: MPT trunked mode

Note: Some of the menus shown below may not be available for your radio.

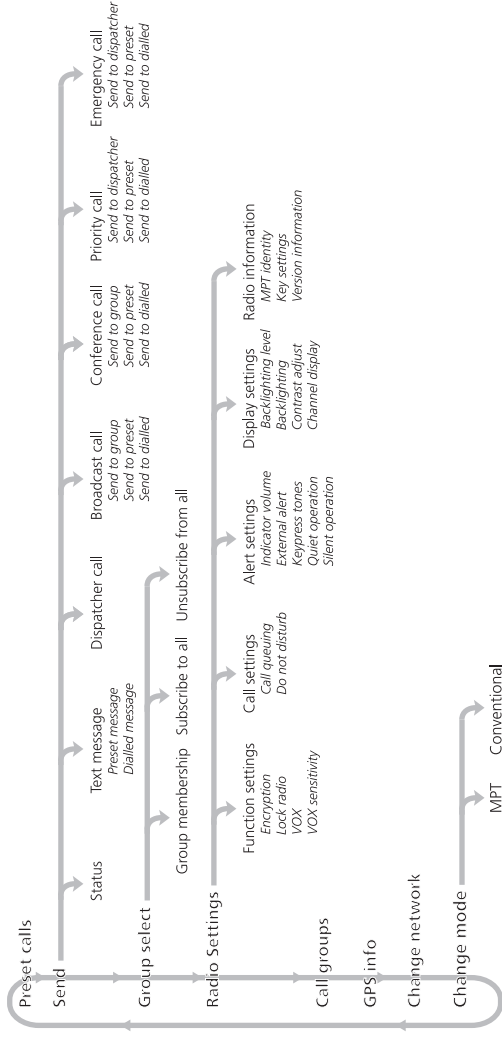

Contents

Safety and compliance warnings	2
Radio frequency exposure information	2
Radio frequency emissions limits in the USA	4
Health, safety and electromagnetic compatibility in Europe	4
Electromagnetic compatibility in European vehicles	5
EN 60950 requirements (25 watt radios)	5
Safe radio operation	6
High radio surface temperatures	6
Radio protection when charging the vehicle battery	6
GPS operation	6
Your radio's settings	7
About this guide	13
Safety warnings used in this guide	13
Feedback about this guide	13
Changes to this guide	13
Copyright information	14
Disclaimer	14
Getting started	15
About the radio controls	15
About the keypad microphone	17
Understanding the radio display	18
Understanding the radio indicators	20
Navigating your radio's menus	21
Viewing your radio's function key settings	23
Basic operation	24
Turning the radio on and off	24
Entering your personal identification number	24
Adjusting the speaker volume	25
Turning on control-head backlighting	25
Changing the level of control-head backlighting	26
Changing the contrast of the radio display	27
Viewing GPS information	27
Operating in conventional mode	29
Selecting a zone	29

Selecting a channel	30
Selecting a group	32
Checking that a channel is clear	34
Communicating directly with other radios	35
Making a call	37
Making a local call	37
Making a call using your address book	39
Making an emergency call	40
Receiving a call	41
Operating in MPT trunked mode	42
Changing your operating mode	42
Checking that your network is available	43
Changing your network	43
Making a preset call	45
About emergency operation	47
Dialling a PABX number	49
Dialling a PSTN number	50
Receiving a call	50
Re-establishing a call	52
Checking missed calls	52
About status messages	54
About text messages	56
Calls to conventional channels or groups	58
Dialling calls in MPT trunked mode	59
MPT 1343 dialling	59
Nokia ANN fleet calls	61
Accessing common MPT trunking functions	63
Troubleshooting	65
When your radio won't turn on	65
Removing the microphone	65
Reinstalling the microphone	66
Removing the radio from the vehicle	66
Describing the radio's audible tones	67
Tait general software licence agreement	69

About this guide

This user's guide provides information about the TM8250 and TM8255 mobile radios, version 3.0x and higher. If you need further assistance or your radio does not operate as you expect, contact your radio provider.



Website: For information about how to install your TM8200 radio, go to <http://support.taitworld.com/>.

Safety warnings used in this guide

Within this guide, the following conventions are used to alert you to important safety information:



Warning: There is a potential risk of death or serious injury.



Caution: There is the risk of minor or moderate injury to people.

Caution: "Caution" is used without the safety alert symbol when there is a risk of equipment damage or malfunction.

Feedback about this guide

If you have any enquiries regarding this guide, or any comments, suggestions and notifications of errors, please contact Technical Support at <http://support@taitworld.com>.

Changes to this guide

In the interests of improving the performance, reliability or servicing of the equipment, Tait Electronics Limited reserves the right to update both the equipment or this user's guide, without prior notice.



Website: For contact details and technical assistance, go to <http://www.taitworld.com/>, and <http://support.taitworld.com/>.

Copyright information

All information contained in this guide is the property of Tait Electronics Limited. All rights are reserved. This guide may not, in whole or in part, be copied, photocopied, reproduced, translated, stored, or reduced to any electronic medium or machine-readable form, without prior written permission from Tait Electronics Limited. All trade names referenced are the service mark, trademark, or registered trademark of the respective manufacturers.

Disclaimer

There are no warranties extended or granted by this guide. Tait Electronics Limited accepts no responsibility for damage arising from use of the information contained in the guide or of the equipment and software it describes. It is the responsibility of the user to ensure that use of such information, equipment and software complies with the laws, rules and regulations of the applicable jurisdictions.

Getting started

This section provides a brief description of your radio's controls and indicators and explains how to use the radio's menus.

The following topics are covered in this section:

- [about the radio controls](#)
- [about the keypad microphone](#)
- [understanding the radio display](#)
- [understanding the radio indicators](#)
- [navigating your radio's menus](#)
- [viewing your radio's function key settings.](#)

About the radio controls

The radio controls are the PTT key, volume control, on/off key, scroll keys, selection keys and function keys. Some keys may have functions assigned to both short and long key presses:

- a short key press is less than one second, and
- a long key press is more than one second.

The radio controls and their functions are summarized in the following diagram.

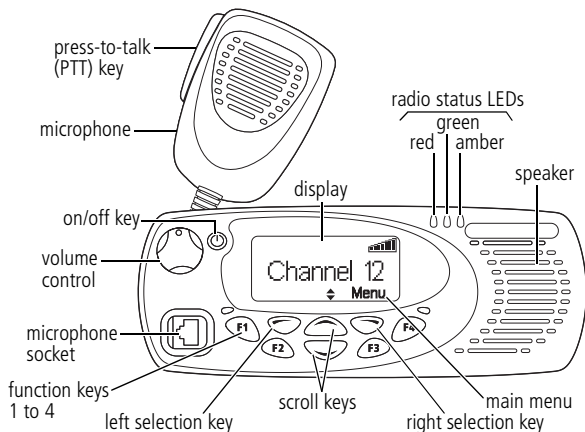

Symbol	Name	Function
	PTT key	Press and hold to transmit and release to listen
	Volume control	Rotate to change the speaker volume
⏻	On/off key	Turn the radio on or off with a long press
⬅️	Left selection key	Action determined by the text above the left selection key
➡️	Right selection key	Action determined by the text above the right selection key
⬆️ ⬆️	Scroll keys	Scroll up and down through a list of menu options or scroll left and right in messages, or select your Quick Access menu

Tip: If you press and hold the scroll keys, the scroll speed increases.

F1	F2	Function keys	Function keys with programmed options
F3	F4	1, 2, 3 and 4	

About the keypad microphone

Your radio may have a keypad microphone installed. The keypad microphone has a PTT key as well as twelve alphanumeric keys, two scroll keys, and left and right selection keys. The PTT key and the scroll and selection keys work in the same way as those on the control head (see ["About the radio controls"](#) on page 15).

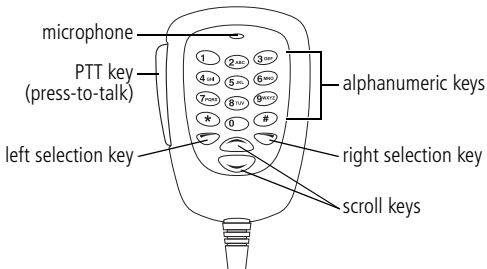

Using the keypad microphone to enter text

When the keypad microphone is used to enter a text message, the microphone keys have special functions. Use the **#** key to toggle between upper and lower case characters and use the left selection key  to delete a character from the display.

The alphanumeric keys **0** to **9wxyz** are used to enter letters, numbers and punctuation. Repeated presses of these keys will give you the characters shown in the table below.

Key	Characters	Key	Characters
1	. , ? ! 1	7PQRS	P Q R S 7
2ABC	A B C 2	8TUV	T U V 8
3DEF	D E F 3	9WXYZ	W X Y Z 9
4GHI	G H I 4	0	space 0
5JKL	J K L 5	*	*
6MNO	M N O 6		

Understanding the radio display





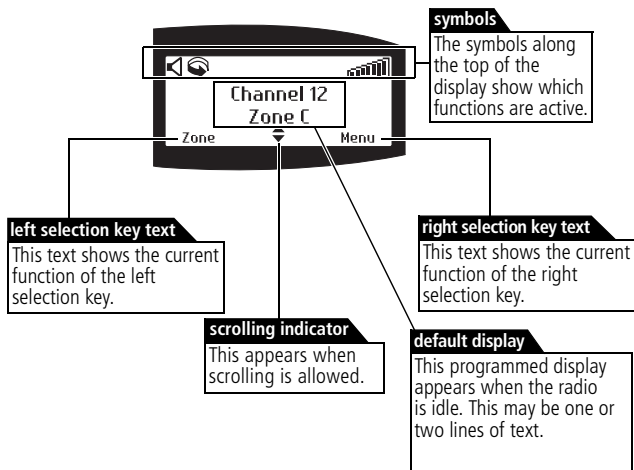







The messages and symbols you see on your radio display depend on the mode in which your radio is operating and the way it is programmed.

The following diagram shows a typical display and explains some of the information that may be available.



Radio display symbols

These are some of the symbols you may see on your radio display:

Symbol	Meaning
	Received signal strength indicator (RSSI): the more bars, the stronger the signal being received by your radio
	Transmit: your radio is transmitting
	Low-power transmit: your radio is transmitting on low power
	Silent operation: your radio's audible tones have been turned off
	External alert: external alert is active
Conventional mode symbols:	
	Scanning: your radio is monitoring a group of channels for activity (this symbol is animated)
	Monitor or squelch override: monitor or squelch override is active
MPT trunked mode symbols:	
	MPT network: your radio has access to an MPT network
	Flashing: your radio is attempting to access an MPT network
	Go: your radio has established a call and you are now able to speak to the other party
	Call queuing: call queuing is active
	Queued call: there are calls in the call queue

Understanding the radio indicators

The status LED indicators and the radio's audible tones—
together with the radio display—all combine to give you
information about the state of your radio.

The most common way the indicators work is described in
the following sections.

Note: The way these indicators behave may be affected by
the way your radio is programmed.

Status LED indicators

LED	Meaning
red (transmit)	Glowing: your radio is transmitting Flashing: your transmit timer is about to expire, or your radio is stunned
green (receive)	Glowing: you are receiving activity (conventional mode) or your radio is actively in a call (MPT trunked mode) Flashing (conventional mode): you have received a call with valid special signalling, or you have activated monitor or squelch override
amber (scanning or network)	Glowing: your radio is scanning a group of channels for activity (conventional mode) or network service is available (MPT trunked mode) Flashing: your radio has detected activity on a channel, and has halted on this channel (conventional mode) flashing fast: there is no network service available (MPT trunked mode)

Audible tones

Note: If quiet or silent mode has been turned on, you will not hear any audible tones.



For a description of other tones you may hear, see [“Describing the radio’s audible tones”](#) on page 67.

Tone type	Meaning
one short beep	Valid key press: the action you have attempted is permitted, or Function activated: a function key has been pressed and that function has been activated
one long, low-pitched beep	Invalid key press: the action you have attempted is not permitted, or Transmission inhibited: you have attempted to transmit but for some reason transmission is not permitted at this time
one short, low-pitched beep	Function deactivated: a function key has been pressed and the corresponding function has been turned off



Navigating your radio’s menus

Your radio has a number of menus available, each containing lists or submenus. The menus available will depend on the way your radio is programmed.

Using the Main menu

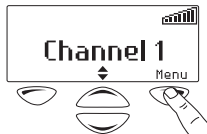
Whenever **Menu** appears above the right selection key , you are able to open the Main menu by pressing .





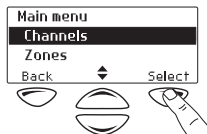

Use the scroll keys  or  to move through the list of menus.

When the menu you want is highlighted, press **Select** to open the menu you have chosen.



Using the scroll key Quick Access menu

Your radio may be programmed so that your scroll keys act as a shortcut to a frequently used menu. To go to this Quick Access menu, press a scroll key  or , and the Quick Access menu appears.

For example, if your Channels menu is your Quick Access menu, press a scroll key  or  to go directly to the Channels menu.



The Channels menu, with a list of your available channels and scan groups, is now displayed.

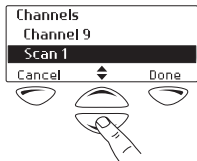

Note: Your scroll keys may be programmed for channel or zone scroll. If this is the case, press the scroll key to immediately begin scrolling through your list of channels or zones.

Using the left selection key Quick Access menu

Your radio may be programmed so that your left selection key acts as a shortcut to another frequently used menu. If this menu has been programmed, the text for left selection key corresponds to the menu.

To use this Quick Access menu, press your left selection key , and the associated menu appears.



Viewing your radio's function key settings

Your radio's four function keys can have programmed functions assigned to each key. Some keys may have a function associated with both a short key press and a long key press. To check the functions assigned to your radio's function keys, you can use the Main menu.

- 1 Select Menu>Radio settings>Radio information>Key settings.

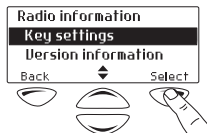

- 2 In the Key Settings menu, scroll through the list of function keys.

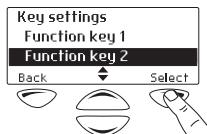

- 3 Press **Select** to view details of the function associated with a particular function key.

The example shown is for a function key programmed to turn control-head backlighting on and off.



Basic operation

This section describes the basic operation of your radio.

The following topics are covered in this section:

- [turning the radio on and off](#)
- [entering your personal identification number](#)
- [adjusting the speaker volume](#)
- [turning on control-head backlighting](#)
- [changing the level of control-head backlighting](#)
- [changing the contrast of the radio display](#)
- [viewing GPS information.](#)

Turning the radio on and off

Give a long press of the on/off key  to turn the radio either on or off.

When the radio is first turned on, the red, green and amber LEDs flash briefly and the radio gives two short beeps. A brief message may appear in the display.

Entering your personal identification number

You may need to enter a personal identification number (PIN) before you can use your radio. If the message

Enter PIN: appears, enter your assigned PIN.

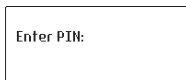

Once you have entered your PIN correctly, the **PIN accepted** message appears and normal operation is now possible.

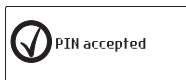

If you do not know your PIN or you receive a **Wrong PIN** message, consult your radio provider or administrator.

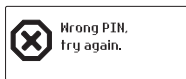

Adjusting the speaker volume

Rotate the volume control clockwise to increase the speaker volume and counterclockwise to decrease the volume. The volume control also changes the volume level of the radio's audible indicators.

Note: Your radio may be programmed with a minimum volume level.

Turning on control-head backlighting

The radio's display and keypad light up when backlighting is on. This normally only happens when a key is pressed or a call is received. There are two ways you may be able to change the way backlighting operates on your radio:

- turn on backlighting momentarily, using a programmed function key, or
- change backlighting between on and off, using either a programmed function key or the Main menu.

Turning backlighting on momentarily by using a function key

You may be able to use a programmed function key to turn backlighting on momentarily. Backlighting remains on for a few seconds and then turns off.

Alternatively, the function key may be programmed so that:

- a short key press turns backlighting on momentarily, and
- a long key press turns backlighting on, and it remains on until there is a further long key press.

Turning backlighting on and off by using a function key

The function key programmed for Backlighting turns backlighting on and off. When backlighting is turned on, it remains on until the function key is pressed again.

Turning backlighting on and off by using the Main menu

When backlighting is turned on using the menu, it remains on until the setting is changed to off, regardless of radio activity.

- 1 Select Menu>Radio settings> Display settings>Backlighting.

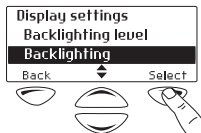

- 2 In the Backlighting menu, choose either **On** or **Off**.

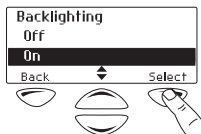

- 3 Press **Select**.

Changing the level of control-head backlighting

The radio's display and keypad light up when backlighting is on. This normally only happens when a key is pressed or a call is received.

You may be able to change the level of control-head backlighting using the Main menu.

- 1 Select Menu>Radio settings> Display settings>Backlighting level.

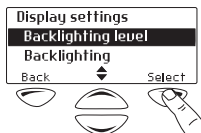

- 2 In the Backlighting Level menu, choose either **High**, **Medium** or **Low**.

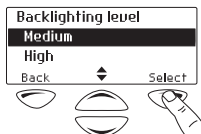



- 3 Press **Select**.

Changing the contrast of the radio display

If the radio's display is too dark or too light, you may be able to adjust the contrast by using the Contrast Adjust menu.

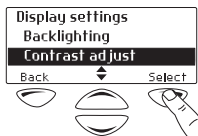
- 1 Select Menu>Radio settings> Display settings> Contrast adjust.



- 2 In the Contrast Adjust menu, use the scroll keys  or  to adjust the display contrast to the desired level.

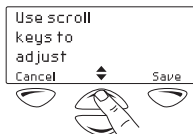

- 3 Press **Save** to save this setting.

Viewing GPS information

Your radio may be connected to a GPS (global positioning system) receiver, and programmed (see the note below) so you can view GPS information such as latitude and longitude, true course, speed, and coordinated universal time. Your radio may also be programmed to display UTM (universal transverse mercator) information such as the UTM zone, and northing and easting coordinates.

Note: GPS information on the radio display is not a standard feature. Before being programmed, it must be purchased and enabled on the radio via the Software Feature Enabler. Contact Tait Electronics Limited for more information.

While viewing GPS information, the status appears at the top right of the display. This shows **tracking** if the GPS receiver is communicating with a satellite, **stored** if the GPS receiver is not communicating with a satellite and the radio is receiving stored information, **lost cnx** if the radio has lost serial communications with the GPS receiver, or **data error** if the radio is receiving incorrect information.

To view GPS information, you may be able to either:



- use a programmed function key, or
- use the Main menu.

Viewing GPS information by using a programmed function key

- 1 Press the function key programmed for GPS display.

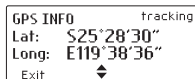
GPS information is now shown in the display.





- 2 Use the scroll keys  or  to view more GPS information.
- 3 Press **Exit** to exit the GPS display.

Viewing GPS information by using the Main menu

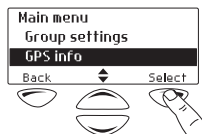
- 1 Select Menu > GPS info.



- 2 Use the scroll keys  or  to view more GPS information.

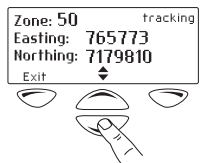

- 3 Press **Exit** to exit the GPS display.

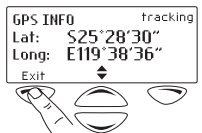

Operating in conventional mode

The following topics are covered in this section:

- selecting a zone
- selecting a channel
- selecting a group
- checking that a channel is clear
- making a call
- making a local call
- making a call using your address book
- making an emergency call
- receiving a call.

Selecting a zone

A zone is a collection of channels and groups. When you select a zone, only the channels and groups assigned to that zone are available.

To select a zone you may be able to either:

- use the Main menu, or
- use your Quick Access menu.

Selecting a zone by using the Main menu

- 1 Select Menu>Zones.

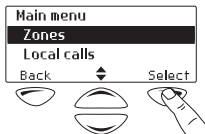

- 2 In the Zones menu, scroll through the list of zones until the one you want appears.

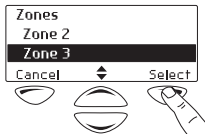

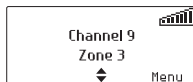

3 Press **Select**.

The zone indication may be programmed to appear either below the channel information or beside the RSSI symbol.



Selecting a zone by using your Quick Access menu

Note: Your scroll keys may be programmed for zone scroll. If this is the case, press the scroll key to immediately begin scrolling through your list of zones.

- 1 Press one of the scroll keys  or  to open the Zones menu.

Alternatively, the left selection key may be programmed as your Quick Access menu. In this case, press the left selection key  to access the Zones menu.

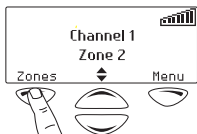

- 2 Scroll through the list of zones until the zone you want appears.

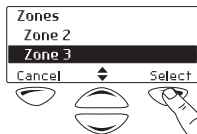

- 3 Press **Select**.

The zone indication may be programmed to appear either below the channel information or beside the RSSI symbol.

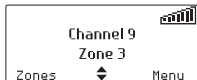

Selecting a channel

To select a channel you may be able to either:

- use a programmed function key,
- use the Main menu, or
- use your quick access menu.

Selecting a channel by using a programmed function key

Press the function key programmed for preset channel.

The programmed channel is now shown in the display.



Selecting a channel by using the Main menu

- 1 Select Menu>Channels.

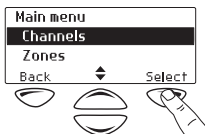

- 2 In the Channels menu, scroll through the list of channels until the channel you want appears.

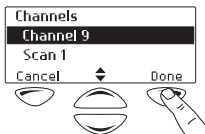



- 3 Press **Done**.

The programmed channel is now shown in the display.



Selecting a channel by using your Quick Access menu

Note: Your scroll keys may be programmed for channel scroll. If this is the case, press the scroll key to immediately begin scrolling through your list of channels.

- 1 Press one of the scroll keys  or  to open the Channels menu.

Alternatively, the left selection key may be programmed as your Quick Access menu. In this case, press the left selection key  to access the Channels menu.



- 2 Scroll through the list of channels until the channel you want appears.
- 3 Press **Done**.

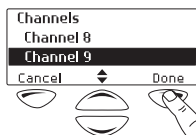

The programmed channel is now shown in the display.



Selecting a group

A group is a collection of channels that are grouped together for either scanning or voting. In the Channels menu, the group is shown as being a single channel item, e.g. "Scan 1". To select a group you may be able to either:

- use a programmed function key,
- use the Main menu, or
- use your quick access menu.

Selecting a group by using a programmed function key

Press a function key programmed for group scanning.

The programmed group is now shown in the display, the amber LED glows and the scanning symbol  appears in the display.

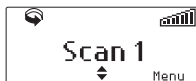

Selecting a group by using the Main menu

- 1 Select Menu>Channels.

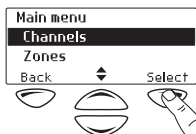

- In the Channels menu, scroll through the list of channels and groups until the group you want appears.

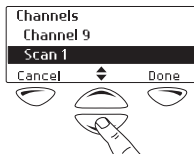

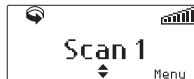

- Press **Done**.

The amber LED glows and the scanning symbol  appears in the display.



Selecting a group by using your Quick Access menu

Note: Your scroll keys may be programmed for channel scroll. If this is the case, press the scroll key to immediately begin scrolling through your list of channels and groups.

- Press one of the scroll keys  or  to open the Channels menu.

Alternatively, the left selection key may be programmed as your Quick Access menu. In this case, press the left selection key  to access the Channels menu.



- Scroll through the list of channels and groups until the group you want appears.

- Press **Done**.

The amber LED glows and the scanning symbol  appears in the display.

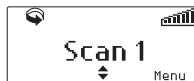
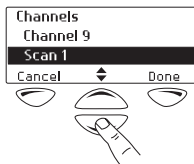

Checking that a channel is clear

You or your user group may be segregated from other user groups by special signalling. If an incoming call carries the special signalling tones specific to you or your user group, your radio's signalling mute opens and you can hear the call. These tones may not be audible.

The monitor function may allow you to override any special signalling on a channel, so that you can check that the channel is clear before you make a call.

Note: Your radio may be programmed to activate monitor whenever the microphone is off the microphone clip.

To activate monitor, you may be able to either:

- remove the microphone from the microphone clip,
- use a programmed function key, or
- use the Main menu.

Activating monitor by using a function key

- 1 Press the monitor function key to activate monitor and hear any traffic on the channel.

While monitor is on, the green LED flashes slowly and the monitor symbol ◀ appears in the display.



- 2 Press the monitor function key again to turn monitor off, or wait for monitor to turn off automatically, after a programmed delay.

When monitor turns off, the green LED stops flashing and the monitor symbol ◀ disappears from the display.



Note: Your radio may be programmed so that monitor turns off automatically after a short time.

Activating monitor by using the Main menu

- 1 Select Menu>Radio settings>Function settings>Monitor.

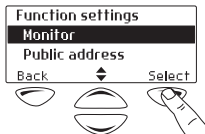

- 2 In the Monitor menu, choose **On**.
- 3 Press **Select**.

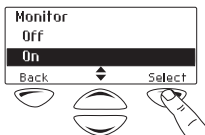

While monitor is on, the green LED flashes slowly and the monitor symbol  appears in the display.



Note: Your radio may be programmed so that monitor turns off automatically after a short time.

Communicating directly with other radios

You can bypass the radio repeater and communicate directly with another radio. This feature is known as repeater talkaround.

You can do this, for example, when you are out of range of the repeater, or if the repeater is busy or stops working for whatever reason.

While repeater talkaround is active, all transmissions are made on the receive frequency of the channel you are on.

To activate repeater talkaround, you may be able to either:

- use a programmed function key, or
- use the Main menu.

Activating repeater talkaround by using a function key

- 1 Change to the required channel.
- 2 Press the programmed function key to turn repeater talkaround on.

The message Talkaround activated appears and the repeater talkaround symbol  appears in the display.



- 3 Proceed with your call.
- 4 To turn repeater talkaround off, either:
 - change the channel, or
 - press the function key again.

Activating repeater talkaround by using the Main menu

- 1 Change to the required channel.
- 2 Select Menu > Radio settings > Function settings > Repeater talkaround.
- 3 In the Repeater talkaround menu, choose **On**.
- 4 Press **Select**.

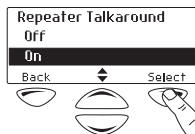

The message Talkaround activated appears. The repeater talkaround symbol  appears if you navigate to the default display.



- 5 Proceed with your call.
- 6 To turn repeater talkaround off, either:
 - change the channel, or
 - choose **Off** in the Repeater talkaround menu and press **Select**.

Making a call

- 1 Select the required channel or scan group.
- 2 Check that the channel is clear. If the green LED is glowing, the channel is busy and you may not be able to transmit.
- 3 Once the channel is clear (the green LED is off), lift the microphone off the microphone clip.
- 4 Hold the microphone about 5 cm (2 inches) from your mouth.
- 5 Press and hold the PTT key to transmit.
- 6 Speak clearly into the microphone and release the PTT key when you have finished talking.

While you are transmitting, the red LED glows and the transmit symbol  appears in the display.



Transmit timer

Your radio may have a transmit timer that limits the amount of time you can transmit continuously.

When the transmit timer is about to expire, the message **Transmit timeout imminent** appears in the display, the red LED flashes and the radio gives three beeps.

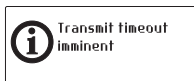

If the transmit timer has timed out, you must release the PTT before you can transmit again.

Making a local call

Each channel on your radio may have one or more local calls programmed. To make a local call you may be able to either:

- use the Main menu, or
- use your Quick Access menu.

Making a local call by using the Main menu

- 1 Select the required channel.
- 2 Select Menu>Local calls.

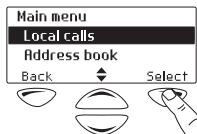

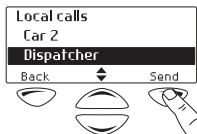

- 3 In the Local Calls menu, scroll through the list of local calls until the call you want appears.
- 4 Press **Send**.



The call details appear in the display, the red LED glows and the transmit symbol  appears in the display.





Making a local call by using your Quick Access menu

- 1 Select the required channel.
- 2 Press one of the scroll keys  or  to open the Local Calls menu.

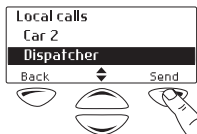

- 3 Scroll through the list of local calls until the call you want appears.
- 4 Press **Send**.



The call details appear in the display, the red LED glows and the transmit symbol  appears in the display.



Making a call using your address book

Your Address Book menu has a programmed list of calls, which can be made from any channel or zone. Address-book calls may also be used to send status information, such as "at lunch" or "on site".

To make a call using your address book, you may be able to either:

- use a programmed function key,
- use the Main menu, or
- use your Quick Access menu.

Making an address-book call by using a function key

Press the function key programmed for Address Book Call.

The call details appear in the display, the red LED glows and the transmit symbol  appears in the display.



Making an address-book call by using the Main menu

- 1 Select Menu > Address book.

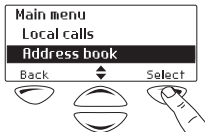

- 2 In the Address Book menu, scroll through the list of calls until the call you want appears.

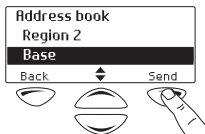



3 Press **Send**.

The call details appear in the display, the red LED glows and the transmit symbol  appears in the display.



Making an address-book call by using your Quick Access menu

- 1 Press one of the scroll keys  or  to open the Address Book menu.

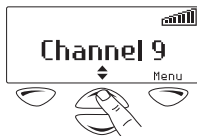

- 2 Scroll through the list of calls until the call you want appears.

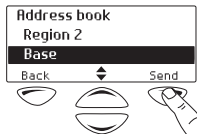

- 3 Press **Send**.

The call details appear in the display, the red LED glows and the transmit symbol  appears in the display.



Making an emergency call

You may be able to activate emergency mode by using a programmed function key.

- 1 Press the function key programmed for Emergency Mode and an emergency call is sent to your dispatcher, or some other predetermined location.

While emergency mode is active, your radio may cycle between receive and transmit, so that your dispatcher can hear any activity near the radio. Alternatively, your radio may appear to turn off but will actually remain in emergency mode.

2 Reset the radio to normal operation at any time by turning the radio off and then on.

Note: Emergency mode may be programmed to end after a fixed period of time. In this case, there is no need to turn the radio off and then on in order to return the radio to normal operation.

Receiving a call

When there is valid activity on your radio's currently selected channel or group, the radio then unmutes and you can hear the call.

If the incoming call contains special signalling that matches the signalling programmed for your radio, the green LED flashes and your radio may give a ringing tone.

Operating in MPT trunked mode

Note: Your radio must have trunking functionality programmed before it can operate in MPT trunked mode.

The following topics are covered in this section:

- [changing your operating mode](#)
- [checking that your network is available](#)
- [changing your network](#)
- [making a preset call](#)
- [about emergency operation](#)
- [dialling a PABX number](#)
- [dialling a PSTN number](#)
- [receiving a call](#)
- [re-establishing a call](#)
- [checking missed calls](#)
- [about status messages](#)
- [about text messages](#)
- [calls to conventional channels or groups.](#)

Changing your operating mode

The way your radio performs basic functions, such as sending and receiving calls, depends on the operating mode of your network. The two operating modes that may be available on your radio are:

- conventional mode (see ["Operating in conventional mode" on page 29](#)), and
- MPT trunked mode.

Changing your operating mode

- 1 Select Menu > Change mode.

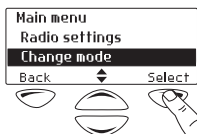

- 2 In the Change Mode menu, select either **Conventional** or **MPT**.

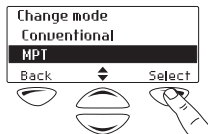

- 3 Press **Select**.

- 4 Press **Yes** when you are prompted to confirm your selection.

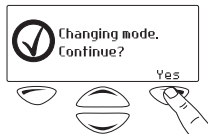

The message **Changing Mode** appears and your radio now shows the programmed default display for either conventional or MPT trunked mode.

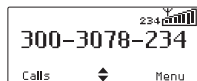

Checking that your network is available

Check that the amber LED is glowing and the network symbol  appears in the display. The amber LED glows and the network symbol is shown whenever your radio has access to the MPT trunked network.

If the amber LED and the network symbol are flashing, your radio is attempting to access the MPT trunked network. If these indicators remain flashing, your radio may be out of the network coverage area.

Changing your network

Your radio may be programmed to operate in up to four completely separate trunking networks. You may wish to change networks because you are out of the network coverage area, or you need to have access to another trunking network. To change your radio's operating network, you may be able to either:

- use the Main menu, or
- dial the new network using a keypad microphone.

Using the Main menu to change networks

- 1 Select Menu > Change network.

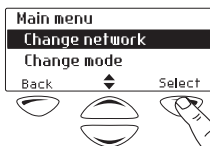

- 2 In the Change Network menu, scroll through the list of networks until the network you want appears.

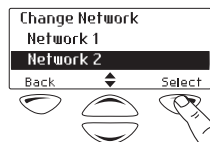

- 3 Press **Select**.

The radio will restart, and display a power-up message followed by the name of the new network.

- 4 Check that the amber LED is glowing and the network symbol  appears in the display. If the amber LED and network symbol keep flashing, you may be out of the coverage area of this network.

Dialling a new network

If your radio has a keypad microphone installed, the new network can be selected by dialling.

- 1 Dial ***700#** to display the name of the current trunked network.
- 2 Dial ***70n#** to change to a new network, where **n** is the number of the new network (1 to 4).

The radio will restart, and display a power-up message followed by the name of the new network.

- 3 Check that the amber LED is glowing and the network symbol  appears in the display. If the amber LED and network symbol keep flashing, you may be out of the coverage area of this network.

Making a preset call

The preset calls programmed for your radio may be to other radios, to PABX extensions or to PSTN numbers. To make a preset call from your radio, you may be able to either:

- use a programmed function key,
- use the Main menu,
- use your Quick Access menu, or
- dial the preset call using a keypad microphone.

Using a function key to make a preset call

Press the function key programmed to make the preset call you want.

The call details appear in the display. While the call is being setup, you can cancel the call by pressing **Clear**.

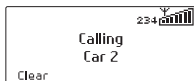

Using the Main menu to make a preset call

- 1 Select Menu > Preset calls.

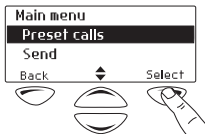

- 2 In the Preset Calls menu, scroll through the list of calls until the call you want appears.

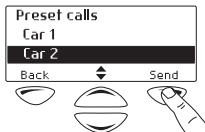

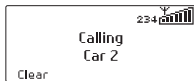

- 3 Press **Send**.

The call details appear in the display. While the call is being setup, you can cancel the call by pressing **Clear**.



Using your Quick Access menu to make a preset call

- 1 Press the left selection key  or one of the scroll keys  or  to enter the Preset Calls menu.
- 2 Scroll through the list of names until the you want appears.
- 3 Press **Send**.

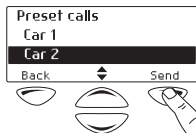

The call details appear in the display. While the call is being setup, you can cancel the call by pressing **Clear**.

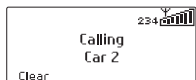

Dialling a preset call

If your radio has a keypad microphone installed, the preset calls programmed for your radio can be dialled. To dial the preset call, you need to know the number associated with the preset call. There may be up to 100 preset calls programmed.

For information about entering characters using the keypad microphone, see ["About the keypad microphone" on page 17](#).

To dial a preset call:

- 1 Dial **p**, where **p** is the number of the preset call.

If your preset call number is the same as a call to another radio, then you need to dial a leading **0**. For example, dial **23#** to call radio 23 and dial **023#** for preset call number 23.

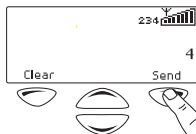

- 2 Press **Send** or the **#** or PTT key.

The call details appear in the display. While the call is being setup, you can cancel the call by pressing **Clear**.

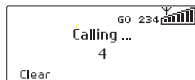

About emergency operation

In an emergency you may be able to summon help by sending an emergency call. After making the call, your radio may be programmed to enter emergency mode. While emergency mode is active, your radio may cycle between receive and transmit, so that your dispatcher or the called party can hear any activity near your radio.

On most networks, an emergency call takes precedence over other call types, and existing calls are cleared down so that the emergency call can proceed.

To make an emergency call from your radio, you may be able to either:

- make a preset emergency call,
- dial the emergency call using a keypad microphone, or
- use a function key programmed for emergency mode.

Making a preset emergency call

To make a preset emergency call from your radio, you may be able to either use a programmed function key, use the main menu, or use your quick access menu.

- 1 Select your preset emergency call.
See ["Making a preset call"](#) on page 45.
- 2 Press **Send**.

An emergency call is now sent to the emergency location that has been programmed for your radio.

Dialling an emergency call

If your radio has a keypad microphone installed, you can dial an emergency call. For information about entering characters using the keypad microphone, see ["About the keypad microphone" on page 17](#).

- 1 Dial ***9**.

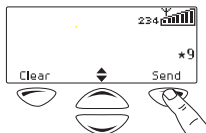

- 2 Press **Send** or the **#** or PTT key.

An emergency call is now sent to the emergency location that has been programmed for your radio.

Note: If you wish to send an emergency call to another radio, you may be able to dial ***9*n** then press the **#** or PTT key. In this case, **n** is the radio unit number you wish to send the emergency call to and may be a two- or three-digit number.

Activating emergency mode

You can activate emergency mode using a function key programmed for emergency mode. Alternatively, you may be able to activate emergency mode using a hidden switch or panic button. Once emergency mode is activated, your radio makes an emergency call to your dispatcher or some other predetermined location. The radio then enters emergency mode.

While emergency mode is active, your radio may cycle between receive and transmit, so that your dispatcher can hear any activity near the radio.

Cancelling emergency mode

Reset the radio to normal operation at any time by turning the radio off and then on.

Note: Emergency mode may be programmed to end after a fixed period of time. In this case, there is no need to turn the radio off and then on in order to return the radio to normal operation.

Dialling a PABX number

If your radio has a keypad microphone installed, you may be able to make calls to a PABX extension. For information about entering characters using the keypad microphone, see [“About the keypad microphone” on page 17](#).

To dial a PABX extension:

- 1 Dial **n**, where **n** is the PABX extension you wish to call.

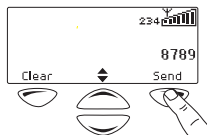

- 2 Press **Send** or the **#** or PTT key.

The call details appear in the display. While the call is being setup, you can cancel the call by pressing **Clear**.



Dialling a PSTN number

If your radio has a keypad microphone installed, you may be able to make calls to a PSTN number. For information about entering characters using the keypad microphone, see [“About the keypad microphone” on page 17](#).

To dial a PSTN number:

- 1 Dial **On**, where **n** is the PSTN number you wish to call.

Note: The numbers you dial before the 0 depend on the way your network operates.

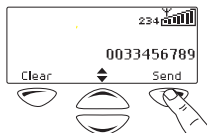

- 2 Press **Send** or the **#** or PTT key.

The call details appear in the display. While the call is being setup, you can cancel the call by pressing **Clear**.



Receiving a call

When you receive a call, your radio displays the caller's identity and responds in one of two ways, depending on the way it was programmed and the way your network operates.

- On-air call setup: The radio gives a ring and automatically accepts the call. The **GO** symbol appears in the display.
- Full off-air call setup (FOACSU): When a call is received, the radio rings like a telephone.

To accept the call, press **Answer**. The radio gives a beep and the **GO** symbol appears in the display. You may also be able to accept the call if you briefly press the PTT key or lift the microphone off the microphone clip.

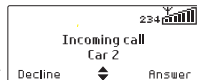

Once the **GO** symbol appears, you can proceed with the call, as follows:

- 1 Hold the microphone about 5 cm (2 inches) from your mouth.
- 2 Press and hold the PTT key to transmit.
- 3 Speak clearly into the microphone and release the PTT key when you have finished talking.

While you are transmitting, the red LED glows and the transmit symbol  appears in the display.

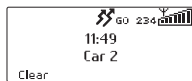

- 4 End the call by placing your microphone back onto its hook or by pressing **Clear**. The network may also end the call if neither you nor the other party transmits for a predetermined time or if your call time limit is exceeded.

Transmit timer

Your radio may have a transmit timer that limits the amount of time you can transmit continuously.

When the transmit timer is about to expire, the message **Transmit timeout imminent** appears in the display, the red LED flashes and the radio gives three beeps.

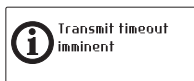

If the transmit timer times out, the call clears down.

Call time limit

In MPT trunked mode, the length of your call may be limited by the network or by your radio. Your radio may be programmed to display the time remaining for your call.

When your call time is about to expire, the message **Call timeout** appears in the display, the red LED flashes and the radio gives a repeated beep.

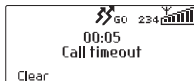

Re-establishing a call

The last number recall, unanswered call and callback functions allow you to re-establish calls using the PTT key.

Last number recall

When an outgoing call has ended, the message **Last call to** and the called unit's identity may appear on the display.

To make a call to that person again, briefly press the PTT key.

Unanswered call

When an incoming call is missed, the message

Missed call and the caller's identity may appear in the display.

To return the call, briefly press the PTT key.

Callback

When an incoming call has been ended, the message

Last call from and the caller's identity may appear in the display.

To make a call to that person, briefly press the PTT key.



Checking missed calls

If you have missed an incoming call, it may be stored in the call queue, so that you can return the call later. Information about the last missed call is shown in the display and the queued call symbol  appears.

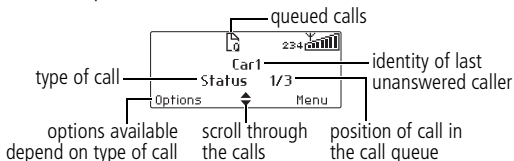
In the example below, the last call received was a status message from Car 1. This call is the first of three calls stored in the call queue.



Accessing the call queue

1 Use the scroll keys  or  to move through the calls in the call queue until the call you want appears.

2 Press **Options** to open the Call Queue Options menu.

The options available for the call depend on the type of call it is. If the call is a voice call, select **Call** to return the call or **Delete** to delete the call.

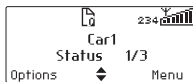

If the call is a status message or a text message, then select **View** to read the message.

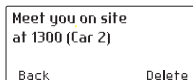

Changing your call queuing setting

Your radio may be programmed so that you are able to change call queuing to "unanswered". Unanswered call queuing means that all status and text messages are immediately queued. Incoming voice calls are only queued if they are unanswered.

If your radio has a keypad microphone installed, you may be able to change your call queuing setting using the keypad. For information about entering characters using the keypad microphone, see ["About the keypad microphone" on page 17](#).

To activate call queuing:

- select Menu>Radio settings>Call settings>Call queuing and choose **On**, or
- dial ***48** then press the  or PTT key.

The message **Call queuing activated** appears.

To change call queuing to unanswered call queuing:

- select Menu>Radio settings>Call settings>Call queuing and choose **Off**, or
- dial **#48** then press the  or PTT key.

The message **Call queuing deactivated** appears.

About status messages

A status message is sent to another party to indicate your current activity or location, such as “en route” or “at lunch”. If the radio receiving your message has been programmed with the same status messages, it will decode and display your message. If you receive a status message, the message is automatically queued, since a response is not expected.

Selecting a status message

- 1 Select Main>Send>Status.

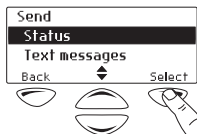

- 2 In the Status menu, scroll through the list of status messages until the message you want appears.

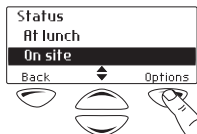

Sending a status message

- 1 When you have chosen a message, press **Options** and the Send To menu opens.

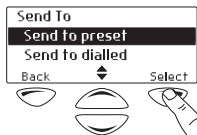

- 2 In the Send To menu, scroll through the list of options until the choice you want appears.

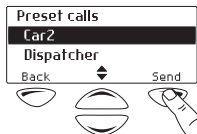

- Note:** If your radio has a keypad microphone installed, you can choose the option **Send to dialled**, then dial the number of the party you wish to call.

3 Press **Send**.

The call details appear in the display. While the call is being setup, you can cancel the call by pressing **Clear**.

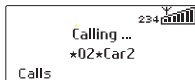

Dialling a status message

If your radio has a keypad microphone installed, the status messages programmed for your radio can be dialled. To dial the message, you need to know the number associated with the status message. There may be up to 30 status messages programmed.

For information about entering characters using the keypad microphone, see [“About the keypad microphone” on page 17](#).

To dial a status message:

- 1 Dial ***0s*n**, where **s** is the number of the status message and **n** is the radio unit number you wish to send the message to.

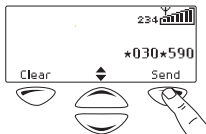

- 2 Alternatively, dial ***0s*p**, where **p** is the number of a preset call. See [“Dialling a preset call” on page 46](#) for more information.

- 3 Press **Send** or the **#** or PTT key.

The call details appear in the display. While the call is being setup, you can cancel the call by pressing **Clear**.



About text messages

Your radio may be programmed so that you can send text messages. There are three options for creating text messages:

- selecting a preset text message,
- editing a preset text message, or
- creating a new text message.

Note: To either edit or enter a text message, your radio must have a keypad microphone installed. For information about entering alphanumeric characters using the keypad microphone, see [“About the keypad microphone”](#) on page 17.

Selecting a preset text message

- 1 Select Menu > Send > Text message > Preset message. In the Preset Message menu, a short label representing each message is displayed.

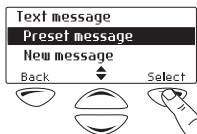

- 2 Scroll through the list of preset message labels until the one you want appears.

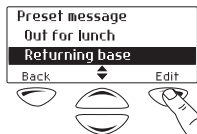

- 3 Select **Edit**, and the complete text message you have chosen is now displayed.

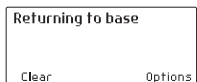

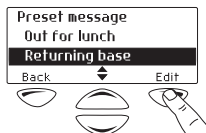
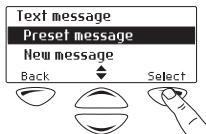

Editing a preset text message

- 1 Select Menu>Send>Text message>Preset message. In the Preset Message menu, a short label representing each message is displayed.
- 2 Scroll through the list of preset message labels until the one you want appears.

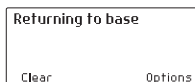

- 3 Press **Edit**, and the complete text message you have chosen is now displayed.



- 4 Use the scroll keys  or  to move through the characters. Use the alphanumeric keypad to add characters and the **Clear** key to delete them. The message can be up to 100 characters long.

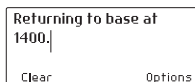

Creating a new text message

- 1 Select Menu>Send>Text message>New message. The last text message you sent may be displayed.
- 2 In the New Message menu, modify the last text message you sent, or enter the new text message using the alphanumeric keypad on your keypad microphone. The message can be up to 100 characters long.

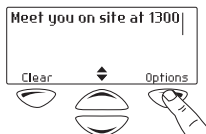
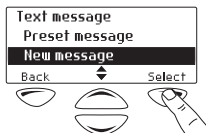

Sending a text message

- 1 When you have chosen or entered a message, press **Options** and the Send To menu opens.
- 2 In the Send To menu, scroll through the list of options until the choice you want appears.

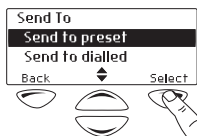

If your radio has a keypad microphone installed, you can choose the option **Send to dialed**, then dial the number of the party you wish to call.

- 3 Press **Send**.

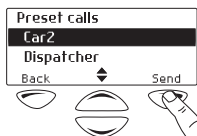
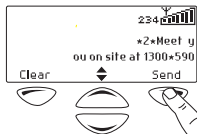

The call details appear in the display. While the call is being setup, you can cancel the call by pressing **Clear**.

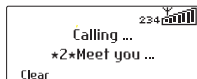

Calls to conventional channels or groups

You may be able to dial conventional channels or groups, using **101** to **110**. The channels or groups called using these numbers are programmed for your radio.

To call a conventional channel or group:

- 1 Dial the number for the channel or group you wish to call.
- 2 Press **Send** or the (#) or PTT key.

Your radio switches to the conventional channel programmed for that number.

Dialling calls in MPT trunked mode

If your radio has a keypad microphone installed, you can make dialled calls from your radio. The numbers you dial and dialling features available depend on the way your radio is programmed and the way your network operates. Contact your radio provider for further assistance.

For information about entering characters using the keypad microphone, see [“About the keypad microphone” on page 17](#).

The following topics are covered in this section:

- [MPT 1343 dialling](#)
- [Nokia ANN fleet calls](#)
- [accessing common MPT trunking functions](#).

MPT 1343 dialling

If your MPT trunked network uses the MPT 1343 dialling scheme, your radio's unique number on the network consists of:

- a three-digit prefix,
- a four-digit fleet number, and
- a two- or three-digit radio unit number.

You may also be part of a group, with a two- or three-digit group number.

Finding your radio's MPT number

To find your radio's full MPT number:

- 1 Dial ***700**.

- 2 Press the (#) or PTT key.

The name associated with your network and your radio's full MPT number appears.

MPT 300-3078-234 Back

The number is in the form:

Prefix 300	Fleet 3078	Radio unit number 234
---------------	---------------	--------------------------

MPT 1343 dialled calls

The following table summarizes the way you dial calls to other radios and groups of radios and gives an example of each type of call.

Note: In the following examples, the final # may be replaced by a short press of the PTT key.

Call to	Dialling code and example			
Radio 23 in the same fleet as you	Radio unit number 23			#
Radio 234 in the same fleet as you	Radio unit number 234			#
Radio 23 in fleet 3078 with the same prefix as you	Fleet 3078	Radio unit number 23		#
Radio 234 in fleet 3078 with the same prefix as you	Fleet 3078	Radio unit number 234		#
Radio 234 in fleet 3078 with a different prefix to you (300)	Prefix 300	Fleet 3078	Radio unit number 234	#
Group 92 in the same fleet as you	Group 92			#
Group 923 in the same fleet as you	Group 923			#

Nokia ANN fleet calls

If your MPT trunked network uses Nokia ANN dialling, the numbers you dial depend on your fleet size. Fleets are defined as either large, small or mini. Your radio's unique number on the network consists of:

- a lead number **7, 8** or **9**, depending on the fleet size,
- a zero-, one-, two- or three-digit prefix,
- a one- or two-digit fleet number, and
- a two- or three-digit radio unit number.

Note: See your radio provider or network administrator for Nokia ANN call details.

Finding your radio's MPT number

To find your radio's full MPT number:

- 1 Dial ***700**.
- 2 Press the **#** or PTT key.

The name associated with your network and your radio's full MPT number appears.

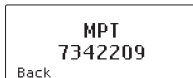

The number is in the form:

Lead 7	Prefix 34	Fleet 2	Radio unit number 209
-----------	--------------	------------	--------------------------

Nokia ANN dialled calls

The following table summarizes the way you dial calls to other radios and gives an example of each type of call.

Note: In the following dialled numbers, the # terminator is not necessary if you press the **PTT** key instead.

Call to	Dialling code and example				
Radio 23 in the same fleet as you	Radio unit number 23		#		
Group 923 in the same fleet as you	Group 923	#			
Large fleet:					
Call to radio 234 in fleet 1 with the same prefix as you	Lead 7	Fleet 1	Radio unit number 234	#	
Call to radio 235 in fleet 2 with a different prefix to you (32)	Lead 7	Prefix 32	Fleet 2	Radio unit number 235	#
Small fleet:					
Call to radio 23 in fleet 51 with the same prefix as you	Lead 7	Fleet 51	Radio unit number 23	#	
Call to radio 23 in fleet 52 with a different prefix to you (126)	Lead 7	Prefix 126	Fleet 52	Radio unit number 23	#
Mini fleet:					
Call to radio 23 in fleet 80 with the same prefix as you	Lead 7, 8 or 9	Fleet 80	Radio unit number 23	#	
Call to radio 23 in fleet 81 with a different prefix to you (3)	Lead 7, 8 or 9	Prefix 3	Fleet 81	Radio unit number 23	#

Accessing common MPT trunking functions

The following tables explain how you can access special MPT trunking functions using the * and # keys. The availability of these functions is dependant on the way your radio is programmed and the way your network operates.

Note: In the following examples, the final # may be replaced by a short press of the PTT key.

*... # functions

Dialling code	Call to	Example
#	Accept an incoming FOACSU call	
*#	Clear call or displayed item, or decline an incoming FOACSU call	
*0#	Request base dispatcher to call you back	
#0#	Cancel request	
*0*n#	Request another dispatcher to call you back	*0*234#
#0*n#	Cancel request	#0*234#
*0s*n#	Status call (s = status 1 to 30) to radio n	*015*23#
*0s#	Status call to dispatcher	*015#
*1*g#	Conference call to group g	*1*92#
*11*g#	Broadcast call to group g	*11*92#
*31*n#	Non-prescribed data call	*31*23#
*41*n#	Divert own calls to radio n	*41*23#
#41#	Cancel divert	
*41*0n#	Divert own calls to PSTN n	*41*03456798#
#41#	Cancel divert	
*44*n*m#	Divert 3rd party calls n to m	*44*23*21#
#44*n#	Cancel divert of 3rd party calls	#44*23#

*... # functions

Dialling code	Call to	Example
*48#	Queue incoming calls	
#48#	Cancel queue	
*49#	Do not disturb	
#49#	Cancel do not disturb	
*491#	Do not disturb - voice calls only	
#491#	Cancel do not disturb, voice calls only	
*492#	Do not disturb - data calls only	
#492#	Cancel do not disturb, data calls only	
*50*n#	Select channel n (site-select diagnostic function, enabled during programming)	
#50#	Resume normal channel hunting (site-select diagnostic function, enabled during programming)	
*700#	Display your MPT number and current network	
*70n#	Change to network n (1 to 4)	*702#
*8*n#	Priority call to radio n	*8*23#
*8*1*g#	Priority conference call to group g	*8*1*923#
*9*n#	Emergency call to radio n	*9*23#
*9*1*g#	Emergency conference call to group g	*9*1*92#
**n#	Abbreviated dialled codes (1-49)	**3#

Troubleshooting

The following topics are covered in this section:

- [when your radio won't turn on](#)
- [removing the microphone](#)
- [reinstalling the microphone](#)
- [removing the radio from the vehicle](#)
- [describing the radio's audible tones.](#)

When your radio won't turn on

If the red, green and amber LEDs on the control head do not light up when the radio is turned on, it is likely that no power is reaching the radio. Check the following:

- Is the power connector firmly plugged into the rear of the radio?
- Are the in-line fuses in good condition?
- Is the power cable securely connected to the vehicle battery or power supply?

If all appears to be in order, then contact your radio provider for further assistance.

Removing the microphone

- 1 Using your thumb or forefinger, lift up one of the corners of the microphone grommet. Firmly (but gently) pull that corner until the seal comes away from the cavity.
- 2 Repeat to expose another corner.
- 3 Pull the exposed corners back and slide the grommet up the microphone cable to reveal the microphone plug.
- 4 Remove the plug from the microphone socket.

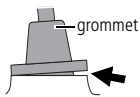

Reinstalling the microphone

Caution: The microphone grommet must be installed whenever the microphone is plugged into the microphone socket.

- 1 Plug the microphone into the microphone socket.
- 2 Slide the microphone grommet along the microphone cord and push two adjacent corners of the grommet into the microphone socket cavity.
- 3 Squeeze the grommet and push the remaining corners into position.
- 4 Check that the grommet is seated correctly in the cavity.

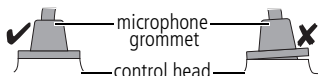

Removing the radio from the vehicle

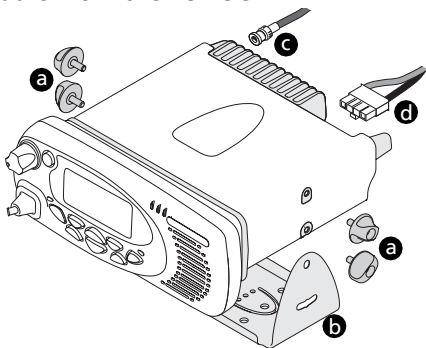

- 1 Switch off the radio.
- 2 Unscrew the four thumb screws **a** that secure the radio to the U-bracket **b**.
- 3 Carefully lift the radio clear of the U-bracket.
- 4 Disconnect the antenna **c** and power cable **d** from the rear of the radio.

Describing the radio's audible tones

The following table summarizes the radio's audible tones.

Action and tone	Meaning
two short beeps	Radio turned on: the radio is powered on and ready to use
one short beep after the power-up beeps	Radio locked: you need to enter your personal identity number (PIN) before you can use the radio
one long, low-pitched beep	Radio PIN entry unsuccessful: you need to re-enter your PIN
two short beeps	Radio PIN entry successful: the radio is now ready to use
one short beep	Function activated: a function key has been pressed and that function has been initiated
one short, low-pitched beep	Function deactivated: a function key has been pressed and the corresponding function has been turned off
one long, low-pitched beep	Invalid key press: the action you have attempted is not permitted, or Transmission inhibited: you have attempted to transmit but for some reason transmission is not permitted at this time
one short, high-pitched beep	Radio is stunned: the radio has been made inoperable by your service provider
two short beeps	Radio is revived: the radio has made operable by your service provider
three beeps	Transmit timeout imminent: in 10 seconds your transmit timer will expire and your current transmission will be terminated
one high-pitched beep	Call timeout imminent: your call time is about to expire (MPT trunked mode only)
two low-pitched beeps	Radio's temperature is high: the radio's temperature is in the high-temperature range, but the radio will continue to operate

Action and tone	Meaning
two high-pitched beeps	Radio's temperature is very high: the radio's temperature is in the very high temperature range and all transmissions will now be at low power; if the radio's temperature rises outside this range, transmissions will be inhibited
continuous low-pitched tone	Radio system error: a system error has occurred and the radio may be inoperable
two long low-high pitched tone pairs	Synthesizer is out-of-lock: the radio's synthesizer is out-of-lock on the current channel and you cannot operate on that channel

Tait general software licence agreement

This legal document is an Agreement between you (the "Licensee") and Tait Electronics Limited ("Tait"). By using any of the Software or Firmware items prior-installed in the related Tait product, included on CD or downloaded from the Tait website, (hereinafter referred to as "the Software or Firmware") you agree to be bound by the terms of this Agreement. If you do not agree to the terms of this Agreement, do not install and use any of the Software or Firmware. If you install and use any of the Software or Firmware that will be deemed to be acceptance of the terms of this licence agreement. The terms of this Agreement shall apply subject only to any express written terms of agreement to the contrary between Tait and the Licensee.

Licence

TAIT GRANTS TO YOU AS LICENSEE THE NON-EXCLUSIVE RIGHT TO USE THE SOFTWARE OR FIRMWARE ON A SINGLE MACHINE PROVIDED YOU MAY ONLY:

- 1 COPY THE SOFTWARE OR FIRMWARE INTO ANY MACHINE READABLE OR PRINTED FORM FOR BACKUP PURPOSES IN SUPPORT OF YOUR USE OF THE PROGRAM ON THE SINGLE MACHINE (CERTAIN PROGRAMS, HOWEVER, MAY INCLUDE MECHANISMS TO LIMIT OR INHIBIT COPYING, THEY ARE MARKED "COPY PROTECTED"), PROVIDED THE COPYRIGHT NOTICE MUST BE REPRODUCED AND INCLUDED ON ANY SUCH COPY OF THE SOFTWARE OR FIRMWARE;
AND / OR
- 2 MERGE IT INTO ANOTHER PROGRAM FOR YOUR USE ON THE SINGLE MACHINE (ANY PORTION OF ANY SOFTWARE OR FIRMWARE MERGED INTO ANOTHER PROGRAM WILL CONTINUE TO BE SUBJECT TO THE TERMS AND CONDITIONS OF THIS AGREEMENT).

THE LICENSEE MAY NOT DUPLICATE, MODIFY, REVERSE COMPILATE OR REVERSE ASSEMBLE ANY SOFTWARE OR FIRMWARE IN WHOLE OR PART.

Important Notice

THE SOFTWARE OR FIRMWARE MAY CONTAIN OPEN SOURCE SOFTWARE COMPONENTS ("OPEN SOURCE

COMPONENTS"). OPEN SOURCE COMPONENTS ARE EXCLUDED FROM THE TERMS OF THIS AGREEMENT EXCEPT AS EXPRESSLY STATED IN THIS AGREEMENT AND ARE COVERED BY THE TERMS OF THEIR RESPECTIVE LICENCES WHICH MAY EXCLUDE OR LIMIT ANY WARRANTY FROM OR LIABILITY OF THE DEVELOPERS AND/OR COPYRIGHT HOLDERS OF THE OPEN SOURCE COMPONENT FOR THE PERFORMANCE OF THOSE OPEN SOURCE COMPONENTS. YOU AGREE TO BE BOUND BY THE TERMS AND CONDITIONS OF EACH SUCH LICENCE. FOR MORE INFORMATION SEE: <http://support.taitworld.com/go/opensource>

Title to Software

THIS AGREEMENT DOES NOT CONSTITUTE A CONTRACT OF SALE IN RELATION TO THE SOFTWARE OR FIRMWARE SUPPLIED TO THE LICENSEE. NOT WITHSTANDING THE LICENSEE MAY OWN THE MAGNETIC OR OTHER PHYSICAL MEDIA ON WHICH THE SOFTWARE OR FIRMWARE WAS ORIGINALLY SUPPLIED, OR HAS SUBSEQUENTLY BEEN RECORDED OR FIXED, IT IS A FUNDAMENTAL TERM OF THIS AGREEMENT THAT AT ALL TIMES TITLE AND OWNERSHIP OF THE SOFTWARE OR FIRMWARE, WHETHER ON THE ORIGINAL MEDIA OR OTHERWISE, SHALL REMAIN VESTED IN TAIT OR THIRD PARTIES WHO HAVE GRANTED LICENCES TO TAIT.

Term and Termination

THIS LICENCE SHALL BE EFFECTIVE UNTIL TERMINATED IN ACCORDANCE WITH THE PROVISIONS OF THIS AGREEMENT. THE LICENSEE MAY TERMINATE THIS LICENCE AT ANY TIME BY DESTROYING ALL COPIES OF THE SOFTWARE OR FIRMWARE AND ASSOCIATED WRITTEN MATERIALS. THIS LICENCE WILL BE TERMINATED AUTOMATICALLY AND WITHOUT NOTICE FROM TAIT IN THE EVENT THAT THE LICENSEE FAILS TO COMPLY WITH ANY TERM OR CONDITION OF THIS AGREEMENT. THE LICENSEE AGREES TO DESTROY ALL COPIES OF THE SOFTWARE OR FIRMWARE AND ASSOCIATED WRITTEN MATERIALS IN THE EVENT OF SUCH TERMINATION.

Limited Warranty

THE SOFTWARE OR FIRMWARE (INCLUDING OPEN SOURCE COMPONENTS) IS SUPPLIED BY TAIT AND ACCEPTED BY THE LICENSEE "AS IS" WITHOUT

WARRANTY OF ANY KIND EITHER EXPRESSED OR IMPLIED, INCLUDING BUT NOT BEING LIMITED TO ANY IMPLIED WARRANTIES AS TO MERCHANTABILITY OR FITNESS FOR ANY PARTICULAR PURPOSE. THE LICENSEE ACKNOWLEDGES THAT THE SOFTWARE OR FIRMWARE (INCLUDING OPEN SOURCE COMPONENTS) IS USED BY IT IN BUSINESS AND ACCORDINGLY TO THE MAXIMUM EXTENT PERMITTED BY LAW NO TERMS OR WARRANTIES WHICH ARE IMPLIED BY LEGISLATION SHALL APPLY TO THIS AGREEMENT. TAIT DOES NOT WARRANT THAT THE FUNCTIONS CONTAINED IN THE SOFTWARE OR FIRMWARE (INCLUDING OPEN SOURCE COMPONENTS) WILL MEET THE LICENSEE'S REQUIREMENTS OR THAT THE OPERATION OF THE SOFTWARE OR FIRMWARE (INCLUDING OPEN SOURCE COMPONENTS) WILL BE UNINTERRUPTED OR ERROR FREE.

Exclusion of Liability

IN NO CIRCUMSTANCES SHALL TAIT BE UNDER ANY LIABILITY TO THE LICENSEE, OR ANY OTHER PERSON WHATSOEVER, WHETHER IN TORT (INCLUDING NEGLIGENCE), CONTRACT (EXCEPT AS EXPRESSLY PROVIDED IN THIS AGREEMENT), EQUITY, UNDER ANY STATUTE, OR OTHERWISE AT LAW FOR ANY LOSSES OR DAMAGES WHETHER GENERAL, SPECIAL, EXEMPLARY, PUNITIVE, DIRECT, INDIRECT OR CONSEQUENTIAL ARISING OUT OF OR IN CONNECTION WITH ANY USE OR INABILITY OF USING THE SOFTWARE OR FIRMWARE (INCLUDING OPEN SOURCE COMPONENTS).

THE LICENSEE'S SOLE REMEDY AGAINST TAIT WILL BE LIMITED TO BREACH OF CONTRACT AND TAIT'S SOLE AND TOTAL LIABILITY FOR ANY SUCH CLAIM SHALL BE LIMITED AT THE OPTION OF TAIT TO THE REPAIR OR REPLACEMENT OF THE SOFTWARE OR FIRMWARE OR THE REFUND OF THE PURCHASE PRICE OF THE SOFTWARE OR FIRMWARE.

General

THE LICENSEE CONFIRMS THAT IT SHALL COMPLY WITH THE PROVISIONS OF LAW IN RELATION TO THE SOFTWARE OR FIRMWARE.

Law and Jurisdiction

THIS AGREEMENT SHALL BE SUBJECT TO AND CONSTRUED IN ACCORDANCE WITH NEW ZEALAND LAW AND DISPUTES BETWEEN THE PARTIES CONCERNING THE PROVISIONS HEREOF SHALL BE DETERMINED BY THE NEW ZEALAND COURTS OF LAW. PROVIDED HOWEVER TAIT MAY AT ITS ELECTION BRING PROCEEDINGS FOR BREACH OF THE TERMS HEREOF OR

FOR THE ENFORCEMENT OF ANY JUDGEMENT IN RELATION TO A BREACH OF THE TERMS HEREOF IN ANY JURISDICTION TAIT CONSIDERS FIT FOR THE PURPOSE OF ENSURING COMPLIANCE WITH THE TERMS HEREOF OR OBTAINING RELIEF FOR BREACH OF THE TERMS HEREOF.

No Dealings

THE LICENSEE MAY NOT SUBLICENSE, ASSIGN OR TRANSFER THE LICENCE OR THE PROGRAM EXCEPT AS EXPRESSLY PROVIDED IN THIS AGREEMENT. ANY ATTEMPT OTHERWISE TO SUBLICENSE, ASSIGN OR TRANSFER ANY OF THE RIGHTS, DUTIES OR OBLIGATIONS HEREUNDER IS VOID.

No Other Terms

THE LICENSEE ACKNOWLEDGES THAT IT HAS READ THIS AGREEMENT, UNDERSTANDS IT AND AGREES TO BE BOUND BY ITS TERMS AND CONDITIONS. THE LICENSEE FURTHER AGREES THAT SUBJECT ONLY TO ANY EXPRESS WRITTEN TERMS OF AGREEMENT TO THE CONTRARY BETWEEN TAIT AND THE LICENSEE THIS IS THE COMPLETE AND EXCLUSIVE STATEMENT OF THE AGREEMENT BETWEEN IT AND TAIT IN RELATION TO THE SOFTWARE OR FIRMWARE WHICH SUPERSEDES ANY PROPOSAL OR PRIOR AGREEMENT, ORAL OR WRITTEN AND ANY OTHER COMMUNICATIONS BETWEEN THE LICENSEE AND TAIT RELATING TO THE SOFTWARE OR FIRMWARE.

www.taitworld.com

06/06 MMA-00003-05

