



## REPORT ON :

Type Approval Testing of the TMAB34-H701 (Serial No 19020187)  
in accordance with:

FCC CFR 47 Parts 22 & 90

FCC ID: CASTMAH7F

## PREPARED FOR :

Tait Electronics Ltd  
PO Box 1645  
558 Wairakei Rd  
Christchurch  
New Zealand

## DISTRIBUTION :

TELTest Laboratory	Mr S Crompton	Copy No 1
Tait Electronics Ltd	Mr. Des Fox	Copy No 2
Tait Electronics Ltd	Mr. Dereck Fiddes	Copy No 3

## APPROVED :

Hamish Newton

Senior Technician

## Date :

All tests reported herein have been performed in accordance with the  
laboratory's scope of accreditation

This document must not be reproduced except in full, without the written  
permission of the Compliance Laboratory Manager.

Copy No:

## TABLE OF CONTENTS

<b>DECLARATION OF CONFORMITY</b> .....	<b>4</b>
<b>TEST CONDITIONS</b> .....	<b>5</b>
<b>NECESSARY BANDWIDTH AND EMISSION DESIGNATORS</b> .....	<b>5</b>
<b>TEST RESULTS</b> .....	<b>9</b>
TRANSMITTER OUTPUT POWER (CONDUCTED) .....	9
TRANSMITTER AUDIO FREQUENCY RESPONSE - PRE-EMPHASIS .....	10
OCCUPIED BANDWIDTH .....	15
<i>ANALOGUE VOICE</i> .....	16
<i>FFSK</i> .....	20
<i>THSD</i> .....	24
<i>DIGITAL - 4 Level FSK</i> .....	28
SPURIOUS EMISSIONS (CONDUCTED).....	32
SPURIOUS EMISSIONS (RADIATED).....	35
TRANSMITTER FREQUENCY STABILITY (TEMPERATURE) .....	38
TRANSMITTER FREQUENCY STABILITY (VOLTAGE).....	40
TRANSIENT FREQUENCY BEHAVIOR .....	41
<b>TEST EQUIPMENT USED</b> .....	<b>46</b>
<b>APPENDIX A</b> .....	<b>47</b>
TEST SETUP DETAILS.....	47

## DECLARATION OF CONFORMITY

We, TELTEST LABORATORIES of 558 Wairakei Road, Christchurch New Zealand, declare under our sole responsibility that the product:

Equipment: Mobile Transceiver

Type: TMAH7F

Product code: TMAB34-H701

Serial Numbers: 19018543

Quantity: 1

To which this declaration relates is in conformity with the following standards:

**FCC CFR 47 Parts 22 & 90**

**Signature:** \_\_\_\_\_

S. A. Crompton  
Compliance Laboratory Manager.

**Date:** \_\_\_\_\_

## Test Conditions

All testing was performed at the following conditions.

Ambient Temperature	15°C to 30°C
Relative Humidity	20% to 75%
Standard Test Voltage	13.8Vdc

## Necessary Bandwidth and Emission Designators

SPECIFICATION: FCC 47 CFR 2.202

The Necessary Bandwidth is the minimum value of the occupied bandwidth sufficient to ensure the transmission of information at the rate and with the quality required for the system employed.

This is calculated using the following formula.

$$B_n = 2M + 2DK$$

Where:  $B_n$  = Necessary Bandwidth  
 $M$  = Maximum modulation frequency  
For Data transmission  
 $M = B/2$   
Where:  $B$  = Modulation rate in Baud  
 $D$  = Peak deviation  
 $K$  = Constant  
For Analogue transmission this is 1  
For Data transmission this is typically 1.2

### 1. Analogue Voice 12.5kHz Bandwidth

Necessary bandwidth Emission Designator

$$M = 3\text{kHz}$$
$$D = 2.5\text{kHz}$$

**11K0F3E**

F3E represents an analogue FM voice transmission

$$B_n = 6 + 5 \times 1$$
$$= 11\text{kHz}$$

### 2. Analogue Voice 25kHz Bandwidth

Necessary bandwidth Emission Designator

$$M = 3\text{kHz}$$
$$D = 5\text{kHz}$$

**16K0F3E**

F3E represents an analogue FM voice transmission

$$B_n = 6 + 10 \times 1$$
$$= 16\text{kHz}$$

### 3. Fast Frequency Shift Keying (FFSK) 12.5kHz Bandwidth

Necessary bandwidth Emission Designator

$$M = 0.6 \text{ (Baud rate = 1200)}$$
$$D = 1.5\text{kHz (60\% of peak deviation)}$$

**4K80F2D**

F2D represents a FM data transmission with the use of a modulating sub carrier

$$B_n = 1.2 + 3 \times 1.2$$
$$= 4.8\text{kHz}$$

#### 4. Fast Frequency Shift Keying (FFSK) 25kHz Bandwidth

Necessary bandwidth

Emission Designator

M = 0.6 (Baud rate = 1200)

D = 3kHz (60% of peak deviation)

**8K40F2D**

F2D represents a FM data transmission with the use of a modulating sub carrier

$B_n = 1.2 + 6 \times 1.2$   
=8.4kHz

#### 5. Tait High Speed Data (THSD)

THSD uses a 4 level gaussian frequency shift keying (CP-4GFSK) modulation scheme. It can be used when transferring data between two radios. Data is transmitted at a rate of 12000bps for narrow band channels, and 19200bps for wide-band channels.

Due to the difficulties in determining the value of k, the necessary bandwidth has been measured using the 99% energy rule.

12.5kHz Bandwidth

99% bandwidth

Emission Designator

7.8 kHz

**7K80F1D**

F1D represents a FM data transmission without the use of a modulating sub carrier

25kHz Bandwidth

99% bandwidth

Emission Designator

12.3 kHz

**12K3F1D**

F1D represents a FM data transmission without the use of a modulating sub carrier

#### 6. Digital Voice /Data (4 – Level FSK) – CFR 47 90.212 (b)

Digital Voice/data transmissions use a 4 level frequency shift keying modulation scheme. The necessary bandwidth as been measured using the 99% energy rule, and in accordance with TIA/EIA 102 CAAB 2.2.5.2

a) Operating in a 12.5 kHz Bandwidth

##### *Digital voice*

99% bandwidth

Emission Designator

8.1 kHz

**8K10F1E**

F1E represents a digital FM voice transmission

**8K10F7E**

F7E represents two or more channels containing quantized or digital voice information

*Digital Data*

99% bandwidth

Emission Designator

8.1 kHz

**8K10F1D**

F1D represents a digital FM data transmission

**8K10F7D**

F7D represents two or more channels containing quantized or digital information

b) Operating in a 25 kHz Bandwidth

*Digital voice*

99% bandwidth

Emission Designator

10.0 kHz

**10K0F1E**

F1E represents a digital FM voice transmission

**10K0F7E**

F7E represents two or more channels containing quantized or digital voice information

*Digital Data*

99% bandwidth

Emission Designator

10.0 kHz

**10K0F1D**

F1D represents a digital FM data transmission

**10K0F7D**

F7D represents two or more channels containing quantized or digital information

**7. Digital Voice Encryption (4 – Level FSK) – CFR 47 90.212 (b)**

Digital Voice Encryption transmissions use a 4 level frequency shift keying modulation scheme.

The necessary bandwidth as been measured using the 99% energy rule, and in accordance with TIA/EIA 102 CAAB 2.2.5.2

b) Operating in a 12.5 kHz Bandwidth

Digital voice

99% bandwidth

Emission Designator

8.1 kHz

**8K10F1E**

F1E represents a digital FM voice transmission

c) Operating in a 25 kHz Bandwidth

Digital voice

99% bandwidth

Emission Designator

10.0 kHz

**10K0F1E**

F1E represents a digital FM voice transmission



## Test Results

### TRANSMITTER OUTPUT POWER (CONDUCTED)

SPECIFICATION: FCC 47 CFR 2.1046

GUIDE: TIA/EIA-603B 2.2.1

#### MEASUREMENT PROCEDURE:

1. Refer Appendix A for Equipment set up.
2. The coaxial attenuator has an impedance of 50 Ohms.
3. The unmodulated output power was measured with an RF Power meter.

#### MEASUREMENT RESULTS:

Manufacturer's Rated Output Power: Switchable: 10 W and 40 W

460.1 MHz	10 W nominal	40 W nominal
POWER (W)	10.1	40.2
Variation from Nominal (%)	1.0	0.5
Measurement Uncertainty (dB)		+0.63 -0.68

LIMIT CLAUSE: FCC 47 CFR 90.205

Radio Type: Mobile Transceiver

Frequency Band: 421 MHz ~ 512 MHz

- (o) The output power shall not exceed by more than 20% the manufacturer's rated output power for the particular transmitter.

**TRANSMITTER AUDIO FREQUENCY RESPONSE - PRE-EMPHASIS**

SPECIFICATION: FCC 47 CFR 2.1047 (a)

GUIDE: TIA/EIA-603B 2.2.6

**MEASUREMENT PROCEDURE:**

1. Refer Appendix A for Equipment set up.
2. An audio input tone of 1000Hz was applied with the level set to obtain 20% of maximum deviation. This was used as the 0dB reference point.
3. The AF was varied while the audio level was held constant.
4. The response in dB relative to 1000Hz was measured.

**MEASUREMENT RESULTS:**

See the plots on the following pages for 12.5 kHz & 25.0 kHz channel spacings.

LIMIT CLAUSE: TIA/EIA-603B 3.2.6

TRANSMITTER AUDIO FREQUENCY RESPONSE - PRE-EMPHASIS

SPECIFICATION: FCC CFR 2.1047 (a)

Tx FREQUENCY: 460.1 MHz 12.5 kHz Channel Spacing

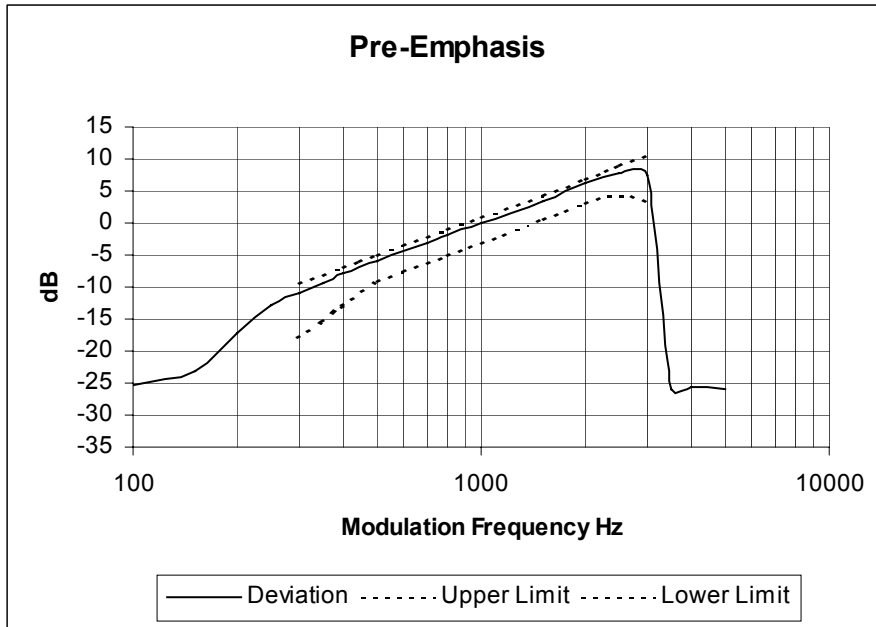

Tx FREQUENCY: 460.1 MHz 25.0 kHz Channel Spacing

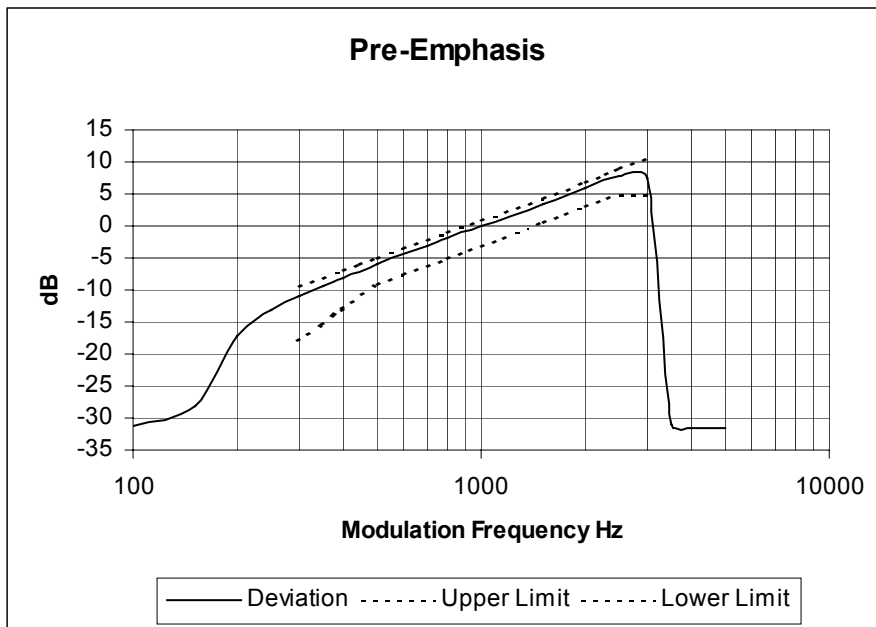

## TRANSMITTER MODULATION LIMITING

SPECIFICATION: FCC 47 CFR 2.1047 (b)

### MEASUREMENT PROCEDURE:

1. Refer Appendix A for Equipment set up.
2. The modulation response was measured at three audio frequencies while varying the input level.
3. Measurements were made for both Positive and Negative Deviation.

### MEASUREMENT RESULTS:

See the plots on the following pages for 12.5 kHz & 25.0 kHz channel spacings.

LIMIT CLAUSE: TIA/EIA-603B 1.3.4.4

TRANSMITTER MODULATION LIMITING

SPECIFICATION: FCC CFR 2.1047 (b)

Tx FREQUENCY: 460.1 MHz 12.5 kHz Channel Spacing

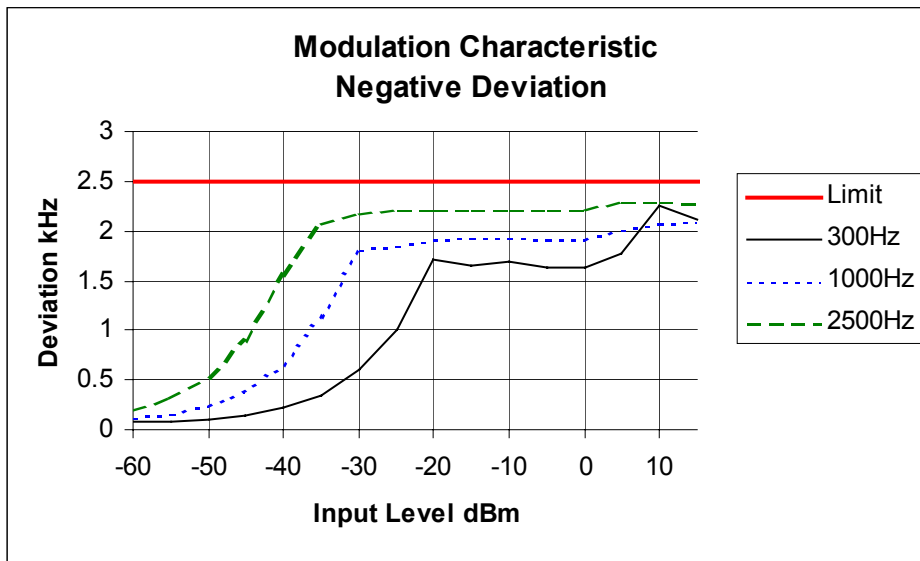
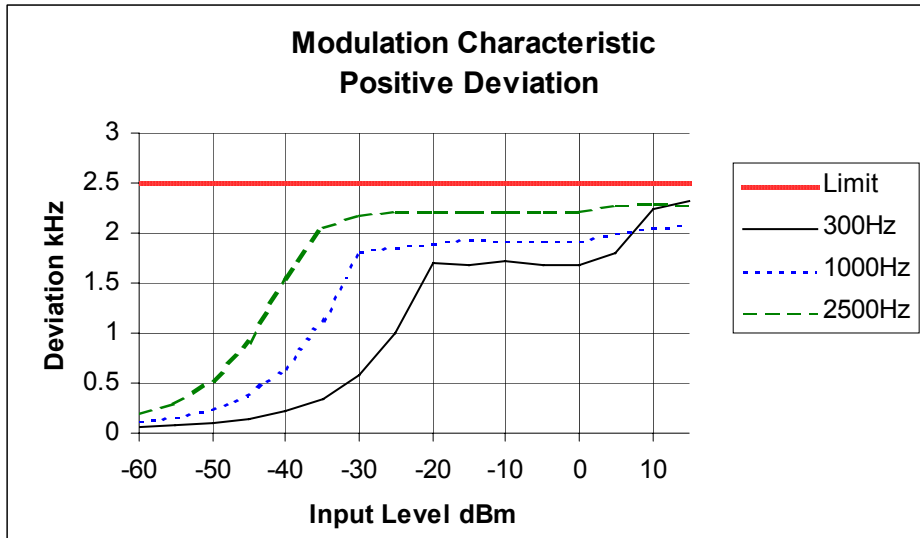

TRANSMITTER MODULATION LIMITING

SPECIFICATION: FCC CFR 2.1047 (b)

Tx FREQUENCY: 460.1 MHz 25.0 kHz Channel Spacing

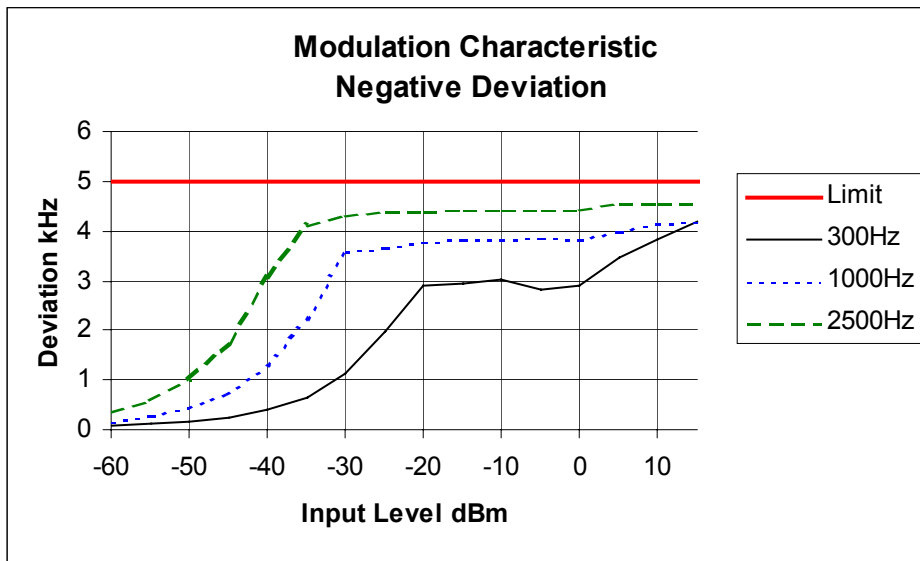
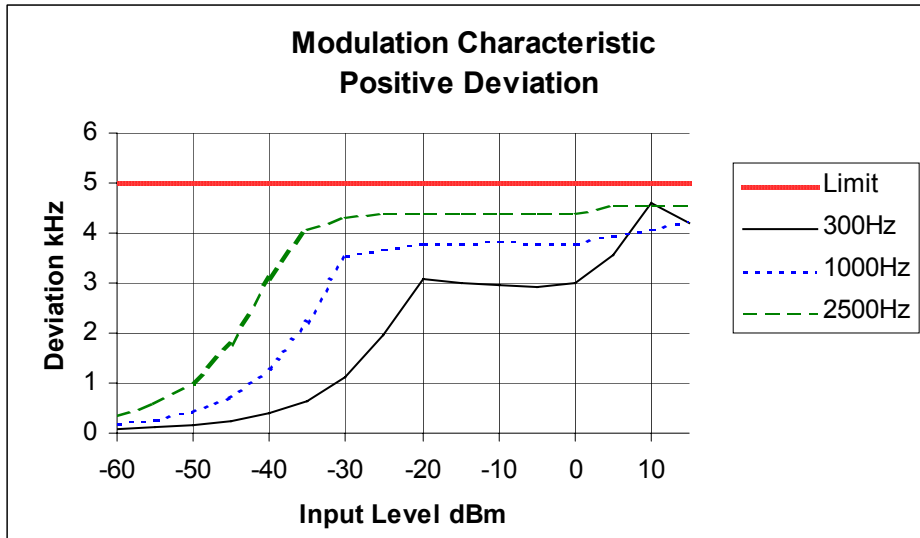

## OCCUPIED BANDWIDTH

SPECIFICATION: FCC 47 CFR 2.1049 (c)

GUIDE: TIA/EIA-603B 2.2.11  
TIA/EIA-102CAAA-A 2.2.5

### MEASUREMENT PROCEDURE:

1. Refer Appendix A for Equipment Set up.
2. For analogue measurements: The EUT was modulated by a 2500Hz tone at an input level 16dB above a level that produced 50% deviation. The input level was established at the frequency of maximum response of the audio modulating circuit .  
For Digital measurements: The EUT was modulated with an internally generated pseudo random bit sequence at the appropriate Baud rates.
3. The Occupied Bandwidth was measured on the Spectrum Analyser, with bandwidth settings as follows.

Emission Mask D – Resolution Bandwidth = 100Hz, Video Bandwidth = 1 kHz  
Emission Mask B, and C – Resolution bandwidth = 300Hz, Video Bandwidth = 3 kHz

### MEASUREMENT RESULTS:

See the plots on the following pages for 12.5 kHz & 25.0 kHz channel spacings.

LIMIT CLAUSE: FCC 47 CFR 90.210

### EMISSION MASKS

Emission Mask D	12.5 kHz Channel Spacing	Analog; Digital; FFSK; THSD
Emission Mask B	25.0 kHz Channel Spacing	Analog;
Emission Mask C	25.0 kHz Channel Spacing	Digital; FFSK; THSD

### DATA SPEED

Digital 9600 bps	12.5 kHz Channel Spacing
Digital 9600 bps	25.0 kHz Channel Spacing
FFSK 1200 bps	12.5 kHz Channel Spacing
FFSK 1200 bps	25.0 kHz Channel Spacing
THSD 12000 bps	12.5 kHz Channel Spacing
THSD 19200 bps	25.0 kHz Channel Spacing

OCCUPIED BANDWIDTH

ANALOGUE VOICE

SPECIFICATION: FCC CFR 2.1049 (c)

Tx FREQUENCY: 460.1 MHz 40W 12.5 kHz Channel Spacing

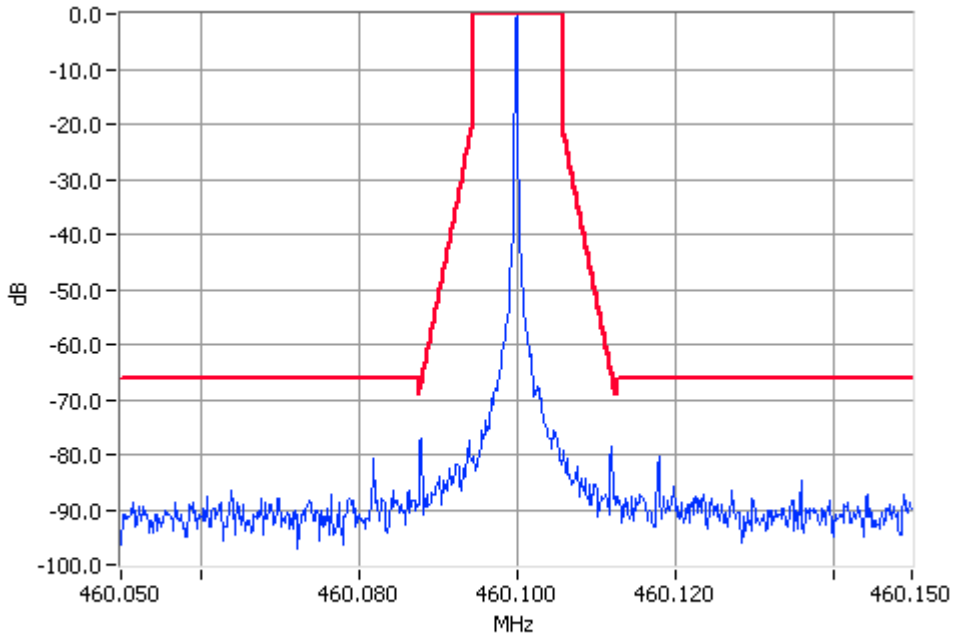

Unmodulated 460.1000MHz Mask D 40W Pass  
RBW=100Hz VBW=1000Hz

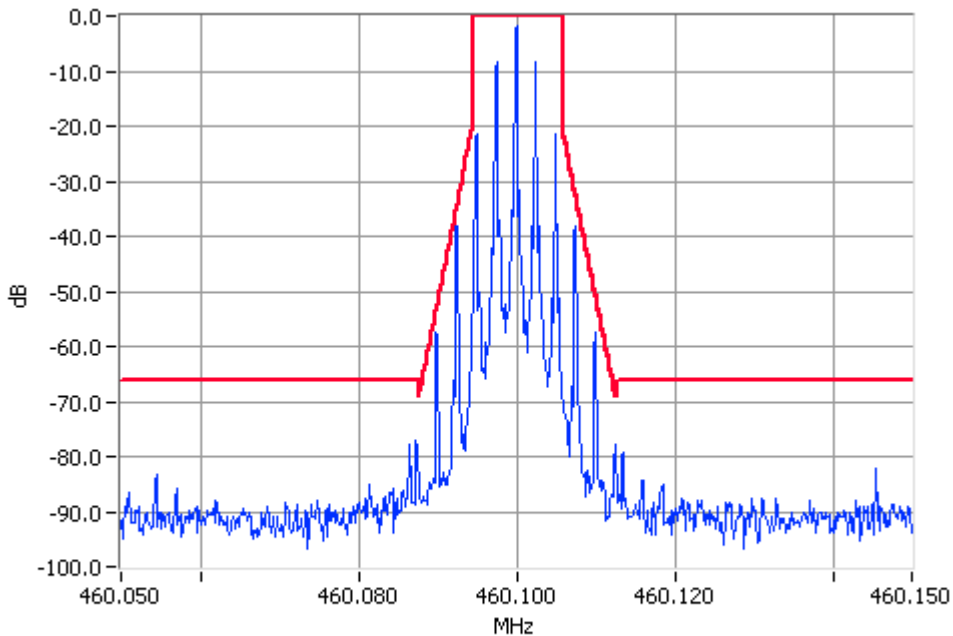

Analogue Modulation 460.1000MHz Mask D 40W Pass  
RBW=100Hz VBW=1000Hz



OCCUPIED BANDWIDTH

ANALOGUE VOICE

SPECIFICATION: FCC CFR 2.1049 (c)

Tx FREQUENCY: 460.1 MHz 10W 12.5 kHz Channel Spacing

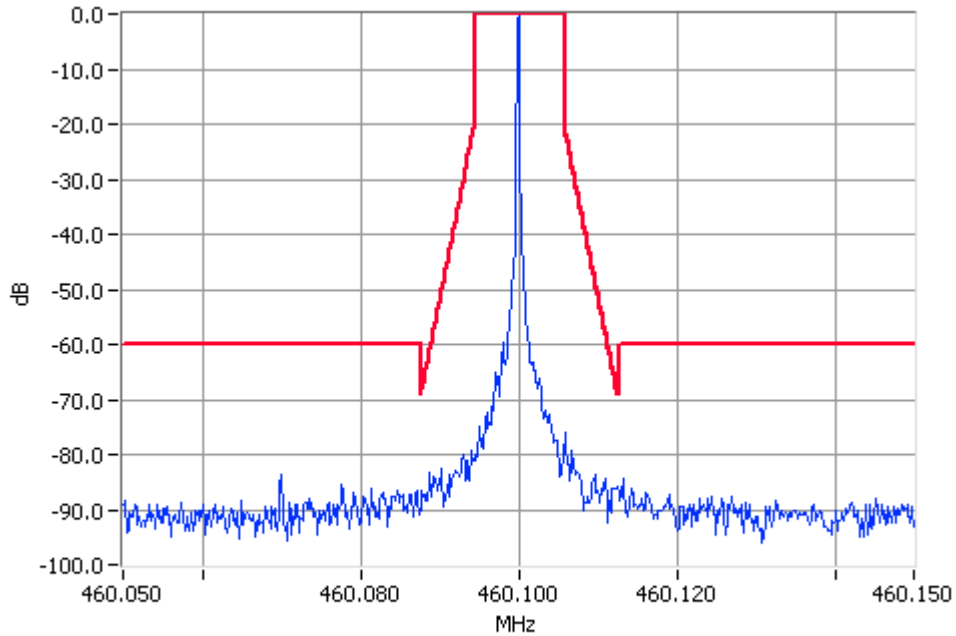

Unmodulated 460.1000MHz Mask D 10W Pass  
RBW=100Hz VBW=1000Hz

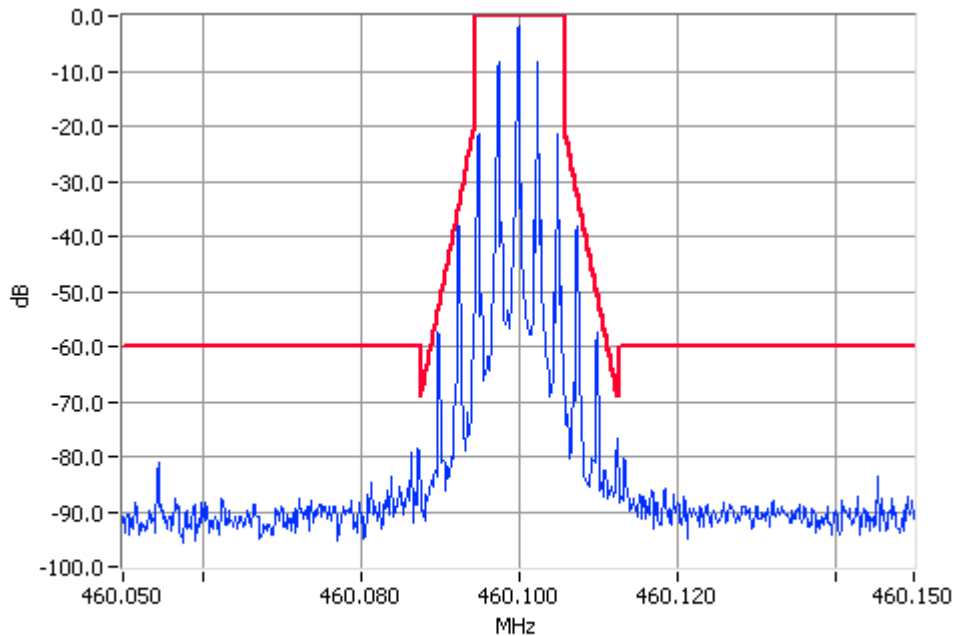

Analogue Modulation 460.1000MHz Mask D 10W Pass  
RBW=100Hz VBW=1000Hz

OCCUPIED BANDWIDTH

ANALOGUE VOICE

SPECIFICATION: FCC CFR 2.1049 (c)

Tx FREQUENCY: 460.1 MHz 40W 25 kHz Channel Spacing

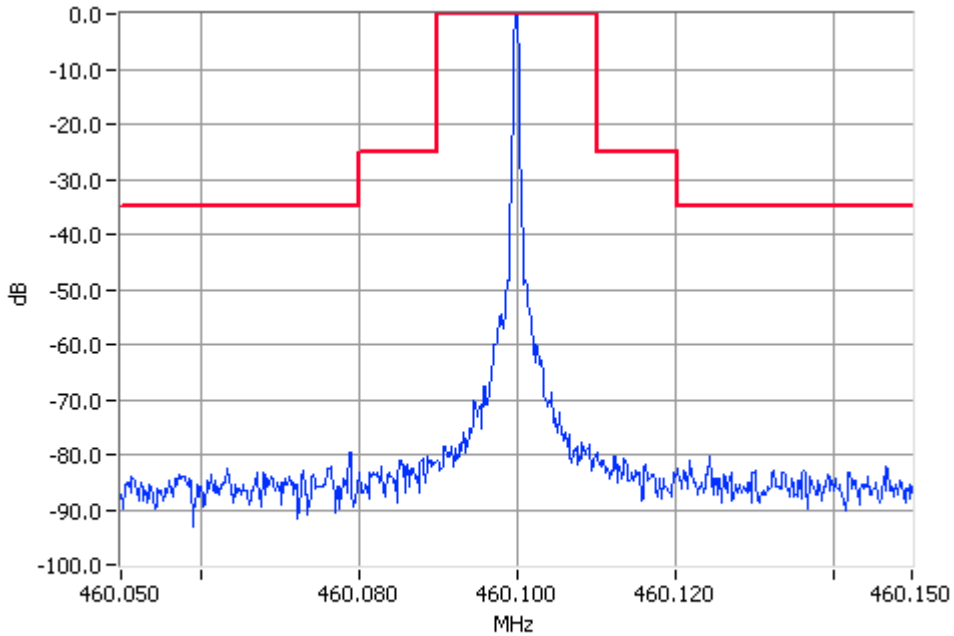

Unmodulated 460.1000MHz Mask B 40W Pass  
RBW=300Hz VBW=3000Hz

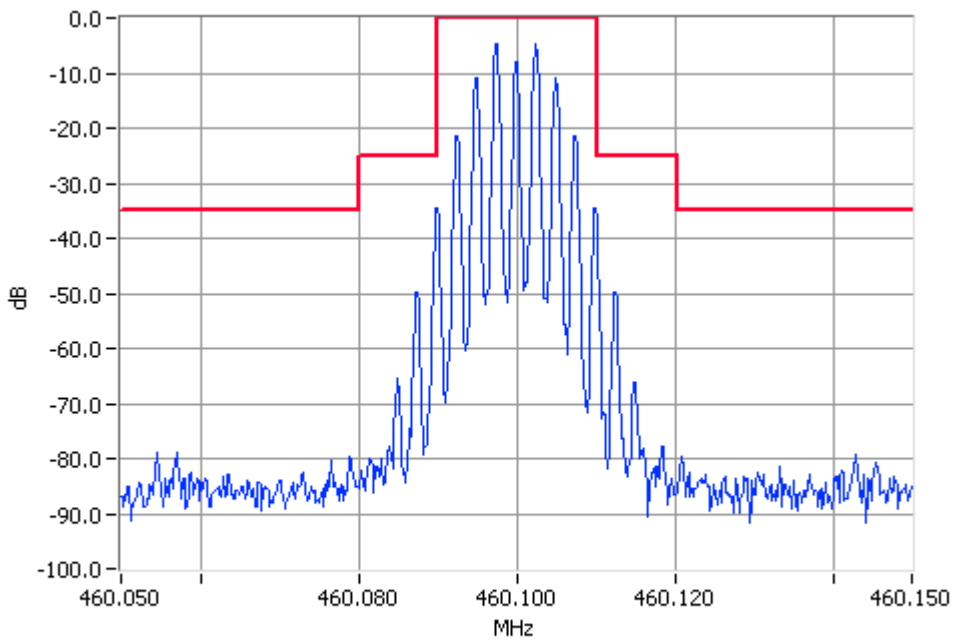

Analogue Modulation 460.1000MHz Mask B 40W Pass  
RBW=300Hz VBW=3000Hz

OCCUPIED BANDWIDTH

ANALOGUE VOICE

SPECIFICATION: FCC CFR 2.1049 (c)

Tx FREQUENCY: 460.1 MHz 10W 25 kHz Channel Spacing

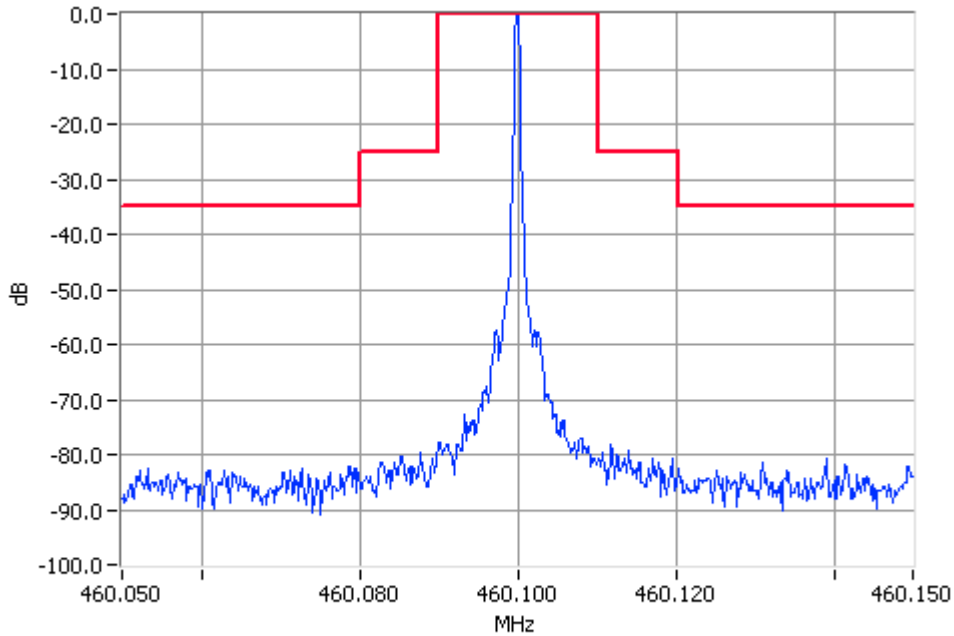

Unmodulated 460.1000MHz Mask B 10W Pass  
RBW=300Hz VBW=3000Hz

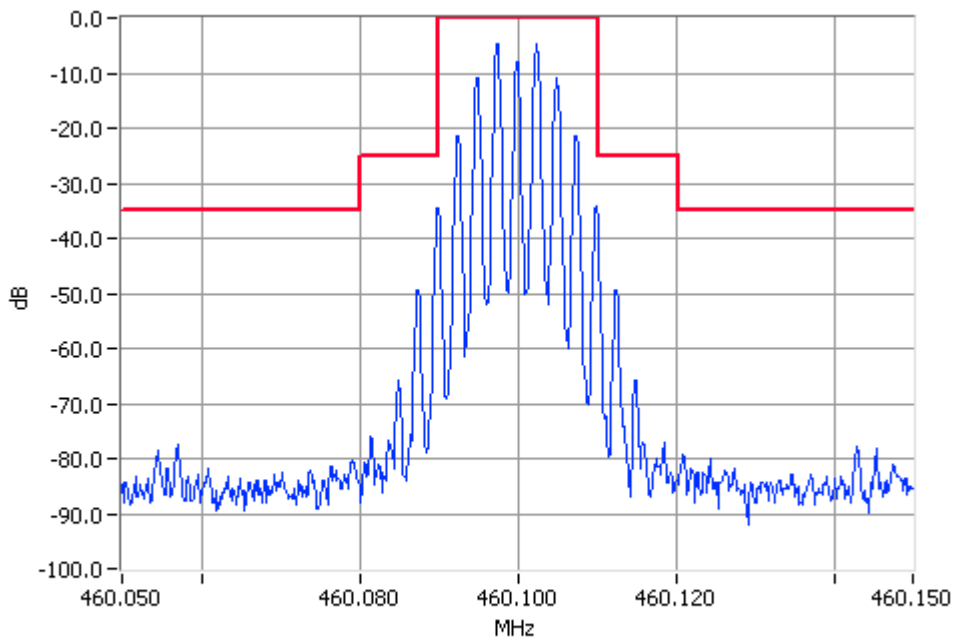

Analogue Modulation 460.1000MHz Mask B 10W Pass  
RBW=300Hz VBW=3000Hz

OCCUPIED BANDWIDTH

FFSK

SPECIFICATION: FCC CFR 2.1049 (c)

Tx FREQUENCY: 460.1 MHz 40W 12.5 kHz Channel Spacing

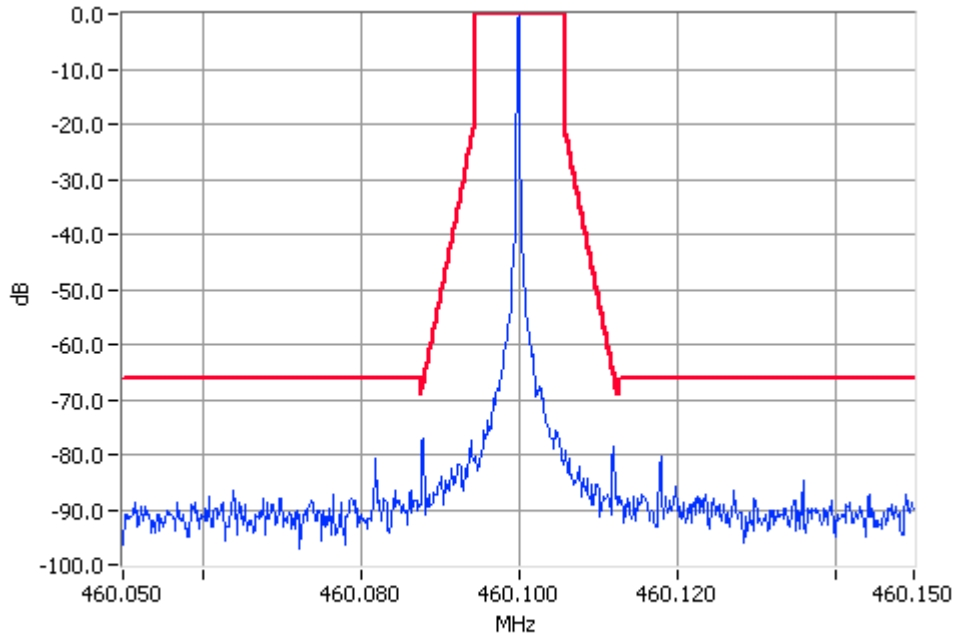

Unmodulated 460.1000MHz Mask D 40W Pass  
RBW=100Hz VBW=1000Hz

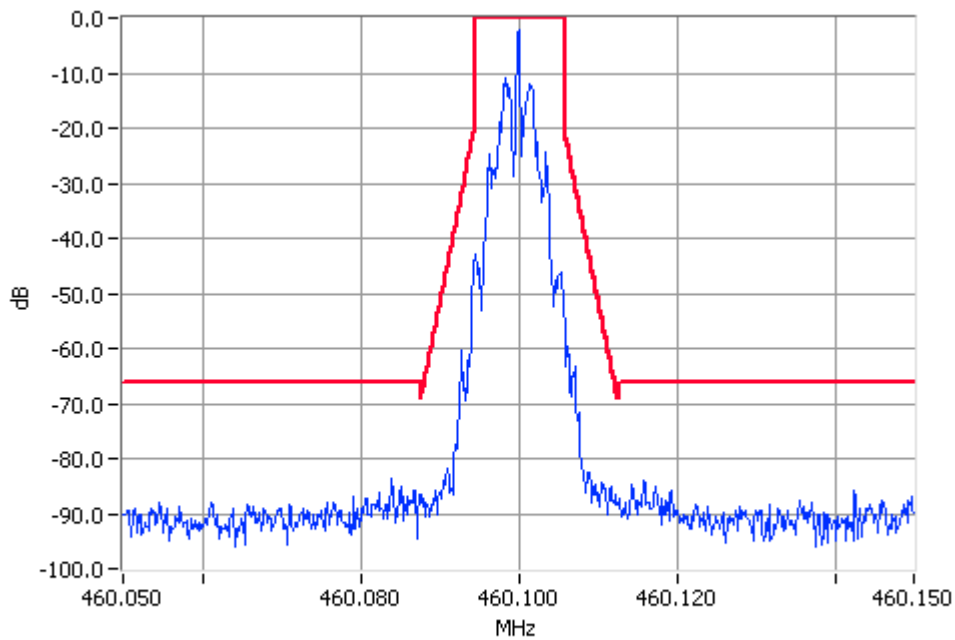

Digital Modulation 460.1000MHz Mask D 40W Pass  
RBW=100Hz VBW=1000Hz

OCCUPIED BANDWIDTH

FFSK

SPECIFICATION: FCC CFR 2.1049 (c)

Tx FREQUENCY: 460.1 MHz 10W 12.5 kHz Channel Spacing

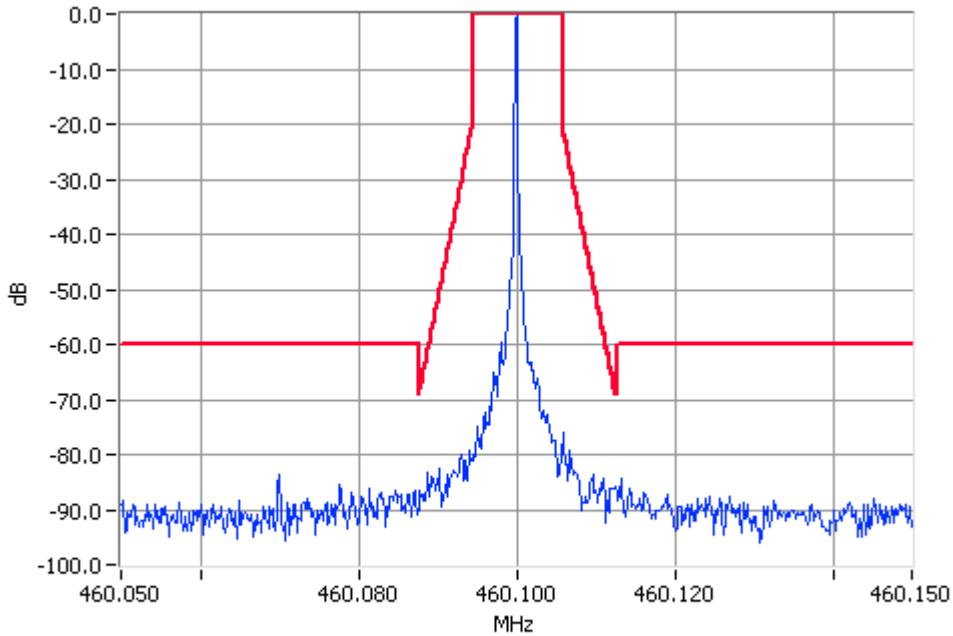

Unmodulated 460.1000MHz Mask D 10W Pass  
RBW=100Hz VBW=1000Hz

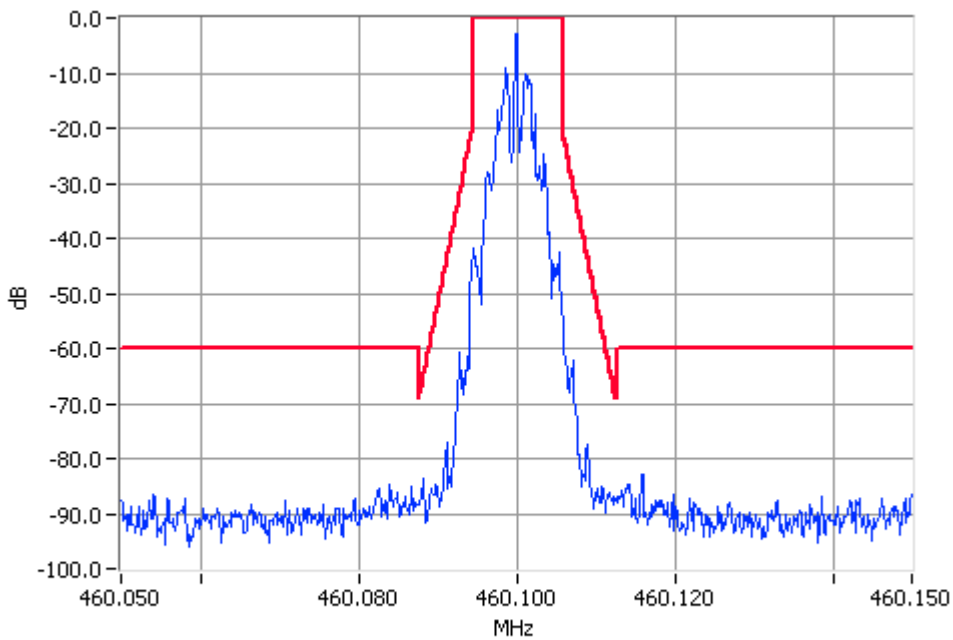

Digital Modulation 460.1000MHz Mask D 10W Pass  
RBW=100Hz VBW=1000Hz

OCCUPIED BANDWIDTH

FFSK

SPECIFICATION: FCC CFR 2.1049 (c)

Tx FREQUENCY: 460.1 MHz 40W 25 kHz Channel Spacing

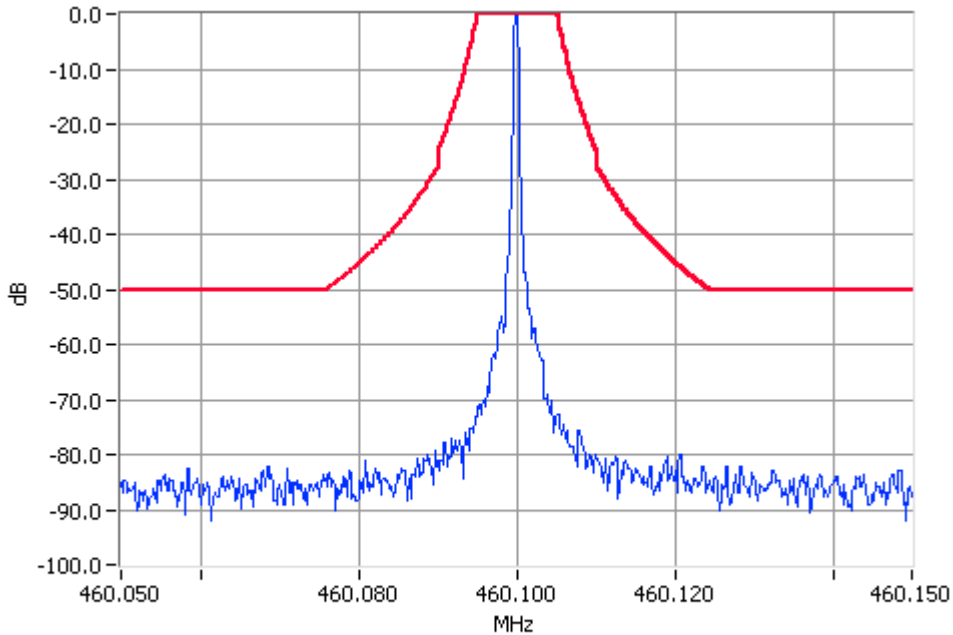

Unmodulated 460.1000MHz Mask C 40W Pass  
RBW=300Hz VBW=3000Hz

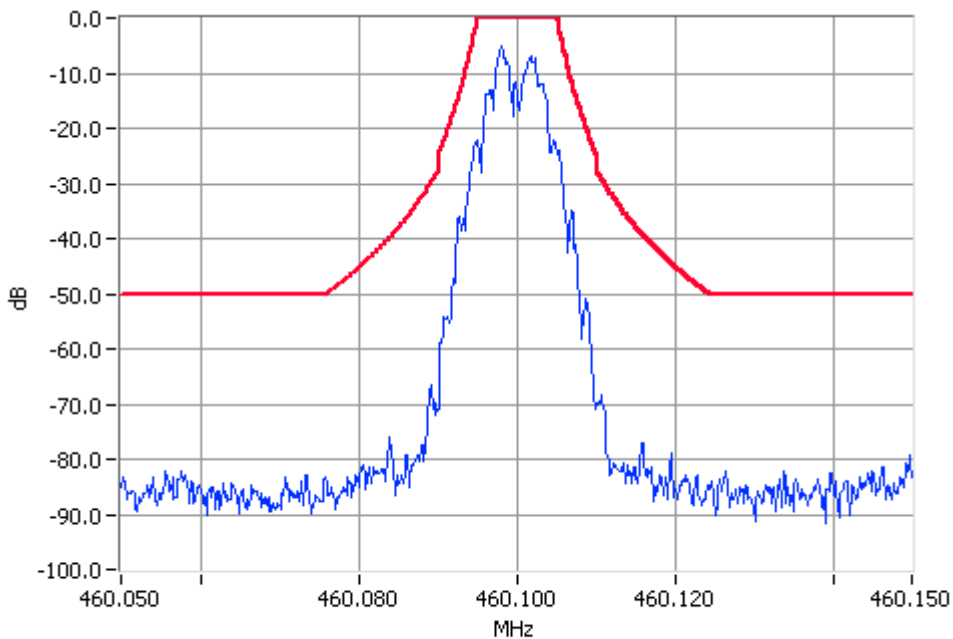

Digital Modulation 460.1000MHz Mask C 40W Pass  
RBW=300Hz VBW=3000Hz

OCCUPIED BANDWIDTH

FFSK

SPECIFICATION: FCC CFR 2.1049 (c)

Tx FREQUENCY: 460.1 MHz 10W 25 kHz Channel Spacing

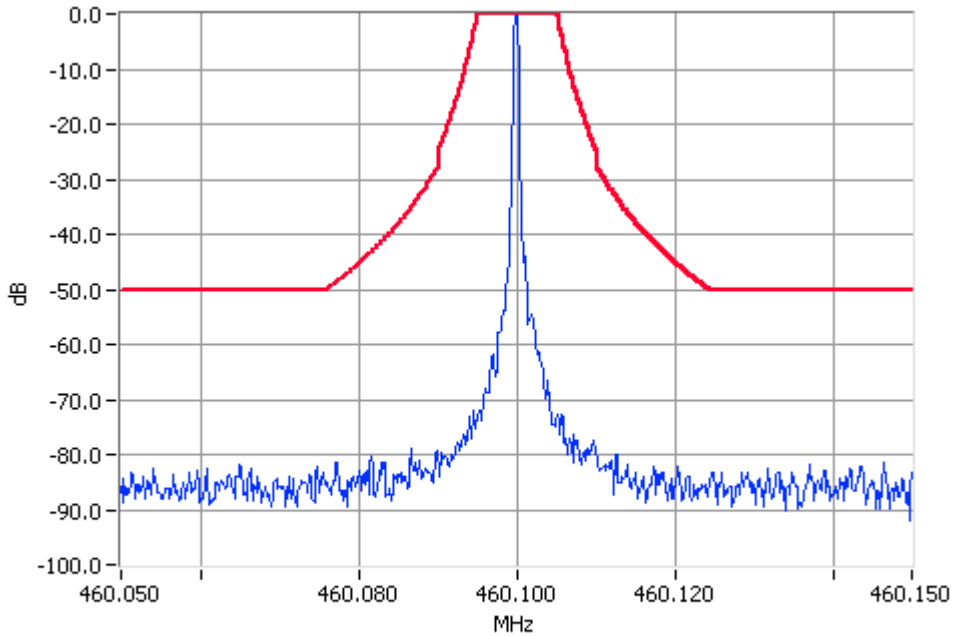

Unmodulated 460.1000MHz Mask C 10W Pass  
RBW=300Hz VBW=3000Hz

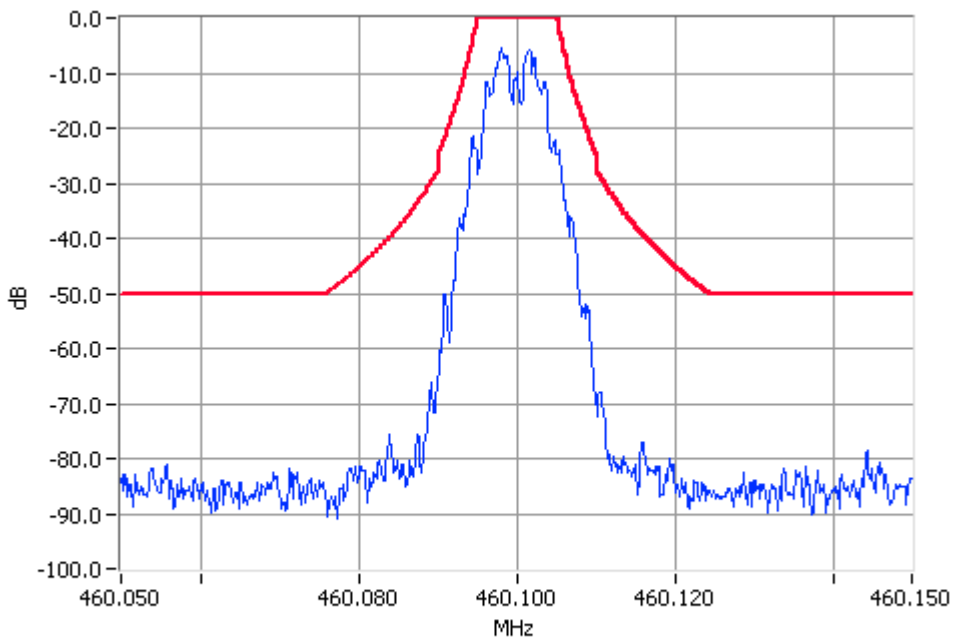

Digital Modulation 460.1000MHz Mask C 10W Pass  
RBW=300Hz VBW=3000Hz

OCCUPIED BANDWIDTH

THSD

SPECIFICATION: FCC CFR 2.1049 (c)

Tx FREQUENCY: 460.1 MHz 40W 12.5 kHz Channel Spacing

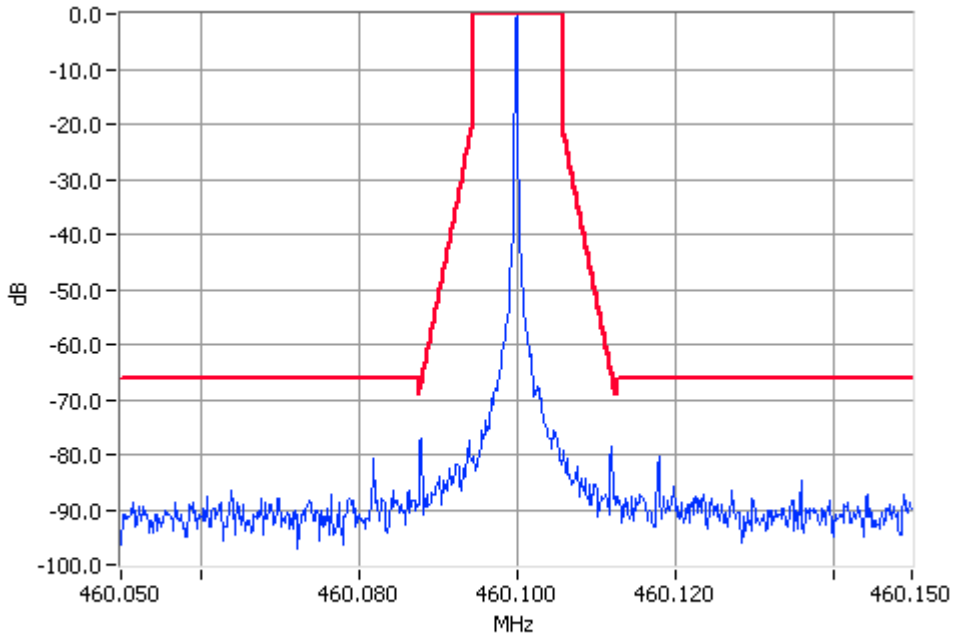

Unmodulated 460.1000MHz Mask D 40W Pass  
RBW=100Hz VBW=1000Hz

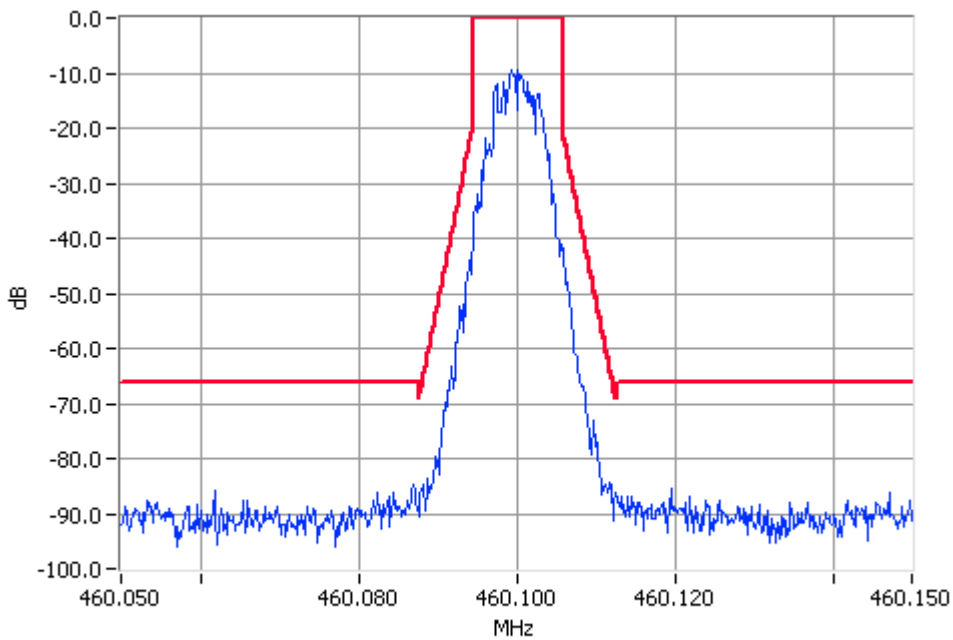

Digital Modulation 460.1000MHz Mask D 40W Pass  
RBW=100Hz VBW=1000Hz



OCCUPIED BANDWIDTH

THSD

SPECIFICATION: FCC CFR 2.1049 (c)

Tx FREQUENCY: 460.1 MHz 10W 12.5 kHz Channel Spacing

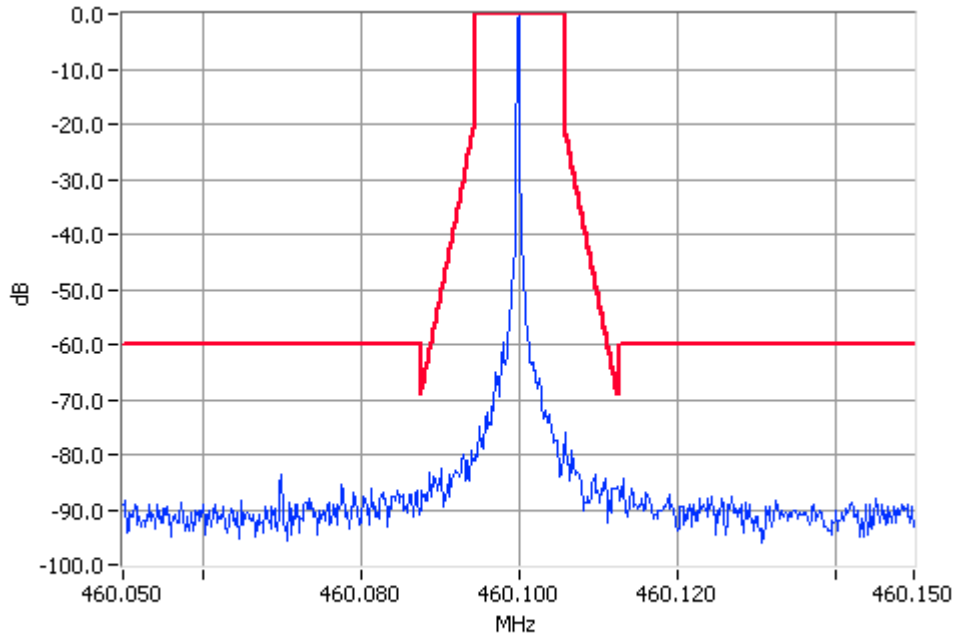

Unmodulated 460.1000MHz Mask D 10W Pass  
RBW=100Hz VBW=1000Hz

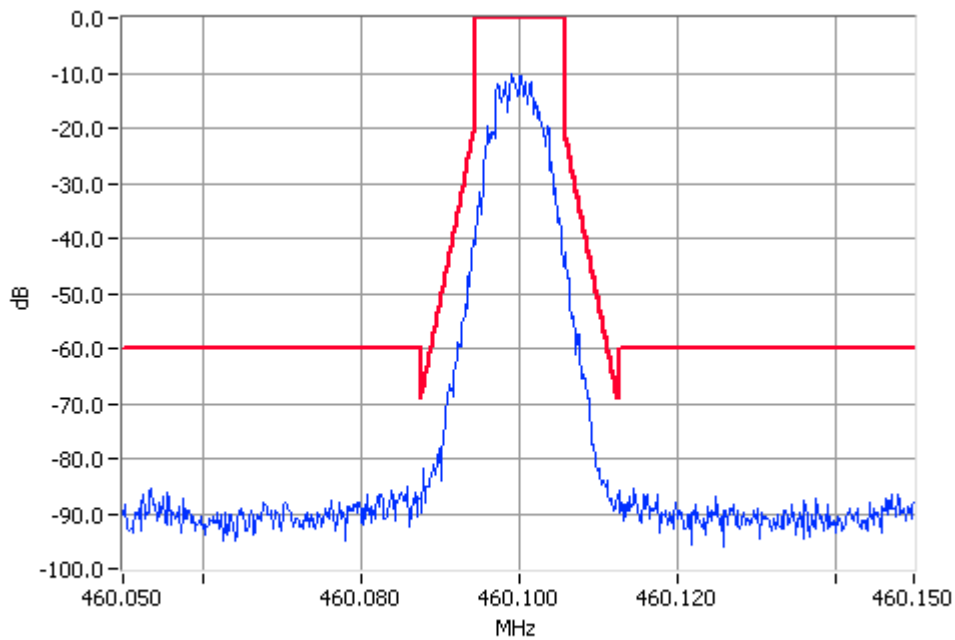

Digital Modulation 460.1000MHz Mask D 10W Pass  
RBW=100Hz VBW=1000Hz

OCCUPIED BANDWIDTH

THSD

SPECIFICATION: FCC CFR 2.1049 (c)

Tx FREQUENCY: 460.1 MHz 40W 25 kHz Channel Spacing

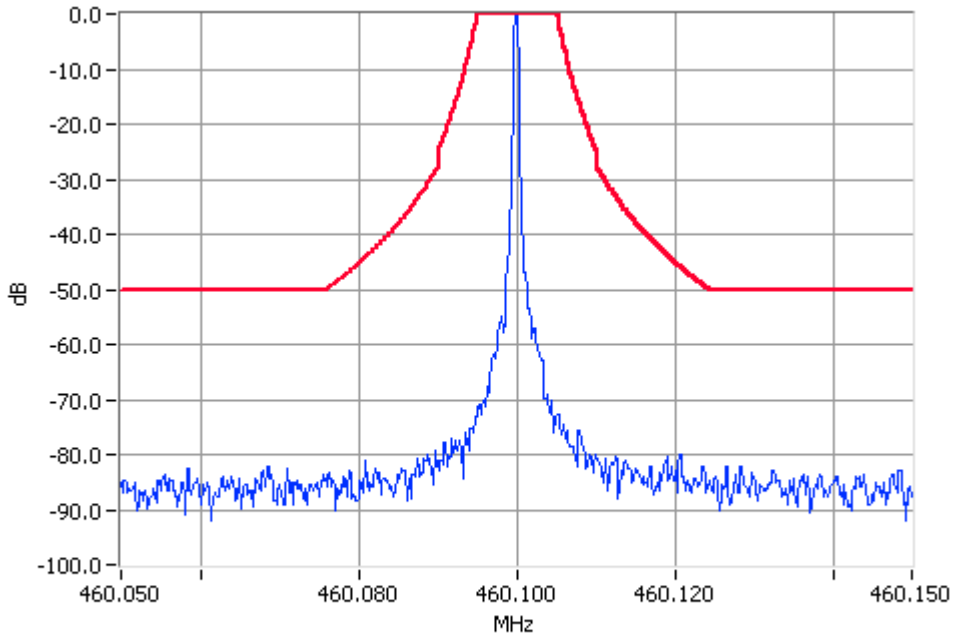

Unmodulated 460.1000MHz Mask C 40W Pass  
RBW=300Hz VBW=3000Hz

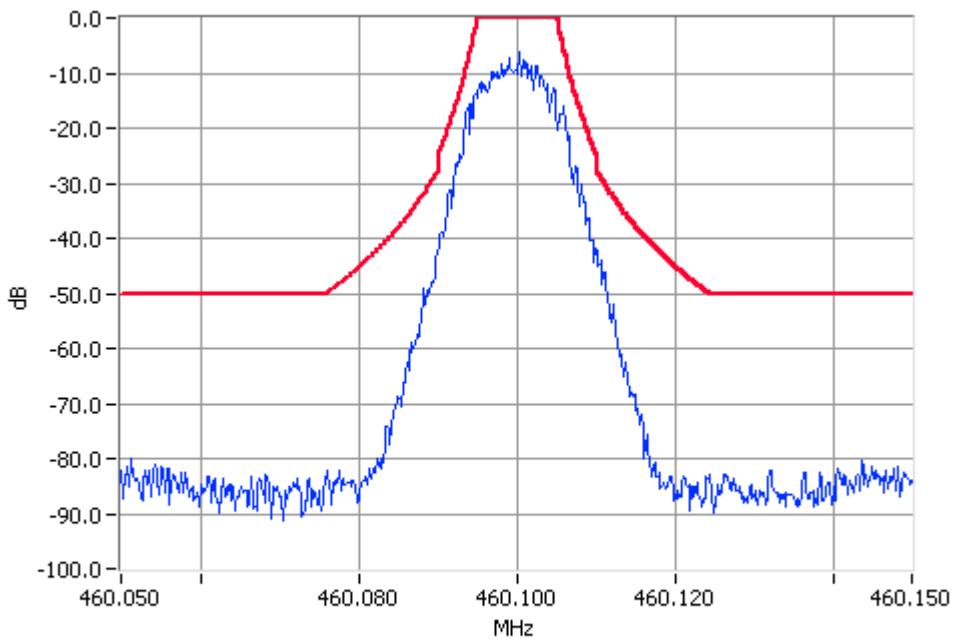

Digital Modulation 460.1000MHz Mask C 40W Pass  
RBW=300Hz VBW=3000Hz

OCCUPIED BANDWIDTH

THSD

SPECIFICATION: FCC CFR 2.1049 (c)

Tx FREQUENCY: 460.1 MHz 10W 25 kHz Channel Spacing

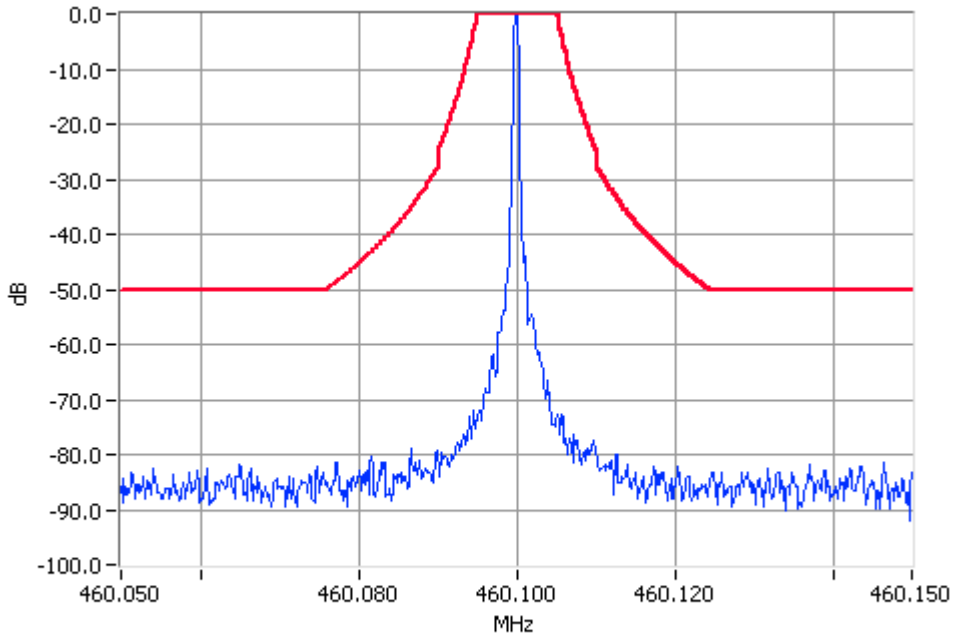

Unmodulated 460.1000MHz Mask C 10W Pass  
RBW=300Hz VBW=3000Hz

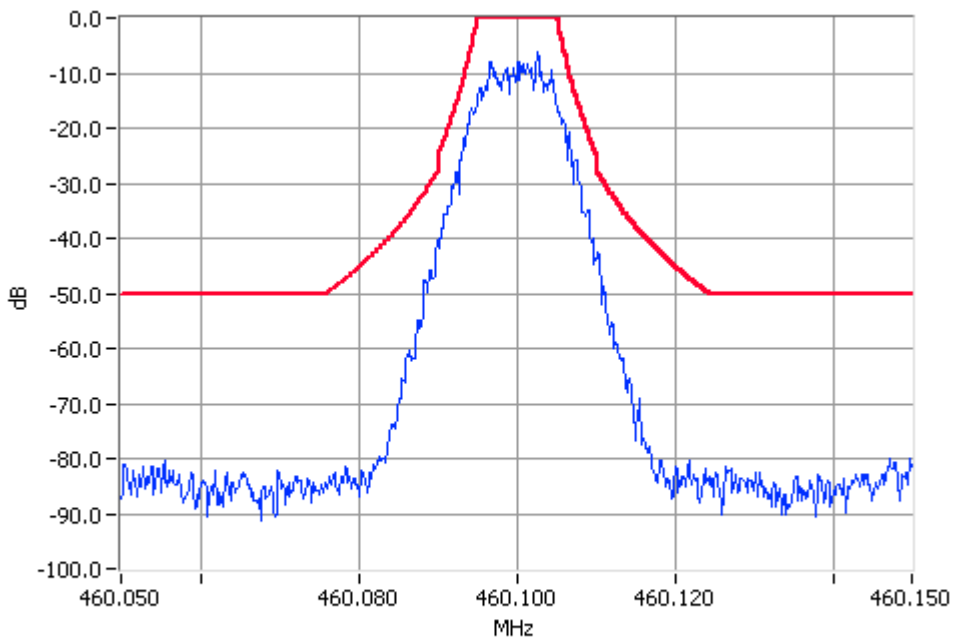

Digital Modulation 460.1000MHz Mask C 10W Pass  
RBW=300Hz VBW=3000Hz

OCCUPIED BANDWIDTH

DIGITAL - 4 Level FSK

SPECIFICATION: FCC CFR 2.1049 (c)

Tx FREQUENCY: 460.1 MHz 40W 12.5 kHz Channel Spacing

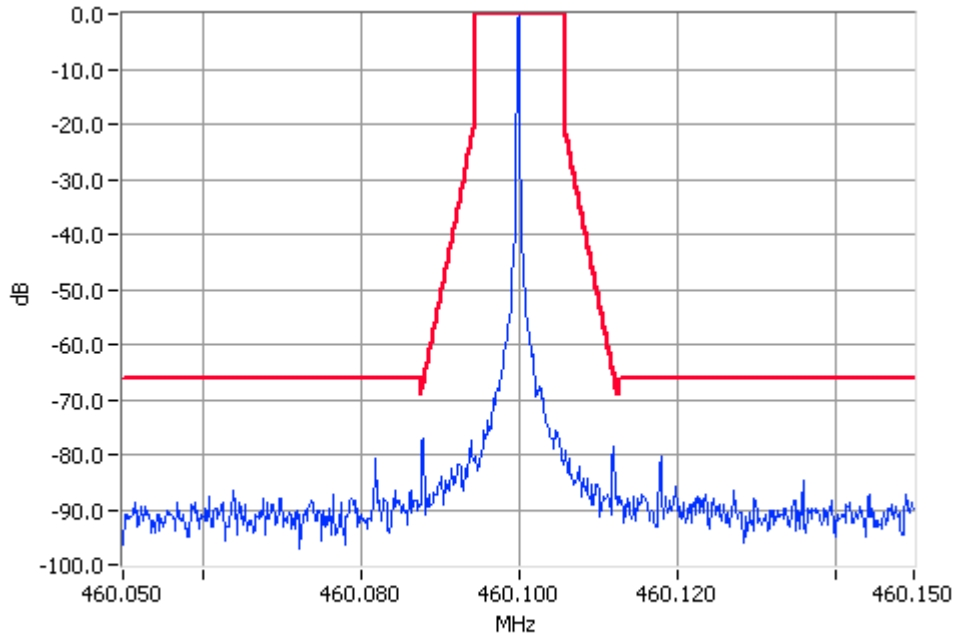

Unmodulated 460.1000MHz Mask D 40W Pass  
RBW=100Hz VBW=1000Hz

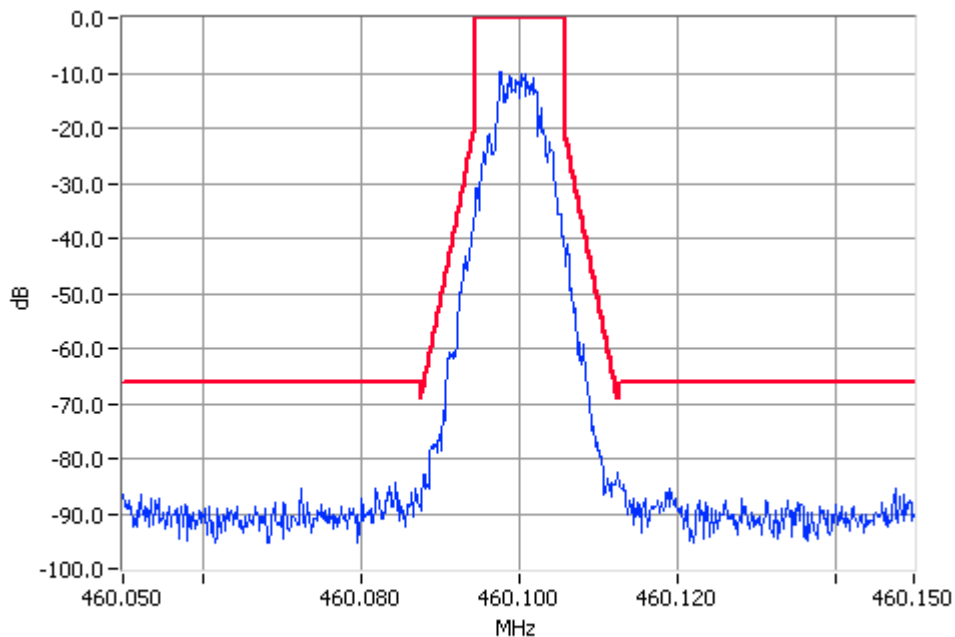

Digital Modulation 460.1000MHz Mask D 40W Pass  
RBW=100Hz VBW=1000Hz

OCCUPIED BANDWIDTH

DIGITAL - 4 Level FSK

SPECIFICATION: FCC CFR 2.1049 (c)

Tx FREQUENCY: 460.1 MHz 10W 12.5 kHz Channel Spacing

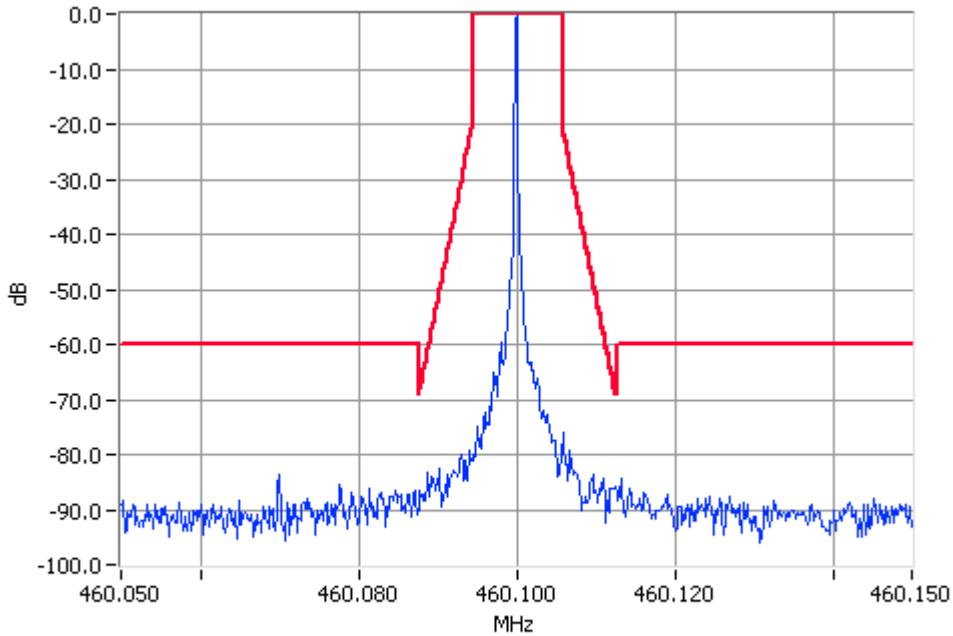

Unmodulated 460.1000MHz Mask D 10W Pass  
RBW=100Hz VBW=1000Hz

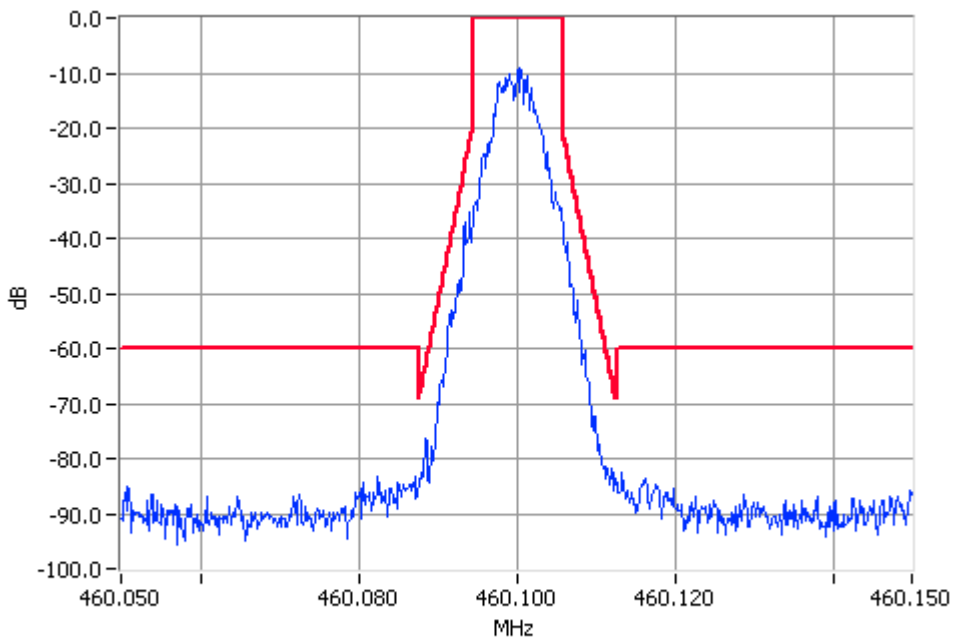

Digital Modulation 460.1000MHz Mask D 10W Pass  
RBW=100Hz VBW=1000Hz

OCCUPIED BANDWIDTH

DIGITAL - 4 Level FSK

SPECIFICATION: FCC CFR 2.1049 (c)

Tx FREQUENCY: 460.1 MHz 40W 25 kHz Channel Spacing

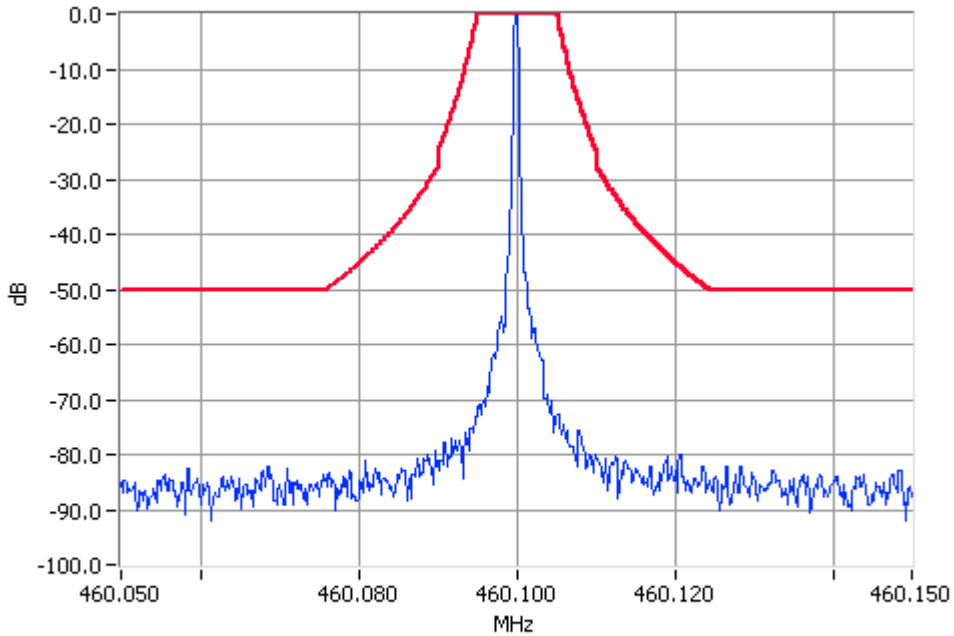

Unmodulated 460.1000MHz Mask C 40W Pass  
RBW=300Hz VBW=3000Hz

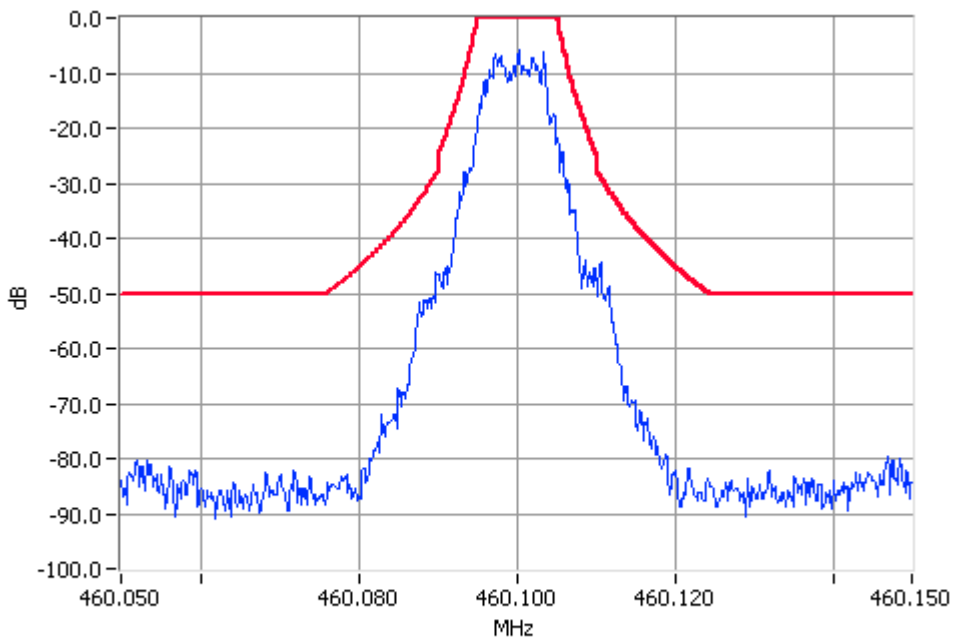

Digital Modulation 460.1000MHz Mask C 40W Pass  
RBW=300Hz VBW=3000Hz

OCCUPIED BANDWIDTH

DIGITAL - 4 Level FSK

SPECIFICATION: FCC CFR 2.1049 (c)

Tx FREQUENCY: 460.1 MHz 10W 25 kHz Channel Spacing

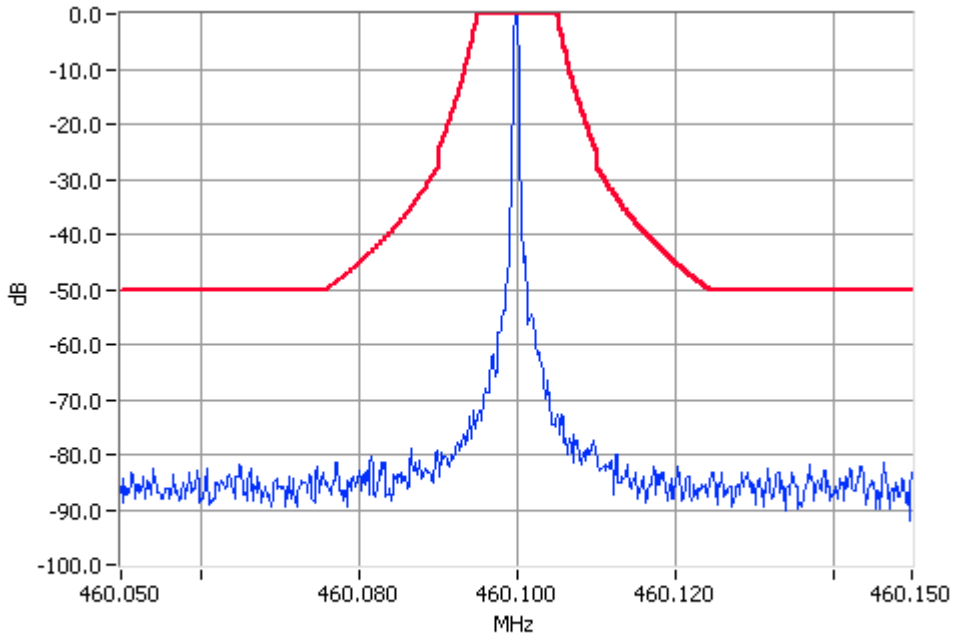

Unmodulated 460.1000MHz Mask C 10W Pass  
RBW=300Hz VBW=3000Hz

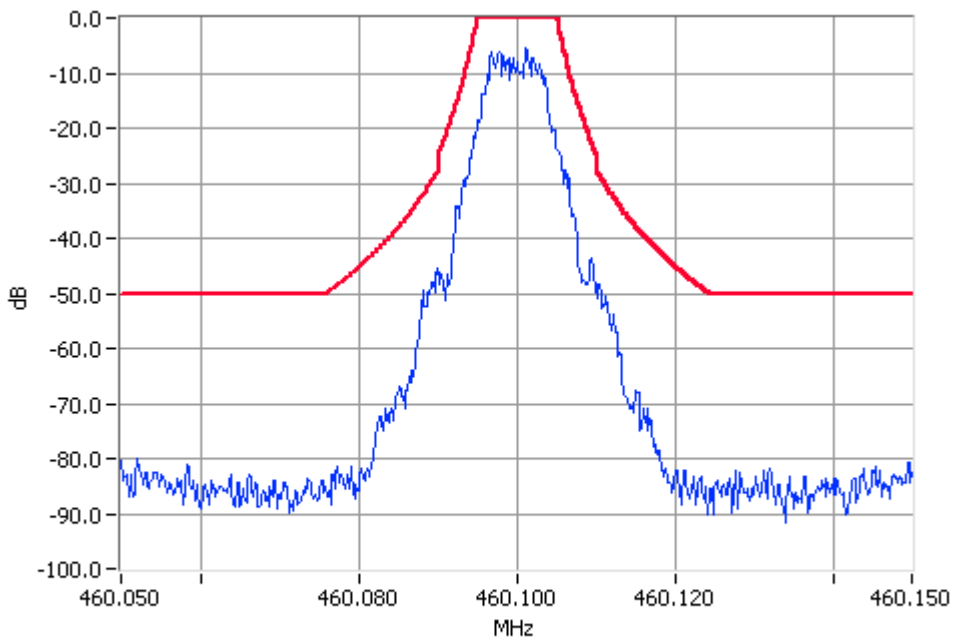

Digital Modulation 460.1000MHz Mask C 10W Pass  
RBW=300Hz VBW=3000Hz

SPURIOUS EMISSIONS (CONDUCTED)

SPECIFICATION: FCC 47 CFR 2.1051

GUIDE: TIA/EIA-603B 2.2.13

MEASUREMENT PROCEDURE:

1. Refer Appendix A for equipment set up.
2. The frequency range examined was from the lowest frequency generated within the EUT, to a frequency higher than the 10<sup>th</sup> Harmonic: 100kHz to Fc-BW  
Fc+BW to 4.5 GHz
3. A Pre-scan is performed with a resolution bandwidth of 1 kHz, and a video bandwidth of 3 kHz. If any emissions are found to be within 20dB of the limit a second measurement is made with the carrier modulated, and a resolution bandwidth of 10 kHz, and a video bandwidth of 30kHz.
4. Spurious emissions which were attenuated more than 20dB below the limit were not recorded.

MEASUREMENT RESULTS:

See the tables on the following pages for 12.5 kHz channel spacing.

LIMIT CLAUSE: FCC 47 CFR 90.210







SPURIOUS EMISSIONS (RADIATED)

SPECIFICATION: FCC 47 CFR 2.1053

GUIDE: TIA/EIA-603B 2.2.12

MEASUREMENT PROCEDURE:

1. Refer Appendix A for equipment set up..
2. The EUT was placed on a wooden turntable at a distance of three metres from the test antenna. The output terminal was connected to an RF dummy load.
3. The turntable was rotated through 360° to obtain the maximum response of each spurious emission. Valid emissions were determined by switching the EUT on and off.
4. The EUT was replaced by a signal generator and substitution antenna to make measurements by the substitution method.

MEASUREMENT RESULTS:

See the tables on the following pages

LIMIT CLAUSE: FCC 47 CFR 90.210

SPURIOUS EMISSIONS (RADIATED)





**TRANSMITTER FREQUENCY STABILITY (TEMPERATURE)**

SPECIFICATION: FCC 47 CFR 2.1055 (a) (1)

GUIDE: TIA/EIA-603B 2.2.2

MEASUREMENT PROCEDURE:

1. Refer Appendix A for equipment set up.
2. The EUT was tested for frequency error from  $-30^{\circ}\text{C}$  to  $+50^{\circ}\text{C}$  in  $10^{\circ}\text{C}$  increments
3. The frequency error was recorded in parts per million (ppm).

MEASUREMENT RESULTS:

See the plots on the following pages for 12.5 kHz & 25.0 kHz channel spacings.

LIMIT CLAUSE: FCC 47 CFR 90.213

Frequency Range: 421 MHz to 512 MHz

Channel Spacing (kHz)	Frequency Error (ppm)
12.5	2.5
25.0	5.0

TRANSMITTER FREQUENCY STABILITY (TEMPERATURE)

SPECIFICATION: FCC 47 CFR 2.1055 (a) (1)

Tx FREQUENCY: 460.1 MHz 40 W 12.5 kHz channel Spacing

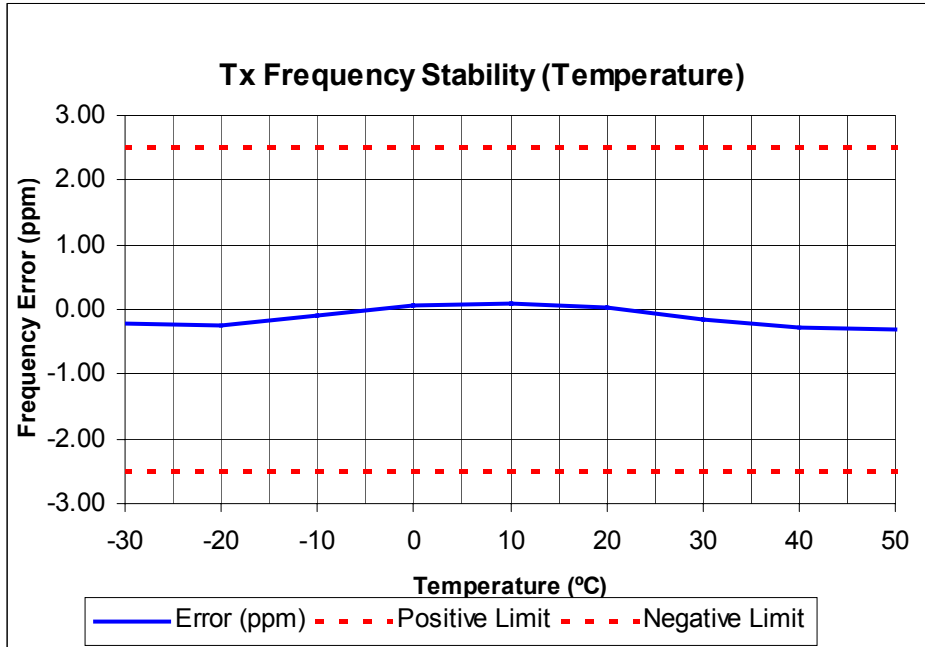

Tx FREQUENCY: 460.1 MHz 40 W 25.0 kHz channel Spacing

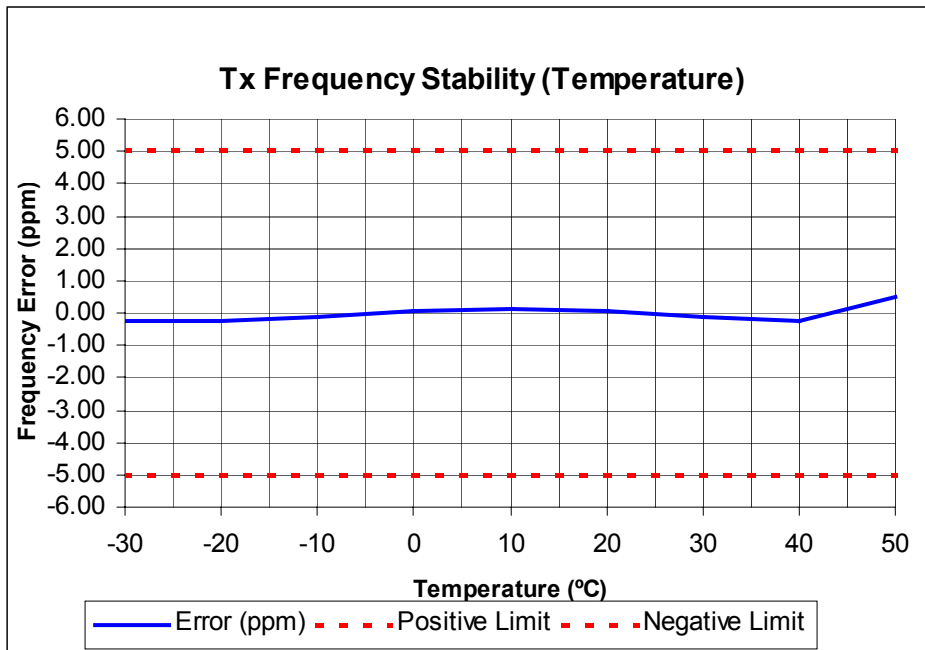

**TRANSMITTER FREQUENCY STABILITY (VOLTAGE)**

SPECIFICATION: FCC 47 CFR 2.1055 (d) (1)

GUIDE: TIA/EIA-603B 2.2.2

MEASUREMENT PROCEDURE:

1. Refer Appendix A for equipment set up.
2. The EUT was tested for frequency error at an input voltage to the radio of 85% to 115%.
3. The frequency error was recorded in parts per million (ppm).

MEASUREMENT RESULTS: Frequency Range: 421 MHz to 512 MHz

Channel Spacing (kHz)	FREQUENCY ERROR (ppm) @ 460.1 MHz		
	11.7 V DC	13.8 V DC	15.9 V DC
12.5	-0.29	-0.28	-0.30
25.0	-0.28	-0.33	-0.27

LIMIT CLAUSE: FCC 47 CFR 90.213

Channel Spacing (kHz)	Frequency Error (ppm)
12.5	2.5
25.0	5.0



TRANSIENT FREQUENCY BEHAVIOR

SPECIFICATION: FCC 47 CFR 90.214

GUIDE: TIA/EIA-603B 2.2.19

MEASUREMENT PROCEDURE:

1. Refer Appendix A for equipment set up.
2. Measurements and plots were made following the TIA/EIA procedure.

MEASUREMENT RESULTS:

See the tables and plots on the following pages for 12.5 kHz & 25.0 kHz channel spacings.

LIMIT CLAUSE: FCC 47 CFR 90.214

TRANSIENT FREQUENCY BEHAVIOUR

SPECIFICATION: FCC 47 CFR 90.214

Tx FREQUENCY: 460.1 MHz    40 W    12.5 kHz Channel Spacing

FREQUENCY	460.1 MHz @ 40 W Tx	
TRANSIENT RESPONSE PERIOD	CARRIER PEAK VARIATION FROM NORMAL	
	Key ON (kHz)	Key OFF (kHz)
$t_1$	0.9	N/A
$t_2$	0.7	N/A
$t_3$	N/A	0.4
$t_2 \rightarrow t_3$ ppm	1.2	
ERROR LIMIT ( $t_2 \rightarrow t_3$ ) ppm	2.5	

Confirm that during periods $t_1$ and $t_3$ the frequency difference does not exceed the value of one channel separation.	YES	NO
	Y	
Confirm that during the period $t_2$ the frequency difference does not exceed half a channel separation.	YES	NO
	Y	
Confirm that during the period $t_2$ to $t_3$ the frequency difference does not exceed the frequency error limit.	YES	NO
	Y	

LIMIT:

TRANSIENT PERIODS	FREQUENCY RANGE 150MHz – 174 MHz	FREQUENCY RANGE 421MHz – 512 MHz
$t_1$ (ms)	5 ms	10 ms
$t_2$ (ms)	20 ms	25 ms
$t_3$ (ms)	5 ms	10 ms

TRANSIENT FREQUENCY BEHAVIOUR

SPECIFICATION: FCC 47 CFR 90.214

Tx FREQUENCY: 460.1 MHz 40 W 12.5 kHz Channel Spacing

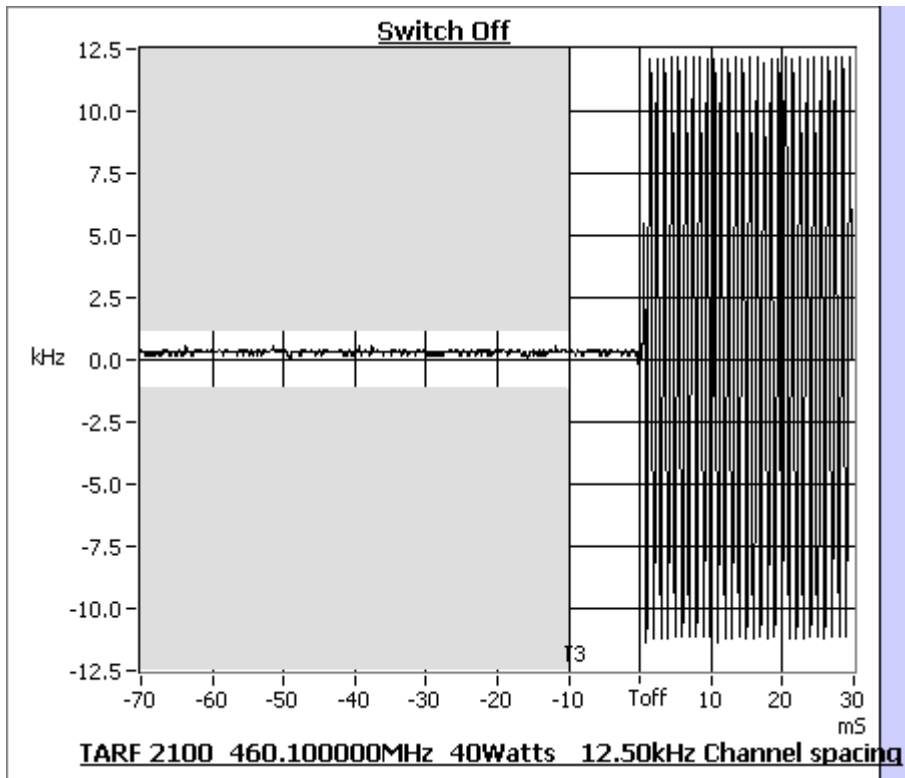
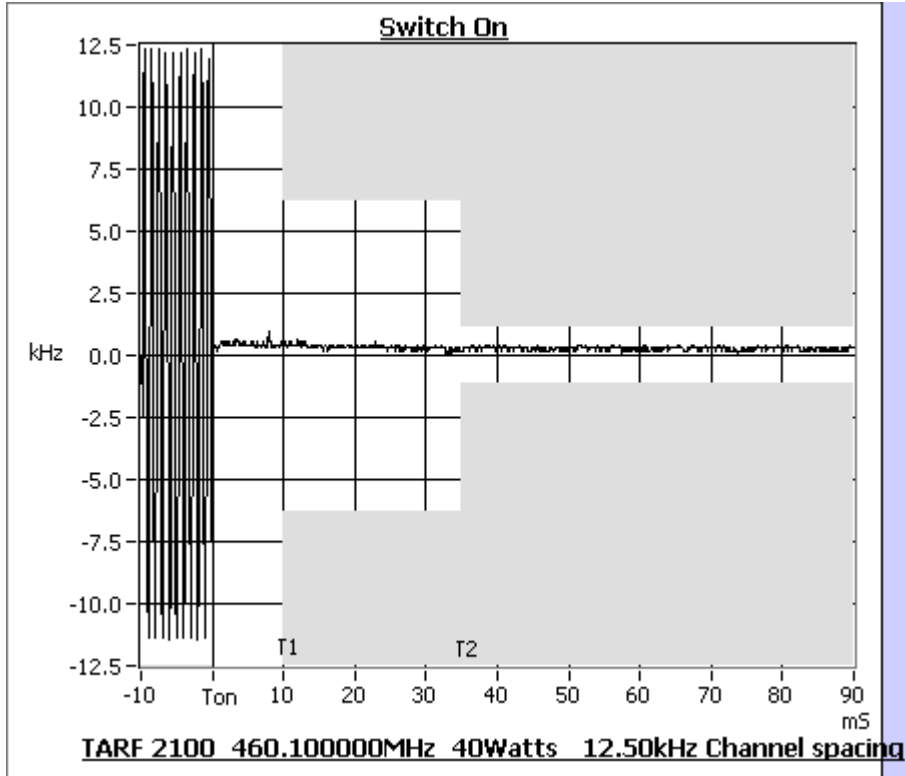

TRANSIENT FREQUENCY BEHAVIOUR

SPECIFICATION: FCC 47 CFR 90.214

Tx FREQUENCY: 460.1 MHz 40 W 25.0 kHz Channel Spacing

FREQUENCY	460.1 MHz @ 40 W Tx	
TRANSIENT RESPONSE PERIOD	CARRIER PEAK VARIATION FROM NORMAL	
	Key ON (kHz)	Key OFF (kHz)
t <sub>1</sub>	2.2	N/A
t <sub>2</sub>	0.2	N/A
t <sub>3</sub>	N/A	0.5
t <sub>2</sub> → t <sub>3</sub> ppm	-1.1	
ERROR LIMIT (t <sub>2</sub> → t <sub>3</sub> ) ppm	5.0	

Confirm that during periods t <sub>1</sub> and t <sub>3</sub> the frequency difference does not exceed the value of one channel separation.	YES	NO
	Y	
Confirm that during the period t <sub>2</sub> the frequency difference does not exceed half a channel separation.	YES	NO
	Y	
Confirm that during the period t <sub>2</sub> to t <sub>3</sub> the frequency difference does not exceed the frequency error limit.	YES	NO
	Y	

LIMIT:

TRANSIENT PERIODS	FREQUENCY RANGE 150MHz – 174 MHz	FREQUENCY RANGE 421MHz – 512 MHz
t <sub>1</sub> (ms)	5 ms	10 ms
t <sub>2</sub> (ms)	20 ms	25 ms
t <sub>3</sub> (ms)	5 ms	10 ms

TRANSIENT FREQUENCY BEHAVIOUR

SPECIFICATION: FCC 47 CFR 90.214

Tx FREQUENCY: 460.1 MHz 40 W 25.0 kHz Channel Spacing

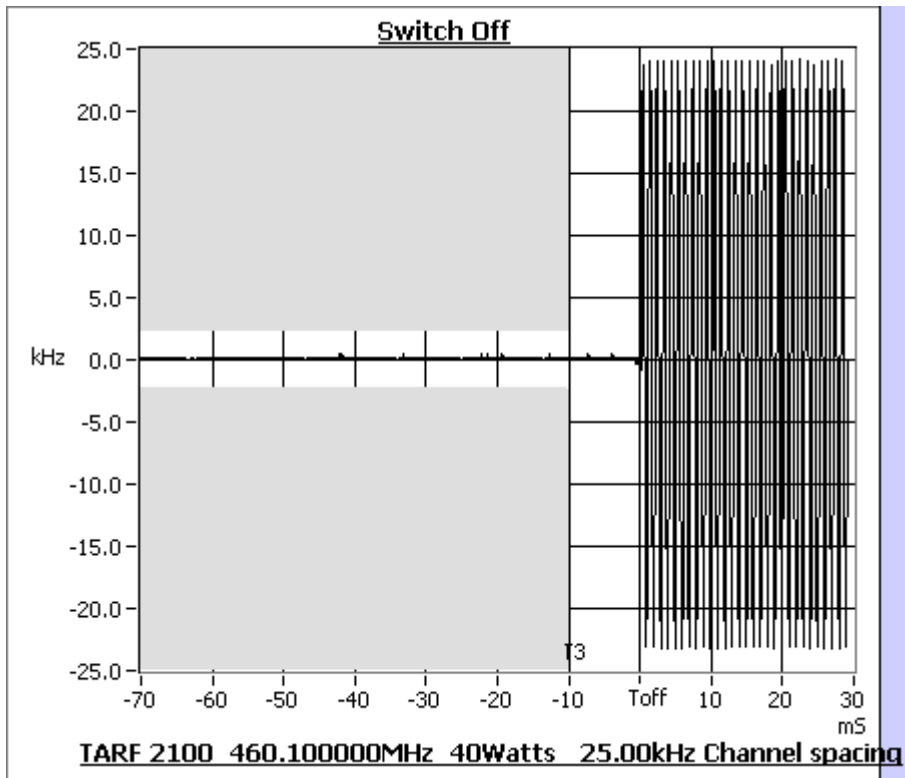
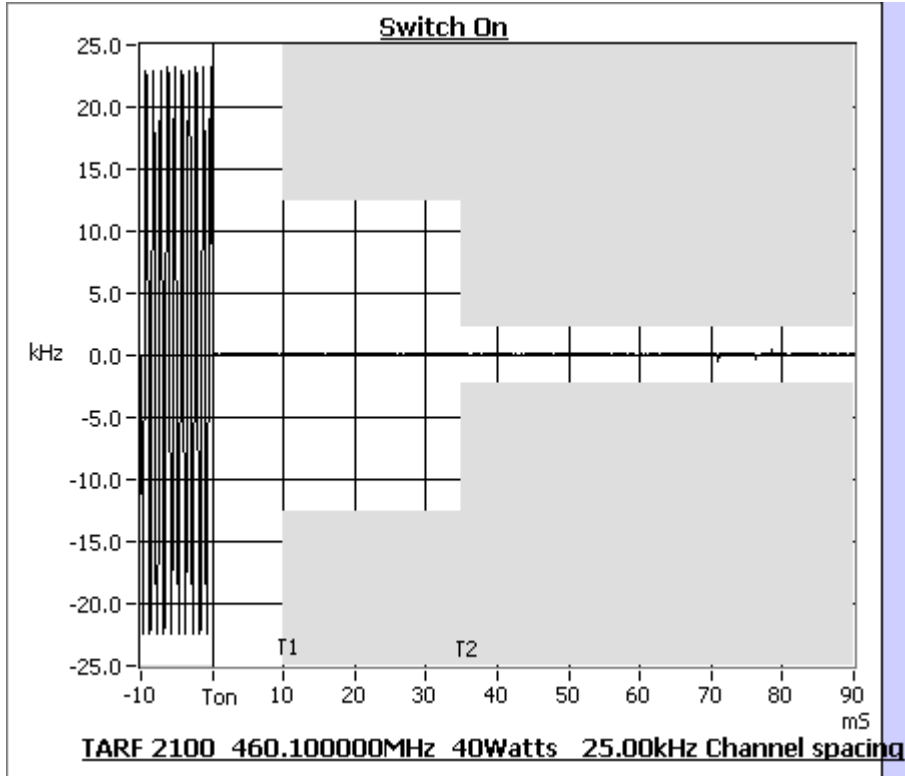

## TEST EQUIPMENT USED

No#	Equipment	Manufacturer	Model No	Serial No#	Tait ID	Cal Due
2	Signal Generator	Hewlett Packard	HP8648A	3430U00344	E3579	15-Oct-04
5	Signal Generator	Rohde & Schwarz	SMY01 1062.5502.11	841736/019	E3553	29-Oct-04
14	Power Head	Hewlett Packard	HP11722A	2320A00688	E3307	15-Oct-04
21	Power Supply	Rohde & Schwarz	NGS M32/10 192.0810.31	Fnr 434	E3556	14-Jun-05
22	Oscilloscope	Tektronics	TDS340	B013611	E3585	25-Nov-04
42	Reference Horn Antenna	Emco	DRG3115	9512-4638	E3560	27-Sep-06
43	Horn Antenna	Emco	DRG3115		E3076	27-Sep-06
60	RF Attenuator 250W	Weinschel	45-30-34	JW663	E3386	09-Aug-05
62	RF Attenuator 150W	Weinschel	57-10-34	LB590	E3674	20-Jul-05
65	RF Attenuator 50W	Weinschel	24-20-44	AW1266	E3562	28-Jun-05
82	3m Coax Cable (BLUE)	Suhner	Sucoflex 104A	25033/4A	E3694	30-Oct-04
83	1m Coax Cable (BLUE)	Suhner	Sucoflex 104A	25006/4A	E3693	30-Oct-04
84	1m Coax Cable (BLUE)	Suhner	Sucoflex 104A	25005/4A	E3692	15-Jul-05
85	1m Coax Cable (BLUE)	Suhner	Sucoflex 104A	25004/4A	E3691	15-Jul-05
86	1m Coax Cable (BLUE)	Suhner	Sucoflex 104A	25003/4A	E3690	13-Aug-05
87	Audio Analyser	Hewlett Packard	HP8903B	2818A04275	E3710	25-Nov-04
111	Modulation Analyser	Hewlett Packard	HP8901B (Opt 002)	3704A05837	E3786	15-Oct-04
114	Signal Generator	Rohde & Schwarz	SML03 1090.3000.13		E4050	28-Nov-04
117	RF Attenuator	Weinschel	Model 1	BL9950	E4080	17-May-05
119	RF Attenuator 150W Treva	Weinschel	40-20-23	MF817	E4082	17-May-05
121	RF Splitter Combiner	Minicircuits	ZFSC-4-1	-	E4084	17-May-05
123	Spectrum Analyser	Agilent	E4445A	MY42510072	E4139	23-Apr-05
135	Attenuator	Weinschel	67-30-33	BR0531	E4280	13-Aug-05

## APPENDIX A

### TEST SETUP DETAILS

Test set up for Spurious Emissions (Radiated)

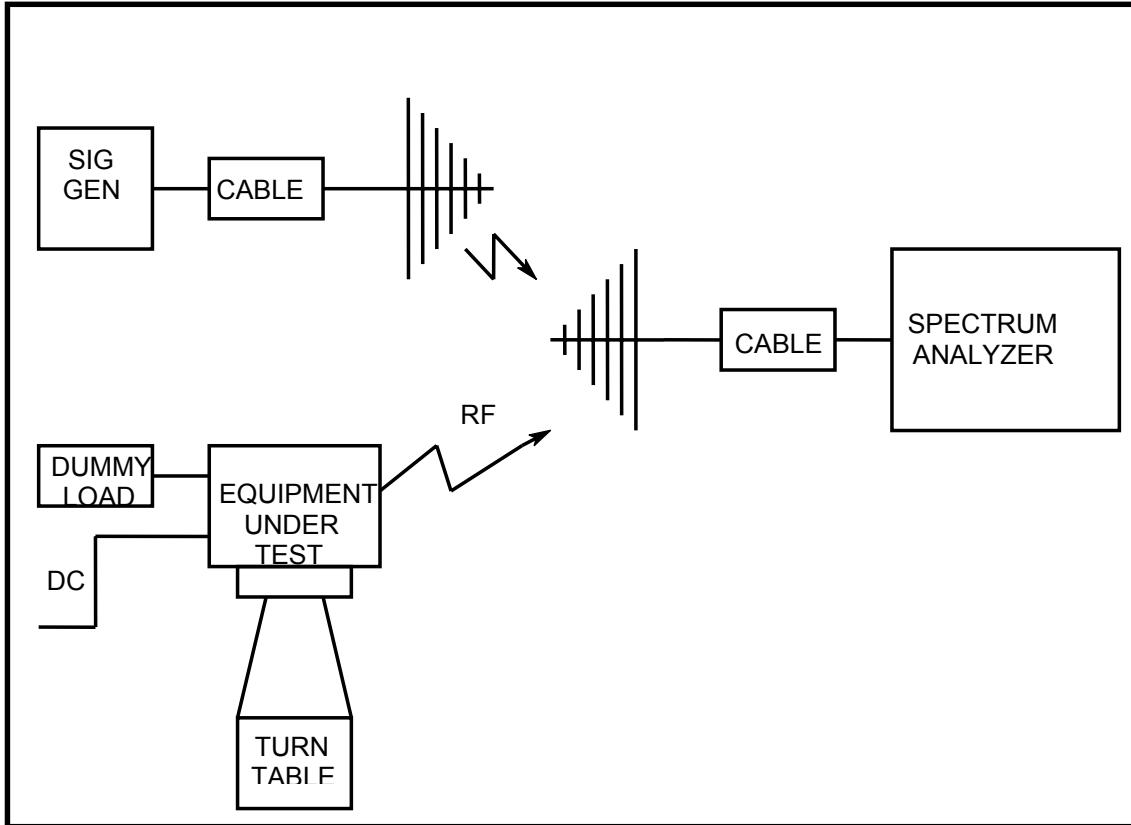

All other testing is performed using the Teltest Radio **EVAL**uation system (TREVA), which is configured as shown below. The Spectrum Analyser is connected to the EUT via the attenuator network for Conducted Emissions testing, and Occupied Bandwidth.

