

Directive 1999/5/EC Declaration of Conformity

da Dansk

Undertegnede Tait Electronics Ltd erklærer herved, at følgende udstyr TMAB1C, TMAD1C & TMAH5C overholder de væsentlige krav og øvrige relevante krav i direktiv 1999/5/EF.

Se endvidere: <http://eudocs.taitworld.com/>

de Deutsch

Hiermit erkläre Tait Electronics Ltd die Übereinstimmung des Gerätes TMAB1C, TMAD1C & TMAH5C mit den grundlegenden Anforderungen und den anderen relevanten Festlegungen der Richtlinie 1999/5/EG.

Siehe auch: <http://eudocs.taitworld.com/>

el Ελληνικός

Με την παρουσία Tait Electronics Ltd δηλώνει ότι TMAB1C, TMAD1C & TMAH5C συμμορφώνεται προς τις ουσιαστικές απαιτήσεις και τις λοιπές σχετικές διατάξεις της οδηγίας 1999/5/EK. βλέπε και: <http://eudocs.taitworld.com/>

en English

Tait Electronics Ltd declares that this TMAB1C, TMAD1C & TMAH5C complies with the essential requirements and other relevant provisions of Directive 1999/5/EC. See also: <http://eudocs.taitworld.com/>

es Español

Por medio de la presente Tait Electronics Ltd declara que el TMAB1C, TMAD1C & TMAH5C cumple con los requisitos esenciales y cualesquiera otras disposiciones aplicables o exigibles de la Directiva 1999/5/CE. Vea también: <http://eudocs.taitworld.com/>

fi Suomi

Tait Electronics Ltd vakuuttaa täten että TMAB1C, TMAD1C & TMAH5C tyyppinen laite on direktiivin 1999/5/EY oleellisten vaatimusten ja sitä koskevien direktiivin

muiden ehtojen mukainen.

Katso: <http://eudocs.taitworld.com/>

fr Français

Par la présente, Tait Electronics Ltd déclare que l'appareil TMAB1C, TMAD1C & TMAH5C est conforme aux exigences essentielles et aux autres dispositions pertinentes de la directive 1999/5/CE.

Voir aussi: <http://eudocs.taitworld.com/>

it Italiano

Con la presente Tait Electronics Ltd dichiara che questo TMAB1C, TMAD1C & TMAH5C è conforme ai requisiti essenziali ed alle altre disposizioni pertinenti stabilite dalla direttiva 1999/5/CE.

Vedi anche: <http://eudocs.taitworld.com/>

nl Nederlands

Hierbij verklaart Tait Electronics Ltd dat het toestel TMAB1C, TMAD1C & TMAH5C in overeenstemming is met de essentiële eisen en de andere relevante bepalingen van richtlijn 1999/5/EG.

Zie ook: <http://eudocs.taitworld.com/>

pt Português

Tait Electronics Ltd declara que este TMAB1C, TMAD1C & TMAH5C está conforme com os requisitos essenciais e outras provisões da Directiva 1999/5/CE.

Veja também: <http://eudocs.taitworld.com/>

sv Svensk

Härmed intygar Tait Electronics Ltd att denna TMAB1C, TMAD1C & TMAH5C står i överensstämmelse med de väsentliga egenskapskrav och övriga relevanta bestämmelser som framgår av direktiv 1999/5/EG.

Se även: <http://eudocs.taitworld.com/>

About this guide

This user's guide provides information about TM8200 radios and is divided into two parts.

- Part 1 explains how the TM8250 radio with the graphical display operates.
- Part 2 outlines the installation procedure for all TM8200 radios.

If you need further assistance or your radio does not operate as you expect, contact your radio provider.

Important safety information

This user's guide also contains important safety and compliance information about using and installing TM8200 radios. Refer to [page 11](#) for user safety and compliance instructions and [page 42](#) for installation safety instructions.

Safety warnings used in this guide

Within this guide, the following conventions are used to alert you to important safety information:



Warning: There is a potential risk of death or serious injury.



Caution: There is the risk of minor or moderate injury to people.

Caution: "Caution" is used without the safety alert symbol when there is a risk of equipment damage or malfunction.

Feedback about this guide

If you have any enquiries regarding this guide, or any comments, suggestions and notifications of errors, please contact Technical Support at support@taitworld.com.

Changes to this guide

In the interests of improving the performance, reliability or servicing of the equipment, Tait Electronics Ltd reserves the right to update both the equipment or this user's guide, without prior notice.



Website: For contact details and technical assistance, go to <http://www.taitworld.com/>, and <http://support.taitworld.com/>.

Copyright information

All information contained in this guide is the property of Tait Electronics Ltd. All rights are reserved. These guides may not, in whole or in part, be copied, photocopied, reproduced, translated, stored, or reduced to any electronic medium or machine-readable form, without prior written permission from Tait Electronics Ltd. All trade names referenced are the service mark, trademark, or registered trademark of the respective manufacturers.

Disclaimer

There are no warranties extended or granted by this guide. Tait Electronics Ltd accepts no responsibility for damage arising from use of the information contained in the guide or of the equipment and software it describes. It is the responsibility of the user to ensure that use of such information, equipment and software complies with the laws, rules and regulations of the applicable jurisdictions.

Your radio's settings

Use the following table to list your radio's programmed settings.

Function key settings

F1 _____

F2 _____

F3 _____

F4 _____

quick access
menus:





Frequently used channels and groups

ID	Description	ID	Description
_____	_____	_____	_____
_____	_____	_____	_____
_____	_____	_____	_____
_____	_____	_____	_____
_____	_____	_____	_____
_____	_____	_____	_____
_____	_____	_____	_____
_____	_____	_____	_____
_____	_____	_____	_____
_____	_____	_____	_____



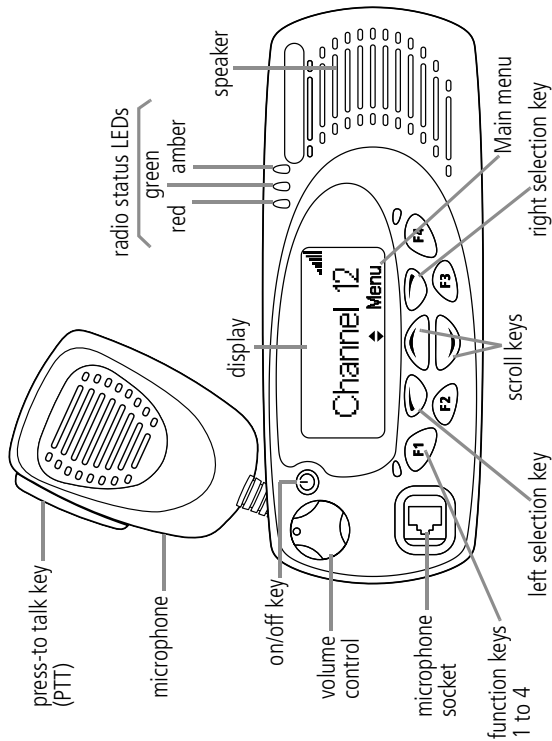



Navigating your radio's menus

Main menu: conventional mode

Note: Only features programmed for your radio will be available.

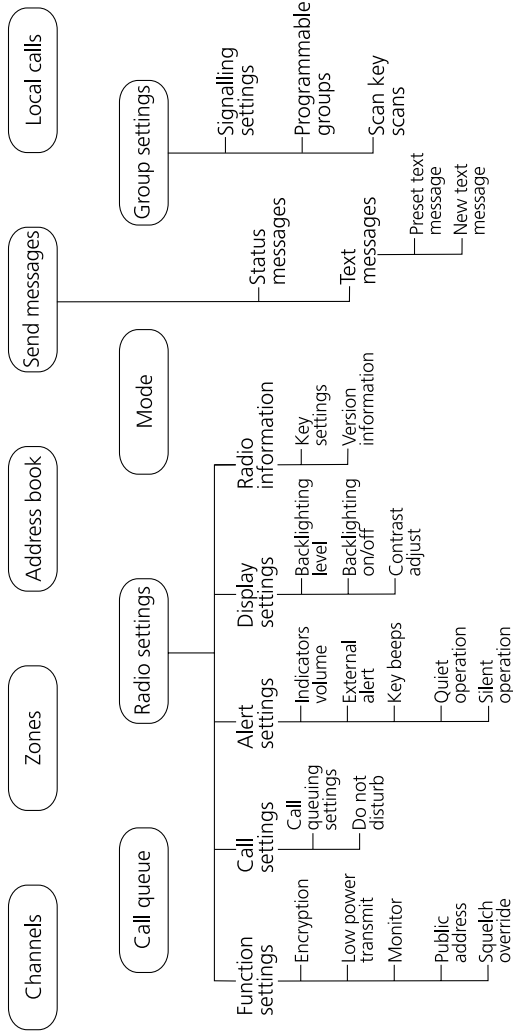

Part 1: Radio operation

About this guide	3
Important safety information	3
Safety warnings used in this guide	3
Feedback about this guide	3
Changes to this guide	4
Copyright information	4
Disclaimer	4
Safety and compliance warnings	11
Radio frequency exposure information	11
Radio frequency emissions limits in the USA	12
Health, safety and electromagnetic compatibility in Europe	13
Electromagnetic compatibility in European vehicles	13
EN 60950 requirements (25 watt radios)	14
Safe radio operation	14
High radio surface temperatures	14
Radio protection when changing the vehicle battery	14
Getting started	15
Radio controls	15
Radio indicators	17
Navigating your radio's menus	20
Viewing your radio's function key settings	21
Basic operation	22
Turning the radio on and off	22
Entering your personal identification number	22
Adjusting the speaker volume	23
Turning on control-head backlighting	23
Operating in conventional mode	25
Selecting a channel or scanning group	25
Selecting a zone	27
Checking that a channel is clear	28
Making a call	30
Making a local call	31

Making a call using your address book	32
Making an emergency call	34
Receiving a call	34
Hearing faint and noisy signals	34
Troubleshooting	37
When your radio won't turn on	37
Removing the microphone	37
Removing the radio from the vehicle	38
Describing the radio's audible tones	38
Notes	40

Safety and compliance warnings

Radio frequency exposure information

For your own safety and to ensure you comply with the Federal Communication Commission's (FCC) radio frequency (RF) exposure guidelines, please read the following information before using this radio.

Using this radio

You should use this radio only for work-related purposes (it is not authorized for any other use) and if you are fully aware of, and can exercise control over, your exposure to RF energy. To prevent exceeding FCC RF exposure limits, you must control the amount and duration of RF that you and other people are exposed to.

It is also important that you:

- Do not remove the RF exposure label from the radio.
- Ensure this RF exposure information accompanies the radio when it is transferred to other users.
- Do not use the radio if you do not adhere to the guidelines on controlling your exposure to RF.

Controlling your exposure to RF energy

This radio emits RF energy or radio waves primarily when calls are made. RF is a form of electromagnetic energy (as is sunlight), and there are recommended levels of maximum RF exposure.

To control your exposure to RF and comply with the maximum exposure limits for occupational/controlled environments, follow these guidelines:

- Do not talk (transmit) on the radio more than the rated transmit duty cycle. This is important because the radio radiates more energy when it is transmitting than when it is receiving.

- While you are transmitting (talking or sending data) on the radio, you must ensure that there is always a distance of 0.9m (35 inches) between people and the antenna. This is the minimum safe distance.
- Use the radio only with Tait-approved antennas and attachments, and make only authorized modifications to the antenna otherwise you could damage the radio and violate FCC regulations.



Website: For more information on what RF energy is and how to control your exposure to it, go to <http://www.fcc.gov/oet/rfsafety/rf-faqs.html>.

Compliance with RF energy exposure standards

This two-way radio complies with these RF energy exposure standards and guidelines:

- United States Federal Communications Commission, Code of Federal Regulations; 47 CFR 1.1307, 1.1310 and 2.1091
- American National Standards Institute (ANSI) / Institute of Electrical and Electronic Engineers (IEEE) C95. 1-1992
- Institute of Electrical and Electronic Engineers (IEEE) C95.1-1999 Edition.

This radio complies with the IEEE (FCC) and ICNIRP exposure limits for occupational/controlled RF exposure environments at operating duty factors of up to 50% talk to 50% listen.

Radio frequency emissions limits in the USA

Part 15 of the FCC Rules imposes RF emission limits on electronic equipment to prevent interference to reception of broadcast services.

This device complies with Part 15 of the FCC Rules. Operation is subject to the condition that this device does not cause harmful interference.

Note: Changes or modifications to this device that are not expressly approved by Tait Electronics Ltd may make its use illegal.

Health, safety and electromagnetic compatibility in Europe

In the European Community, radio and telecommunications equipment is regulated by Directive 1999/5/EC, also known as the Radio and Telecommunications Terminal Equipment (R&TTE) directive. The requirements of this directive include protection of health and safety of users, as well as electromagnetic compatibility.

Intended purpose of product

This product is an FM radio transceiver. Its intended purpose is for radio communication in Private Mobile Radio (PMR) services or Public Access Mobile Radio (PAMR) services.

Note: This product can be programmed for frequencies or emissions that may make its use illegal. Where applicable, a license must be obtained before this product is used. All license requirements must be observed. Limitations may apply to transmitter power, operating frequency, channel spacing, and emission.

Declaration of conformity

Brief Declarations of Conformity appear on [page 1](#).



Website: To download the formal declaration of conformity, go to <http://eudocs.taitworld.com/>.

A signed and dated paper copy of the declaration of conformity can be obtained from Tait Europe Ltd.

Electromagnetic compatibility in European vehicles

In the European Community, radio equipment fitted to automotive vehicles is regulated by Directive 72/245/EEC, as amended by 95/54/EC. The requirements of this directive

cover the electromagnetic compatibility of electrical or electronic equipment fitted to automotive vehicles.

Note: To meet the requirements of Directive 72/245/EEC (as amended by 95/54/EC) installation of this product in a vehicle must be performed according to the instructions provided, and any guidelines of the vehicle manufacturer.

EN 60950 requirements (25 watt radios)

This radio complies with the European Union standard EN 60950 when operated up to the rated 33% duty cycle of two minutes transmit and four minutes receive, and with ambient temperatures of 30°C or lower.



Caution: Operation outside these limits may cause the external temperature of the radio to rise higher than this standard permits.

Safe radio operation



Warning: Observe the following safe operating practices:

- Switch the radio off at petrol filling stations or near flammable liquids or gases.
- Switch the radio off in the vicinity of explosive devices and blasting zones.
- Using a handheld microphone or a radio while driving a vehicle may violate the laws and legislation that apply in your country or state. Please check the regulations in your area.

High radio surface temperatures

The bottom surface of the radio and the heatsink fins can become hot during prolonged operation. Do not touch these parts of the radio.

Radio protection when changing the vehicle battery

Always remove the fuses from the radio power cable before charging the vehicle battery, connecting a second battery or using power from another vehicle (e.g. when jump-starting the vehicle).

Getting started

This section provides a brief description of your radio's controls and indicators and explains how to use the radio's menus.

The following topics are covered in this section:

- [radio controls](#)
- [radio indicators](#)
- [navigating your radio's menus](#)
- [viewing your radio's function key settings](#).







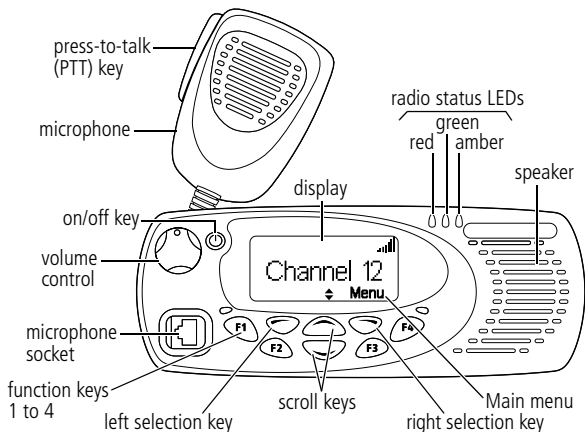

Radio controls

The radio controls are the PTT key, volume control, on/off key, scroll keys, selection keys and function keys. Some keys may have functions assigned to both short and long key presses:

- a short key press is less than one second, and
- a long key press is more than one second.

The radio controls and their functions are summarized in the following diagram.



Symbol	Name	Function
	PTT key	press and hold to transmit and release to listen
	volume control	rotate to change the speaker volume
	on/off key	turn the radio on or off with a long press
	left selection key	action determined by the text above the left selection key
	right selection key	action determined by the text above the right selection key
	scroll keys	scroll up and down through a list of menu options or scroll left and right in messages, or access your Quick Access menu
	Tip: If you press and hold the scroll keys, the scroll speed increases.	
 	function keys 1, 2, 3 and 4	function keys with programmed options
 		

Radio indicators

The radio display, LED indicators and the radio's audible tones all combine to give you information about the state of your radio.

The most common operation of the radio display and indicators is described in the following sections.

Note: The way these indicators behave may be affected by the way your radio is programmed.





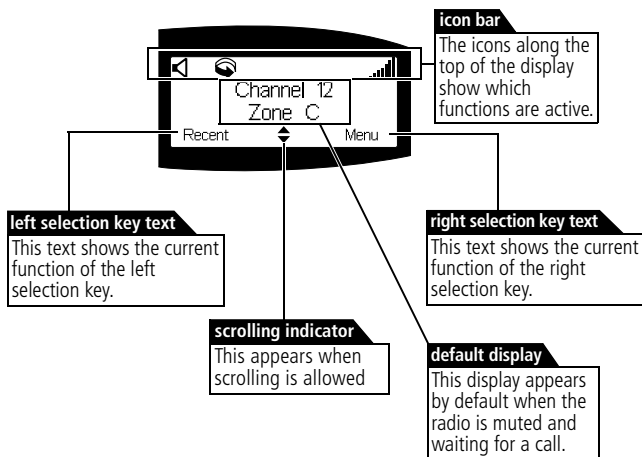

Radio display

The messages and icons you see in your display depend on the radio's current operating mode, and the way the radio was programmed.

The following diagram shows a typical display in conventional mode, explaining some of the display information available.



Radio display icons

Icon	Meaning
	received signal strength indicator (RSSI) (green LED glowing): the more bars on this indicator, the stronger the signal being received by your radio. transmit power level (red LED glowing): the more bars on the indicator, the higher the power level of your transmission
	MPT network: your radio has access to an MPT network flashing: your radio is attempting to access an MPT network
	transmit: your radio is transmitting
	low-power transmit: your radio is transmitting on low power
	scanning: your radio is monitoring a group of channels for activity
	monitor or squelch override: monitor or squelch override is active

LED indicators

LED	Meaning
red (transmit)	glowing: your radio is transmitting flashing: your transmit timer is about to expire, or your radio is stunned, or your call time is about to expire (MPT trunked mode)
green (receive)	glowing: you are receiving flashing: you have received a call
amber (scanning or network)	glowing: your radio is scanning a group of channels for activity (conventional mode) or network service is available (MPT trunked mode) flashing: your radio has detected activity on a channel, and has halted on this channel (conventional mode) flashing fast: there is no network service available (MPT trunked mode)

Audible tones

Note: If quiet or silent mode has been turned on, you will not hear any audible tones.

For a description of other tones you may hear, see [“Describing the radio’s audible tones” on page 38.](#)



Tone type Meaning

one short beep	valid key press: the action you have attempted is permitted, or function activated: a function key has been pressed and that function has been activated
one long, low-pitched beep	invalid key press: the action you have attempted is not permitted, or transmission inhibited: you have attempted to transmit but for some reason transmission is not permitted at this time
one short, low-pitched beep	function deactivated: a function key has been pressed and the corresponding function has been turned off



Navigating your radio's menus

Your radio has a number of menus available, each containing lists or submenus. The menus available will depend on the way your radio is programmed.

Using the Main menu

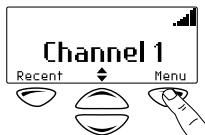
Whenever **Menu** appears above the right selection key , you are able to open the Main menu by pressing .





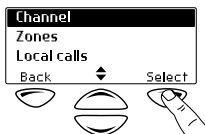

Use the scroll keys  or  to move through the list of menus.

When the menu you want is highlighted, press **Select** to open the menu you have chosen.



Using the scroll key Quick Access menu

Your radio may be programmed so that your scroll keys act as a shortcut to a frequently used menu. To go to this Quick Access menu, press a scroll key  or , and the Quick Access menu appears.

For example, if your Channels menu is your Quick Access menu, press a scroll key  or  to go directly to the Channels menu.

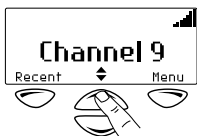

The Channels menu, with a list of your available channels and scan groups, is now displayed.

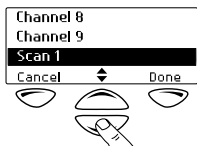

Using the left selection key Quick Access menu

Your radio may be programmed so that your left selection key acts as a shortcut to another frequently used menu. If this menu has been programmed, the text for left selection key corresponds to the menu.



To use this Quick Access menu, press your left selection key , and the associated menu appears.

Viewing your radio's function key settings

Your radio's four function keys can have programmed functions assigned to each key. Some keys may have a function associated with both a short key press and a long key press. To check the functions assigned to your radio's function keys, you can use the Main menu.

- 1 Select **Main**>**Radio Information**>**Key Settings**.

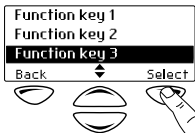

- 2 In the Key Settings menu, scroll through the list of function keys.
- 3 Press **Select** to view details of the function associated with a particular function key.

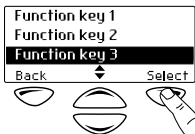

The example shown is for a function key programmed to turn control-head backlighting on and off.

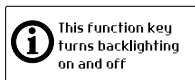

Basic operation

This section describes the basic operations of your radio.

The following topics are covered in this section:

- [turning the radio on and off](#)
- [entering your personal identification number](#)
- [adjusting the speaker volume](#)
- [turning on control-head backlighting.](#)

Turning the radio on and off

Give a long press of the on/off key  to turn the radio either on or off.

When the radio is first turned on, the red, green and amber LEDs flash briefly and the radio gives two short beeps. A brief message may appear on the display.

Entering your personal identification number

You may need to enter a personal identification number (PIN) before you can use your radio. If the message **Enter PIN:** appears, enter your assigned PIN.

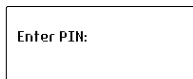

Once you have entered your PIN correctly, the **PIN accepted** message appears and normal operation is now possible.

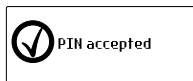

If you do not know your PIN or you receive an incorrect PIN message, consult your radio provider or administrator.

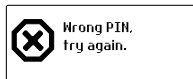

Adjusting the speaker volume

Rotate the volume control clockwise to increase the speaker volume and counterclockwise to decrease the volume. The volume control also changes the volume level of the radio's audible indicators.

Note: Your radio may be programmed with a minimum volume level.

Turning on control-head backlighting

The radio's display and keypad light up when backlighting is on. This normally only happens when a key is pressed or a call is received. There are two ways you may be able to change the way backlighting operates on your radio:

- turn on backlighting momentarily, using a programmed function key, or
- toggle backlighting between on and off, using either a programmed function key or the Main menu.

Turning backlighting on momentarily by using a function key

You may be able to use a programmed function key to turn backlighting on momentarily. Backlighting remains on for a few seconds and then turns off.

Alternatively, the function key may be programmed so that:

- a short key press turns backlighting on momentarily, and
- a long key press turns backlighting on, and it remains on until there is a further long key press.

Toggling backlighting on and off by using a function key

The function key programmed for backlighting toggles the backlighting between on and off. When backlighting is turned on, it remains on until the function key is pressed again.

Toggle backlighting on and off by using the Main menu

When backlighting is turned on using the menu, it remains on until the setting is changed to off, regardless of radio activity.

- 1 Select Menu > Radio Settings > Display Settings > Backlighting.

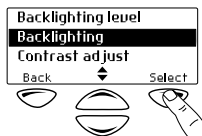

- 2 In the Backlighting menu, choose either **On** or **Off**.

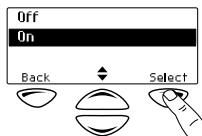

- 3 Press **Select**.

Operating in conventional mode

The following topics are covered in this section:

- selecting a channel or scanning group
- selecting a zone
- checking that a channel is clear
- making a call
- making a local call
- making a call using your address book
- making an emergency call
- receiving a call
- hearing faint and noisy signals.

Selecting a channel or scanning group

To select a channel or scanning group you may be able to either:

- use a programmed function key,
- use the Main menu, or
- use your quick access menu.

Selecting a channel by using a programmed function key

Press the function key programmed for preset channel.

The programmed channel is now shown in the display.



Selecting a scan group by using a programmed function key

Press the function key programmed for group scanning.

The programmed scan group is now shown in the display, the amber LED glows and the scanning icon  appears in the icon bar.



Selecting a channel or scan group by using the Main menu

- 1 Select Menu > Channels.

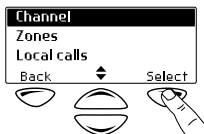

- 2 In the Channels menu, scroll through the list of channels and scan groups until the channel or scan group you want appears.

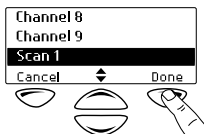

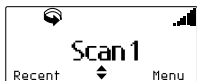

- 3 Press **Done**.

If you have selected a scan group, the amber LED glows and the scanning icon  appears in the icon bar.



Selecting a channel or scan group by using your Quick Access menu

- 1 Press one of the scroll keys  or  to open the Channels menu.



- 2 Scroll through the list of channels and scan groups until the channel or scan group you want appears.

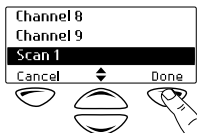

- 3 Press **Done**.

If you have selected a scan group, the amber LED glows and the scanning icon  appears in the icon bar.

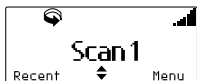

Selecting a zone

A zone is a collection of channels. To select a zone you may be able to either:

- use the Main menu, or
- use your Quick Access menu.

Selecting a zone by using the Main menu

- 1 Select Menu>Zones.

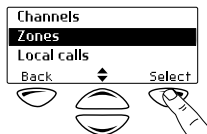

- 2 In the Zones menu, scroll through the list of zones until the one you want appears.

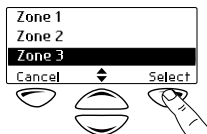



- 3 Press **Select**.

Your radio may now display the zone information in two ways:

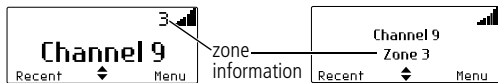
- the zone icon appears in the icon bar
- the zone indication appears below the channel information.



Selecting a zone by using your Quick Access menu

- 1 Press one of the scroll keys  or  to open the Zones menu.

Alternatively, the left selection key may be programmed as your Quick Access menu. In this case, press the left selection key  to access the Zones menu.

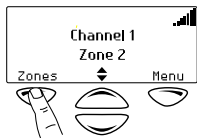

- 2 Scroll through the list of zones until the zone you want appears.

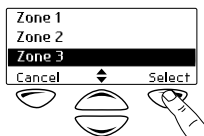

- 3 Press **Select**.

Your radio may now display the zone information in two ways:

- the zone icon appears in the icon bar
- the zone indication appears below the channel information.

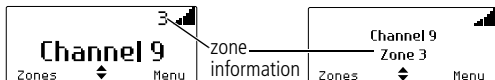

Checking that a channel is clear

You or your user group may be segregated from other user groups by special signalling. If an incoming call carries the special signalling tones specific to you or your user group, your radio's signalling mute opens and you can hear the call. These tones may not be audible.

The monitor function allows you to override any special signalling on a channel, so that you can check that the channel is clear before you make a call.

Note: Your radio may be programmed to activate monitor whenever the microphone is off the microphone clip.

To activate monitor, you may be able to either:

- remove the microphone from the microphone clip,
- use a programmed function key, or
- use the Main menu.

Activating monitor by using a function key

- 1 Press the monitor function key to activate monitor and hear any traffic on the channel.

While monitor is on, the green LED flashes continually and the monitor icon  appears in the icon bar.



- 2 Press the monitor function key again to turn monitor off, or wait for monitor to turn off automatically, after a programmed delay.

When monitor turns off, the green LED stops flashing and the monitor icon  disappears from the icon bar.



Activating monitor by using the Main menu

- 1 Select Menu>Radio Settings>Function Settings>Monitor.

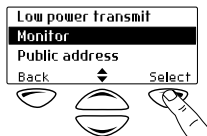

- 2 In the Monitor menu, choose **On**.

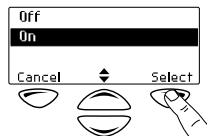

3 Press **Select**.

While monitor is on, the green LED flashes continually and the monitor icon  appears in the icon bar.



Making a call

- 1 Select the required channel or scan group.
- 2 Check that the channel is clear. If the green LED is glowing, the channel is busy and you may not be able to transmit.
- 3 Once the channel is clear (the green LED is off), lift the microphone off the microphone clip.
- 4 Hold the microphone about 5 cm (2 inches) from your mouth and press the PTT key to transmit.
- 5 Speak clearly into the microphone and release the PTT key when you have finished talking.

While you are transmitting, the red LED glows and the transmit icon  appears in the icon bar.



Transmit timer

Your radio may have a transmit timer that limits the amount of time you can transmit continuously.

When the transmit timer is about to expire, the message **Transmit timeout imminent** appears in the display, the red LED flashes and the radio gives three beeps.

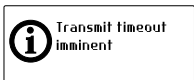

You must release the PTT before you can transmit again.

Note: Your radio may be unable to transmit for a short time after the transmit timer has expired.

Making a local call

Each channel on your radio may have one or more local calls programmed. To make a local call you may be able to either:

- use a programmed function key,
- use the Main menu, or
- use your Quick Access menu.

Making a local call by using a function key

- 1 Select the required channel.
- 2 Press the function key programmed for the local call you want.

The call details appear in the display, the red LED glows and the transmit icon  appears in the icon bar.



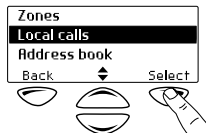

Making a local call by using the Main menu

- 1 Select the required channel.
- 2 Select Menu>Local Calls.



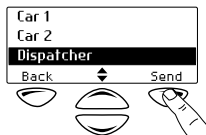

- 3 In the Local Calls menu, scroll through the list of local calls until the call you want appears.
- 4 Press **Send**.





The call details appear in the display, the red LED glows and the transmit icon  appears in the icon bar.

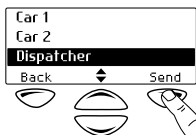
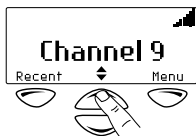

Making a local call by using your Quick Access menu

- 1 Select the required channel.
- 2 Press one of the scroll keys  or  to open the Local Calls menu.
- 3 Scroll through the list of local calls until the call you want appears.
- 4 Press **Send**.



The call details appear in the display, the red LED glows and the transmit icon  appears in the icon bar.



Making a call using your address book

Your Address Book menu has a programmed list of calls, which can be made from any channel or zone. Address-book calls may also be used to send status information, such as "at lunch" or "on site".

To make a call using your address book, you may be able to either:

- use a programmed function key,
- use the Main menu, or
- use your Quick Access menu.

Making an address-book call by using a function key

Press the function key programmed to make a call from your address book.

The call details appear in the display, the red LED glows and the transmit icon  appears in the icon bar.

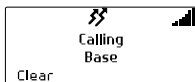

Making an address-book call by using the Main menu

- 1 Select Menu>Address Book.

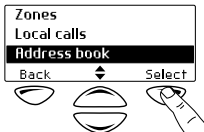

- 2 In the Address Book menu, scroll through the list of calls until the call you want appears.

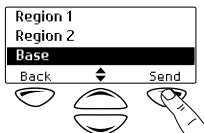

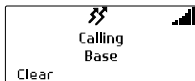

- 3 Press **Send**.

The call details appear in the display, the red LED glows and the transmit icon  appears in the icon bar.



Making an address-book call by using your Quick Access menu

- 1 Press one of the scroll keys  or  to open the Address Book menu.

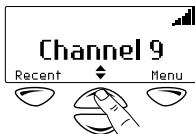

- 2 Scroll through the list of calls until the call you want appears.

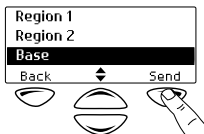

3 Press **Send**.

The call details appear in the display, the red LED glows and the transmit icon  appears in the icon bar.

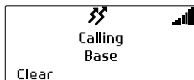

Making an emergency call

You may be able to activate emergency mode by using a programmed function key.

- 1 Press the function key programmed for emergency mode and an emergency call is sent to your dispatcher, or some other predetermined location.

While emergency mode is active, your radio may cycle between receive and transmit, so that your dispatcher can hear any activity near the radio. Alternatively, your radio may appear to turn off but will actually remain in emergency mode.

- 2 Reset the radio to normal operation at any time by turning the radio off and then on.

Receiving a call

When there is valid activity on your radio's currently selected channel or group, the radio then unmutes and you can hear the call.

If the incoming call contains special signalling that matches the signalling programmed for your radio, the green LED flashes and your radio may give a ringing tone.

Hearing faint and noisy signals

Your radio's squelch allows the radio to unmute only when the strength of the incoming signal is above a predetermined threshold. This means that only signals of reasonable intelligibility are made audible. To make faint and noisy signals audible, use the squelch override function to unmute the radio.

To activate squelch override, you may be able to either:

- use a programmed function key, or
- use the Main menu.

Turning squelch override on and off by using a function key

- 1 Press the function key programmed for squelch override to unmute the radio.

The message **Squelch override activated** appears on the display.

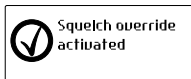

While squelch override is on, the green LED flashes continually and the squelch override icon  appears in the icon bar.

- 2 To turn squelch override off, press the squelch override function key again.

The message **Squelch override deactivated** appears in the display. The squelch override icon  disappears from the icon bar and the green LED stops flashing.

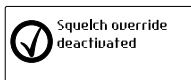

Turning squelch override on and off by using the function key programmed for monitor

The function key programmed for monitor may be programmed so that:

- a short key press turns monitor on, and
- a long key press turns squelch override on.

Press and hold the function key programmed for monitor to override the radio's squelch.

The message **Squelch override activated** appears in the display.

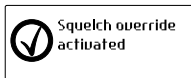

While squelch override is on, the green LED flashes continually and the squelch override icon  appears in the icon bar. Squelch override remains on until there is a further long key press.

Activating squelch override by using the Main menu

- 1 Select Menu>Radio Settings>Function Settings>Squelch Override.

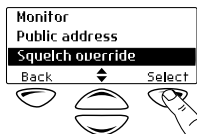

- 2 In the Squelch Override menu, chose **On** then press **Select**.

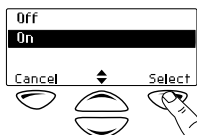

The message **Squelch override activated** appears in the display.

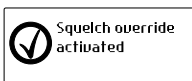

While squelch override is on, the green LED flashes continually and the squelch override icon  appears in the icon bar.

Troubleshooting

The following topics are covered in this section:

- [when your radio won't turn on](#)
- [removing the microphone](#)
- [removing the radio from the vehicle](#)
- [describing the radio's audible tones.](#)

When your radio won't turn on

If the red, green and amber LEDs on the control head do not light up when the radio is turned on, it is likely that no power is reaching the radio. Check the following:

- Is the power connector firmly plugged into the rear of the radio?
- Are the in-line fuses in good condition?
- Is the power cable securely connected to the vehicle battery or power supply?

If all appears to be in order, then contact your radio provider for further assistance.

Removing the microphone

- 1 Using your thumb or forefinger, lift up one of the corners of the microphone grommet. Firmly (but gently) pull that corner until the seal comes away from the cavity.

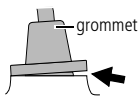

- 2 Repeat to expose another corner.
- 3 Pull the exposed corners back and slide the grommet up the microphone cable to reveal the microphone plug.
- 4 Remove the plug from the microphone socket.

Caution: The microphone grommet must be installed whenever the microphone is plugged into the microphone socket. When installing a microphone, follow the instructions in the section ["Installing the microphone"](#) on page 49.

Removing the radio from the vehicle

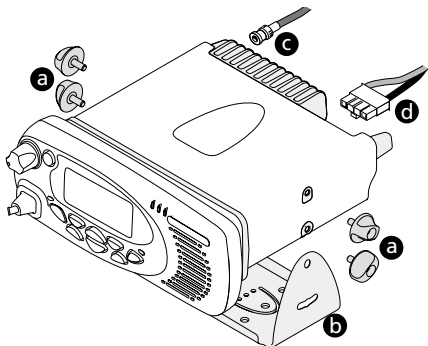

- 1 Switch off the radio.
- 2 Unscrew the four thumb screws **a** that secure the radio to the U-bracket **b**.
- 3 Carefully lift the radio clear of the U-bracket.
- 4 Disconnect the antenna **c** and power cable **d** from the rear of the radio.

Describing the radio's audible tones

The following table summarizes the radio's audible tones.

Action and tone	Meaning
two short beeps	radio turned on: the radio is powered on and ready to use
one short beep after the power-up beeps	radio locked: you need to enter your personal identity number (PIN) before you can use the radio
one long, low-pitched beep	radio PIN entry unsuccessful: you need to re-enter your PIN
two short beeps	radio PIN entry successful: the radio is now ready to use
one short beep	function activated: a function key has been pressed and that function has been initiated

Action and tone	Meaning
one short, low-pitched beep	function deactivated: a function key has been pressed and the corresponding function has been turned off
one long, low-pitched beep	invalid key press: the action you have attempted is not permitted, or transmission inhibited: you have attempted to transmit but for some reason transmission is not permitted at this time
one short, high-pitched beep	radio is stunned: the radio has been made inoperable by your service provider
two short beeps	radio is revived: the radio has made operable by your service provider
three beeps	transmit timeout imminent: in 10 seconds your transmit timer will expire and your current transmission will be terminated
two low-pitched beeps	radio's temperature is high: the radio's temperature is in the high-temperature range, but the radio will continue to operate
two high-pitched beeps	radio's temperature is very high: the radio's temperature is in the very high temperature range and all transmissions will now be at low power; if the radio's temperature rises outside this range, transmissions will be inhibited
continuous low-pitched tone	radio system error: a system error has occurred and the radio may be inoperable
two long low-high pitched tone pairs	synthesizer is out-of-lock: the radio's synthesizer is out-of-lock on the current channel and you cannot operate on that channel

Notes

Part 2: Radio installation procedures

Installation warnings	42
Safe radio mounting	42
Interference with the vehicle's electronic systems	42
Preparation when drilling holes	43
Vehicles powered by liquefied petroleum gas (LPG)	43
Radio installation in gas or fuel tankers	43
Non-standard radio installations	44
Negative ground supply	44
Installation planning	45
MPT 1362 code of practice	45
Checking equipment	45
Installation tools	46
Selecting the mounting position	46
Radio Installation	47
Installing and removing the control head	47
Installing the microphone	49
Installing the antenna	50
Installing the power cable	51
Mounting the U-bracket	53
Installing the radio in the U-bracket	54
Checking the installation	54
Other installation options	55
Tait general software licence agreement	56

Installation warnings

The following topics are covered in this section:

- [safe radio mounting](#)
- [interference with the vehicle's electronic systems](#)
- [preparation when drilling holes](#)
- [vehicles powered by liquefied petroleum gas \(LPG\)](#)
- [radio installation in gas or fuel tankers](#)
- [non-standard radio installations](#)
- [negative ground supply](#).

Safe radio mounting



Caution: Mount the radio securely so that it will not break loose in the event of a collision. An unsecured radio is dangerous to the vehicle occupants.

- Mount the radio where it will not interfere with the deployment of passenger air bags.
- Do not mount the radio vertically, with the control head facing down. This will violate compliance with the European Union standard EN 60950, Safety of Information Technology Equipment.

Interference with the vehicle's electronic systems



Caution: Some vehicular electronic devices may be prone to malfunction, due to the lack of protection from RF energy present when your radio is transmitting.

Examples of vehicular electronic devices that may be affected by RF energy are:

- electronic fuel injection systems
- electronic anti-skid braking systems
- electronic cruise control systems.

If the vehicle contains such equipment, consult the vehicle manufacturer or dealer in order to determine whether these electronic circuits will perform normally when the radio is transmitting.

Preparation when drilling holes



Caution: When drilling holes in the vehicle, check that drilling at the selected points will not damage existing wiring, petrol tanks, fuel lines, brake pipes or battery cables.

Vehicles powered by liquefied petroleum gas (LPG)



Caution: Radio installation in vehicles powered by LPG with the LPG container in a sealed-off space within the interior of the vehicle must conform to the National Fire Protection Association Standard NFPA 58. This standard states that the radio equipment installation must meet the following requirements.

- The space containing the radio equipment shall be isolated by a seal from the space containing the LPG container and its fitting.
- Outside filling connections shall be used for the LPG container and its fittings.
- The LPG container space shall be vented to the outside of the vehicle.

Radio installation in gas or fuel tankers

Special conditions must be observed when installing a radio in gas and fuel tankers. Consult your radio provider or Tait-accredited service centre for more details.

Non-standard radio installations

The installation U-bracket described in this guide has been designed so that there is enough airflow around the radio to provide cooling.

If a non-standard installation method is used, care must be taken that sufficient heat can be dissipated from the radio heatsink fins and the bottom surface of the radio chassis.

For this to be achieved, there must be a gap of more than 10mm (3/8 inch) between the bottom surface of the radio chassis and the mounting surface. This is illustrated in the following diagram.

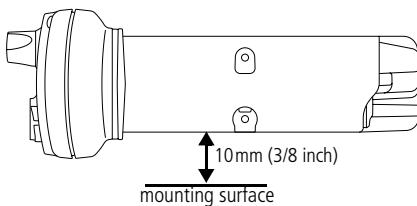

Negative ground supply

TM8200 radios are designed to operate only in a negative ground system.

Installation planning

The procedures outlined in this and the following sections are for installing a TM8200 radio in a vehicle, using a standard U-bracket.

The following topics are covered in this section:

- [MPT 1362 code of practice](#)
- [checking equipment](#)
- [installation tools](#)
- [selecting the mounting position.](#)

MPT 1362 code of practice

TM8200 radios should be installed in accordance with the MPT 1362 Code of Practice. This code of practice covers the installation of mobile radio equipment in land based vehicles and has been developed by the United Kingdom Radiocommunications Agency.



Website: For the full text of the MPT 1362 Code of Practice, go to the Radiocommunications Agency website, <http://www.radio.gov.uk>.

Checking equipment

Unpack the radio and check that you have the following items:

- radio control head with connecting loom
- radio body
- microphone with microphone clip and screws
- U-bracket installation kit, consisting of:
 - U-bracket
 - thumbscrews
 - self-drilling screws and washers
 - power cable with DC connector
 - 10A fuses (25W radios)
 - 20A fuses (40W/50W radios)

- fuse holders
- receptacles for a remote speaker (speaker not included)
- BNC or mini-UHF antenna plug.

Installation tools

The following installation tools may be required:

- portable drill and drill bit
- Pozidriv screwdriver
- 8mm (5/16 inch) socket (or Pozidriv screwdriver)
- BNC or mini-UHF crimp tool
- fuse crimp tool
- in-line RF power meter capable of measuring forward and reflected power at the operating frequency of the radio.

Microphone clip installation tools

The following installation tools may be required for installing the microphone:

- centre punch
- drill bit
- Pozidriv screwdriver
- hammer.

Selecting the mounting position

Inspect the vehicle and determine the safest and most convenient location for mounting the radio.

The installation must meet the following requirements:

- sufficient clearance behind the radio for the heatsink and cables
- a large enough flat surface so that the mounting bracket will not be distorted
- no danger of the radio interfering with air bag deployment.

Radio Installation

The following topics are covered in this section:

- installing and removing the control head
- installing the microphone
- installing the antenna
- installing the power cable
- mounting the U-bracket
- installing the radio in the U-bracket
- checking the installation
- other installation options.

Installing and removing the control head

Caution: The control head contains devices which can be damaged by static discharges. Always install or remove the control head in a static-safe environment.



Website: For information on antistatic precautions, go to the Electrostatic Discharge Association (ESD) website, <http://www.esda.org>.

Installing the control head on the radio body

Note: The way in which the U-bracket is mounted determines which way up the control head is mounted on the radio body.

The numbers in the diagram on the following page refer to the numbered steps below.

- 1 Plug the control head loom onto the control head connector.
- 2 Insert the bottom edge of the control head onto the two clips in the front of the radio chassis, then snap into place.

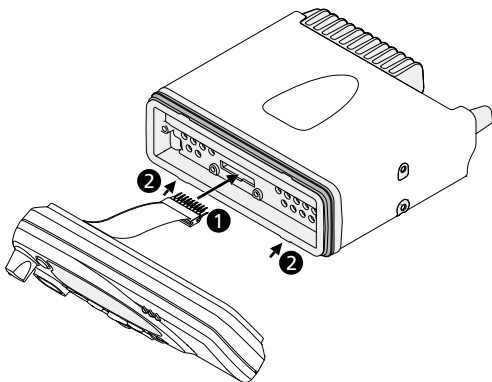

Removing the control head

Caution: During this procedure, take care that the control-head seal is not damaged. Damage to this seal reduces environmental protection.

- 1 On the underside of the radio, insert a 5mm (3/16 inch) flat-bladed screwdriver between the control head and the control-head seal, in either position **1** or **2**.

Insertion points **1** and **2** are lever points and are indicated on the radio chassis by a dot-dash-dot pattern (•—•).

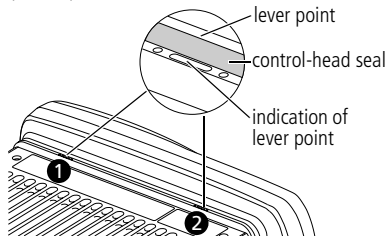

- 2 Use the screwdriver to lift the control head off the chassis clip, then repeat in the other position. The control head can now be removed from the radio body.

Installing the microphone

A microphone and microphone clip are only used for radios with a user interface.

Caution: The microphone grommet must be installed whenever the microphone is plugged into the microphone socket. When installed, the grommet has two functions:

- to prevent damage to the microphone socket when there is movement of the microphone cord, and
- to ensure that the control head is sealed against water, dust and other environmental hazards.

To install the microphone:

- 1 Plug the microphone into the microphone socket.
- 2 Slide the microphone grommet along the microphone cord and push two adjacent corners of the grommet into the microphone socket cavity.
- 3 Squeeze the grommet and push the remaining corners into position.
- 4 Check that the grommet is seated correctly in the cavity.

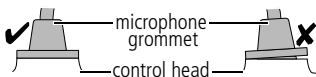

Installing the microphone clip

Caution: Only install the microphone clip provided. If a non-standard microphone clip is used, the correct operation of the microphone hookswitch cannot be guaranteed.

Install the microphone clip in the most convenient location for the radio user. It must be installed:

- within easy reach of the user, and
- in such a position that the microphone PTT key cannot be inadvertently activated or jammed on.

Installing the antenna

Install the external antenna according to the supplier's instructions. Good quality 50 ohm coaxial cable must be used, such as RG58 or UR76.

Caution: The cable should be routed in a manner that minimizes coupling into the electronic control systems of the vehicle.

Caution: Avoid sharp bends in the cable. These distort the cable and alter its electrical characteristics.



Warning: RF exposure hazard

To comply with FCC RF exposure limits:

- 1 Mount the antenna at a location such that no person or persons can come closer than 0.9m (35 inches) to the antenna.
- 2 For 25W radios, the radio must be installed using an externally mounted antenna with a gain of either a 2.15dBi or 5.15dBi gain.
- 3 For 40W/50W radios:
 - VHF radios must be installed using an antenna mounted centrally on the vehicle roof, with a gain of 2.15dBi or 5.15dBi.
 - UHF radios must be installed using an antenna either mounted centrally on the vehicle roof with a gain of 2.15dBi or 5.65dBi, or mounted centrally on the trunk with a gain of 5.65dBi.

Antenna termination

- 1 Run the free end of the coaxial cable to the radio's mounting position and cut it to length, allowing 20 - 30cm (8 - 12 inches) excess.

Caution: The cable should be protected from engine heat, sharp edges and from being pinched or crushed.



- 2 Terminate the free end of the cable with the BNC or mini-UHF plug.

Installing the power cable

One end of the power cable is connected to the vehicle battery and the other end plugs into the radio's power connector.

Power connector

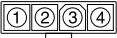
The following table explains the pin allocations for the power connectors on both 25W and 40W/50W radios.

	Pin	Signal name	Description
25W radio  rear view	1	AGND	earth return for radio body power source
	2	SPK-	external speaker output
40W/50W radio  rear view	3	SPK+	external speaker output
	4	13V8_BATT	DC power input for radio body and control head

Battery supply voltage

This radio is designed to operate from a nominal 12V negative ground supply and may draw up to 8A of current (25W radios) or 15A of current (40W/50W radios). The radio will tolerate a supply voltage range of 10.8V to 16.0V at the radio.

Caution: In vehicles with a supply voltage greater than 16.0V, such as many trucks, it is essential to provide a suitably rated DC to DC converter. This will isolate the radio from excessive battery voltage and provide the correct DC operating conditions.

Connecting the power cable

Caution: Disconnecting the vehicle's battery may cause problems with some electronic equipment, such as vehicle alarms, engine management systems and in-car entertainment systems. Check that the

vehicle owner has the necessary information to make all electronic equipment function correctly after battery reconnection.

Caution: If the battery is not disconnected, exercise extreme caution throughout the installation and install the fuses only when the installation is ready to be checked (see [“Checking the installation” on page 54](#)).

- 1** Disconnect the vehicle’s battery, unless specifically prohibited from doing so by the customer, vehicle manufacturer, agent or supplier.
- 2** Run the power cable between the radio’s mounting position and the vehicle battery.

Caution: The power cable should be protected from engine heat, sharp edges and from being pinched or crushed.

- 3** Cut the power cable to length, allowing about 20cm (8 inches) excess at the radio end.
- 4** Cut the negative and the positive wires where the in-line fuse holders will be placed (as close to the battery as possible).

Caution: Do not install the fuses until the installation is ready to be checked.

- 5** Insert each end of the negative wire into one of the in-line fuse holders and crimp them to force the metal contacts onto the wires.
- 6** Connect the negative wire to the battery ground.
- 7** Repeat step 5 for the positive wire and connect it to the positive terminal of the battery.

Mounting the U-bracket

The U-bracket can be used to install the radio on the dashboard or on any sufficiently flat surface, using the self-drilling screws and washers provided in the installation kit.

Caution: When mounting the radio, check whether the mounting surface needs to be reinforced.

Caution: The U-bracket must be installed using at least four screws.

- 1 If the U-bracket is being mounted over a curved surface, bend the U-bracket tabs slightly, to match the surface shape.
- 2 Drill any holes required for cables and install suitable grommets or bushings in the holes.

Caution: Check that the U-bracket is not distorted when the screws are tightened.

- 3 Screw the U-bracket in the chosen mounting position using the self-drilling screws and washers provided.



Tip: For more precise positioning, predrill 3 mm (1/8 inch) pilot holes for the self-drilling screws. Reduce the hole size in metal that is less than 1 mm (1/32 inch) thick.

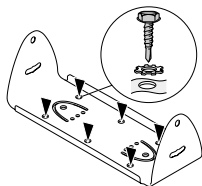

Installing the radio in the U-bracket

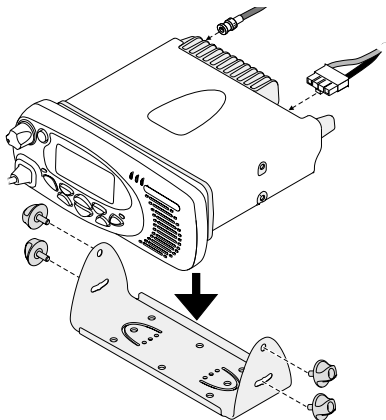

- 1 Connect the antenna and power cables to the rear of the radio.
- 2 Position the radio in the U-bracket so that the holes in the U-bracket line up with the holes in the radio chassis.
- 3 Screw the radio into position using the four thumb screws but without fully tightening the screws.
- 4 Position the radio in the U-bracket for best viewing angle, then tighten the thumb screws.

Checking the installation

- 1 Insert the fuses into the power leads.
 - 2 Switch on the radio to confirm that it is operational.
- Caution:** Do not transmit yet.
- 3 Connect an in-line power meter between the radio and the antenna.

- 4 Transmit and measure the forward and reflected power levels.
Less than 4% of the forward power should be reflected. If this is not achieved, check the installation, including the antenna length.
- 5 Radios with a user interface only:
Once the reflected power levels are within tolerance, make a call to another party on the radio (see [“Making a call” on page 30](#)).

Other installation options

Contact your radio provider for further information.

Tait general software licence agreement

This legal document is an Agreement between you (the "Licensee") and Tait Electronics Limited ("Tait"). By using any of the Software or Firmware items prior-installed in the related Tait product, included on this CD or downloaded from the Tait website, (hereinafter referred to as "the Software or Firmware") you agree to be bound by the terms of this Agreement. If you do not agree to the terms of this Agreement, do not install and use any of the Software or Firmware. If you install and use any of the Software or Firmware that will be deemed to be acceptance of the terms of this licence agreement.

The terms of this agreement shall apply subject only to any express written terms of agreement to the contrary between Tait and the Licensee.

Licence

TAIT GRANTS TO YOU AS LICENSEE THE NON-EXCLUSIVE RIGHT TO USE THE SOFTWARE OR FIRMWARE ON A SINGLE MACHINE PROVIDED YOU MAY ONLY:

- 1 COPY THE SOFTWARE OR FIRMWARE INTO ANY MACHINE READABLE OR PRINTED FORM FOR BACKUP PURPOSES IN SUPPORT OF YOUR USE OF THE PROGRAM ON THE SINGLE MACHINE (CERTAIN PROGRAMS, HOWEVER, MAY INCLUDE MECHANISMS TO LIMIT OR INHIBIT COPYING, THEY ARE MARKED "COPY PROTECTED"), PROVIDED THE COPYRIGHT NOTICE MUST BE REPRODUCED AND INCLUDED ON ANY SUCH COPY OF THE SOFTWARE OR FIRMWARE; AND / OR
- 2 MERGE IT INTO ANOTHER PROGRAM FOR YOUR USE ON THE SINGLE MACHINE (ANY PORTION OF ANY SOFTWARE OR FIRMWARE MERGED INTO ANOTHER PROGRAM WILL CONTINUE TO BE SUBJECT TO THE TERMS AND CONDITIONS OF THIS AGREEMENT).

THE LICENSEE MAY NOT DUPLICATE, MODIFY, REVERSE COMPILE OR REVERSE ASSEMBLE ANY SOFTWARE OR FIRMWARE IN WHOLE OR PART.

Title to Software

THIS AGREEMENT DOES NOT CONSTITUTE A CONTRACT OF SALE IN RELATION TO THE SOFTWARE OR FIRMWARE SUPPLIED TO THE LICENSEE. NOTWITHSTANDING THE LICENSEE MAY OWN THE MAGNETIC OR OTHER PHYSICAL MEDIA ON WHICH THE SOFTWARE OR FIRMWARE WAS ORIGINALLY SUPPLIED, OR HAS SUBSEQUENTLY BEEN RECORDED OR FIXED, IT IS A FUNDAMENTAL TERM OF THIS AGREEMENT THAT AT ALL TIMES TITLE AND OWNERSHIP OF THE SOFTWARE OR FIRMWARE, WHETHER ON THE ORIGINAL MEDIA OR OTHERWISE, SHALL REMAIN VESTED IN TAIT OR THIRD PARTIES WHO HAVE GRANTED LICENCES TO TAIT.

Term and Termination

THIS LICENCE SHALL BE EFFECTIVE UNTIL TERMINATED IN ACCORDANCE WITH THE PROVISIONS OF THIS AGREEMENT. THE LICENSEE MAY TERMINATE THIS LICENCE AT ANY TIME BY DESTROYING ALL COPIES OF THE SOFTWARE OR FIRMWARE AND ASSOCIATED WRITTEN MATERIALS. THIS LICENCE WILL BE TERMINATED AUTOMATICALLY AND WITHOUT NOTICE FROM TAIT IN THE EVENT THAT THE LICENSEE FAILS TO COMPLY WITH ANY TERM OR CONDITION OF THIS AGREEMENT. THE LICENSEE AGREES TO DESTROY ALL COPIES OF THE SOFTWARE OR FIRMWARE AND ASSOCIATED WRITTEN MATERIALS IN THE EVENT OF SUCH TERMINATION.

Limited Warranty

THE SOFTWARE OR FIRMWARE IS SUPPLIED BY TAIT AND ACCEPTED BY THE LICENSEE "AS IS" WITHOUT WARRANTY OF ANY KIND EITHER EXPRESSED OR IMPLIED, INCLUDING BUT NOT BEING LIMITED TO ANY IMPLIED WARRANTIES AS TO MERCHANTABILITY OR FITNESS FOR ANY PARTICULAR PURPOSE. THE LICENSEE ACKNOWLEDGES THAT THE SOFTWARE OR FIRMWARE IS USED BY IT IN BUSINESS AND ACCORDINGLY TO THE MAXIMUM EXTENT PERMITTED BY LAW NO TERMS OR WARRANTIES WHICH ARE IMPLIED BY LEGISLATION SHALL APPLY TO THIS AGREEMENT. TAIT DOES NOT WARRANT THAT THE FUNCTIONS CONTAINED IN THE SOFTWARE OR FIRMWARE WILL MEET THE LICENSEE'S REQUIREMENTS OR THAT THE OPERATION OF THE SOFTWARE OR FIRMWARE WILL BE UNINTERRUPTED OR ERROR FREE.

Exclusion of Liability

TAIT'S ENTIRE LIABILITY AND THE LICENSEE'S EXCLUSIVE REMEDY SHALL BE THE FOLLOWING:

- 1 IN NO CIRCUMSTANCES SHALL TAIT BE UNDER ANY LIABILITY TO THE LICENSEE, OR ANY OTHER PERSON WHATSOEVER, FOR ANY DIRECT OR CONSEQUENTIAL DAMAGE ARISING OUT OF OR IN CONNECTION WITH ANY USE OR INABILITY OF USING THE SOFTWARE OR FIRMWARE.
- 2 TAIT WARRANTS THE OPERATION OF THE SOFTWARE OR FIRMWARE ONLY WITH THE OPERATING SYSTEM FOR WHICH IT WAS DESIGNED. USE OF THE SOFTWARE OR FIRMWARE WITH AN OPERATING SYSTEM OTHER THAN THAT FOR WHICH IT WAS DESIGNED MAY NOT BE SUPPORTED BY TAIT, UNLESS OTHERWISE EXPRESSLY AGREED BY TAIT.

General

THE LICENSEE CONFIRMS THAT IT SHALL COMPLY WITH THE PROVISIONS OF LAW IN RELATION TO THE SOFTWARE OR FIRMWARE.

Law and Jurisdiction

THIS AGREEMENT SHALL BE SUBJECT TO AND CONSTRUED IN ACCORDANCE WITH NEW ZEALAND LAW AND DISPUTES BETWEEN THE PARTIES CONCERNING THE PROVISIONS HEREOF SHALL BE DETERMINED BY THE NEW ZEALAND COURTS OF LAW. PROVIDED HOWEVER TAIT MAY AT ITS ELECTION BRING PROCEEDINGS FOR BREACH OF THE TERMS HEREOF OR FOR THE ENFORCEMENT OF ANY JUDGEMENT IN RELATION TO A BREACH OF THE TERMS HEREOF IN ANY JURISDICTION TAIT CONSIDERS FIT FOR THE PURPOSE OF ENSURING COMPLIANCE WITH THE TERMS HEREOF OR OBTAINING RELIEF FOR BREACH OF THE TERMS HEREOF.

No Dealings

THE LICENSEE MAY NOT SUBLICENSE, ASSIGN OR TRANSFER THE LICENCE OR THE PROGRAM EXCEPT AS EXPRESSLY PROVIDED IN THIS AGREEMENT. ANY ATTEMPT OTHERWISE TO SUBLICENSE, ASSIGN OR TRANSFER ANY OF THE RIGHTS, DUTIES OR OBLIGATIONS HEREUNDER IS VOID.

No Other Terms

THE LICENSEE ACKNOWLEDGES THAT IT HAS READ THIS AGREEMENT, UNDERSTANDS IT AND AGREES TO BE BOUND BY ITS TERMS AND CONDITIONS. THE LICENSEE FURTHER AGREES THAT SUBJECT ONLY TO ANY EXPRESS WRITTEN TERMS OF AGREEMENT TO THE CONTRARY BETWEEN TAIT AND THE LICENSEE THIS IS THE COMPLETE AND EXCLUSIVE STATEMENT OF THE AGREEMENT BETWEEN IT AND TAIT IN RELATION TO THE SOFTWARE OR FIRMWARE WHICH SUPERSEDES ANY PROPOSAL OR PRIOR AGREEMENT, ORAL OR WRITTEN AND ANY OTHER COMMUNICATIONS BETWEEN THE LICENSEE AND TAIT RELATING TO THE SOFTWARE OR FIRMWARE