

REPORT ON :

Type Approval Testing of the TMAB34-B101 (Serial No 19016675)
in accordance with:

FCC CFR 47 Parts 22 & 90

FCC ID: CASTMAB1F

PREPARED FOR :

Tait Electronics Ltd
PO Box 1645
558 Wairakei Rd
Christchurch
New Zealand

DISTRIBUTION :

TELTest Laboratory	Mr S Crompton	Copy No 1
Tait Electronics Ltd	Mr. Des Fox	Copy No 2
Tait Electronics Ltd	Mr. Dereck Fiddes	Copy No 3

APPROVED :

Hamish Newton

Senior Technician

Date :

All tests reported herein have been performed in accordance with the
laboratory's scope of accreditation

This document must not be reproduced except in full, without the written
permission of the Compliance Laboratory Manager.

Copy No:

TABLE OF CONTENTS

DECLARATION OF CONFORMITY	4
TEST CONDITIONS	5
NECESSARY BANDWIDTH AND EMISSION DESIGNATORS	5
TEST RESULTS	9
TRANSMITTER OUTPUT POWER (CONDUCTED)	9
TRANSMITTER AUDIO FREQUENCY RESPONSE - PRE-EMPHASIS	10
TRANSMITTER MODULATION LIMITING	12
OCCUPIED BANDWIDTH	15
<i>ANALOGUE VOICE</i>	16
<i>FFSK</i>	20
<i>THSD</i>	24
<i>Digital (4-level FSK)</i>	28
SPURIOUS EMISSIONS (CONDUCTED).....	32
SPURIOUS EMISSIONS (RADIATED).....	35
TRANSMITTER FREQUENCY STABILITY (TEMPERATURE)	38
TRANSMITTER FREQUENCY STABILITY (VOLTAGE)	40
TRANSIENT FREQUENCY BEHAVIOR	41
TEST EQUIPMENT USED	46
APPENDIX A	47
TEST SETUP DETAILS.....	47

DECLARATION OF CONFORMITY

We, TELTEST LABORATORIES of 558 Wairakei Road, Christchurch New Zealand, declare under our sole responsibility that the product:

Equipment: Mobile Transceiver
Type: TMAB1E
Product code: TMAB34-B101
Serial Numbers: 19016675
Quantity: 1

To which this declaration relates is in conformity with the following standards:

FCC CFR 47 Parts 22 & 90

Signature: _____

S. A. Crompton
Compliance Laboratory Manager.

Date: _____

4. Fast Frequency Shift Keying (FFSK) 25kHz Bandwidth

Necessary bandwidth

Emission Designator

M = 0.6 (Baud rate = 1200)

8k40F2D

D = 3kHz (60% of peak deviation)

F2D represents a FM data transmission with the use of a modulating sub carrier

$B_n = 1.2 + 6 \times 1.2$
 $= 8.4 \text{ kHz}$

5. Tait High Speed Data (THSD)

THSD uses a 4 level gaussian frequency shift keying (CP-4GFSK) modulation scheme. It can be used when transferring data between two radios. Data is transmitted at a rate of 12000bps for narrow band channels, and 19200bps for wide-band channels.

Due to the difficulties in determining the value of k, the necessary bandwidth has been measured using the 99% energy rule.

12.5kHz Bandwidth

99% bandwidth

Emission Designator

7.7 kHz

7k70F1D

F1D represents a FM data transmission without the use of a modulating sub carrier

25kHz Bandwidth

99% bandwidth

Emission Designator

12.6 kHz

12k6F1D

F1D represents a FM data transmission without the use of a modulating sub carrier

1. Digital Voice /Data (4 – Level FSK) – CFR 47 90.212 (b)

Digital Voice/data transmissions use a 4 level frequency shift keying modulation scheme. The necessary bandwidth as been measured using the 99% energy rule, and in accordance with TIA/EIA 102 CAAB 2.2.5.2

a) Operating in a 12.5 kHz Bandwidth

Digital Voice

99% bandwidth

Emission Designator

8.1 kHz

8K10F1E

F1E represents a digital FM voice transmission

8K10F7E

F7E represents two or more channels containing quantized or digital voice information

Digital Data

99% bandwidth

Emission Designator

8.1 kHz

8K10F1D

F1D represents a digital FM data transmission

8K10F7D

F7D represents two or more channels containing quantized or digital information

b) Operating in a 25 kHz Bandwidth

Digital Voice

99% bandwidth

Emission Designator

10.0 kHz

10K0F1E

F1E represents a digital FM voice transmission

10K0F7E

F7E represents two or more channels containing quantized or digital voice information

Digital Data

99% bandwidth

Emission Designator

10.0 kHz

10K0F1D

F1D represents a digital FM data transmission

10K0F7D

F7D represents two or more channels containing quantized or digital information

2. Digital Voice Encryption (4 – Level FSK) – CFR 47 90.212 (b)

Digital Voice Encryption transmissions use a 4 level frequency shift keying modulation scheme.

The necessary bandwidth as been measured using the 99% energy rule, and in accordance with TIA/EIA 102 CAAB 2.2.5.2

b) Operating in a 12.5 kHz Bandwidth

Digital voice

99% bandwidth

Emission Designator

8.1 kHz

8K10F1E

F1E represents a digital FM voice transmission

c) Operating in a 25 kHz Bandwidth

Digital voice

99% bandwidth

Emission Designator

10.0 kHz

10K0F1E

F1E represents a digital FM voice transmission

Test Results

TRANSMITTER OUTPUT POWER (CONDUCTED)

SPECIFICATION: FCC 47 CFR 2.1046

GUIDE: TIA/EIA-603B 2.2.1

MEASUREMENT PROCEDURE:

1. Refer Appendix A for Equipment set up.
2. The coaxial attenuator has an impedance of 50 Ohms.
3. The unmodulated output power was measured with an RF Power meter.

MEASUREMENT RESULTS:

Manufacturer's Rated Output Power: Switchable: 10 W and 50 W

155.1 MHz	10 W nominal	50 W nominal
POWER (W)	10.3	50.6
Variation from Nominal (%)	+3.0	+1.2
Measurement Uncertainty (dB)		+0.63 -0.68

LIMIT CLAUSE: FCC 47 CFR 90.205

Radio Type: Mobile Transceiver

Frequency Band: 150 MHz ~ 174 MHz

- (o) The output power shall not exceed by more than 20% the manufacturer's rated output power for the particular transmitter.

TRANSMITTER AUDIO FREQUENCY RESPONSE - PRE-EMPHASIS

SPECIFICATION: FCC 47 CFR 2.1047 (a)

GUIDE: TIA/EIA-603B 2.2.6

MEASUREMENT PROCEDURE:

1. Refer Appendix A for Equipment set up.
2. An audio input tone of 1000Hz was applied with the level set to obtain 20% of maximum deviation. This was used as the 0dB reference point.
3. The AF was varied while the audio level was held constant.
4. The response in dB relative to 1000Hz was measured.

MEASUREMENT RESULTS:

See the plots on the following pages for 12.5 kHz & 25.0 kHz channel spacings.

LIMIT CLAUSE: TIA/EIA-603B 3.2.6

TRANSMITTER AUDIO FREQUENCY RESPONSE - PRE-EMPHASIS

SPECIFICATION: FCC CFR 2.1047 (a)

Tx FREQUENCY: 155.1 MHz 12.5 kHz Channel Spacing

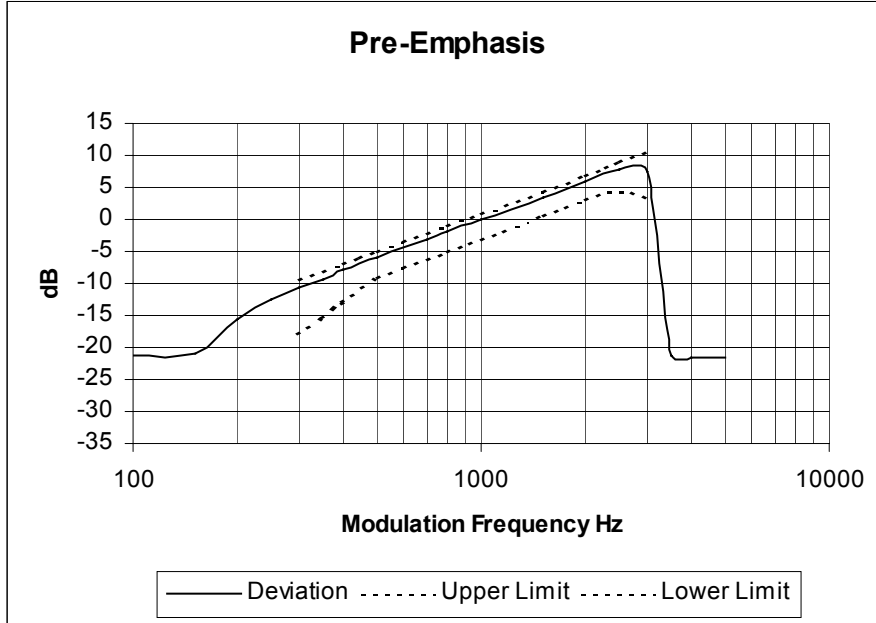

Tx FREQUENCY: 155.1 MHz 25.0 kHz Channel Spacing

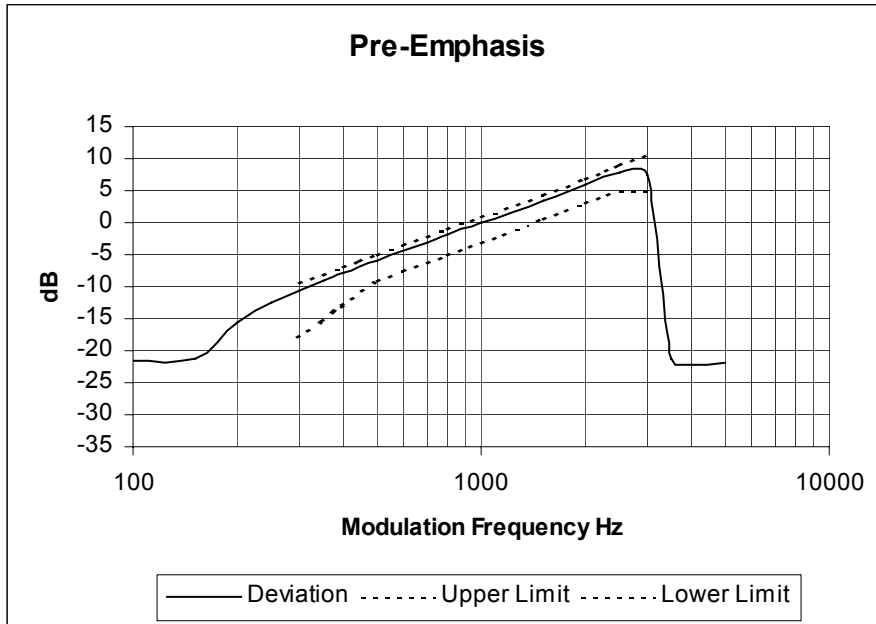

TRANSMITTER MODULATION LIMITING

SPECIFICATION: FCC 47 CFR 2.1047 (b)

MEASUREMENT PROCEDURE:

1. Refer Appendix A for Equipment set up.
2. The modulation response was measured at three audio frequencies while varying the input level.
3. Measurements were made for both Positive and Negative Deviation.

MEASUREMENT RESULTS:

See the plots on the following pages for 12.5 kHz & 25.0 kHz channel spacings.

LIMIT CLAUSE: TIA/EIA-603B 1.3.4.4

TRANSMITTER MODULATION LIMITING

SPECIFICATION: FCC CFR 2.1047 (b)

Tx FREQUENCY: 155.1 MHz 12.5 kHz Channel Spacing

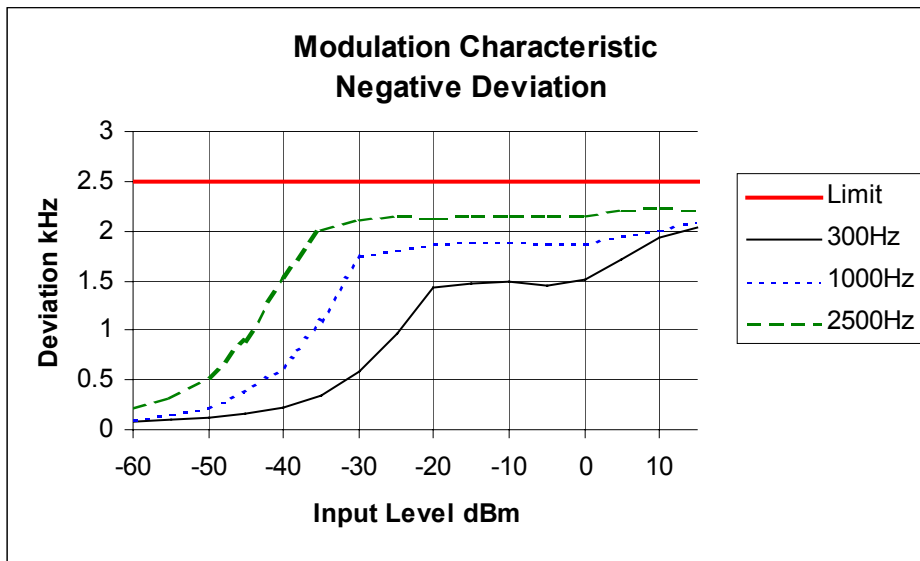
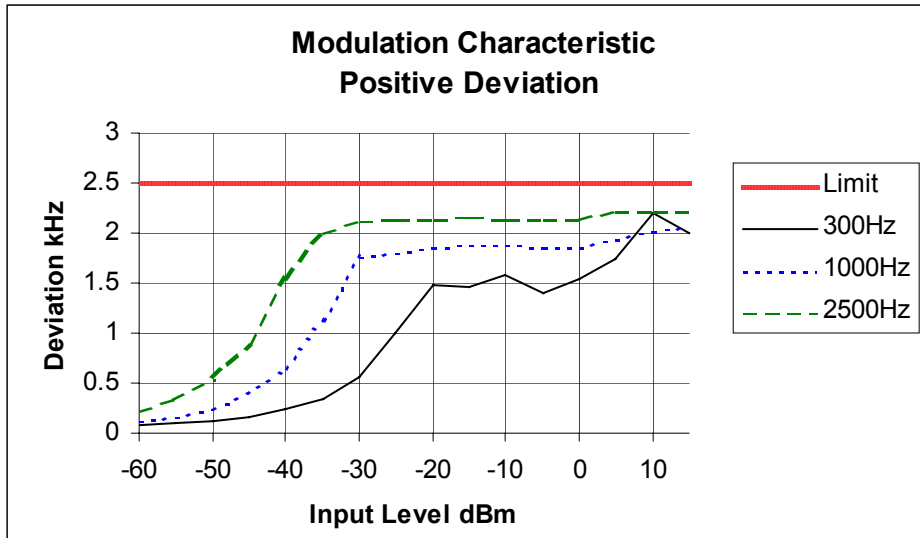

TRANSMITTER MODULATION LIMITING

SPECIFICATION: FCC CFR 2.1047 (b)

Tx FREQUENCY: 155.1 MHz 25.0 kHz Channel Spacing

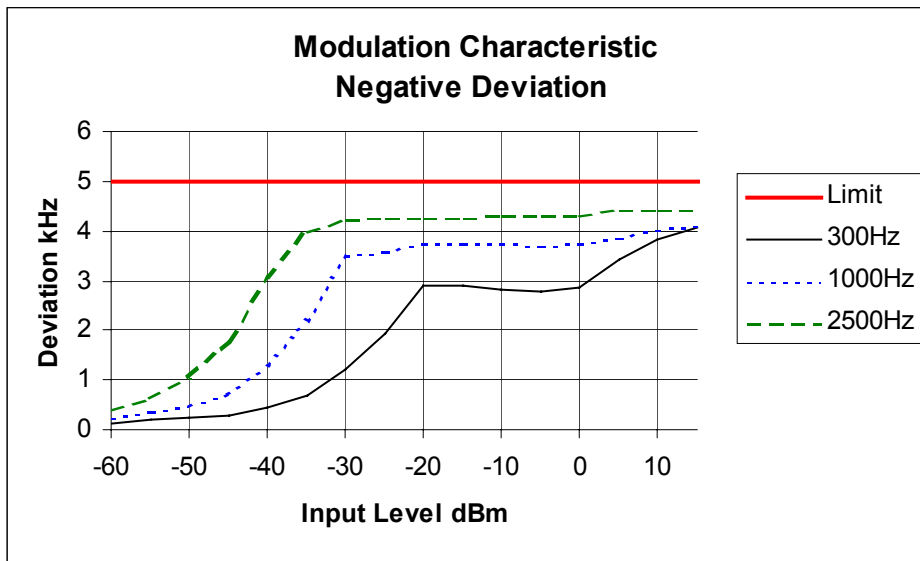
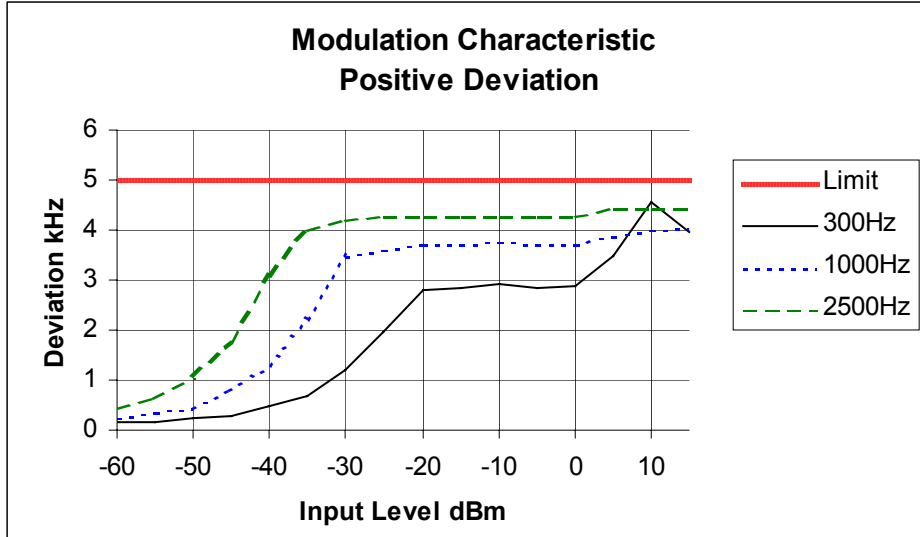

OCCUPIED BANDWIDTH

SPECIFICATION: FCC 47 CFR 2.1049 (c)

GUIDE: TIA/EIA-603B 2.2.11 for Analogue
TIA/EIA-102CAAA-A 2.2.5 for Digital

MEASUREMENT PROCEDURE:

1. Refer Appendix A for Equipment Set up.
2. For analogue measurements: The EUT was modulated by a 2500Hz tone at an input level 16dB above a level that produced 50% deviation. The input level was established at the frequency of maximum response of the audio modulating circuit .
For Digital measurements: The EUT was modulated with an internally generated pseudo random bit sequence at the appropriate Baud rates.
3. The Occupied Bandwidth was measured on the Spectrum Analyser, with bandwidth settings as follows.

Emission Mask D – Resolution Bandwidth = 100Hz, Video Bandwidth = 1 kHz
Emission Mask B, and C – Resolution bandwidth = 300Hz, Video Bandwidth = 3 kHz

MEASUREMENT RESULTS:

See the plots on the following pages for 12.5 kHz & 25.0 kHz channel spacings.

LIMIT CLAUSE: FCC 47 CFR 90.210

EMISSION MASKS

Emission Mask D	12.5 kHz Channel Spacing	Analog; Digital; FFSK; THSD
Emission Mask B	25.0 kHz Channel Spacing	Analog;
Emission Mask C	25.0 kHz Channel Spacing	Digital; FFSK; THSD

DATA SPEED

Digital	9600 bps	12.5 kHz Channel Spacing
Digital	9600 bps	25.0 kHz Channel Spacing
FFSK	1200 bps	12.5 kHz Channel Spacing
FFSK	1200 bps	25.0 kHz Channel Spacing
THSD	12000 bps	12.5 kHz Channel Spacing
THSD	19200 bps	25.0 kHz Channel Spacing

OCCUPIED BANDWIDTH

ANALOGUE VOICE

SPECIFICATION: FCC CFR 2.1049 (c)

Tx FREQUENCY: 155.1 MHz 50 W 12.5 kHz Channel Spacing

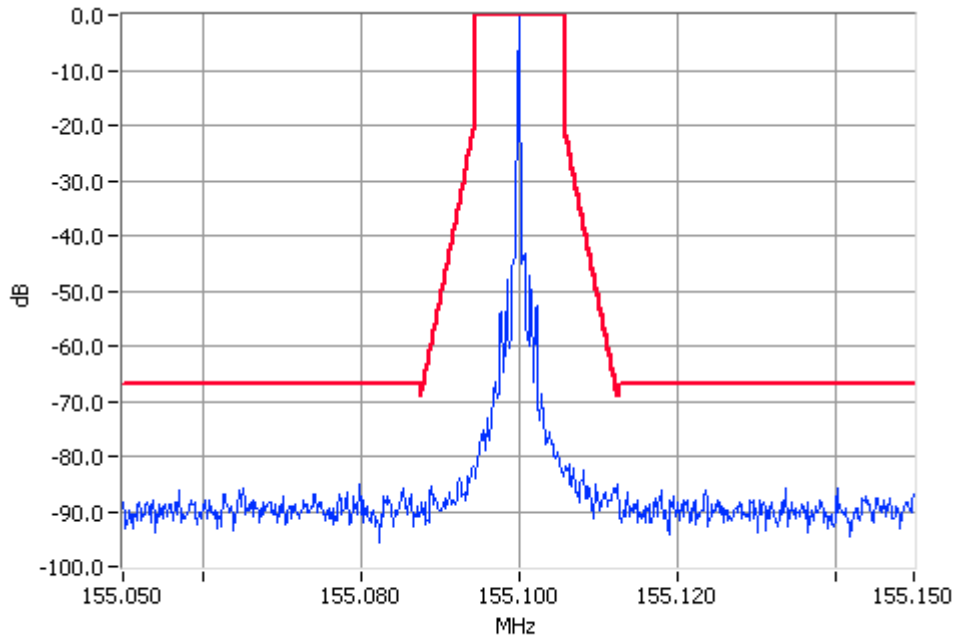

Unmodulated 155.100MHz Mask D 50W Pass
RBW=100Hz VBW=1000Hz

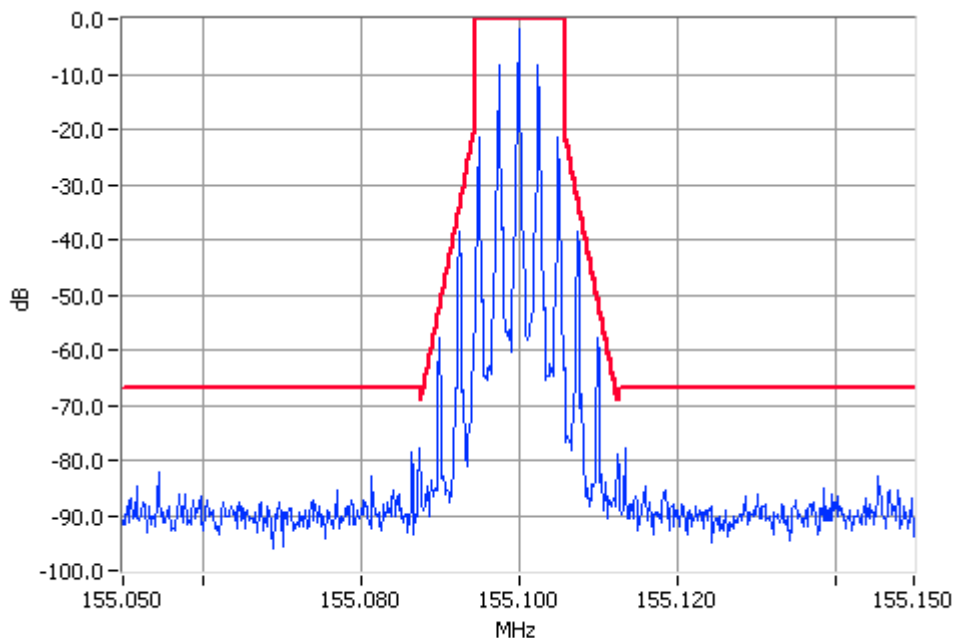

Analogue Modulation 155.100MHz Mask D 50W
Pass

OCCUPIED BANDWIDTH

ANALOGUE VOICE

SPECIFICATION: FCC CFR 2.1049 (c)

Tx FREQUENCY: 155.1 MHz 10 W 12.5 kHz Channel Spacing

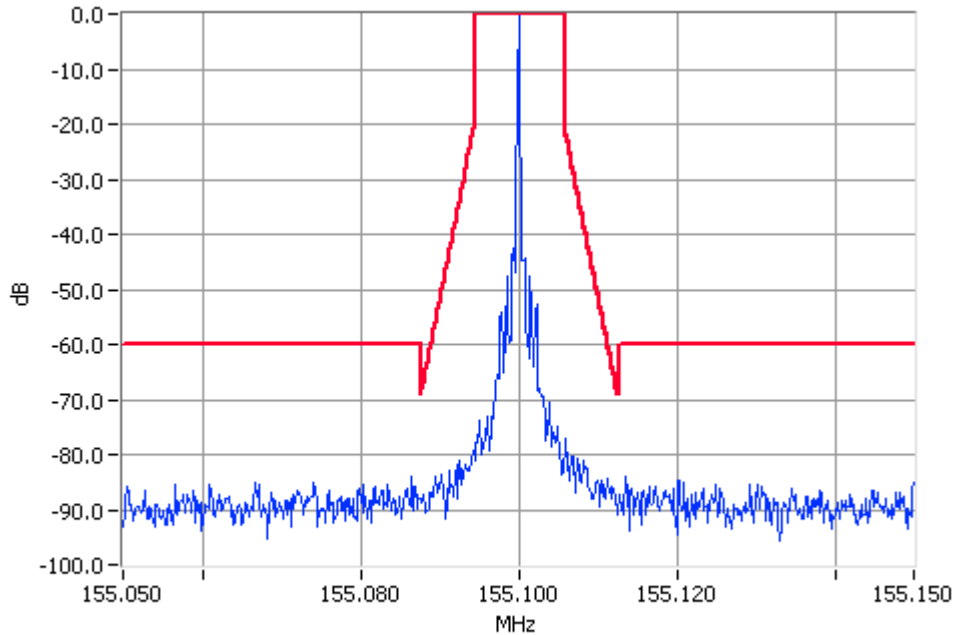

Unmodulated 155.1000MHz Mask D 10W Pass
RBW=100Hz VBW=1000Hz

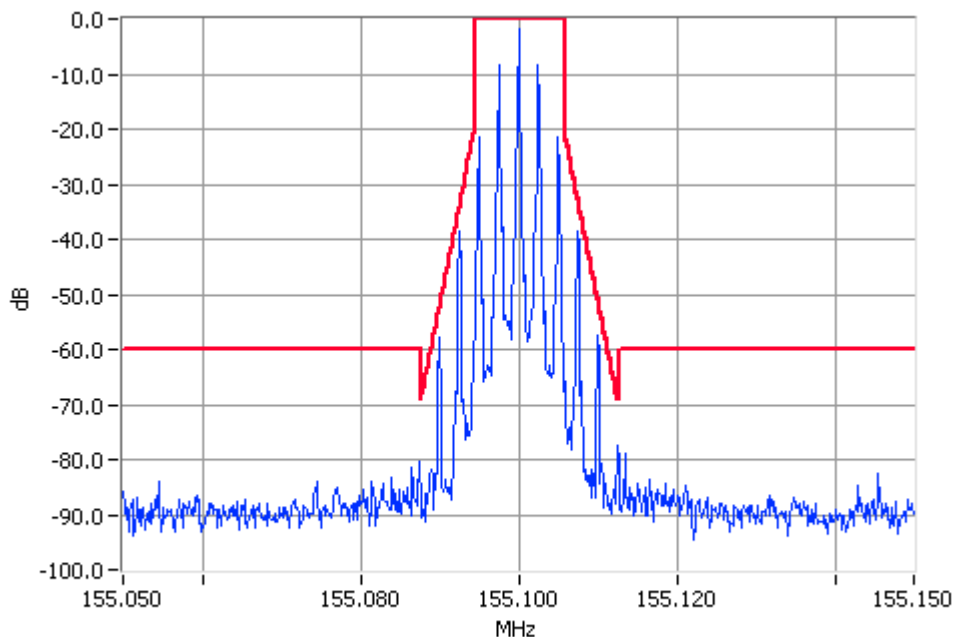

Analogue Modulation 155.1000MHz Mask D 10W
Pass

OCCUPIED BANDWIDTH

ANALOGUE VOICE

SPECIFICATION: FCC CFR 2.1049 (c)

Tx FREQUENCY: 155.1 MHz 50 W 25.0 kHz Channel Spacing

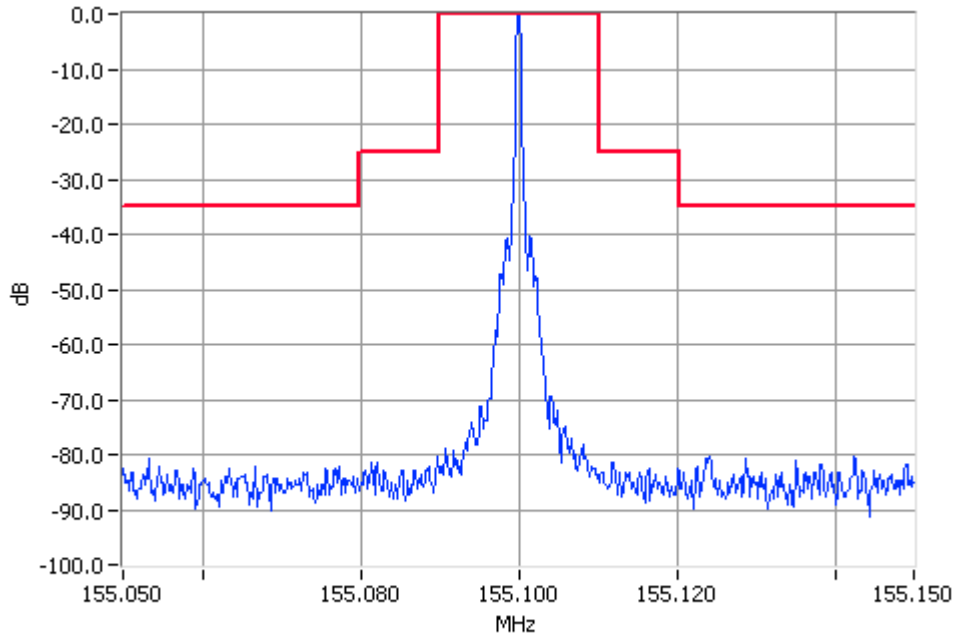

Unmodulated 155.1000MHz Mask B 50W Pass
RBW=300Hz VBW=3000Hz

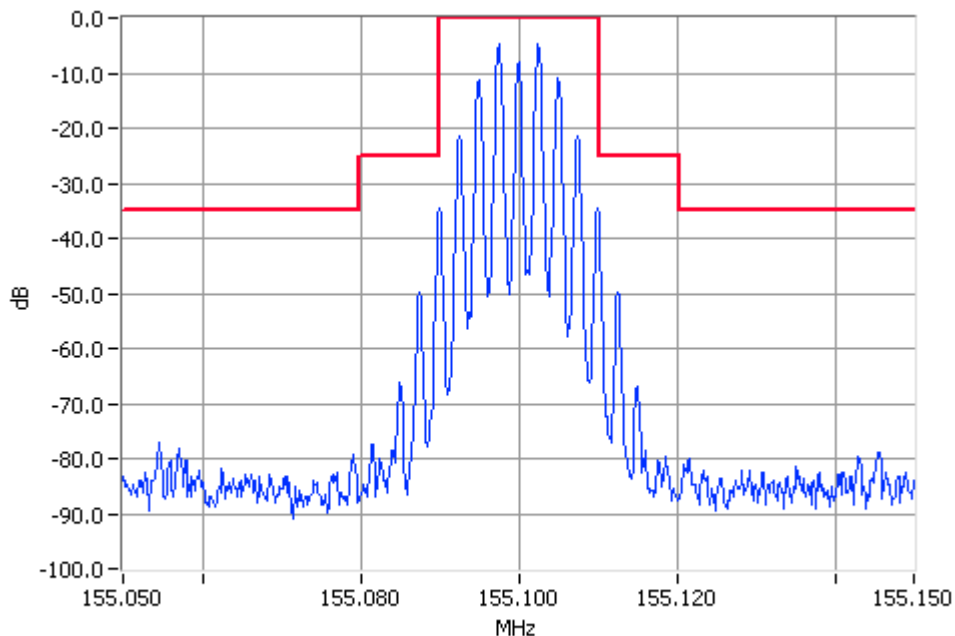

Analogue Modulation 155.1000MHz Mask B 50W
Pass

OCCUPIED BANDWIDTH

ANALOGUE VOICE

SPECIFICATION: FCC CFR 2.1049 (c)

Tx FREQUENCY: 155.1 MHz 10 W 25.0 kHz Channel Spacing

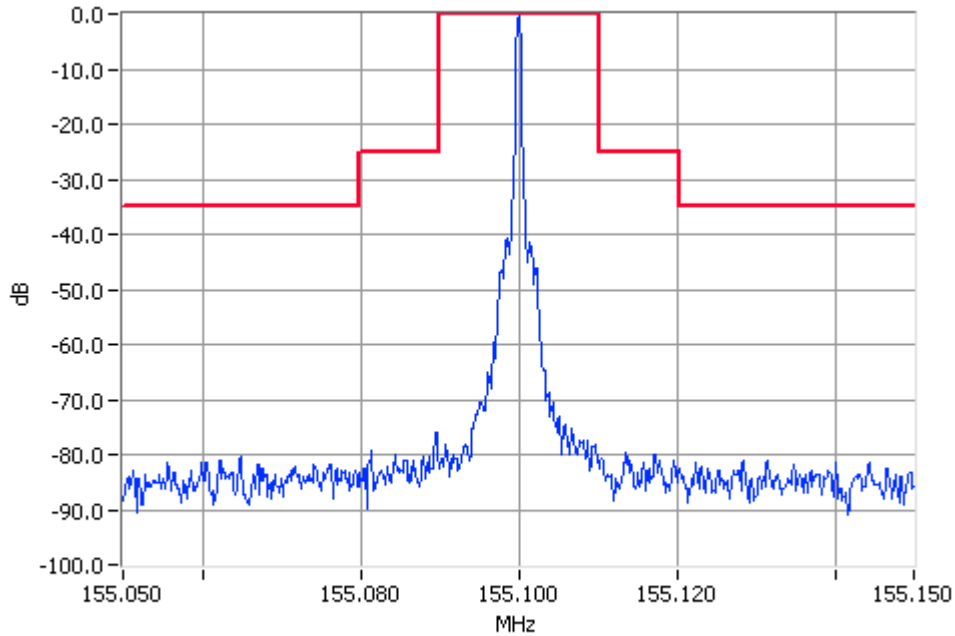

Unmodulated 155.1000MHz Mask B 10W Pass
RBW=300Hz VBW=3000Hz

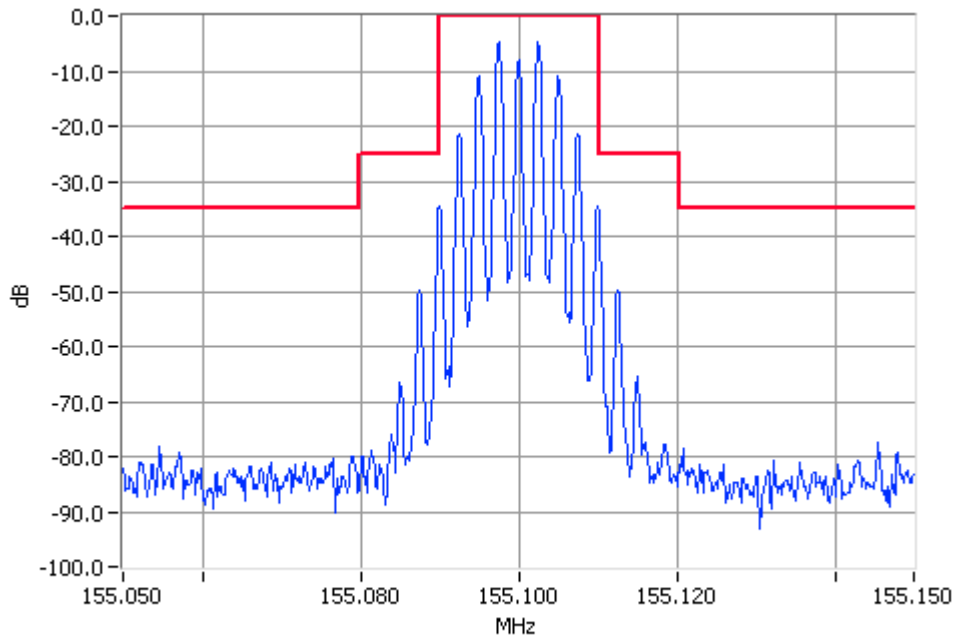

Analogue Modulation 155.1000MHz Mask B 10W
Pass

OCCUPIED BANDWIDTH

FFSK

SPECIFICATION: FCC CFR 2.1049 (c)

Tx FREQUENCY: 155.1 MHz 50 W 12.5 kHz Channel Spacing

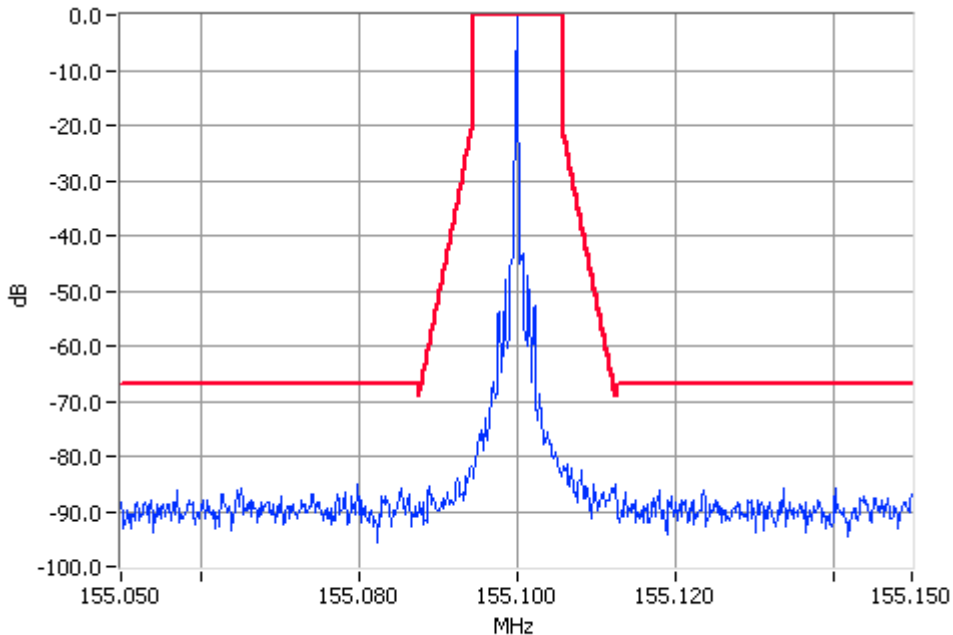

Unmodulated 155.1000MHz Mask D 50W Pass
RBW=100Hz VBW=1000Hz

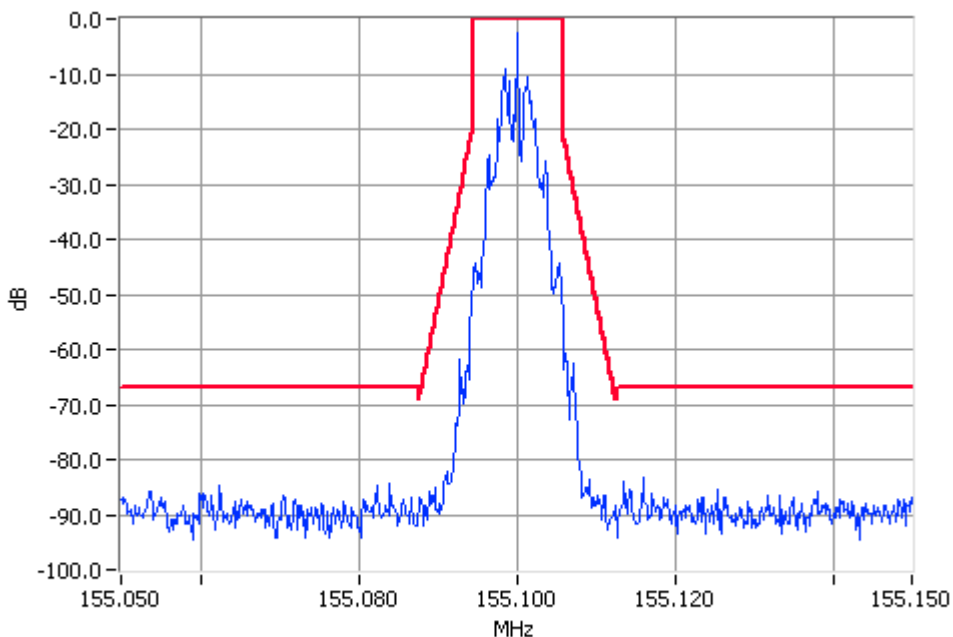

Digital Modulation 155.1000MHz Mask D 50W Pass
RBW=100Hz VBW=1000Hz

OCCUPIED BANDWIDTH

FFSK

SPECIFICATION: FCC CFR 2.1049 (c)

Tx FREQUENCY: 155.1 MHz 10 W 12.5 kHz Channel Spacing

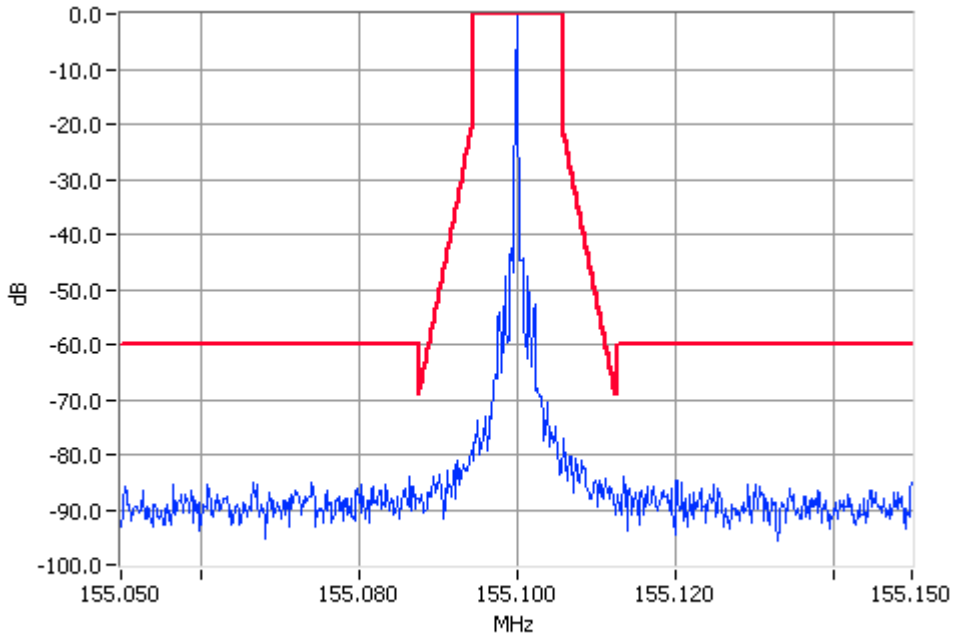

Unmodulated 155.1000MHz Mask D 10W Pass
RBW=100Hz VBW=1000Hz

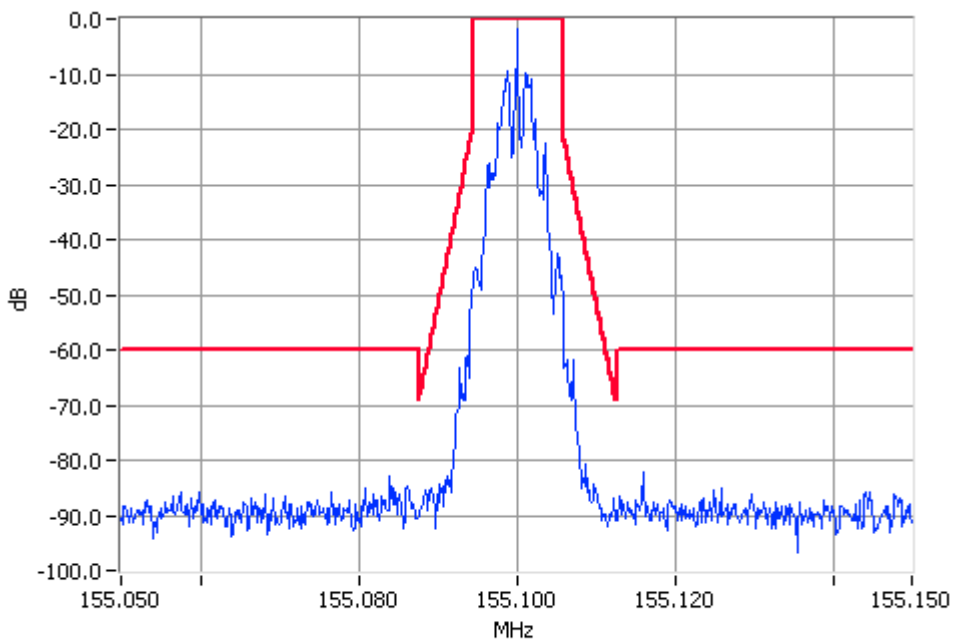

Digital Modulation 155.1000MHz Mask D 10W Pass
RBW=100Hz VBW=1000Hz

OCCUPIED BANDWIDTH

FFSK

SPECIFICATION: FCC CFR 2.1049 (c)

Tx FREQUENCY: 155.1 MHz 50 W 25.0 kHz Channel Spacing

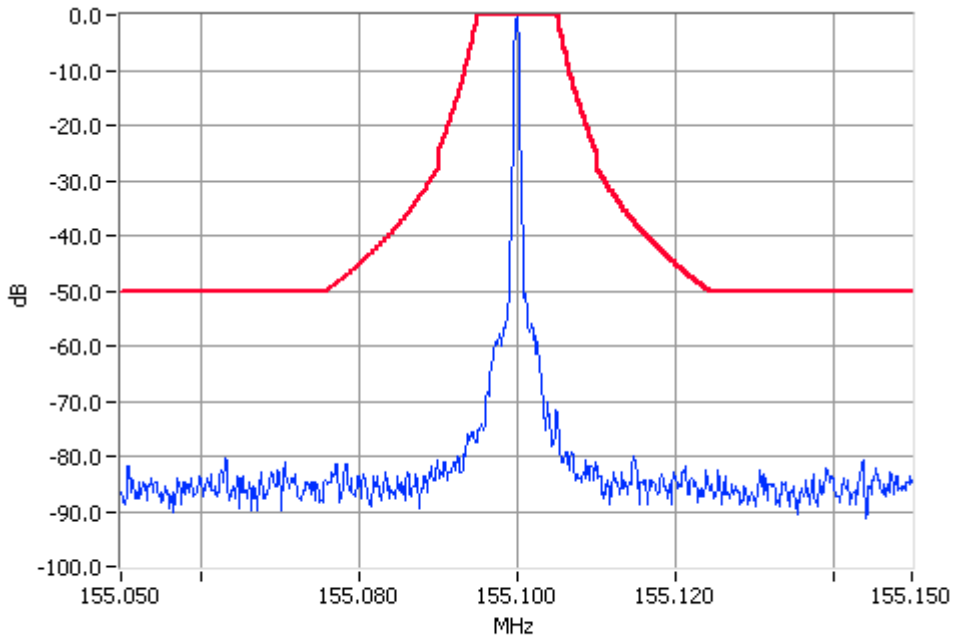

Unmodulated 155.1000MHz Mask C 50W Pass
RBW=300Hz VBW=3000Hz

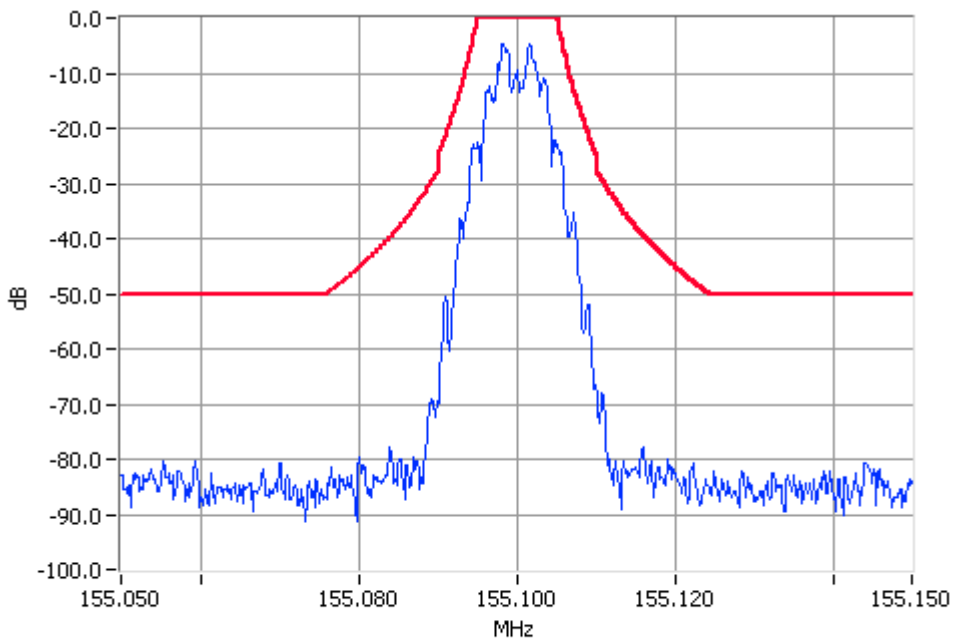

Digital Modulation 155.1000MHz Mask C 50W Pass
RBW=300Hz VBW=3000Hz

OCCUPIED BANDWIDTH

FFSK

SPECIFICATION: FCC CFR 2.1049 (c)

Tx FREQUENCY: 155.1 MHz 10 W 25.0 kHz Channel Spacing

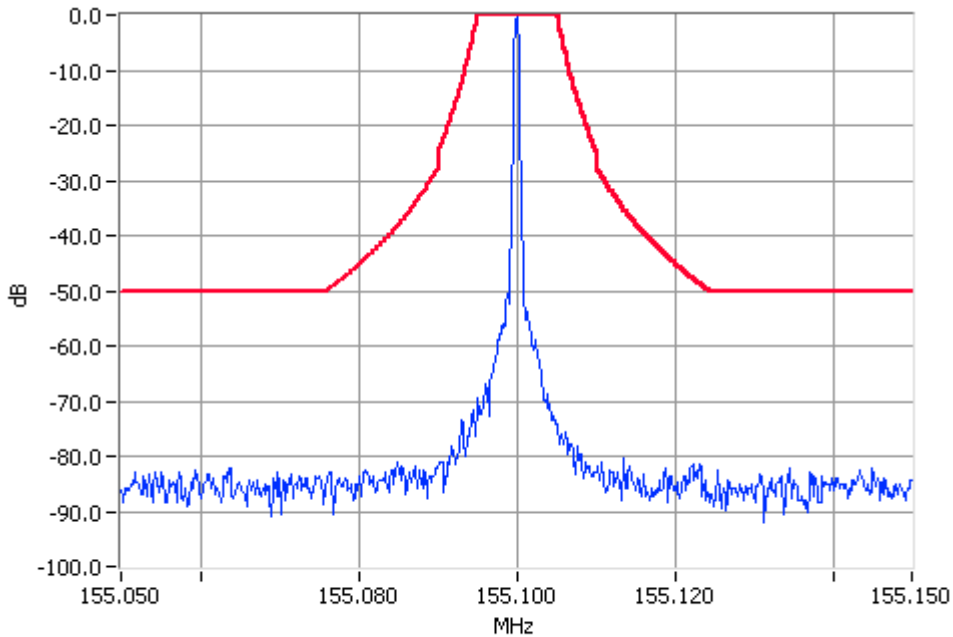

Unmodulated 155.1000MHz Mask C 10W Pass
RBW=300Hz VBW=3000Hz

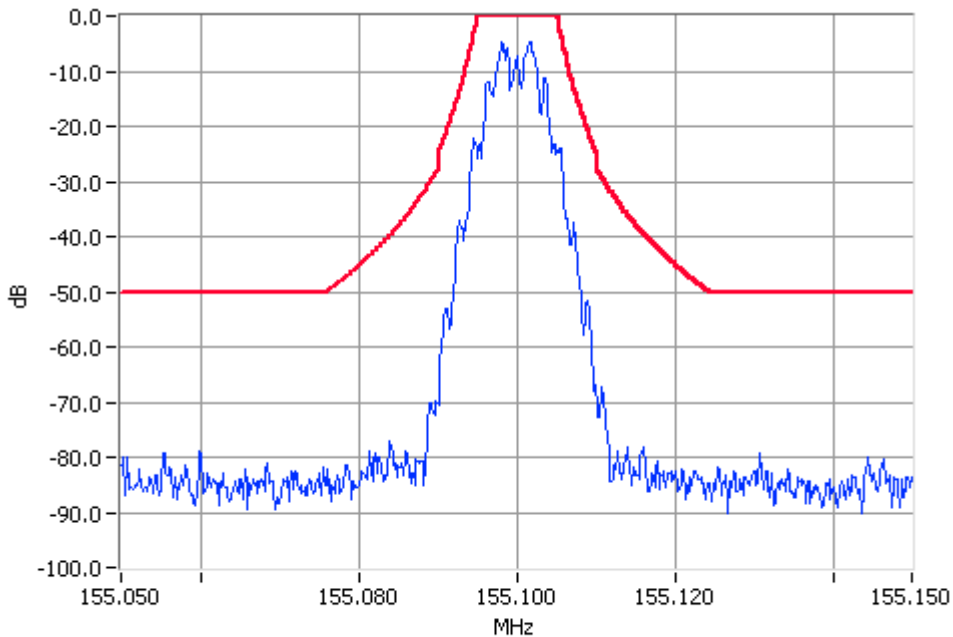

Digital Modulation 155.1000MHz Mask C 10W Pass
RBW=300Hz VBW=3000Hz

OCCUPIED BANDWIDTH

THSD

SPECIFICATION: FCC CFR 2.1049 (c)

Tx FREQUENCY: 155.1 MHz 50 W 12.5 kHz Channel Spacing

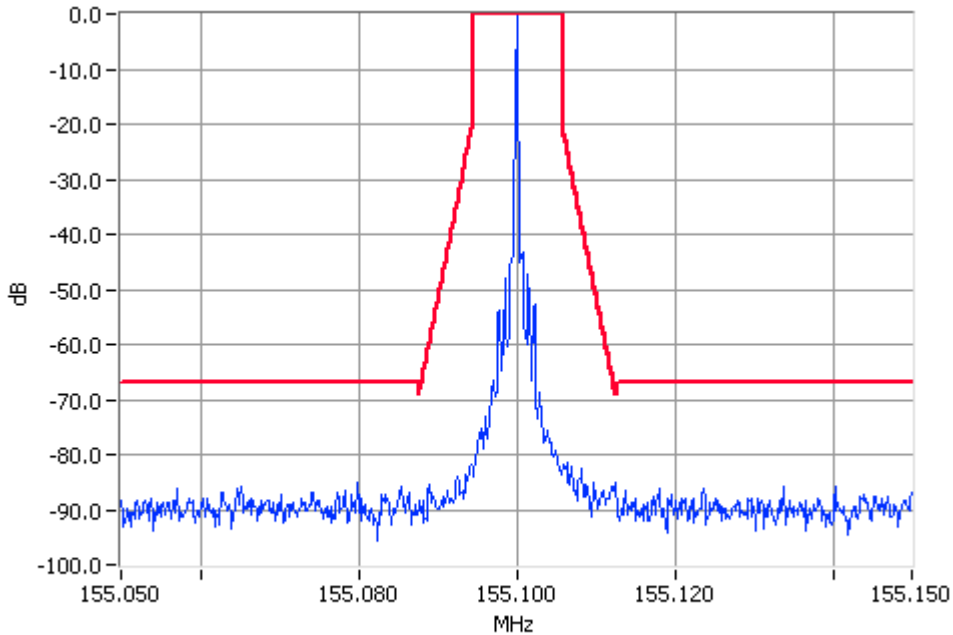

Unmodulated 155.1000MHz Mask D 50W Pass
RBW=100Hz VBW=1000Hz

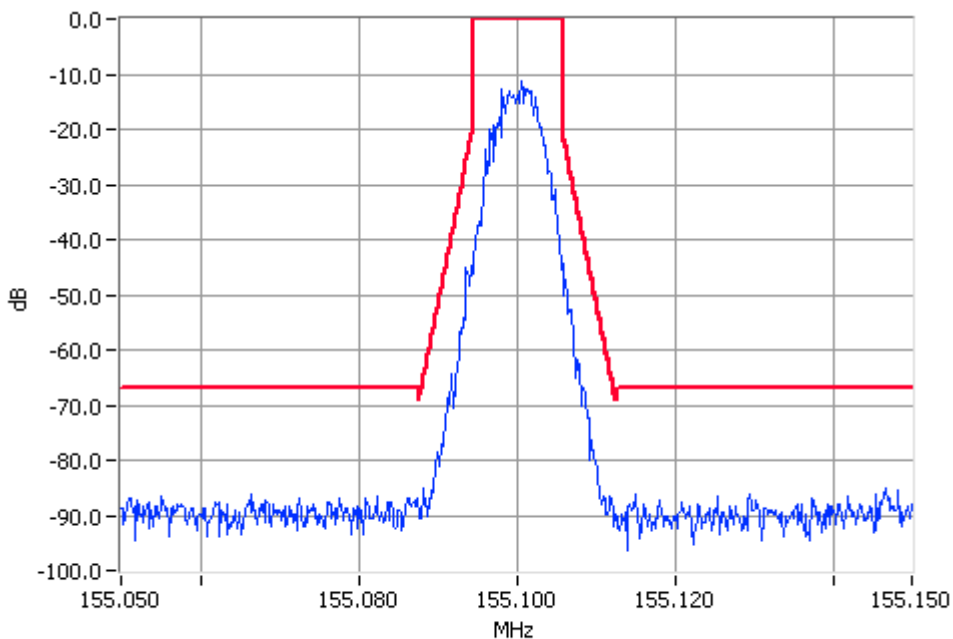

Digital Modulation 155.1000MHz Mask D 50W Pass
RBW=100Hz VBW=1000Hz

OCCUPIED BANDWIDTH

THSD

SPECIFICATION: FCC CFR 2.1049 (c)

Tx FREQUENCY: 155.1 MHz 10 W 12.5 kHz Channel Spacing

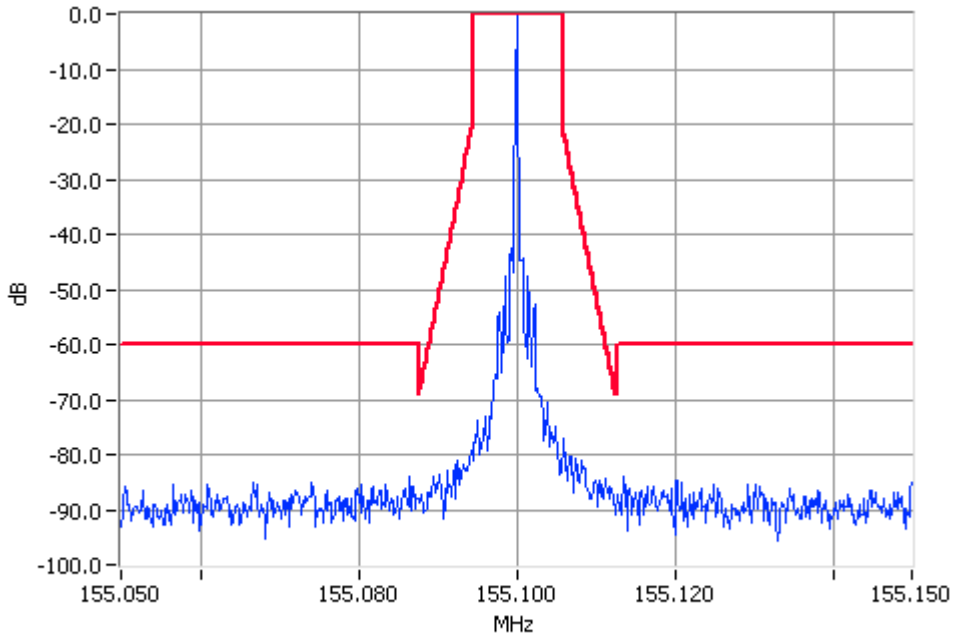

Unmodulated 155.1000MHz Mask D 10W Pass
RBW=100Hz VBW=1000Hz

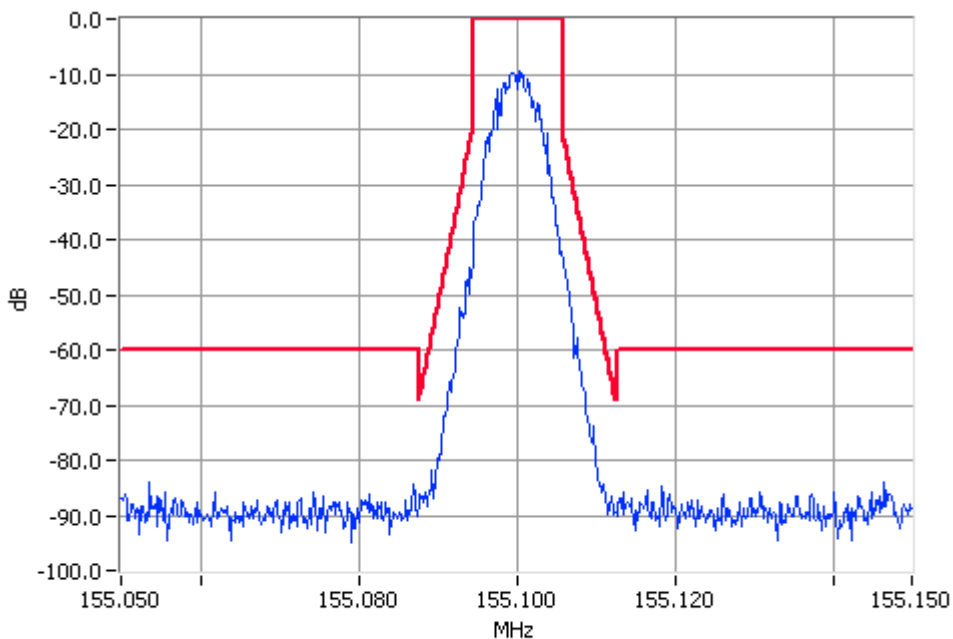

Digital Modulation 155.1000MHz Mask D 10W Pass
RBW=100Hz VBW=1000Hz

OCCUPIED BANDWIDTH

THSD

SPECIFICATION: FCC CFR 2.1049 (c)

Tx FREQUENCY: 155.1 MHz 50 W 25.0 kHz Channel Spacing

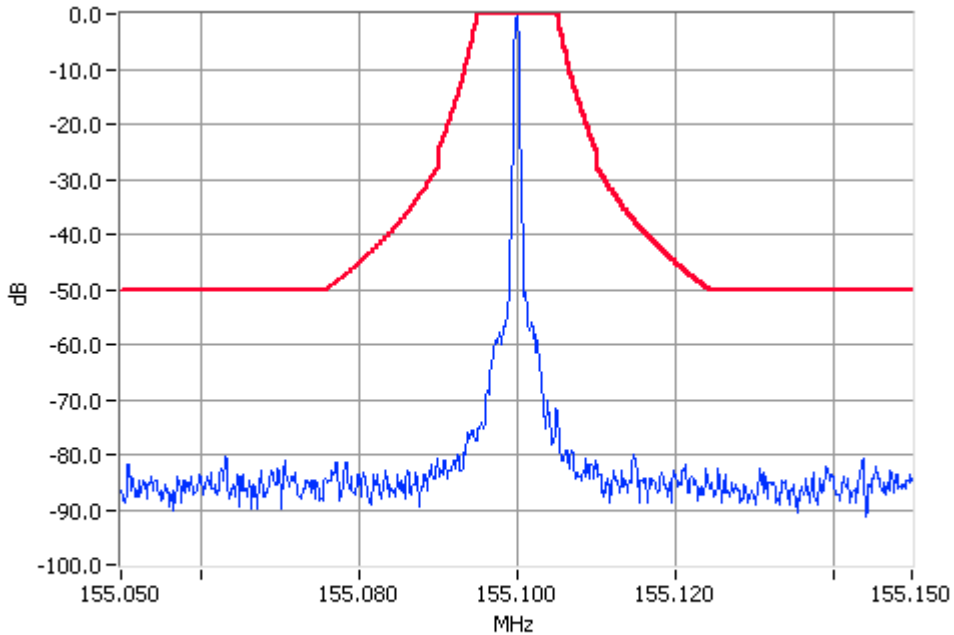

Unmodulated 155.1000MHz Mask C 50W Pass
RBW=300Hz VBW=3000Hz

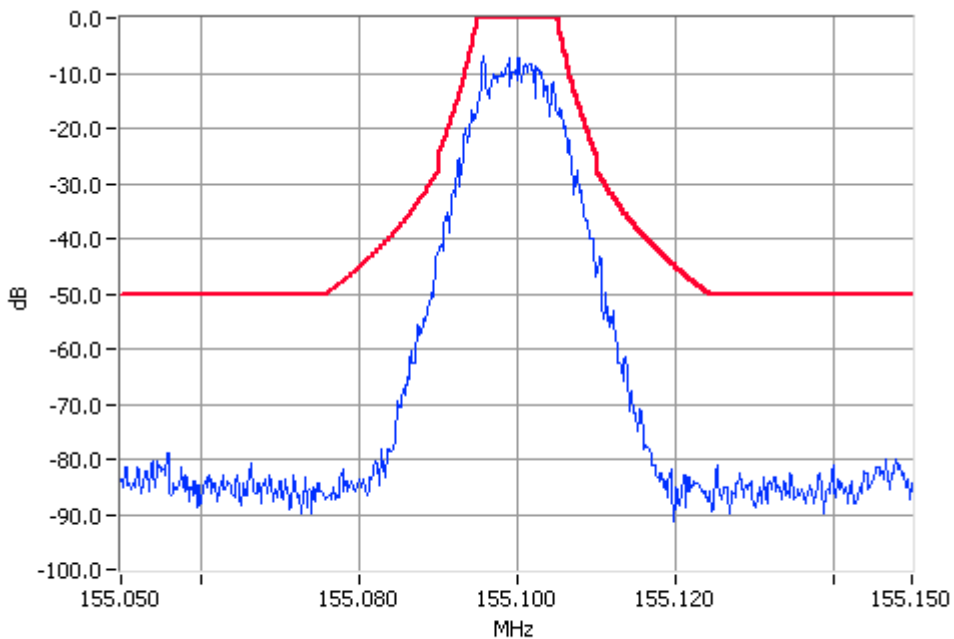

Digital Modulation 155.1000MHz Mask C 50W Pass
RBW=300Hz VBW=3000Hz

OCCUPIED BANDWIDTH

THSD

SPECIFICATION: FCC CFR 2.1049 (c)

Tx FREQUENCY: 155.1 MHz 10 W 25.0 kHz Channel Spacing

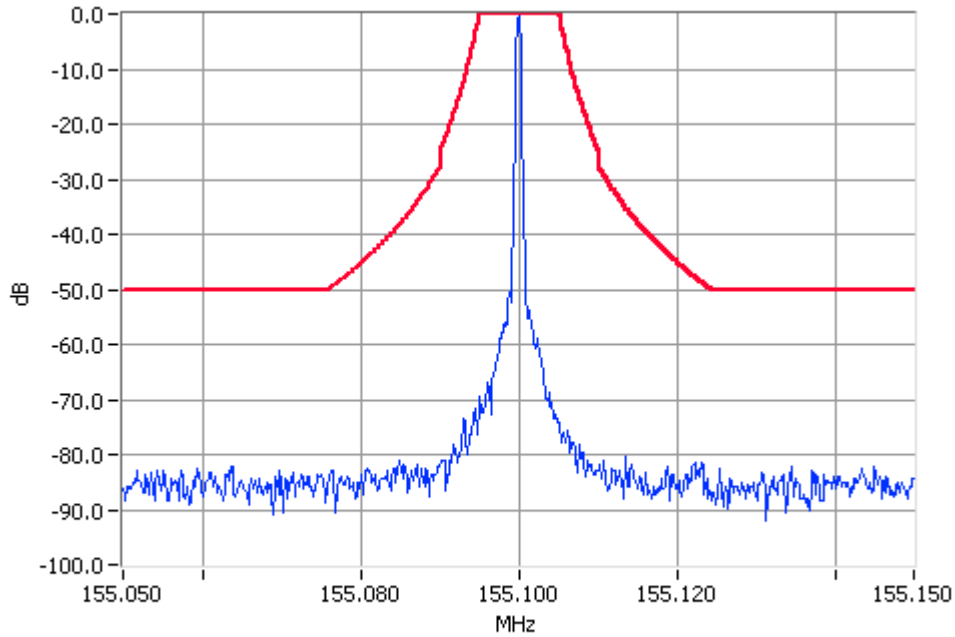

Unmodulated 155.1000MHz Mask C 10W Pass
RBW=300Hz VBW=3000Hz

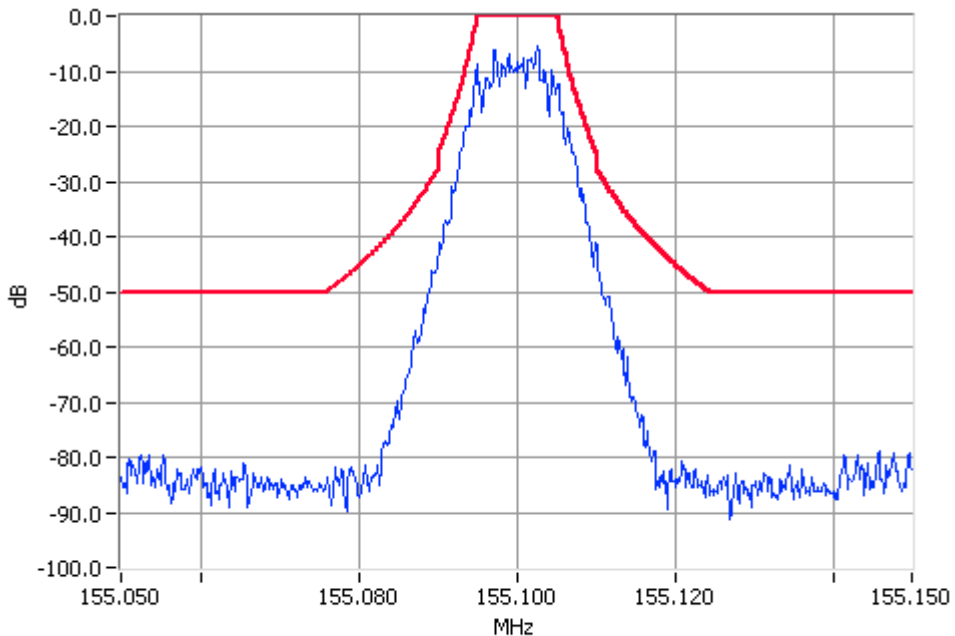

Digital Modulation 155.1000MHz Mask C 10W Pass
RBW=300Hz VBW=3000Hz

OCCUPIED BANDWIDTH

Digital (4-level FSK)

SPECIFICATION: FCC CFR 2.1049 (c)

Tx FREQUENCY: 155.1 MHz 50 W 12.5 kHz Channel Spacing

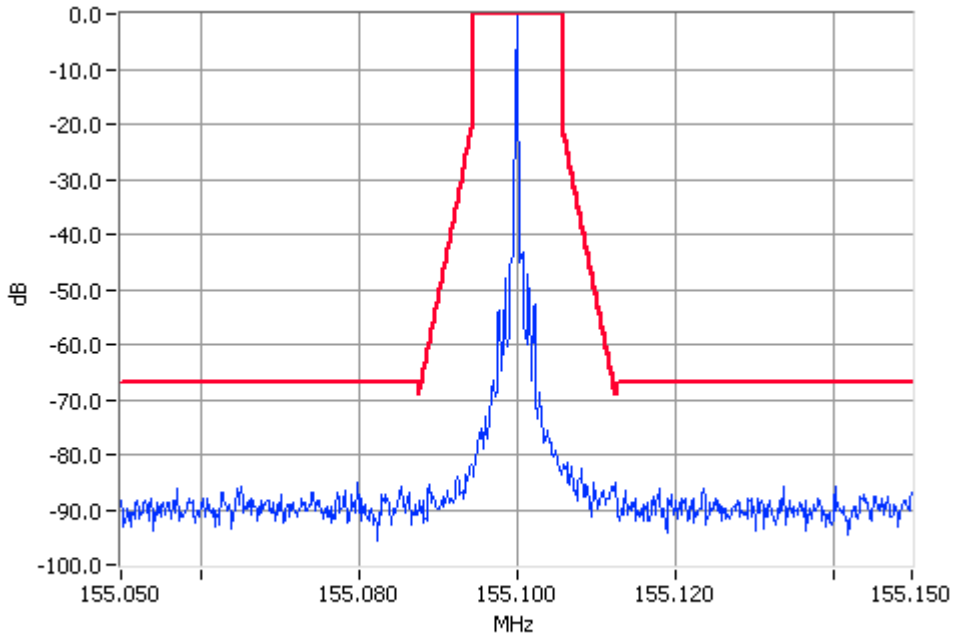

Unmodulated 155.1000MHz Mask D 50W Pass
RBW=100Hz VBW=1000Hz

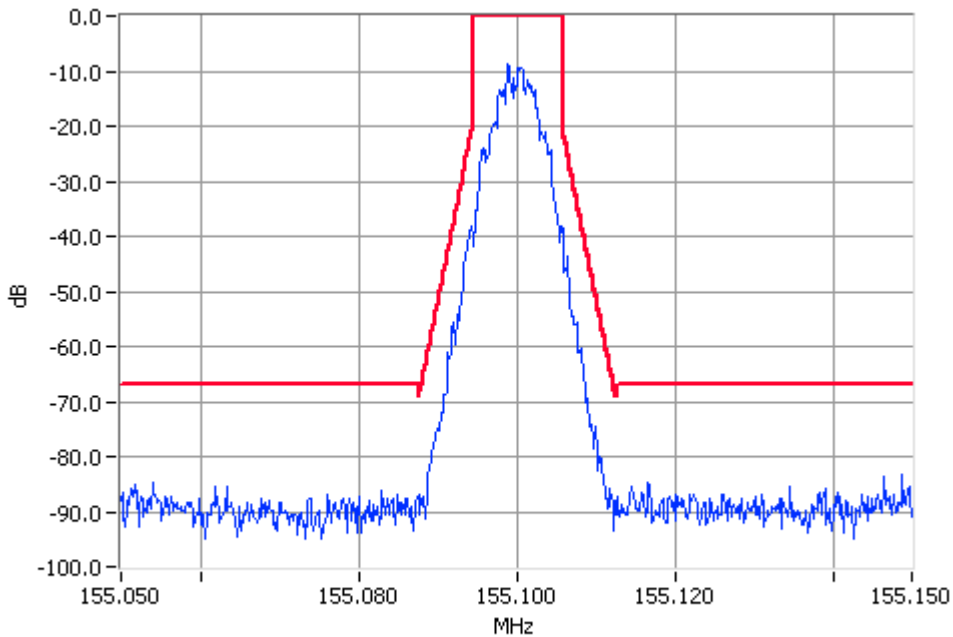

Digital Modulation 155.1000MHz Mask D 50W Pass
RBW=100Hz VBW=1000Hz

OCCUPIED BANDWIDTH

Digital (4-level FSK)

SPECIFICATION: FCC CFR 2.1049 (c)

Tx FREQUENCY: 155.1 MHz 10 W 12.5 kHz Channel Spacing

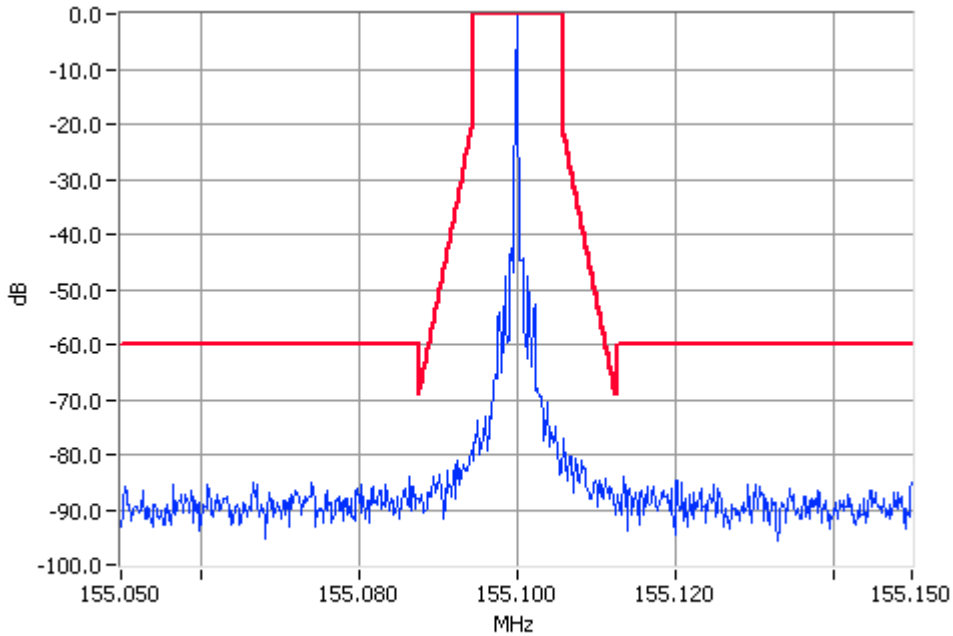

Unmodulated 155.1000MHz Mask D 10W Pass
RBW=100Hz VBW=1000Hz

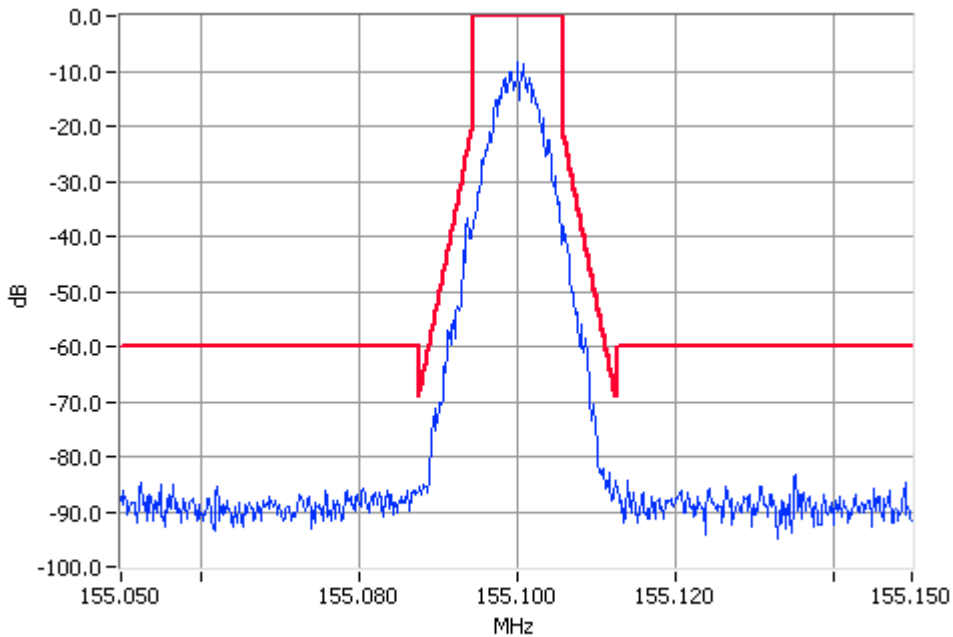

Digital Modulation 155.1000MHz Mask D 10W Pass
RBW=100Hz VBW=1000Hz

OCCUPIED BANDWIDTH

Digital (4-level FSK)

SPECIFICATION: FCC CFR 2.1049 (c)

Tx FREQUENCY: 155.1 MHz 50 W 25.0 kHz Channel Spacing

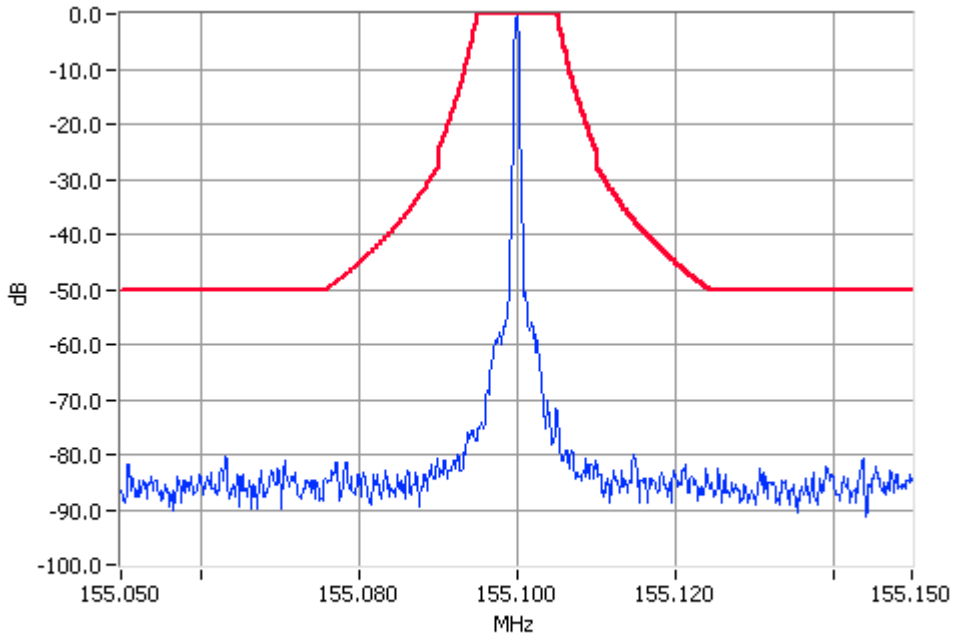

Unmodulated 155.1000MHz Mask C 50W Pass
RBW=300Hz VBW=3000Hz

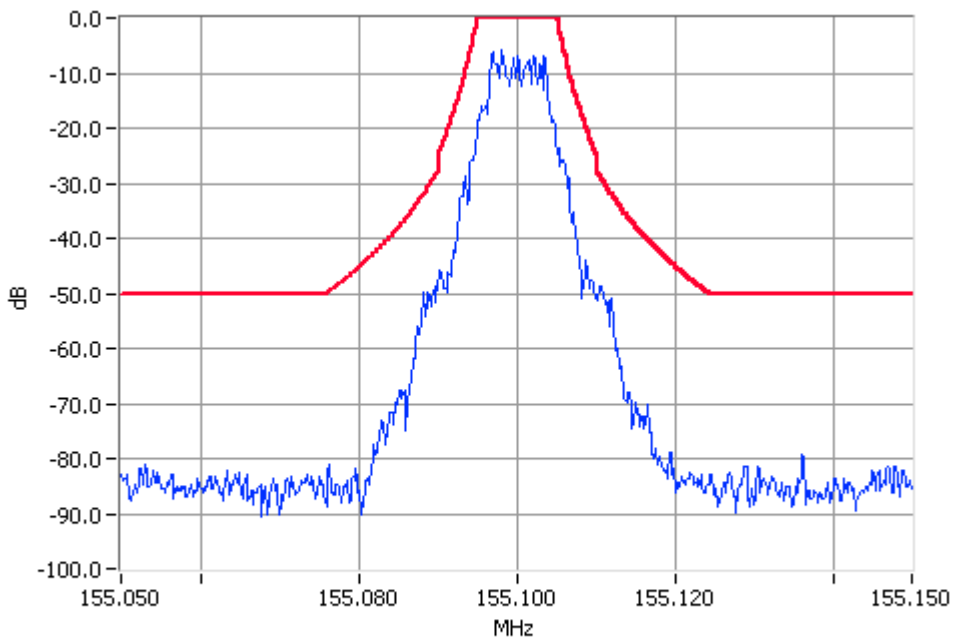

Digital Modulation 155.1000MHz Mask C 50W Pass
RBW=300Hz VBW=3000Hz

OCCUPIED BANDWIDTH

Digital (4-level FSK)

SPECIFICATION: FCC CFR 2.1049 (c)

Tx FREQUENCY: 155.1 MHz 10 W 25.0 kHz Channel Spacing

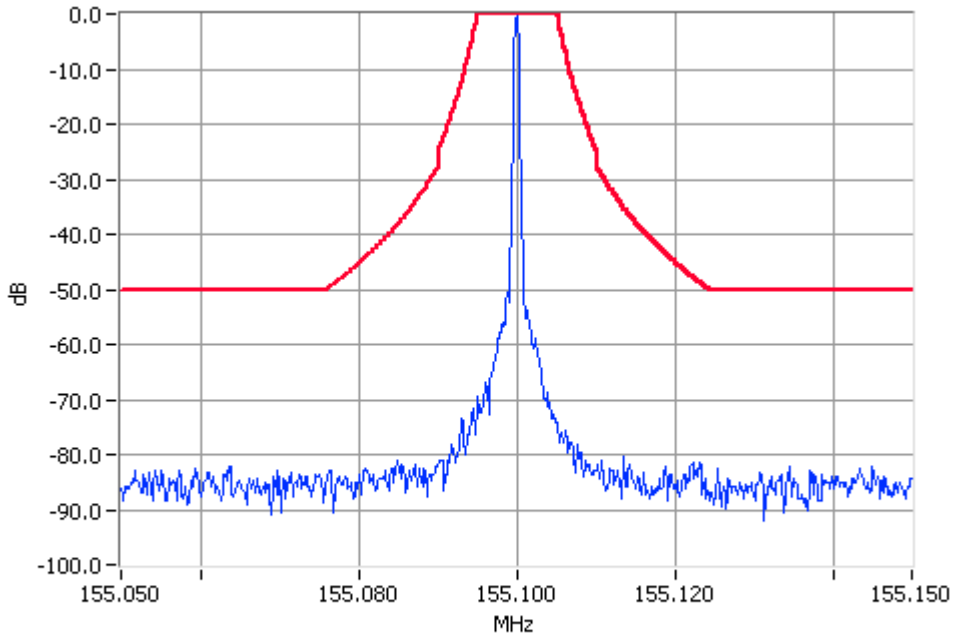

Unmodulated 155.1000MHz Mask C 10W Pass
RBW=300Hz VBW=3000Hz

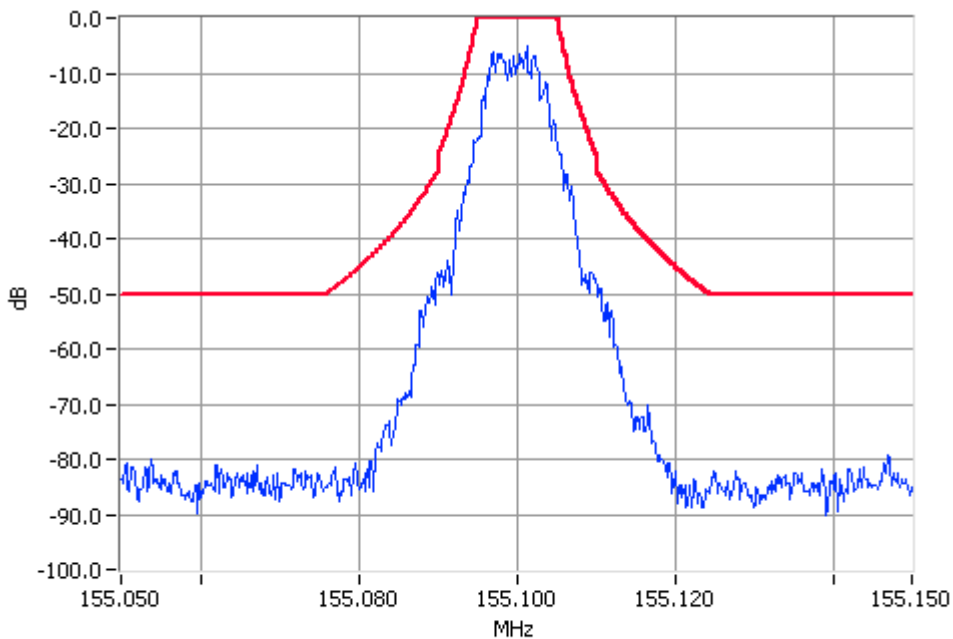

Digital Modulation 155.1000MHz Mask C 10W Pass
RBW=300Hz VBW=3000Hz

SPURIOUS EMISSIONS (RADIATED)

SPECIFICATION: FCC 47 CFR 2.1053

GUIDE: TIA/EIA-603B 2.2.12

MEASUREMENT PROCEDURE:

1. Refer Appendix A for equipment set up.
2. The EUT was placed on a wooden turntable at a distance of three metres from the test antenna. The output terminal was connected to an RF dummy load.
3. The turntable was rotated through 360° to obtain the maximum response of each spurious emission. Valid emissions were determined by switching the EUT on and off.
4. The EUT was replaced by a signal generator and substitution antenna to make measurements by the substitution method.

MEASUREMENT RESULTS:

See the tables on the following pages

LIMIT CLAUSE: FCC 47 CFR 90.210

TRANSMITTER FREQUENCY STABILITY (TEMPERATURE)

SPECIFICATION: FCC 47 CFR 2.1055 (a) (1)

GUIDE: TIA/EIA-603B 2.2.2

MEASUREMENT PROCEDURE:

1. Refer Appendix A for equipment set up.
2. The EUT was tested for frequency error from -30°C to $+50^{\circ}\text{C}$ in 10°C increments
3. The frequency error was recorded in parts per million (ppm).

MEASUREMENT RESULTS:

See the plots on the following pages for 12.5 kHz & 25.0 kHz channel spacings.

LIMIT CLAUSE: FCC 47 CFR 90.213

Frequency Range: 150 MHz to 174 MHz

Channel Spacing (kHz)	Frequency Error (ppm)
12.5	5.0
25.0	5.0

TRANSMITTER FREQUENCY STABILITY (TEMPERATURE)

SPECIFICATION: FCC 47 CFR 2.1055 (a) (1)

Tx FREQUENCY: 155.1 MHz 50 W 12.5 kHz channel Spacing

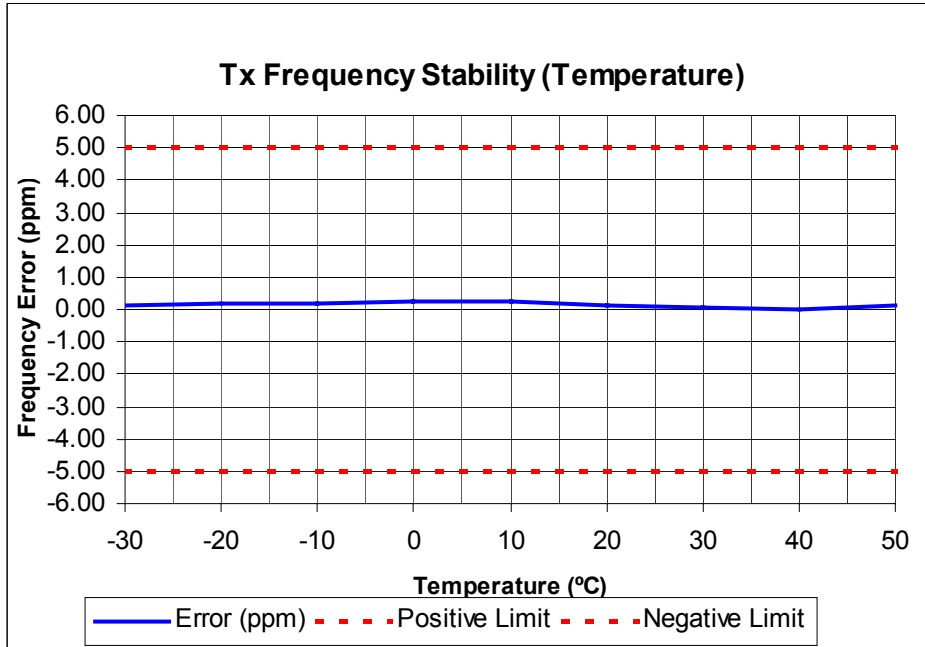

Tx FREQUENCY: 155.1 MHz 50 W 25.0 kHz channel Spacing

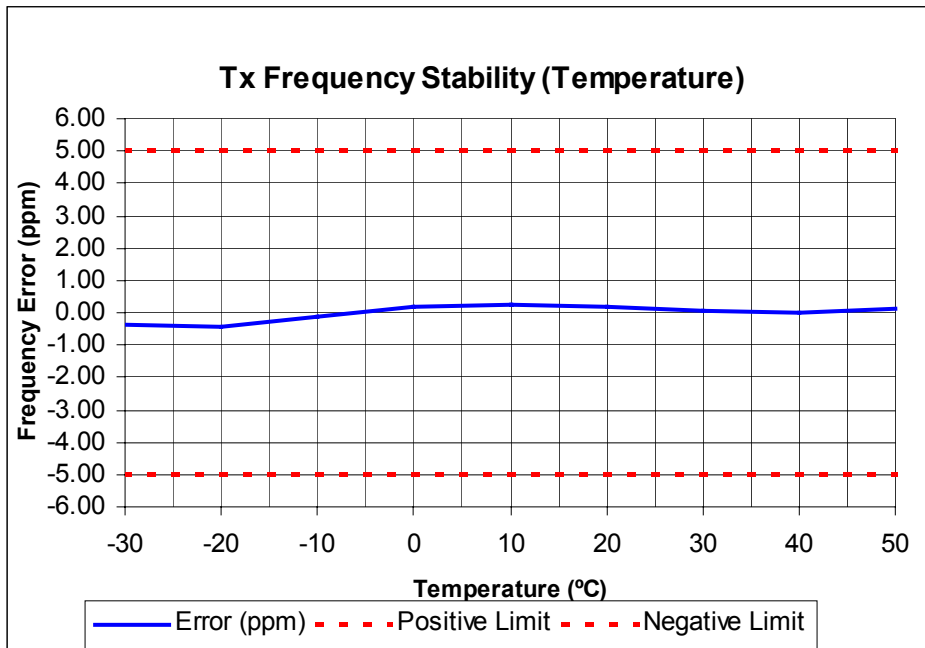

TRANSMITTER FREQUENCY STABILITY (VOLTAGE)

SPECIFICATION: FCC 47 CFR 2.1055 (d) (1)

GUIDE: TIA/EIA-603B 2.2.2

MEASUREMENT PROCEDURE:

1. Refer Appendix A for equipment set up.
2. The EUT was tested for frequency error at an input voltage to the radio of 85% to 115%.
3. The frequency error was recorded in parts per million (ppm).

MEASUREMENT RESULTS: Frequency Range: 150 MHz to 174 MHz

Channel Spacing (kHz)	FREQUENCY ERROR (ppm) @ 155.1 MHz		
	11.7 V DC	13.8 V DC	15.9 V DC
12.5	0.06	0.05	0.07
25.0	0.04	0.05	0.05

LIMIT CLAUSE: FCC 47 CFR 90.213

Channel Spacing (kHz)	Frequency Error (ppm)
12.5	5.0
25.0	5.0

TRANSIENT FREQUENCY BEHAVIOR

SPECIFICATION: FCC 47 CFR 90.214

GUIDE: TIA/EIA-603B 2.2.19

MEASUREMENT PROCEDURE:

1. Refer Appendix A for equipment set up.
2. Measurements and plots were made following the TIA/EIA procedure.

MEASUREMENT RESULTS:

See the tables and plots on the following pages for 12.5 kHz & 25.0 kHz channel spacings.

LIMIT CLAUSE: FCC 47 CFR 90.214

TRANSIENT FREQUENCY BEHAVIOUR

SPECIFICATION: FCC 47 CFR 90.214

Tx FREQUENCY: 155.1 MHz 50 W 12.5 kHz Channel Spacing

FREQUENCY	155.1 MHz @ 50 W Tx	
TRANSIENT RESPONSE PERIOD	CARRIER PEAK VARIATION FROM NORMAL	
	Key ON (kHz)	Key OFF (kHz)
t_1	0.6	N/A
t_2	0.6	N/A
t_3	N/A	0.6
$t_2 \rightarrow t_3$ ppm	3.6	
ERROR LIMIT ($t_2 \rightarrow t_3$) ppm	5.0	

Confirm that during periods t_1 and t_3 the frequency difference does not exceed the value of one channel separation.	YES	NO
	Y	
Confirm that during the period t_2 the frequency difference does not exceed half a channel separation.	YES	NO
	Y	
Confirm that during the period t_2 to t_3 the frequency difference does not exceed the frequency error limit.	YES	NO
	Y	

LIMIT:

TRANSIENT PERIODS	FREQUENCY RANGE 150MHz – 174 MHz	FREQUENCY RANGE 421MHz – 512 MHz
t_1 (ms)	5 ms	10 ms
t_2 (ms)	20 ms	25 ms
t_3 (ms)	5 ms	10 ms

TRANSIENT FREQUENCY BEHAVIOUR

SPECIFICATION: FCC 47 CFR 90.214

Tx FREQUENCY: 155.1 MHz 50 W 12.5 kHz Channel Spacing

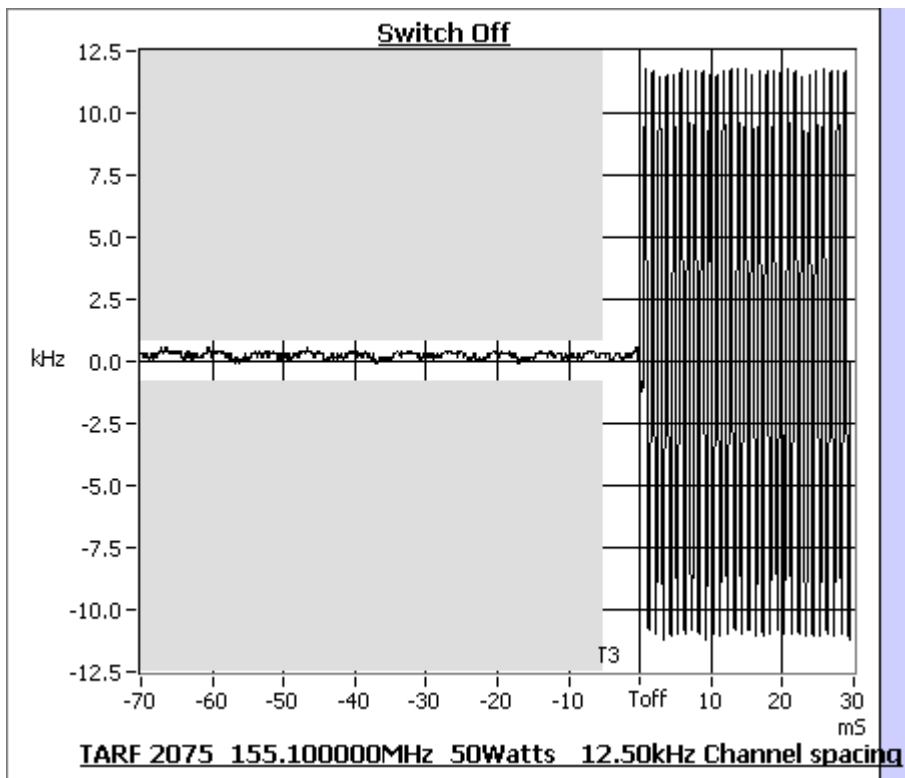
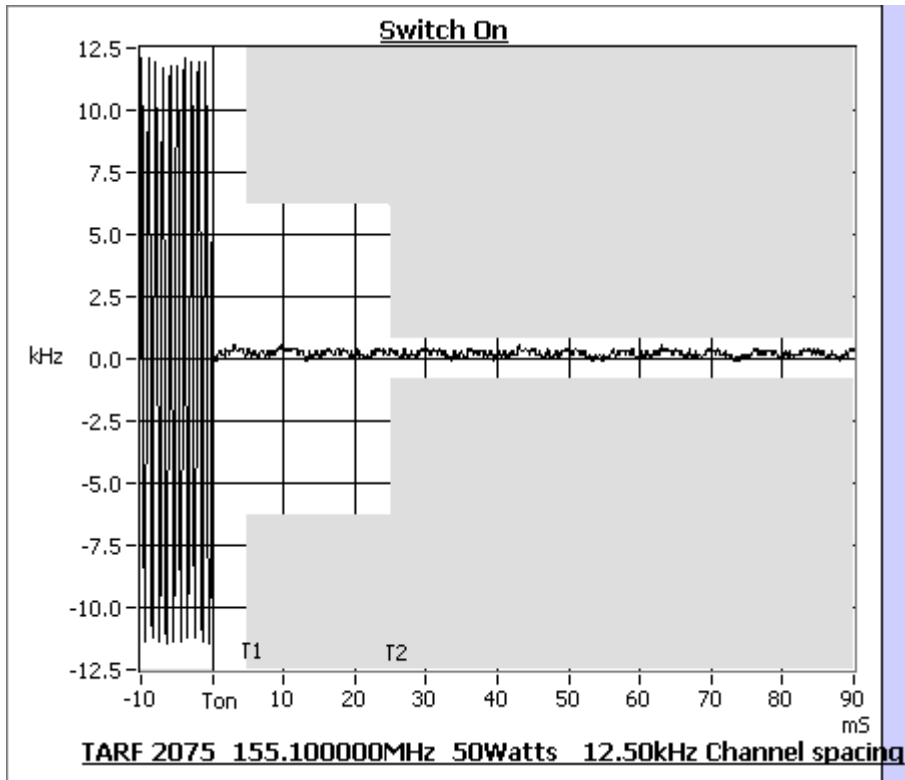

TRANSIENT FREQUENCY BEHAVIOUR

SPECIFICATION: FCC 47 CFR 90.214

Tx FREQUENCY: 155.1 MHz 50 W 25.0 kHz Channel Spacing

FREQUENCY	155.1 MHz @ 50 W Tx	
TRANSIENT RESPONSE PERIOD	CARRIER PEAK VARIATION FROM NORMAL	
	Key ON (kHz)	Key OFF (kHz)
t ₁	1.6	N/A
t ₂	0.6	N/A
t ₃	N/A	0.6
t ₂ → t ₃ ppm	3.6	
ERROR LIMIT (t ₂ → t ₃) ppm	5.0	

Confirm that during periods t ₁ and t ₃ the frequency difference does not exceed the value of one channel separation.	YES	NO
	Y	
Confirm that during the period t ₂ the frequency difference does not exceed half a channel separation.	YES	NO
	Y	
Confirm that during the period t ₂ to t ₃ the frequency difference does not exceed the frequency error limit.	YES	NO
	Y	

LIMIT:

TRANSIENT PERIODS	FREQUENCY RANGE 150MHz – 174 MHz	FREQUENCY RANGE 421MHz – 512 MHz
t ₁ (ms)	5 ms	10 ms
t ₂ (ms)	20 ms	25 ms
t ₃ (ms)	5 ms	10 ms

TRANSIENT FREQUENCY BEHAVIOUR

SPECIFICATION: FCC 47 CFR 90.214

Tx FREQUENCY: 155.1 MHz 50 W 25.0 kHz Channel Spacing

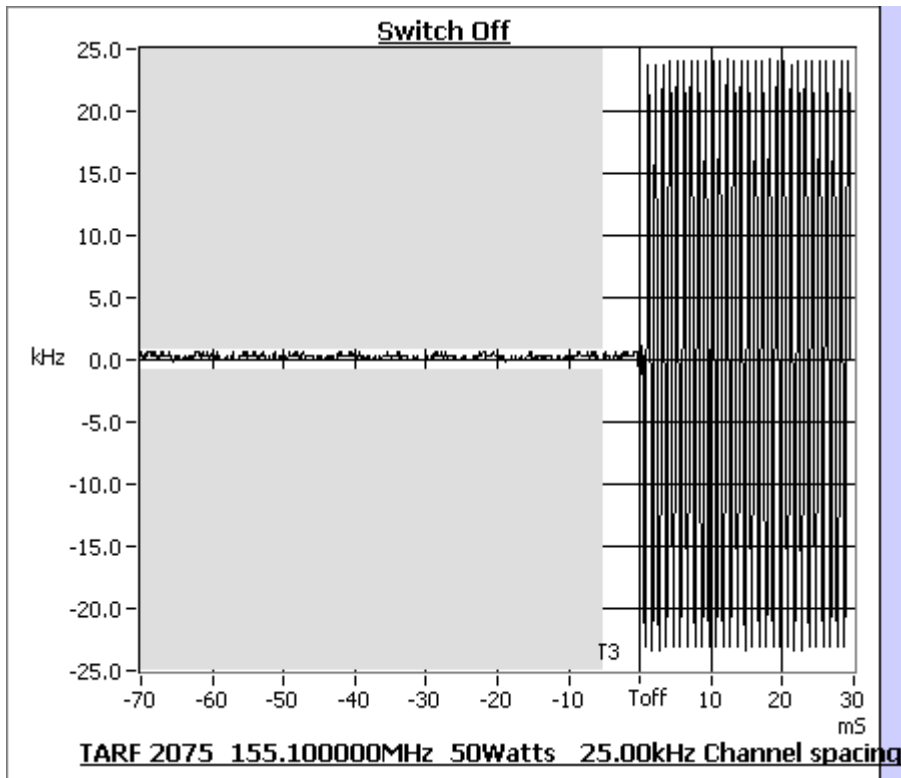
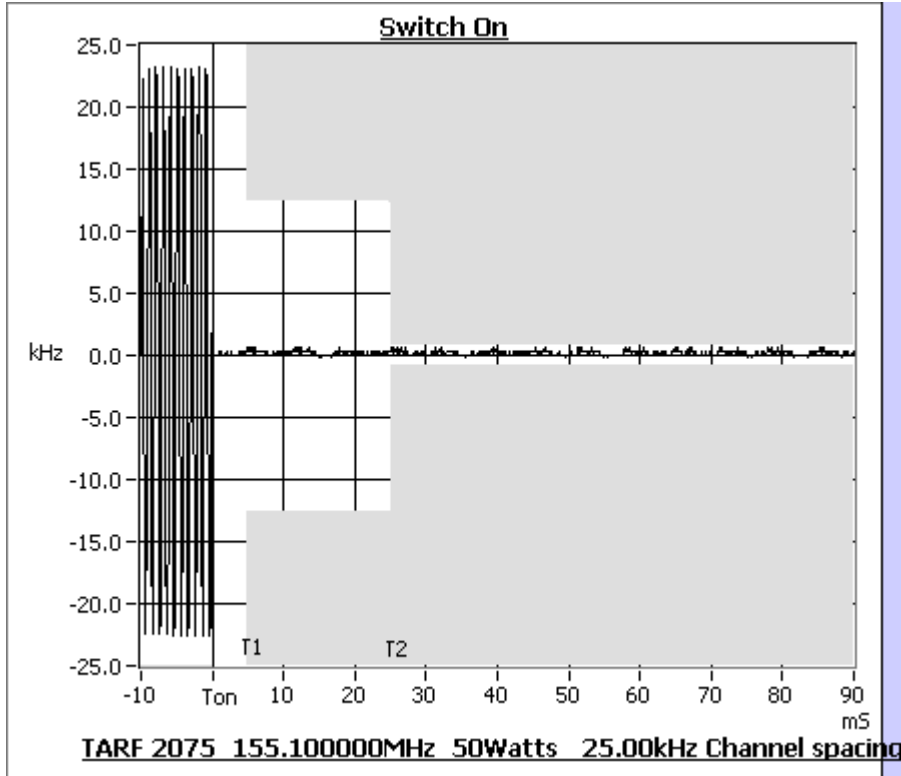

TEST EQUIPMENT USED

No#	Equipment	Manufacturer	Model No	Serial No#	Tait ID	Cal Due
1	Signal Generator	Hewlett Packard	HP8642B (Opt 001)	2512A00176	E3064	18-Feb-05
3	Signal Generator	Agilent	E4422B	GB40050320	E3788	22-Oct-04
14	Power Head	Hewlett Packard	HP11722A	2320A00688	E3307	15-Oct-04
20	Power Supply	Hewlett Packard	HP6032A	2441A-0041Z	E3075	15-Oct-04
21	Power Supply	Rohde & Schwarz	NGS M32/10 192.0810.31	Fnr 434	E3556	14-Jun-05
22	Oscilloscope	Tektronics	TDS340	B013611	E3585	25-Nov-04
24	Environ. Chamber	Contherm	Temp Control	E3397	E3397	04-Mar-05
40	Reference Dipoles	Emco	3121C DB1	9510-1164	E3559	17-Oct-06
41	Biconical Antenna	Emco	3110B	9307-1680	E3033	
43	Horn Antenna	Emco	DRG3115		E3076	27-Sep-06
62	RF Attenuator 150W	Weinschel	57-10-34	LB590	E3674	20-Jul-05
65	RF Attenuator 50W	Weinschel	24-20-44	AW1266	E3562	28-Jun-05
70	RF Load 150W	Bird			E3625	30-Oct-04
71	RF Load 50W	Weinschel	F1426	BF0487	E3675	09-Aug-05
72	RF Load 50W	Weinschel	F1426	AE2490	E3624	14-Jul-05
80	20m Coax Cable	Intelcom	RG214/U-50(Ext Cal)	CBL03	E3659	08-Sep-04
82	3m Coax Cable (BLUE)	Suhner	Sucoflex 104A	25033/4A	E3694	30-Oct-04
83	1m Coax Cable (BLUE)	Suhner	Sucoflex 104A	25006/4A	E3693	30-Oct-04
84	1m Coax Cable (BLUE)	Suhner	Sucoflex 104A	25005/4A	E3692	15-Jul-05
87	Audio Analyser	Hewlett Packard	HP8903B	2818A04275	E3710	25-Nov-04
88	Spectrum Analyser	Hewlett Packard	HP8562E	3821A00779	E3715	06-Jan-05
90	Power Supply	Hewlett Packard	HP6012B	2524A00616	E3712	21-Jul-05
100	Oscilloscope	Tektronics	TDS380	B017095	E3782	16-Oct-04
111	Modulation Analyser	Hewlett Packard	HP8901B (Opt 002)	3704A05837	E3786	15-Oct-04
114	Signal Generator	Rohde & Schwarz	SML03 1090.3000.13		E4050	28-Nov-04
115	Environ. Chamber	Contherm	5400 RHSLT.M		E4051	04-Mar-05
123	Spectrum Analyser	Agilent	E4445A	MY42510072	E4139	23-Apr-05
129	Antenna Tower	Electrometrics	EM-4720-2			
130	Controller	Electrometrics	EM-4700			
131	Turntable	Electrometrics	EM-4704A			

APPENDIX A

TEST SETUP DETAILS

Radiated Emissions Set Up.

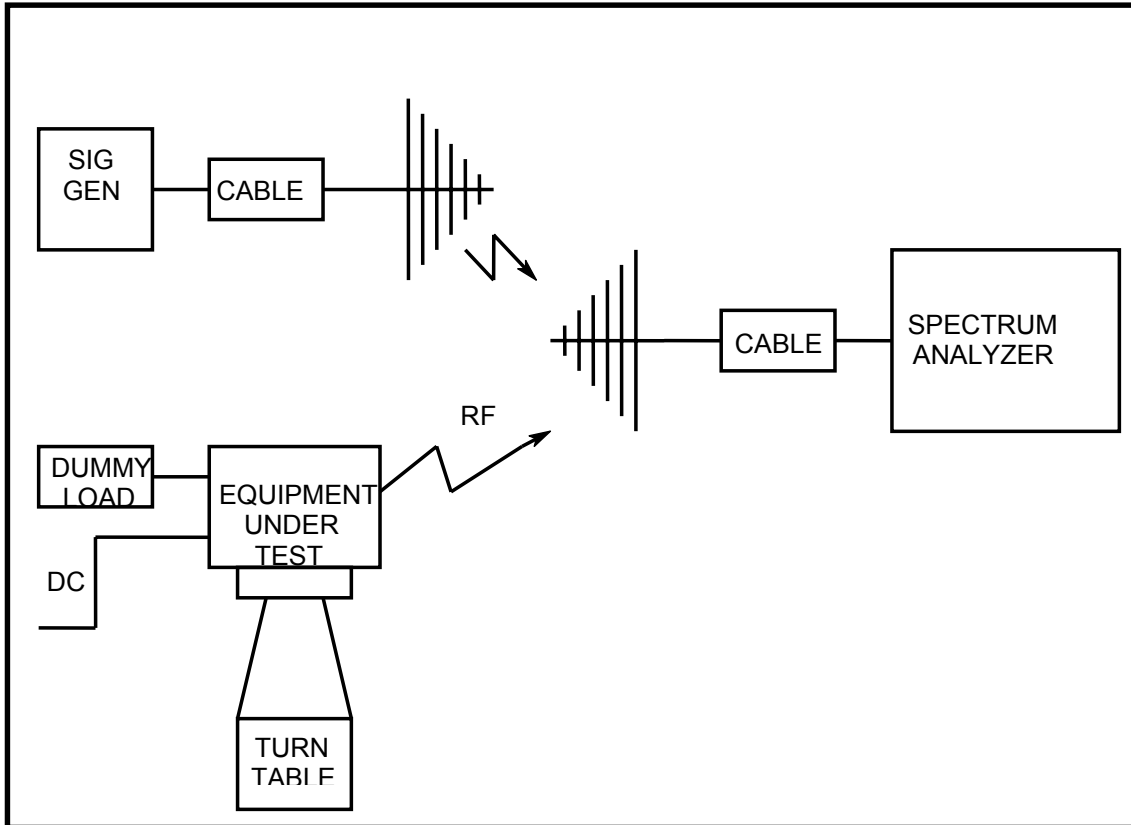

All other testing is performed using the Teltest Radio **EVAL**uation system (TREVA), which is configured as shown below. The Spectrum Analyser is connected to the EUT via the attenuator network for Conducted Emissions testing, and Occupied Bandwidth.

