

**Engineering Exhibit in Support of
Class II Permissive Change Request
FCC Form 731**

for the

Tait T2015-8xx (806-821&851-866MHz mobile transceiver)

modulated with

2FSK and 4FSK digital modulation (F1D)

FCC ID: CASTEL0056

July 4, 2003

AFFIDAVIT

The technical data included in this report has been accumulated through tests that were performed by me or by engineers under my direction. To the best of my knowledge, all of the data is true and correct.

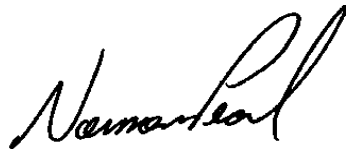

Norman D. Pearl
Vice-president Engineering, Dataradio Inc.

TABLE OF CONTENTS

AFFIDAVIT 2
TABLE OF CONTENTS 3
SECTION 1- FORM 731..... 4
 Engineering Statement..... 4
 Qualifications of Engineering Personnel..... 5
 Class II Permissive Change Information - Rule part 2.1043 (b)(2)..... 6
 General Information about the Grantee and Certified Equipment -2.1043 (b)(2) 7
 Data And Characteristics Not Affected By the F1D Emission Designator – 2.1043 (b)(2) 8
 Data And Characteristics Affected By the F1D Digital Modulation Emission Designator..... 9
SECTION 2 - TEST REPORT Rule Part Number: 2.1033 (c)(14) 10
 NAME OF TEST: Emission Designator 10
 NAME OF TEST: Transmitter Occupied Bandwidth 11
 Test data in support of compliance with Mask G 11
 Plot 1a:MASK G, 12K4F1D, OUTPUT POWER: 15 Watts 13
 Plot 1b:MASK G, 12K4F1D, OUTPUT POWER: 5 Watts 13
 Plot 1a:MASK G, 13K0F1D, OUTPUT POWER: 15 Watts 14
 Plot 1b:MASK G, 13K0F1D, OUTPUT POWER: 5 Watts 14
 Plot 1a:MASK G, 14K0F1D, OUTPUT POWER: 15 Watts 15
 Plot 1b:MASK G, 14K0F1D, OUTPUT POWER: 5 Watts 15
Annex A LIST OF THE TEST EQUIPMENT:..... 16

SECTION 1- FORM 731

Dataradio Inc., Montreal, Canada

Engineering Statement

OF CONSTANTIN PINTILEI

The application consists of the attached engineering exhibit and associated FCC form 731 that were prepared in support of a request for a Class II Permissive Change for CASTEL0056. All changes involved fall under the Class II Permissive Change type and they are entirely detailed within the current report.

The certificate CASTEL0056 has been granted to Tait Electronics Ltd. for the T2015-8xx mobile transceiver. The Class II Permissive type of change is demonstrated with this filing. The original certificate has been granted for F3E type of modulations. The change consists of adding the digital modulation emission designator F1D. It was demonstrated that several sources of DGMSK and 4RCFSK digital modulation comply with the mask 90.210 (G). For those modulation sources their emission designator was found. This Class II permissive change involves the digital modulation source only and it is completely described with the current report.

EXISTING CONDITIONS

The unit utilized for these occupied bandwidth and mask-compliance measurements was a regular production sample. The test pin input provided on the TSP910 of "TCXO series 2" board was fed for the tests. A Dataradio MobilPacII modem was used to create the digital modulation scheme and test sequence.

The transmit frequencies of the unit are 806-821 and 851-866MHz. The frequency tolerance of the exciter is .00025% or 2.5 parts per million and the output power is 15W or 5W as granted in CASTEL0056.

PROPOSED CONDITIONS

It is proposed to accept the Class II permissive change request for the CASTEL0056 grant for F1D operations in the band of frequencies previously outlined. The applicant anticipates marketing the device for use in wireless transmission of data.

PERFORMANCE MEASUREMENTS

All measurements for Occupied Bandwidth and mask compliance as per 2.1043 (b)(2) were conducted in accordance with the Rules and Regulations Section 2.1041 and 2.1049 of Rules Service Co rev.2-164, Jan 15,2003. The measurements were made in the engineering laboratory located at 5500 Royalmount ave, Montreal, Canada. All measurements were made and recorded by myself or under my direction. The measurements were made between May 1st and May 7, 2003.

CONCLUSION

Given the results of the measurements contained herein, the applicant requests to be applied a Class II Permissive Change for the Certificate CASTEL0056 to add the new emission designators 12K4F1D, 13K0F1D and 14K0F1D to the existing one, 16K0F3E.



05/07/2003

Constantin Pintilei
R&D Test Engineer, Dataradio Inc.

Qualifications of Engineering Personnel

NAME: Norman Pearl
TITLE: Vice-president Engineering
TECHNICAL EDUCATION: Bachelor of Engineering (Electrical)
(1979) McGill University, Montreal, Canada
TECHNICAL EXPERIENCE: Professional engineer since 1979
27 Years experience in radio communications

NAME: Constantin Pintilei
TITLE: R&D Test Engineer
TECHNICAL EDUCATION: Bachelor of Engineering Degree in Radiotechnique Electronic Engineering
(1993) Technical University of Iasi, Romania
TECHNICAL EXPERIENCE: 10 Years experience in radio frequency measurements.

Class II Permissive Change Information - Rule part 2.1043 (b)(2)

The certificate CASTEL0056 was granted to Tait Electronics Ltd. for its T2015-8xx mobile transceiver.

The original certificate has been granted for 16K0F3E-voice type of modulation for a unit equipped with audio low-pass filtering as per 90.210. The change consists of adding a new digital modulation source which bypasses the audio low-pass filter, therefore compliance has been demonstrated again with mask 90.210 G. For this modulation source, three digital modulation scheme are used:

- 9600bps DGMSK Gaussian shaped 2-FSK with the emission designator 12K4F1D
- 19200bps DGMSK Gaussian shaped 2-FSK with the emission designator 13K0F1D.
- 19200bps, 9600bauds RC4FSK , raised cosine shaped 4FSK with the emission designator of 14K0F1D

The digital input provided on the TSP910 of “T2000 TCXO/Tx Audio PCB- TCXO series 2” board was fed for the tests. For the purpose of a digital input the jumper which connects the Audio Low Pass filter to the input of the FM modulator was removed. The location of the TSP910 is the area H7 on the schematics (Sheet 7.9.11 in T2000 TCXO/Tx Audio PCB) The page belong to the Part 7.9 of the manual which was submitted with the initial request for FCC ID.

The change above described involves the modulation source only therefore it fall under Class II Permissive Changes type as per 2.1043 (b)(2).

No other changes occur elsewhere in the circuitry of the mobile transceiver.

The characteristics affected by the first modification of above are:

- Digital Modulation Techniques - part 2.1033.(c)(13)
- Type of emission and Emission designators list - part 2.1033 (c)(4), 90.209
- Occupied bandwidth and mask compliance requirement - part 2.1049,90.210(g)

They are entirely documented with the current report.

Therefore all the original test results but those related to the Mask compliance continue to be representative of and applicable to the exciter module. The compliance with Mask G is further confirmed in Section 2, Test Data.

All this Class II permissive change related with the F1D type emission designator data as per 2.1043 are completely described with the current report.

General Information about the Grantee and Certified Equipment -2.1043 (b)(2)

(as per Rule Part Number: 2.1033 (c).(1),(2),(5),(6),(7))

GRANTEE AND MANUFACTURER: Tait Electronics Ltd., Burnside Christchurch 5, New Zealand
(T2000II -800, 800-870 Tx, 851-870MHz Rx)

APPLICANT Tait Electronics Ltd., Burnside Christchurch 5, New Zealand
(T2000II -800, 800-870 Tx, 851-870MHz Rx)

TEST LABORATORY The R&D Validation Laboratory of Dataradio Inc.,
5500 Royalmount Ave, suite 200,
Town of Mount Royal, Quebec, Canada, H4P 1H7

MODEL NUMBER: T2015-815-A84

SERIAL NUMBER (S): 724313

FCC ID NUMBER: CASTEL0056

FCC RULES AND REGS: FCC Part (s) 90

FREQUENCY RANGE: 806-821 & 851-866 MHz Tx as per CASTEL0056 certificate

MAXIMUM POWER RATING: 15Watts/5Watts as per CASTEL0056 certificate.

NUMBER OF CHANNELS: 1 Channel selectable from 24 channels as per Tait's manual

OUTPUT IMPEDANCE: 50 ohms, Nominal

VOLTAGE REQUIREMENTS: 10.9-16.3VDC (13.6 VDC Nominal)

EQUIPMENT IDENTIFICATION product codes of the T2000II Mobile (ref Tait's Service Manual section 1.4)

The model : T20CC – FOO-OOOO CC-nr of channels
F- Frequency band
OOO detail the manufacturer's options.

CC - number of channels	F – Frequency band
10 - 4 channels	1 – 220-270 MHz
15 - 24 channels	2 – 66-88 MHz
20 – 100 channels	3 – 136-174 MHz
30 – 4 calls, all preset –T	4 - 175-225 MHz
35 – 1000 calls, 20 preset T	5 – 400-470 MHz
40 – dialled calls –T	6 – 450-520 MHz
50 – dual mode T2040/T2020	7 – 330-360 MHz
60 – LTR® , systems xgroups =24	8 – 800-870 MHz
T above means trunked operations	9 – 360-400 MHz
	0 – 500-530 MHz

Data And Characteristics Not Affected By the F1D Emission Designator – 2.1043 (b)(2)

(as per Rule Part Number: 2.1033 (c)(3),(8),(9),(10),(11),(12),(14),(15),(16))

Instruction Book	2.1033 (c) (3)
DC Voltages And Currents Into Final Amplifier (T881)	2.1033(c).(8)
Transmitter Tune Up Procedure	2.1033 (c) (9)
Description Of Circuitry (Schematics, Transistor, diode and IC functions)	2.1033 (c)(10)
FCC Label	2.1033 (c) (11)
External or/and Internal Photographs	2.1033 (c) (12)
Data addressing Rule Part Number	2.1033(c) (15),(16): this unit is not designed for the mentioned purposes
MPE limits compliance	2.1091
Test results	2.1033(c)(14), 2.1041
Test data according to:	
Part 2: 2.1046, 2.1051, 2.1053, and 2.1055	
Part 90, Subpart I: 90.213	
as follows:	
Transmitter Rated Power Output	2.1046
Transmitter Spurious and Harmonic Outputs	2.1051
Field Strength of Spurious Radiation	2.1053
Frequency Stability and Frequency Tolerance	2.1055,90.213

Data And Characteristics Affected By the F1D Digital Modulation Emission Designator

(as per Rule Part Number: 2.1033(c) (4),(13),(14)

TYPE OF EMISSION: 2.1033(c)(4)

Originally granted **11K0F3E**
For Class II Permissive Change digital modulation **12K4F1D** (9600bps,DGMSK)
13K0F1D (19200bps DGMSK)
14K0F1D (19200bps, RC4FSK)

DIGITAL MODULATION TECHNIQUES 2.1033 (c)(13)

The digital modulation type used is DGMSK (Differential Gaussian Minimum Shift Keying) or RC4FSK (Raised Cosine 4-level Frequency Shift Keying). A modulation source modem using such type of modulation has three main functional blocks:

Differential encoder:

The differential encoder XOR's the current input bit with the previous bit. The differential encoder is used to make the modem insensitive to audio polarity inversion of the FM radio system.

Symbol mapper

The symbol mapper assigns incoming groups of bits to logic symbols. For DGMSK there are only 2 symbols equated to bit 0 or 1, for 4FSK there are groups of 2 bits mapped in 4 symbols following Gray coding

Waveshape generator:

The waveshape generator filters the processed digital symbols through the pulse-shaping Nyquist-based filter, either Gaussian or Raised Cosine. The data such processed is reconverted in analog baseband signal through a DAC. This audio signal resulting is passed further to the FM modulator as modulating input of the RF transmitter.

TEST DATA Rule Part Number: 2.1033 (c)(14)

All applicable test data related to a new type of emission designator according to:

- Part 2: 2.1043 (b)(2), 2.1049
- Part 90, Subpart I: 90.209 and 90.210

are provided in next section

SECTION 2 - TEST REPORT Rule Part Number: 2.1033 (c)(14)

NAME OF TEST: Emission Designator

RULE PART NUMBER: 2.201, 2.202, 2.1033 c (14), 2.1049 (h), 2.1041

For the F1D type of emission designator the TSP910 of the TCXO board was the input for digital modulation signals. The random signal generator used passes the test sequence through a DSP implemented pulse-shaped (either Gaussian or Raised Cosine) filter to fed directly the FM modulator. The necessary bandwidth calculation for this type of modulation (DGMSK) is not covered by paragraphs (1), (2) or (3) from 2.202(c), the result exceeding by far the real necessary bandwidth obtained through measurement of the 99% of the occupied bandwidth.

Therefore, the approach outlined in (2.202(c)(4)) is applicable in this case.

Necessary Bandwidth Measurement (90.209.(b))

The results of 99% Occupied Bandwidth measurement are:

Bit rate/Symbol rate	Reference voltage for 1kHz tone	Ref. deviation for 1kHz tone	Maximum Digital Deviation	Occupied Bandwidth	Emission designator
9600 bps/9600bauds	1.352 V _{pp}	± 4.25 kHz	± 4.85 KHz	12333 Hz	12K4F1D
19200bps/19200bauds	0.941 V _{pp}	± 3.00 kHz	± 3.25 kHz	13000 Hz	13K0F1D
19200bps/9600bauds	1.160 V _{pp}	± 3.60 kHz	± 5.00 kHz	14000 Hz	14K0F1D

The set-up explanations follow.

Occupied Bandwidth Measurement

The Occupied Bandwidth measurement option of the instrument (8563EC spectrum analyzer from Agilent) calculates and provides the values used above for the emission designator.

The percentage setting of the measurement has been set to 99% following the definition of the **Occupied Bandwidth** “the frequency bandwidth such that, below its lower and above its upper frequency limits, the mean powers radiated are each equal to 0.5 percent of the total mean power radiated by a given emission” (FCC 2.202)

The measurement has been performed during the tests for compliance with mask G, the resulting value was recorded for the Occupied Bandwidth. V_{pp} amplitude of the modulating signal applied to TSP910 was measured between input and ground , AC coupled at the output of MobilPac2. A +2.5V offset applies.

The measurement set-up is:

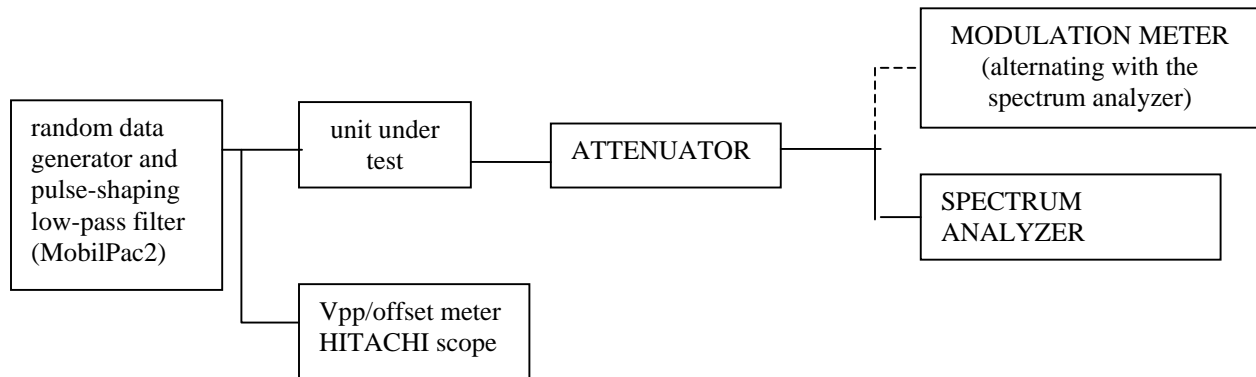

NAME OF TEST: Transmitter Occupied Bandwidth

Test data in support of compliance with Mask G

RULE PART NUMBER: 2.201, 2.202, 2.1033 c (14), 2.1049 (h), 2.1041, 90.209 (b)(5), 90.210 (G)

MINIMUM STANDARD: Mask G
 Sidebands and Spurious [Rule 90.210 (g)]
 Authorized Bandwidth = 20 kHz [Rule 90.209(b) (5)]
 Fo to 5.0 kHz Attenuation = 0 dB
 >5.0 kHz to 10.0 kHz Attenuation= $83 * \log(f_d \text{ KHz} / 5)$ dB
 >10.0 kHz to 250% Auth BW Attenuation = Lesser of:
 $116 * \log(f_d \text{ KHz} / 6.1)$ dB,
 $50 + 10 \log_{10}(P)$ OR
 70 dB
 >250% Auth BW 43 + $10 * \log(P)$ dB

Corner Points:
 Fo to 5.0 kHz Attenuation = 0 dB
 >5.0 kHz to 10.0 kHz Attenuation= 0 dB to 25 dB
 >10.0 kHz to 20.90 KHz Attenuation = 24.9 dB to 62 dB (10 Watts)
 >10.0 kHz to 18.91 KHz Attenuation = 24.9 dB to 57 dB (5 Watts)
 >20.90 kHz to 50kHz Attenuation = 61.2dB (15Watts)
 >18.91kHz to 50kHz Attenuation = 57dB (5W)
 >250% Authorized BW Attenuation = 51.2 dB (15 W), 50 dB (5 W)

TEST RESULTS: Meets minimum standard (see data on the following pages)

TEST CONDITIONS: Standard Test Conditions, 25 C

TEST EQUIPMENT: Digital pseudo-random sequence generator: modem Model Dataradio MobilPac II
 Attenuator, BIRD Model / 10-A-MFN-30 / 30 dB / 10 Watt
 DC Power Source, Model Astron VS 20M
 Communication Analyzer, Model IFR COM120B for Modulation Analyzer
 Spectrum Analyzer, Model HP(Agilent) 8563EC

Constantin Pintilei

PERFORMED BY: _____ DATE: 05/09/03

Constantin Pintilei

TEST SET-UP:

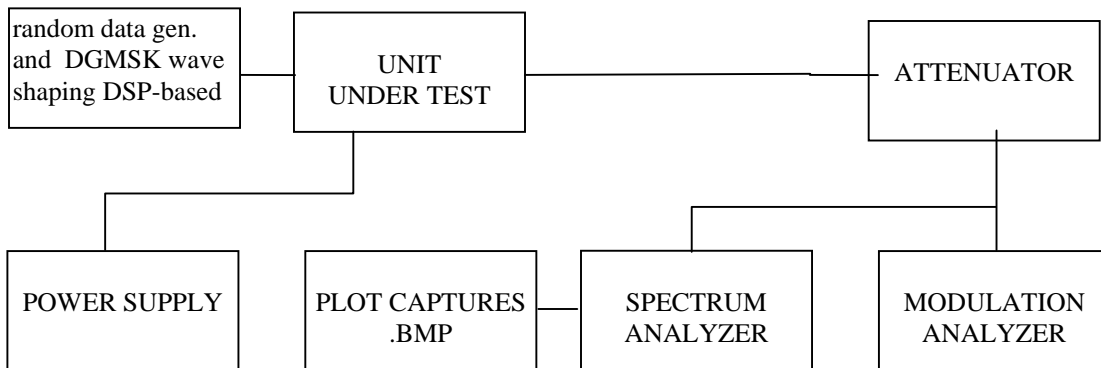

NAME OF TEST: Transmitter Occupied Bandwidth (Continued)

MODULATION SOURCE DESCRIPTION:(Part 2.1047 (d), 90.209 (b), 90.210(g):

Other types of equipment: the digital modulation input of the exciter bypasses the audio low-pass filter, the filtering is entirely result of the digital modulation source.

TEST PATTERN GENERATOR:

The random data generator function of the MobilPac generates a 2047-long bit test sequence. This function is performed with a serial shift register and a exclusive OR two tap gate that implement the polynomial form $X^{10}+X^8+1$. The initial value of the register is 7FF.

After this, the data follow the DGMSK/RC4FSK digital modulation process described in the page 8 and the resulting base band signal feed the modulator's input of the transceiver.

The modulation source's rates and output voltages are set through the DSP/DAC as explained in pages 8,9. The resulting FM deviation for maximum deviation was read using the modulation analyzer of IFR COM120B. For the deviation measurements on the modulation analyzer an IF filter of 30KHz has been used.

Snap shots: Refer to the following plots.

SPECTRUM FOR EMISSION **12K4F1D**, , 9600bps, DGMSK BT factor=0.5
PEAK DEVIATION = 4240 Hz, SPAN = 20kHz/div

Plot 1a: MASK G, 12K4F1D, OUTPUT POWER: 15 Watts

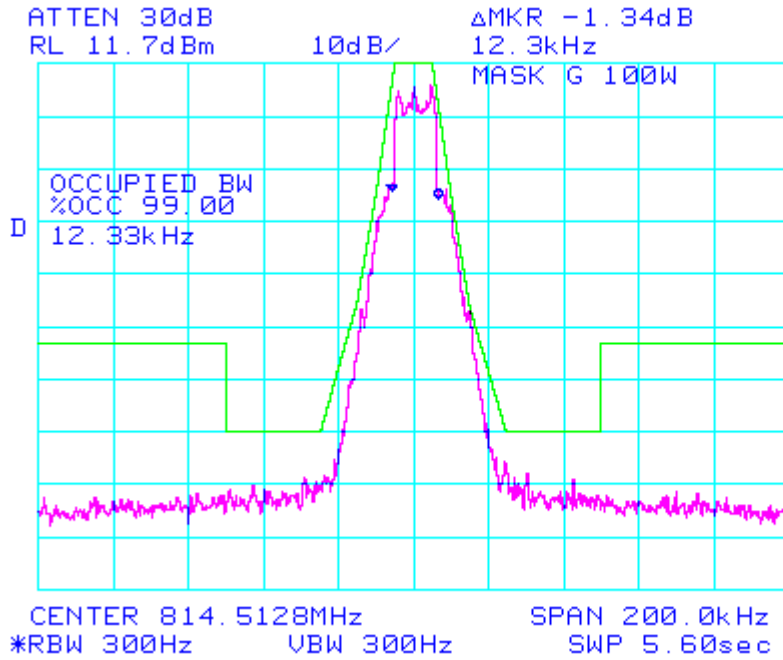

Plot 1b: MASK G, 12K4F1D, OUTPUT POWER: 5 Watts

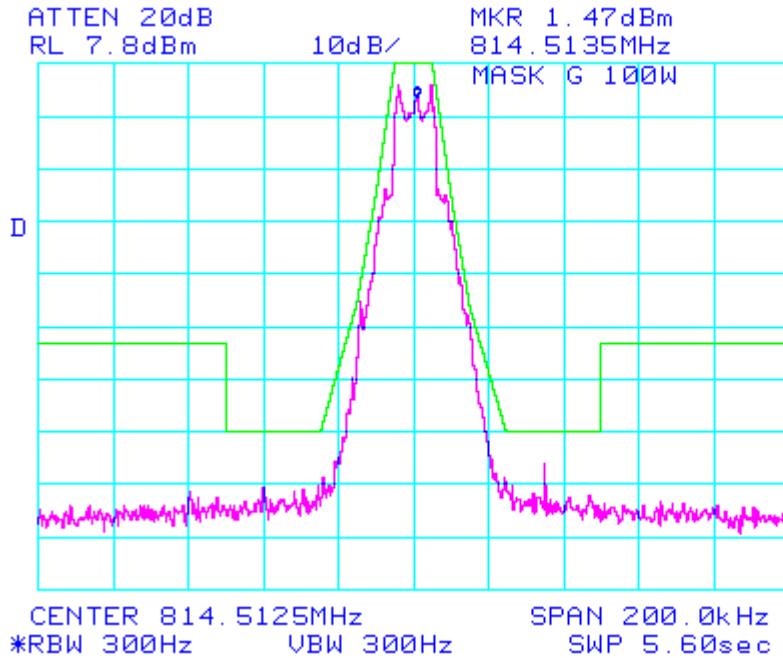

SPECTRUM FOR EMISSION **13K0F1D**, , 19200bps, DGMSK BT factor=0.3
PEAK DEVIATION = 3000 Hz, SPAN = 20kHz/div

Plot 1a: MASK G, 13K0F1D, OUTPUT POWER: 15 Watts

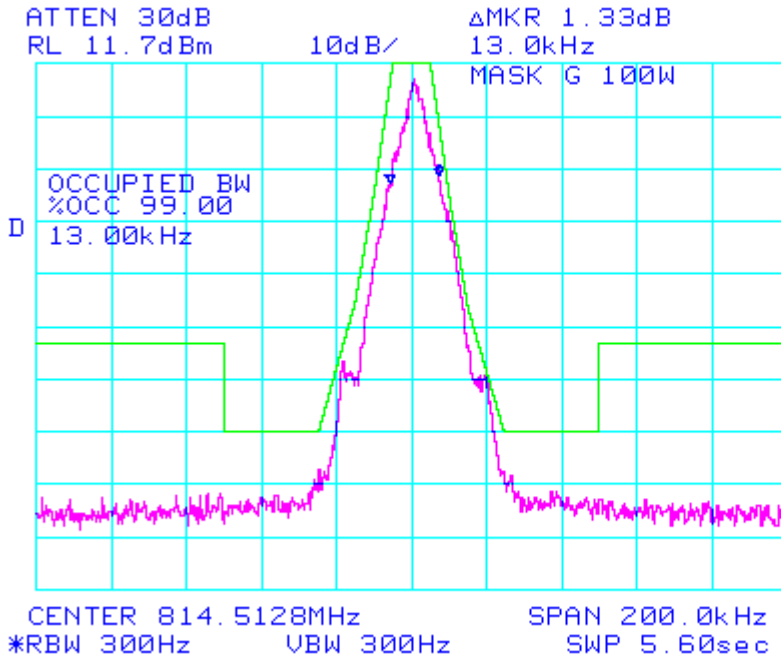

Plot 1b: MASK G, 13K0F1D, OUTPUT POWER: 5 Watts

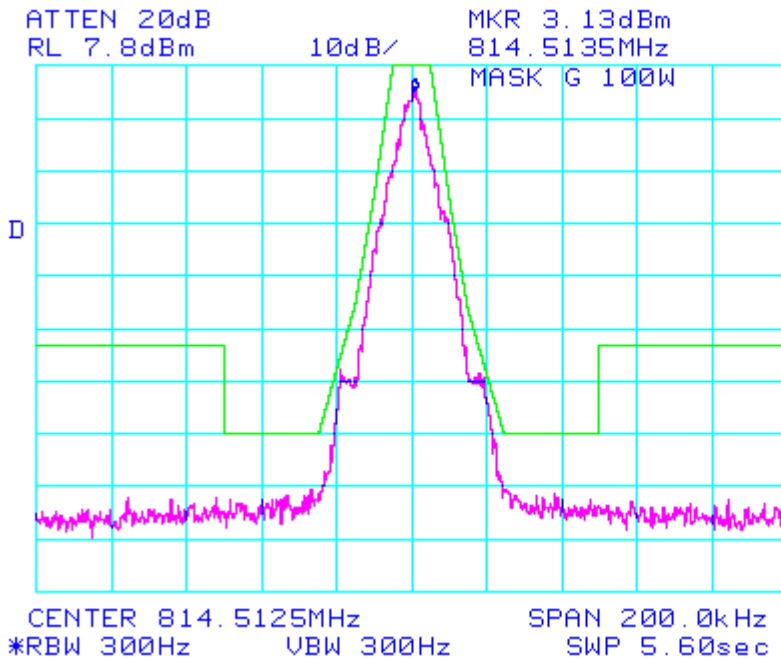

SPECTRUM FOR EMISSION **14K0F1D**, 19200bps, 9600bauds, RC4FSK
PEAK DEVIATION = 3640 Hz, SPAN = 20kHz/div

Plot 1a: MASK G, 14K0F1D, OUTPUT POWER: 15 Watts

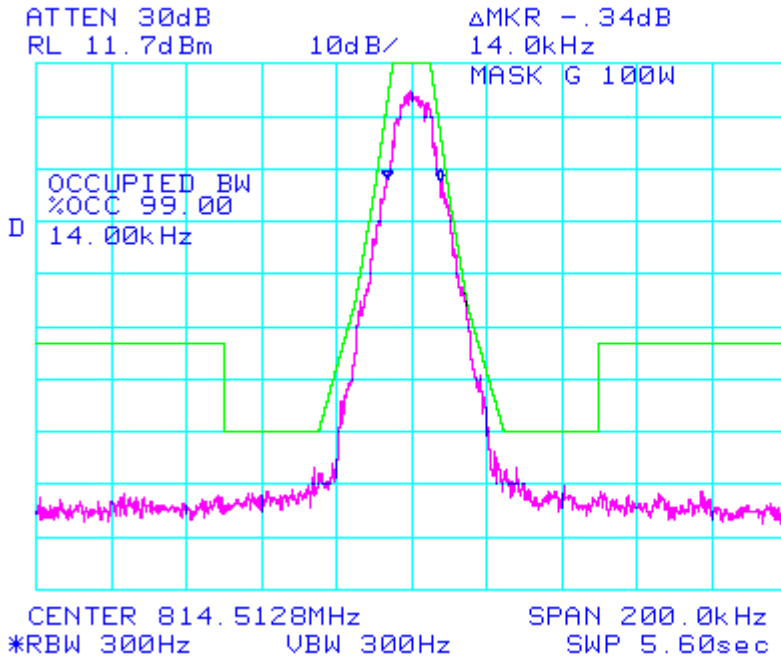

Plot 1b: MASK G, 14K0F1D, OUTPUT POWER: 5 Watts

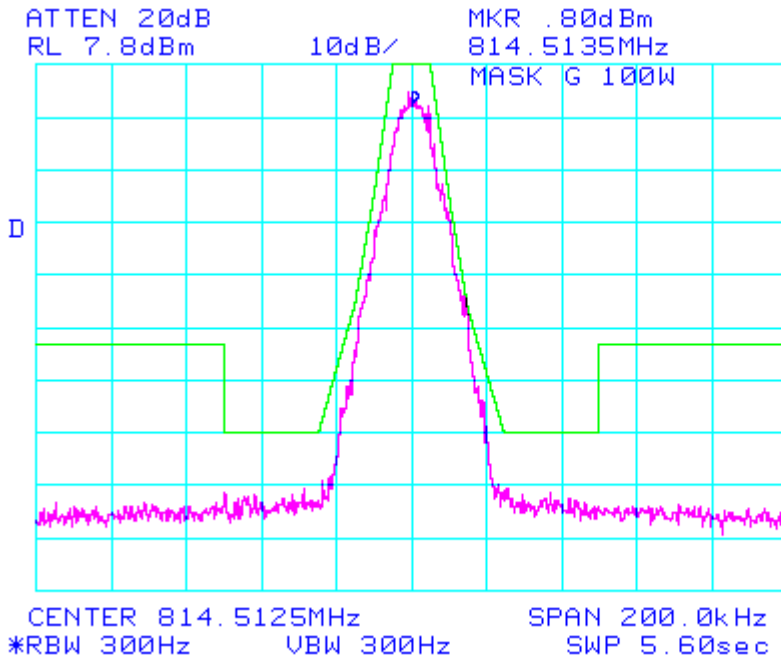

Annex A LIST OF THE TEST EQUIPMENT:

Equipment	Manufacturer and model	serial number	inventory
Digital pseudo-random sequence generator	Dataradio MobilPac II model MP2D9- 2015	NA	R&D-IWCE demo
Attenuator 30 dB / 10 Watt	BIRD Model / 10-A-MFN-30	NA	DR1121
Communication Analyzer (used for Modulation Analyzer)	IFR COM120B	500008432	T612
Spectrum Analyzer	HP(Agilent) 8563EC	4103A01135	DR231
DC Power Source	Astron VS 20M	200030003	DR1447
Oscilloscope	HITACHI VC6545	4110320	DR213