

# 7.11 T2020, T203X, T2040, T2050 & T2060 HC11 Logic PCB

## T2000 HC11 Logic Parts List (IPN 220-01344-02)

Parts List Amendments	

Ref	Var	IPN	Description	Ref	Var	IPN	Description
#012	2050	038-13680-00	RES 0603 CHIP 680E 1/16W +5%	C621		018-15100-00	CAP 0603 CHIP 10N 50V X7R +-10%
#015	2020	038-14470-00	RES 0603 CHIP 4K7 1/16W +-5%	C622		018-15100-00	CAP 0603 CHIP 10N 50V X7R +-10%
#017	2060	038-15100-00	RES 0603 CHIP 10K 1/16W +-5%	C623		015-06100-08	CAP CER 1206 CHIP 100N 10% X7R 50V
#018	203X	038-15270-00	RES 0603 CHIP 27K 1/16W +-5%	C624		018-15100-00	CAP 0603 CHIP 10N 50V X7R +-10%
#019	2040	038-15470-00	RES 0603 CHIP 47K 1/16W +-5%	C625		018-15100-00	CAP 0603 CHIP 10N 50V X7R +-10%
C501		015-23680-08	CAP CER 0805 CHIP 680P 10% X7R 50V	C626		014-07470-00	CAP TANT CHIP 4U7 3.5 X 2.8MM 267 SERIE
C502		018-16100-01	CAP 0603 CHIP 100N +80-20% Y5V 16V	C627		015-06100-08	CAP CER 1206 CHIP 100N 10% X7R 50V
C503		018-16100-01	CAP 0603 CHIP 100N +80-20% Y5V 16V	C628		018-15100-00	CAP 0603 CHIP 10N 50V X7R +-10%
C504		018-16100-01	CAP 0603 CHIP 100N +80-20% Y5V 16V	C629		015-23220-01	CAP CER 0805 CHIP 220P 5% NPO 50V
C505		018-12390-00	CAP 0603 CHIP 39P 50V NPO +-5%	C630		015-25150-08	CAP CER 0805 CHIP 15N 10% X7R 50V
C506		018-12220-00	CAP 0603 CHIP 22P 50V NPO +-5%	#C631	2020	015-06100-08	CAP CER 1206 CHIP 100N 10% X7R 50V
C507		018-12270-00	CAP 0603 CHIP 27P 50V NPO +-5%	#C631	2040	015-06100-08	CAP CER 1206 CHIP 100N 10% X7R 50V
C508		018-16100-01	CAP 0603 CHIP 100N +80-20% Y5V 16V	#C631	2050	015-06100-08	CAP CER 1206 CHIP 100N 10% X7R 50V
C509		018-14100-00	CAP 0603 CHIP 1N 50V X7R +-10%	#C631	2060	015-06100-08	CAP CER 1206 CHIP 100N 10% X7R 50V
C510		018-15100-00	CAP 0603 CHIP 10N 50V X7R +-10%	C635		016-08470-01	CAP ELECT SMD 6*4MM 47U 16V
C511		018-15100-00	CAP 0603 CHIP 10N 50V X7R +-10%	C635A		016-08470-01	CAP ELECT SMD 6*4MM 47U 16V
C512		018-14100-00	CAP 0603 CHIP 1N 50V X7R +-10%	C636		015-06100-08	CAP CER 1206 CHIP 100N 10% X7R 50V
C514		018-16100-01	CAP 0603 CHIP 100N +80-20% Y5V 16V	C637		018-11470-00	CAP 0603 CHIP 4P7 50V NPO +-0.25P
C514A		018-14100-00	CAP 0603 CHIP 1N 50V X7R +-10%	C638		018-16100-01	CAP 0603 CHIP 100N +80-20% Y5V 16V
C514B		018-14100-00	CAP 0603 CHIP 1N 50V X7R +-10%	C639		016-08470-01	CAP ELECT SMD 6*4MM 47U 16V
C516		018-16100-01	CAP 0603 CHIP 100N +80-20% Y5V 16V	C640		016-08470-01	CAP ELECT SMD 6*4MM 47U 16V
C517		015-23680-08	CAP CER 0805 CHIP 680P 10% X7R 50V	C641		018-14100-00	CAP 0603 CHIP 1N 50V X7R +-10%
C519		018-16100-01	CAP 0603 CHIP 100N +80-20% Y5V 16V	C642		015-23220-01	CAP CER 0805 CHIP 220P 5% NPO 50V
C520		018-16100-01	CAP 0603 CHIP 100N +80-20% Y5V 16V	C643		015-25150-08	CAP CER 0805 CHIP 15N 10% X7R 50V
C522		018-16100-01	CAP 0603 CHIP 100N +80-20% Y5V 16V	C644		015-25150-08	CAP CER 0805 CHIP 15N 10% X7R 50V
C523		018-16100-01	CAP 0603 CHIP 100N +80-20% Y5V 16V	C645		018-13150-00	CAP 0603 CHIP 150P 50V NPO +-5%
C524		016-08470-01	CAP ELECT SMD 6*4MM 47U 16V	C646		014-07470-00	CAP TANT CHIP 4U7 3.5 X 2.8MM 267 SERIE
C525		018-13150-00	CAP 0603 CHIP 150P 50V NPO +-5%	C647		018-16100-01	CAP 0603 CHIP 100N +80-20% Y5V 16V
C526		018-13150-00	CAP 0603 CHIP 150P 50V NPO +-5%	C648		016-08470-01	CAP ELECT SMD 6*4MM 47U 16V
C527		018-13150-00	CAP 0603 CHIP 150P 50V NPO +-5%	C650		018-13150-00	CAP 0603 CHIP 150P 50V NPO +-5%
C529		018-13150-00	CAP 0603 CHIP 150P 50V NPO +-5%	C651		018-13150-00	CAP 0603 CHIP 150P 50V NPO +-5%
C530		018-13150-00	CAP 0603 CHIP 150P 50V NPO +-5%	C652		018-14100-00	CAP 0603 CHIP 1N 50V X7R +-10%
C532		018-14100-00	CAP 0603 CHIP 1N 50V X7R +-10%	C653		018-14100-00	CAP 0603 CHIP 1N 50V X7R +-10%
C533		018-16100-01	CAP 0603 CHIP 100N +80-20% Y5V 16V	#C661	2020	018-16100-01	CAP 0603 CHIP 100N +80-20% Y5V 16V
C534		018-16100-01	CAP 0603 CHIP 100N +80-20% Y5V 16V	#C661	203X	018-16100-01	CAP 0603 CHIP 100N +80-20% Y5V 16V
C535		018-16100-01	CAP 0603 CHIP 100N +80-20% Y5V 16V	#C661	2040	018-16100-01	CAP 0603 CHIP 100N +80-20% Y5V 16V
C536		014-07470-00	CAP TANT CHIP 4U7 3.5 X 2.8MM 267 SERIE	#C661	2060	018-16100-01	CAP 0603 CHIP 100N +80-20% Y5V 16V
C537		016-07470-01	CAP ELECT 6X4MM CHIP 4M7 20% 16V	#C662	2020	018-16100-01	CAP 0603 CHIP 100N +80-20% Y5V 16V
C538		018-16100-01	CAP 0603 CHIP 100N +80-20% Y5V 16V	#C662	203X	018-16100-01	CAP 0603 CHIP 100N +80-20% Y5V 16V
C540		018-13150-00	CAP 0603 CHIP 150P 50V NPO +-5%	#C662	2040	018-16100-01	CAP 0603 CHIP 100N +80-20% Y5V 16V
C541		018-13150-00	CAP 0603 CHIP 150P 50V NPO +-5%	#C662	2060	018-16100-01	CAP 0603 CHIP 100N +80-20% Y5V 16V
C550		018-16100-01	CAP 0603 CHIP 100N +80-20% Y5V 16V	#C663	2020	018-16100-01	CAP 0603 CHIP 100N +80-20% Y5V 16V
C560		018-16100-01	CAP 0603 CHIP 100N +80-20% Y5V 16V	#C663	203X	018-16100-01	CAP 0603 CHIP 100N +80-20% Y5V 16V
C570		018-16100-01	CAP 0603 CHIP 100N +80-20% Y5V 16V	#C663	2040	018-16100-01	CAP 0603 CHIP 100N +80-20% Y5V 16V
C571		018-16100-01	CAP 0603 CHIP 100N +80-20% Y5V 16V	#C663	2060	018-16100-01	CAP 0603 CHIP 100N +80-20% Y5V 16V
C600		018-14100-00	CAP 0603 CHIP 1N 50V X7R +-10%	C700		014-07470-00	CAP TANT CHIP 4U7 3.5 X 2.8MM 267 SERIE
C601		014-07470-00	CAP TANT CHIP 4U7 3.5 X 2.8MM 267 SERIE	C701		016-08470-01	CAP ELECT SMD 6*4MM 47U 16V
C602		018-12820-00	CAP 0603 CHIP 82P 50V NPO +-5%	#C704	2020	014-07470-00	CAP TANT CHIP 4U7 3.5 X 2.8MM 267
C603		015-23220-01	CAP CER 0805 CHIP 220P 5% NPO 50V	#C704	203X	014-07470-00	CAP TANT CHIP 4U7 3.5 X 2.8MM 267
C605		014-07470-00	CAP TANT CHIP 4U7 3.5 X 2.8MM 267 SERIE	#C704	2040	014-07470-00	CAP TANT CHIP 4U7 3.5 X 2.8MM 267
C607		015-06100-08	CAP CER 1206 CHIP 100N 10% X7R 50V	#C704	2050	014-07470-00	CAP TANT CHIP 4U7 3.5 X 2.8MM 267
C608		018-15100-00	CAP 0603 CHIP 10N 50V X7R +-10%	#C704	2060	014-07470-00	CAP TANT CHIP 4U7 3.5 X 2.8MM 267
C609		018-12470-00	CAP 0603 CHIP 47P 50V NPO +-5%	C705		015-24470-08	CAP CER 0805 CHIP 4N7 10% X7R 50V
C610		014-07470-00	CAP TANT CHIP 4U7 3.5 X 2.8MM 267 SERIE	#C706	203X	015-06100-08	CAP CER 1206 CHIP 100N 10% X7R 50V
C611		018-13100-00	CAP 0603 CHIP 100P 50V NPO +-5%	#C706	2060	015-06100-08	CAP CER 1206 CHIP 100N 10% X7R 50V
C613		015-24470-08	CAP CER 0805 CHIP 4N7 10% X7R 50V	C720		018-16100-01	CAP 0603 CHIP 100N +80-20% Y5V 16V
C614		015-25150-08	CAP CER 0805 CHIP 15N 10% X7R 50V	C721		018-16100-01	CAP 0603 CHIP 100N +80-20% Y5V 16V
C615		015-25150-08	CAP CER 0805 CHIP 15N 10% X7R 50V	C722		018-16100-01	CAP 0603 CHIP 100N +80-20% Y5V 16V
C616		015-25150-08	CAP CER 0805 CHIP 15N 10% X7R 50V	C801		015-25220-08	CAP CER 0805 CHIP 22N 10% X7R 50V
C617		018-15100-00	CAP 0603 CHIP 10N 50V X7R +-10%	C802		018-15100-00	CAP 0603 CHIP 10N 50V X7R +-10%
C618		018-15100-00	CAP 0603 CHIP 10N 50V X7R +-10%	C803		018-11470-00	CAP 0603 CHIP 4P7 50V NPO +-0.25P
C619		018-15100-00	CAP 0603 CHIP 10N 50V X7R +-10%	C804		015-23180-01	CAP CER 0805 CHIP 180P 5% NPO 50V
C620		018-15100-00	CAP 0603 CHIP 10N 50V X7R +-10%	C805		015-06100-08	CAP CER 1206 CHIP 100N 10% X7R 50V
				C806		014-07470-00	CAP TANT CHIP 4U7 3.5 X 2.8MM 267 SERIE

Ref	Var	IPN	Description	Ref	Var	IPN	Description
C808		015-06100-08	CAP CER 1206 CHIP 100N 10% X7R 50V	R503		038-15470-00	RES 0603 CHIP 47K 1/16W +5%
#C810	PE	018-13150-00	CAP 0603 CHIP 150P 50V NPO +5%	R504		038-14470-00	RES 0603 CHIP 4K7 1/16W +5%
C811		018-16100-01	CAP 0603 CHIP 100N +80-20% Y5V 16V	R505		036-16150-00	RES M/F 0805 CHIP 150K 5%
#C812	203X	018-15100-00	CAP 0603 CHIP 10N 50V X7R +10%	R506		038-15100-00	RES 0603 CHIP 10K 1/16W +5%
#C812	2040	018-15100-00	CAP 0603 CHIP 10N 50V X7R +10%	R507		038-10000-00	RES 0603 CHIP ZERO OHM 1/16W +5%
#C812	2050	018-15100-00	CAP 0603 CHIP 10N 50V X7R +10%	RV507		042-15500-01	RES PRESET SMD 50K +25% 4X4.5X2.5MM 0
#C812	PE	018-13150-00	CAP 0603 CHIP 150P 50V NPO +5%	R508		038-16100-00	RES 0603 CHIP 100K 1/16W +5%
C813		018-11560-00	CAP 0603 CHIP 5P6 50V NPO +0.25P	R509		038-14220-00	RES 0603 CHIP 22K 1/16W +5%
C814		018-16100-01	CAP 0603 CHIP 100N +80-20% Y5V 16V	R510		036-18100-00	RES M/F 0805 CHIP 10M 10%
C815		015-25150-08	CAP CER 0805 CHIP 15N 10% X7R 50V	R511		038-16470-00	RES 0603 CHIP 470K 1/16W +5%
D502		001-10099-01	(S) DIODE BAV99W DUAL SML SIG SOT323	R512		038-16100-00	RES 0603 CHIP 100K 1/16W +5%
D503		001-10099-01	(S) DIODE BAV99W DUAL SML SIG SOT323	R514		038-16100-00	RES 0603 CHIP 100K 1/16W +5%
D800		001-10099-01	(S) DIODE BAV99W DUAL SML SIG SOT323	R515		038-16100-00	RES 0603 CHIP 100K 1/16W +5%
#F01	PE	038-16000-00	RES 0603 CHIP 100K 1/16W +5%	R516		038-16100-00	RES 0603 CHIP 100K 1/16W +5%
#IC500	2020	002-10481-80	LS) IC SMD M48Z18 8K*8 SNAPHAT RA	#R517	2020	038-16220-00	RES 0603 CHIP 220K 1/16W +5%
#IC500	203X	002-10481-80	LS) IC SMD M48Z18 8K*8 SNAPHAT RA	#R517	203X	038-16220-00	RES 0603 CHIP 220K 1/16W +5%
#IC500	2040	002-10481-80	LS) IC SMD M48Z18 8K*8 SNAPHAT RA	#R517	2040	038-16220-00	RES 0603 CHIP 220K 1/16W +5%
#IC500	2050	002-10483-50	LS) IC SMD M48Z35 32K*8 SNAPHAT R	#R517	2060	038-16220-00	RES 0603 CHIP 220K 1/16W +5%
#IC500	2060	002-10481-80	LS) IC SMD M48Z18 8K*8 SNAPHAT RA	R518		038-14100-00	RES 0603 CHIP 1K0 1/16W +5%
IC501		002-20290-10	(S) IC AM29F010-120JC FLASH MEM 128*8K	R519		038-16100-00	RES 0603 CHIP 100K 1/16W +5%
IC502		002-74900-00	(S) IC SMD 74HC00 QUAD 2 I/P NAND	R520		038-14220-00	RES 0603 CHIP 2K2 1/16W +5%
#IC503	203X	002-10140-21	(S) IC MC14021BDR2 8BIT SHIFT REG	R521		038-15100-00	RES 0603 CHIP 10K 1/16W +5%
#IC503	2060	002-10140-21	(S) IC MC14021BDR2 8BIT SHIFT REG	R522		038-14470-00	RES 0603 CHIP 4K7 1/16W +5%
IC504		002-10340-64	(S) IC SMD MC34064 LO VOLT SENSE	R523		038-14100-00	RES 0603 CHIP 1K0 1/16W +5%
IC505		002-16800-11	(S) IC SMD MC68HC11A1 MCU PLCC52	#R524	2020	036-16330-00	RES M/F 0805 CHIP 330K 5%
IC510		002-74900-40	(LSH) IC SMD TC7S04F SINGLE INV GATE S	#R524	203X	036-16330-00	RES M/F 0805 CHIP 330K 5%
IC511		002-74900-40	(LSH) IC SMD TC7S04F SINGLE INV GATE S	#R524	2040	036-16330-00	RES M/F 0805 CHIP 330K 5%
IC513		002-10078-05	(S) IC SMD 78L05 5V REG	#R524	2060	036-16330-00	RES M/F 0805 CHIP 330K 5%
IC514		002-10078-08	(S) IC SMD 78L08 8V REG SO8	R525		038-13330-00	RES 0603 CHIP 330E 1/16W +5%
#IC517	203X	002-20046-90	(S) IC FX469LS FFSK MODEM 1200/24	R525A		038-13330-00	RES 0603 CHIP 330E 1/16W +5%
#IC517	2040	002-20046-90	(S) IC FX469LS FFSK MODEM 1200/24	R526		038-14470-00	RES 0603 CHIP 4K7 1/16W +5%
#IC517	2050	002-20004-39	(S) IC FX439LS FFSK MODEM 24 PLCC	R529		038-10000-00	RES 0603 CHIP ZERO OHM 1/16W +5%
IC555		002-16562-60	(LSH) IC CMOS6X GATE ARRAY (T3000/T205	R530		038-15470-00	RES 0603 CHIP 47K 1/16W +5%
IC601		002-10003-24	(S) IC SMD 324 QUAD OP AMP SO14	R531		038-14470-00	RES 0603 CHIP 4K7 1/16W +5%
IC603		002-10003-24	(S) IC SMD 324 QUAD OP AMP SO14	R532		038-15470-00	RES 0603 CHIP 2K2 1/16W +5%
IC604		002-10003-24	(S) IC SMD 324 QUAD OP AMP SO14	R533		038-15470-00	RES 0603 CHIP 47K 1/16W +5%
#IC606	2020	002-74901-32	(S) IC SMD 74HC132 HCMOS QUAD SCH	R534		038-14470-00	RES 0603 CHIP 4K7 1/16W +5%
#IC606	203X	002-74901-32	(S) IC SMD 74HC132 HCMOS QUAD SCH	R535		038-14100-00	RES 0603 CHIP 1K0 1/16W +5%
#IC606	2040	002-74901-32	(S) IC SMD 74HC132 HCMOS QUAD SCH	R537		038-15470-00	RES 0603 CHIP 47K 1/16W +5%
#IC606	2060	002-74901-32	(S) IC SMD 74HC132 HCMOS QUAD SCH	R538		036-15220-00	RES M/F 0805 CHIP 22K 5%
IC614		002-10040-53	(S) IC 4053 SMD TRIPLE 2CH MULTI-PLRXR	R539		038-17100-00	RES 0603 CHIP 1M 1/16W +5%
IC801		002-10003-24	(S) IC SMD 324 QUAD OP AMP SO14	R540		038-14470-00	RES 0603 CHIP 4K7 1/16W +5%
IC802		002-10003-58	(S) IC SMD LM358 DUAL OP AMP	R541		038-16100-00	RES 0603 CHIP 100K 1/16W +5%
L501		056-10330-02	(L) IND SMD 330NH SIEMENS SMID02	R543		038-14220-00	RES 0603 CHIP 2K2 1/16W +5%
MPT3-1		290-00010-41	CELL M4Z28 SNAPHAT BATTERY PACK	R544		038-15470-00	RES 0603 CHIP 47K 1/16W +5%
#P1	2050	240-10000-01	CONN SMD 24WAY (PLUG)	R545		038-15470-00	RES 0603 CHIP 47K 1/16W +5%
Q501		000-10084-81	(S) XSTR SMD BC848BW NPN SOT-323 SMALL	R547		038-16100-00	RES 0603 CHIP 100K 1/16W +5%
Q504		000-10084-81	(S) XSTR SMD BC848BW NPN SOT-323 SMALL	R548		038-15100-00	RES 0603 CHIP 10K 1/16W +5%
Q505		000-10084-81	(S) XSTR SMD BC848BW NPN SOT-323 SMALL	R549		038-14100-00	RES 0603 CHIP 1K0 1/16W +5%
Q506		000-10084-81	(S) XSTR SMD BC848BW NPN SOT-323 SMALL	R550		038-16100-00	RES 0603 CHIP 100K 1/16W +5%
Q507		000-10084-81	(S) XSTR SMD BC848BW NPN SOT-323 SMALL	R551		038-15100-00	RES 0603 CHIP 10K 1/16W +5%
Q508		000-10008-69	(S) XSTR SMD BC869 PNP 1W 2A SOT-89	R552		038-10000-00	RES 0603 CHIP ZERO OHM 1/16W +5%
Q509		000-10003-12	(S) XSTR SMD BFR31 N JFET SOT-23	R552	2040	038-10000-00	RES 0603 CHIP ZERO OHM 1/16W +5%
Q510		000-10084-81	(S) XSTR SMD BC848BW NPN SOT-323 SMALL	R552	2050	038-10000-00	RES 0603 CHIP ZERO OHM 1/16W +5%
#Q511	2020	000-10029-55	(S) XSTR SMD MJD2955 PWR PNP 10A 6	R553		038-15470-00	RES 0603 CHIP 47K 1/16W +5%
#Q511	2040	000-10029-55	(S) XSTR SMD MJD2955 PWR PNP 10A 6	R554		038-16100-00	RES 0603 CHIP 100K 1/16W +5%
#Q511	2050	000-10029-55	(S) XSTR SMD MJD2955 PWR PNP 10A 6	R554		038-15100-00	RES 0603 CHIP 10K 1/16W +5%
#Q511	2060	000-10029-55	(S) XSTR SMD MJD2955 PWR PNP 10A 6	R559		038-13220-00	RES 0603 CHIP 220E 1/16W +5%
Q513		000-10084-81	(S) XSTR SMD BC848BW NPN SOT-323 SMALL	R560		038-13220-00	RES 0603 CHIP 220E 1/16W +5%
Q514		000-10085-71	(S) XSTR SMD BC857BW PNP SOT-323 SMALL	R562		038-15100-00	RES 0603 CHIP 10K 1/16W +5%
Q515		000-10085-71	(S) XSTR SMD BC857BW PNP SOT-323 SMALL	R563		036-14390-00	RES M/F 0805 CHIP 3K9 5%
Q516		000-10085-71	(S) XSTR SMD BC857BW PNP SOT-323 SMALL	R564		038-14100-00	RES 0603 CHIP 1K0 1/16W +5%
Q517		000-10084-81	(S) XSTR SMD BC848BW NPN SOT-323 SMALL	R565		036-14270-00	RES M/F 0805 CHIP 2K7 5%
Q601		000-10084-81	(S) XSTR SMD BC848BW NPN SOT-323 SMALL	R566		038-16100-00	RES 0603 CHIP 100K 1/16W +5%
Q602		000-10084-81	(S) XSTR SMD BC848BW NPN SOT-323 SMALL	R566A		038-16100-00	RES 0603 CHIP 100K 1/16W +5%
Q604		000-10084-81	(S) XSTR SMD BC848BW NPN SOT-323 SMALL	R567		038-16100-00	RES 0603 CHIP 100K 1/16W +5%
Q605		000-10085-71	(S) XSTR SMD BC857BW PNP SOT-323 SMALL	R568		038-16100-00	RES 0603 CHIP 100K 1/16W +5%
Q606		000-10084-81	(S) XSTR SMD BC848BW NPN SOT-323 SMALL	R569		038-16100-00	RES 0603 CHIP 100K 1/16W +5%
Q607		000-10084-81	(S) XSTR SMD BC848BW NPN SOT-323 SMALL	R570		038-14470-00	RES 0603 CHIP 4K7 1/16W +5%
Q608		000-10084-81	(S) XSTR SMD BC848BW NPN SOT-323 SMALL	#R571	2020	038-10000-00	RES 0603 CHIP ZERO OHM 1/16W +5%
Q700		000-10084-81	(S) XSTR SMD BC848BW NPN SOT-323 SMALL	#R571	203X	038-16220-00	RES 0603 CHIP 220K 1/16W +5%
Q800		000-10003-12	(S) XSTR SMD BFR31 N JFET SOT-23	#R571	2040	038-16220-00	RES 0603 CHIP 220K 1/16W +5%
R400		038-15100-00	RES 0603 CHIP 10K 1/16W +5%	#R571	2050	038-16220-00	RES 0603 CHIP 220K 1/16W +5%
R402		038-15270-00	RES 0603 CHIP 27K 1/16W +5%	#R571	2060	038-10000-00	RES 0603 CHIP ZERO OHM 1/16W +5%
R403		038-15270-00	RES 0603 CHIP 27K 1/16W +5%	#R571	PE	038-16470-00	RES 0603 CHIP 470K 1/16W +5%
R500		038-13470-00	RES 0603 CHIP 470E 1/16W +5%	R572		038-15100-00	RES 0603 CHIP 10K 1/16W +5%
R501		038-15470-00	RES 0603 CHIP 47K 1/16W +5%	R573		038-16100-00	RES 0603 CHIP 100K 1/16W +5%
R502		038-15470-00	RES 0603 CHIP 47K 1/16W +5%	R578		038-15470-00	RES 0603 CHIP 47K 1/16W +5%
				R580		038-14220-00	RES 0603 CHIP 2K2 1/16W +5%
				R581		038-14220-00	RES 0603 CHIP 2K2 1/16W +5%
				R582		038-13470-00	RES 0603 CHIP 470E 1/16W +5%
				R583		038-13470-00	RES 0603 CHIP 470E 1/16W +5%
				R584		038-15470-00	RES 0603 CHIP 47K 1/16W +5%
				R589		038-16100-00	RES 0603 CHIP 100K 1/16W +5%
				R590		038-16470-00	RES 0603 CHIP 470K 1/16W +5%
				R591		036-13680-00	RES M/F 0805 CHIP 680E 5%

Ref	Var	IPN	Description	Ref	Var	IPN	Description
R592		036-13680-00	RES M/F 0805 CHIP 680E 5%	R675		038-15470-00	RES 0603 CHIP 47K 1/16W +5%
R594		038-16100-00	RES 0603 CHIP 100K 1/16W +5%	R676		038-15470-00	RES 0603 CHIP 47K 1/16W +5%
#R596	2020	036-15390-00	RES M/F 0805 CHIP 39K 5%	R677		038-15100-00	RES 0603 CHIP 10K 1/16W +5%
#R596	203X	036-15390-00	RES M/F 0805 CHIP 39K 5%	R678		038-16100-00	RES 0603 CHIP 100K 1/16W +5%
#R596	2040	036-15390-00	RES M/F 0805 CHIP 39K 5%	R679		038-15470-00	RES 0603 CHIP 47K 1/16W +5%
#R596	2050	036-15390-00	RES M/F 0805 CHIP 39K 5%	R680		036-14270-00	RES M/F 0805 CHIP 2K7 5%
#R596	2060	036-15390-00	RES M/F 0805 CHIP 39K 5%	R681		038-15100-00	RES 0603 CHIP 10K 1/16W +5%
#R597	2020	038-15100-00	RES 0603 CHIP 10K 1/16W +5%	R682		036-14180-00	RES M/F 0805 CHIP 1K8 5%
#R597	203X	038-15100-00	RES 0603 CHIP 10K 1/16W +5%	R683		038-15100-00	RES 0603 CHIP 10K 1/16W +5%
#R597	2040	038-15100-00	RES 0603 CHIP 10K 1/16W +5%	R684		036-16120-00	RES M/F 0805 CHIP 120K 5%
#R597	2050	038-15100-00	RES 0603 CHIP 10K 1/16W +5%	R685		038-10000-00	RES 0603 CHIP ZERO OHM 1/16W +5%
#R597	2060	038-15100-00	RES 0603 CHIP 10K 1/16W +5%	R686		038-15470-00	RES 0603 CHIP 47K 1/16W +5%
R598		038-16220-00	RES 0603 CHIP 220K 1/16W +5%	R687		038-15100-00	RES 0603 CHIP 10K 1/16W +5%
#RV599	203X	042-15500-01	RES PRESET SMD 50K +25% 4X4.5X2.	R688		038-15100-00	RES 0603 CHIP 10K 1/16W +5%
#RV599	2040	042-15500-01	RES PRESET SMD 50K +25% 4X4.5X2.	R689		038-15100-00	RES 0603 CHIP 10K 1/16W +5%
#RV599	2050	042-15500-01	RES PRESET SMD 50K +25% 4X4.5X2.	R690		038-15150-00	RES 0603 CHIP 15K 1/16W +5%
R600		038-13220-00	RES 0603 CHIP 220E 1/16W +5%	R691		038-14220-00	RES 0603 CHIP 2K2 1/16W +5%
R602		036-14820-00	RES M/F 0805 CHIP 8K2 5%	R692		036-15220-00	RES M/F 0805 CHIP 22K 5%
R603		038-16100-00	RES 0603 CHIP 100K 1/16W +5%	R699		038-15470-00	RES 0603 CHIP 47K 1/16W +5%
R604		038-16220-00	RES 0603 CHIP 220K 1/16W +5%	R700		038-15470-00	RES 0603 CHIP 47K 1/16W +5%
R605		038-16220-00	RES 0603 CHIP 220K 1/16W +5%	R701		038-14470-00	RES 0603 CHIP 4K7 1/16W +5%
R606		038-16470-00	RES 0603 CHIP 470K 1/16W +5%	R702		038-14220-00	RES 0603 CHIP 2K2 1/16W +5%
R607		038-16100-00	RES 0603 CHIP 100K 1/16W +5%	R704		038-13330-00	RES 0603 CHIP 330E 1/16W +5%
R608		036-15220-00	RES M/F 0805 CHIP 22K 5%	R705		038-14220-00	RES 0603 CHIP 2K2 1/16W +5%
R609		038-16220-00	RES M/F 0805 CHIP 220K 1/16W +5%	R706		038-14220-00	RES 0603 CHIP 2K2 1/16W +5%
R610		038-10000-00	RES 0603 CHIP ZERO OHM 1/16W +5%	R709		038-14100-00	RES 0603 CHIP 1K0 1/16W +5%
R611		038-16220-00	RES 0603 CHIP 220K 1/16W +5%	R710		038-13220-00	RES 0603 CHIP 220E 1/16W +5%
R613		038-16100-00	RES 0603 CHIP 100K 1/16W +5%	R711		038-14220-00	RES 0603 CHIP 2K2 1/16W +5%
R614		038-16220-00	RES 0603 CHIP 220K 1/16W +5%	R712		038-15100-00	RES 0603 CHIP 10K 1/16W +5%
R615		036-15270-00	RES M/F 0805 CHIP 27K 5%	R714		038-10000-00	RES 0603 CHIP ZERO OHM 1/16W +5%
R616		036-16150-00	RES M/F 0805 CHIP 150K 5%	#R717	203X	038-10000-00	RES 0603 CHIP ZERO OHM 1/16W +5%
R617		036-16150-00	RES M/F 0805 CHIP 150K 5%	#R717	2040	038-10000-00	RES 0603 CHIP ZERO OHM 1/16W +5%
R619		038-15270-00	RES 0603 CHIP 27K 1/16W +5%	#R717	2050	038-10000-00	RES 0603 CHIP ZERO OHM 1/16W +5%
R620		038-15100-00	RES 0603 CHIP 10K 1/16W +5%	#R717A	2020	038-10000-00	RES 0603 CHIP ZERO OHM 1/16W +5%
R621		036-16390-00	RES M/F 0805 CHIP 390K 5%	#R717A	2060	038-10000-00	RES 0603 CHIP ZERO OHM 1/16W +5%
R622		038-15100-00	RES 0603 CHIP 10K 1/16W +5%	#R720	2020	038-10000-00	RES 0603 CHIP ZERO OHM 1/16W +5%
R623		038-14680-00	RES 0603 CHIP 6K8 1/16W +5%	#R720	203X	038-10000-00	RES 0603 CHIP ZERO OHM 1/16W +5%
R624		038-15100-00	RES 0603 CHIP 10K 1/16W +5%	#R720	2040	038-10000-00	RES 0603 CHIP ZERO OHM 1/16W +5%
R625		038-14680-00	RES 0603 CHIP 6K8 1/16W +5%	#R720	2060	038-10000-00	RES 0603 CHIP ZERO OHM 1/16W +5%
R626		038-15270-00	RES 0603 CHIP 27K 1/16W +5%	R721		038-14470-00	RES 0603 CHIP 4K7 1/16W +5%
R627		036-16390-00	RES M/F 0805 CHIP 390K 5%	#R730	2020	038-10000-00	RES 0603 CHIP ZERO OHM 1/16W +5%
R628		038-15100-00	RES 0603 CHIP 10K 1/16W +5%	#R730	203X	038-10000-00	RES 0603 CHIP ZERO OHM 1/16W +5%
R629		038-15270-00	RES 0603 CHIP 27K 1/16W +5%	#R730	2040	038-10000-00	RES 0603 CHIP ZERO OHM 1/16W +5%
R630		038-17100-00	RES 0603 CHIP 1M 1/16W +5%	#R730	2060	038-10000-00	RES 0603 CHIP ZERO OHM 1/16W +5%
R631		038-14100-00	RES 0603 CHIP 1K0 1/16W +5%	#R731	2020	038-10000-00	RES 0603 CHIP ZERO OHM 1/16W +5%
R632		036-16390-00	RES M/F 0805 CHIP 390K 5%	#R731	203X	038-10000-00	RES 0603 CHIP ZERO OHM 1/16W +5%
R633		038-15100-00	RES 0603 CHIP 10K 1/16W +5%	#R731	2040	038-10000-00	RES 0603 CHIP ZERO OHM 1/16W +5%
R634		038-14680-00	RES 0603 CHIP 6K8 1/16W +5%	#R731	2060	038-10000-00	RES 0603 CHIP ZERO OHM 1/16W +5%
R635		038-16220-00	RES 0603 CHIP 220K 1/16W +5%	#R732	2020	038-10000-00	RES 0603 CHIP ZERO OHM 1/16W +5%
R636		038-16100-00	RES 0603 CHIP 100K 1/16W +5%	#R732	203X	038-10000-00	RES 0603 CHIP ZERO OHM 1/16W +5%
R637		038-16100-00	RES 0603 CHIP 100K 1/16W +5%	#R732	2040	038-10000-00	RES 0603 CHIP ZERO OHM 1/16W +5%
R638		038-15100-00	RES 0603 CHIP 10K 1/16W +5%	#R732	2060	038-10000-00	RES 0603 CHIP ZERO OHM 1/16W +5%
R639		038-14220-00	RES 0603 CHIP 2K2 1/16W +5%	R801		038-16100-00	RES 0603 CHIP 100K 1/16W +5%
R640		038-17100-00	RES 0603 CHIP 1M 1/16W +5%	R802		038-16220-00	RES 0603 CHIP 220K 1/16W +5%
R641		036-16150-00	RES M/F 0805 CHIP 150K 5%	R803		036-16470-00	RES M/F 0805 CHIP 470K 5%
R642		038-16100-00	RES 0603 CHIP 100K 1/16W +5%	R804		038-15470-00	RES 0603 CHIP 47K 1/16W +5%
R643		036-16330-00	RES M/F 0805 CHIP 330K 5%	R805		038-13680-00	RES 0603 CHIP 680E 1/16W +5%
R644		038-17100-00	RES 0603 CHIP 1M 1/16W +5%	R806		038-16100-00	RES 0603 CHIP 100K 1/16W +5%
R645		038-16100-00	RES 0603 CHIP 100K 1/16W +5%	R807		038-15470-00	RES 0603 CHIP 47K 1/16W +5%
R646		036-16330-00	RES M/F 0805 CHIP 330K 5%	R808		038-14220-00	RES 0603 CHIP 2K2 1/16W +5%
R647		038-14220-00	RES 0603 CHIP 2K2 1/16W +5%	R809		038-14470-00	RES 0603 CHIP 4K7 1/16W +5%
R648		038-16220-00	RES 0603 CHIP 220K 1/16W +5%	R810		038-13220-00	RES 0603 CHIP 220E 1/16W +5%
R649		038-17100-00	RES 0603 CHIP 1M 1/16W +5%	R811		038-12220-00	RES 0603 CHIP 22E 1/16W +5%
R650		038-14100-00	RES 0603 CHIP 1K0 1/16W +5%	R812		038-10000-00	RES 0603 CHIP ZERO OHM 1/16W +5%
R651		038-15150-00	RES 0603 CHIP 15K 1/16W +5%	S1		240-10000-07	CONN SMD SKT 16WAY 2ROW MICROMATCH
R652		038-15100-00	RES 0603 CHIP 10K 1/16W +5%	S2		240-10000-06	CONN SMD SKT 12WAY 2ROW MICROMATCH
R653		038-13680-00	RES 0603 CHIP 680E 1/16W +5%	#S8	203X	240-10000-07	CONN SMD SKT 16WAY 2ROW MICROMATCH
#R656	2020	038-10000-00	RES 0603 CHIP ZERO OHM 1/16W +5%	#S8	2060	240-10000-07	CONN SMD SKT 16WAY 2ROW MICROMATCH
#R656	2040	038-10000-00	RES 0603 CHIP ZERO OHM 1/16W +5%	#S9	2020	240-10000-05	CONN SMD SKT 8WAY 2ROW MICROMATCH
#R656	2050	038-10000-00	RES 0603 CHIP ZERO OHM 1/16W +5%	#S9	2040	240-10000-05	CONN SMD SKT 8WAY 2ROW MICROMATCH
R658		036-16150-00	RES M/F 0805 CHIP 150K 5%	#S9	2050	240-10000-05	CONN SMD SKT 8WAY 2ROW MICROMATCH
R659		038-13680-00	RES 0603 CHIP 680E 1/16W +5%	#S13	DATA	240-10000-06	CONN SMD SKT 12WAY 2ROW MICROMATCH
R660		038-15470-00	RES 0603 CHIP 47K 1/16W +5%	#S14	DATA	240-10000-07	CONN SMD SKT 16WAY 2ROW MICROMATCH
R662		038-14100-00	RES 0603 CHIP 1K0 1/16W +5%	#S16	DATA	240-10000-06	CONN SMD SKT 12WAY 2ROW MICROMATCH
R663		038-15470-00	RES 0603 CHIP 47K 1/16W +5%	#S17	DATA	240-10000-06	CONN SMD SKT 12WAY 2ROW MICROMATCH
R664		036-15220-00	RES M/F 0805 CHIP 22K 5%	#S18	DATA	240-10000-06	CONN SMD SKT 12WAY 2ROW MICROMATCH
R665		038-16470-00	RES 0603 CHIP 470K 1/16W +5%	SK501		240-04043-20	SKT 32 PIN SMD PLCC CHIP CARRIER
R666		036-16150-00	RES M/F 0805 CHIP 150K 5%	TP610		005-10000-10	TEST POINT SMD 0805 2.0 X 1.25 X 1.45
R667		038-17100-00	RES 0603 CHIP 1M 1/16W +5%	#T3K44		240-10000-01	CONN SMD 24WAY (PLUG)
R668		038-16470-00	RES 0603 CHIP 470K 1/16W +5%	#T3K45		240-10000-01	CONN SMD 24WAY (PLUG)
R669		036-14180-00	RES M/F 0805 CHIP 1K8 5%	X501		274-01072-00	XTAL 8.064MHZ HC-49U/S HOLDER C/W TEFLON
R670		038-15100-00	RES 0603 CHIP 10K 1/16W +5%				
R671		038-14470-00	RES 0603 CHIP 4K7 1/16W +5%				
R672		038-15100-00	RES 0603 CHIP 10K 1/16W +5%				
R673		038-15100-00	RES 0603 CHIP 10K 1/16W +5%				
R674		038-15100-00	RES 0603 CHIP 10K 1/16W +5%				

Variants: PE = Pre-emphasised FFSK

DATA = Data ratio

## T2000 HC11 Logic Mechanical & Miscellaneous Parts

IPN	Description	IPN	Description
220-01344-02	(L) PCB T2000 LOGIC HCII COMMON PLATFORM		
240-00020-11	PLUG MICROPHONE BT SR937		
240-00100-13	PLUG COAX BNC CORD MTG CRIMP URM76		
240-02010-75	SKT RECEPTL SML 172775-1		
240-04021-63	CONN 2WAY 24AWG (BLACK) INLINE HERMAPHRODITIC PACK LOOSE IN INSTALLATION KIT		
252-00010-37	MIC AWC DYNAMIC 600E 6WAY M095D TINSEL SHLD'D		
252-00010-49	MIC CLIP (SPRING STEEL CONTACT)		
265-00010-60	FUSE 10A 12V AUTOMOTIVE STAPLE TYPE		
303-23134-02	COVER TOP A1M2504 T2000 PNTD CMLPT		
303-30062-02	CRADLE BODY A3M2551 T2000 BOTTOM		
303-30063-02	CRADLE BODY A3M2552 T2000 TOP		
303-30064-00	CRADLE CLIP A1M2550 T2000		
303-30065-01	KEY A3M2553 CRADLE T2000		
340-00010-23	FUSEHLDR INLINE 3M 972		
349-00010-49	SCREW SELFTAP NO 10X1/2 IN TYPE AB PAN POZI B		
353-00010-32	WASHER M5 SHAKEPROOF EXT BZ		
360-02003-01	GROMMET MIC CORD T2000 SII		
365-01391-01	(L)LABEL BLNK 30*10.8MM TAMPERMARK VOID MATT		
399-00010-52	BAG PLASTIC 100*150MM		
410-01099-01	(L) PKG CARTON T2000 SERIES II		
410-01101-00	CARTON T700/T2000 OUTER (5 UNIT EA)		
<b>T2020 MECHANICAL PARTS</b>			
005-00000-40	MODULE RMT 5W 4OHM SPKR IN ENCLSR T2000 PACF		
219-02585-00	CABLE ASSEMBLY T2000 ENHD PWR/SPKR CABLE		
409-20203-00	OPER MANL T2020 (INTERNATIONAL)		
<b>T203X MECHANICAL PARTS</b>			
219-02584-00	CABLE ASSEMBLY T2000 PWR CABLE		
<b>T2040 MECHANICAL PARTS</b>			
219-02584-00	CABLE ASSEMBLY T2000 PWR CABLE		

## T2000 HC11 Logic Grid Reference Index (IPN 220-01344-02)

Device	PCB	Circuit	Device	PCB	Circuit	Device	PCB	Circuit	Device	PCB	Circuit
#012	1:L11	1-T1	C622	1:G3	1-H3	IC502	1:F22	2-B0	Q508	1:C13	2-R4
#014	1:L11	1-T1	C623	1:C4	1-L3		1:F22	2-M6	Q509	1:K10	2-D6
#015	1:L11	1-T1	C624	1:C8	1-N5		1:F22	2-R5	Q510	1:B7	2-L3
#016	1:M11	1-T1	C625	1:D7	1-O5		1:F22	2-S5	#Q511	1:M4	2-V9
#017	1:M11	1-U1	C626	1:D9	1-O4		1:F22	2-T5	Q513	1:G14	2-T2
#018	1:M11	1-U1	C627	1:D8	1-N3	#IC503	1:L22	2-N5	Q514	1:J11	2-C4
#019	1:N11	1-U1	C628	1:D4	1-M2	IC504	1:N20	2-S9	Q515	1:G11	2-C4
A15ROM	2:H17	2-F5	C629	1:D8	1-N2	IC505	1:K19	2-Q5	Q516	1:G11	2-D4
A16ROM	2:H17	2-F5	C630	1:N9	1-U4	IC510	1:K5	2-V5	Q517	1:F11	2-D4
ALC	2:L6	1-V1	#C631	1:K6	1-V5		1:K5	2-U3	Q601	1:J9	1-J4
BOARD	2:N11	1-S1	#C632	1:K9	1-P4	IC511	1:G22	2-S5	Q602	1:C9	1-M4
C501	1:J12	2-C5	C635	1:L3	2-A8		1:G22	2-A0	Q604	1:D10	1-W5
C502	1:K13	2-L8	C636	1:P8	1-V4	IC513	1:M2	2-A8	Q605	1:M6	1-T3
C503	1:P20	2-T9	C637	1:M7	1-V3	IC514	1:N2	2-A9	Q606	1:P9	1-W4
C504	1:N18	2-Q8	C638	1:M6	1-V3	#IC517	1:G13	2-Q1	Q607	1:L8	1-W3
C505	1:N22	2-R5	C639	1:L8	1-V2	IC555	1:D16	2-I2	Q608	1:D10	1-W5
C506	1:N21	2-Q5	C635A	1:J3	2-A8	IC601	1:F3	1-E3	Q700	1:K6	1-S6
C507	1:N21	2-Q5	C640	1:N3	1-U2		1:F3	1-Q9	Q800	1:G6	1-C6
C508	1:P21	2-P5	C641	1:L6	1-S3		1:F3	1-G2	Q802	1:G4	1-I6
C509	1:K12	2-D5	C642	1:L7	1-R3		1:F3	1-H2			
C510	1:C3	2-L0	C643	1:L9	1-Q3		1:F3	1-C2	R400	1:F11	2-D4
C511	1:H15	2-U4	C644	1:M9	1-Q3	IC603	1:M8	1-V8	R402	1:G11	2-D4
C512	1:H12	2-D3	C645	1:B2	2-B7		1:M8	1-Q9	R403	1:F11	2-D4
C514	1:M3	2-B9	C646	1:M9	1-Q2		1:M8	1-Q2	R500	1:L5	2-T7
C516	1:B22	2-U2	C647	1:M7	1-S3		1:M8	1-R3	R501	1:N17	2-B7
C517	1:K11	2-E6	C648	1:F1	1-E2		1:M8	1-V3	R502	1:N18	2-C7
C519	1:N19	2-P8	C650	1:C9	1-L4	IC604	1:J13	1-V7	R503	1:J10	2-C4
C514A	1:M3	2-A9	C651	1:C8	1-N4		1:J13	2-E3	R504	1:H11	2-E0
C514B	1:N3	2-B9	C652	1:J6	2-U6		1:J13	1-R9	R505	1:K11	2-E5
C520	1:H15	2-P3	C653	1:J6	2-V6		1:J13	2-S2	R506	1:K11	2-E5
C522	1:K2	2-B4	#C660	1:C5	1-I5		1:J13	2-C5	R507	1:G17	2-F8
C523	1:H11	2-C4	#C661	1:C5	1-J5	#IC605	1:J14	1-S9	R508	1:K12	2-D5
C524	1:D3	2-B6	#C662	1:E10	1-T6		1:J14	1-G8	R509	1:J11	2-B6
C525	1:L3	2-B3	#C663	1:J16	1-S9		1:J14	1-H8	R510	1:J11	2-C5
C526	1:M3	2-B3	C700	1:K7	1-Q7		1:J14	1-H8	R511	1:J11	2-D3
C527	1:L3	2-E3	C701	1:H8	1-R7		1:J14	1-I8	R512	1:H11	2-D3
C529	1:L11	1-V6	#C703	1:K8	1-Q7	#IC606	1:J15	1-T9	R514	1:H11	2-D2
C530	1:D2	1-V6	#C704	1:J7	1-Q6		1:J15	1-V9	R515	1:H12	2-E2
C532	1:K4	2-V8	C705	1:L6	1-R6		1:J15	1-V9	R516	1:F11	2-E3
C533	1:H15	2-U2	#C706	1:K6	1-S7		1:J15	1-I8	#R517	1:H11	2-C4
C534	1:F14	2-S3	C720	1:G17	2-G8		1:J15	1-J7	R518	1:K11	2-B6
C535	1:H14	2-S1	C721	1:C18	2-F2	IC614	1:F4	1-H7	R519	1:E11	2-E5
C536	1:G11	2-R1	C722	1:G21	2-B0		1:F4	1-T8	R520	1:H11	2-E2
C537	1:C8	2-S0	C801	1:D6	1-G6		1:F4	1-M3	R521	1:L11	2-D6
C538	1:B21	2-T1	C802	1:D6	1-G6	IC801	1:F4	1-J3	R522	1:K11	2-D6
C540	1:G7	1-D7	C803	1:E6	1-G6		1:F6	1-F6	R523	1:J11	2-B5
C541	1:G7	1-E7	C804	1:E6	1-H6		1:F6	1-Q9	#R524	1:H11	2-C4
C550	1:G21	2-O6	C805	1:D5	1-G6		1:F6	1-H7	R525	1:P20	2-T9
C560	1:G21	2-C0	C806	1:D7	1-K6		1:F6	1-J6	R526	1:P20	2-S9
C570	1:F16	2-J6	C808	1:D6	1-L7		1:F6	1-L6	R529	1:J11	2-C3
C571	1:F16	2-I6	#C810	1:F13	2-S2	IC802	1:E8	1-O3	R525A	1:P20	2-T9
C600	1:K5	2-T7	C811	1:K12	2-S2		1:E8	1-K2	R530	1:N19	2-Q8
C601	1:P1	1-C8	#C812	1:F13	2-S2		1:E8	1-R9	R531	1:N20	2-R8
C602	1:E3	1-B2	C813	1:F14	2-S1	ID	2:N11	1-S1	R532	1:K21	2-R8
C603	1:D3	1-C3	C814	1:F8	1-P9				R533	1:K21	2-R8
C605	1:D4	1-A2	C815	1:G7	1-C6	L501	1:G7	1-D8	R534	1:K21	2-R8
C607	1:G5	1-D6	D502	1:H3	2-U7				R535	1:N19	2-P8
C608	1:G6	1-D6		1:H3	2-U7	MANUAL	2:N16	2-S8	R537	1:B7	2-L3
C609	1:G6	1-D6	D503	1:C9	2-N1	MODE	2:H18	2-O8	R538	1:B7	2-L3
C610	1:D3	1-D3		1:C9	2-M0	ONLY	2:N19	2-S7	R539	1:N21	2-Q5
C611	1:G6	1-E6	D800	1:E7	1-K7				R540	1:N21	2-Q5
C613	1:E2	1-E3		1:E7	1-K6	P1	1:K15	2-U0	R541	1:N21	2-P5
C614	1:D2	1-E3	DISABLE	2:L6	1-V2	PAD1	2:F11	2-F4	R543	1:H3	2-T9
C615	1:G2	1-F3	#F01	1:N11	1-V1	PAD2	2:G4	2-V9	R544	1:H3	2-U7
C616	1:G2	1-F3	#F02	1:N11	1-V1	PAD3	2:N5	2-C2	R545	1:H3	2-U8
C617	1:G2	1-H3	#F03	1:P11	1-V1	PAD6	2:B9	2-O4	R547	1:D11	2-K3
C618	1:G3	1-H3	FACTORY	2:N19	2-S7				R548	1:E11	2-K0
C619	1:G4	1-I3	FIDA	1:F15	1-H1	Q501	1:N18	2-C7	R549	1:D11	2-K3
C620	1:G4	1-J3	FIDB	1:C17	1-H1	Q504	1:P21	2-Q5	R550	1:D12	2-K3
C621	1:G3	1-J3	#IC500	1:D19	2-F1	Q505	1:D12	2-K3	#R552	1:K22	2-N6
						Q506	1:H3	2-T8	R551	1:G16	2-O5
						Q507	1:C14	2-Q4	R553	1:K21	2-P8
									R554	1:F11	2-F4

Device	PCB	Circuit	Device	PCB	Circuit	Device	PCB	Circuit	Device	PCB	Circuit
R556	1:N18	2-P8	R647	1:E9	1-O2	R811	1:E8	1-Q9	1:B9	2-M0	
R559	1:L4	2-W8	R648	1:C8	1-M5	R812	1:C3	2-L0	1:B9	2-M0	
R560	1:L4	2-W8	R649	1:P9	1-V4	RESET	2:N16	2-S8	1:B9	2-M0	
R562	1:G14	2-T3	R650	1:K9	1-W3	RV507	1:D22	2-D5	1:B9	2-L0	
R563	1:G15	2-T2	R651	1:C2	2-C7	#RV508	1:B22	2-U1	1:B9	2-P0	
R564	1:G14	2-T2	R652	1:C2	2-W6	#RV599	1:C22	2-T1	1:B9	2-P0	
R565	1:G14	2-T3	R653	1:J6	2-V6				1:B9	2-O0	
R566	1:G14	2-R3	#R656	1:J6	2-U6	S1	1:L1	2-A1	1:B9	2-O0	
R567	1:F13	2-S2	R658	1:P9	1-U4		1:L1	2-A3	1:B9	2-O0	
R568	1:K13	2-S2	R659	1:J6	2-U6		1:L1	2-A2	1:B9	2-O0	
R569	1:K13	2-S2	R660	1:P9	1-V5		1:L1	2-A2	1:B9	2-N0	
R566A	1:F14	2-R3	R662	1:P10	1-W4		1:L1	2-A2	#S16	1:B13	2-H9
#R571	1:F14	2-S1	R663	1:D10	1-V5		1:L1	2-A2	#S16	1:B13	2-C9
R570	1:H18	2-M8	R664	1:P8	1-V4		1:L1	2-A2		1:B13	2-C9
R572	1:N18	2-C7	R665	1:M7	1-U3		1:L1	2-A2		1:B13	2-J9
R573	1:H14	2-T1	R666	1:M5	1-W2		1:L1	2-A1		1:B13	2-C9
R578	1:C14	2-Q3	R667	1:M5	1-U2		1:L1	2-A4		1:B13	2-H9
#R579	1:H14	2-P1	R668	1:M6	1-U3		1:L1	2-A4		1:B13	2-I9
R580	1:C14	2-Q4	R669	1:M5	1-U2		1:L1	2-A3		1:B13	2-I9
R581	1:C14	2-R4	R670	1:M6	1-T3		1:L1	2-A3		1:B13	2-I9
R582	1:C14	2-Q3	R671	1:M5	1-T2		1:L1	2-A3		1:B13	2-I9
R583	1:C14	2-R3	R672	1:M6	1-T3		1:L1	2-A3		1:B13	2-I9
R584	1:B10	2-S0	R673	1:M6	1-S3		1:L1	2-A3		1:B13	2-J9
R589	1:B21	2-U1	R674	1:L6	1-S3	S2	1:C1	2-A7	#S17	1:B16	2-H9
R590	1:C4	2-J0	R675	1:M7	1-S2		1:C1	2-A6		1:B16	2-H9
R591	1:D13	2-R3	R676	1:L7	1-R3		1:C1	2-A6		1:B16	2-F9
R592	1:C13	2-S3	R677	1:M9	1-R3		1:C1	2-A6		1:B16	2-F9
#R593	1:J14	2-Q1	R678	1:M9	1-Q2		1:C1	2-A6		1:B16	2-H9
R594	1:B22	2-U2	R679	1:M8	1-Q3		1:C1	2-A6		1:B16	2-G9
#R596	1:B21	2-U1	R680	1:M6	1-U3		1:C1	2-A7		1:B16	2-G9
#R597	1:B21	2-U1	R681	1:L8	1-P2		1:C1	2-A7		1:B16	2-G9
R598	1:B22	2-T1	R682	1:M9	1-Q2		1:C1	2-A7		1:B16	2-G9
R600	1:E6	1-L7	R683	1:M9	1-Q2		1:C1	2-A7		1:B16	2-G9
R602	1:G1	1-D2	R684	1:D6	1-G6		1:C1	2-A7		1:B16	2-F9
R603	1:E4	1-A3	R685	1:M5	1-U2		1:C1	2-A5		1:B16	2-F9
R604	1:E4	1-B3	R686	1:D10	1-V5	#S8	1:H5	2-V5	#S18	1:B20	2-D9
R605	1:E3	1-B3	R687	1:E4	1-A3		1:H5	2-V5		1:B20	2-F9
R606	1:G7	1-C6	R688	1:E4	1-A2		1:H5	2-V6		1:B20	2-D9
R607	1:G6	1-D6	R689	1:G7	1-C8		1:H5	2-V5		1:B20	2-D9
R608	1:E3	1-D3	R690	1:F7	1-D8		1:H5	2-V4		1:B20	2-E9
R609	1:G2	1-D2	R691	1:N10	1-T4		1:H5	2-V4		1:B20	2-E9
R610	1:J2	2-A5	R692	1:D4	1-C6		1:H5	2-V4		1:B20	2-E9
R611	1:E2	1-E3	R699	1:K22	2-N5		1:H5	2-V4		1:B20	2-E9
R613	1:G6	1-D6	R700	1:K22	2-O5		1:H5	2-V4		1:B20	2-E9
R614	1:G6	1-E6	#R700	1:J8	1-Q7		1:H5	2-V4		1:B20	2-C9
R615	1:D5	1-F6	R701	1:K7	1-Q7		1:H5	2-V6		1:B20	2-D9
R616	1:D5	1-G6	R702	1:K7	1-R7		1:H5	2-V5		1:B20	2-D9
R617	1:E5	1-G6	R704	1:K7	1-R7		1:H5	2-V5	SK501	1:G19	2-F6
R619	1:G1	1-F2	R705	1:K6	1-S7		1:H5	2-V5			
R620	1:D2	1-E2	R706	1:K7	1-Q7		1:H5	2-V5	#T3K44	1:F9	2-V0
R621	1:G2	1-F2	R709	1:J7	1-Q6		1:H5	2-V5	#T3K45	1:C11	1-A1
R622	1:E4	1-C2	R710	1:J7	1-Q6	#S9	1:K4	2-V7	TEST	2:H18	2-O8
R623	1:G2	1-G3	R711	1:K7	1-R6		1:K4	2-V6	TP602	2:G4	1-F6
R624	1:F2	1-G2	R712	1:K6	1-R7		1:K4	2-V7	TP606	2:G16	2-K3
R625	1:G4	1-I3	#R713	1:F17	2-E7		1:K4	2-V7	TP607	2:G16	2-K3
R626	1:F3	1-H2	R714	1:G17	2-G6		1:K4	2-V7	TP608	2:G16	2-K3
R627	1:G2	1-H2	R715	1:F17	2-G6		1:K4	2-V7	TP609	1:F17	2-K3
R628	1:F4	1-I2	R716	1:F17	2-E7		1:K4	2-V7	TP610	1:B11	2-P0
R629	1:G4	1-J2	#R717	1:G17	2-G6		1:K4	2-V7			
R630	1:C4	1-M2	#R717A	1:H17	2-F6	#S13	1:B4	2-I0	X501	1:M21	2-Q6
R631	1:C4	1-M2	#R720	1:K9	1-P4		1:B4	2-K0			
R632	1:G2	1-J2	R721	1:D7	1-J7		1:B4	2-K0			
R633	1:H3	1-K2	#R730	1:C5	1-L5		1:B4	2-J0			
R634	1:G3	1-K3	#R731	1:C5	1-S5		1:B4	2-J0			
R635	1:H9	1-J5	#R732	1:N8	1-T5		1:B4	2-J0			
R636	1:J9	1-K4	#R733	1:N8	1-T6		1:B4	2-J0			
R637	1:C3	1-L2	R801	1:G5	1-I7		1:B4	2-I0			
R638	1:C3	1-L3	R802	1:G4	1-I6		1:B4	2-I0			
R639	1:C4	2-B2	R803	1:E7	1-J6		1:B4	2-I0			
R640	1:C4	1-L2	R804	1:E7	1-J6		1:B4	2-K0			
R641	1:D8	1-N3	R805	1:E7	1-K6		1:B4	2-K0			
R642	1:C9	1-M4	R806	1:F7	1-K7	#S14	1:B9	2-N0			
R643	1:D8	1-N2	R807	1:F7	1-K6		1:B9	2-L0			
R644	1:D8	1-N3	R808	1:F7	1-L7		1:B9	2-N0			
R645	1:C7	1-O5	R809	1:F7	1-M6		1:B9	2-N0			
R646	1:D8	1-O3	R810	1:D6	1-M7		1:B9	2-M0			

# 7.11 T2020, T203X, T2040, T2050 & T2060 HC11 Logic PCB

## T2000 HC11 Logic Parts List (IPN 220-01344-04)

Parts List Amendments	

Ref	Var	IPN	Description	Ref	Var	IPN	Description
#012	2050	038-13680-00	RES 0603 CHIP 680E 1/16W +5%	C626		014-07470-01	CAP TANT CHIP 4U7 'B' CASE 25V +10% 26
#015	2020	038-14470-00	RES 0603 CHIP 4K7 1/16W +5%	C627		015-06100-08	CAP CER 1206 CHIP 100N 10% X7R 50V
#017	2060	038-15100-00	RES 0603 CHIP 10K 1/16W +5%	C628		018-15100-00	CAP 0603 CHIP 10N 50V X7R +10%
#018	203X	038-15270-00	RES 0603 CHIP 27K 1/16W +5%	C629		015-23220-01	CAP CER 0805 CHIP 220P 5% NPO 50V
#019	2040	038-15470-00	RES 0603 CHIP 47K 1/16W +5%	C630		015-25150-08	CAP CER 0805 CHIP 15N 10% X7R 50V
C501		015-23680-08	CAP CER 0805 CHIP 680P 10% X7R 50V	#C631	2020	015-06100-08	CAP CER 1206 CHIP 100N 10% X7R 50V
C502		018-16100-01	CAP 0603 CHIP 100N +80-20% Y5V 16V	#C631	2040	015-06100-08	CAP CER 1206 CHIP 100N 10% X7R 50V
C503		018-16100-01	CAP 0603 CHIP 100N +80-20% Y5V 16V	#C631	2050	015-06100-08	CAP CER 1206 CHIP 100N 10% X7R 50V
C504		018-16100-01	CAP 0603 CHIP 100N +80-20% Y5V 16V	C635		016-08470-01	CAP ELECT SMD 6X4MM 47M 16V
C505		018-12390-10	CAP 0603 CHIP 39P 50V NPO +1%	C635A		016-08470-01	CAP ELECT SMD 6X4MM 47M 16V
C506		018-12220-10	CAP 0603 CHIP 22P 50V NPO +1%	C636		015-06100-08	CAP CER 1206 CHIP 100N 10% X7R 50V
C507		018-12270-10	CAP 0603 CHIP 27P 50V NPO +1%	C637		018-11470-10	CAP 0603 CHIP 4P7 50V NPO +0.1P
C508		018-16100-01	CAP 0603 CHIP 100N +80-20% Y5V 16V	C638		018-16100-01	CAP 0603 CHIP 100N +80-20% Y5V 16V
C509		018-14100-00	CAP 0603 CHIP 1N 50V X7R +10%	C639		016-08470-01	CAP ELECT SMD 6X4MM 47M 16V
C510		018-15100-00	CAP 0603 CHIP 10N 50V X7R +10%	C640		016-08470-01	CAP ELECT SMD 6X4MM 47M 16V
C511		018-15100-00	CAP 0603 CHIP 10N 50V X7R +10%	C641		018-14100-00	CAP 0603 CHIP 1N 50V X7R +10%
C512		018-14100-00	CAP 0603 CHIP 1N 50V X7R +10%	C642		015-23220-01	CAP CER 0805 CHIP 220P 5% NPO 50V
C514		018-16100-01	CAP 0603 CHIP 100N +80-20% Y5V 16V	C643		015-25150-08	CAP CER 0805 CHIP 15N 10% X7R 50V
C514A		018-14100-00	CAP 0603 CHIP 1N 50V X7R +10%	C644		015-25150-08	CAP CER 0805 CHIP 15N 10% X7R 50V
C514B		018-14100-00	CAP 0603 CHIP 1N 50V X7R +10%	C645		018-13150-00	CAP 0603 CHIP 150P 50V NPO +5%
C516		018-16100-01	CAP 0603 CHIP 100N +80-20% Y5V 16V	C646		014-07470-01	CAP TANT CHIP 4U7 'B' CASE 25V +10% 26
C517		015-23680-08	CAP CER 0805 CHIP 680P 10% X7R 50V	C647		018-16100-01	CAP 0603 CHIP 100N +80-20% Y5V 16V
C519		018-16100-01	CAP 0603 CHIP 100N +80-20% Y5V 16V	C648		016-08470-01	CAP ELECT SMD 6X4MM 47M 16V
C520		018-16100-01	CAP 0603 CHIP 100N +80-20% Y5V 16V	C650		018-13150-00	CAP 0603 CHIP 150P 50V NPO +5%
C522		018-16100-01	CAP 0603 CHIP 100N +80-20% Y5V 16V	C651		018-13150-00	CAP 0603 CHIP 150P 50V NPO +5%
C523		018-16100-01	CAP 0603 CHIP 100N +80-20% Y5V 16V	C652		018-14100-00	CAP 0603 CHIP 1N 50V X7R +10%
C524		016-08470-01	CAP ELECT SMD 6X4MM 47M 16V	C653		018-14100-00	CAP 0603 CHIP 1N 50V X7R +10%
C525		018-13150-00	CAP 0603 CHIP 150P 50V NPO +5%	#C661	2020	018-16100-01	CAP 0603 CHIP 100N +80-20% Y5V 16V
C526		018-13150-00	CAP 0603 CHIP 150P 50V NPO +5%	#C661	203X	018-16100-01	CAP 0603 CHIP 100N +80-20% Y5V 16V
C527		018-13150-00	CAP 0603 CHIP 150P 50V NPO +5%	#C661	2040	018-16100-01	CAP 0603 CHIP 100N +80-20% Y5V 16V
C529		018-13150-00	CAP 0603 CHIP 150P 50V NPO +5%	#C661	2050	018-16100-01	CAP 0603 CHIP 100N +80-20% Y5V 16V
C530		018-13150-00	CAP 0603 CHIP 150P 50V NPO +5%	#C661	2060	018-16100-01	CAP 0603 CHIP 100N +80-20% Y5V 16V
C532		018-14100-00	CAP 0603 CHIP 1N 50V X7R +10%	#C662	2020	018-16100-01	CAP 0603 CHIP 100N +80-20% Y5V 16V
C533		018-16100-01	CAP 0603 CHIP 100N +80-20% Y5V 16V	#C662	203X	018-16100-01	CAP 0603 CHIP 100N +80-20% Y5V 16V
C534		018-16100-01	CAP 0603 CHIP 100N +80-20% Y5V 16V	#C662	2040	018-16100-01	CAP 0603 CHIP 100N +80-20% Y5V 16V
C535		018-16100-01	CAP 0603 CHIP 100N +80-20% Y5V 16V	#C662	2050	018-16100-01	CAP 0603 CHIP 100N +80-20% Y5V 16V
C536		014-07470-01	CAP TANT CHIP 4U7 'B' CASE 25V +10% 26	#C662	2060	018-16100-01	CAP 0603 CHIP 100N +80-20% Y5V 16V
C537		016-07470-01	CAP ELECT 6X4MM CHIP 4M7 20% 16V	#C663	2020	018-16100-01	CAP 0603 CHIP 100N +80-20% Y5V 16V
C538		018-16100-01	CAP 0603 CHIP 100N +80-20% Y5V 16V	#C663	203X	018-16100-01	CAP 0603 CHIP 100N +80-20% Y5V 16V
C540		018-13150-00	CAP 0603 CHIP 150P 50V NPO +5%	#C663	2040	018-16100-01	CAP 0603 CHIP 100N +80-20% Y5V 16V
C541		018-13150-00	CAP 0603 CHIP 150P 50V NPO +5%	#C663	2050	018-16100-01	CAP 0603 CHIP 100N +80-20% Y5V 16V
C550		018-16100-01	CAP 0603 CHIP 100N +80-20% Y5V 16V	#C663	2060	018-16100-01	CAP 0603 CHIP 100N +80-20% Y5V 16V
C560		018-16100-01	CAP 0603 CHIP 100N +80-20% Y5V 16V	#C664	2020	018-16100-01	CAP 0603 CHIP 100N +80-20% Y5V 16V
C570		018-16100-01	CAP 0603 CHIP 100N +80-20% Y5V 16V	#C664	2040	018-16100-01	CAP 0603 CHIP 100N +80-20% Y5V 16V
C571		018-16100-01	CAP 0603 CHIP 100N +80-20% Y5V 16V	#C664	2050	018-16100-01	CAP 0603 CHIP 100N +80-20% Y5V 16V
C600		018-14100-00	CAP 0603 CHIP 1N 50V X7R +10%	#C664	2060	018-16100-01	CAP 0603 CHIP 100N +80-20% Y5V 16V
C601		014-07470-01	CAP TANT CHIP 4U7 'B' CASE 25V +10% 26	#C665	2020	018-16100-01	CAP 0603 CHIP 100N +80-20% Y5V 16V
C602		018-12820-10	CAP 0603 CHIP 82P 50V NPO +1%	#C665	2040	018-16100-01	CAP 0603 CHIP 100N +80-20% Y5V 16V
C603		015-23220-01	CAP CER 0805 CHIP 220P 5% NPO 50V	#C665	2050	018-16100-01	CAP 0603 CHIP 100N +80-20% Y5V 16V
C605		014-07470-01	CAP TANT CHIP 4U7 'B' CASE 25V +10% 26	#C665	2060	018-16100-01	CAP 0603 CHIP 100N +80-20% Y5V 16V
C607		015-06100-08	CAP CER 1206 CHIP 100N 10% X7R 50V	#C666	2020	018-16100-01	CAP 0603 CHIP 100N +80-20% Y5V 16V
C608		018-15100-00	CAP 0603 CHIP 10N 50V X7R +10%	#C666	2040	018-16100-01	CAP 0603 CHIP 100N +80-20% Y5V 16V
C609		018-12470-10	CAP 0603 CHIP 47P 50V NPO +1%	#C666	2050	018-16100-01	CAP 0603 CHIP 100N +80-20% Y5V 16V
C610		014-07470-01	CAP TANT CHIP 4U7 'B' CASE 25V +10% 26	#C666	2060	018-16100-01	CAP 0603 CHIP 100N +80-20% Y5V 16V
C611		018-13100-10	CAP 0603 CHIP 100P 50V NPO +1%	#C667	2020	018-16100-01	CAP 0603 CHIP 100N +80-20% Y5V 16V
C613		015-24470-08	CAP CER 0805 CHIP 4N7 10% X7R 50V	#C667	2040	018-16100-01	CAP 0603 CHIP 100N +80-20% Y5V 16V
C614		015-25150-08	CAP CER 0805 CHIP 15N 10% X7R 50V	#C667	2050	018-16100-01	CAP 0603 CHIP 100N +80-20% Y5V 16V
C615		015-25150-08	CAP CER 0805 CHIP 15N 10% X7R 50V	#C667	2060	018-16100-01	CAP 0603 CHIP 100N +80-20% Y5V 16V
C616		015-25150-08	CAP CER 0805 CHIP 15N 10% X7R 50V	C700		014-07470-01	CAP TANT CHIP 4U7 'B' CASE 25V +10% 26
C617		018-15100-00	CAP 0603 CHIP 10N 50V X7R +10%	C701		016-08470-01	CAP ELECT SMD 6X4MM 47M 16V
C618		018-15100-00	CAP 0603 CHIP 10N 50V X7R +10%	#C704	2020	014-07470-01	CAP TANT CHIP 4U7 'B' CASE 25V +1
C619		018-15100-00	CAP 0603 CHIP 10N 50V X7R +10%	#C704	203X	014-07470-00	CAP TANT CHIP 4U7 'B' CASE 16V +1
C620		018-15100-00	CAP 0603 CHIP 10N 50V X7R +10%	#C704	2040	014-07470-01	CAP TANT CHIP 4U7 'B' CASE 25V +1
C621		018-15100-00	CAP 0603 CHIP 10N 50V X7R +10%	#C704	2050	014-07470-01	CAP TANT CHIP 4U7 'B' CASE 25V +1
C622		018-15100-00	CAP 0603 CHIP 10N 50V X7R +10%	#C704	2060	014-07470-01	CAP TANT CHIP 4U7 'B' CASE 25V +1
C623		015-06100-08	CAP CER 1206 CHIP 100N 10% X7R 50V	C705		015-24470-08	CAP CER 0805 CHIP 4N7 10% X7R 50V
C624		018-15100-00	CAP 0603 CHIP 10N 50V X7R +10%	#C706	203X	015-06100-08	CAP CER 1206 CHIP 100N 10% X7R 50V
C625		018-15100-00	CAP 0603 CHIP 10N 50V X7R +10%	#C706	2060	015-06100-08	CAP CER 1206 CHIP 100N 10% X7R 50V
				C720		018-16100-01	CAP 0603 CHIP 100N +80-20% Y5V 16V

Ref	Var	IPN	Description	Ref	Var	IPN	Description
C721		018-16100-01	CAP 0603 CHIP 100N +80-20% Y5V 16V	R501		038-15470-00	RES 0603 CHIP 47K 1/16W +5%
C722		018-16100-01	CAP 0603 CHIP 100N +80-20% Y5V 16V	R502		038-15470-00	RES 0603 CHIP 47K 1/16W +5%
C801		015-25220-08	CAP CER 0805 CHIP 22N 10% X7R 50V	R503		038-15470-00	RES 0603 CHIP 47K 1/16W +5%
C802		018-15100-00	CAP 0603 CHIP 10N 50V X7R +10%	R504		038-14470-00	RES 0603 CHIP 4K7 1/16W +5%
C803		018-11470-10	CAP 0603 CHIP 4P7 50V NPO +0.1P	R505		036-16150-00	RES M/F 0805 CHIP 150K 5%
C804		015-23180-01	CAP CER 0805 CHIP 180P 5% NPO 50V	R506		038-15100-00	RES 0603 CHIP 10K 1/16W +5%
C805		015-06100-08	CAP CER 1206 CHIP 100N 10% X7R 50V	R507		038-10000-00	RES 0603 CHIP ZERO OHM 1/16W +5%
C806		014-07470-01	CAP TANT CHIP 4U7 'B' CASE 25V +10% 26	RV507		042-15500-01	RES PRESET SMD 50K +25% 4X4.5X2.5MM 0
C808		015-06100-08	CAP CER 1206 CHIP 100N 10% X7R 50V	R508		038-16100-00	RES 0603 CHIP 100K 1/16W +5%
#C810	PE	018-13150-00	CAP 0603 CHIP 150P 50V NPO +5%	R509		038-14220-00	RES 0603 CHIP 220K 1/16W +5%
C811		018-16100-01	CAP 0603 CHIP 100N +80-20% Y5V 16V	R510		036-18100-00	RES M/F 0805 CHIP 10M 10%
#C812	203X	018-15100-00	CAP 0603 CHIP 10N 50V X7R +10%	R511		038-16470-00	RES 0603 CHIP 100K 1/16W +5%
#C812	2040	018-15100-00	CAP 0603 CHIP 10N 50V X7R +10%	R512		038-16100-00	RES 0603 CHIP 100K 1/16W +5%
#C812	2050	018-15100-00	CAP 0603 CHIP 10N 50V X7R +10%	R514		038-16100-00	RES 0603 CHIP 100K 1/16W +5%
#C812	PE	018-13150-00	CAP 0603 CHIP 150P 50V NPO +5%	R515		038-16100-00	RES 0603 CHIP 100K 1/16W +5%
C813		018-11560-10	CAP 0603 CHIP 5P6 50V NPO +0.1P	R516		038-16100-00	RES 0603 CHIP 100K 1/16W +5%
C814		018-16100-01	CAP 0603 CHIP 100N +80-20% Y5V 16V	#R517	2020	038-16220-00	RES 0603 CHIP 220K 1/16W +5%
C815		015-25150-08	CAP CER 0805 CHIP 15N 10% X7R 50V	#R517	203X	038-16220-00	RES 0603 CHIP 220K 1/16W +5%
C832		018-14100-00	CAP 0603 CHIP 1N 50V X7R +10%	#R517	2040	038-16220-00	RES 0603 CHIP 220K 1/16W +5%
D502		001-10099-01	(S) DIODE BAV99W DUAL SML SIG SOT323	#R517	2050	038-16220-00	RES 0603 CHIP 220K 1/16W +5%
D503		001-10099-01	(S) DIODE BAV99W DUAL SML SIG SOT323	#R517	2060	038-16220-00	RES 0603 CHIP 220K 1/16W +5%
D800		001-10099-01	(S) DIODE BAV99W DUAL SML SIG SOT323	R518		038-14100-00	RES 0603 CHIP 1K0 1/16W +5%
#F02	PE	038-16220-00	RES 0603 CHIP 220K 1/16W +5%	R519		038-16100-00	RES 0603 CHIP 2K2 1/16W +5%
#IC500	2020	002-10481-80	LS) IC SMD M48Z18 8K*8 SNAPAT RA	R520		038-14220-00	RES 0603 CHIP 2K2 1/16W +5%
#IC500	203X	002-10481-80	LS) IC SMD M48Z18 8K*8 SNAPAT RA	R521		038-15100-00	RES 0603 CHIP 10K 1/16W +5%
#IC500	2040	002-10481-80	LS) IC SMD M48Z18 8K*8 SNAPAT RA	R522		038-14470-00	RES 0603 CHIP 4K7 1/16W +5%
#IC500	2050	002-10483-50	LS) IC SMD M48Z35 32K*8 SNAPAT R	R523		038-14100-00	RES 0603 CHIP 1K0 1/16W +5%
#IC500	2060	002-10481-80	LS) IC SMD M48Z18 8K*8 SNAPAT RA	#R524	2020	036-16330-00	RES M/F 0805 CHIP 330K 5%
IC501		002-20290-10	(S) IC AM29F010-120JC FLASH MEM 128*8K	#R524	203X	036-16330-00	RES M/F 0805 CHIP 330K 5%
IC502		002-74900-00	(S) IC SMD 74HC00 QUAD 2 I/P NAND	#R524	2040	036-16330-00	RES M/F 0805 CHIP 330K 5%
#IC503	203X	002-10140-21	(S) IC MC14021BDR2 8BIT SHIFT REG	#R524	2050	036-16330-00	RES M/F 0805 CHIP 330K 5%
#IC503	2060	002-10140-21	(S) IC MC14021BDR2 8BIT SHIFT REG	#R524	2060	036-16330-00	RES M/F 0805 CHIP 330K 5%
IC504		002-10340-64	(S) IC SMD MC34064 LO VOILT SENSE	R525		038-13330-00	RES 0603 CHIP 330E 1/16W +5%
IC505		002-16800-11	(S) IC SMD MC68HC11A1 MCU PLCC52	R525A		038-13330-00	RES 0603 CHIP 330E 1/16W +5%
IC510		002-74900-40	(LSH) IC SMD TC7S04F SINGLE INV GATE S	R526		038-14470-00	RES 0603 CHIP 4K7 1/16W +5%
IC511		002-74900-40	(LSH) IC SMD TC7S04F SINGLE INV GATE S	R529		038-10000-00	RES 0603 CHIP ZERO OHM 1/16W +5%
IC513		002-10078-05	(S) IC SMD 78L05 5V REG	R530		038-15470-00	RES 0603 CHIP 47K 1/16W +5%
IC514		002-10078-08	(S) IC SMD 78L08 8V REG SO8	R531		038-14470-00	RES 0603 CHIP 4K7 1/16W +5%
#IC517	203X	002-20004-39	(S) IC FX439LS FFSK MODEM 24 PLCC	R532		038-15470-00	RES 0603 CHIP 47K 1/16W +5%
#IC517	2040	002-20046-90	(S) IC FX469LS FFSK MODEM 1200/24	R533		038-15470-00	RES 0603 CHIP 47K 1/16W +5%
#IC517	2050	002-20046-90	(S) IC FX469LS FFSK MODEM 1200/24	R534		038-14470-00	RES 0603 CHIP 4K7 1/16W +5%
IC555		002-16562-60	(LSH) IC CMOS6X GATE ARRAY (T3000/T205	R535		038-14100-00	RES 0603 CHIP 1K0 1/16W +5%
IC601		002-10003-24	(S) IC SMD 324 QUAD OP AMP SO14	R537		038-15470-00	RES 0603 CHIP 47K 1/16W +5%
IC603		002-10003-24	(S) IC SMD 324 QUAD OP AMP SO14	R538		036-15220-00	RES M/F 0805 CHIP 22K 5%
IC604		002-10003-24	(S) IC SMD 324 QUAD OP AMP SO14	R539		038-17100-00	RES 0603 CHIP 1M 1/16W +5%
#IC606	2020	002-74901-32	(S) IC SMD 74HC132 HCMOS QUAD SCH	R540		038-14470-00	RES 0603 CHIP 4K7 1/16W +5%
#IC606	203X	002-74901-32	(S) IC SMD 74HC132 HCMOS QUAD SCH	R541		038-16100-00	RES 0603 CHIP 100K 1/16W +5%
#IC606	2040	002-74901-32	(S) IC SMD 74HC132 HCMOS QUAD SCH	R543		038-14220-00	RES 0603 CHIP 2K2 1/16W +5%
#IC606	2050	002-74901-32	(S) IC SMD 74HC132 HCMOS QUAD SCH	R544		038-15470-00	RES 0603 CHIP 47K 1/16W +5%
#IC606	2060	002-74901-32	(S) IC SMD 74HC132 HCMOS QUAD SCH	R545		038-15470-00	RES 0603 CHIP 47K 1/16W +5%
IC614		002-10040-53	(S) IC 4053 SMD TRIPLE 2CH MULTI-PLRXR	R547		038-16100-00	RES 0603 CHIP 100K 1/16W +5%
IC801		002-10003-24	(S) IC SMD 324 QUAD OP AMP SO14	R548		038-15100-00	RES 0603 CHIP 10K 1/16W +5%
IC802		002-10003-58	(S) IC SMD LM358 DUAL OP AMP	R549		038-14100-00	RES 0603 CHIP 1K0 1/16W +5%
L501		056-10330-02	(L) IND SMD 330NH SIEMENS SMID02	R550		038-16100-00	RES 0603 CHIP 100K 1/16W +5%
MPT3-1		290-00010-41	CELL M4Z28 SNAPAT BATTERY PACK	R551		038-15100-00	RES 0603 CHIP 10K 1/16W +5%
Q501		000-10084-81	(S) XSTR SMD BC848BW NPN SOT-323 SMALL	#R552	2020	038-10000-00	RES 0603 CHIP ZERO OHM 1/16W +5%
Q504		000-10084-81	(S) XSTR SMD BC848BW NPN SOT-323 SMALL	#R552	2040	038-10000-00	RES 0603 CHIP ZERO OHM 1/16W +5%
Q505		000-10084-81	(S) XSTR SMD BC848BW NPN SOT-323 SMALL	#R552	2050	038-10000-00	RES 0603 CHIP ZERO OHM 1/16W +5%
Q506		000-10084-81	(S) XSTR SMD BC848BW NPN SOT-323 SMALL	R553		038-15470-00	RES 0603 CHIP 47K 1/16W +5%
Q507		000-10084-81	(S) XSTR SMD BC848BW NPN SOT-323 SMALL	R554		038-16100-00	RES 0603 CHIP 100K 1/16W +5%
Q508		000-10008-69	(S) XSTR SMD BC869 PNP 1W 2A SOT-89	R556		038-15100-00	RES 0603 CHIP 10K 1/16W +5%
Q509		000-10003-12	(S) XSTR SMD BFR31 N JFET SOT-23	R559		038-13220-00	RES 0603 CHIP 220E 1/16W +5%
Q510		000-10084-81	(S) XSTR SMD BC848BW NPN SOT-323 SMALL	R560		038-13220-00	RES 0603 CHIP 220E 1/16W +5%
#Q511	2020	000-10029-55	(S) XSTR SMD MJD2955 PWR PNP 10A 6	R562		038-15100-00	RES 0603 CHIP 10K 1/16W +5%
#Q511	2040	000-10029-55	(S) XSTR SMD MJD2955 PWR PNP 10A 6	R563		036-14390-00	RES M/F 0805 CHIP 3K9 5%
#Q511	2050	000-10029-55	(S) XSTR SMD MJD2955 PWR PNP 10A 6	R564		038-14100-00	RES 0603 CHIP 1K0 1/16W +5%
Q513		000-10084-81	(S) XSTR SMD BC848BW NPN SOT-323 SMALL	R565		036-14270-00	RES M/F 0805 CHIP 2K7 5%
Q514		000-10085-71	(S) XSTR SMD BC857BW PNP SOT-323 SMALL	R566		038-16100-00	RES 0603 CHIP 100K 1/16W +5%
Q515		000-10085-71	(S) XSTR SMD BC857BW PNP SOT-323 SMALL	R566A		038-16100-00	RES 0603 CHIP 100K 1/16W +5%
Q516		000-10085-71	(S) XSTR SMD BC857BW PNP SOT-323 SMALL	R567		038-16100-00	RES 0603 CHIP 100K 1/16W +5%
Q517		000-10084-81	(S) XSTR SMD BC848BW NPN SOT-323 SMALL	R568		038-16100-00	RES 0603 CHIP 100K 1/16W +5%
Q601		000-10084-81	(S) XSTR SMD BC848BW NPN SOT-323 SMALL	R569		038-16100-00	RES 0603 CHIP 100K 1/16W +5%
Q602		000-10084-81	(S) XSTR SMD BC848BW NPN SOT-323 SMALL	R570		038-14470-00	RES 0603 CHIP 4K7 1/16W +5%
Q604		000-10084-81	(S) XSTR SMD BC848BW NPN SOT-323 SMALL	#R571	2020	038-10000-00	RES 0603 CHIP ZERO OHM 1/16W +5%
Q605		000-10085-71	(S) XSTR SMD BC857BW PNP SOT-323 SMALL	#R571	203X	038-16220-00	RES 0603 CHIP 220K 1/16W +5%
Q606		000-10085-71	(S) XSTR SMD BC857BW PNP SOT-323 SMALL	#R571	2040	038-16220-00	RES 0603 CHIP 220K 1/16W +5%
Q607		000-10084-81	(S) XSTR SMD BC848BW NPN SOT-323 SMALL	#R571	2050	038-16220-00	RES 0603 CHIP 220K 1/16W +5%
Q608		000-10084-81	(S) XSTR SMD BC848BW NPN SOT-323 SMALL	#R571	2060	038-10000-00	RES 0603 CHIP ZERO OHM 1/16W +5%
Q700		000-10084-81	(S) XSTR SMD BC848BW NPN SOT-323 SMALL	#R571	PE	038-16470-00	RES 0603 CHIP 470K 1/16W +5%
Q800		000-10003-12	(S) XSTR SMD BFR31 N JFET SOT-23	R572		038-15100-00	RES 0603 CHIP 10K 1/16W +5%
Q802		000-10084-81	(S) XSTR SMD BC848BW NPN SOT-323 SMALL	R573		038-16100-00	RES 0603 CHIP 100K 1/16W +5%
Q804		000-10084-81	(S) XSTR SMD BC848BW NPN SOT-323 SMALL	R578		038-15470-00	RES 0603 CHIP 47K 1/16W +5%
R400		038-15100-00	RES 0603 CHIP 10K 1/16W +5%	R580		038-14220-00	RES 0603 CHIP 2K2 1/16W +5%
R402		038-15270-00	RES 0603 CHIP 27K 1/16W +5%	R581		038-14220-00	RES 0603 CHIP 2K2 1/16W +5%
R403		038-15270-00	RES 0603 CHIP 27K 1/16W +5%	R582		038-13470-00	RES 0603 CHIP 470E 1/16W +5%
R500		038-13470-00	RES 0603 CHIP 470E 1/16W +5%	R583		038-13470-00	RES 0603 CHIP 470E 1/16W +5%
				R584		038-15470-00	RES 0603 CHIP 47K 1/16W +5%
				R589		038-16100-00	RES 0603 CHIP 100K 1/16W +5%
				R590		038-16470-00	RES 0603 CHIP 470K 1/16W +5%
				R591		036-13680-00	RES M/F 0805 CHIP 680E 5%
				R592		036-13680-00	RES M/F 0805 CHIP 680E 5%
				R594		038-16100-00	RES 0603 CHIP 100K 1/16W +5%
				#R596	2020	036-15390-00	RES M/F 0805 CHIP 39K 5%



Ref	Var	IPN	Description	Ref	Var	IPN	Description
#R596	203X	036-15390-00	RES M/F 0805 CHIP 39K 5%	R685		038-10000-00	RES 0603 CHIP ZERO OHM 1/16W +5%
#R596	2040	036-15390-00	RES M/F 0805 CHIP 39K 5%	R686		038-15470-00	RES 0603 CHIP 47K 1/16W +5%
#R596	2050	036-15390-00	RES M/F 0805 CHIP 39K 5%	R687		038-15100-00	RES 0603 CHIP 10K 1/16W +5%
#R596	2060	036-15390-00	RES M/F 0805 CHIP 39K 5%	R688		038-15100-00	RES 0603 CHIP 10K 1/16W +5%
#R597	2020	038-15100-00	RES 0603 CHIP 10K 1/16W +5%	R689		038-15100-00	RES 0603 CHIP 10K 1/16W +5%
#R597	203X	038-15100-00	RES 0603 CHIP 10K 1/16W +5%	R690		038-15150-00	RES 0603 CHIP 15K 1/16W +5%
#R597	2040	038-15100-00	RES 0603 CHIP 10K 1/16W +5%	R691		038-14220-00	RES 0603 CHIP 2K2 1/16W +5%
#R597	2050	038-15100-00	RES 0603 CHIP 10K 1/16W +5%	R692		036-15220-00	RES M/F 0805 CHIP 22K 5%
#R597	2060	038-15100-00	RES 0603 CHIP 10K 1/16W +5%	R699		038-15470-00	RES 0603 CHIP 47K 1/16W +5%
R598		038-16220-00	RES 0603 CHIP 220K 1/16W +5%	R700		038-15470-00	RES 0603 CHIP 47K 1/16W +5%
#RV599	203X	042-15500-01	RES PRESET SMD 50K +25% 4X4.5X2.	R701		038-14470-00	RES 0603 CHIP 4K7 1/16W +5%
#RV599	2040	042-15500-01	RES PRESET SMD 50K +25% 4X4.5X2.	R702		038-14220-00	RES 0603 CHIP 2K2 1/16W +5%
#RV599	2050	042-15500-01	RES PRESET SMD 50K +25% 4X4.5X2.	R704		038-13330-00	RES 0603 CHIP 330E 1/16W +5%
R600		038-13220-00	RES 0603 CHIP 220E 1/16W +5%	R705		038-14220-00	RES 0603 CHIP 2K2 1/16W +5%
R602		036-14820-00	RES M/F 0805 CHIP 8K2 5%	R706		038-14220-00	RES 0603 CHIP 2K2 1/16W +5%
R603		038-16100-00	RES 0603 CHIP 100K 1/16W +5%	R709		038-14100-00	RES 0603 CHIP 1K0 1/16W +5%
R604		038-16220-00	RES 0603 CHIP 220K 1/16W +5%	R710		038-13220-00	RES 0603 CHIP 220E 1/16W +5%
R605		038-16220-00	RES 0603 CHIP 220K 1/16W +5%	R711		038-14220-00	RES 0603 CHIP 2K2 1/16W +5%
R606		038-16470-00	RES 0603 CHIP 470K 1/16W +5%	R712		038-15100-00	RES 0603 CHIP 10K 1/16W +5%
R607		038-16100-00	RES 0603 CHIP 100K 1/16W +5%	R715		038-10000-00	RES 0603 CHIP ZERO OHM 1/16W +5%
R608		036-15220-00	RES M/F 0805 CHIP 22K 5%	#R717	203X	038-10000-00	RES 0603 CHIP ZERO OHM 1/16W +5%
R609		038-16220-00	RES 0603 CHIP 220K 1/16W +5%	#R717	2040	038-10000-00	RES 0603 CHIP ZERO OHM 1/16W +5%
R610		038-10000-00	RES 0603 CHIP ZERO OHM 1/16W +5%	#R717	2050	038-10000-00	RES 0603 CHIP ZERO OHM 1/16W +5%
R611		038-16220-00	RES 0603 CHIP 220K 1/16W +5%	#R717A	2020	038-10000-00	RES 0603 CHIP ZERO OHM 1/16W +5%
R613		038-16100-00	RES 0603 CHIP 100K 1/16W +5%	#R717A	2060	038-10000-00	RES 0603 CHIP ZERO OHM 1/16W +5%
R614		038-16220-00	RES 0603 CHIP 220K 1/16W +5%	R720		038-15560-00	RES 0603 CHIP 56K 1/16W +5%
R615		036-15270-00	RES M/F 0805 CHIP 27K 5%	#R720	2020	038-10000-00	RES 0603 CHIP ZERO OHM 1/16W +5%
R616		036-16150-00	RES M/F 0805 CHIP 150K 5%	#R720	203X	038-10000-00	RES 0603 CHIP ZERO OHM 1/16W +5%
R617		036-16150-00	RES M/F 0805 CHIP 150K 5%	#R720	2040	038-10000-00	RES 0603 CHIP ZERO OHM 1/16W +5%
R619		038-15270-00	RES 0603 CHIP 27K 1/16W +5%	#R720	2050	038-10000-00	RES 0603 CHIP ZERO OHM 1/16W +5%
R620		038-15100-00	RES 0603 CHIP 10K 1/16W +5%	#R720	2060	038-10000-00	RES 0603 CHIP ZERO OHM 1/16W +5%
R621		036-16390-00	RES M/F 0805 CHIP 390K 5%	R721		038-14470-00	RES 0603 CHIP 4K7 1/16W +5%
R622		038-15100-00	RES 0603 CHIP 10K 1/16W +5%	#R730	2020	038-10000-00	RES 0603 CHIP ZERO OHM 1/16W +5%
R623		038-14680-00	RES 0603 CHIP 6K8 1/16W +5%	#R730	203X	038-10000-00	RES 0603 CHIP ZERO OHM 1/16W +5%
R624		038-15100-00	RES 0603 CHIP 10K 1/16W +5%	#R730	2040	038-10000-00	RES 0603 CHIP ZERO OHM 1/16W +5%
R625		038-14680-00	RES 0603 CHIP 6K8 1/16W +5%	#R730	2050	038-10000-00	RES 0603 CHIP ZERO OHM 1/16W +5%
R626		038-15270-00	RES 0603 CHIP 27K 1/16W +5%	#R730	2060	038-10000-00	RES 0603 CHIP ZERO OHM 1/16W +5%
R627		036-16390-00	RES M/F 0805 CHIP 390K 5%	#R731	2020	038-10000-00	RES 0603 CHIP ZERO OHM 1/16W +5%
R628		038-15100-00	RES 0603 CHIP 10K 1/16W +5%	#R731	203X	038-10000-00	RES 0603 CHIP ZERO OHM 1/16W +5%
R629		038-15270-00	RES 0603 CHIP 27K 1/16W +5%	#R731	2040	038-10000-00	RES 0603 CHIP ZERO OHM 1/16W +5%
R630		038-17100-00	RES 0603 CHIP 1M 1/16W +5%	#R731	2050	038-10000-00	RES 0603 CHIP ZERO OHM 1/16W +5%
R631		038-14100-00	RES 0603 CHIP 1K0 1/16W +5%	#R731	2060	038-10000-00	RES 0603 CHIP ZERO OHM 1/16W +5%
R632		036-16390-00	RES M/F 0805 CHIP 390K 5%	#R732	2020	038-10000-00	RES 0603 CHIP ZERO OHM 1/16W +5%
R633		038-15100-00	RES 0603 CHIP 10K 1/16W +5%	#R732	203X	038-10000-00	RES 0603 CHIP ZERO OHM 1/16W +5%
R634		038-14680-00	RES 0603 CHIP 6K8 1/16W +5%	#R732	2040	038-10000-00	RES 0603 CHIP ZERO OHM 1/16W +5%
R635		038-16220-00	RES 0603 CHIP 220K 1/16W +5%	#R732	2050	038-10000-00	RES 0603 CHIP ZERO OHM 1/16W +5%
R636		038-16100-00	RES 0603 CHIP 100K 1/16W +5%	#R732	2060	038-10000-00	RES 0603 CHIP ZERO OHM 1/16W +5%
R637		038-16100-00	RES 0603 CHIP 100K 1/16W +5%	R801		038-16100-00	RES 0603 CHIP 100K 1/16W +5%
R638		038-15100-00	RES 0603 CHIP 10K 1/16W +5%	R802		038-16220-00	RES 0603 CHIP 220K 1/16W +5%
R639		038-14220-00	RES 0603 CHIP 2K2 1/16W +5%	R803		036-16470-00	RES M/F 0805 CHIP 470K 5%
R640		038-17100-00	RES 0603 CHIP 1M 1/16W +5%	R804		038-15470-00	RES 0603 CHIP 47K 1/16W +5%
R641		036-16150-00	RES M/F 0805 CHIP 150K 5%	R805		038-13680-00	RES 0603 CHIP 680E 1/16W +5%
R642		038-16100-00	RES 0603 CHIP 100K 1/16W +5%	R806		038-16100-00	RES 0603 CHIP 100K 1/16W +5%
R643		036-16330-00	RES M/F 0805 CHIP 330K 5%	R807		038-15470-00	RES 0603 CHIP 47K 1/16W +5%
R644		038-17100-00	RES 0603 CHIP 1M 1/16W +5%	R808		038-14220-00	RES 0603 CHIP 2K2 1/16W +5%
R645		038-16100-00	RES 0603 CHIP 100K 1/16W +5%	R809		038-14470-00	RES 0603 CHIP 4K7 1/16W +5%
R646		036-16330-00	RES M/F 0805 CHIP 330K 5%	R810		038-13220-00	RES 0603 CHIP 220E 1/16W +5%
R647		038-14220-00	RES 0603 CHIP 2K2 1/16W +5%	R811		038-12220-00	RES 0603 CHIP 22E 1/16W +5%
R648		038-16220-00	RES 0603 CHIP 220K 1/16W +5%	R812		038-10000-00	RES 0603 CHIP ZERO OHM 1/16W +5%
R649		038-17100-00	RES 0603 CHIP 1M 1/16W +5%	R845		038-15560-00	RES 0603 CHIP 56K 1/16W +5%
R650		038-14100-00	RES 0603 CHIP 1K0 1/16W +5%	R846		038-16220-00	RES 0603 CHIP 220K 1/16W +5%
R651		038-15150-00	RES 0603 CHIP 15K 1/16W +5%	R847		038-12100-00	RES 0603 CHIP 10E 1/16W +5%
R652		038-15100-00	RES 0603 CHIP 10K 1/16W +5%	S1		240-10000-07	CONN SMD SKT 16WAY 2ROW MICROMATCH
R653		038-13680-00	RES 0603 CHIP 680E 1/16W +5%	S2		240-10000-06	CONN SMD SKT 12WAY 2ROW MICROMATCH
#R656	2020	038-10000-00	RES 0603 CHIP ZERO OHM 1/16W +5%	#S8	203X	240-10000-07	CONN SMD SKT 16WAY 2ROW MICROMATCH
#R656	2040	038-10000-00	RES 0603 CHIP ZERO OHM 1/16W +5%	#S8	2060	240-10000-07	CONN SMD SKT 16WAY 2ROW MICROMATCH
#R656	2050	038-10000-00	RES 0603 CHIP ZERO OHM 1/16W +5%	#S9	2020	240-10000-05	CONN SMD SKT 8WAY 2ROW MICROMATCH
R658		038-16150-00	RES 0603 CHIP 150K 1/16W +5%	#S9	2040	240-10000-05	CONN SMD SKT 8WAY 2ROW MICROMATCH
R659		038-13680-00	RES 0603 CHIP 680E 1/16W +5%	#S9	2050	240-10000-05	CONN SMD SKT 8WAY 2ROW MICROMATCH
R660		038-15470-00	RES 0603 CHIP 47K 1/16W +5%	#S13	OPT	240-10000-06	CONN SMD SKT 12WAY 2ROW MICROMATCH
R662		038-14100-00	RES 0603 CHIP 1K0 1/16W +5%	#S14	OPT	240-10000-07	CONN SMD SKT 16WAY 2ROW MICROMATCH
R663		038-15470-00	RES 0603 CHIP 47K 1/16W +5%	#S16	OPT	240-10000-06	CONN SMD SKT 12WAY 2ROW MICROMATCH
R664		038-15220-00	RES 0603 CHIP 22K 1/16W +5%	#S17	OPT	240-10000-06	CONN SMD SKT 12WAY 2ROW MICROMATCH
R665		038-16470-00	RES 0603 CHIP 470K 1/16W +5%	#S18	OPT	240-10000-06	CONN SMD SKT 12WAY 2ROW MICROMATCH
R666		036-16150-00	RES M/F 0805 CHIP 150K 5%	SK501		240-04043-20	SKT 32 PIN SMD PLCC CHIP CARRIER
R667		038-17100-00	RES 0603 CHIP 1M 1/16W +5%	TP610		005-10000-10	TEST POINT SMD 0805 2.0 X 1.25 X 1.45
R668		038-16470-00	RES 0603 CHIP 470K 1/16W +5%	#T3K44	2020	240-10000-01	CONN SMD 24WAY (PLUG)
R669		036-14180-00	RES M/F 0805 CHIP 1K8 5%	#T3K44	203X	240-10000-01	CONN SMD 24WAY (PLUG)
R670		038-15100-00	RES 0603 CHIP 10K 1/16W +5%	#T3K44	2040	240-10000-01	CONN SMD 24WAY (PLUG)
R671		038-14470-00	RES 0603 CHIP 4K7 1/16W +5%	#T3K44	2050	240-10000-01	CONN SMD 24WAY (PLUG)
R672		038-15100-00	RES 0603 CHIP 10K 1/16W +5%	#T3K45		240-10000-01	CONN SMD 24WAY (PLUG)
R673		038-15100-00	RES 0603 CHIP 10K 1/16W +5%	X501		274-01072-00	XTAL 8.064MHZ HC-49U/S HOLDER C/W TEFLON
R674		038-15100-00	RES 0603 CHIP 10K 1/16W +5%				
R675		038-15470-00	RES 0603 CHIP 47K 1/16W +5%				
R676		038-15470-00	RES 0603 CHIP 47K 1/16W +5%				
R677		038-15100-00	RES 0603 CHIP 10K 1/16W +5%				
R678		038-16100-00	RES 0603 CHIP 100K 1/16W +5%				
R679		038-15470-00	RES 0603 CHIP 47K 1/16W +5%				
R680		036-14270-00	RES M/F 0805 CHIP 2K7 5%				
R681		038-15100-00	RES 0603 CHIP 10K 1/16W +5%				
R682		038-14180-00	RES 0603 CHIP 1K8 1/16W +5%				
R683		038-15100-00	RES 0603 CHIP 10K 1/16W +5%				
R684		036-16120-00	RES M/F 0805 CHIP 120K 5%				

Variants: PE = Pre-emphasised FFSK  
OPT = Options connectors fitted

## T2000 HC11 Logic Mechanical & Miscellaneous Parts

IPN	Description	IPN	Description
219-02585-00	CABLE ASSEMBLY T2000 ENHD PWR/SPKR CABLE		
220-01344-04	(L) PCB T2000 LOGIC HCII COMMON PLATFORM		
240-00020-12	PLUG MICROPHONE BT SR937 (PIN 2 MISSING)		
240-00100-13	PLUG COAX BNC CORD MTG CRIMP URM76		
240-02010-75	SKT RECEP TL SML 172775-1		
252-00010-37	MIC AWC DYNAMIC 600E 6WAY M095D TINSEL SHLD'		
252-00010-49	MIC CLIP (SPRING STEEL CONTACT)		
265-00010-60	FUSE 10A 12V AUTOMOTIVE STAPLE TYPE		
303-23134-02	COVER TOP A1M2504 T2000 PNTD CMPLT		
303-30062-02	CRADLE BODY A3M2551 T2000 BOTTOM		
303-30063-02	CRADLE BODY A3M2552 T2000 TOP		
303-30064-00	CRADLE CLIP A1M2550 T2000		
303-30065-03	KEY CRADLE T2000 SII (BLANK)		
340-00010-23	FUSEHLDR INLINE 3M 972		
349-00010-49	SCREW SELFTAP NO 10X1/2 IN TYPE AB PAN POZI		
349-00020-32	SCREW TAPTITE M3X8MM PAN POZI BZ		
365-00100-20	LABEL WHITE S/A 28X11MM QUIKSTIK RW718/4		
353-00010-32	WASHER M5 SHAKEPROOF EXT BZ		
360-02003-01	GROMMET MIC CORD T2000 SII		
362-01028-00	GASKET A4M2652 130X3MM CONDUCT STRIPS T2000 ADD GASKET TO REAR OF TOP COVER		
365-01376-00	LABEL A4A724 SOFTWARE WARNING GUIDE		
365-01516-00	LABEL T2000 MODEL ID/TYPE APPROVAL		
399-00010-52	BAG PLASTIC 100*150MM		
410-01099-02	(L) PKG CARTON T2000 SERIES II		
410-01101-01	CARTON T700/T2000 SII OUTER (5 UNIT EA)		

### T2020 VARIANT PARTS

005-00000-40 MODULE RMT 5W 4OHM SPKR IN ENCLSR T2000 PACF

### T2040 VARIANT PARTS

005-00000-40 MODULE RMT 5W 4OHM SPKR IN ENCLSR T2000 PACF

### T2050 VARIANT PARTS

005-00000-40 MODULE RMT 5W 4OHM SPKR IN ENCLSR T2000 PACF

## T2000 HC11 Logic Grid Reference Index (IPN 220-01344-04)

Device	PCB	Circuit	Device	PCB	Circuit	Device	PCB	Circuit	Device	PCB	Circuit
#012	1:G8	1-T1	C624	1:B7	1-N5	#F03	1:J8	1-V1	Q501	1:H13	2-C7
#014	1:G8	1-T1	C625	1:B6	1-O5	FACTORY	2:J14	2-S7	Q504	1:J15	2-Q5
#015	1:G8	1-T1	C626	1:C7	1-O4	FIDA	1:D11	1-H1	Q505	1:C9	2-K3
#016	1:H8	1-T1	C627	1:B7	1-N3	FIDB	1:B12	1-H1	Q506	1:E3	2-T8
#017	1:H8	1-U1	C628	1:B4	1-M2				Q507	1:B10	2-Q4
#018	1:H8	1-U1	C629	1:C6	1-N2	#IC500	1:C14	2-F1	Q508	1:B10	2-R4
#019	1:H8	1-U1	C630	1:H7	1-U4	IC502	1:D15	2-B0	Q509	1:F8	2-D6
A15ROM	2:E12	2-F5	#C631	1:F5	1-V5	IC502	1:D15	2-R5	Q510	1:A6	2-L3
A16ROM	2:E12	2-F5	#C632	1:F7	1-P4	IC502	1:D15	2-T5	#Q511	1:G4	2-V9
ALC	2:G5	1-V1	C635	1:G3	2-A8	IC502	1:D15	2-S5	Q513	1:D10	2-T2
			C636	1:J6	1-V4	#IC503	1:G15	2-N5	Q514	1:F8	2-C4
BOARD	2:H8	1-S1	C637	1:H6	1-V3	IC504	1:H14	2-S9	Q515	1:E8	2-C4
			C638	1:H5	1-V3	IC505	1:G14	2-Q5	Q516	1:D8	2-D4
C501	1:F9	2-C5	C639	1:G6	1-V2	IC510	1:G5	2-V5	Q517	1:D8	2-D4
C502	1:G10	2-L8	C640	1:J4	1-U2	IC510	1:G5	2-U3	Q601	1:F7	1-J4
C503	1:J14	2-T9	C641	1:G5	1-S3	IC511	1:E15	2-A0	Q602	1:B7	1-M4
C504	1:H13	2-Q8	C642	1:G6	1-R3	IC511	1:E15	2-S5	Q604	1:C8	1-W5
C505	1:H15	2-R5	C643	1:G7	1-Q3	IC513	1:H3	2-A8	Q605	1:H5	1-T3
C506	1:H15	2-Q5	C644	1:G7	1-Q3	IC514	1:H3	2-A9	Q606	1:J7	1-W4
C507	1:H15	2-Q5	C645	1:B3	2-B7	#IC517	1:E9	2-Q1	Q607	1:G7	1-W3
C508	1:J15	2-P5	C646	1:H7	1-Q2	IC555	1:C12	2-I2	Q608	1:C8	1-W5
C509	1:F9	2-D5	C647	1:H6	1-S3	IC601	1:D3	1-E3	Q700	1:G5	1-S6
C510	1:B4	2-L0	C648	1:D2	1-E2	IC601	1:D3	1-Q9	Q800	1:E5	1-C6
C511	1:E11	2-U4	C650	1:B7	1-L4	IC601	1:D3	1-C2	Q802	1:D4	1-I6
C512	1:E9	2-D3	C651	1:B6	1-N4	IC601	1:D3	1-H2	Q804	1:E5	1-F5
C514	1:H4	2-B9	C652	1:F5	2-U6	IC601	1:D3	1-G2			
C516	1:B15	2-U2	C653	1:F5	2-V6	IC603	1:H6	1-V3	R400	1:D8	2-D4
C517	1:F8	2-E6	#C660	1:B5	1-I5	IC603	1:H6	1-V8	R402	1:E8	2-D4
C519	1:H13	2-P8	#C661	1:B5	1-J5	IC603	1:H6	1-R3	R403	1:D8	2-D4
C520	1:E11	2-P3	#C662	1:C8	1-T6	IC603	1:H6	1-Q2	R500	1:G4	2-T7
C522	1:F3	2-B4	#C663	1:F12	1-T9	IC603	1:H6	1-Q9	R501	1:H12	2-B7
C523	1:E8	2-C4	#C664	1:C3	1-Q9	IC604	1:F9	2-C5	R502	1:H13	2-C7
C524	1:B3	2-B6	#C665	1:H6	1-R9	IC604	1:F9	1-V7	R503	1:F8	2-C4
C525	1:G4	2-B3	#C666	1:F10	1-S9	IC604	1:F9	2-S2	R504	1:E9	2-E0
C526	1:H4	2-B3	#C667	1:D7	1-S9	IC604	1:F9	1-R9	R505	1:F9	2-E5
C527	1:G3	2-E3	C700	1:F6	1-Q7	IC604	1:F9	2-E3	R506	1:F9	2-E5
C529	1:G9	1-V6	C701	1:E6	1-R7	#IC605	1:F11	1-I8	R507	1:E12	2-F8
C530	1:C3	1-V6	#C703	1:F6	1-Q7	#IC605	1:F11	1-T9	R508	1:F9	2-D5
C532	1:G4	2-V8	#C704	1:F6	1-Q6	#IC605	1:F11	1-H8	R509	1:F8	2-B6
C533	1:E11	2-U2	C705	1:G5	1-R6	#IC605	1:F11	1-H8	R510	1:F9	2-C5
C534	1:D10	2-S3	#C706	1:G5	1-S7	#IC605	1:F11	1-G8	R511	1:F8	2-D3
C535	1:E10	2-S1	C720	1:D12	2-G8	#IC606	1:F11	1-J7	R512	1:E9	2-D3
C536	1:E8	2-R1	C721	1:B13	2-F2	#IC606	1:F11	1-I8	R514	1:E9	2-D2
C537	1:B6	2-S0	C722	1:D15	2-B0	#IC606	1:F11	1-U9	R515	1:E9	2-E2
C538	1:B15	2-T1	C801	1:C5	1-G6	#IC606	1:F11	1-V9	R516	1:D9	2-E3
C540	1:D6	1-D7	C802	1:C5	1-G6	#IC606	1:F11	1-V9	#R517	1:E8	2-C4
C541	1:D6	1-E7	C803	1:C5	1-G6	IC614	1:D4	1-H7	R518	1:F8	2-B6
C550	1:E15	2-O6	C804	1:C5	1-H6	IC614	1:D4	1-T7	R519	1:D9	2-E5
C560	1:E15	2-C0	C805	1:C5	1-G6	IC614	1:D4	1-M3	R520	1:E9	2-E2
C570	1:D11	2-J6	C806	1:C6	1-K6	IC614	1:D4	1-J3	R521	1:G9	2-D6
C571	1:D11	2-I6	C808	1:C6	1-L7	IC801	1:D5	1-L6	R522	1:G9	2-D6
C600	1:G4	2-T7	#C810	1:D10	2-S2	IC801	1:D5	1-F6	R523	1:F8	2-B5
C601	1:J2	1-C8	C811	1:F9	2-S2	IC801	1:D5	1-J6	#R524	1:E8	2-C4
C602	1:C3	1-B2	#C812	1:D10	2-S2	IC801	1:D5	1-H7	R525	1:J14	2-T9
C603	1:C4	1-C3	C813	1:D10	2-S1	IC801	1:D5	1-S8	R526	1:J14	2-S9
C605	1:C4	1-A2	C814	1:C6	1-S8	IC802	1:C7	1-S9	R529	1:F8	2-C3
C607	1:D5	1-D6	C815	1:E6	1-C6	IC802	1:C7	1-O3	R530	1:H14	2-Q8
C608	1:D6	1-D6	C831	1:D5	1-E6	IC802	1:C7	1-K2	R531	1:H14	2-R8
C609	1:D5	1-D6	C832	1:F10	2-C5	ID	2:H8	1-S1	R532	1:F15	2-R8
C610	1:C3	1-D3	C514A	1:H4	2-A9	L501	1:E6	1-D8	R533	1:F15	2-R8
C611	1:D5	1-E6	C514B	1:H4	2-B9				R534	1:G15	2-R8
C613	1:C3	1-E3	C635A	1:F3	2-A8				R535	1:H13	2-P8
C614	1:C3	1-E3				MANUAL	2:H11	2-S8	R537	1:B6	2-L3
C615	1:D3	1-F3	D502	1:E3	2-U7	MODE	2:E13	2-O8	R538	1:A6	2-L3
C616	1:E3	1-F3	D502	1:E3	2-U7				R539	1:H15	2-Q5
C617	1:D3	1-H3	D503	1:B7	2-N1	ONLY	2:J13	2-S7	R540	1:H14	2-Q5
C618	1:D3	1-H3	D503	1:B7	2-M0				R541	1:J15	2-P5
C619	1:E4	1-I3	D800	1:C6	1-K7				R543	1:E3	2-T9
C620	1:E4	1-J3	D800	1:C6	1-K6	P1	1:F11	2-U0	R544	1:E3	2-U7
C621	1:E3	1-J3	DISABLE	2:G5	1-V2	PAD1	2:D9	2-F4	R545	1:E3	2-U8
C622	1:E3	1-H3				PAD2	2:E4	2-V9	R547	1:C8	2-K3
C623	1:B4	1-L3	#F01	1:H8	1-V1	PAD3	2:H5	2-C2	R548	1:C8	2-K0
			#F02	1:J8	1-V1	PAD6	2:B7	2-O4			

Device	PCB	Circuit	Device	PCB	Circuit	Device	PCB	Circuit	Device	PCB	Circuit
R549	1:C8	2-K3	R642	1:B7	1-M4	R806	1:D6	1-K7	#S13	1:A4	2-J0
R550	1:C9	2-K3	R643	1:C6	1-N2	R807	1:D6	1-K6	#S13	1:A4	2-J0
R551	1:E11	2-O5	R644	1:B6	1-N3	R808	1:D6	1-L7	#S13	1:A4	2-J0
#R552	1:F15	2-N6	R645	1:B6	1-O5	R809	1:D6	1-M6	#S13	1:A4	2-J0
R553	1:F15	2-P8	R646	1:C7	1-O3	R810	1:C6	1-M7	#S13	1:A4	2-K0
R554	1:D8	2-F4	R647	1:C7	1-O2	R811	1:D6	1-S8	#S13	1:A4	2-K0
R556	1:H13	2-P8	R648	1:B7	1-M5	R812	1:B4	2-L0	S14	1:A7	2-N0
R559	1:G4	2-W8	R649	1:J7	1-V4	R845	1:E5	1-F5	#S14	1:A7	2-N0
R560	1:G4	2-W8	R650	1:G7	1-W3	R846	1:C10	2-Q4	#S14	1:A7	2-O0
R562	1:E10	2-T3	R651	1:B3	2-C7	R847	1:B10	2-Q3	#S14	1:A7	2-O0
R563	1:E11	2-T2	R652	1:B3	2-W6	R525A	1:J14	2-T9	#S14	1:A7	2-O0
R564	1:E10	2-T2	R653	1:F5	2-V6	R566A	1:D10	2-R3	#S14	1:A7	2-O0
R565	1:D10	2-T3	#R656	1:F5	2-U6	#R717A	1:E12	2-F6	#S14	1:A7	2-P0
R566	1:E10	2-R3	R658	1:J7	1-U4	RESET	2:H12	2-S8	#S14	1:A7	2-P0
R567	1:D10	2-S2	R659	1:F5	2-U6	RV507	1:B15	2-D5	#S14	1:A7	2-L0
R568	1:G10	2-S2	R660	1:J7	1-V5	#RV508	1:A15	2-U1	#S14	1:A7	2-M0
R569	1:G10	2-S2	R662	1:J8	1-W4	#RV599	1:B15	2-T1	#S14	1:A7	2-M0
R570	1:E13	2-M8	R663	1:C8	1-V5				#S14	1:A7	2-M0
#R571	1:E10	2-S1	R664	1:J7	1-V4	S1	1:G2	2-A1	#S14	1:A7	2-M0
R572	1:H13	2-C7	R665	1:H6	1-U3	S1	1:G2	2-A3	#S14	1:A7	2-N0
R573	1:E10	2-T1	R666	1:H5	1-W2	S1	1:G2	2-A2	#S14	1:A7	2-N0
R578	1:B10	2-Q3	R667	1:H5	1-U2	S1	1:G2	2-A2	#S14	1:A7	2-L0
#R579	1:E10	2-P1	R668	1:H5	1-U3	S1	1:G2	2-A2	#S16	1:A10	2-J9
R580	1:B10	2-Q4	R669	1:H5	1-U2	S1	1:G2	2-A2	#S16	1:A10	2-H9
R581	1:B10	2-R4	R670	1:H5	1-T3	S1	1:G2	2-A2	#S16	1:A10	2-I9
R582	1:B10	2-R4	R671	1:H5	1-T2	S1	1:G2	2-A2	#S16	1:A10	2-I9
R583	1:B10	2-R4	R672	1:H6	1-T3	S1	1:G2	2-A1	#S16	1:A10	2-I9
R584	1:B8	2-S0	R673	1:H5	1-S3	S1	1:G2	2-A4	#S16	1:A10	2-I9
R589	1:B15	2-U1	R674	1:G5	1-S3	S1	1:G2	2-A4	#S16	1:A10	2-I9
R590	1:B4	2-J0	R675	1:H6	1-S2	S1	1:G2	2-A3	#S16	1:A10	2-H9
R591	1:C9	2-R3	R676	1:G6	1-R3	S1	1:G2	2-A3	#S16	1:A10	2-C9
R592	1:B9	2-S3	R677	1:G7	1-R3	S1	1:G2	2-A3	#S16	1:A10	2-J9
#R593	1:E10	2-Q1	R678	1:H7	1-Q2	S1	1:G2	2-A3	#S16	1:A10	2-C9
R594	1:B15	2-U2	R679	1:G7	1-Q3	S1	1:G2	2-A3	#S16	1:A10	2-C9
#R596	1:A15	2-U1	R680	1:H5	1-U3	S2	1:B2	2-A5	#S17	1:A12	2-F9
#R597	1:B15	2-U1	R681	1:G7	1-P2	S2	1:B2	2-A7	#S17	1:A12	2-H9
R598	1:B15	2-T1	R682	1:H7	1-Q2	S2	1:B2	2-A7	#S17	1:A12	2-F9
R600	1:C6	1-L7	R683	1:H7	1-Q2	S2	1:B2	2-A7	#S17	1:A12	2-G9
R602	1:E2	1-D2	R684	1:C5	1-G6	S2	1:B2	2-A7	#S17	1:A12	2-G9
R603	1:C4	1-A3	R685	1:H5	1-U2	S2	1:B2	2-A7	#S17	1:A12	2-G9
R604	1:C4	1-B3	R686	1:C8	1-V5	S2	1:B2	2-A7	#S17	1:A12	2-G9
R605	1:C3	1-B3	R687	1:C4	1-A3	S2	1:B2	2-A6	#S17	1:A12	2-G9
R606	1:E6	1-C6	R688	1:C4	1-A2	S2	1:B2	2-A6	#S17	1:A12	2-H9
R607	1:E6	1-D6	R689	1:D6	1-C8	S2	1:B2	2-A6	#S17	1:A12	2-F9
R608	1:C3	1-D3	R690	1:D6	1-D8	S2	1:B2	2-A6	#S17	1:A12	2-F9
R609	1:D3	1-D2	R691	1:H8	1-T4	S2	1:B2	2-A6	#S17	1:A12	2-H9
R610	1:F3	2-A5	R692	1:C4	1-C6	#S8	1:E5	2-V5	#S18	1:A14	2-D9
R611	1:C3	1-E3	R699	1:F15	2-N5	#S8	1:E5	2-V5	#S18	1:A14	2-D9
R613	1:D5	1-D6	#R700	1:F6	1-Q7	#S8	1:E5	2-V5	#S18	1:A14	2-D9
R614	1:D5	1-E6	R700	1:G15	2-O5	#S8	1:E5	2-V5	#S18	1:A14	2-C9
R615	1:C5	1-F6	R701	1:F6	1-Q7	#S8	1:E5	2-V5	#S18	1:A14	2-E9
R616	1:C5	1-G6	R702	1:F6	1-R7	#S8	1:E5	2-V5	#S18	1:A14	2-E9
R617	1:C5	1-G6	R704	1:F6	1-R7	#S8	1:E5	2-V6	#S18	1:A14	2-E9
R619	1:D2	1-F2	R705	1:F5	1-S7	#S8	1:E5	2-V4	#S18	1:A14	2-E9
R620	1:C3	1-E2	R706	1:G6	1-Q7	#S8	1:E5	2-V4	#S18	1:A14	2-E9
R621	1:E3	1-F2	R709	1:F6	1-Q6	#S8	1:E5	2-V4	#S18	1:A14	2-D9
R622	1:C4	1-C2	R710	1:F6	1-Q6	#S8	1:E5	2-V4	#S18	1:A14	2-D9
R623	1:D3	1-G3	R711	1:G6	1-R6	#S8	1:E5	2-V4	#S18	1:A14	2-F9
R624	1:D3	1-G2	R712	1:F5	1-R7	#S8	1:E5	2-V4	SK501	1:D14	2-F6
R625	1:D4	1-J3	#R713	1:D12	2-E7	#S8	1:E5	2-V5			
R626	1:D3	1-H2	R714	1:D12	2-G6	#S8	1:E5	2-V6	#T3K44	1:D7	2-V0
R627	1:E3	1-H2	R715	1:D12	2-G6	#S8	1:E5	2-V5	#T3K45	1:B9	1-A1
R628	1:D4	1-I2	R716	1:D12	2-E7	#S9	1:F4	2-V7	TEST	2:E13	2-O8
R629	1:E4	1-J2	#R717	1:E12	2-G6	#S9	1:F4	2-V7	TP602	2:E4	1-F6
R630	1:B4	1-M2	#R720	1:G7	1-P4	#S9	1:F4	2-V7	TP606	2:E12	2-K3
R631	1:B4	1-M2	R720	1:E5	1-F6	#S9	1:F4	2-V7	TP607	2:E12	2-K3
R632	1:C6	1-J2	R721	1:C6	1-J7	#S9	1:F4	2-V7	TP608	2:E12	2-K3
R633	1:D6	1-K2	#R730	1:B5	1-L5	#S9	1:F4	2-V7	TP609	1:D12	2-K3
R634	1:D6	1-K3	#R731	1:B5	1-S5	#S9	1:F4	2-V7	TP610	1:A9	2-Q0
R635	1:E7	1-J5	#R732	1:H7	1-T5	#S9	1:F4	2-V6			
R636	1:F7	1-K4	#R733	1:H7	1-T6	#S13	1:A4	2-K0	X501	1:H15	2-Q6
R637	1:B3	1-L2	R801	1:D4	1-I7	#S13	1:A4	2-I0			
R638	1:B3	1-L3	R802	1:D4	1-I6	#S13	1:A4	2-K0			
R639	1:B4	2-B2	R803	1:C6	1-J6	#S13	1:A4	2-I0			
R640	1:B4	1-L2	R804	1:C6	1-J6	#S13	1:A4	2-I0			
R641	1:C7	1-N3	R805	1:D6	1-K6	#S13	1:A4	2-I0			

## 7.11 T2020,T203X, T2040 & T2065 HC11 Logic PCB

### T2000 HC11 Logic Grid Reference Index (IPN 220-01344-07)

Device	PCB	Circuit	Device	PCB	Circuit	Device	PCB	Circuit	Device	PCB	Circuit
#012	1:G7	1-P1	C621	1:E2	1-J3	D800	1:C5	1-K7	MODE	2:F11	2-O8
#014	1:G7	1-P1	C622	1:E2	1-H3	DISABLE	2:G3	1-V2			
#015	1:H7	1-Q1	C623	1:B2	1-L3				ONLY	2:J12	2-S7
#016	1:H7	1-Q1	C624	1:C5	1-N5	#F01	1:J7	1-R1			
#017	1:H7	1-Q1	C625	1:C4	1-O5	#F02	1:J7	1-R1	P1	1:G9	2-U0
#018	1:H7	1-Q1	C626	1:C5	1-O4	#F03	1:J7	1-S1	PAD1	2:D7	2-F4
#019	1:H7	1-R1	C627	1:C5	1-N3	FACTORY	2:J12	2-S7	PAD2	2:E3	2-V9
A15ROM	2:F11	2-F5	C628	1:C2	1-M2	FIDA	1:D9	1-H1	PAD3	2:J3	2-C2
A16ROM	2:F11	2-F5	C629	1:C5	1-N2	FIDB	1:B10	1-H1	PAD6	2:B5	2-O4
ALC	2:G3	1-V1	C630	1:H6	1-U4						
BOARD	2:J7	1-P1	#C631	1:G3	1-V5	#IC500	1:C12	2-F1	Q501	1:J11	2-C7
C501	1:F7	2-C5	#C632	1:G5	1-P4	IC502	1:D13	2-B0	Q504	1:J13	2-Q5
C502	1:G8	2-L8	C635	1:G1	2-A8	IC502	1:D13	2-M6	Q505	1:C7	2-L2
C503	1:J13	2-T9	C635A	1:F1	2-A8	IC502	1:D13	2-R5	Q506	1:F1	2-T8
C504	1:J11	2-Q8	C636	1:H6	1-V4	IC502	1:D13	2-S5	Q507	1:B9	2-Q4
C505	1:J13	2-R5	C637	1:H4	1-V3	IC502	1:D13	2-T5	Q508	1:C8	2-R4
C506	1:J13	2-Q5	C638	1:H4	1-V3	#IC503	1:G13	2-N5	Q509	1:G6	2-D6
C507	1:J13	2-Q5	C639	1:G5	1-V2	IC504	1:H12	2-S9	Q510	1:B4	2-L3
C508	1:J13	2-P5	C640	1:J1	1-U2	IC505	1:G12	2-Q5	#Q511	1:H2	2-V9
C509	1:F7	2-D5	C641	1:H4	1-S3	IC510	1:G3	2-V5	Q513	1:E9	2-T2
C510	1:B2	2-L0	C642	1:G4	1-R3	IC510	1:G3	2-U3	Q514	1:F6	2-C4
C511	1:E9	2-U4	C643	1:G5	1-Q3	IC511	1:E13	2-A0	Q515	1:E6	2-C4
C512	1:F7	2-D3	C644	1:H5	1-Q3	IC511	1:E13	2-S5	Q516	1:E6	2-D4
C514	1:H2	2-B9	C645	1:B1	2-B7	IC513	1:H1	2-A8	Q517	1:D7	2-D4
C514A	1:H2	2-A9	C646	1:H6	1-Q2	IC514	1:J2	2-A9	#Q518	1:D10	2-K2
C514B	1:H2	2-B9	C647	1:H4	1-S3	#IC517	1:E8	2-Q1	Q601	1:F5	1-J4
C516	1:B13	2-U2	C648	1:D1	1-E2	#IC550	1:H10	2-J7	Q602	1:B5	1-M4
C517	1:G7	2-E6	C650	1:B5	1-L4	IC555	1:C10	2-I2	Q604	1:C6	1-W5
C519	1:J12	2-P8	C651	1:C5	1-N4	IC601	1:D1	1-E3	Q605	1:H4	1-T3
C520	1:E9	2-P3	C652	1:F3	2-U6	IC601	1:D1	1-Q9	Q606	1:G6	1-W4
C522	1:G1	2-B4	C653	1:F4	2-V6	IC601	1:D1	1-C2	Q607	1:G5	1-W3
C523	1:F6	2-C4	#C660	1:C3	1-I5	IC601	1:D1	1-H2	Q608	1:C6	1-W5
C524	1:C2	2-B6	#C661	1:B3	1-J5	IC601	1:D1	1-G2	Q700	1:G4	1-S6
C525	1:H2	2-B3	#C662	1:D6	1-T6	IC603	1:H4	1-V3	Q800	1:E4	1-C6
C526	1:H2	2-B3	#C663	1:F10	1-T9	IC603	1:H4	1-V8	Q802	1:E2	1-H6
C527	1:H2	2-E3	#C664	1:D2	1-Q9	IC603	1:H4	1-R3	Q804	1:E3	1-F5
C529	1:G7	1-V6	#C665	1:H4	1-R9	IC603	1:H4	1-Q2			
C530	1:C1	1-V6	#C666	1:G8	1-S9	IC603	1:H4	1-Q9	R400	1:D6	2-D4
C532	1:G2	2-V8	#C667	1:D5	1-S9	IC604	1:F8	2-C5	R402	1:E6	2-D4
C533	1:E9	2-U2	C700	1:G4	1-Q7	IC604	1:F8	1-V7	R403	1:D6	2-D4
C534	1:D9	2-S3	C701	1:F5	1-R7	IC604	1:F8	2-S2	R500	1:G3	2-T7
C535	1:E8	2-S1	#C703	1:F5	1-Q7	IC604	1:F8	1-R9	R501	1:J11	2-B7
C536	1:E7	2-R1	#C704	1:F4	1-Q6	IC604	1:F8	2-E3	R502	1:J11	2-C7
C537	1:B5	2-S0	C705	1:G4	1-R6	#IC605	1:F9	1-H8	R503	1:F6	2-C4
C538	1:B11	2-T1	#C706	1:G3	1-S7	#IC605	1:F9	1-T9	R504	1:F7	2-E0
C540	1:E4	1-D7	C720	1:E11	2-G8	#IC605	1:F9	1-H8	R505	1:G7	2-E5
C541	1:E4	1-E7	C721	1:B11	2-F2	#IC605	1:F9	1-I8	R506	1:F7	2-E5
C550	1:E13	2-O6	C722	1:E13	2-B0	#IC605	1:F9	1-G8	R507	1:E11	2-F8
C560	1:E13	2-C0	C801	1:C3	1-G6	#IC606	1:F10	1-I8	R508	1:F7	2-D5
C570	1:D10	2-J7	C802	1:C3	1-G6	#IC606	1:F10	1-J7	R509	1:F7	2-B6
C571	1:D10	2-I7	C803	1:C4	1-G6	#IC606	1:F10	1-U9	R510	1:F7	2-C5
#C575	1:H10	2-J8	C804	1:C4	1-H6	#IC606	1:F10	1-V9	R511	1:F7	2-D3
C600	1:G3	2-T7	C805	1:C3	1-G6	#IC606	1:F10	1-V9	R512	1:E7	2-D3
C601	1:J1	1-C8	C806	1:C4	1-K6	IC614	1:D2	1-H7	R514	1:E7	2-D2
C602	1:D2	1-B2	C808	1:C4	1-L7	IC614	1:D2	1-J3	R515	1:F7	2-E2
C603	1:C2	1-C3	#C810	1:D8	2-S2	IC614	1:D2	1-T7	R516	1:D7	2-E3
C605	1:C2	1-A2	C811	1:G7	2-S2	IC614	1:D2	1-M3	#R517	1:F6	2-C4
C607	1:E3	1-D6	#C812	1:D8	2-S2	#IC801	1:D4	1-L6	R518	1:F6	2-B6
C608	1:E4	1-D6	C813	1:D8	2-S1	#IC801	1:D4	1-J6	R519	1:D7	2-E5
C609	1:D4	1-D6	C814	1:D4	1-S8	#IC801	1:D4	1-F6	R520	1:F7	2-E2
C610	1:C2	1-D3	C815	1:E4	1-C6	#IC801	1:D4	1-S8	R521	1:G7	2-D6
#C611	1:D3	1-E6	#C831	1:E4	1-E6	#IC801	1:D4	1-H7	R522	1:G7	2-D6
C613	1:D1	1-E3	C832	1:F8	2-C5	IC802	1:D5	1-O3	R523	1:F7	2-B5
C614	1:C1	1-E3	#C906	1:C4	1-K6	IC802	1:D5	1-S9	#R524	1:E6	2-C4
C615	1:E1	1-F3				IC802	1:D5	1-K2	R525	1:J12	2-T9
C616	1:E1	1-F3	D502	1:E1	2-U7	ID	2:J6	1-P1	R525A	1:J12	2-T9
C617	1:E1	1-H3	D502	1:E1	2-U7				R526	1:J12	2-S9
C618	1:E2	1-H3	D503	1:B6	2-M0	L501	1:E4	1-D8	#R527	1:H10	2-I8
C619	1:E2	1-I3	D503	1:B6	2-N1				R529	1:F6	2-C3
C620	1:E2	1-J3	D800	1:C5	1-K6	MANUAL	2:H10	2-S8	R530	1:J12	2-Q8

Device	PCB	Circuit	Device	PCB	Circuit	Device	PCB	Circuit	Device	PCB	Circuit
R531	1:J12	2-R8	R617	1:C3	1-G6	R702	1:F4	1-R7	#S8	1:F3	2-V5
R532	1:G13	2-R8	R619	1:E1	1-F2	R704	1:F4	1-R7	#S8	1:F3	2-V5
R533	1:G13	2-R8	R620	1:C1	1-E2	R705	1:F4	1-S7	#S9	1:F2	2-V7
R534	1:G13	2-R8	R621	1:E1	1-F2	R706	1:G4	1-Q7	#S9	1:F2	2-V7
R535	1:J11	2-P8	R622	1:D2	1-C2	R709	1:F4	1-Q6	#S9	1:F2	2-V6
#R536	1:D10	2-I7	R623	1:E1	1-G3	R710	1:F4	1-Q6	#S9	1:F2	2-V7
R537	1:B4	2-L3	R624	1:E1	1-G2	R711	1:G4	1-R6	#S9	1:F2	2-V7
R538	1:B4	2-L3	R625	1:E2	1-I3	R712	1:G4	1-R7	#S9	1:F2	2-V7
R539	1:J13	2-Q5	R626	1:E2	1-H2	#R713	1:E11	2-E7	#S9	1:F2	2-V7
R540	1:J13	2-Q5	R627	1:E1	1-H2	#R714	1:E11	2-G6	#S9	1:F2	2-V7
R541	1:J13	2-P5	R628	1:D2	1-I2	#R715	1:D11	2-G6	#S13	1:A2	2-F0
R542	1:D11	2-K3	R629	1:E2	1-J2	R716	1:D11	2-E7	#S14	1:A6	2-O0
R543	1:E2	2-T9	R630	1:B2	1-M2	#R717	1:E11	2-G6	#S14	1:A6	2-L0
R544	1:E2	2-U7	R631	1:B2	1-M2	#R717A	1:E11	2-F6	#S14	1:A6	2-O0
R545	1:F2	2-U8	R632	1:C5	1-J2	R720	1:E3	1-F6	#S14	1:A6	2-O0
R546	1:B9	2-K3	R633	1:D5	1-K2	#R720	1:G5	1-P4	#S14	1:A6	2-O0
R547	1:C7	2-M3	R634	1:D5	1-K3	R721	1:D4	1-J7	#S14	1:A6	2-P0
R548	1:C7	2-K0	R635	1:F5	1-J5	#R730	1:B3	1-L5	#S14	1:A6	2-P0
R549	1:C7	2-L2	R636	1:F5	1-K4	#R731	1:B3	1-S5	#S14	1:A6	2-L0
R550	1:C7	2-L3	R637	1:B2	1-L2	#R732	1:H5	1-T5	#S14	1:A6	2-M0
R551	1:E10	2-O5	R638	1:B2	1-L3	#R733	1:H6	1-T6	#S14	1:A6	2-M0
#R552	1:G13	2-N6	R639	1:B2	2-B2	R801	1:E3	1-I6	#S14	1:A6	2-M0
R553	1:F13	2-P8	R640	1:B2	1-L2	R802	1:E2	1-I6	#S14	1:A6	2-M0
R554	1:D7	2-F4	R641	1:C5	1-N3	R803	1:C4	1-J6	#S14	1:A6	2-N0
#R555	1:D11	2-K2	R642	1:B6	1-M4	R804	1:C4	1-J6	#S14	1:A6	2-N0
R556	1:J11	2-P8	R643	1:C5	1-N2	R805	1:D4	1-K6	#S14	1:A6	2-N0
#R557	1:E10	2-K2	R644	1:C5	1-N3	R806	1:D4	1-K7	#S14	1:A6	2-N0
#R558	1:E10	2-K2	R645	1:C4	1-O5	R807	1:D4	1-K6	#S16	1:A8	2-C8
R559	1:G2	2-W8	R646	1:C5	1-O3	R808	1:D4	1-L7	#S17	1:A10	2-C8
R560	1:G2	2-W8	R647	1:D5	1-Q2	R809	1:D4	1-M6	#S18	1:A12	2-C8
R561	1:E10	2-K4	R648	1:B5	1-M5	R810	1:C4	1-M7	SK501	1:E12	2-F6
R562	1:E9	2-T3	R649	1:G6	1-V4	R811	1:D4	1-S8			
R563	1:E9	2-T2	R650	1:G5	1-W3	R812	1:B2	2-L0	#T3K45	1:B7	1-A1
R564	1:E9	2-T2	R651	1:B1	2-C7	R845	1:E3	1-F5	#T3K44	1:D5	2-V0
R565	1:E9	2-T3	R652	1:B1	2-W6	R846	1:C8	2-Q4	TEST	2:F11	2-O8
R566	1:E8	2-R3	R653	1:F4	2-V6	R847	1:B8	2-Q3	TP602	2:E2	1-F7
R566A	1:D8	2-R3	#R656	1:F4	2-U6	#R900	1:C3	1-H6	TP606	2:E10	2-K3
R567	1:D8	2-S2	R658	1:H6	1-U4	#R901	1:C3	1-F6	TP607	2:E10	2-K3
R568	1:G8	2-S2	R659	1:F3	2-U6	#R902	1:E3	1-I6	TP608	2:E10	2-K3
R569	1:G8	2-S2	R660	1:G6	1-V5	R903	1:G6	1-W4	TP609	1:E10	2-K3
R570	1:F11	2-M8	R662	1:G6	1-W4	RESET	2:H10	2-S8	TP610	1:A7	2-Q0
#R571	1:F8	2-S1	R663	1:C6	1-V5	RV507	1:A13	2-D5	TP615	1:E10	2-K3
R572	1:J11	2-C7	R664	1:H6	1-V4	#RV508	1:C13	2-U1	TP616	1:E10	2-K4
R573	1:F8	2-S1	R665	1:H4	1-U3	#RV599	1:B13	2-T1	TP617	1:D10	2-K3
R578	1:B8	2-Q3	R666	1:H3	1-W2				TP618	1:E10	2-L2
#R579	1:E9	2-P1	R667	1:H3	1-U2	S1	1:H1	2-A1			
R580	1:B9	2-Q4	R668	1:H3	1-U3	S1	1:H1	2-A3	X501	1:H13	2-Q6
R581	1:B8	2-R4	R669	1:H3	1-U2	S1	1:H1	2-A3			
R582	1:C8	2-R4	R670	1:H3	1-T3	S1	1:H1	2-A3			
R583	1:C8	2-R4	R671	1:H3	1-T2	S1	1:H1	2-A3			
R584	1:B6	2-S0	R672	1:H4	1-T3	S1	1:H1	2-A3			
R589	1:B13	2-U1	R673	1:H4	1-S3	S1	1:H1	2-A4			
R590	1:B2	2-J0	R674	1:G4	1-S3	S1	1:H1	2-A4			
R591	1:C8	2-R3	R675	1:H4	1-S2	S1	1:H1	2-A1			
R592	1:B8	2-S3	R676	1:G4	1-R3	S1	1:H1	2-A2			
#R593	1:E8	2-Q1	R677	1:H6	1-R3	S1	1:H1	2-A3			
R594	1:B13	2-U2	R678	1:H5	1-Q2	S1	1:H1	2-A2			
#R595	1:H10	2-Q7	R679	1:H5	1-Q3	S1	1:H1	2-A2			
#R596	1:B13	2-U1	R680	1:H3	1-U3	S1	1:H1	2-A2			
#R597	1:B13	2-U1	R681	1:H5	1-P2	S1	1:H1	2-A2			
R598	1:B13	2-T1	R682	1:H5	1-Q2	S1	1:H1	2-A2			
R600	1:C4	1-L7	R683	1:H5	1-Q2	S2	1:B1	2-C0			
R602	1:E1	1-D2	R684	1:C3	1-G6	#S8	1:F3	2-V5			
R603	1:C2	1-A3	R685	1:H3	1-U2	#S8	1:F3	2-V6			
R604	1:C2	1-B3	R686	1:C6	1-V5	#S8	1:F3	2-V4			
R605	1:C2	1-B3	R687	1:D3	1-A3	#S8	1:F3	2-V4			
R606	1:E4	1-C6	R688	1:D2	1-A2	#S8	1:F3	2-V4			
R607	1:E4	1-D6	R689	1:E4	1-C8	#S8	1:F3	2-V4			
R608	1:C1	1-D3	R690	1:D4	1-D8	#S8	1:F3	2-V4			
R609	1:E1	1-D2	R691	1:H6	1-T4	#S8	1:F3	2-V4			
R610	1:F1	2-A5	R692	1:C2	1-C6	#S8	1:F3	2-V6			
R611	1:C1	1-E3	R693	1:H5	1-Q2	#S8	1:F3	2-V5			
R613	1:E4	1-D6	R699	1:G13	2-N5	#S8	1:F3	2-V5			
R614	1:E3	1-E6	#R700	1:F5	1-Q7	#S8	1:F3	2-V5			
R615	1:C3	1-F6	R700	1:G13	2-O5	#S8	1:F3	2-V5			
R616	1:C3	1-G6	R701	1:G4	1-Q7	#S8	1:F3	2-V5			

# 7.12 T2010 & T2030 Control Head PCB

## T2010 & T2030 Control Head Parts List (IPN 220-01319-01)

Ref	Var	IPN	Description	Ref	Var	IPN	Description
BUSY		008-00010-25	(S) LED 2MM GREEN TOWER 3.8MM BASE ROHM	R587		036-12100-00	RES M/F 0805 CHIP 10E 5%
				R588		036-14220-00	RES M/F 0805 CHIP 2K2 5%
C510		015-06100-08	CAP CER 1206 CHIP 100N 10% X7R 50V	R589		036-14470-00	RES M/F 0805 CHIP 4K7 5%
C511		015-25150-08	CAP CER 0805 CHIP 15N 10% X7R 50V	R590		036-14220-00	RES M/F 0805 CHIP 2K2 5%
C512		015-24100-08	CAP CER 0805 CHIP 1N 10% X7R 50V	R591		036-13150-00	RES M/F 0805 CHIP 150E 5%
C513		015-24100-08	CAP CER 0805 CHIP 1N 10% X7R 50V	R594		036-12100-00	RES M/F 0805 CHIP 10E 5%
C514		015-25100-08	CAP CER 0805 CHIP 10N 10% X7R 50V	S10		240-04021-61	SKT TELEPHONE JACK 6-WAY SIDE ENTY 555163
C515		015-24100-08	CAP CER 0805 CHIP 1N 10% X7R 50V				
C516		015-24470-08	CAP CER 0805 CHIP 4N7 10% X7R 50V	TX		008-00010-21	(S) LED 2MM RED TOWER 3.8MM BASE ROHM S-
C517		015-25100-08	CAP CER 0805 CHIP 10N 10% X7R 50V				
C518		015-25220-08	CAP CER 0805 CHIP 22N 10% X7R 50V				
C531		015-23150-01	CAP CER 0805 CHIP 150P 5% NPO 50V				
C570		015-06100-08	CAP CER 1206 CHIP 100N 10% X7R 50V				
DCALL		008-00010-25	(S) LED 2MM GREEN TOWER 3.8MM BASE ROHM				
DAUX		008-00010-25	(S) LED 2MM GREEN TOWER 3.8MM BASE ROHM				
DSCAN		008-00010-25	(S) LED 2MM GREEN TOWER 3.8MM BASE ROHM				
DMON		008-00010-25	(S) LED 2MM GREEN TOWER 3.8MM BASE ROHM				
D-C1		008-00010-25	(S) LED 2MM GREEN TOWER 3.8MM BASE ROHM				
D-C2		008-00010-25	(S) LED 2MM GREEN TOWER 3.8MM BASE ROHM				
D-C3		008-00010-25	(S) LED 2MM GREEN TOWER 3.8MM BASE ROHM				
D-C4		008-00010-25	(S) LED 2MM GREEN TOWER 3.8MM BASE ROHM				
D502		001-10000-99	(S) DIODE SMD BAV99 DUAL SWTCH SNGLE INL				
D520		008-00010-15	(S) LED 3MM GREEN HLMP1585 DIFSD 2V3 6.0				
D521		008-00010-15	(S) LED 3MM GREEN HLMP1585 DIFSD 2V3 6.0				
D522		008-00010-15	(S) LED 3MM GREEN HLMP1585 DIFSD 2V3 6.0				
IC507		002-10140-21	(S) IC MC14021BDR2 8BIT SHIFT REGISTR.SO				
IC508		002-74905-95	(S) IC SMD 74HC595 SHIFT REGISTER				
IC514		002-74905-95	(S) IC SMD 74HC595 SHIFT REGISTER				
IC515		002-74900-04	(S) IC SMD 74HC04D HEX INVERTER BUFFD				
P8		240-00026-24	CONN PADLE BRD 16 WAY MICRO MATCH 1-2155				
P11		240-00020-87	HEADER 2X5 WAY RGT ANGLE PCB MTG MOLEX				
PT501		040-05100-20	SWITCH ROT 10K LOG POT 3A 16VDC SPST PC				
Q506		000-10008-48	(S) XSTR SMD BCW60/BC848B215 NPN SOT23 A				
Q550		000-10008-48	(S) XSTR SMD BCW60/BC848B215 NPN SOT23 A				
R517		036-10000-00	RES M/F 0805 CHIP ZERO OHM				
R544		036-15470-00	RES M/F 0805 CHIP 47K 5%				
R545		036-15470-00	RES M/F 0805 CHIP 47K 5%				
R548		036-13560-00	RES M/F 0805 CHIP 560E 5%				
R549		036-13560-00	RES M/F 0805 CHIP 560E 5%				
R550		036-13560-00	RES M/F 0805 CHIP 560E 5%				
R551		036-13560-00	RES M/F 0805 CHIP 560E 5%				
R552		036-13560-00	RES M/F 0805 CHIP 560E 5%				
R553		036-13560-00	RES M/F 0805 CHIP 560E 5%				
R554		036-13560-00	RES M/F 0805 CHIP 560E 5%				
R555		036-13560-00	RES M/F 0805 CHIP 560E 5%				
R556		036-15470-00	RES M/F 0805 CHIP 47K 5%				
R557		036-15470-00	RES M/F 0805 CHIP 47K 5%				
R558		036-15470-00	RES M/F 0805 CHIP 47K 5%				
R559		036-15470-00	RES M/F 0805 CHIP 47K 5%				
R560		036-15470-00	RES M/F 0805 CHIP 47K 5%				
R561		036-15470-00	RES M/F 0805 CHIP 47K 5%				
R562		036-15470-00	RES M/F 0805 CHIP 47K 5%				
R563		036-15470-00	RES M/F 0805 CHIP 47K 5%				
R564		036-13470-00	RES M/F 0805 CHIP 470E 5%				
R565		036-13470-00	RES M/F 0805 CHIP 470E 5%				
R566		036-13470-00	RES M/F 0805 CHIP 470E 5%				
R567		036-14100-00	RES M/F 0805 CHIP 1K 5%				
R573		036-14100-00	RES M/F 0805 CHIP 1K 5%				
R574		036-13560-00	RES M/F 0805 CHIP 560E 5%				
R575		036-13560-00	RES M/F 0805 CHIP 560E 5%				
R576		036-13560-00	RES M/F 0805 CHIP 560E 5%				
R577		036-13560-00	RES M/F 0805 CHIP 560E 5%				

## T2010 & T2030 Control Head Mechanical & Miscellaneous Parts

IPN	Description	IPN	Description
-----	-------------	-----	-------------

220-01319-01	PCB T2010/30 DISPLAY BRD		
240-00020-54	PLUG 16 WAY 2X8 FLAT CABLE TERMN MICROMATCH		
240-04020-72	SKT HOUSING 2 WAY CORD MTG ULTREX		
240-04020-99	SKT RECEPTACLE SML WIRE CRIMP FOR ULTREX HOUS		
250-00010-19	SPKR A3M2520 C/W RUBBER SEALING RING		
301-00001-05	ADAPTOR FRT PNL T2000 SII		
304-07035-00	LIGHT SPREADER A2M2531 BUTTONS T2000 FM1/TR1		
304-07037-00	LIGHT SPREADER A4M2533 KNOB T2000 FM1/TR1		
311-01042-01	KNOB A3M2530 T2000 S11		
349-00010-22	SCREW NO 4X3/8 PAN POZI PLASTITE		
349-00010-24	SCREW #4X5/8 PLASTITE PAN POZI		
357-00010-03	FIX PUSH ON SFO 2938		
365-00100-20	LABEL WHITE S/A 28X11MM QUIKSTIK RW718/4		
429-20000-05	T2000 SERIES II INSTALLATION GUIDE		

### T2010 VARIANT PARTS

201-00030-10	WIRE #1 T/C WIRE 7/0.2MM PVC BLACK
205-00010-12	CABLE FLAT RBBN 16 CORE 16/7/0.1 GREY
311-03074-01	KEYPAD T2010 SII INTERNATIONAL
316-06428-01	PNL FRT SCR N T2010 SII
349-00020-30	SCREW TAPTITE M3X6MM PAN POZI BZ
400-00020-07	SLEEVING 2MM SIL RUBBER
459-20100-02	T2010/T2015 SERIES II USERS GUIDE

### T2010 EMC VARIANT PARTS

205-00010-16	CABLE FLAT RBBN 25 CORE 28 AWG GREY
240-00010-91	CONN MALE ON WIRE 18WAY MICROMATCH
311-03074-01	KEYPAD T2010 SII INTERNATIONAL
316-06428-01	PNL FRT SCR N T2010 SII
369-00020-30	TAPE VINYLFOAM 2 SIDE S/A 24*1.5MM INSEAL 516
459-20100-02	T2010/T2015 SERIES II USERS GUIDE
X2EF03	EMC FILTER PCB ASSEMBLY T201X T2030

### T2030 VARIANT PARTS

201-00030-10	WIRE #1 T/C WIRE 7/0.2MM PVC BLACK
205-00010-12	CABLE FLAT RBBN 16 CORE 16/7/0.1 GREY
240-00026-24	CONN PADLE BRD 16 WAY MICRO MATCH 1-215570-6
311-03077-01	KEYPAD T2030 SII INTERNATIONAL
316-06429-01	PNL FRT SCR N T2030 SII
349-00020-30	SCREW TAPTITE M3X6MM PAN POZI BZ
400-00020-07	SLEEVING 2MM SIL RUBBER
459-20300-02	T2030/T2035 SERIES II USERS GUIDE

### T2030 EMC VARIANT PARTS

205-00010-16	CABLE FLAT RBBN 25 CORE 28 AWG GREY
240-00010-91	CONN MALE ON WIRE 18WAY MICROMATCH
240-00026-24	CONN PADLE BRD 16 WAY MICRO MATCH 1-215570-6
311-03077-01	KEYPAD T2030 SII INTERNATIONAL
316-06429-01	PNL FRT SCR N T2030 SII
356-00010-01	TAG SOLDER 3MM SHORT M6132/3.2
369-00020-30	TAPE VINYLFOAM 2 SIDE S/A 24*1.5MM INSEAL 516
400-00020-07	SLEEVING 2MM SIL RUBBER
459-20300-02	T2030/T2035 SERIES II USERS GUIDE
X2EF03	EMC FILTER PCB ASSEMBLY T201X T2030



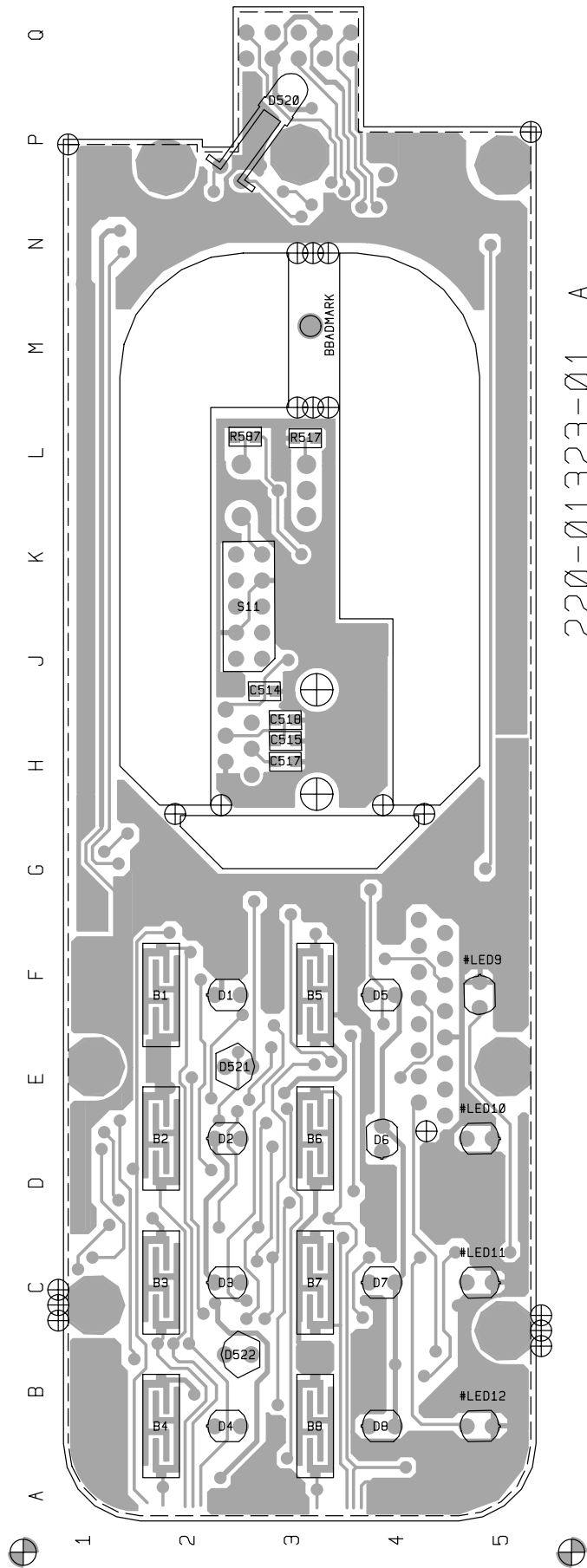

T2010 & T2030 Control Head PCB (IPN 220-01319-01) - Bottom Side

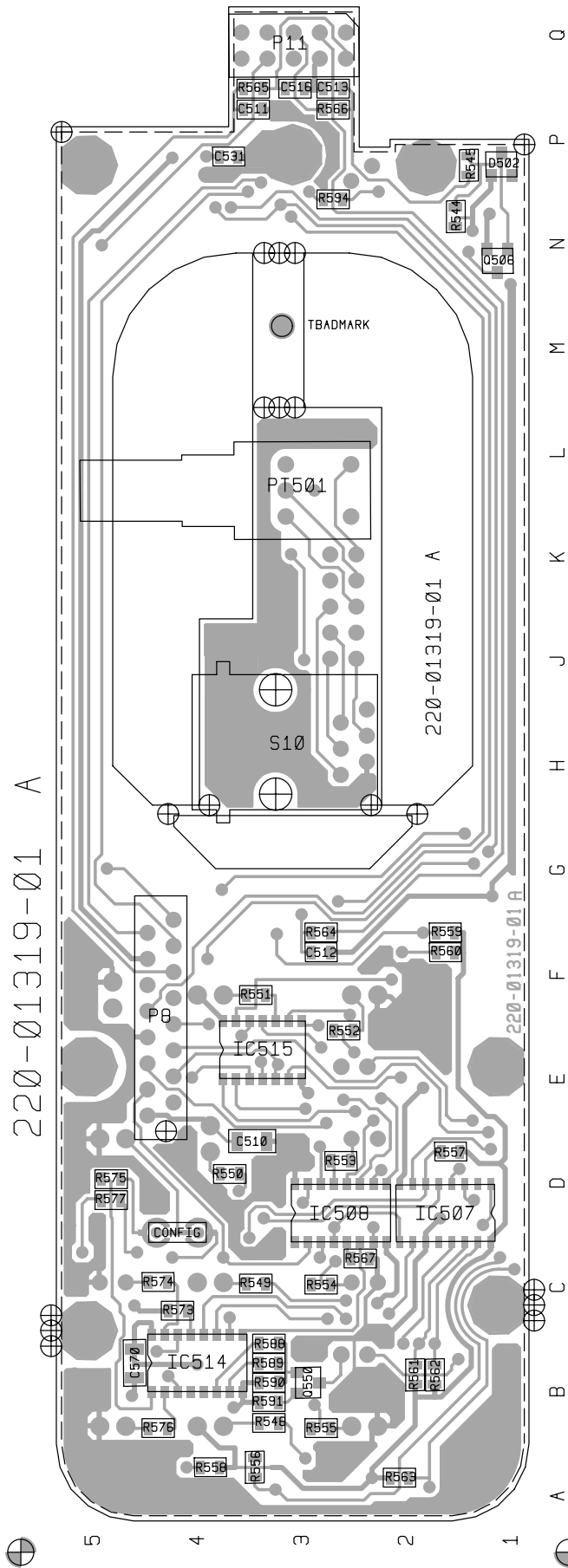

T2010 & T2030 Control Head PCB (IPN 220-01319-01) - Top Side

# 7.13 T2015 & T2060 Control Head PCB

## T2015 & T2060 Control Head Parts List (IPN 220-01320-01)

Ref	Var	IPN	Description	Ref	Var	IPN	Description
BUSY		008-00010-25	(S) LED 2MM GREEN TOWER 3.8MM BASE ROHM	R589		036-14470-00	RES M/F 0805 CHIP 4K7 5%
				R590		036-14220-00	RES M/F 0805 CHIP 2K2 5%
C510		015-06100-08	CAP CER 1206 CHIP 100N 10% X7R 50V	R591		036-13150-00	RES M/F 0805 CHIP 150E 5%
C511		015-25150-08	CAP CER 0805 CHIP 15N 10% X7R 50V	R594		036-12100-00	RES M/F 0805 CHIP 10E 5%
C512		015-24100-08	CAP CER 0805 CHIP 1N 10% X7R 50V	R596A		036-13680-00	RES M/F 0805 CHIP 680E 5%
C513		015-24100-08	CAP CER 0805 CHIP 1N 10% X7R 50V	R596B		036-13680-00	RES M/F 0805 CHIP 680E 5%
C516		015-24470-08	CAP CER 0805 CHIP 4N7 10% X7R 50V	R596C		036-13680-00	RES M/F 0805 CHIP 680E 5%
C517		015-25220-08	CAP CER 0805 CHIP 22N 10% X7R 50V	R596D		036-13680-00	RES M/F 0805 CHIP 680E 5%
C518		015-24100-08	CAP CER 0805 CHIP 1N 10% X7R 50V	R596E		036-13680-00	RES M/F 0805 CHIP 680E 5%
C519		015-25100-08	CAP CER 0805 CHIP 10N 10% X7R 50V	R596F		036-13680-00	RES M/F 0805 CHIP 680E 5%
C520		015-24330-08	CAP CER 0805 CHIP 3N3 10% X7R 50V	R596G		036-13680-00	RES M/F 0805 CHIP 680E 5%
C531		015-23150-01	CAP CER 0805 CHIP 150P 5% NPO 50V	R597A		036-13680-00	RES M/F 0805 CHIP 680E 5%
C542		015-06100-08	CAP CER 1206 CHIP 100N 10% X7R 50V	R597B		036-13680-00	RES M/F 0805 CHIP 680E 5%
C543		015-06100-08	CAP CER 1206 CHIP 100N 10% X7R 50V	R597C		036-13680-00	RES M/F 0805 CHIP 680E 5%
C570		015-06100-08	CAP CER 1206 CHIP 100N 10% X7R 50V	R597D		036-13680-00	RES M/F 0805 CHIP 680E 5%
C580		015-06100-08	CAP CER 1206 CHIP 100N 10% X7R 50V	R597E		036-13680-00	RES M/F 0805 CHIP 680E 5%
				R597F		036-13680-00	RES M/F 0805 CHIP 680E 5%
DSCAN		008-00010-25	(S) LED 2MM GREEN TOWER 3.8MM BASE ROHM	R597G		036-13680-00	RES M/F 0805 CHIP 680E 5%
DAUX		008-00010-25	(S) LED 2MM GREEN TOWER 3.8MM BASE ROHM	R598		036-14220-00	RES M/F 0805 CHIP 2K2 5%
DCALL		008-00010-25	(S) LED 2MM GREEN TOWER 3.8MM BASE ROHM	R599		036-14470-00	RES M/F 0805 CHIP 4K7 5%
DMON		008-00010-25	(S) LED 2MM GREEN TOWER 3.8MM BASE ROHM				
D502		001-10000-99	(S) DIODE SMD BAV99 DUAL SWTCH SNGLE INL	S8B		240-04020-50	SKT 8WAY 2ROW(2X4) PCB MTG MICROMATCH
D520		008-00010-15	(S) LED 3MM GREEN HLMP1585 DIFSD 2V3 6.0	S10		240-04021-61	SKT TELEPHONE JACK 6-WAY SIDE ENTY 555163
D521		008-00010-15	(S) LED 3MM GREEN HLMP1585 DIFSD 2V3 6.0				
D522		008-00010-15	(S) LED 3MM GREEN HLMP1585 DIFSD 2V3 6.0	TX		008-00010-21	(S) LED 2MM RED TOWER 3.8MM BASE ROHM SL
				TENS		008-00020-29	(S) LED DISPLAY GREEN 7 SEG SINGLE HDSP-
IC507		002-10140-21	(S) IC MC14021BDR2 8BIT SHIFT REGSTR.SO				
IC508		002-74905-95	(S) IC SMD 74HC595 SHIFT REGISTER	UNITS		008-00020-29	(S) LED DISPLAY GREEN 7 SEG SINGLE HDSP
IC510		002-10045-43	(S) IC SMD 4543 BCD 7SEG DECODE/DRIVER				
IC512		002-10045-43	(S) IC SMD 4543 BCD 7SEG DECODE/DRIVER				
IC514		002-74905-95	(S) IC SMD 74HC595 SHIFT REGISTER				
IC515		002-74900-04	(S) IC SMD 74HC04D HEX INVERTER BUFFD				
P8A		240-00026-23	CONN PADLE BD 8 WAY MICRO MATCH 0-215570-				
P11		240-00020-87	HEADER 2X5 WAY RGT ANGLE PCB MTG MOLEX				
PT501		040-05100-20	SWITCH ROT 10K LOG POT 3A 16VDC SPST PC				
Q506		000-10008-48	(S) XSTR SMD BCW60/BC848B215 NPN SOT23 A				
Q508		000-10008-57	(S) XSTR SMD BCW70 PNP SOT23 AF SML SIG				
Q509		000-10008-48	(S) XSTR SMD BCW60/BC848B215 NPN SOT23 A				
Q550		000-10008-48	(S) XSTR SMD BCW60/BC848B215 NPN SOT23 A				
R500		036-14100-00	RES M/F 0805 CHIP 1K 5%				
R517		036-10000-00	RES M/F 0805 CHIP ZERO OHM				
R544		036-15470-00	RES M/F 0805 CHIP 47K 5%				
R545		036-15470-00	RES M/F 0805 CHIP 47K 5%				
R552		036-13560-00	RES M/F 0805 CHIP 560E 5%				
R553		036-13560-00	RES M/F 0805 CHIP 560E 5%				
R554		036-13560-00	RES M/F 0805 CHIP 560E 5%				
R555		036-13560-00	RES M/F 0805 CHIP 560E 5%				
R556		036-15470-00	RES M/F 0805 CHIP 47K 5%				
R557		036-15470-00	RES M/F 0805 CHIP 47K 5%				
R558		036-15470-00	RES M/F 0805 CHIP 47K 5%				
R559		036-15470-00	RES M/F 0805 CHIP 47K 5%				
R560		036-15470-00	RES M/F 0805 CHIP 47K 5%				
R561		036-15470-00	RES M/F 0805 CHIP 47K 5%				
R562		036-15470-00	RES M/F 0805 CHIP 47K 5%				
R563		036-15470-00	RES M/F 0805 CHIP 47K 5%				
R564		036-13470-00	RES M/F 0805 CHIP 470E 5%				
R565		036-13470-00	RES M/F 0805 CHIP 470E 5%				
R566		036-13470-00	RES M/F 0805 CHIP 470E 5%				
R567		036-14100-00	RES M/F 0805 CHIP 1K 5%				
R573		036-14100-00	RES M/F 0805 CHIP 1K 5%				
R576		036-13560-00	RES M/F 0805 CHIP 560E 5%				
R577		036-13560-00	RES M/F 0805 CHIP 560E 5%				
R587		036-12100-00	RES M/F 0805 CHIP 10E 5%				
R588		036-14220-00	RES M/F 0805 CHIP 2K2 5%				

## T2015 & T2060 Control Head Mechanical & Miscellaneous Parts

IPN	Description	IPN	Description
220-01320-01	PCB T2015 DISPLAY BRD		
240-00020-54	PLUG 16 WAY 2X8 FLAT CABLE TERMN MICROMATCH		
240-00020-56	PLUG 8WAY 2ROW(2X4) CORD MTG IDC MICROMATCH		
240-04020-72	SKT HOUSING 2 WAY CORD MTG ULTREX		
240-04020-99	SKT RECEPTACLE SML WIRE CRIMP FOR ULTREX HOUS		
250-00010-19	SPKR A3M2520 C/W RUBBER SEALING RING		
304-07035-00	LIGHT SPREADER A2M2531 BUTTONS T2000 FM1/TR1		
304-07037-00	LIGHT SPREADER A4M2533 KNOB T2000 FM1/TR1		
311-01042-01	KNOB A3M2530 T2000 S11		
312-01049-01	LENS T2015/60 SII GREEN MC DISPLAY		
316-06489-01	PNL FRT SCR N T2015 SII		
349-00010-22	SCREW NO 4X3/8 PAN POZI PLASTITE		
349-00010-24	SCREW #4X5/8 PLASTITE PAN POZI		
356-00010-01	TAG SOLDER 3MM SHORT M6132/3.2		
357-00010-03	FIX PUSH ON SFO 2938		
365-00100-20	LABEL WHITE S/A 28X11MM QUIKSTIK RW718/4		
400-00020-07	SLEEVING 2MM SIL RUBBER		
429-20000-05	T2000 SERIES II INSTALLATION GUIDE		

### T2015 VARIANT PARTS

201-00030-10	WIRE #1 T/C WIRE 7/0.2MM PVC BLACK
205-00010-12	CABLE FLAT RBBN 16 CORE 16/7/0.1 GREY
301-00001-05	ADAPTOR FRT PNL T2000 SII
311-03075-01	KEYPAD T2015 SII INTERNATIONAL
349-00020-30	SCREW TAPTITE M3X6MM PAN POZI BZ
459-20100-02	T2010/T2015 SERIES II USERS GUIDE

### T2015 EMC VARIANT PARTS

205-00010-16	CABLE FLAT RBBN 25 CORE 28 AWG GREY
240-00010-91	CONN MALE ON WIRE 18WAY MICROMATCH
301-00001-03	ADAPTOR FRT PNL T2000 SII
311-03075-01	KEYPAD T2015 SII INTERNATIONAL
459-20100-02	T2010/T2015 SERIES II USERS GUIDE
X2EFO3	EMC FILTER PCB ASSEMBLY T201X T2030

### T2060 VARIANT PARTS

201-00030-10	WIRE #1 T/C WIRE 7/0.2MM PVC BLACK
205-00010-12	CABLE FLAT RBBN 16 CORE 16/7/0.1 GREY
301-00001-03	ADAPTOR FRT PNL T2000 SII
311-03089-01	KEYPAD T2060 SII LTR INTERNATIONAL
459-20600-02	T2060 SERIES II USERS GUIDE

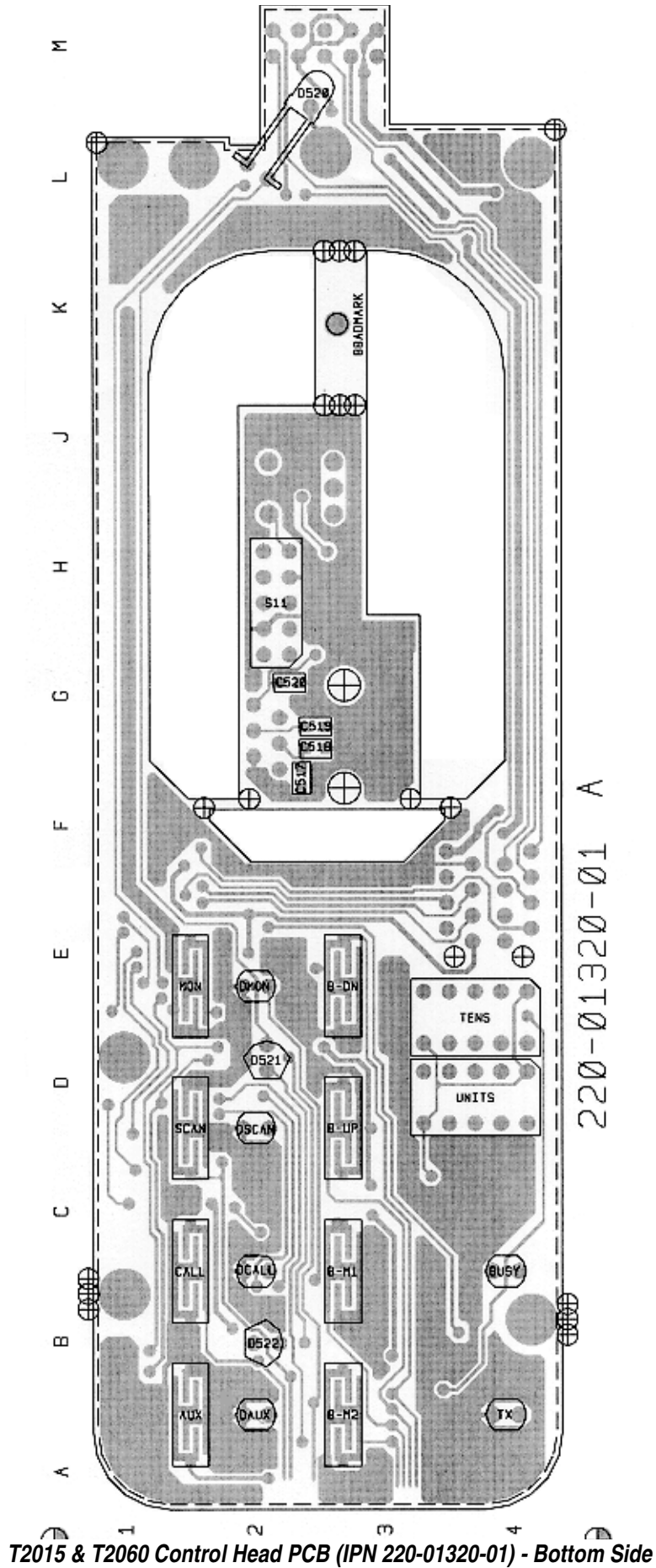

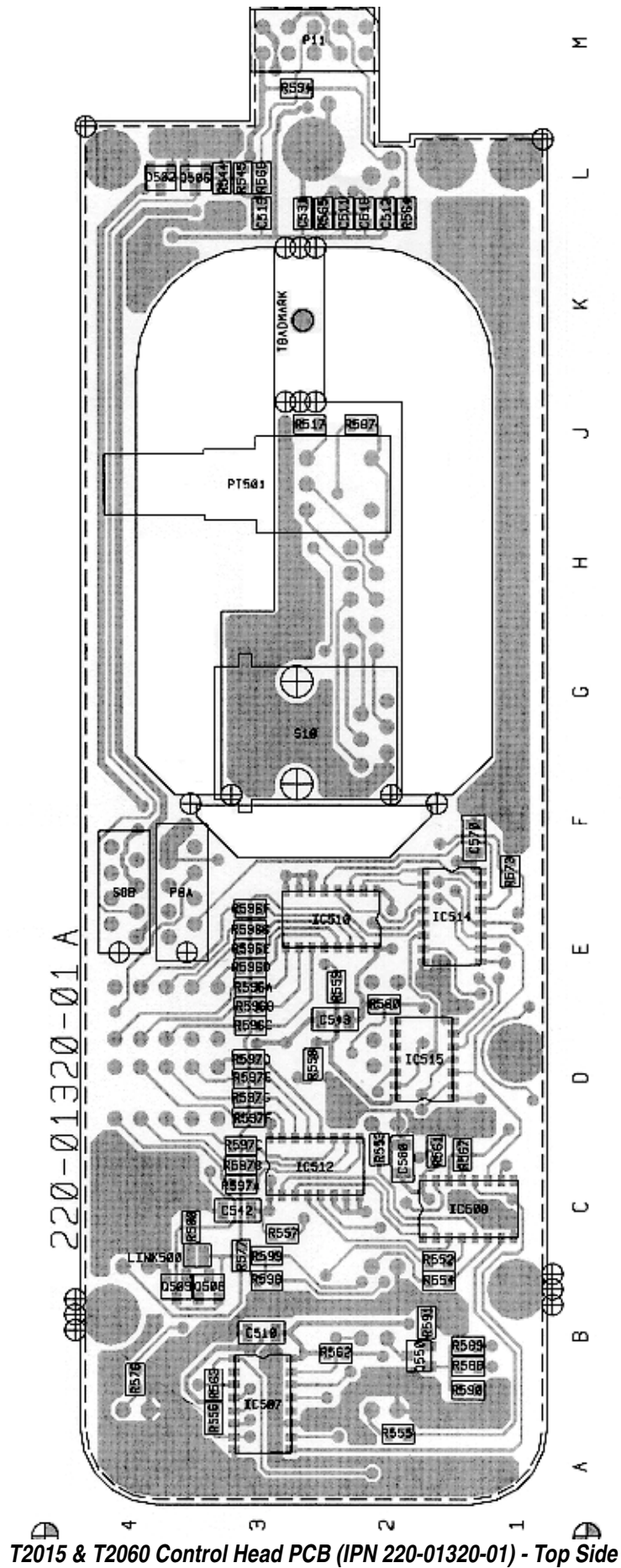

T2015 & T2060 Control Head PCB (IPN 220-01320-01) - Top Side

# 7.14 T2020, T2040 & T2050 Control Head PCB

## T2020, T2040 & T2050 Control Head Parts List (IPN 220-01321-04)

Ref	Var	IPN	Description	Ref	Var	IPN	Description
B701		260-00010-11	LAMP 5V 60MA T-1 3MM OD 0.63LM US REF 68	P11		240-00020-87	HEADER 2X5 WAY RGT ANGLE PCB MTG MOLEX
B702		260-00010-11	LAMP 5V 60MA T-1 3MM OD 0.63LM US REF 68	PT501		040-05100-20	SWITCH ROT 10K LOG POT 3A 16VDC SPST PC
B703		260-00010-11	LAMP 5V 60MA T-1 3MM OD 0.63LM US REF 68				
B704		260-00010-11	LAMP 5V 60MA T-1 3MM OD 0.63LM US REF 68	Q103		000-10008-47	(S) XSTR SMD BCW72 NPN GEN PURPOSE
B705		260-00010-11	LAMP 5V 60MA T-1 3MM OD 0.63LM US REF 68	Q701		000-10008-48	(S) XSTR SMD BCW60/BC848B215 NPN SOT23 A
				Q702		000-10008-57	(S) XSTR SMD BCW70 PNP SOT23 AF SML SIG
C102		014-07470-01	CAP TANT CHIP 4U7 'B' CASE 25V +-10% 267	Q703		000-10008-48	(S) XSTR SMD BCW60/BC848B215 NPN SOT23 A
C103		015-24100-08	CAP CER 0805 CHIP 1N 10% X7R 50V	Q704		000-10008-57	(S) XSTR SMD BCW70 PNP SOT23 AF SML SIG
C531		015-23150-01	CAP CER 0805 CHIP 150P 5% NPO 50V	Q705		000-10008-48	(S) XSTR SMD BCW60/BC848B215 NPN SOT23 A
C700		015-24100-08	CAP CER 0805 CHIP 1N 10% X7R 50V	Q706		000-10008-48	(S) XSTR SMD BCW60/BC848B215 NPN SOT23 A
C701		015-22220-01	CAP CER 0805 CHIP 22P 5% NPO 50V	Q710		000-10008-48	(S) XSTR SMD BCW60/BC848B215 NPN SOT23 A
C702		015-22220-01	CAP CER 0805 CHIP 22P 5% NPO 50V	Q711		000-10008-69	(S) XSTR SMD BC869 PNP 1W 2A SOT-89
C703		015-06100-08	CAP CER 1206 CHIP 100N 10% X7R 50V	Q712		000-10008-48	(S) XSTR SMD BCW60/BC848B215 NPN SOT23 A
C704		015-06100-08	CAP CER 1206 CHIP 100N 10% X7R 50V	Q713		000-10008-57	(S) XSTR SMD BCW70 PNP SOT23 AF SML SIG
C705		015-06100-08	CAP CER 1206 CHIP 100N 10% X7R 50V	Q714		000-10008-48	(S) XSTR SMD BCW60/BC848B215 NPN SOT23 A
C706		016-08470-01	CAP ELECT SMD 6X4MM 47M 16V	Q715		000-10008-57	(S) XSTR SMD BCW70 PNP SOT23 AF SML SIG
C707		015-25100-08	CAP CER 0805 CHIP 10N 10% X7R 50V	R106		036-14220-00	RES M/F 0805 CHIP 2K2 5%
C708		015-24470-08	CAP CER 0805 CHIP 4N7 10% X7R 50V	R517		036-10000-00	RES M/F 0805 CHIP ZERO OHM
C710		015-24100-08	CAP CER 0805 CHIP 1N 10% X7R 50V	R595		036-12100-00	RES M/F 0805 CHIP 10E 5%
C711		015-25150-08	CAP CER 0805 CHIP 15N 10% X7R 50V	R701		036-14270-00	RES M/F 0805 CHIP 2K7 5%
C712		015-24100-08	CAP CER 0805 CHIP 1N 10% X7R 50V	R702		036-14270-00	RES M/F 0805 CHIP 2K7 5%
C713		015-24470-08	CAP CER 0805 CHIP 4N7 10% X7R 50V	R703		036-14270-00	RES M/F 0805 CHIP 2K7 5%
C714		016-08100-01	CAP ELECT 6X4MM CHIP 10M 20% 16V	R704		036-14270-00	RES M/F 0805 CHIP 2K7 5%
C715		016-08100-01	CAP ELECT 6X4MM CHIP 10M 20% 16V	R705		036-15470-00	RES M/F 0805 CHIP 47K 5%
C716		015-06100-08	CAP CER 1206 CHIP 100N 10% X7R 50V	R706		036-15470-00	RES M/F 0805 CHIP 47K 5%
C717		015-25150-08	CAP CER 0805 CHIP 15N 10% X7R 50V	R707		036-15470-00	RES M/F 0805 CHIP 47K 5%
*C720		014-07470-01	CAP TANT CHIP 4U7 'B' CASE 25V +-10% 26	R708		036-15470-00	RES M/F 0805 CHIP 47K 5%
C720		016-08470-01	CAP ELECT SMD 6X4MM 47M 16V	R709		036-15470-00	RES M/F 0805 CHIP 47K 5%
C721		015-24100-08	CAP CER 0805 CHIP 1N 10% X7R 50V	R710		036-13470-00	RES M/F 0805 CHIP 470E 5%
C722		015-06100-08	CAP CER 1206 CHIP 100N 10% X7R 50V	R711		036-13470-00	RES M/F 0805 CHIP 470E 5%
C723		015-06100-08	CAP CER 1206 CHIP 100N 10% X7R 50V	R712		036-13470-00	RES M/F 0805 CHIP 470E 5%
C725		015-24100-08	CAP CER 0805 CHIP 1N 10% X7R 50V	R713		036-15470-00	RES M/F 0805 CHIP 47K 5%
C726		015-24100-08	CAP CER 0805 CHIP 1N 10% X7R 50V	R714		036-15470-00	RES M/F 0805 CHIP 47K 5%
C727		015-06100-08	CAP CER 1206 CHIP 100N 10% X7R 50V	R715		036-14470-00	RES M/F 0805 CHIP 4K7 5%
C728		015-25100-08	CAP CER 0805 CHIP 10N 10% X7R 50V	R716		036-14470-00	RES M/F 0805 CHIP 4K7 5%
C729		015-25100-08	CAP CER 0805 CHIP 10N 10% X7R 50V	R717		036-14270-00	RES M/F 0805 CHIP 2K7 5%
C730		015-24100-08	CAP CER 0805 CHIP 1N 10% X7R 50V	R718		036-15470-00	RES M/F 0805 CHIP 47K 5%
C731		015-25100-08	CAP CER 0805 CHIP 10N 10% X7R 50V	R719		036-15100-00	RES M/F 0805 CHIP 10K 5%
C732		015-25100-08	CAP CER 0805 CHIP 10N 10% X7R 50V	R720		036-12100-00	RES M/F 0805 CHIP 10E 5%
C733		015-24100-08	CAP CER 0805 CHIP 1N 10% X7R 50V	R721		036-15330-00	RES M/F 0805 CHIP 33K 5%
C734		015-25220-08	CAP CER 0805 CHIP 22N 10% X7R 50V	R722		036-15180-00	RES M/F 0805 CHIP 18K 5%
D1		008-00010-25	(S) LED 2MM GREEN TOWER 3.8MM BASE ROHM	R723		036-13330-00	RES M/F 0805 CHIP 330E 5%
D2		008-00010-25	(S) LED 2MM GREEN TOWER 3.8MM BASE ROHM	R724		036-13330-00	RES M/F 0805 CHIP 330E 5%
D3		008-00010-25	(S) LED 2MM GREEN TOWER 3.8MM BASE ROHM	R725		036-12100-00	RES M/F 0805 CHIP 10E 5%
D4		008-00010-25	(S) LED 2MM GREEN TOWER 3.8MM BASE ROHM	R726		036-15680-00	RES M/F 0805 CHIP 68K 5%
D5		008-00010-25	(S) LED 2MM GREEN TOWER 3.8MM BASE ROHM	R727		036-16120-00	RES M/F 0805 CHIP 120K 5%
D6		008-00010-25	(S) LED 2MM GREEN TOWER 3.8MM BASE ROHM	R728		036-12100-00	RES M/F 0805 CHIP 10E 5%
D7		008-00010-25	(S) LED 2MM GREEN TOWER 3.8MM BASE ROHM	R729		036-13330-00	RES M/F 0805 CHIP 330E 5%
D8		008-00010-25	(S) LED 2MM GREEN TOWER 3.8MM BASE ROHM	R730		036-15470-00	RES M/F 0805 CHIP 47K 5%
D701		001-10000-99	(S) DIODE SMD BAV99 DUAL SWITCH SINGLE INL	R731		036-15470-00	RES M/F 0805 CHIP 47K 5%
D703		001-10000-99	(S) DIODE SMD BAV99 DUAL SWITCH SINGLE INL	R733		036-14220-00	RES M/F 0805 CHIP 2K2 5%
D710		001-10084-33	(S) DIODE ZENER SMD BZX84C3V3 SOT23	R734		036-14220-00	RES M/F 0805 CHIP 2K2 5%
D711		001-10084-33	(S) DIODE ZENER SMD BZX84C3V3 SOT23	R735		036-14180-00	RES M/F 0805 CHIP 1K8 5%
D712		001-10084-33	(S) DIODE ZENER SMD BZX84C3V3 SOT23	R736		036-14680-00	RES M/F 0805 CHIP 6K8 5%
D713		001-10084-47	(S) DIODE ZENER SMD BZX84C4V7 SOT23	R737		036-15100-00	RES M/F 0805 CHIP 10K 5%
D714		001-10084-47	(S) DIODE ZENER SMD BZX84C4V7 SOT23	R738		036-14270-00	RES M/F 0805 CHIP 2K7 5%
IC701		002-20068-05	(S) IC MC68HC05C4 MASK PROG.MICRO-P 44P	R739		036-14220-00	RES M/F 0805 CHIP 2K2 5%
IC702		002-10085-76	(S) IC SMD PCF8576T LCD DRIVER SOT-190	R740		036-15120-00	RES M/F 0805 CHIP 12K 5%
IC703		002-74900-04	(S) IC SMD 74HC04D HEX INVERTER BUFFD	R741		036-15330-00	RES M/F 0805 CHIP 33K 5%
IC704		002-74900-04	(S) IC SMD 74HC04D HEX INVERTER BUFFD	R742		036-16560-00	RES M/F 0805 CHIP 560K 5%
IC705		002-10078-05	(S) IC SMD 78L05 5V REG	R743		036-12100-00	RES M/F 0805 CHIP 10E 5%
IC706		002-10340-64	(S) IC SMD MC34064 LO VOLT SENSE	R746		036-15100-00	RES M/F 0805 CHIP 10K 5%
LCD		008-02029-00	(S) LCD DISPLAY A2M2523 8 CHR 14 SEG ALPH	R747		036-16330-00	RES M/F 0805 CHIP 330K 5%
				R750		036-14470-00	RES M/F 0805 CHIP 4K7 5%
				R751		036-13470-00	RES M/F 0805 CHIP 470E 5%
				R752		036-13470-00	RES M/F 0805 CHIP 470E 5%

Ref	Var	IPN	Description	Ref	Var	IPN	Description
R753		036-13330-00	RES M/F 0805 CHIP 330E 5%				
R760		036-14470-00	RES M/F 0805 CHIP 4K7 5%				
R761		036-14470-00	RES M/F 0805 CHIP 4K7 5%				
R762		036-15100-00	RES M/F 0805 CHIP 10K 5%				
R763		036-15100-00	RES M/F 0805 CHIP 10K 5%				
R764		036-14330-00	RES M/F 0805 CHIP 3K3 5%				
R765		036-15100-00	RES M/F 0805 CHIP 10K 5%				
R766		036-15100-00	RES M/F 0805 CHIP 10K 5%				
R767		036-18100-00	RES M/F 0805 CHIP 10M 10%				
R768		036-15470-00	RES M/F 0805 CHIP 47K 5%				
R769		036-16180-00	RES M/F 0805 CHIP 180K 5%				
R770		036-15100-00	RES M/F 0805 CHIP 10K 5%				
R771		036-15100-00	RES M/F 0805 CHIP 10K 5%				
R772		036-15100-00	RES M/F 0805 CHIP 10K 5%				
R773		036-15100-00	RES M/F 0805 CHIP 10K 5%				
R774		036-15100-00	RES M/F 0805 CHIP 10K 5%				
R775		036-15100-00	RES M/F 0805 CHIP 10K 5%				
R776		036-15100-00	RES M/F 0805 CHIP 10K 5%				
R777		036-15100-00	RES M/F 0805 CHIP 10K 5%				
R778		036-13560-00	RES M/F 0805 CHIP 560E 5%				
R779		036-13560-00	RES M/F 0805 CHIP 560E 5%				
R780		036-13560-00	RES M/F 0805 CHIP 560E 5%				
R781		036-13560-00	RES M/F 0805 CHIP 560E 5%				
R782		036-13560-00	RES M/F 0805 CHIP 560E 5%				
R783		036-13560-00	RES M/F 0805 CHIP 560E 5%				
R784		036-13560-00	RES M/F 0805 CHIP 560E 5%				
R785		036-13560-00	RES M/F 0805 CHIP 560E 5%				
R790		036-13470-00	RES M/F 0805 CHIP 470E 5%				
R791		036-13390-00	RES M/F 0805 CHIP 390E 5%				
R792		036-12330-00	RES M/F 0805 CHIP 33E 5%				
R793		036-12330-00	RES M/F 0805 CHIP 33E 5%				
R795		036-13470-00	RES M/F 0805 CHIP 470E 5%				
R796		036-14120-00	RES M/F 0805 CHIP 1K2 5%				
R797		045-15100-00	RES NTC SMD 10K 5%				
S9A		240-04020-50	SKT 8WAY 2ROW(2X4) PCB MTG MICROMATCH				
S10		240-04021-61	SKT TELEPHONE JACK 6-WAY SIDE ENTY 555163				
X701		274-00010-33	XTAL 4MHZ TE-35 HC49U C/W TEFLON INS				



## T2020, T2040 & T2050 Control Head Mechanical & Miscellaneous Parts

IPN	Description	IPN	Description
205-00010-12	CABLE FLAT RBBN 16 CORE 16/7/0.1 GREY		
209-01027-00	STRIP A3M2544 SI IMPREGNATED ELASTOMER 55X8MM		
220-01321-04	PCB T2000 LCD DISPLAY		
240-00020-56	PLUG 8WAY 2ROW(2X4) CORD MTG IDC MICROMATCH		
301-00001-03	ADAPTOR FRT PNL T2000 SII		
304-07036-02	LIGHT SPREADER 20 BUTTON T2000 SII		
311-01042-01	KNOB A3M2530 T2000 S11		
312-01046-03	LENS A2M2543 LCD DISPLAY T2000 FM2/TR2		
316-06430-02	PNL FRT SCR N T2020/40/50 SII		
349-00010-22	SCREW NO 4X3/8 PAN POZI PLASTITE		
349-00010-24	SCREW #4X5/8 PLASTITE PAN POZI		
356-00010-01	TAG SOLDER 3MM SHORT M6132/3.2		
365-00100-20	LABEL WHITE S/A 28X11MM QUIKSTIK RW718/4		
369-00020-29	TAPE VINYL FOAM 2 SIDE S/A 12X0.8MM INSEAL 51		
429-20000-05	T2000 SERIES II INSTALLATION GUIDE		
<b>T2020 VARIANT PARTS</b>			
311-03076-01	KEYPAD T2020 SII INTERNATIONAL		
459-20200-02	T2020 SERIES II USERS GUIDE		
<b>T2020 EMC VARIANT PARTS</b>			
240-00010-91	CONN MALE ON WIRE 18WAY MICROMATCH		
311-03076-01	KEYPAD T2020 SII INTERNATIONAL		
459-20200-02	T2020 SERIES II USERS GUIDE		
X2EF01	EMC FILTER PCB ASSEMBLY T2020 T2035 T2040 T2050		
<b>T2040 VARIANT PARTS</b>			
311-03078-01	KEYPAD T2040 SII INTERNATIONAL		
459-20400-02	T2040 SERIES II USERS GUIDE		
<b>T2040 EMC VARIANT PARTS</b>			
240-00010-91	CONN MALE ON WIRE 18WAY MICROMATCH		
311-03078-01	KEYPAD T2040 SII INTERNATIONAL		
459-20400-02	T2040 SERIES II USERS GUIDE		
X2EF01	EMC FILTER PCB ASSEMBLY T2020 T2035 T2040 T2050		
<b>T2050 VARIANT PARTS</b>			
308-13093-02	CHASSIS A1M2503 DIE CAST T2000 SERIES II		
311-03009-01	KEYPAD T2050 SII INTERNATIONAL DUAL MODE		
459-20200-02	T2020 SERIES II USERS GUIDE		
459-20400-02	T2040 SERIES II USERS GUIDE		



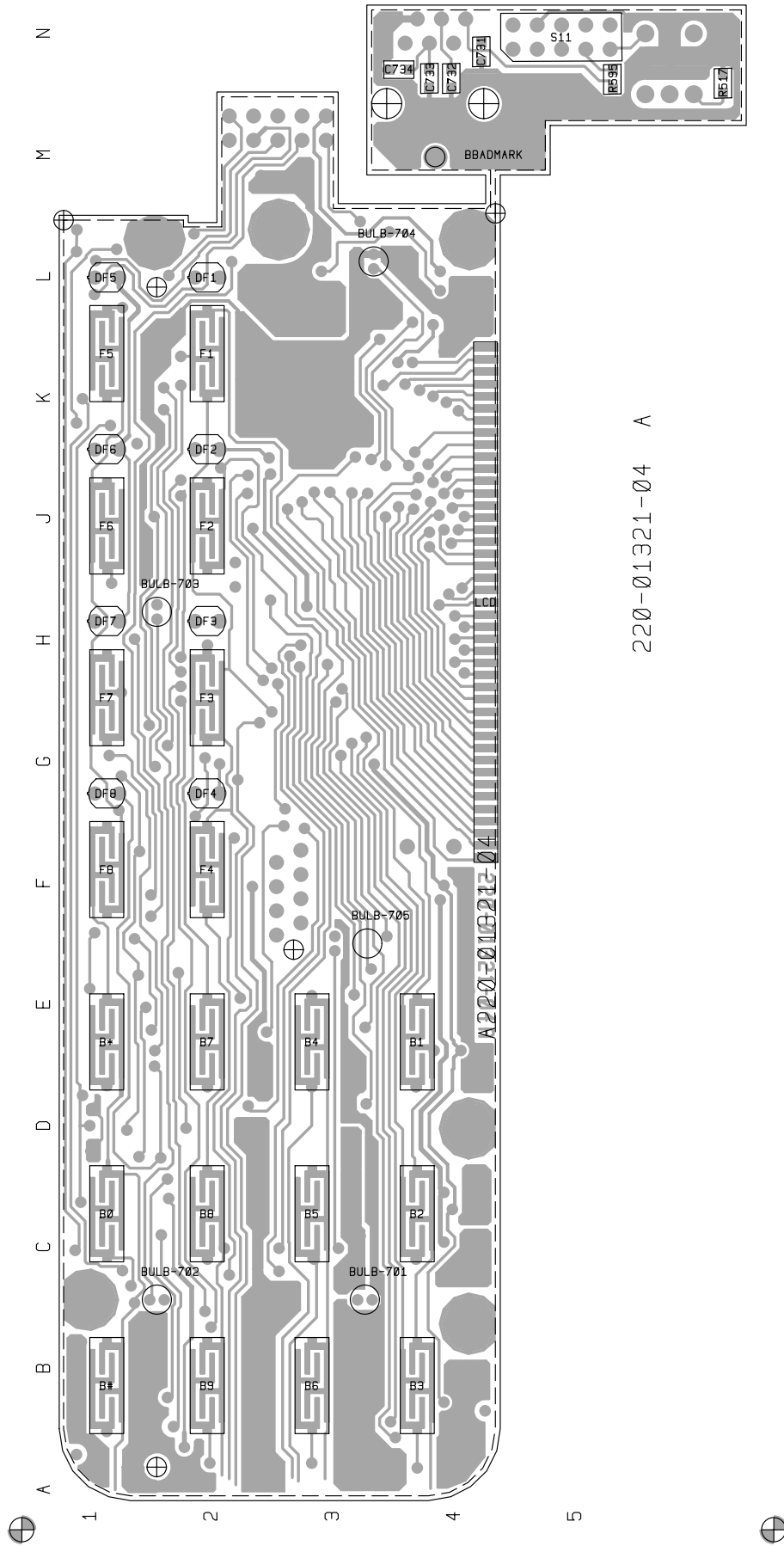

220-01321-04 A

T2020, T2040 & T2050 Control Head PCB (IPN 220-01321-04) - Bottom Side

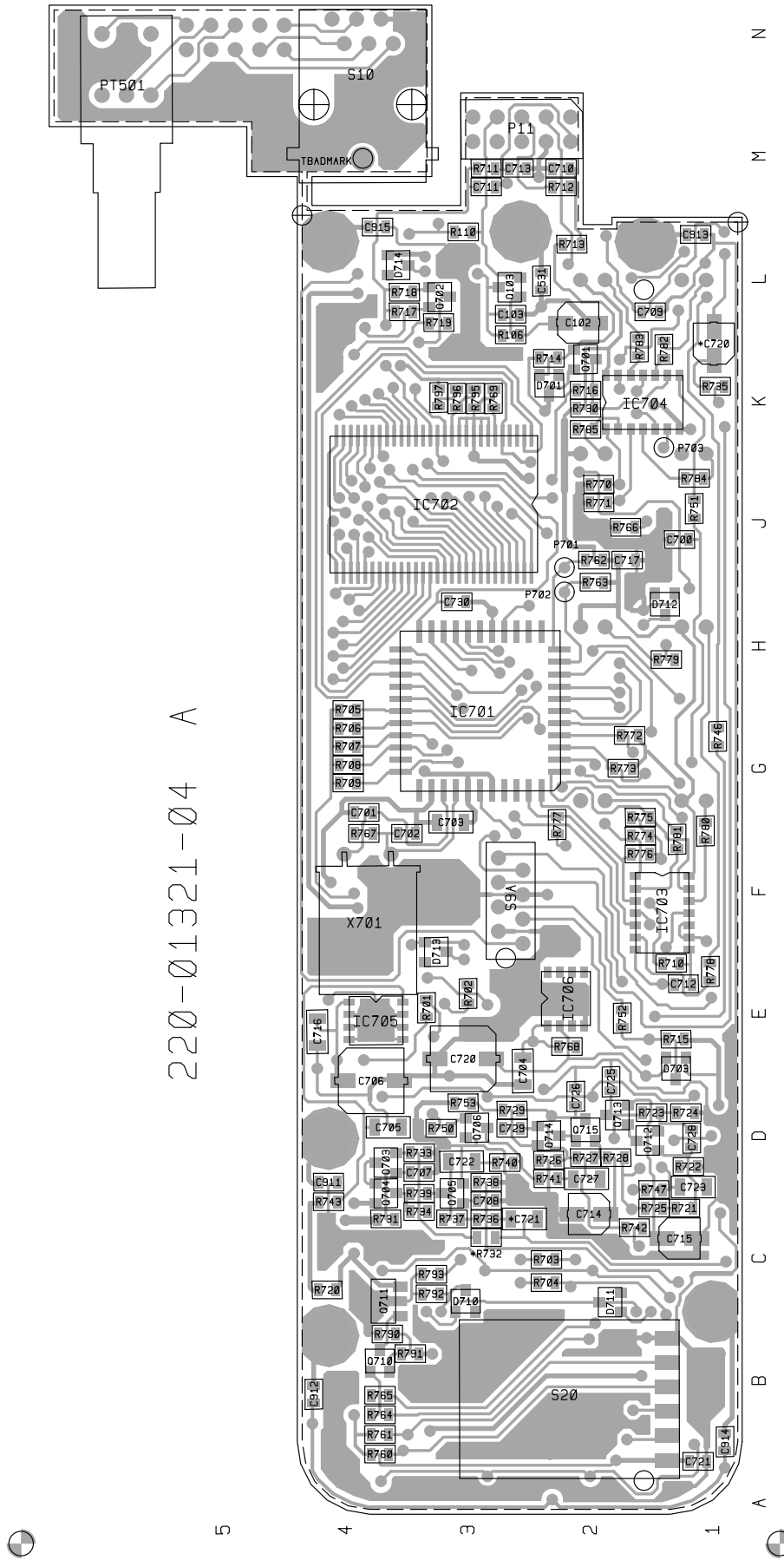

T2020, T2040 & T2050 Control Head PCB (IPN 220-01321-04) - Top Side

# 7.15 T2035 Control Head PCB

## T2035 Control Head Parts List (IPN 220-01322-03)

Ref	Var	IPN	Description	Ref	Var	IPN	Description
CLEAR		008-00010-25	(S) LED 2MM GREEN TOWER 3.8MM BASE ROH	R565		036-13470-00	RES M/F 0805 CHIP 470E 5%
CALLBK		008-00010-25	(S) LED 2MM GREEN TOWER 3.8MM BASE RO	R566		036-13470-00	RES M/F 0805 CHIP 470E 5%
C510		015-24150-08	CAP CER 0805 CHIP 1N5 10% X7R 50V	R567		036-13270-00	RES M/F 0805 CHIP 270E 5%
C511		015-25150-08	CAP CER 0805 CHIP 15N 10% X7R 50V	R573		036-14100-00	RES M/F 0805 CHIP 1K 5%
C512		015-24100-08	CAP CER 0805 CHIP 1N 10% X7R 50V	R574		036-13270-00	RES M/F 0805 CHIP 270E 5%
C513		015-24100-08	CAP CER 0805 CHIP 1N 10% X7R 50V	R575		036-13270-00	RES M/F 0805 CHIP 270E 5%
C516		015-24470-08	CAP CER 0805 CHIP 4N7 10% X7R 50V	R587		036-12100-00	RES M/F 0805 CHIP 10E 5%
C517		015-24330-08	CAP CER 0805 CHIP 3N3 10% X7R 50V	R588		036-14220-00	RES M/F 0805 CHIP 2K2 5%
C518		015-25100-08	CAP CER 0805 CHIP 10N 10% X7R 50V	R589		036-14470-00	RES M/F 0805 CHIP 4K7 5%
C519		015-24100-08	CAP CER 0805 CHIP 1N 10% X7R 50V	R590		036-14220-00	RES M/F 0805 CHIP 2K2 5%
C520		015-25220-08	CAP CER 0805 CHIP 22N 10% X7R 50V	R591		036-13150-00	RES M/F 0805 CHIP 150E 5%
C531		015-23150-01	CAP CER 0805 CHIP 150P 5% NPO 50V	R594		036-12100-00	RES M/F 0805 CHIP 10E 5%
C542		015-06100-08	CAP CER 1206 CHIP 100N 10% X7R 50V	R597		036-13270-00	RES M/F 0805 CHIP 270E 5%
C570		015-06100-08	CAP CER 1206 CHIP 100N 10% X7R 50V	R635		036-15100-00	RES M/F 0805 CHIP 10K 5%
C571		015-06100-08	CAP CER 1206 CHIP 100N 10% X7R 50V	R636		036-13560-00	RES M/F 0805 CHIP 560E 5%
C580		015-06100-08	CAP CER 1206 CHIP 100N 10% X7R 50V	R637		036-13560-00	RES M/F 0805 CHIP 560E 5%
				R638		036-13560-00	RES M/F 0805 CHIP 560E 5%
DVC		008-00010-21	(S) LED 2MM RED TOWER 3.8MM BASE ROHM SL	R639		036-13560-00	RES M/F 0805 CHIP 560E 5%
DSP		008-00010-25	(S) LED 2MM GREEN TOWER 3.8MM BASE ROHM	R643		036-15470-00	RES M/F 0805 CHIP 47K 5%
D502		001-10000-99	(S) DIODE SMD BAV99 DUAL SWITCH SINGLE IN				
D520		008-00010-15	(S) LED 3MM GREEN HLMP1585 DIFSD 2V3 6.	S8B		240-04020-50	SKT 8WAY 2ROW(2X4) PCB MTG MICROMATCH
D521		008-00010-15	(S) LED 3MM GREEN HLMP1585 DIFSD 2V3 6.	S10		240-04021-61	SKT TELEPHONE JACK 6-WAY SIDE ENTY 55516
D522		008-00010-15	(S) LED 3MM GREEN HLMP1585 DIFSD 2V3 6.				
D523		001-10000-99	(S) DIODE SMD BAV99 DUAL SWITCH SINGLE IN	TX		008-00010-21	(S) LED 2MM RED TOWER 3.8MM BASE ROHM SC
D524		001-10000-99	(S) DIODE SMD BAV99 DUAL SWITCH SINGLE IN	TENS		008-00020-29	(S) LED DISPLAY GREEN 7 SEG SINGLE HDSP
FUNCTI		008-00010-25	(S) LED 2MM GREEN TOWER 3.8MM BASE RO	UNITS		008-00020-29	(S) LED DISPLAY GREEN 7 SEG SINGLE HDS
GO		008-00010-25	(S) LED 2MM GREEN TOWER 3.8MM BASE ROHM	WAIT		008-00010-23	(S) LED 2MM YELLOW TOWER 3.8MM BASE ROH
HUNDS		008-00020-29	(S) LED DISPLAY GREEN 7 SEG SINGLE HDS				
IC507		002-10140-21	(S) IC MC14021BDR2 8BIT SHIFT REGSTR.S				
IC508		002-10144-99	(S) IC SMD 4*7 SEGMENT LED DRIVER				
IC514		002-74905-95	(S) IC SMD 74HC595 SHIFT REGISTER				
IC515		002-74900-04	(S) IC SMD 74HC04D HEX INVERTER BUFFD				
IC517		002-74907-40	(S) IC 74HC74 DUAL D-TYPE FLIP FLOP SO				
P8A		240-00026-23	CONN PADLE BD 8 WAY MICRO MATCH 0-215570				
P11		240-00020-87	HEADER 2X5 WAY RGT ANGLE PCB MTG MOLEX				
9							
PT501		040-05100-20	SWITCH ROT 10K LOG POT 3A 16VDC SPST P				
Q506		000-10008-48	(S) XSTR SMD BCW60/BC848B215 NPN SOT23				
Q512		000-10008-48	(S) XSTR SMD BCW60/BC848B215 NPN SOT23				
Q513		000-10008-48	(S) XSTR SMD BCW60/BC848B215 NPN SOT23				
Q514		000-10008-48	(S) XSTR SMD BCW60/BC848B215 NPN SOT23				
Q515		000-10008-48	(S) XSTR SMD BCW60/BC848B215 NPN SOT23				
Q516		000-10008-48	(S) XSTR SMD BCW60/BC848B215 NPN SOT23				
Q550		000-10008-48	(S) XSTR SMD BCW60/BC848B215 NPN SOT23				
R517		036-10000-00	RES M/F 0805 CHIP ZERO OHM				
R544		036-15470-00	RES M/F 0805 CHIP 47K 5%				
R545		036-15470-00	RES M/F 0805 CHIP 47K 5%				
R552		036-13270-00	RES M/F 0805 CHIP 270E 5%				
R553		036-13270-00	RES M/F 0805 CHIP 270E 5%				
R554		036-13270-00	RES M/F 0805 CHIP 270E 5%				
R555		036-13270-00	RES M/F 0805 CHIP 270E 5%				
R556		036-15470-00	RES M/F 0805 CHIP 47K 5%				
R557		036-15470-00	RES M/F 0805 CHIP 47K 5%				
R558		036-15470-00	RES M/F 0805 CHIP 47K 5%				
R559		036-15470-00	RES M/F 0805 CHIP 47K 5%				
R560		036-15470-00	RES M/F 0805 CHIP 47K 5%				
R561		036-15470-00	RES M/F 0805 CHIP 47K 5%				
R562		036-15470-00	RES M/F 0805 CHIP 47K 5%				
R563		036-15470-00	RES M/F 0805 CHIP 47K 5%				
R564		036-13470-00	RES M/F 0805 CHIP 470E 5%				

## T2035 Control Head Mechanical & Miscellaneous Parts

IPN	Description	IPN	Description
220-01322-03	PCB T2033/35 DISPLAY BRD		
240-00020-54	PLUG 16 WAY 2X8 FLAT CABLE TERMN MICROMATCH		
240-00020-56	PLUG 8WAY 2ROW(2X4) CORD MTG IDC MICROMATCH		
240-04020-72	SKT HOUSING 2 WAY CORD MTG ULTREX		
240-04020-99	SKT RECEPTACLE SML WIRE CRIMP FOR ULTREX HOU		
250-00010-19	SPKR A3M2520 C/W RUBBER SEALING RING		
301-00001-05	ADAPTOR FRT PNL T2000 SII		
304-07035-00	LIGHT SPREADER A2M2531 BUTTONS T2000 FM1/TR1		
311-01042-01	KNOB A3M2530 T2000 S11		
311-03080-01	KEYPAD T2035 SII INTERNATIONAL		
312-01057-01	LENS T2035 SII GREEN DISPLAY		
316-06496-01	PNL FRT SCR N T2035 SII		
349-00010-22	SCREW NO 4X3/8 PAN POZI PLASTITE		
349-00010-24	SCREW #4X5/8 PLASTITE PAN POZI		
356-00010-01	TAG SOLDER 3MM SHORT M6132/3.2		
357-00010-03	FIX PUSH ON SFO 2938		
365-00100-20	LABEL WHITE S/A 28X11MM QUIKSTIK RW718/4		
400-00020-07	SLEEVING 2MM SIL RUBBER		
429-20000-05	T2000 SERIES II INSTALLATION GUIDE		
459-20300-02	T2030/T2035 SERIES II USERS GUIDE		
<b>T2035 VARIANT PARTS</b>			
201-00030-10	WIRE #1 T/C WIRE 7/0.2MM PVC BLACK		
205-00010-12	CABLE FLAT RBBN 16 CORE 16/7/0.1 GREY		
304-07037-00	LIGHT SPREADER A4M2533 KNOB T2000 FM1/TR1		
349-00020-30	SCREW TAPTITE M3X6MM PAN POZI BZ		
<b>T2035 EMC VARIANT PARTS</b>			
205-00010-16	CABLE FLAT RBBN 25 CORE 28 AWG GREY		
240-00010-91	CONN MALE ON WIRE 18WAY MICROMATCH		
369-00020-30	TAPE VINYLFOAM 2 SIDE S/A 24*1.5MM INSEAL 51		
X2EF01	EMC FILTER PCB ASSEMBLY T2020 T2035 T2040 T2050		

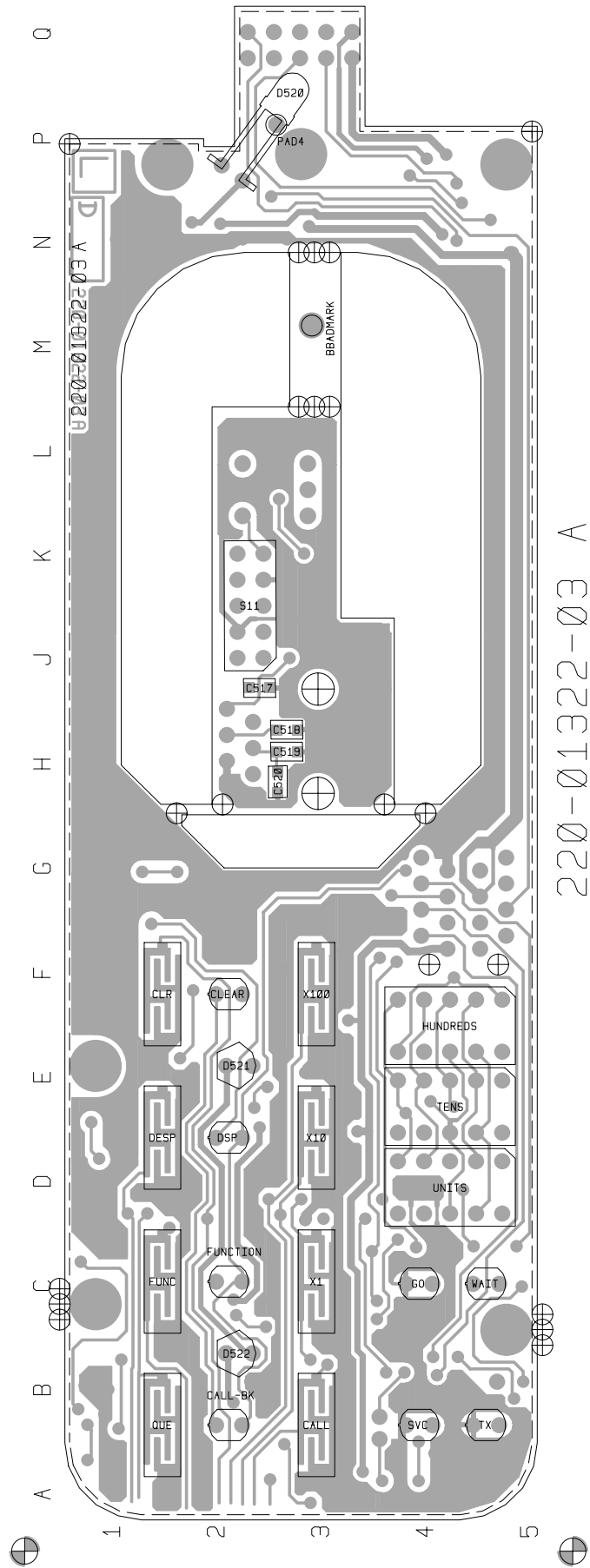

T2035 Control Head PCB (IPN 220-01322-03) - Bottom Side

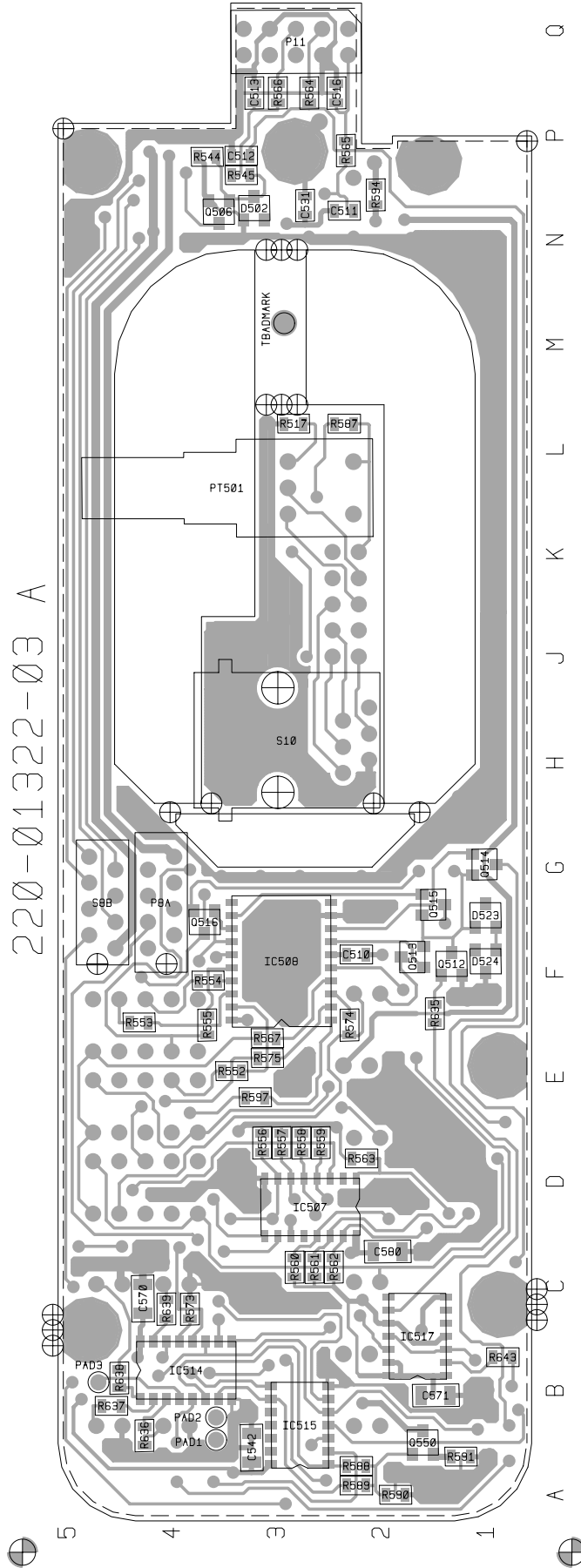

T2035 Control Head PCB (IPN 220-01322-03) - Top Side



## 7.16 T2000 EMC Filter PCB

### T2000 EMC Filter Parts List (IPN 220-01383-01)

Ref	Var	IPN	Description	Ref	Var	IPN	Description
C1		015-23470-08	CAP CER 0805 CHIP 470P 10% X7R 50V				
C2		015-23470-08	CAP CER 0805 CHIP 470P 10% X7R 50V				
C3		015-23470-08	CAP CER 0805 CHIP 470P 10% X7R 50V				
C4	01	015-23150-01	CAP CER 0805 CHIP 150P 5% NPO 50V				
C4	02	015-23150-01	CAP CER 0805 CHIP 150P 5% NPO 50V				
C4	08	015-23470-08	CAP CER 0805 CHIP 470P 10% X7R 50V				
C5		015-23470-08	CAP CER 0805 CHIP 470P 10% X7R 50V				
C6		015-23470-08	CAP CER 0805 CHIP 470P 10% X7R 50V				
C7		015-23470-08	CAP CER 0805 CHIP 470P 10% X7R 50V				
C8		015-23470-08	CAP CER 0805 CHIP 470P 10% X7R 50V				
C9		015-23470-08	CAP CER 0805 CHIP 470P 10% X7R 50V				
C10		015-23470-08	CAP CER 0805 CHIP 470P 10% X7R 50V				
C11		015-23470-08	CAP CER 0805 CHIP 470P 10% X7R 50V				
C12		015-23470-08	CAP CER 0805 CHIP 470P 10% X7R 50V				
C13		015-23470-08	CAP CER 0805 CHIP 470P 10% X7R 50V				
C14		015-23470-08	CAP CER 0805 CHIP 470P 10% X7R 50V				
C15		015-23470-08	CAP CER 0805 CHIP 470P 10% X7R 50V				
C16		015-23470-08	CAP CER 0805 CHIP 470P 10% X7R 50V				
C17		015-23470-08	CAP CER 0805 CHIP 470P 10% X7R 50V				
C18		015-23470-08	CAP CER 0805 CHIP 470P 10% X7R 50V				
PDL-1	01	240-00026-31	CONN PADLE BRD 18WAY MICROMATCH				
PDL-1	02	240-00026-31	CONN PADLE BRD 18WAY MICROMATCH				
PDL-1	03	240-00026-31	CONN PADLE BRD 18WAY MICROMATCH				
PDL-1	08	240-00026-23	CONN PADLE BD 8 WAY MICRO MATCH 0-215570-				
SKT-1	01	240-10000-11	(L) CONN SMD SKT 18WAY MICROMATCH				
SKT-1	02	240-10000-11	(L) CONN SMD SKT 18WAY MICROMATCH				
SKT-1	03	240-10000-11	(L) CONN SMD SKT 18WAY MICROMATCH				
SKT-1	08	240-10000-05	CONN SMD SKT 8WAY 2ROW MICROMATCH				
	02	205-00010-12	CABLE FLAT RBBN 16 CORE 16/7/0.1 GREY				
	08	205-00010-12	CABLE FLAT RBBN 16 CORE 16/7/0.1 GREY				
		220-01383-01	PCB T2000 SII EMC FILTER BRD				
	02	240-00020-56	PLUG 8WAY 2ROW(2X4) CORD MTG IDC MICROM				
	08	240-00020-56	PLUG 8WAY 2ROW(2X4) CORD MTG IDC MICROM				
		349-00020-32	SCREW TAPTITE M3X8MM PAN POZI BZ				

**Variants:** 01 = T2020, T2035, T2040 & T2050 EMC radios

02 = Non-EMC remote mounted radios

03 = T2010, T2015 & T2030 radios

08 = Used in T2000-A03/-A04/-A16 remote kits (refer to Section 8.16)



# EMC FILTER PCB

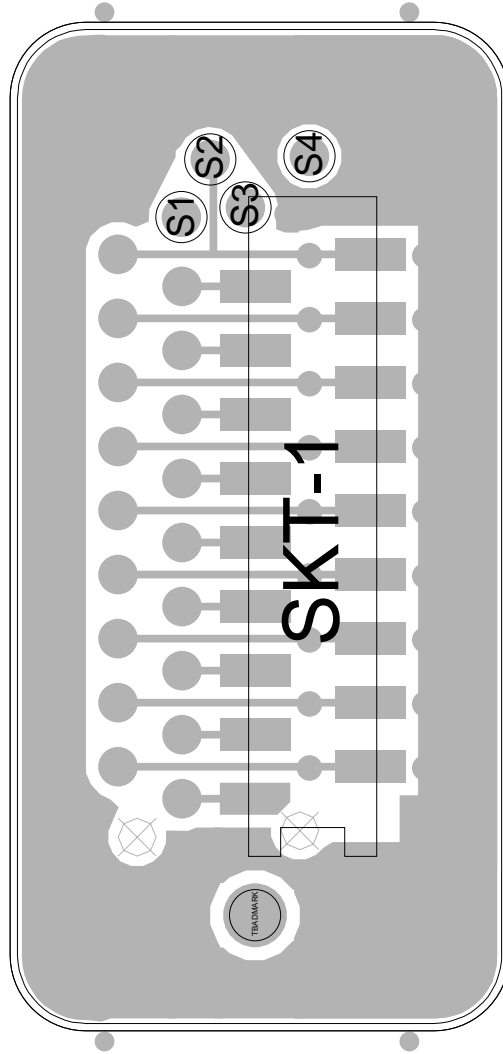

# 220-01383-01 TOP COPPER/DEVICES

T2000 EMC Filter PCB (IPN 220-01383-01) - Top Side

# EMC FILTER PCB

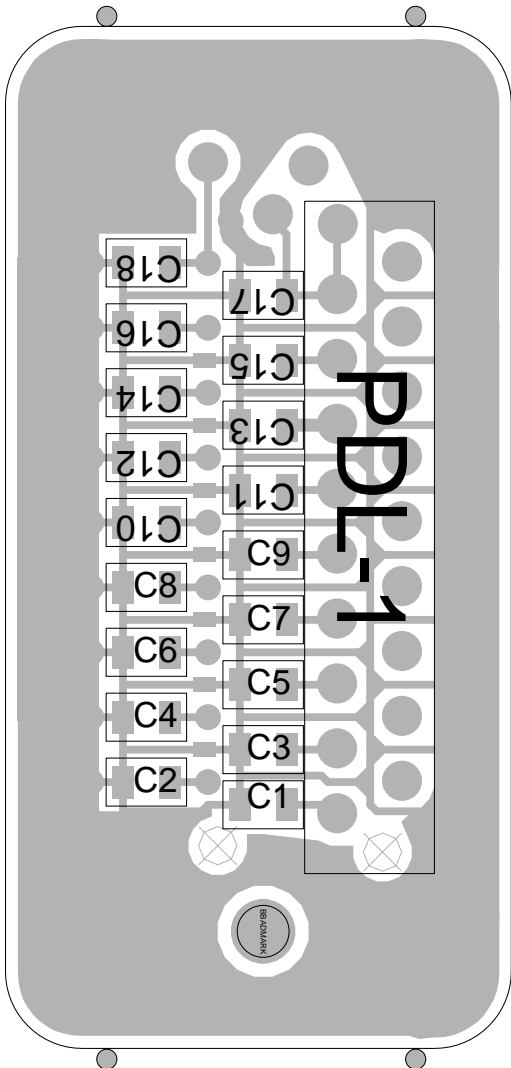

220-01383-01

BOTTOM COPPER/DEVICES

T2000 EMC Filter PCB (IPN 220-01383-01) - Bottom Side

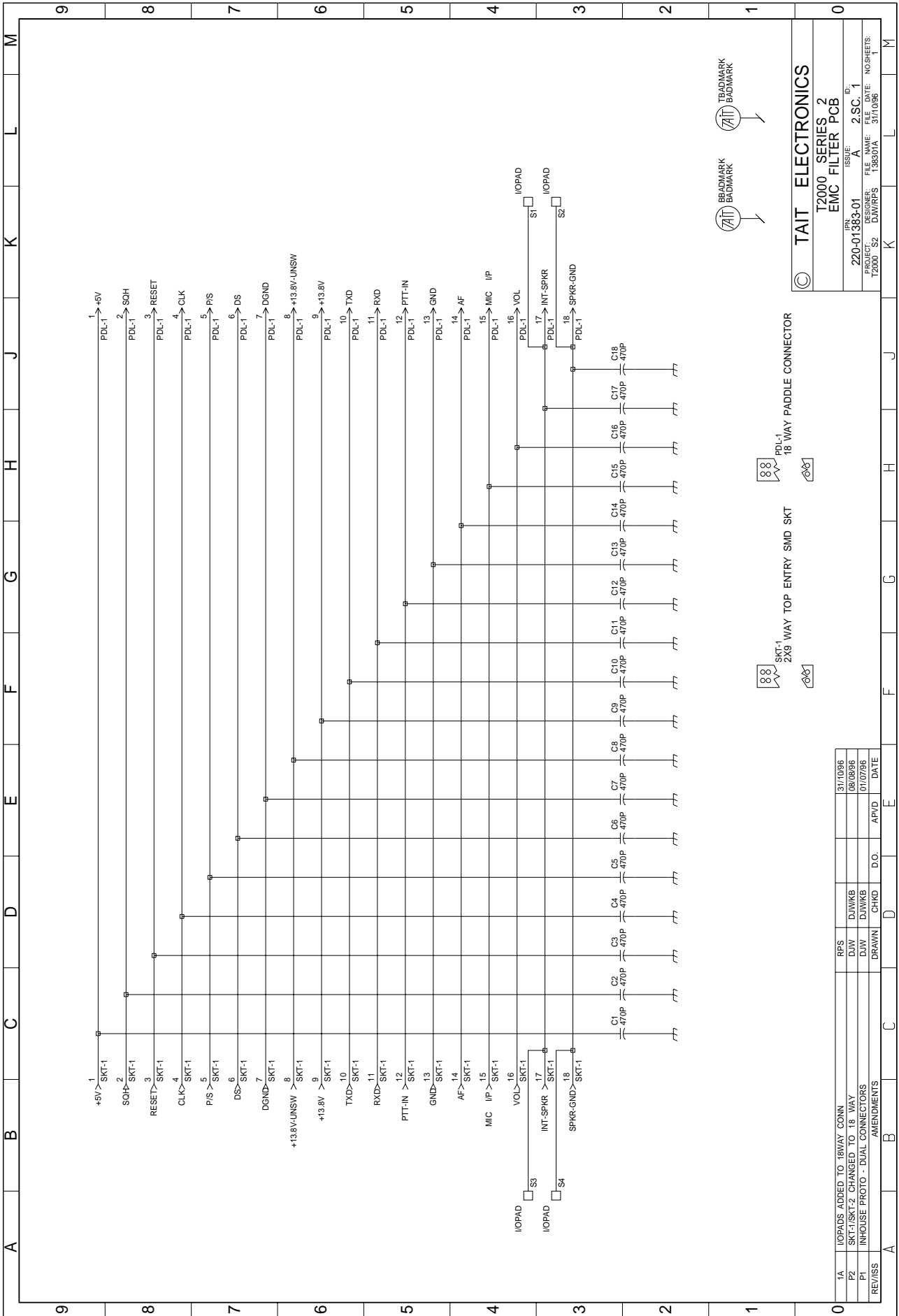



## 7.17 T2000 Data Interface Decoupling PCB

### T2000 Data Interface Parts List (IPN 220-01388-01)

Ref	Var	IPN	Description	Ref	Var	IPN	Description
C1		018-14100-00	CAP 0603 CHIP 1N 50V X7R +-10%				
C2		018-14100-00	CAP 0603 CHIP 1N 50V X7R +-10%				
C3		018-14100-00	CAP 0603 CHIP 1N 50V X7R +-10%				
C4		018-14100-00	CAP 0603 CHIP 1N 50V X7R +-10%				
C5		018-14100-00	CAP 0603 CHIP 1N 50V X7R +-10%				
C6		018-14100-00	CAP 0603 CHIP 1N 50V X7R +-10%				
C7		018-14100-00	CAP 0603 CHIP 1N 50V X7R +-10%				
C8		018-14100-00	CAP 0603 CHIP 1N 50V X7R +-10%				
C9		018-14100-00	CAP 0603 CHIP 1N 50V X7R +-10%				
SKT1		240-02010-40	SKT 9 WAY D RANGE SUB MA				
SKT2		240-04020-84	SKT 24 WAY PCB MTG STAG MA				
		200-00010-03	WIRE T/C 0.9MM				
		220-01388-01	PCB T2000 DATA INT FCE DE-COUPLING				
		349-00020-07	(L) SCREW 4-40 X 5/16 PAN POZI TAPTITE BLACK				
		354-01041-00	FASTENER SCREW LOCK KIT (4-40 THREAD FOR DRANGE)				
		356-00010-05	TAG SOLDER 4MM LONG M MT				





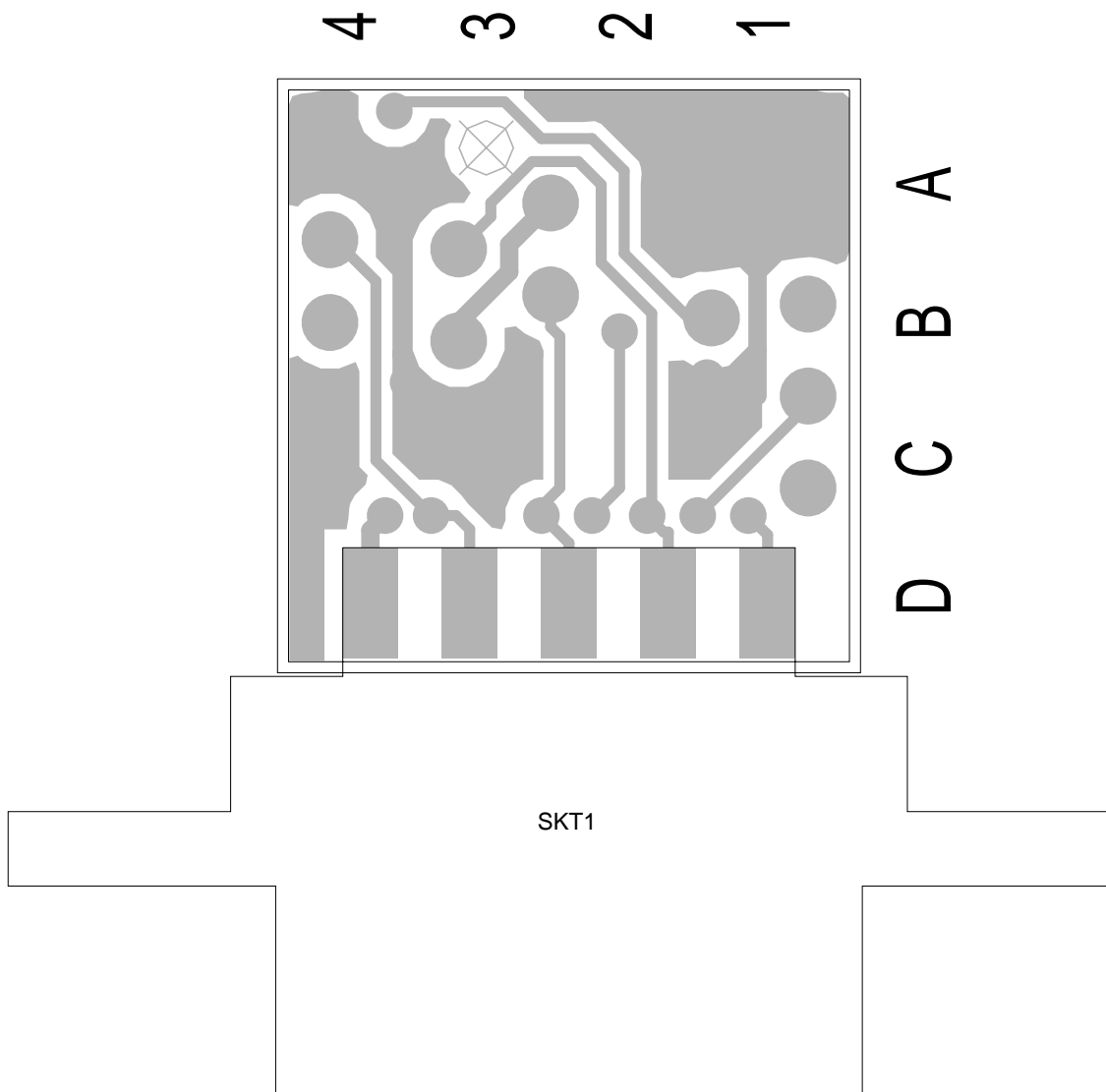

T2000 Data Interface Decoupling PCB (IPN 220-01388-01) - Bottom Side

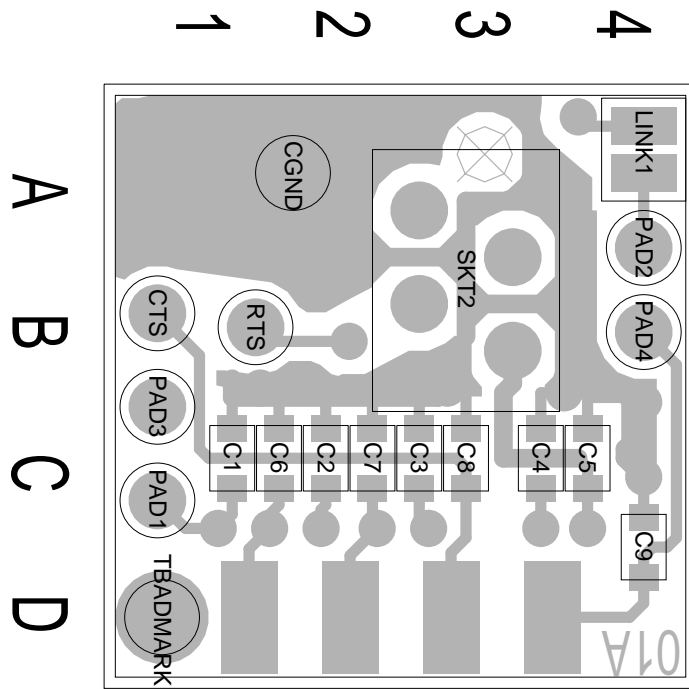

T2000 Data Interface Decoupling PCB (IPN 220-01388-01) - Top Side

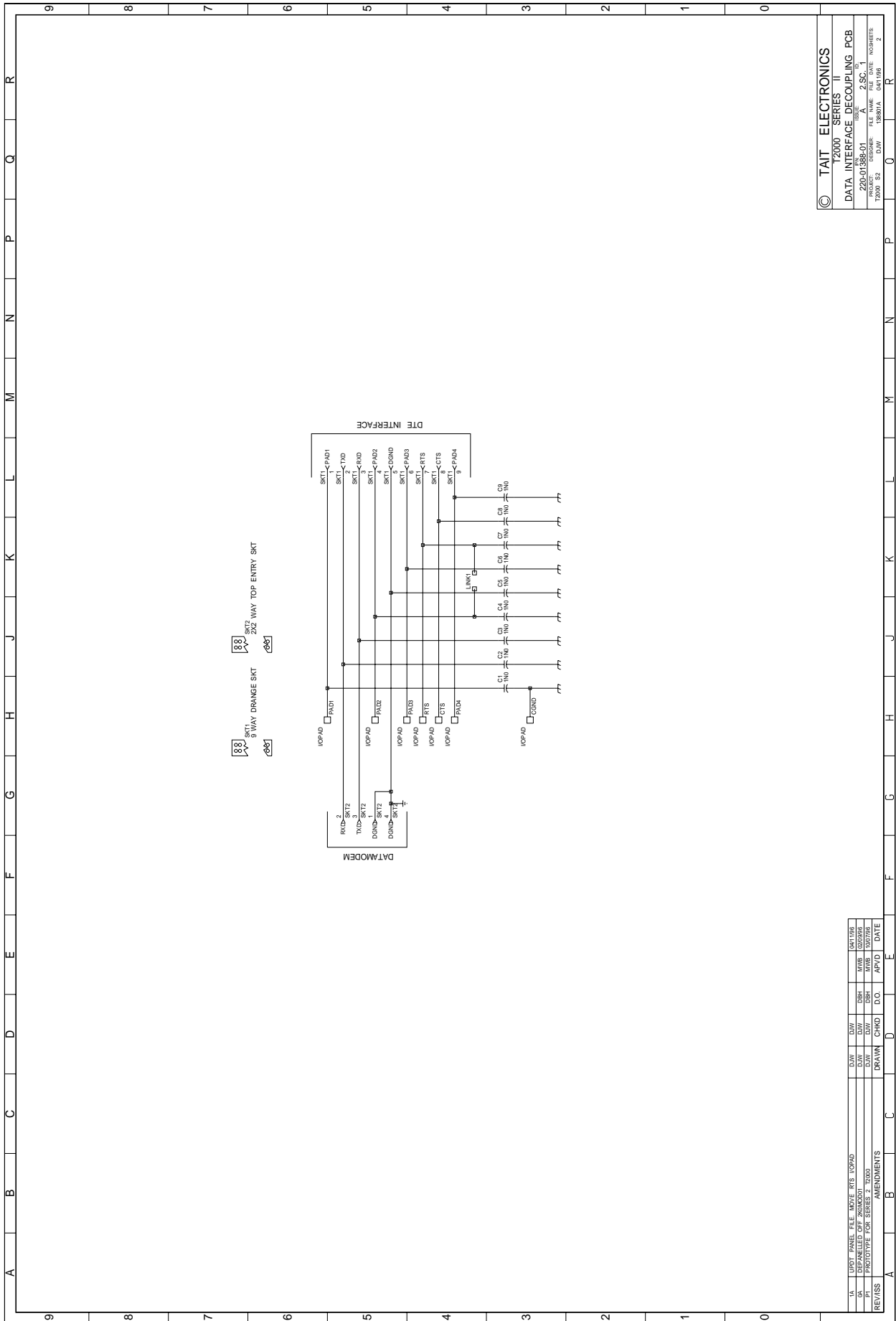

© TAIT ELECTRONICS  
 T2000 SERIES II  
 DATA INTERFACE DECOUPLING PCB  
 220-01388-01  
 REV. DATE 10/96  
 FILE NAME A 2.SC.1  
 DRAWN BY J.W. DATE 10/96  
 CHECKED BY J.W. DATE 10/96  
 DESIGNED BY J.W. DATE 10/96

REV/ISS	DATE	BY	CHKD	DATE	DESCRIPTION
1A	10/96	J.W.	J.W.	10/96	UPROT PANEL FILE. NOTE RTS TO PAD
1B	10/96	J.W.	J.W.	10/96	DEPARALLELED OFF 2W00K001
1C	10/96	J.W.	J.W.	10/96	PROTOTYPE FOR SERIAL AMENDMENTS

