



M. Flom Associates, Inc. - Global Compliance Center
3356 North San Marcos Place, Suite 107, Chandler, Arizona 85224-1571
www.goodnet.com/~mflom, (602) 926-3100, FAX: 926-3598

Sub-part
2.983 (f):

EQUIPMENT IDENTIFICATION

FCC ID: CASTEL0016

NAMEPLATE DRAWING

ATTACHED, EXHIBIT 1.

LOCATION

AS PER LABEL DRAWING(S)

DATE OF REPORT

July 21, 1998

SUPERVISED BY:
MF:glk

MORTON FLOM, P. Eng.

THE APPLICANT HAS BEEN CAUTIONED AS TO THE FOLLOWING:

15.21 INFORMATION TO USER.

The users manual or instruction manual for an intentional radiator shall caution the user that changes or modifications not expressly approved by the party responsible for compliance could void the user's authority to operate the equipment.

15.27(a) SPECIAL ACCESSORIES.

Equipment marketed to a consumer must be capable of complying with the necessary regulations in the configuration in which the equipment is marketed. Where special accessories, such as shielded cables and/or special connectors are required to enable an unintentional or intentional radiator to comply with the emission limits in this part, the equipment must be marketed with, i.e. shipped and sold with, those special accessories. However, in lieu of shipping or packaging the special accessories with the unintentional or intentional radiator, the responsible party may employ other methods of ensuring that the special accessories are provided to the consumer, without additional charge.

Information detailing any alternative method used to supply the special accessories for a grant of equipment authorization or retained in the verification records, as appropriate. The party responsible for the equipment, as detailed in § 2.909 of this chapter, shall ensure that these special accessories are provided with the equipment. The instruction manual for such devices shall include appropriate instructions on the first page of text concerned with the installation of the device that these special accessories must be used with the device. It is the responsibility of the user to use the needed special accessories supplied with the equipment.

TABLE OF CONTENTS

CASTEL0016

| <u>RULE</u> | <u>DESCRIPTION</u> | <u>PAGE</u> |
|-------------------|---|-------------|
| 2.983 | List of General Information Required | 2 |
| EXCITER: | | |
| 2.985(a) | Carrier Output Power | 6 |
| 2.991 | Unwanted Emissions (Transmitter Conducted) | 8 |
| 2.993(a) | Field Strength of Spurious Radiation | 11 |
| 2.989(c) | Occupied Bandwidth | 14 |
| 90.214 | Transient Frequency Behavior | 16 |
| 2.987(a) | Audio Low Pass Filter (Voice Input) | 19 |
| 2.987(a) | Audio Frequency Response | 22 |
| 2.987(b) | Modulation Limiting | 24 |
| 2.995(a) | Frequency Stability (Temperature Variation) | 26 |
| 2.995(d) | Frequency Stability (Voltage Variation) | 29 |
| AMPLIFIER: | | |
| 2.985(a) | Carrier Output Power | 31 |
| 2.991 | Unwanted Emissions (Transmitter Conducted) | 33 |
| 2.993(a) | Field Strength of Spurious Radiation | 36 |
| 2.989(c) | Occupied Bandwidth | 39 |
| 90.214 | Transient Frequency Behavior | 41 |
| 2.987(a) | Audio Low Pass Filter (Voice Input) | 44 |
| 2.987(a) | Audio Frequency Response | 47 |
| 2.987(b) | Modulation Limiting | 49 |
| 2.995(a) | Frequency Stability (Temperature Variation) | 51 |
| 2.995(d) | Frequency Stability (Voltage Variation) | 54 |
| 2.202(g) | Necessary Bandwidth and Emission Bandwidth | 55 |

LIST OF GENERAL INFORMATION REQUIRED FOR TYPE ACCEPTANCE

IN ACCORDANCE WITH FCC RULES AND REGULATIONS,
VOLUME II, PART 2 AND TO

80.207, 90

Sub-part

2.983(a): NAME AND ADDRESS OF APPLICANT:

Tait Electronics Ltd.
558 Wairakei Rd.
Burnside, Christchurch 5, NEW ZEALAND

VENDOR:

Tait Electronics, Ltd.
P.O. Box 1646
Christchurch 1, NEW ZEALAND

2.983(b): FCC ID:

CASTEL0016

MODEL NO: * T867-16-0000 (EXCITER),
** T869-10-0000 (POWER AMPLIFIER)
SERIAL NO. * 996718 and ** 949331

2.983(c): QUANTITY PRODUCTION PLANNED.

2.983(d): TECHNICAL DESCRIPTION:

SEE ATTACHED EXHIBITS

- (1): TYPE OF EMISSION: 16K0F3E, 16K0F3C, 16K0F1D
- (2): FREQUENCY RANGE, MHz: 216 to 220
- (3): POWER RATING, Watts: 20, 100
SWITCHABLE ___ ADJUSTABLE x N/A ___
- (4): MAXIMUM POWER RATING, Watts: 300

2.983(d)

(5):

VOLTAGES & CURRENTS IN ALL ELEMENTS IN FINAL R. F. STAGE, INCLUDING FINAL TRANSISTOR OR SOLID STATE DEVICE:

COLLECTOR CURRENT, A = per manual
COLLECTOR VOLTAGE, Vdc = per manual
SUPPLY VOLTAGE, Vdc = 120

(6):

FUNCTION OF ACTIVE CIRCUIT DEVICES:

PLEASE SEE ATTACHED EXHIBITS

(7):

CIRCUIT DIAGRAM:

PLEASE SEE ATTACHED EXHIBITS

(8):

MANUAL:

PLEASE SEE ATTACHED EXHIBITS

(9):

TUNE-UP PROCEDURE:

PLEASE SEE ATTACHED EXHIBITS

(10):

DESCRIPTION OF CIRCUITRY & DEVICES PROVIDED FOR DETERMINING AND STABILIZING FREQUENCY:

PLEASE SEE ATTACHED EXHIBITS

(11):

DESCRIPTION OF CIRCUITS OR DEVICES EMPLOYED FOR

- (a) SUPPRESSION OF SPURIOUS RADIATION,
- (b) LIMITING MODULATION,
- (c) LIMITING POWER:

PLEASE SEE ATTACHED EXHIBITS

(12):

DIGITAL MODULATION DESCRIPTION:

ATTACHED EXHIBITS
N/A

x

2.983(e): TEST AND MEASUREMENT DATA:

FOLLOWS

2.983(f): LABEL INFORMATION:

PLEASE SEE ATTACHED EXHIBITS

2.983(g): PHOTOGRAPHS:

PLEASE SEE ATTACHED EXHIBITS

Sub-part
2.983(e):

TEST AND MEASUREMENT DATA

All tests and measurement data shown were performed in accordance with FCC Rules and Regulations, Volume II; Part 2, Sub-part J, Sections 2.981, 2.983, 2.985, 2.987, 2.989, 2.991, 2.993, 2.995, 2.997, 2.999 and the following individual Parts:

- ___ 21 - Domestic Public Fixed Radio Services
- ___ 22 - Public Mobile Services
- ___ 22 Subpart H - Cellular Radiotelephone Service
- ___ 22.901(d) - Alternative technologies and auxiliary services
- ___ 23 - International Fixed Public Radiocommunication services
- ___ 24 - Personal Communications Services
- ___ 74 Subpart H - Low Power Auxiliary Stations
- x 80 - Stations in the Maritime Services
- ___ 80 Subpart E - General Technical Standards
- ___ 80 Subpart F - Equipment Authorization for Compulsory Ships
- ___ 80 Subpart K - Private Coast Stations and Marine Utility Stations
- ___ 80 Subpart S - Compulsory Radiotelephone Installations for Small Passenger Boats
- ___ 80 Subpart T - Radiotelephone Installation Required for Vessels on the Great Lakes
- ___ 80 Subpart U - Radiotelephone Installations Required by the Bridge-to-Bridge Act
- ___ 80 Subpart V - Emergency Position Indicating Radiobeacons (EPIRB'S)
- ___ 80 Subpart W - Global Maritime Distress and Safety System (GMDSS)
- ___ 80 Subpart X - Voluntary Radio Installations
- ___ 87 - Aviation Services
- x 90 - Private Land Mobile Radio Services
- ___ 94 - Private Operational-Fixed Microwave Service
- ___ 95 Subpart A - General Mobile Radio Service (GMRS)
- ___ 95 Subpart C - Radio Control (R/C) Radio Service
- ___ 95 Subpart D - Citizens Band (CB) Radio Service
- ___ 95 Subpart E - Family Radio Service
- ___ 95 Subpart F - Interactive Video and Data Service (IVDS)
- ___ 101 - Fixed Microwave Services

STANDARD TEST CONDITIONS
and
ENGINEERING PRACTICES

Except as noted herein, the following conditions and procedures were observed during the testing:

| | |
|---------------------------|----------|
| ROOM TEMPERATURE | = 25±5°C |
| ROOM HUMIDITY | = 20-50% |
| D.C. SUPPLY VOLTAGE, Vdc | = N/A |
| A.C. SUPPLY VOLTAGE, Vac | = 120 |
| A.C. SUPPLY FREQUENCY, Hz | = 60 Hz |

Prior to testing, the EUT was tuned up in accordance with the manufacturer's alignment procedures. All external gain controls were maintained at the position of maximum and/or optimum gain throughout the testing.

Measurement results, unless otherwise noted, are worst case measurements.

PAGE NO.

6.

CASTEL0016

NAME OF TEST:

Carrier Output Power (Conducted)

SPECIFICATION:

FCC: 47 CFR 2.985(a)
IC: RSS-119, Section 6.2

GUIDE:

TIA/EIA-603, Paragraph 2.2.1

TEST CONDITIONS:

Standard Temperature and Humidity (S. T. & H.)

TEST EQUIPMENT:

As per attached page

MEASUREMENT PROCEDURE

1. The EUT was connected to a resistive coaxial attenuator of normal load impedance, and the unmodulated output power was measured by means of an R. F. Power Meter.
2. Measurement accuracy is $\pm 3\%$.

MEASUREMENT RESULTS

| <u>NOMINAL, MHz</u> | <u>R.F. POWER OUTPUT, WATTS</u> | |
|---------------------|---------------------------------|-----|
| EXCITER: | | |
| 217.5 | 0.5 | 100 |

SUPERVISED BY:

MORTON FLOM, P. Eng.

TRANSMITTER POWER CONDUCTED MEASUREMENTS

TEST 1: R. F. POWER OUTPUT
 TEST 2: FREQUENCY STABILITY

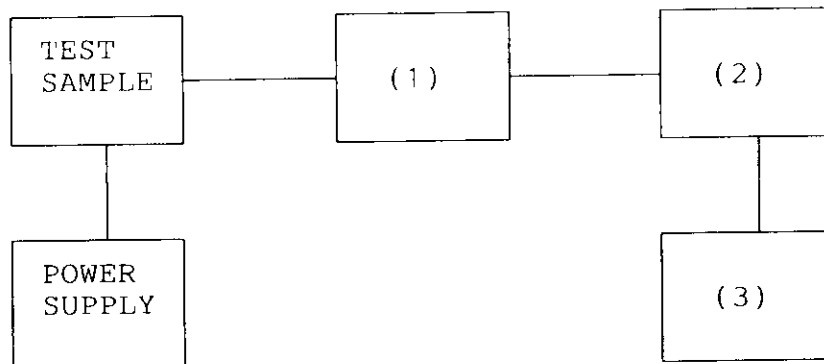
(1) COAXIAL ATTENUATOR

NARDA 766-10
 SIERRA 661A-30
 BIRD 8329 (30 dB)

 x

(2) POWER METERS

HP 435A
 HP 436A
 HP 8901A POWER MODE

 x
 x

(3) FREQUENCY COUNTER

HP 5383A
 HP 5334B
 HP 8901A FREQUENCY MODE

 x
 x

PAGE NO.

8.

CASTEL0016

NAME OF TEST:

Unwanted Emissions (Transmitter Conducted)

SPECIFICATION:

FCC: 47 CFR 2.991
IC: RSS-119, Section 6.3

GUIDE:

TIA/EIA-603, Paragraph 2.2.13

TEST CONDITIONS:

S. T. & H.

TEST EQUIPMENT:

As per attached page

MEASUREMENT PROCEDURE

1. The emissions were measured for the worst case as follows:
 - (a): within a band of frequencies defined by the carrier frequency plus and minus one channel.
 - (b): from the lowest frequency generated in the EUT and to at least the 10th harmonic of the carrier frequency, or 40 GHz, whichever is lower.
2. The magnitude of spurious emissions which are attenuated more than 20 dB below the permissible value need not be specified.
3. MEASUREMENT RESULTS: ATTACHED FOR WORST CASE

FREQUENCY OF CARRIER, MHz = 217.5
SPECTRUM SEARCHED, GHz = 0 to $10 \times F_C$
MAXIMUM RESPONSE, Hz = 2820
ALL OTHER EMISSIONS = ≥ 20 dB BELOW LIMIT
LIMIT, dBc: $-(43 + 10 \text{ LOG } P_0)$ = -56 (20 Watts)
-40 (0.5 Watts)



SUPERVISED BY:

MORTON FLOM, P. Eng.

TRANSMITTER SPURIOUS EMISSION

TEST A. OCCUPIED BANDWIDTH (IN-BAND SPURIOUS)
 TEST B. OUT-OF-BAND SPURIOUS

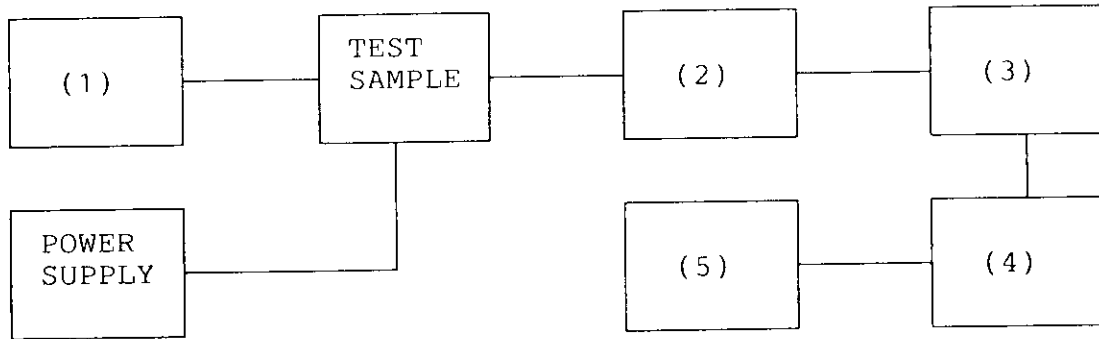

- (1) AUDIO OSCILLATOR/GENERATOR
 - HP 204D _____
 - HP 8903A _____
 - HP 3312A x
 - _____ x

- (2) COAXIAL ATTENUATOR
 - NARDA 766-10 _____
 - SIERRA 661A-30 x
 - BIRD 8329 (30 dB) x
 - _____ _____

- (3) FILTERS; NOTCH, HP, LP, BP
 - CIRQTEL FHT _____
 - EAGLE TNF-1 x
 - PHELPS DODGE PD-495-8 _____
 - _____ _____

- (4) SPECTRUM ANALYZER
 - HP 8566B x
 - HP 8563E _____
 - _____ _____

- (5) SCOPE
 - HP 1741A _____
 - HP 181T _____
 - TEK 935 _____
 - HP 54502A _____
 - _____ _____

PAGE NO.

10.1.

CASTEL0016

G86J004

TRANSMITTER SPURIOUS EMISSIONS (CONDUCTED) (EXCITER)

POWER: LOW

| FREQUENCY TUNED, MHz | FREQUENCY EMISSION, MHz | LEVEL, dBm | LEVEL, dBc | LEVEL, μ W |
|-------------------------|----------------------------|---------------|---------------|-------------------|
| 217.500 | 435.340 | -31.3 | -74.3 | 1 |
| 217.500 | 652.511 | -25.4 | -68.4 | 3 |
| 217.500 | 869.992 | -29.3 | -72.3 | 1 |
| 217.500 | 1087.730 | -31.9 | -74.9 | 1 |
| 217.500 | 1304.988 | -31.7 | -74.7 | 1 |
| 217.500 | 1522.912 | -31.2 | -74.2 | 1 |
| 217.500 | 1739.703 | -31.5 | -74.5 | 1 |
| 217.500 | 1957.259 | -30.0 | -73.0 | 1 |
| 217.500 | 2174.670 | -30.8 | -73.8 | 1 |
| 217.500 | 2392.562 | -29.8 | -72.8 | 1 |
| 217.500 | 2609.554 | -33.2 | -76.2 | 0 |
| 217.500 | 2827.334 | -32.5 | -75.5 | 1 |
| 217.500 | 3045.169 | -32.7 | -75.7 | 1 |
| 217.500 | 3262.541 | -33.5 | -76.5 | 0 |

PAGE NO.

10.2.

CASTEL0016

G86J005

TRANSMITTER SPURIOUS EMISSIONS (CONDUCTED) (EXCITER)

POWER: MEDIUM

| FREQUENCY TUNED, MHz | FREQUENCY EMISSION, MHz | LEVEL, dBm | LEVEL, dBc | LEVEL, μ W |
|-------------------------|----------------------------|---------------|---------------|-------------------|
| 217.500 | 434.997 | -11.6 | -61.6 | 69 |
| 217.500 | 652.508 | -27.9 | -77.9 | 2 |
| 217.500 | 869.994 | -31.2 | -81.2 | 1 |
| 217.500 | 1087.496 | -32.1 | -82.1 | 1 |
| 217.500 | 1304.608 | -31.7 | -81.7 | 1 |
| 217.500 | 1522.140 | -31.5 | -81.5 | 1 |
| 217.500 | 1740.202 | -31.3 | -81.3 | 1 |
| 217.500 | 1957.452 | -31.4 | -81.4 | 1 |
| 217.500 | 2174.735 | -30.2 | -80.2 | 1 |
| 217.500 | 2392.907 | -30.7 | -80.7 | 1 |
| 217.500 | 2610.088 | -32.4 | -82.4 | 1 |
| 217.500 | 2827.743 | -32.2 | -82.2 | 1 |
| 217.500 | 3045.280 | -32.5 | -82.5 | 1 |
| 217.500 | 3262.409 | -33.4 | -83.4 | 0 |

PAGE NO.

11.1.

CASTEL0016

NAME OF TEST:

Field Strength of Spurious Radiation

SPECIFICATION:

FCC: 47 CFR 2.993(a)

IC: N/A

GUIDE:

TIA/EIA-603, Section 2.2.12

TEST CONDITIONS:

S. T. & H.

TEST EQUIPMENT:

AS PER ATTACHED PAGE

MEASUREMENT PROCEDURE

1. A description of the measurement facilities was filed with the FCC and was found to be in compliance with the requirements of Section 15.38, by letter from the FCC dated March 3, 1997, FILE 31040/SIT. All pertinent changes will be reported to the Commission by up-date prior to March 2000.

2. At first, in order to locate all spurious frequencies and approximate amplitudes, and to determine proper equipment functioning, the test sample was set up at a distance of three meters from the test instrument. Valid spurious signals were determined by switching the power on and off.

3. In the field, the test sample was placed on a wooden turntable above ground at three (or thirty) meters away from the search antenna. The test sample was connected to an R.F. Wattmeter and a 50 ohm dummy load, and adjusted to its rated output.

In order to obtain the maximum response at each spurious frequency, the turntable was rotated. Also, the Search Antennas were raised and lowered vertically, and all cables were oriented. Excess power lead was coiled near the power supply.

4. A signal generator, connected with a non-radiating cable to a vertically polarized half-wave antenna (for each frequency involved) was substituted for the transmitter. The Search Antenna was raised and lowered to obtain maximum indicated.

5. The signal generator output was adjusted until a signal level indication equal to that from the transmitter was obtained.

6. Steps 4 and 5 were repeated, using a horizontally polarized half-wave antenna. The higher of the two observations was noted.

PAGE NO.

11.2.

CASTEL0016

NAME OF TEST:

Field Strength of Spurious Radiation

SPECIFICATION:

FCC: 47 CFR 2.993(a)
IC: N/A

MEASUREMENT PROCEDURE (CONT.)

7. Power into the half-wave antenna was calculated from the characteristic impedance of the line, and the voltage output from the signal generator.

8. The level of each spurious radiation with reference to the transmitter power in dB, was calculated from:

$$\text{SPURIOUS LEVEL, dB} = 10 \text{ LOG} \left(\frac{\text{Calculated Spurious Power}}{\text{Tx Power (Wattmeter)}} \right) \quad \text{[from para. 7].}$$

9. The worst case for all channels is shown.

10. Measurement summary:

| | |
|---------------------------|-------------------------------------|
| FREQUENCY OF CARRIER, MHz | = 217.5 |
| SPECTRUM SEARCHED, GHz | = 0 to $10 \times F_C$ |
| ALL OTHER EMISSIONS | = ≥ 20 dB BELOW LIMIT |
| LIMIT, dBc | = -56 (20 Watts) -40 (0.5 Watts) |

11. Measurement results:

ATTACHED FOR WORST CASE

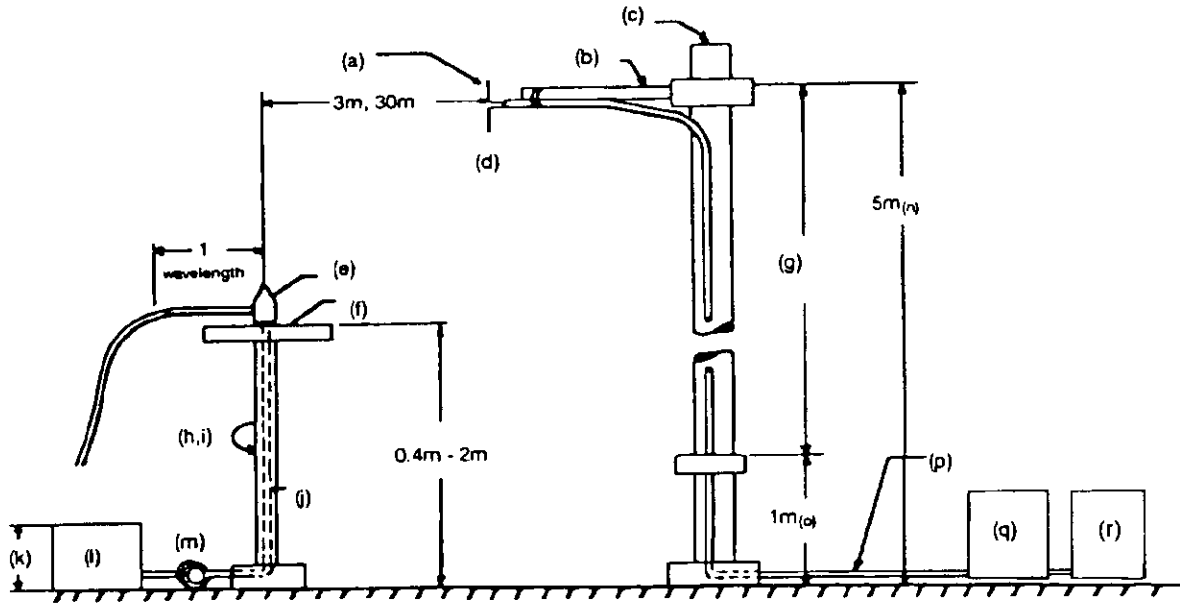
RADIATED TEST SETUP

NOTES:

- (a) Search Antenna - Rotatable on boom.
- (b) Non-metallic boom.
- (c) Non-metallic mast.
- (d) Adjustable horizontally.
- (e) Equipment Under Test.
- (f) Turntable.
- (g) Boom adjustable in height.
- (h) External control cables routed horizontally at least one wavelength.
- (i) Rotatable.
- (j) Cables routed through hollow turntable center.
- (k) 30 cm or less.
- (l) External power source.
- (m) 10 cm diameter coil of excess cable.
- (n) 25 cm (V), 1 m-7 m (V, H).
- (o) 25 cm from bottom end of 'V', 1 m normally.
- (p) Calibrated Cable at least 10 m in length.
- (q) Amplifier (optional).
- (r) Spectrum Analyzer.

TRANSMITTER SPURIOUS EMISSIONS (RADIATED FIELD STRENGTH)

ALL OTHER EMISSIONS = ≥ 20 dB BELOW LIMIT

| EMISSION, MHz/HARMONIC | SPURIOUS LEVEL BELOW | |
|---------------------------|----------------------|----|
| | Lo | Hi |
| | CARRIER, dBc | |

EXCITER:

| | | |
|-------------|------|------|
| 2nd to 10th | <-65 | <-60 |
|-------------|------|------|

SUPERVISED BY:

M. Flom P. Eng.
MORTON FLOM, P. Eng.

PAGE NO.

14.

CASTEL0016

NAME OF TEST:

Emission Masks (Occupied Bandwidth)

SPECIFICATION:

FCC: 47 CFR 2.989(c)(1)
IC: RSS-119, Section 6.4

GUIDE:

TIA/EIA-603, Paragraph 2.2.11

TEST CONDITIONS:

S. T. & H.

TEST EQUIPMENT:

As per previous page

MEASUREMENT PROCEDURE

1. The EUT and test equipment were set up as shown on the following page, with the Spectrum Analyzer connected.
2. For EUTs supporting audio modulation, the audio signal generator was adjusted to the frequency of maximum response and with output level set for ± 2.5 kHz deviation (or 50% modulation). With level constant, the signal level was increased 16 dB.
3. For EUTs supporting digital modulation, the digital modulation mode was operated to its maximum extent.
4. The Occupied Bandwidth was measured with the Spectrum Analyzer controls set as shown on the test results.
5. MEASUREMENT RESULTS: ATTACHED

SPECTRUM ANALYZER PRESENTATION
TAIT ELECTRONICS, T867-16-0000 (EXCITER)
1998-JUL-17, 08:15, FRI

POWER: HIGH
MODULATION: NONE

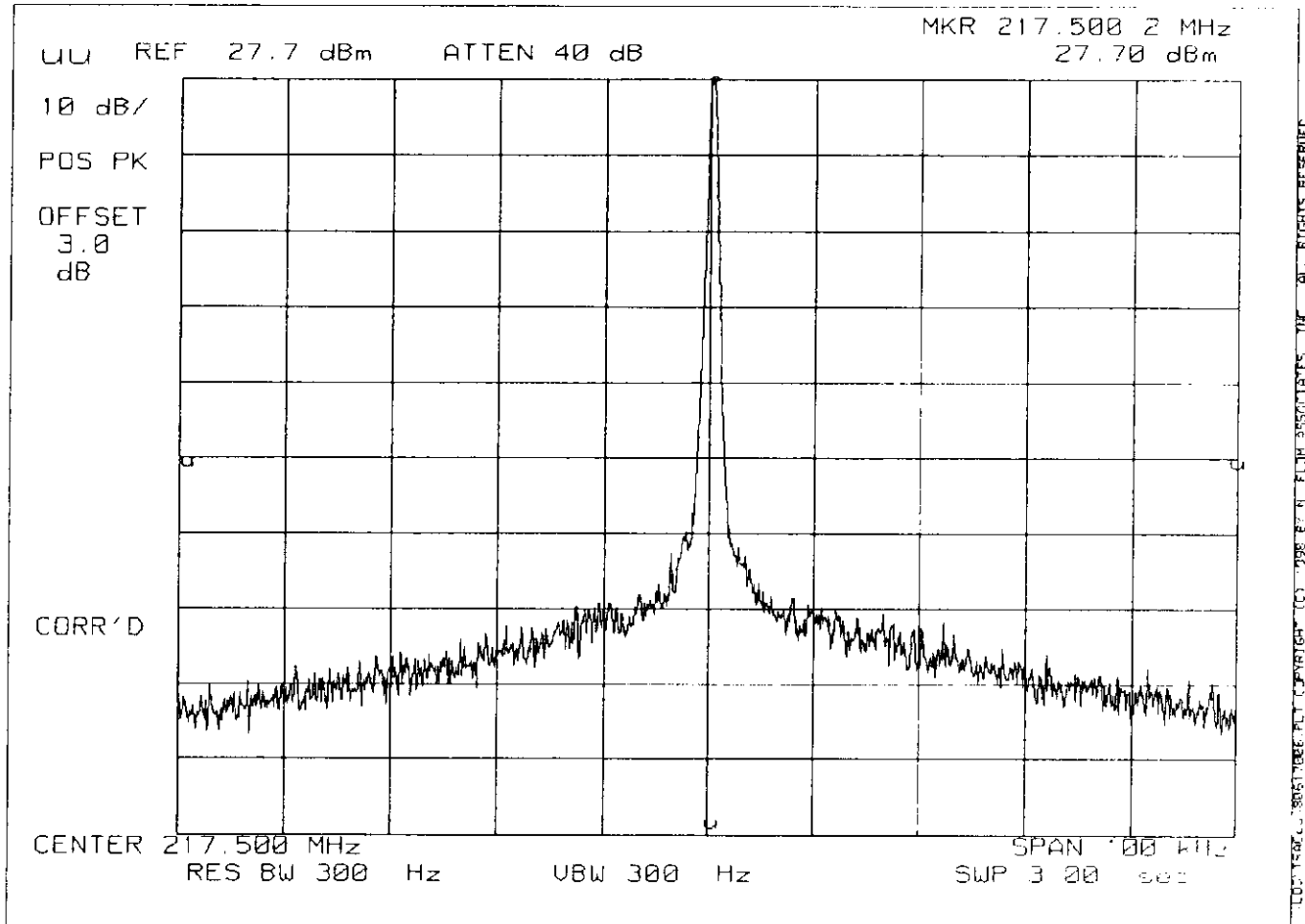

SPECTRUM ANALYZER PRESENTATION
TAIT ELECTRONICS, T867-16-0000 (EXCITER)
1998-JUL-17, 08:17, FRI

POWER: HIGH
MODULATION: VOICE: 2500 Hz SINE WAVE
MASK: B, VHF/UHF 25kHz, w/LPF

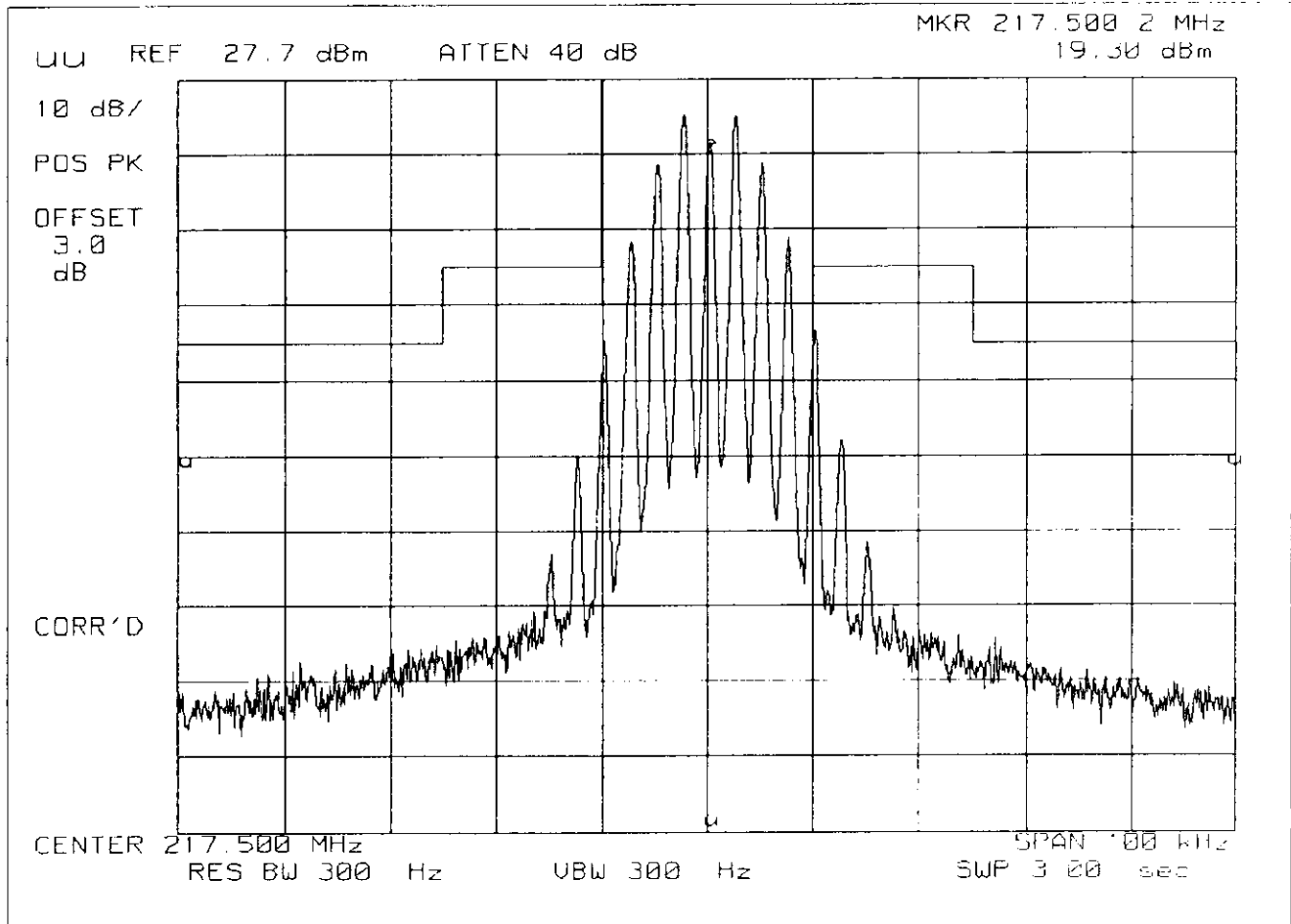

SPECTRUM ANALYZER PRESENTATION
TAIT ELECTRONICS, T867-16-0000 (EXCITER)
1998-JUL-17, 08:21, FRI

POWER: HIGH
MODULATION: VOICE: 2500 Hz SINE WAVE
MASK: D, VHF/UHF 12.5kHz BW

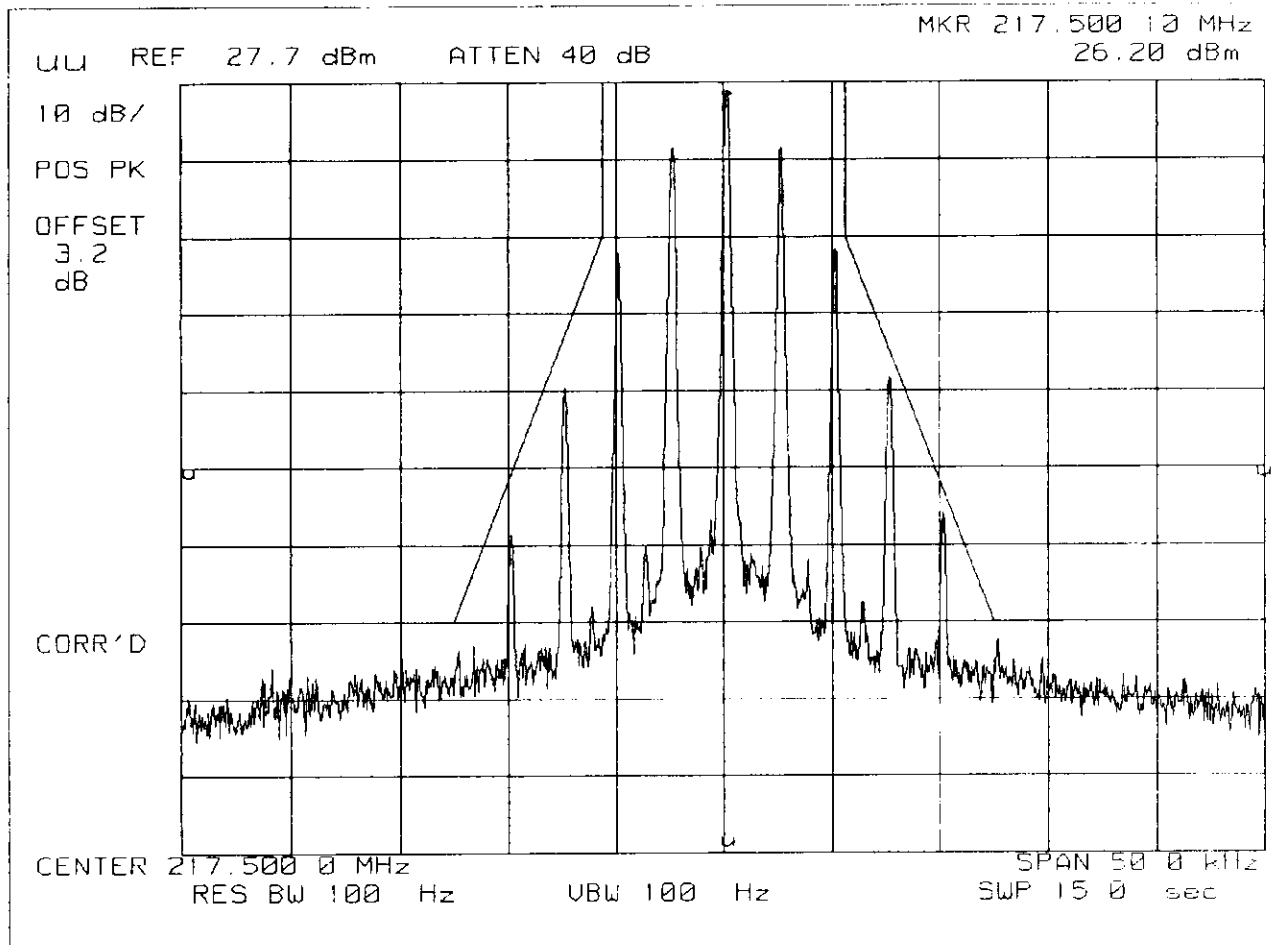

ALL RIGHTS RESERVED

PAGE NO.

16.

CASTEL0016

NAME OF TEST:

Transient Frequency Behavior

SPECIFICATION:

FCC: 47 CFR 90.214
IC: RSS-119, Section 6.5

GUIDE:

TIA/EIA-603, Paragraph 2.2.19

TEST CONDITIONS:

S. T. & H.

TEST EQUIPMENT:

As per attached page

MEASUREMENT PROCEDURE

1. The EUT was setup as shown on the attached page, following TIA/EIA-603 steps a, b, and c as a *guide*.

2. The transmitter was turned on.

3. Sufficient attenuation was provided so that the transmitter carrier level measured at the output of the combiner was 40 dB below the maximum input level of the test receiver. This level was recorded as step f.

4. The transmitter was turned off.

5. An RF signal generator (1) modulated with a 1 kHz tone at either 25, 12.5, or 6.25 kHz deviation, and set to the same frequency as the assigned transmitter frequency, (2) was adjusted to a level -20 dB below the level recorded for step f, as measured at the output of the combiner. This level was then fixed for the remainder of the test and is recorded at step h.

6. The oscilloscope was setup using TIA/EIA-603 steps j and k as a guide, and to either 10 ms/div (UHF) or 5 ms/div (VHF).

7. The 30 dB attenuator was removed, the transmitter was turned on, and the level of the carrier at the output of the combiner was recorded as step l.

8. The carrier on-time as referenced in TIA/EIA-603 steps m, n, and o was captured and plotted. The carrier off-time as referenced in TIA/EIA-603 steps p, q, r, and s was captured and plotted.

LEVELS MEASURED:

EXCITER

step f, dBm = -11.5

step h, dBm = -32.7

step l, dBm = 18.2

SUPERVISED BY:

MORTON FLOM, P. Eng.

TRANSIENT FREQUENCY BEHAVIOR

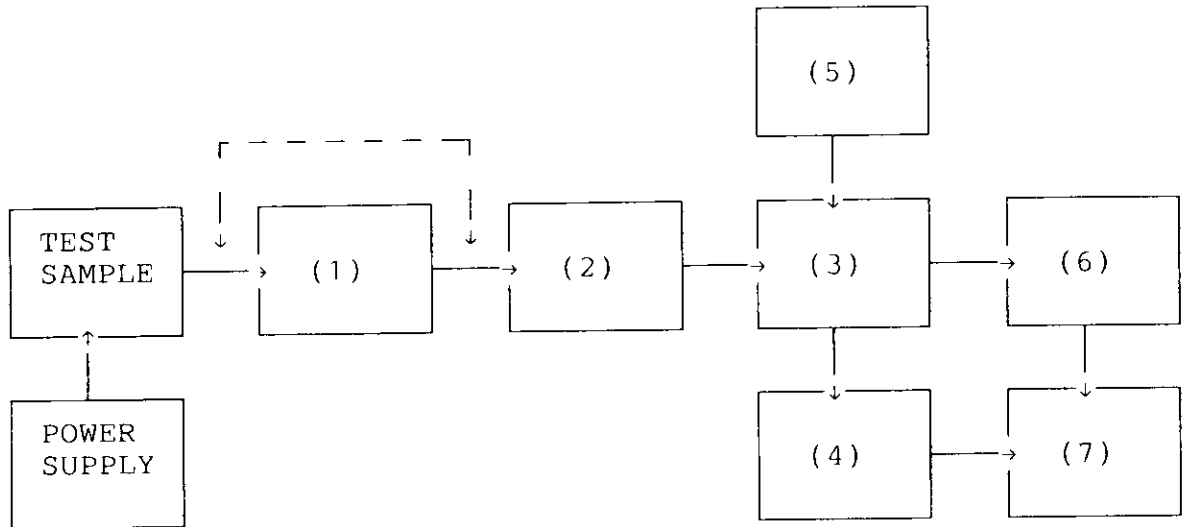

- (1) ATTENUATOR
 (NOTE: Removed after 1st step)
 30 dB x

- (2) ATTENUATOR
 30 dB
 20 dB x
 10 dB
 KAY VARIABLE

- (3) COMBINER
 4 x 25 Ω COMBINER x

- (4) CRYSTAL DETECTOR
 HP 8470B x

- (5) RF SIGNAL GENERATOR
 HP 8656A
 HP 8920A x

- (6) MODULATION ANALYZER
 HP 8901A x

- (7) SCOPE
 HP 54502A x

OSCILLOSCOPE PRESENTATION
TAIT ELECTRONICS, T867-16-0000 (EXCITER)
1998-JUL-16, 16:06, THR

MODULATION: Ref Gen=12.5 kHz Deviation
REMARK: CARRIER ON TIME

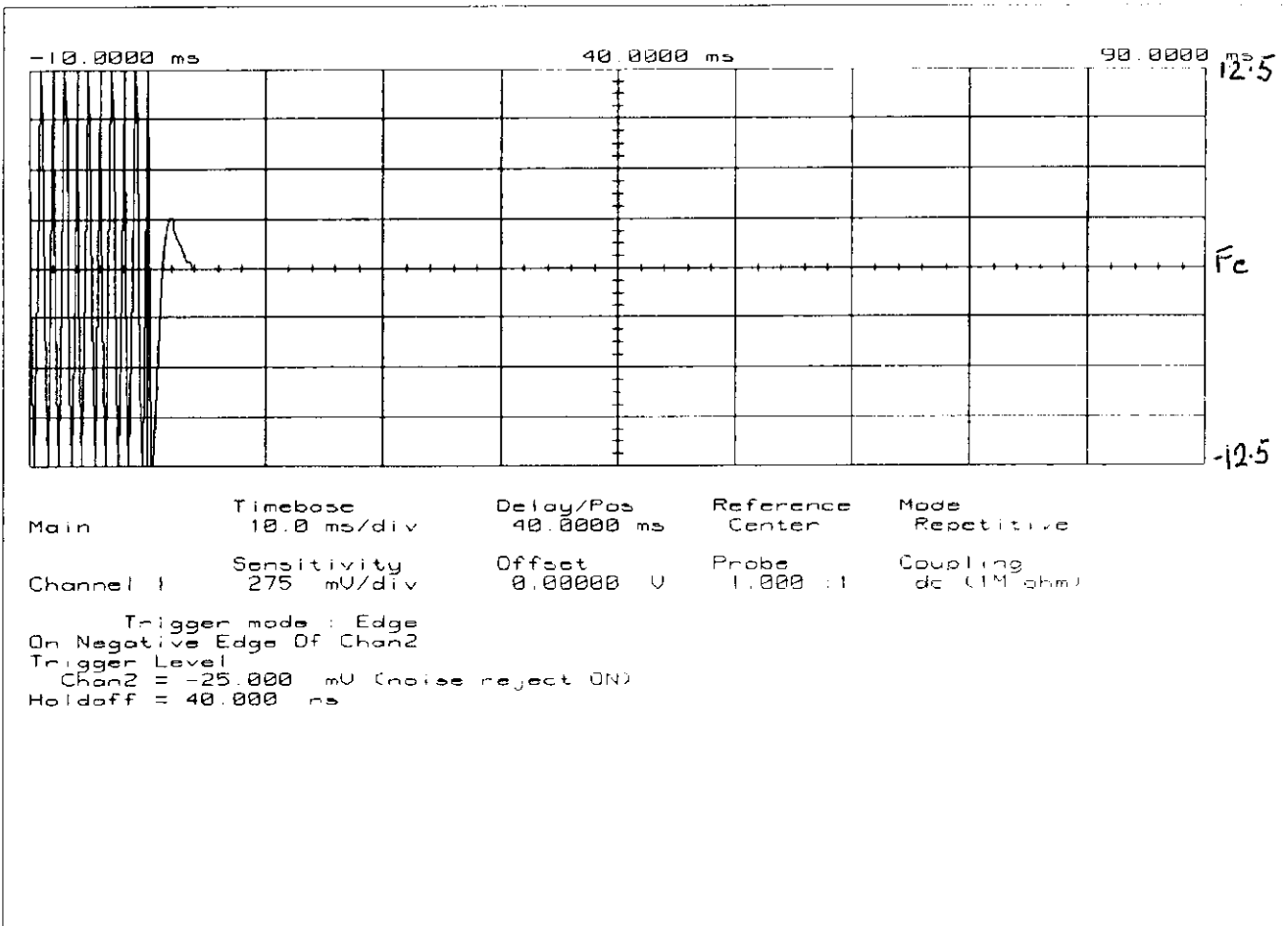

OSCILLOSCOPE PRESENTATION
TAIT ELECTRONICS, T867-16-0000 (EXCITER)
1998-JUL-16, 16:08, THR

MODULATION: Ref Gen=12.5 kHz Deviation
REMARK: CARRIER OFF TIME

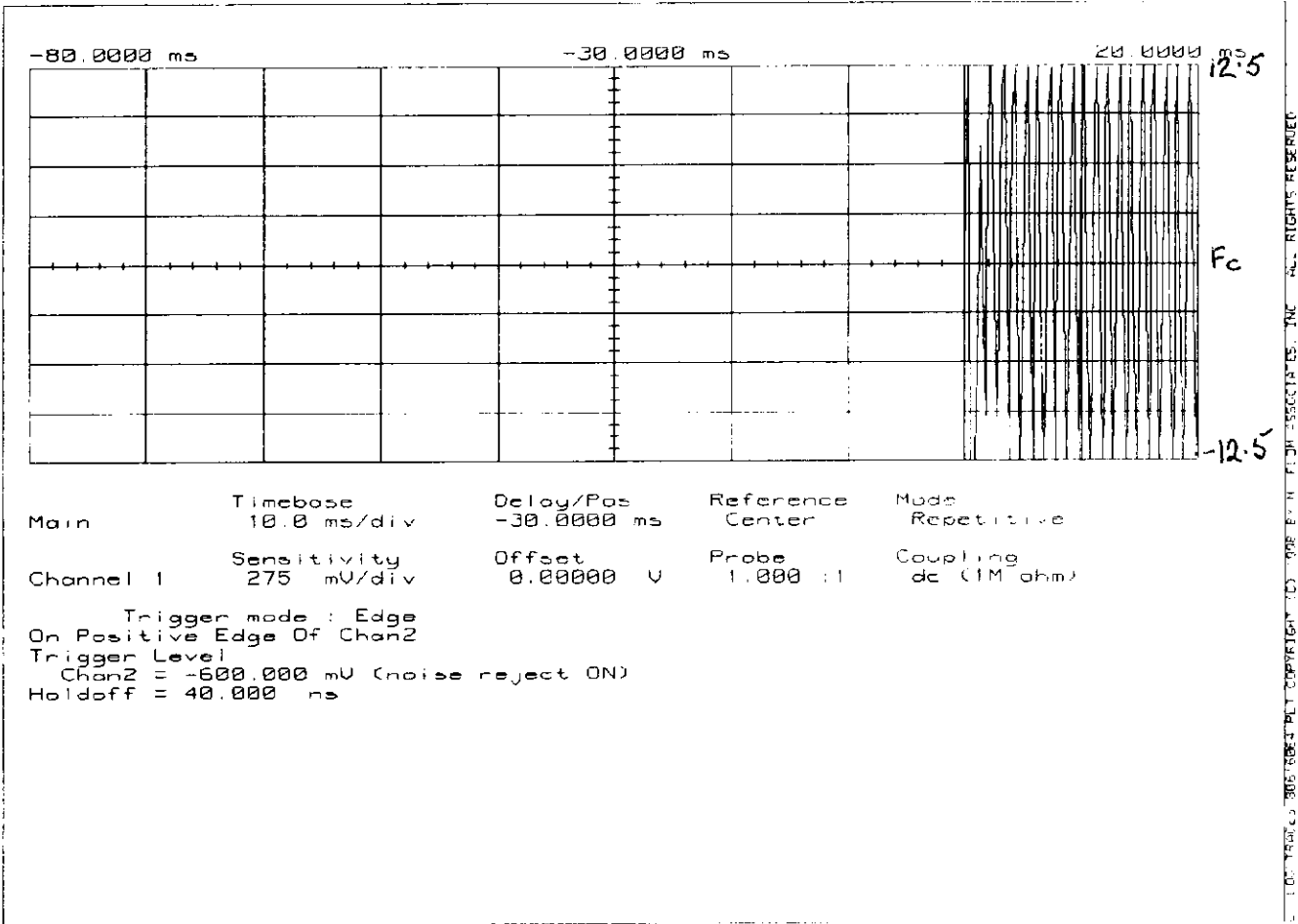

OSCILLOSCOPE PRESENTATION
TAIT ELECTRONICS, T867-16-0000 (EXCITER)
1998-JUL-16, 16:12, THR

MODULATION: Ref Gen=25 kHz Deviation
REMARK: CARRIER ON TIME

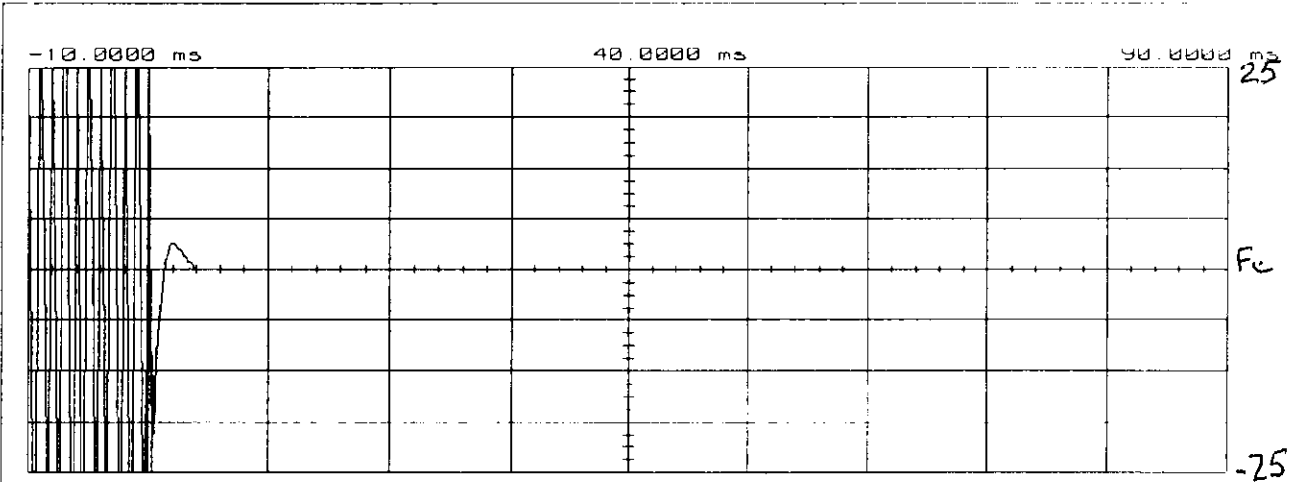

| | | | | |
|-----------|---------------------------|-------------------------|---------------------|-------------------------|
| Main | Timebase 10.0 ms/div | Delay/Pos 40.0000 ms | Reference Center | Mode Repetitive |
| Channel 1 | Sensitivity 275 mV/div | Offset 0.00000 V | Probe 1.000 :1 | Coupling dc (1M ohm) |

Trigger mode : Edge
 On Negative Edge Of Chan2
 Trigger Level
 Chan2 = -37.500 mV (noise reject ON)
 Holdoff = 40.000 ns

C:\TDI\T867-16-0000\T867-16-0000.FLT COPY FROM T867-16-0000 BY H. FLORES ASSOCIATES, INC. ALL RIGHTS RESERVED

OSCILLOSCOPE PRESENTATION
TAIT ELECTRONICS, T867-16-0000 (EXCITER)
1998-JUL-16, 16:13, THR

MODULATION: Ref Gen=25 kHz Deviation
REMARK: CARRIER OFF TIME

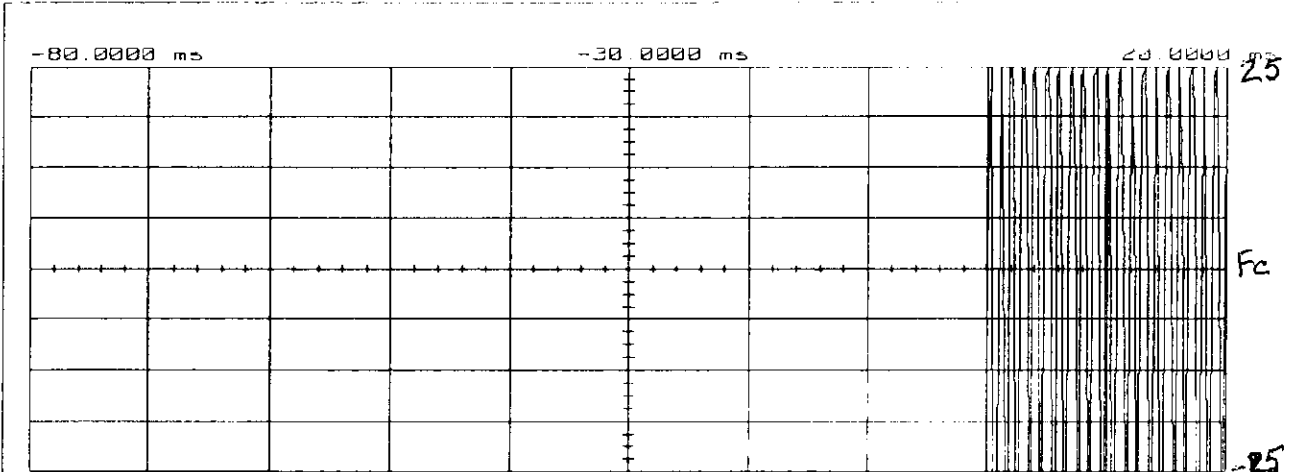

| | | | | |
|-----------|---------------------------|--------------------------|---------------------|-------------------------|
| Main | Timebase 10.0 ms/div | Delay/Pos -30.0000 ms | Reference Center | Mode Repetitive |
| Channel 1 | Sensitivity 275 mV/div | Offset 0.00000 V | Probe 1.000 :1 | Coupling dc (1M ohm) |

Trigger mode : Edge
 On Positive Edge Of Chan2
 Trigger Level
 Chan2 = -600.000 mV (noise reject ON)
 Holdoff = 40.000 ns

COURTESY OF TAIT ELECTRONICS, INC. ALL RIGHTS RESERVED

PAGE NO.

19.

CASTEL0016

NAME OF TEST:

Audio Low Pass Filter (Voice Input)

SPECIFICATION:

FCC: 47 CFR 2.987(a)
IC: RSS-119, Section 6.6

GUIDE:

TIA/EIA-603, Paragraph 2.2.15

TEST CONDITIONS:

S. T. & H.

TEST EQUIPMENT:

As per attached page

MEASUREMENT PROCEDURE

1. The EUT and test equipment were set up such that the audio input was connected at the input to the modulation limiter, and the modulated stage.
2. The audio output was connected at the output to the modulated stage.
3. MEASUREMENT RESULTS: ATTACHED

TRANSMITTER TEST SET-UP

- TEST A. MODULATION CAPABILITY/DISTORTION
- TEST B. AUDIO FREQUENCY RESPONSE
- TEST C. HUM AND NOISE LEVEL
- TEST D. RESPONSE OF LOW PASS FILTER
- TEST E. MODULATION LIMITING

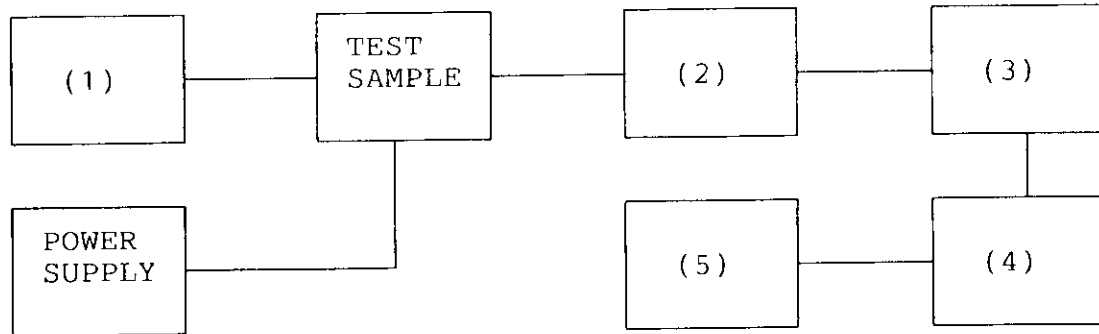

(1) AUDIO OSCILLATOR/GENERATOR

| | |
|----------|----------|
| HP 204D | --- |
| HP 8903A | --- |
| HP 3312A | <u>x</u> |
| _____ | <u>x</u> |

(2) COAXIAL ATTENUATOR

| | |
|-------------------|----------|
| NARDA 766-10 | --- |
| SIERRA 661A-30 | <u>x</u> |
| BIRD 8329 (30 dB) | --- |
| _____ | --- |

(3) MODULATION ANALYZER

| | |
|----------|----------|
| HP 8901A | <u>x</u> |
| _____ | --- |

(4) AUDIO ANALYZER

| | |
|----------|----------|
| HP 8903A | <u>x</u> |
| _____ | --- |

(5) SCOPE

| | |
|----------|-----|
| HP 1741A | --- |
| HP 181T | --- |
| TEK 935 | --- |
| _____ | --- |

FREQUENCY RESPONSE OF AUDIO LOW PASS FILTER
TAIT ELECTRONICS, T867-16-0000 (EXCITER)
17 JUL 1998, 08:39

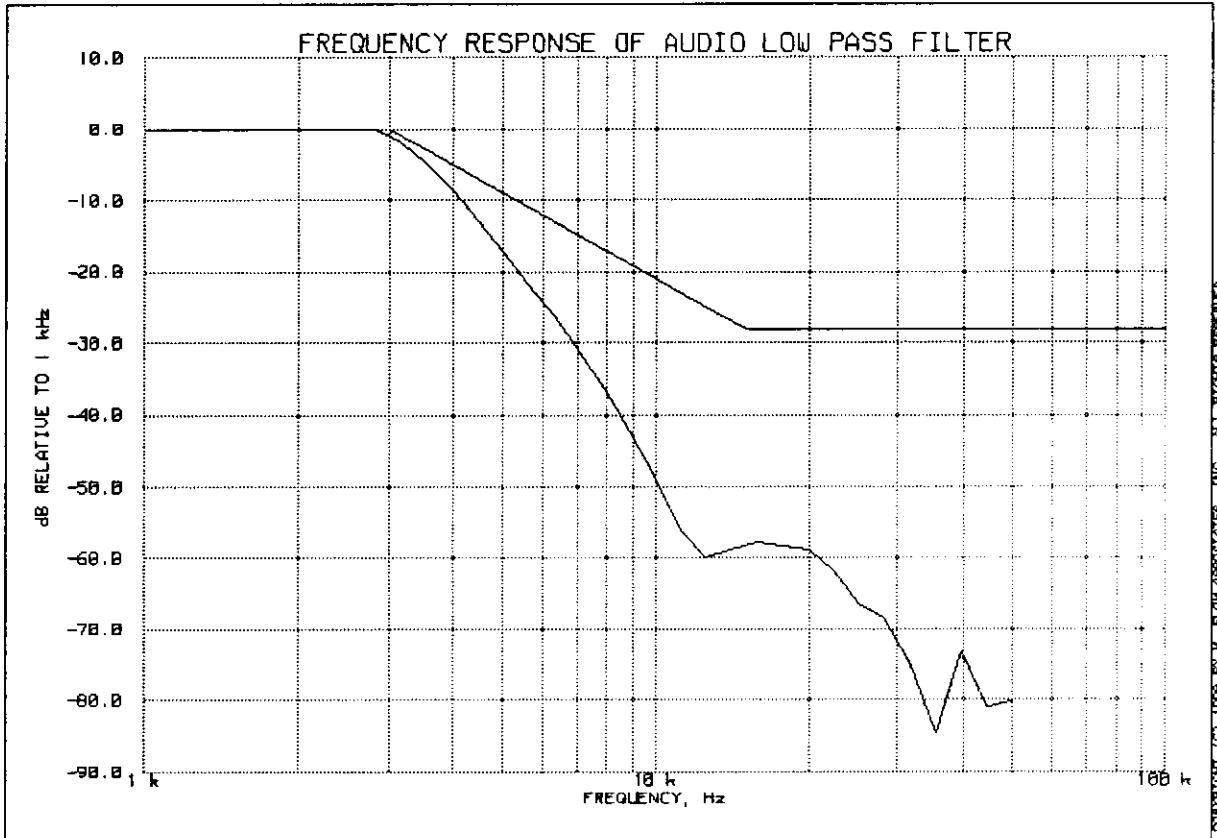

COPYRIGHT (C) 1998 BY M. FLOM ASSOCIATES, INC. ALL RIGHTS RESERVED.

PEAK AUDIO FREQUENCY, Hz: 2820

SUPERVISED BY:

MORTON FLOM, P. Eng.

PAGE NO.

22.

CASTEL0016

NAME OF TEST:

Audio Frequency Response

SPECIFICATION:

FCC: 47 CFR 2.987(a)
IC: N/A

GUIDE:

TIA/EIA-603, Section 2.2.6

TEST CONDITIONS:

S. T. & H.

TEST EQUIPMENT:

As per previous page

MEASUREMENT PROCEDURE

1. The EUT and test equipment were set up as shown on the following page.
2. The audio signal generator was connected to the audio input circuit/microphone of the EUT.
3. The audio signal input was adjusted to obtain 20% modulation at 1 kHz, and this point was taken as the 0 dB reference level.
4. With input levels held constant and below limiting at all frequencies, the audio signal generator was varied from 100 Hz to 50 kHz.
5. The response in dB relative to 1 kHz was then measured, using the HP 8901A Modulation Analyzer.
6. MEASUREMENT RESULTS: ATTACHED

TRANSMITTER AUDIO FREQUENCY RESPONSE
 TAIT ELECTRONICS, T867-16-0000 (EXCITER)
 17 JUL 1998, 08:36

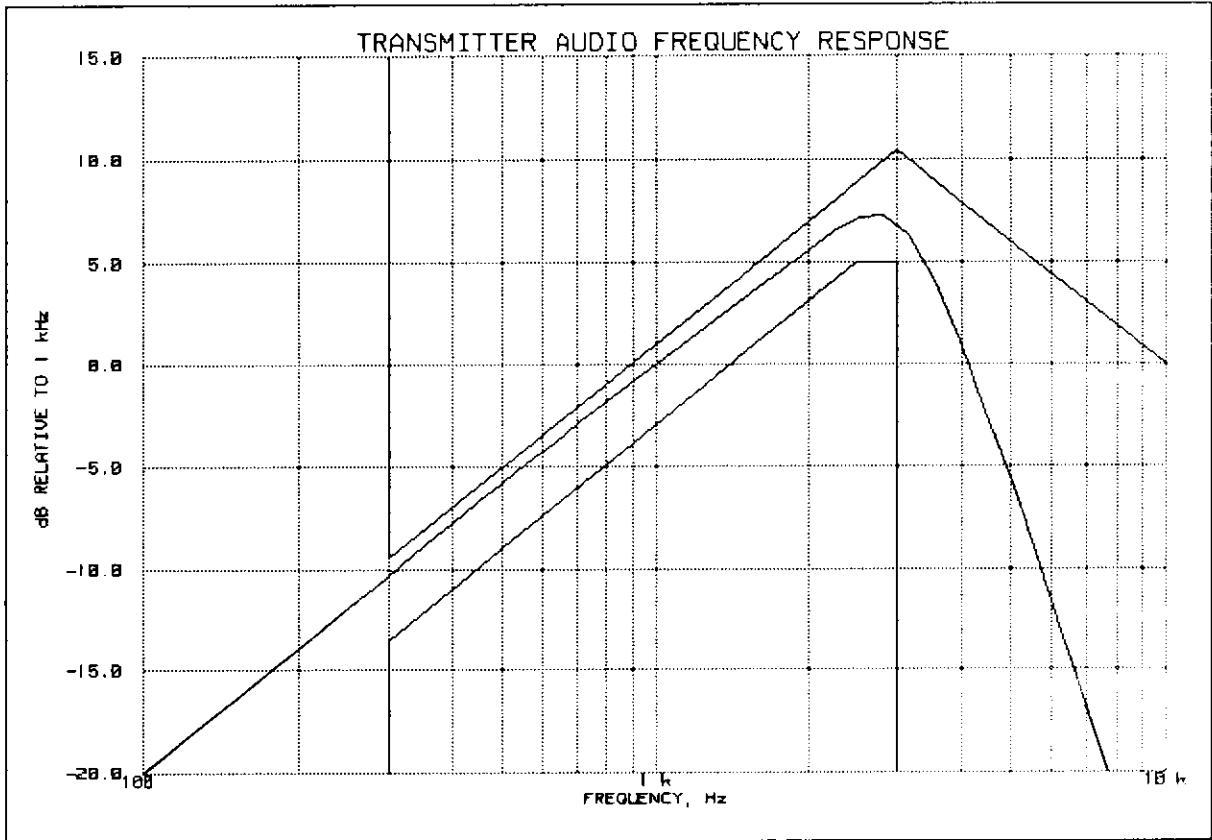

PEAK AUDIO FREQUENCY, Hz: 2820

TABLE VALUES:

| FREQUENCY, Hz | LEVEL, dB | FREQUENCY, Hz | LEVEL, dB | FREQUENCY, Hz | LEVEL, dB |
|---------------|-----------|---------------|-----------|---------------|-----------|
| 300 | -10.3 | 30000 | -24.8 | | |
| 20000 | -24.8 | 50000 | -24.8 | | |

Morton Flom P. Eng.

SUPERVISED BY:

MORTON FLOM, P. Eng.

PAGE NO.

24.

CASTEL0016

NAME OF TEST:

Modulation Limiting

SPECIFICATION:

IC: RSS-119, Section 6.6
FCC: 47 CFR 2.987(b)

GUIDE:

TIA/EIA-603, Paragraph 2.2.3

TEST CONDITIONS:

S. T. & H.

TEST EQUIPMENT:

As per attached page

MEASUREMENT PROCEDURE

1. The signal generator was connected to the input of the EUT as for "Frequency Response of the Modulating Circuit."
2. The modulation response was measured for each of three frequencies (one of which was the frequency of maximum response), and the input voltage was varied and was observed on an HP 8901A Modulation Analyzer.
3. The input level was varied from 30% modulation (± 1.5 kHz deviation) to at least 20 dB higher than the saturation point.
4. Measurements were performed for both negative and positive modulation and the respective results were recorded.
5. MEASUREMENT RESULTS: ATTACHED

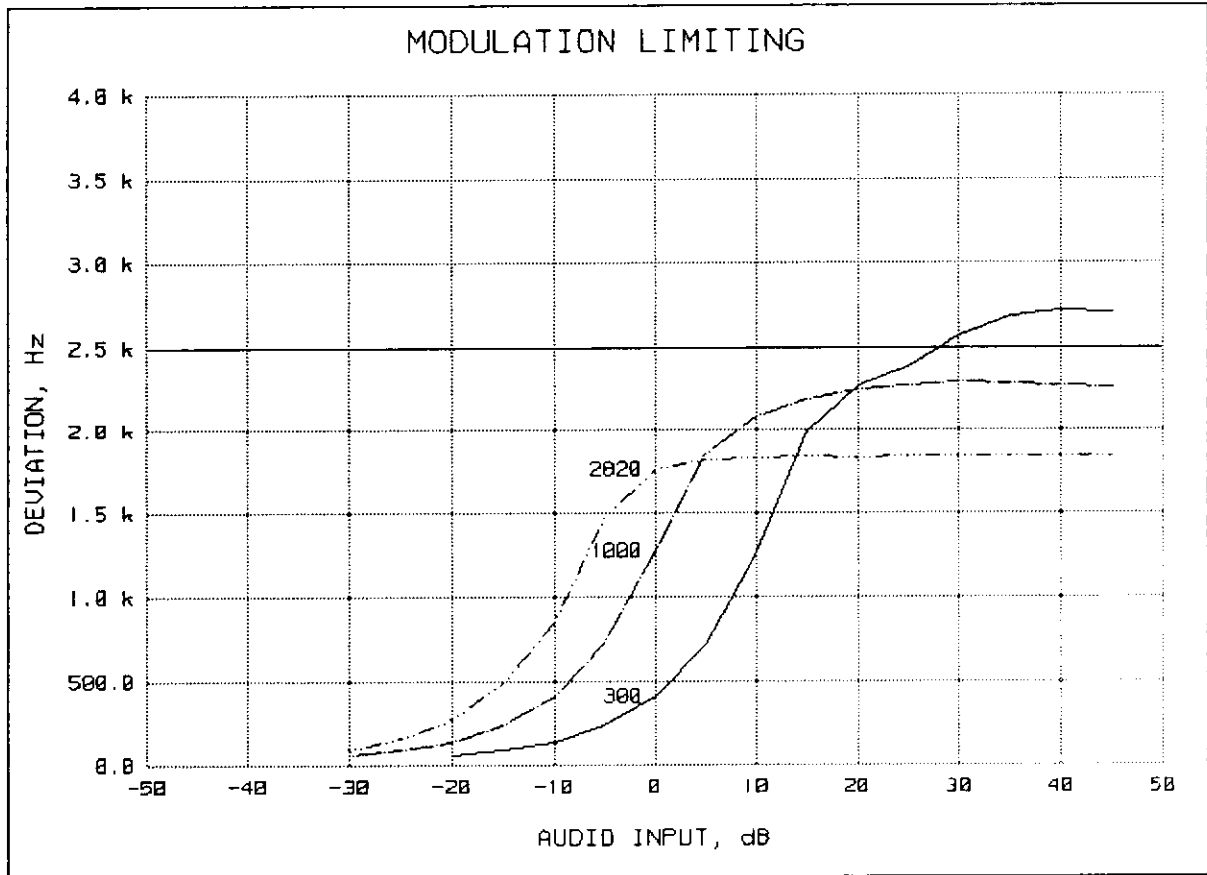

REFERENCE DEVIATION, kHz = 1.25
 REFERENCE MODULATION, Hz = 1000
 PEAKS = POSITIVE
 AUDIO AMPLITUDE, mV = 33.43

Morton Flom P. Eng.

SUPERVISED BY:

MORTON FLOM, P. Eng.

MODULATION LIMITING

TAIT ELECTRONICS, T867-16-0000 (EXCITER)

1998-JUL-17, 08:45

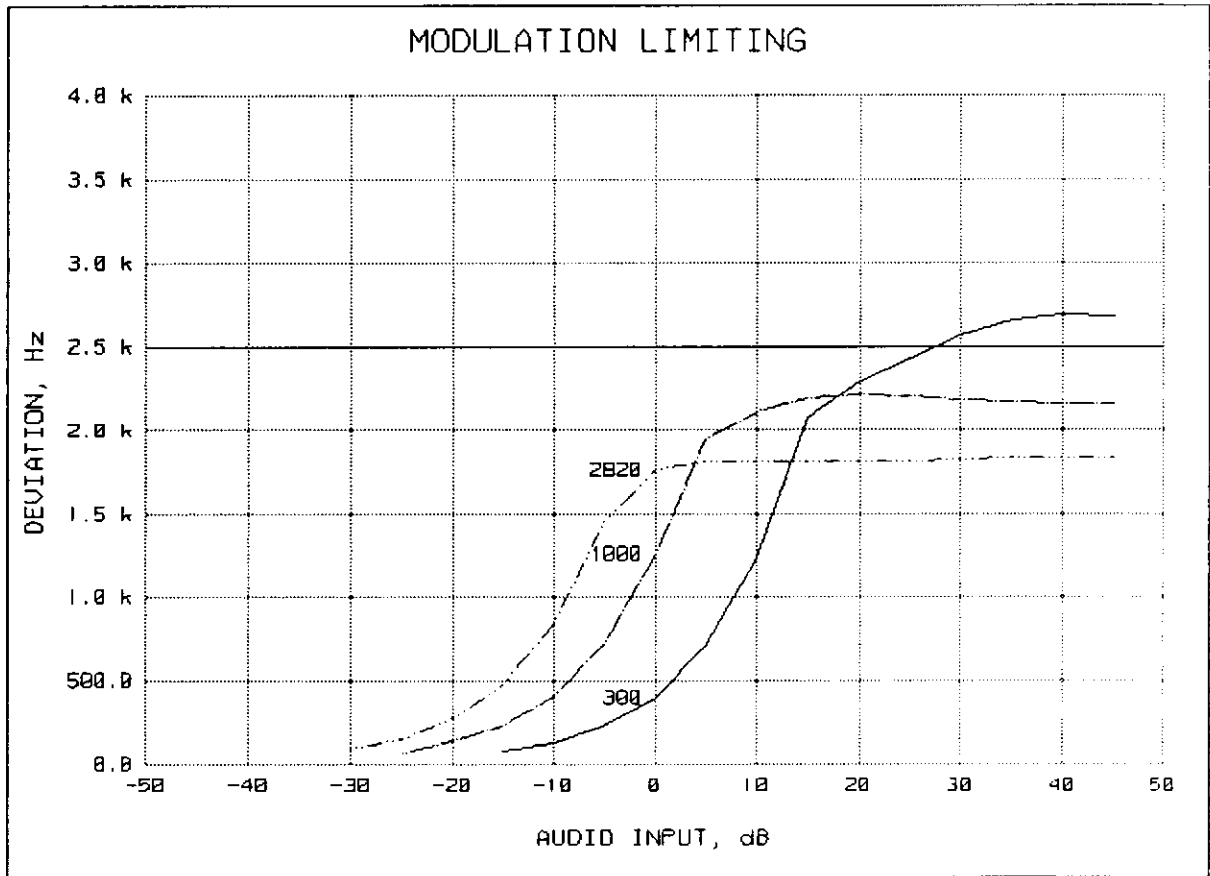

REFERENCE DEVIATION, kHz = 1.25
REFERENCE MODULATION, Hz = 1000
PEAKS = NEGATIVE
AUDIO AMPLITUDE, mV = 33.43

SUPERVISED BY:

MORTON FLOM, P. Eng.

MODULATION LIMITING

TAIT ELECTRONICS, T867-16-0000 (EXCITER)

1998-JUL-17, 08:41

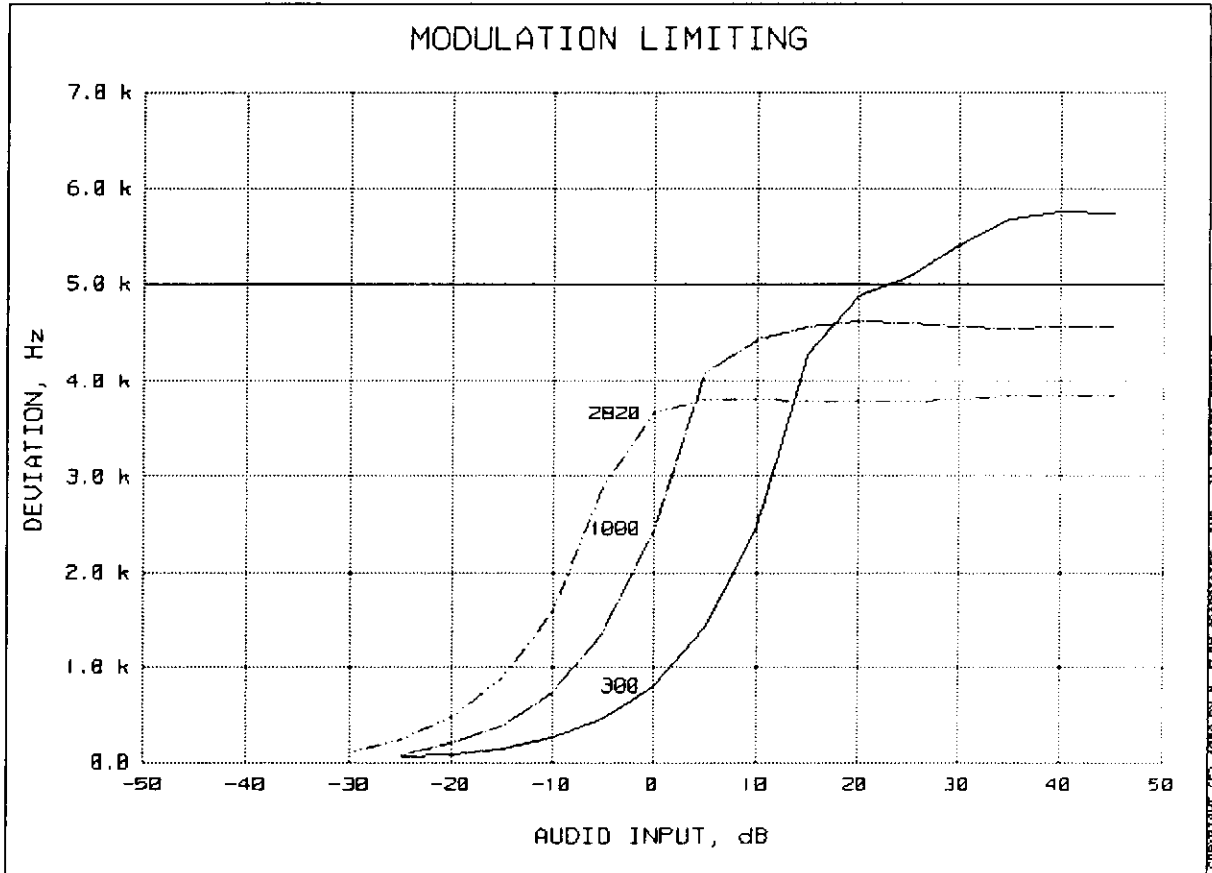

REFERENCE DEVIATION, kHz = 2.5

REFERENCE MODULATION, Hz = 1000

PEAKS = NEGATIVE

AUDIO AMPLITUDE, mV = 31.19

Morton Flom P. Eng.

SUPERVISED BY:

MORTON FLOM, P. Eng.

PAGE NO.

26.

CASTEL0016

NAME OF TEST:

Frequency Stability (Temperature Variation)

SPECIFICATION:

FCC: 47 CFR 2.995(a)(1)
IC: RSS-119, Section 7.0

GUIDE:

TIA/EIA-602, Section 2.2.2

TEST CONDITIONS:

As indicated

TEST EQUIPMENT:

As per attached page

MEASUREMENT PROCEDURE

1. The EUT and test equipment were set up as shown on the following page.
2. With all power removed, the temperature was decreased to -30°C and permitted to stabilize for three hours. Power was applied and the maximum change in frequency was noted within one minute.
3. With power OFF, the temperature was raised in 10°C steps. The sample was permitted to stabilize at each step for at least one-half hour. Power was applied and the maximum frequency change was noted within one minute.
4. The temperature tests were performed for the worst case.
5. MEASUREMENT RESULTS: ATTACHED

TRANSMITTER TEST SET-UP

TEST A. OPERATIONAL STABILITY
 TEST B. CARRIER FREQUENCY STABILITY
 TEST C. OPERATIONAL PERFORMANCE STABILITY
 TEST D. HUMIDITY
 TEST E. VIBRATION
 TEST F. ENVIRONMENTAL TEMPERATURE
 TEST G. FREQUENCY STABILITY: TEMPERATURE VARIATION
 TEST H. FREQUENCY STABILITY: VOLTAGE VARIATION

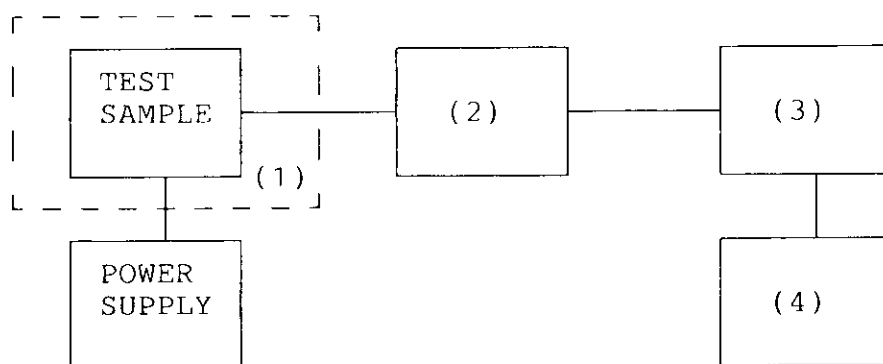
(1) TEMPERATURE, HUMIDITY, VIBRATION

| | |
|----------------------------|------------|
| TENNEY TEMPERATURE CHAMBER | <u>x</u> |
| WEBER HUMIDITY CHAMBER | <u> </u> |
| L.A.B. RVH 18-100 | <u> </u> |

(2) COAXIAL ATTENUATOR

| | |
|-------------------|------------|
| NARDA 766-10 | <u> </u> |
| SIERRA 661A-30 | <u>x</u> |
| BIRD 8329 (30 dB) | <u>x</u> |

(3) R.F. POWER

| | |
|----------------------|------------|
| HP 435A POWER METER | <u> </u> |
| HP 436A POWER METER | <u>x</u> |
| HP 8901A POWER METER | <u>x</u> |

(4) FREQUENCY COUNTER

| | |
|----------|------------|
| HP 5383A | <u> </u> |
| HP 5334B | <u>x</u> |
| HP 8901A | <u>x</u> |

TRANSMITTER FREQUENCY STABILITY
TAIT ELECTRONICS, T867-16-0000 (EXCITER)

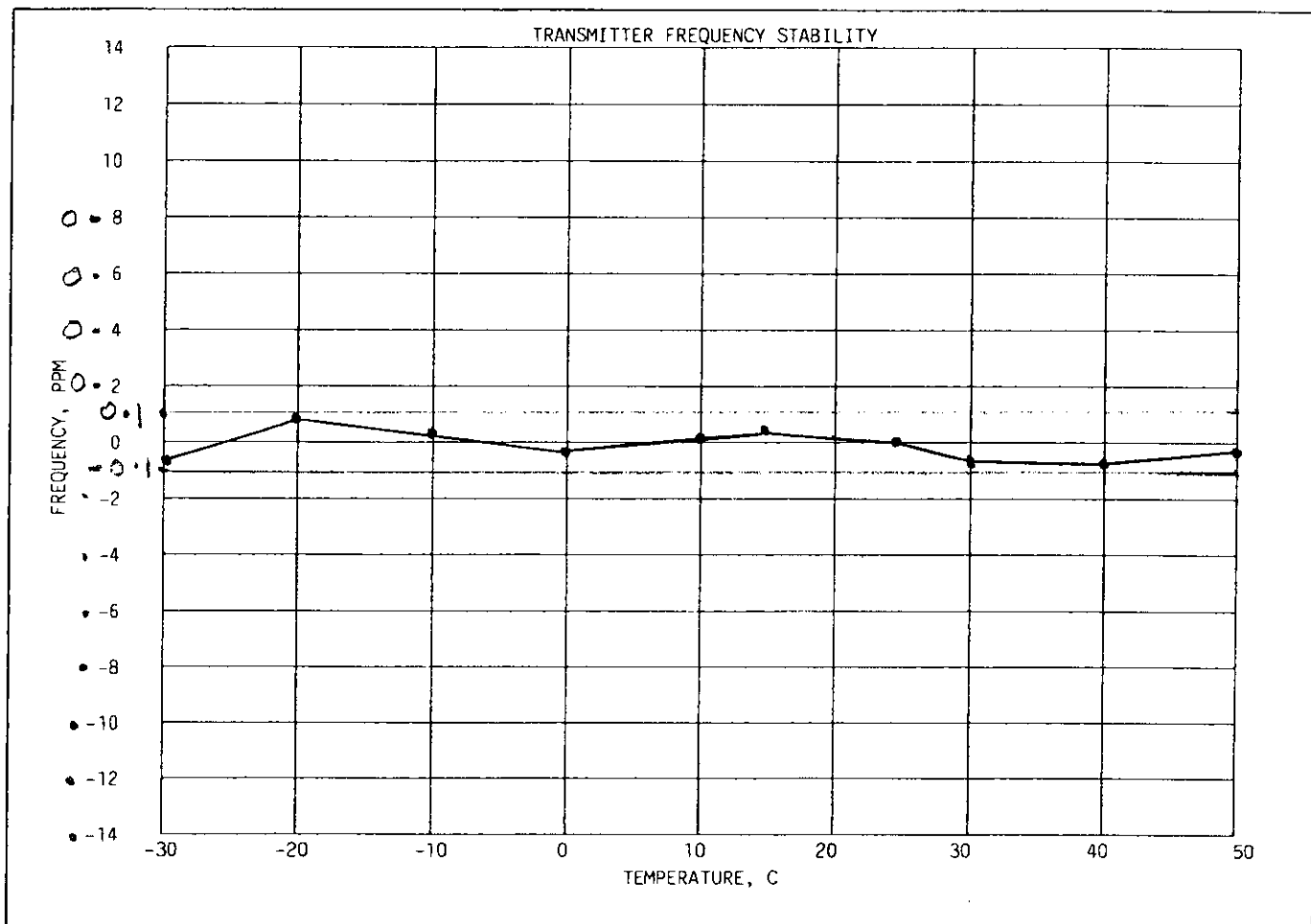

FREQUENCY OF CARRIER, MHz = 217.500

LIMIT, ppm = 0.1

LIMIT, Hz = 21

SUPERVISED BY:

Morton Flom, P. Eng.

PAGE NO. 29. CASTEL0016

NAME OF TEST: Frequency Stability (Voltage Variation)

SPECIFICATION: FCC: 47 CFR 2.995 (b)(1)
IC: RSS-119, Section 7.0

GUIDE: TIA/EIA-602, Section 2.2.2

TEST CONDITIONS: As indicated

TEST EQUIPMENT: As per attached page

MEASUREMENT PROCEDURE

1. The EUT was placed in a temperature chamber at 25±5°C and connected as for "Frequency Stability - Temperature Variation" test.
2. The power supply voltage to the EUT was varied from 85% to 115% of the nominal value measured at the input to the EUT.
3. The variation in frequency was measured for the worst case.

MEASUREMENT RESULTS

LIMIT, ppm = 0.1
LIMIT, Hz = 21

| STV, % | Vdc | <u>CHANGE IN FREQUENCY, Hz</u> | |
|--------|-------|--------------------------------|---|
| 85 | 102.0 | 217.500080 | 8 |
| 100 | 120.0 | 217.500000 | 0 |
| 115 | 138.0 | 217.500090 | 9 |

SUPERVISED BY:

M. J. F. Eng.
MORTON FLOM, P. Eng.

PAGE 30.

FCC ID: CASTEL0016

MODEL: T869-10-0000

POWER AMPLIFIER DATA

PAGE NO.

31.

CASTEL0016

NAME OF TEST:

Carrier Output Power (Conducted)

SPECIFICATION:

FCC: 47 CFR 2.985(a)
IC: RSS-119, Section 6.2

GUIDE:

TIA/EIA-603, Paragraph 2.2.1

TEST CONDITIONS:

Standard Temperature and Humidity (S. T. & H.)

TEST EQUIPMENT:

As per attached page

MEASUREMENT PROCEDURE

1. The EUT was connected to a resistive coaxial attenuator of normal load impedance, and the unmodulated output power was measured by means of an R. F. Power Meter.
2. Measurement accuracy is $\pm 3\%$.

MEASUREMENT RESULTS

NOMINAL, MHz

R.F. POWER OUTPUT, WATTS

POWER AMPLIFIER:

217.5

20

100

SUPERVISED BY:

MORTON FLOM, P. Eng.

TRANSMITTER POWER CONDUCTED MEASUREMENTS

TEST 1: R. F. POWER OUTPUT
 TEST 2: FREQUENCY STABILITY

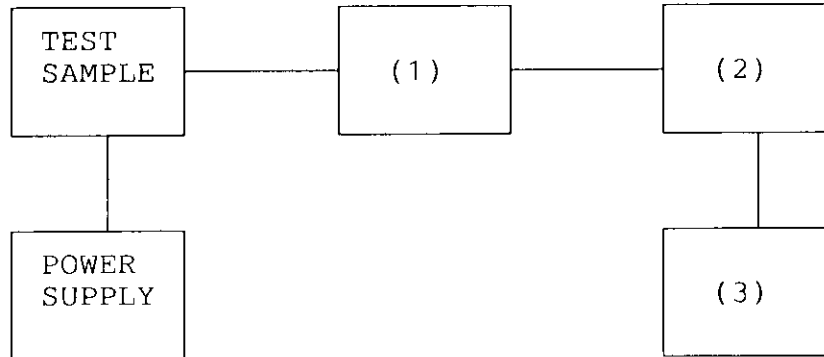
(1) COAXIAL ATTENUATOR

NARDA 766-10
 SIERRA 661A-30
 BIRD 8329 (30 dB)

 x

(2) POWER METERS

HP 435A
 HP 436A
 HP 8901A POWER MODE

 x
 x

(3) FREQUENCY COUNTER

HP 5383A
 HP 5334B
 HP 8901A FREQUENCY MODE

 x
 x

TRANSMITTER SPURIOUS EMISSION

TEST A. OCCUPIED BANDWIDTH (IN-BAND SPURIOUS)

TEST B. OUT-OF-BAND SPURIOUS

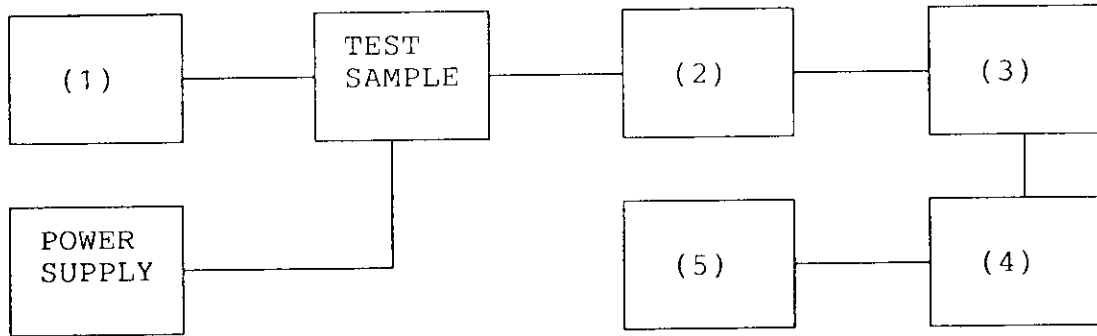
(1) AUDIO OSCILLATOR/GENERATOR

HP 204D

HP 8903A

HP 3312A

xx(2) COAXIAL ATTENUATOR

NARDA 766-10

SIERRA 661A-30

BIRD 8329 (30 dB)

xx(3) FILTERS; NOTCH, HP, LP, BP

CIRQTEL FHT

EAGLE TNF-1

PHELPS DODGE PD-495-8

x

(4) SPECTRUM ANALYZER

HP 8566B

HP 8563E

x

(5) SCOPE

HP 1741A

HP 181T

TEK 935

HP 54502A

G87H002

TRANSMITTER SPURIOUS EMISSIONS (CONDUCTED) (AMP)

POWER: LOW

| FREQUENCY TUNED, MHz | FREQUENCY EMISSION, MHz | LEVEL, dBm | LEVEL, dBc | LEVEL, μW |
|-------------------------|----------------------------|---------------|---------------|--------------|
| 217.500 | 435.172 | -31.6 | -74.6 | 1 |
| 217.500 | 652.714 | -31.2 | -74.2 | 1 |
| 217.500 | 869.932 | -31.8 | -74.8 | 1 |
| 217.500 | 1087.772 | -30.9 | -73.9 | 1 |
| 217.500 | 1304.593 | -31.8 | -74.8 | 1 |
| 217.500 | 1522.798 | -30.6 | -73.6 | 1 |
| 217.500 | 1740.450 | -31.0 | -74.0 | 1 |
| 217.500 | 1957.660 | -30.4 | -73.4 | 1 |
| 217.500 | 2175.488 | -29.8 | -72.8 | 1 |
| 217.500 | 2392.801 | -29.9 | -72.9 | 1 |
| 217.500 | 2609.932 | -32.0 | -75.0 | 1 |
| 217.500 | 2827.469 | -32.0 | -75.0 | 1 |
| 217.500 | 3045.215 | -32.1 | -75.1 | 1 |
| 217.500 | 3262.868 | -32.9 | -75.9 | 1 |

G87H001

TRANSMITTER SPURIOUS EMISSIONS (CONDUCTED) (AMP)

POWER: HIGH

| FREQUENCY TUNED, MHz | FREQUENCY EMISSION, MHz | LEVEL, dBm | LEVEL, dBc | LEVEL, μW |
|-------------------------|----------------------------|---------------|---------------|--------------|
| 217.500 | 434.931 | -32.0 | -82.0 | 1 |
| 217.500 | 652.923 | -32.1 | -82.1 | 1 |
| 217.500 | 870.008 | -30.5 | -80.5 | 1 |
| 217.500 | 1087.439 | -31.8 | -81.8 | 1 |
| 217.500 | 1305.118 | -32.2 | -82.2 | 1 |
| 217.500 | 1522.504 | -31.8 | -81.8 | 1 |
| 217.500 | 1739.795 | -31.7 | -81.7 | 1 |
| 217.500 | 1957.675 | -30.5 | -80.5 | 1 |
| 217.500 | 2175.464 | -30.7 | -80.7 | 1 |
| 217.500 | 2392.339 | -30.9 | -80.9 | 1 |
| 217.500 | 2609.998 | -31.8 | -81.8 | 1 |
| 217.500 | 2827.855 | -33.4 | -83.4 | 0 |
| 217.500 | 3044.733 | -33.4 | -83.4 | 0 |
| 217.500 | 3262.668 | -33.1 | -83.1 | 0 |

PAGE NO. 36.1.

CASTEL0016

NAME OF TEST: Field Strength of Spurious Radiation

SPECIFICATION: FCC: 47 CFR 2.993(a)
IC: N/A

GUIDE: TIA/EIA-603, Section 2.2.12

TEST CONDITIONS: S. T. & H.

TEST EQUIPMENT: AS PER ATTACHED PAGE

MEASUREMENT PROCEDURE

1. A description of the measurement facilities was filed with the FCC and was found to be in compliance with the requirements of Section 15.38, by letter from the FCC dated March 3, 1997, FILE 31040/SIT. All pertinent changes will be reported to the Commission by up-date prior to March 2000.
2. At first, in order to locate all spurious frequencies and approximate amplitudes, and to determine proper equipment functioning, the test sample was set up at a distance of three meters from the test instrument. Valid spurious signals were determined by switching the power on and off.
3. In the field, the test sample was placed on a wooden turntable above ground at three (or thirty) meters away from the search antenna. The test sample was connected to an R.F. Wattmeter and a 50 ohm dummy load, and adjusted to its rated output.

In order to obtain the maximum response at each spurious frequency, the turntable was rotated. Also, the Search Antennas were raised and lowered vertically, and all cables were oriented. Excess power lead was coiled near the power supply.

4. A signal generator, connected with a non-radiating cable to a vertically polarized half-wave antenna (for each frequency involved) was substituted for the transmitter. The Search Antenna was raised and lowered to obtain maximum indicated.
5. The signal generator output was adjusted until a signal level indication equal to that from the transmitter was obtained.
6. Steps 4 and 5 were repeated, using a horizontally polarized half-wave antenna. The higher of the two observations was noted.

PAGE NO.

36.2.

CASTEL0016

NAME OF TEST:

Field Strength of Spurious Radiation

SPECIFICATION:

FCC: 47 CFR 2.993(a)

IC: N/A

MEASUREMENT PROCEDURE (CONT.)

7. Power into the half-wave antenna was calculated from the characteristic impedance of the line, and the voltage output from the signal generator.

8. The level of each spurious radiation with reference to the transmitter power in dB, was calculated from:

$$\text{SPURIOUS LEVEL, dB} = 10 \text{ LOG (Calculated Spurious Power)} \\ \frac{[\text{from para. 7}]}{\text{Tx Power (Wattmeter)}}$$

9. The worst case for all channels is shown.

10. Measurement summary:

| | |
|---------------------------|-------------------------------------|
| FREQUENCY OF CARRIER, MHz | = 217.5 |
| SPECTRUM SEARCHED, GHz | = 0 to $10 \times F_c$ |
| ALL OTHER EMISSIONS | = ≥ 20 dB BELOW LIMIT |
| LIMIT, dBc | = -63 (100 Watts) -56 (20 Watts) |

11. Measurement results:

ATTACHED FOR WORST CASE

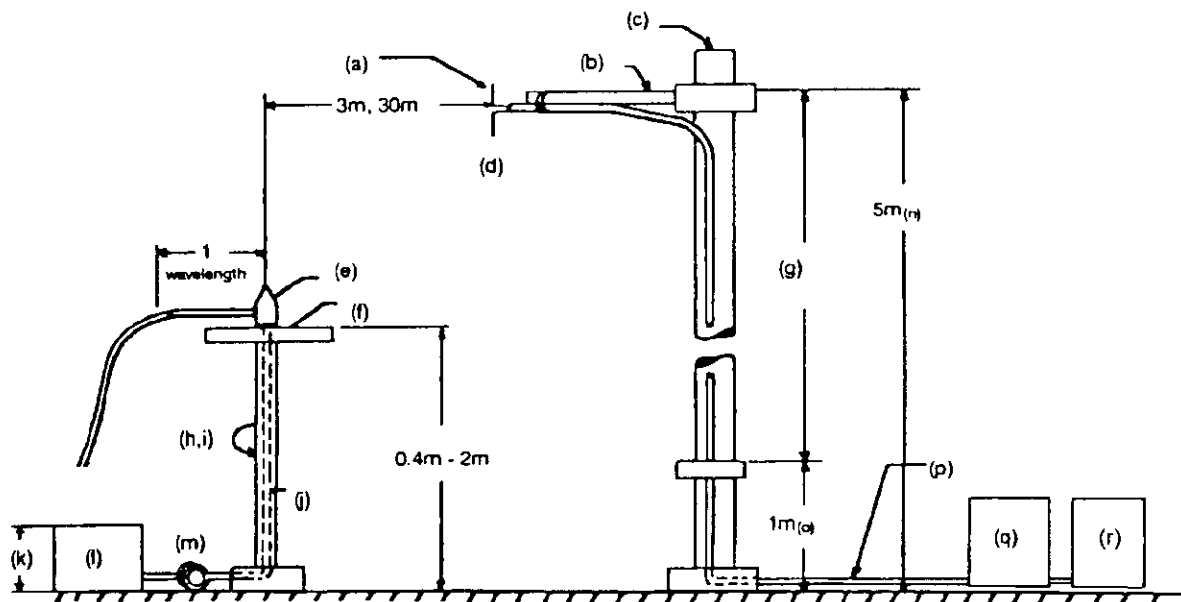
RADIATED TEST SETUP

NOTES:

- (a) Search Antenna - Rotatable on boom.
- (b) Non-metallic boom.
- (c) Non-metallic mast.
- (d) Adjustable horizontally.
- (e) Equipment Under Test.
- (f) Turntable.
- (g) Boom adjustable in height.
- (h) External control cables routed horizontally at least one wavelength.
- (i) Rotatable.
- (j) Cables routed through hollow turntable center.
- (k) 30 cm or less.
- (l) External power source.
- (m) 10 cm diameter coil of excess cable.
- (n) 25 cm (V), 1 m-7 m (V, H).
- (o) 25 cm from bottom end of 'V', 1 m normally.
- (p) Calibrated Cable at least 10 m in length.
- (q) Amplifier (optional).
- (r) Spectrum Analyzer.

TRANSMITTER SPURIOUS EMISSIONS (RADIATED FIELD STRENGTH)

ALL OTHER EMISSIONS = ≥ 20 dB BELOW LIMIT

| EMISSION, MHz/HARMONIC | SPURIOUS LEVEL BELOW | |
|---------------------------|----------------------|----|
| | Lo | Hi |
| | | |

AMPLIFIER

| | | |
|-------------|--------|--------|
| 2nd to 10th | <-72.8 | <-80.5 |
|-------------|--------|--------|

SUPERVISED BY:

M. Thom P. Eng
MORTON FLOM, P. Eng.

PAGE NO.

39.

CASTEL0016

NAME OF TEST:

Emission Masks (Occupied Bandwidth)

SPECIFICATION:

FCC: 47 CFR 2.989(c)(1)
IC: RSS-119, Section 6.4

GUIDE:

TIA/EIA-603, Paragraph 2.2.11

TEST CONDITIONS:

S. T. & H.

TEST EQUIPMENT:

As per previous page

MEASUREMENT PROCEDURE

1. The EUT and test equipment were set up as shown on the following page, with the Spectrum Analyzer connected.
2. For EUTs supporting audio modulation, the audio signal generator was adjusted to the frequency of maximum response and with output level set for ± 2.5 kHz deviation (or 50% modulation). With level constant, the signal level was increased 16 dB.
3. For EUTs supporting digital modulation, the digital modulation mode was operated to its maximum extent.
4. The Occupied Bandwidth was measured with the Spectrum Analyzer controls set as shown on the test results.
5. MEASUREMENT RESULTS: ATTACHED

SPECTRUM ANALYZER PRESENTATION
TAIT ELECTRONICS, T869-10-0000 (AMP)
1998-JUL-17, 07:43, FRI

POWER: LOW
MODULATION: NONE

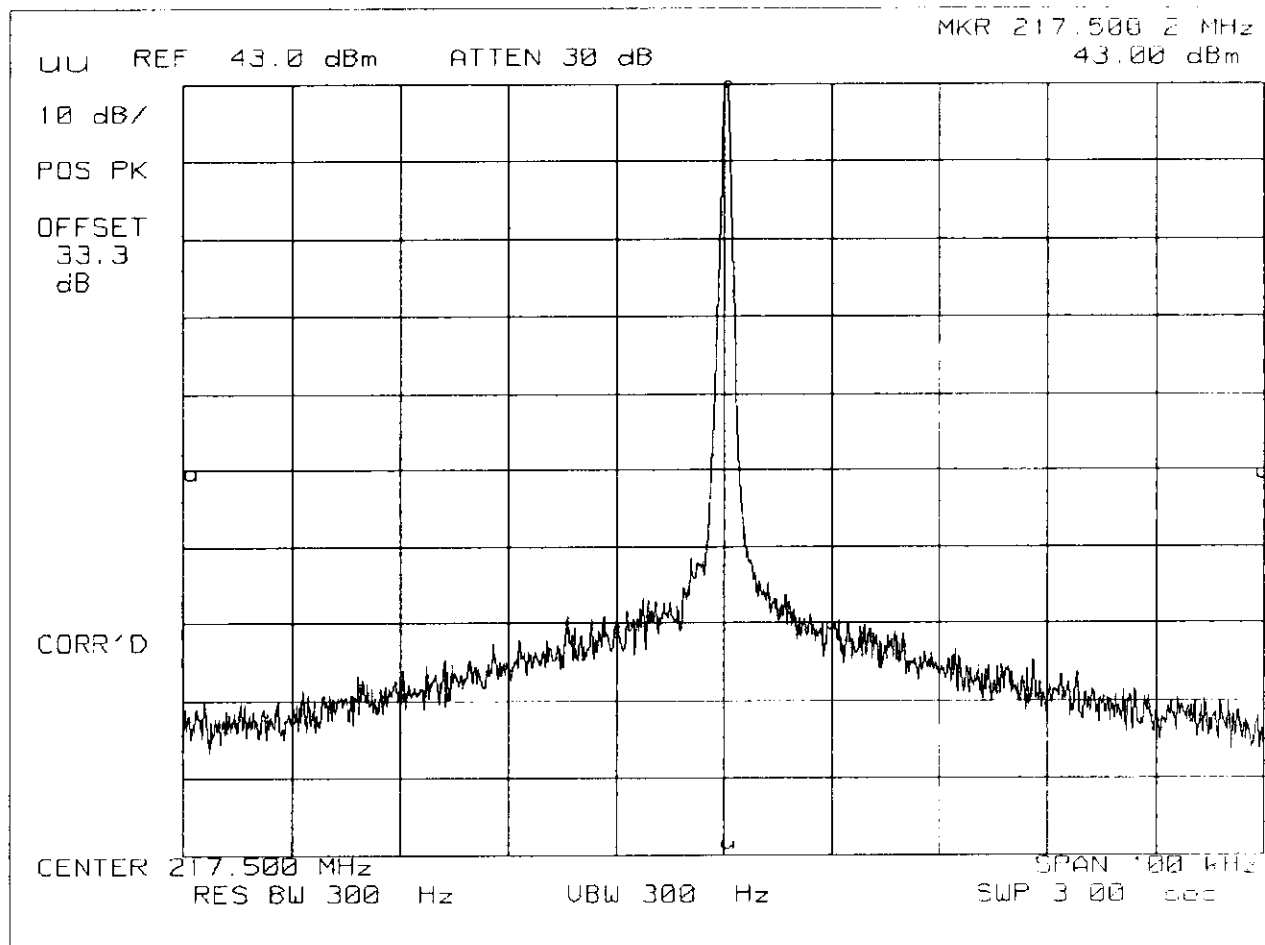

© 1998 TAIT ELECTRONICS, INC. ALL RIGHTS RESERVED

SPECTRUM ANALYZER PRESENTATION
TAIT ELECTRONICS, T86-10-0000 (AMP)
1998-JUL-17, 07:53, FRI

POWER: LOW
MODULATION: VOICE: 2500 Hz SINE WAVE
MASK: D, VHF/UHF 12.5kHz BW

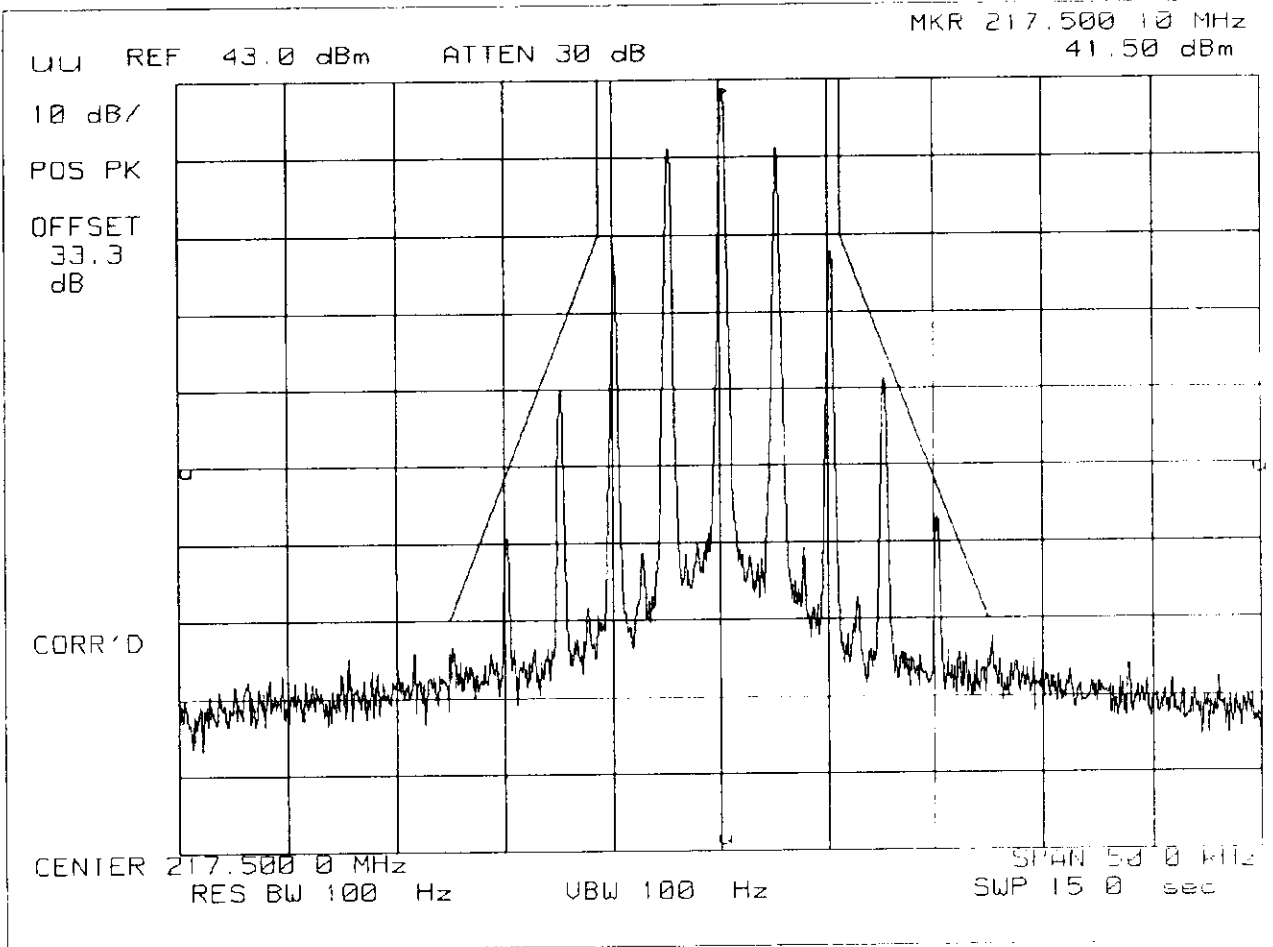

© 1998 TAIT ELECTRONICS, INC. ALL RIGHTS RESERVED

SPECTRUM ANALYZER PRESENTATION
TAIT ELECTRONICS, T869-10-0000 (AMP)
1998-JUL-17, 07:40, FRI

POWER: HIGH
MODULATION: NONE

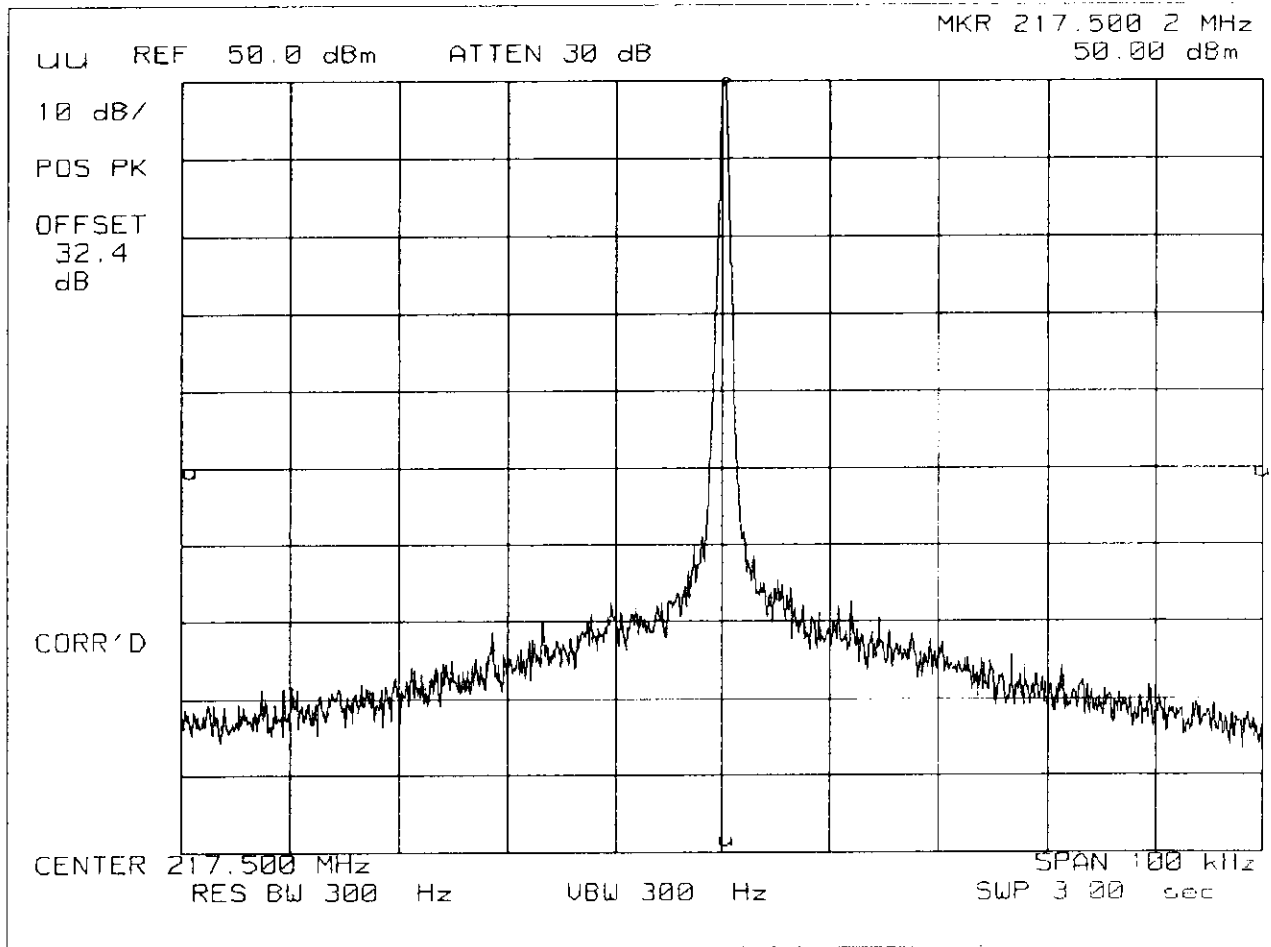

© 1998 TAIT ELECTRONICS, INC. ALL RIGHTS RESERVED

PAGE 40.5
SPECTRUM ANALYZER PRESENTATION
TAIT ELECTRONICS, T869-10-0000 (AMP)
1998-JUL-17, 07:52, FRI

CASTEL0016

POWER: HIGH
MODULATION: VOICE: 2500 Hz SINE WAVE
MASK: D, VHF/UHF 12.5kHz BW

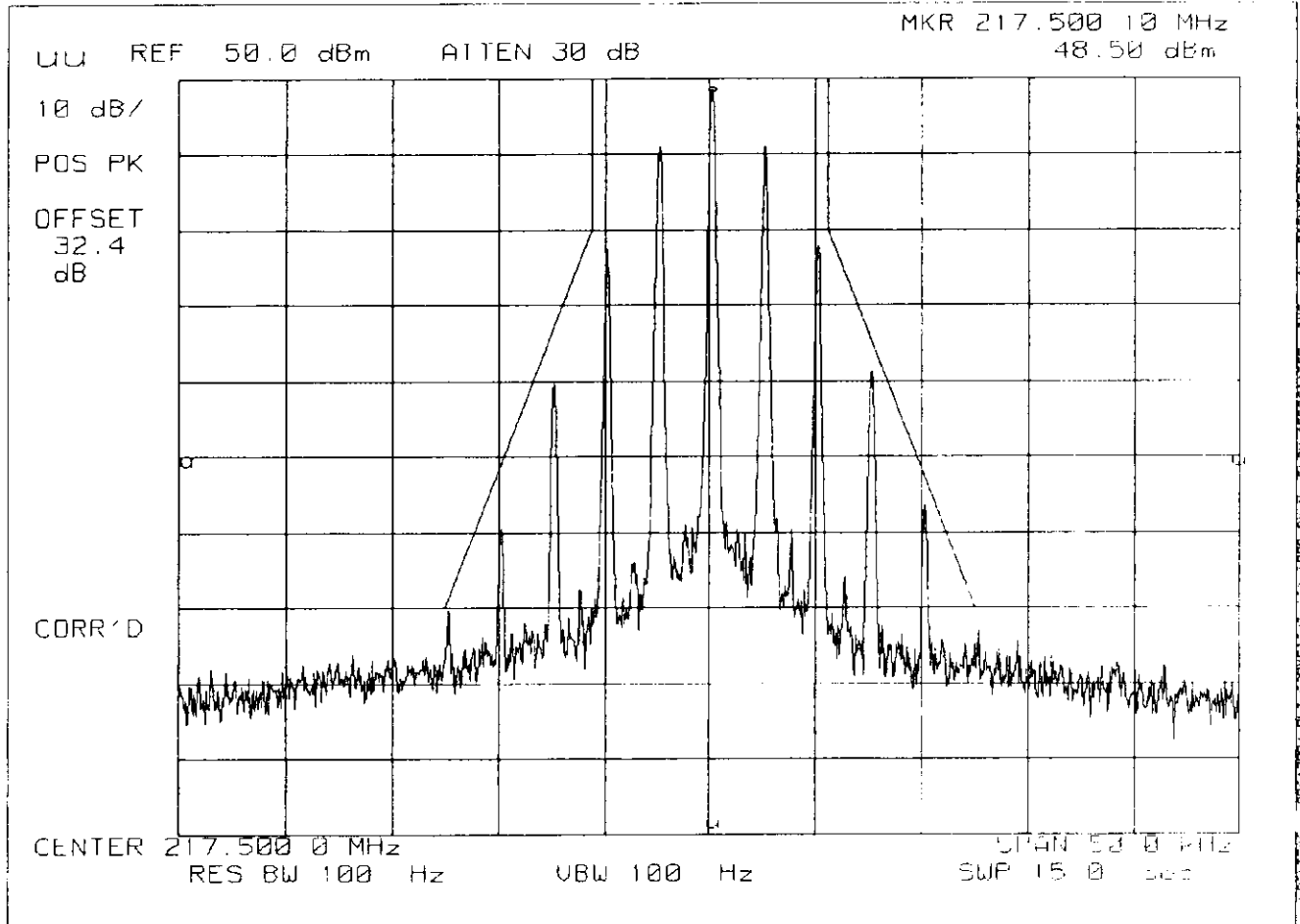

SPECTRUM ANALYZER PRESENTATION
TAIT ELECTRONICS, T869-10-0000 (AMP)
1998-JUL-17, 07:45, FRI

POWER: HIGH
MODULATION: VOICE: 2500 Hz SINE WAVE
MASK: B, VHF/UHF 25kHz, w/LPF

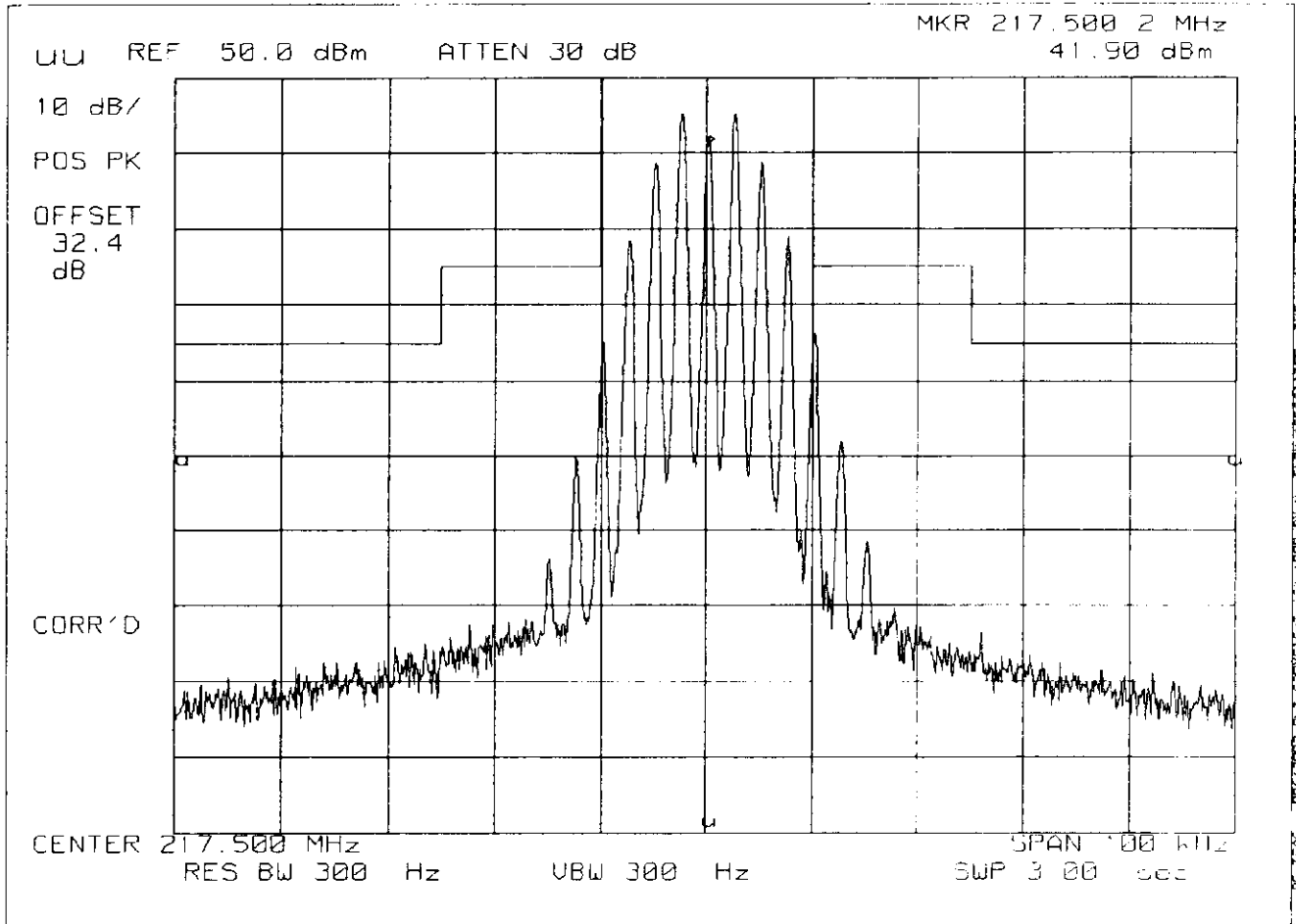

PAGE NO.

41.

CASTEL0016

NAME OF TEST:

Transient Frequency Behavior

SPECIFICATION:

FCC: 47 CFR 90.214
IC: RSS-119, Section 6.5

GUIDE:

TIA/EIA-603, Paragraph 2.2.19

TEST CONDITIONS:

S. T. & H.

TEST EQUIPMENT:

As per attached page

MEASUREMENT PROCEDURE

1. The EUT was setup as shown on the attached page, following TIA/EIA-603 steps a, b, and c as a *guide*.
2. The transmitter was turned on.
3. Sufficient attenuation was provided so that the transmitter carrier level measured at the output of the combiner was 40 dB below the maximum input level of the test receiver. This level was recorded as step f.
4. The transmitter was turned off.
5. An RF signal generator (1) modulated with a 1 kHz tone at either 25, 12.5, or 6.25 kHz deviation, and set to the same frequency as the assigned transmitter frequency, (2) was adjusted to a level -20 dB below the level recorded for step f, as measured at the output of the combiner. This level was then fixed for the remainder of the test and is recorded at step h.
6. The oscilloscope was setup using TIA/EIA-603 steps j and k as a guide, and to either 10 ms/div (UHF) or 5 ms/div (VHF).
7. The 30 dB attenuator was removed, the transmitter was turned on, and the level of the carrier at the output of the combiner was recorded as step l.
8. The carrier on-time as referenced in TIA/EIA-603 steps m, n, and o was captured and plotted. The carrier off-time as referenced in TIA/EIA-603 steps p, q, r, and s was captured and plotted.

LEVELS MEASURED:

| | AMPLIFIER | |
|---------------------|-----------|---------|
| <u>step f</u> , dBm | | = -11.1 |
| <u>step h</u> , dBm | | = -33.5 |
| <u>step l</u> , dBm | | = 17.2 |

SUPERVISED BY:

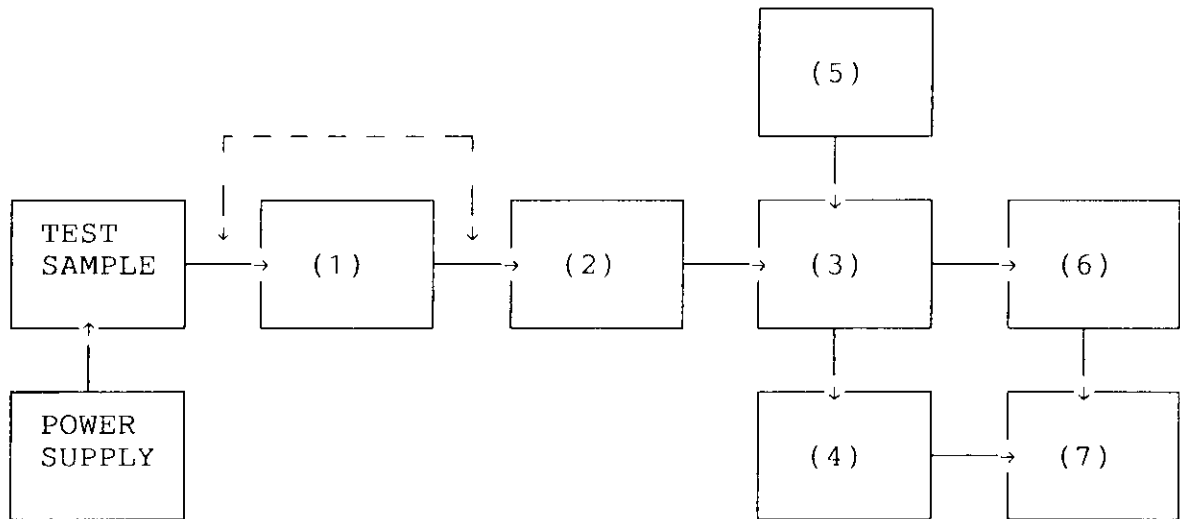

MORTON FLOM, P. Eng.

TRANSIENT FREQUENCY BEHAVIOR

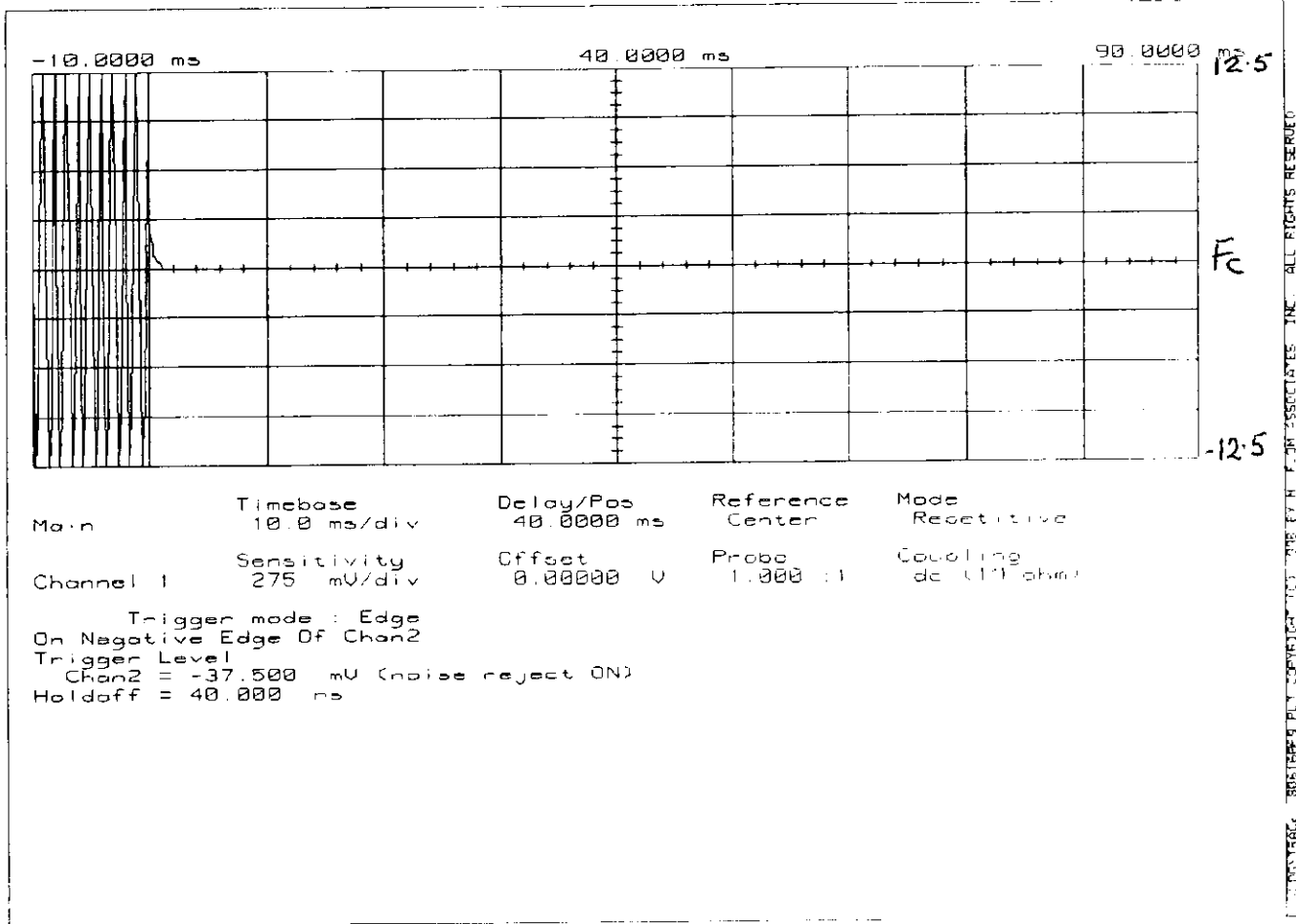

- (1) ATTENUATOR
 (NOTE: Removed after 1st step)
 30 dB x
- (2) ATTENUATOR
 30 dB
 20 dB
 10 dB
 KAY VARIABLE
- (3) COMBINER
 4 x 25 Ω COMBINER x
- (4) CRYSTAL DETECTOR
 HP 8470B x
- (5) RF SIGNAL GENERATOR
 HP 8656A
 HP 8920A x
- (6) MODULATION ANALYZER
 HP 8901A x
- (7) SCOPE
 HP 54502A x

MODULATION: Ref Gen=12.5 kHz Deviation
REMARK: CARRIER ON TIME



OSCILLOSCOPE PRESENTATION

TAIT ELECTRONICS, T86 9-10-0000 (AMP)

1998-JUL-16, 16:19, THR

MODULATION: Ref Gen=25 kHz Deviation

REMARK: CARRIER ON TIME

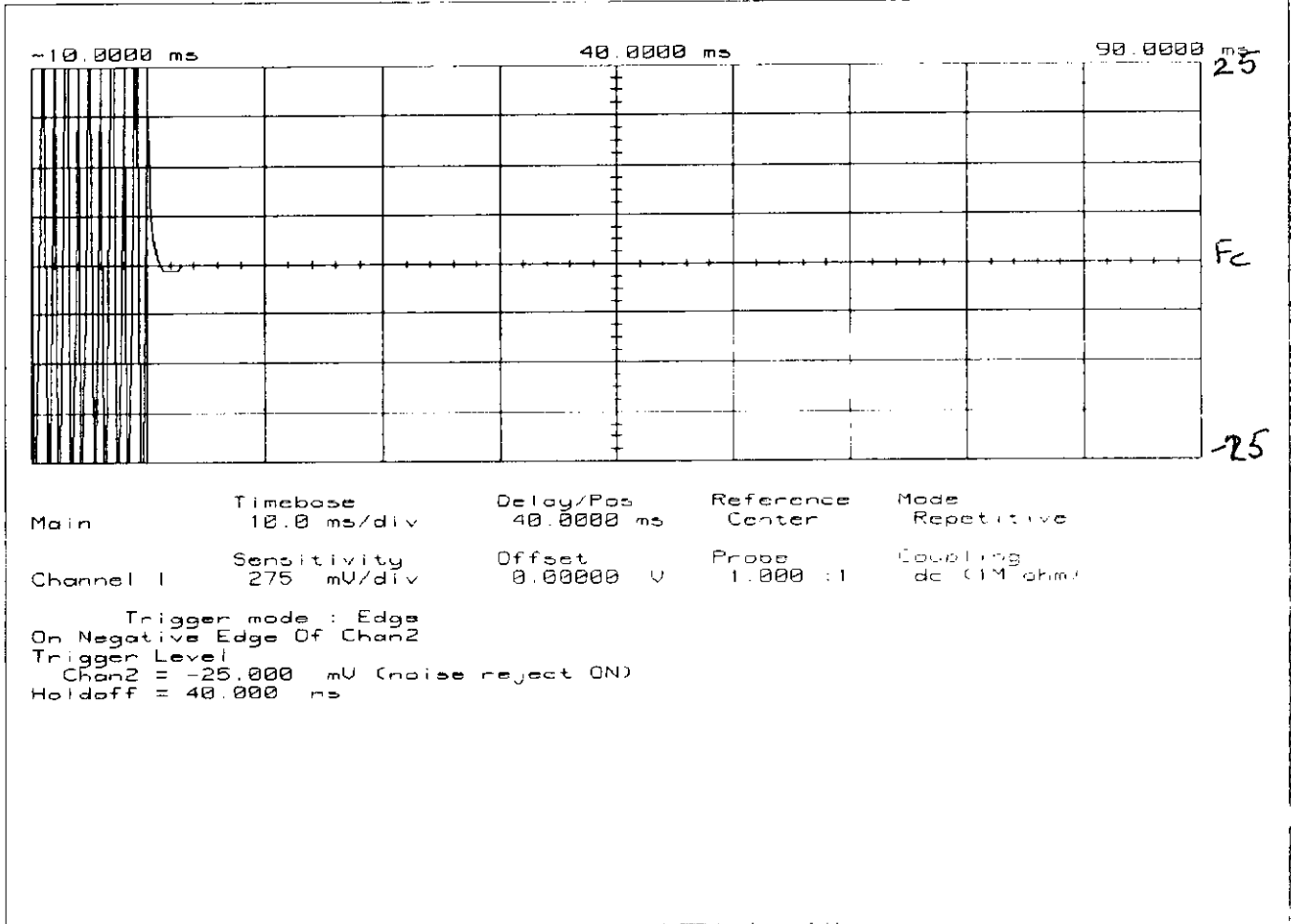

| | | | | |
|-----------|---------------------------|-------------------------|---------------------|-------------------------|
| Main | Timebase 10.0 ms/div | Delay/Pos 40.0000 ms | Reference Center | Mode Repetitive |
| Channel 1 | Sensitivity 275 mV/div | Offset 0.00000 V | Probe 1.000 :1 | Coupling dc (1M ohm) |

Trigger mode : Edge
 On Negative Edge Of Chan2
 Trigger Level
 Chan2 = -25.000 mV (noise reject ON)
 Holdoff = 40.000 ns

C:\TOOLS\ELLS\88615887\PLT\CASTEL0016.PLT: 1998 JUL 16 16:19:19: TAIT ELECTRONICS. ALL RIGHTS RESERVED.

OSCILLOSCOPE PRESENTATION

TAIT ELECTRONICS, T869-10-0000 (AMP)

1998-JUL-16, 16:20, THR

MODULATION: Ref Gen=25 kHz Deviation

REMARK: CARRIER OFF TIME

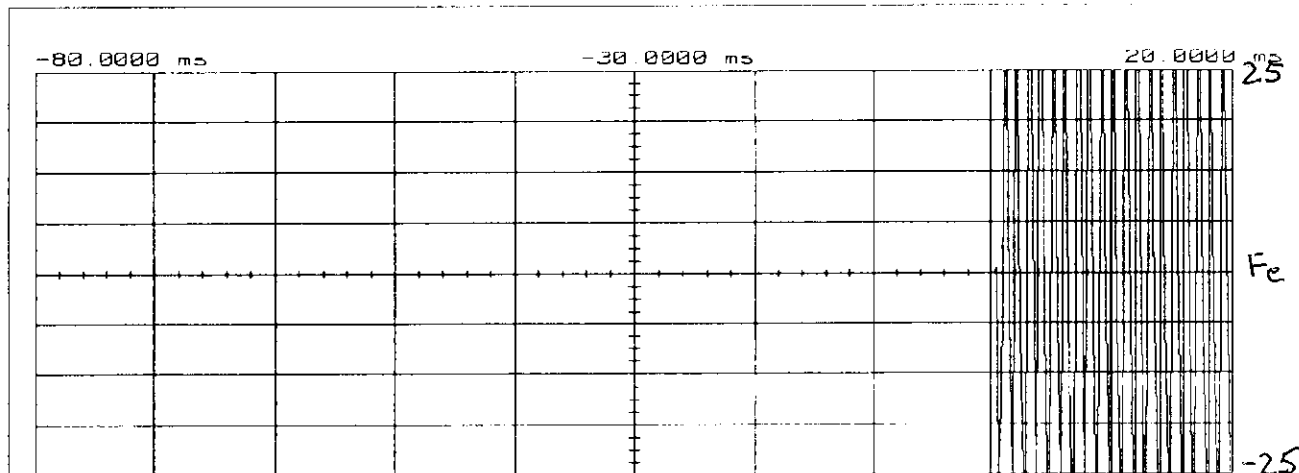

| | | | | |
|-----------|---------------------------|--------------------------|---------------------|-------------------------|
| Main | Timebase 10.0 ms/div | Delay/Pos -30.0000 ms | Reference Center | Mode Repetitive |
| Channel 1 | Sensitivity 275 mV/div | Offset 0.00000 V | Probe 1.000 :1 | Coupling dc (1M ohm) |

Trigger mode : Edge
 On Positive Edge Of Chan2
 Trigger Level
 Chan2 = -262.500 mV (noise reject ON)
 Holdoff = 40.000 ns

OSCILLOSCOPE PRESENTATION T869-10-0000 JUL 16 1998 16:20:00 ALL RIGHTS RESERVED

PAGE NO.

44.

CASTEL0016

NAME OF TEST:

Audio Low Pass Filter (Voice Input)

SPECIFICATION:

FCC: 47 CFR 2.987(a)
IC: RSS-119, Section 6.6

GUIDE:

TIA/EIA-603, Paragraph 2.2.15

TEST CONDITIONS:

S. T. & H.

TEST EQUIPMENT:

As per attached page

MEASUREMENT PROCEDURE

1. The EUT and test equipment were set up such that the audio input was connected at the input to the modulation limiter, and the modulated stage.
2. The audio output was connected at the output to the modulated stage.
3. MEASUREMENT RESULTS: ATTACHED

TRANSMITTER TEST SET-UP

TEST A. MODULATION CAPABILITY/DISTORTION
 TEST B. AUDIO FREQUENCY RESPONSE
 TEST C. HUM AND NOISE LEVEL
 TEST D. RESPONSE OF LOW PASS FILTER
 TEST E. MODULATION LIMITING

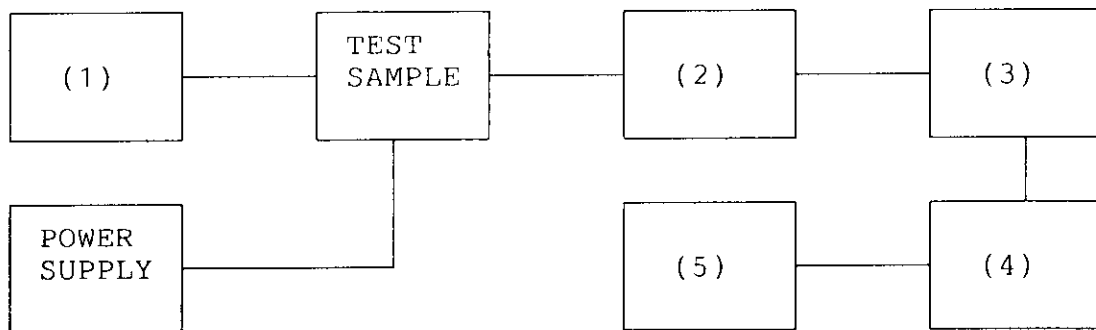
(1) AUDIO OSCILLATOR/GENERATOR

| | |
|----------|--------------|
| HP 204D | _____ |
| HP 8903A | _____ |
| HP 3312A | <u> x </u> |
| _____ | <u> x </u> |

(2) COAXIAL ATTENUATOR

| | |
|-------------------|--------------|
| NARDA 766-10 | _____ |
| SIERRA 661A-30 | <u> x </u> |
| BIRD 8329 (30 dB) | _____ |
| _____ | _____ |

(3) MODULATION ANALYZER

| | |
|----------|--------------|
| HP 8901A | <u> x </u> |
| _____ | _____ |

(4) AUDIO ANALYZER

| | |
|----------|--------------|
| HP 8903A | <u> x </u> |
| _____ | _____ |

(5) SCOPE

| | |
|----------|-------|
| HP 1741A | _____ |
| HP 181T | _____ |
| TEK 935 | _____ |
| _____ | _____ |

PAGE NO.

46.

CASTEL0016

NAME OF TEST:

Audio Low Pass Filter (Voice Input)

NOT APPLICABLE

PAGE NO.

47.

CASTEL0016

NAME OF TEST:

Audio Frequency Response

SPECIFICATION:

FCC: 47 CFR 2.987(a)
IC: N/A

GUIDE:

TIA/EIA-603, Section 2.2.6

TEST CONDITIONS:

S. T. & H.

TEST EQUIPMENT:

As per previous page

MEASUREMENT PROCEDURE

1. The EUT and test equipment were set up as shown on the following page.
2. The audio signal generator was connected to the audio input circuit/microphone of the EUT.
3. The audio signal input was adjusted to obtain 20% modulation at 1 kHz, and this point was taken as the 0 dB reference level.
4. With input levels held constant and below limiting at all frequencies, the audio signal generator was varied from 100 Hz to 50 kHz.
5. The response in dB relative to 1 kHz was then measured, using the HP 8901A Modulation Analyzer.
6. MEASUREMENT RESULTS: ATTACHED

PAGE NO.

48.

CASTEL0016

NAME OF TEST:

Audio Frequency Response

NOT APPLICABLE

PAGE NO.

49.

CASTEL0016

NAME OF TEST:

Modulation Limiting

SPECIFICATION:

IC: RSS-119, Section 6.6
FCC: 47 CFR 2.987(b)

GUIDE:

TIA/EIA-603, Paragraph 2.2.3

TEST CONDITIONS:

S. T. & H.

TEST EQUIPMENT:

As per attached page

MEASUREMENT PROCEDURE

1. The signal generator was connected to the input of the EUT as for "Frequency Response of the Modulating Circuit."
2. The modulation response was measured for each of three frequencies (one of which was the frequency of maximum response), and the input voltage was varied and was observed on an HP 8901A Modulation Analyzer.
3. The input level was varied from 30% modulation (± 1.5 kHz deviation) to at least 20 dB higher than the saturation point.
4. Measurements were performed for both negative and positive modulation and the respective results were recorded.
5. MEASUREMENT RESULTS: ATTACHED

PAGE NO.

50.

CASTEL0016

NAME OF TEST:

Modulation Limiting

NOT APPLICABLE

PAGE NO.

51.

CASTEL0016

NAME OF TEST:

Frequency Stability (Temperature Variation)

SPECIFICATION:

FCC: 47 CFR 2.995(a)(1)
IC: RSS-119, Section 7.0

GUIDE:

TIA/EIA-602, Section 2.2.2

TEST CONDITIONS:

As indicated

TEST EQUIPMENT:

As per attached page

MEASUREMENT PROCEDURE

1. The EUT and test equipment were set up as shown on the following page.
2. With all power removed, the temperature was decreased to -30°C and permitted to stabilize for three hours. Power was applied and the maximum change in frequency was noted within one minute.
3. With power OFF, the temperature was raised in 10°C steps. The sample was permitted to stabilize at each step for at least one-half hour. Power was applied and the maximum frequency change was noted within one minute.
4. The temperature tests were performed for the worst case.
5. MEASUREMENT RESULTS: ATTACHED

TRANSMITTER TEST SET-UP

- TEST A. OPERATIONAL STABILITY
- TEST B. CARRIER FREQUENCY STABILITY
- TEST C. OPERATIONAL PERFORMANCE STABILITY
- TEST D. HUMIDITY
- TEST E. VIBRATION
- TEST F. ENVIRONMENTAL TEMPERATURE
- TEST G. FREQUENCY STABILITY: TEMPERATURE VARIATION
- TEST H. FREQUENCY STABILITY: VOLTAGE VARIATION

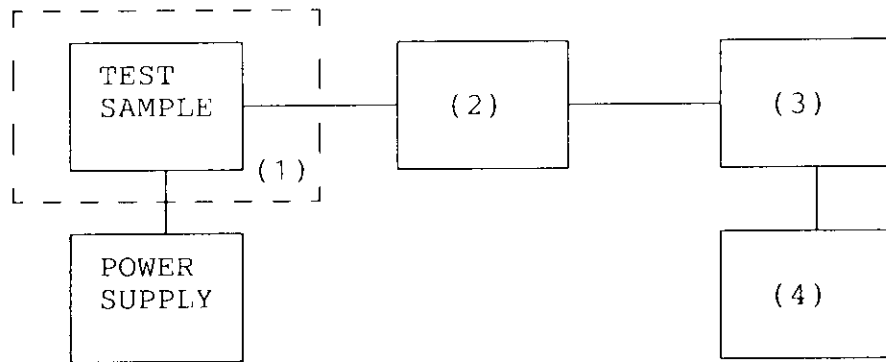

(1) TEMPERATURE, HUMIDITY, VIBRATION

| | |
|----------------------------|---------------|
| TENNEY TEMPERATURE CHAMBER | <u> x </u> |
| WEBER HUMIDITY CHAMBER | <u> </u> |
| L.A.B. RVH 18-100 | <u> </u> |
| <hr/> | |

(2) COAXIAL ATTENUATOR

| | |
|-------------------|---------------|
| NARDA 766-10 | <u> </u> |
| SIERRA 661A-30 | <u> x </u> |
| BIRD 8329 (30 dB) | <u> x </u> |
| <hr/> | |

(3) R.F. POWER

| | |
|---------------------|---------------|
| HP 435A POWER METER | <u> </u> |
| HP 436A POWER METER | <u> x </u> |
| HP 8901A POWER MODE | <u> x </u> |
| <hr/> | |

(4) FREQUENCY COUNTER

| | |
|----------|---------------|
| HP 5383A | <u> </u> |
| HP 5334B | <u> x </u> |
| HP 8901A | <u> x </u> |
| <hr/> | |

PAGE NO.

53.

CASTEL0016

NAME OF TEST:

Frequency Stability (Temperature Variation)

NOT APPLICABLE

PAGE NO.

54.

CASTEL0016

NAME OF TEST:

Frequency Stability (Voltage Variation)

SPECIFICATION:

FCC: 47 CFR 2.995 (b)(1)
IC: RSS-119, Section 7.0

GUIDE:

TIA/EIA-602, Section 2.2.2

TEST CONDITIONS:

As indicated

TEST EQUIPMENT:

As per attached page

MEASUREMENT PROCEDURE

1. The EUT was placed in a temperature chamber at $25\pm 5^{\circ}\text{C}$ and connected as for "Frequency Stability - Temperature Variation" test.
2. The power supply voltage to the EUT was varied from 85% to 115% of the nominal value measured at the input to the EUT.
3. The variation in frequency was measured for the worst case.

MEASUREMENT RESULTS

LIMIT, ppm = 0.1
LIMIT, Hz = 21

| <u>STV, %</u> | <u>Vdc</u> | <u>CHANGE IN FREQUENCY, Hz</u> | |
|---------------|------------|--------------------------------|---|
| 85 | 102.0 | 217.500080 | 8 |
| 100 | 120.0 | 217.500000 | 0 |
| 115 | 138.0 | 217.500090 | 9 |

SUPERVISED BY:

MORTON FLOM, P. Eng.

PAGE NO.

55.

CASTEL0016

NAME OF TEST:

Necessary Bandwidth and Emission Bandwidth

PARAGRAPH:

47 CFR 2.202(g)

MODULATION = 16K0

NECESSARY BANDWIDTH CALCULATION:

MAXIMUM MODULATION (M), kHz = 3

MAXIMUM DEVIATION (D), kHz = 5

CONSTANT FACTOR (K) = 1

NECESSARY BANDWIDTH (B_N), kHz = $(2 \times M) + (2 \times D \times K)$

= 16.0

SUPERVISED BY:

MORTON FLOM, P. Eng.

STATEMENT OF QUALIFICATIONS

EDUCATION:

1. B. ENG. in ENGINEERING PHYSICS, 1949, McGill University, Montreal, Canada.
2. Post Graduate Studies, McGill University & Sir George Williams University, Montreal.

PROFESSIONAL AFFILIATIONS:

1. ARIZONA SOCIETY OF PROFESSIONAL ENGINEERS (NSPE), #026 031 821.
2. ORDER OF ENGINEERS (QUEBEC) 1949. #4534.
3. ASSOCIATION OF PROFESSIONAL ENGINEERS, GEOPHYSICISTS & GEOLOGISTS OF ALBERTA #5916.
4. REGISTERED ENGINEERING CONSULTANT - GOVERNMENT OF CANADA, DEPARTMENT OF COMMUNICATIONS. Radio Equipment Approvals.
5. IEEE, Lifetime Member No. 0417204 (member since 1947).

EXPERIENCE:

1. Research/Development/Senior Project Engineer, R.C.A. LIMITED (4 years).
2. Owner/Chief Engineer of Electronics. Design/Manufacturing & Cable TV Companies (10 years).
3. CONSULTING ENGINEER (over 25 years).

MORTON FLOM, P. Eng.

TEST INSTRUMENTATION LIST

All equipment calibrated
within last 90 days

ADAPTER

HP X281 (Coaxial waveguide); HP S281; HP 85659 (Quasi peak)

AMPLIFIER

Pre-amp. HP 10885A (2-1300 MHz); HP 8447D, HP 8447E, HP 8449A

ANTENNA See end

ATTENUATOR

Kay 432D; Power, Sierra 661A-30; Narda 76610; Narda 4779-3, -6, -10 dB

AUDIO OSCILLATOR

HP 204D; AIEC DTC-1; Motorola S-1333B; HP 3312A; HP 8903A

BATTERY

Sears Diehard, Stock #4341

CAMERA

Oscilloscope, Tektronix CSA; Polaroid Impulse AF; Kodak DC-50

CAPACITOR

Feed-Thru, 10 μ F, Solar 6512-106R; Solar 7525-1

CLOSE FIELD PROBE

HP 11940A, 11941A, HP 11945A

COMPUTER

HP 332; HP Vectra 486/25VL; Various PC COMPATIBLES

CONVERTOR, Down

HP 117 10B

COUPLER

Narda 1080, Waveguide; HP S750E (Cross guide); Waveline 274/40; Solar 7415-3; Solar 7835-891 & -896

CURRENT PROBE

Solar 6741-1

DETECTOR

HP 8470B

DIGITAL MULTIMETER

HP 3476A w/H.F. Probe; Fluke 8030A-01; HP 3478A

DISTORTION ANALYZER

HP 334A; HP 8903A

ELECTRONIC COUNTER

HP 5383A; HP 5334B

FILTER

Cirqtel FHT/7-50-57/50-1A/1B (HP); Jerrold TLB-1; THB-1, Piezo 5064; Eagle TNF-I Series, Krohn-Hite 3202; Phelps-Dodge #PD-495-8; Newton #PD6000 Line Protector; 870-890 MHz (Lab Design); 900 MHz (Lab Design); Solar High-Pass s/n 882029

FREQ. DEV. METER

HP 8901A

FREQ. DOUBLER

HP 11721A

FREQUENCY METER

HP 537A; HP 536A

GENERATOR

Solar 6550-1 (power sweep); HP 8640B, GAW 1012, HP 8656A (signal); Solar 8282-1 (spike)

HUMIDITY CHAMBER

Embem Co FW30; Bowser 0

LIMITER, R.F.

HP 11867A; HP 11693A; HP 10509A

LISN

Singer 91221-1; Ailtech 94641-1 (50 μ H)

LOAD, POWER

Telewave TLW-25; Bird 8329

MILLIAMETER

HP 428B

MIXER

HP 10514A; Mini-Circuits TAK-1H

OPEN FIELD SITE

As filed with FCC & IC and kept up-dated.

TURNTABLES:

Up to 2000# capacity

GROUND SCREEN:

Complies with docket 80-284

ANTENNA MAST:

Complies as above

OSCILLOSCOPE

HP 1741A; HP 181T; Tektronix T935; HP 54502A

PHANTOM

M.F.A. Labs Left and Right human head

PLOTTER

HP 7470; HP7475A

POWER METER

AF GR 1840A; HP 435A with 8481A & 8482H Power Sensors; HP 436A; HP 8901A

POWER SUPPLY

HP 6286A; Heathkit 1P 2711; 1P 5220; Honda EM400 (portable gas gen.); HP 6012

PRINTER

Brother HL-8; Brother HL-10V; HP DeskJet 640C

R. F. PRESELECTOR

HP 85685A

RADIATION METER

Narda 8717 w/8010 Amp, 8021B and 8760 probes

RESISTOR, PRECISION

Solar 7144-1.0, 7144-10.0; Solar 8525-1

SCALE

Weigh-Tronix 3632T-50

SCANNER

HP 9190A Scanjet

SCREEN ROOM

Lindgren 22-2/2-0

SIGNAL LEVEL METER

Jerrold 704B

SIGNAL SAMPLER

R. F. Bird 4273-030, 4275-030

SINAD/VOLTMETER

Helper Sinadder

SPECTRUM ANALYZER

HP 8558B, 8557; HP 8563E; HP 853A; HP 8566B/8568B

TEMPERATURE CHAMBER

Tenney, Jr

TEMPERATURE PROBE

Fluke 80T-150C

TERMINATION

Narda 320B Waveguide. Waveline #281

TEST SET

Semi-Automatic: HP 8953A; HP 8954A Interface; Computer / Controller; P.S. Programmer; HP 59501A; RF Communications: HP 8920A

TRANSFORMERS

Audio Isolation: Solar 6220-1A; Impedance: HP 11694A; Isolation: Solar 7032-1; Matching: Solar 7033-1

TRANSMISSION & NOISE MEASURING SET

HP 3555B

VIBRATION CHAMBER

Unholtz-Dickie T 500; Unholtz-Dickie T 4000

VOLTMETER

HP 410C; HP 3478A

WATTMETER

Bird 43, Sierra 174A-2

ANTENNAS

30 - 50 Hz

Emco 7603 M-Field; Emco 7604 M-Field

20 - 200 MHz

Aprel Biconical Model AAB20200

20 - 300 MHz

Emco Biconical H-Field

25 - 1000 MHz

Singer DM-105A; EMCO 3121C

200 - 1000 MHz

Aprel Log Periodic, Model AALP 2001

10 kHz - 30 MHz

Emco 3107B, E-Field; Emco 3101B/1, Rod E-Field

10 kHz - 32 MHz

Singer 94593-1 (Loop)

150 kHz - 32 MHz

Singer 92197-1 (41")

150 kHz - 32 MHz

Singer 93049-1 (9')

1 - 10 GHz

Singer 90794-A Discone

1 - 18 GHz

Horn: Aprel Model AAH-118

18 - 40 GHz

Emco 3116, Horn

40 - 60 GHz

Horn: HP 11970U, HP 11971U,

HP 11975A (Lo Drive

Amplifier)

50 - 75 GHz

Mixer, HP 11970V, HP 11971V

75 - 110 GHz

Mixer, HP 11970W