

REV	DATE	BY	CHKD	APPD	DATE
1A	ORIGINAL				
AMENDMENTS					
1A	DAVES				
2A	DAVES				
3A	DAVES				

LOW POWER TEMP CONTROL

POWER CONTROL

RF PIN SWITCH

EXCITER

TAIT ELECTRONICS

7856TX
EXCITER

220-01597-01
REV. 1
2 SQ. 3

PROJECT 1858 THE NAME FILE DATE WORKERS
DAVES 1979 01A 27-10-97 10

445

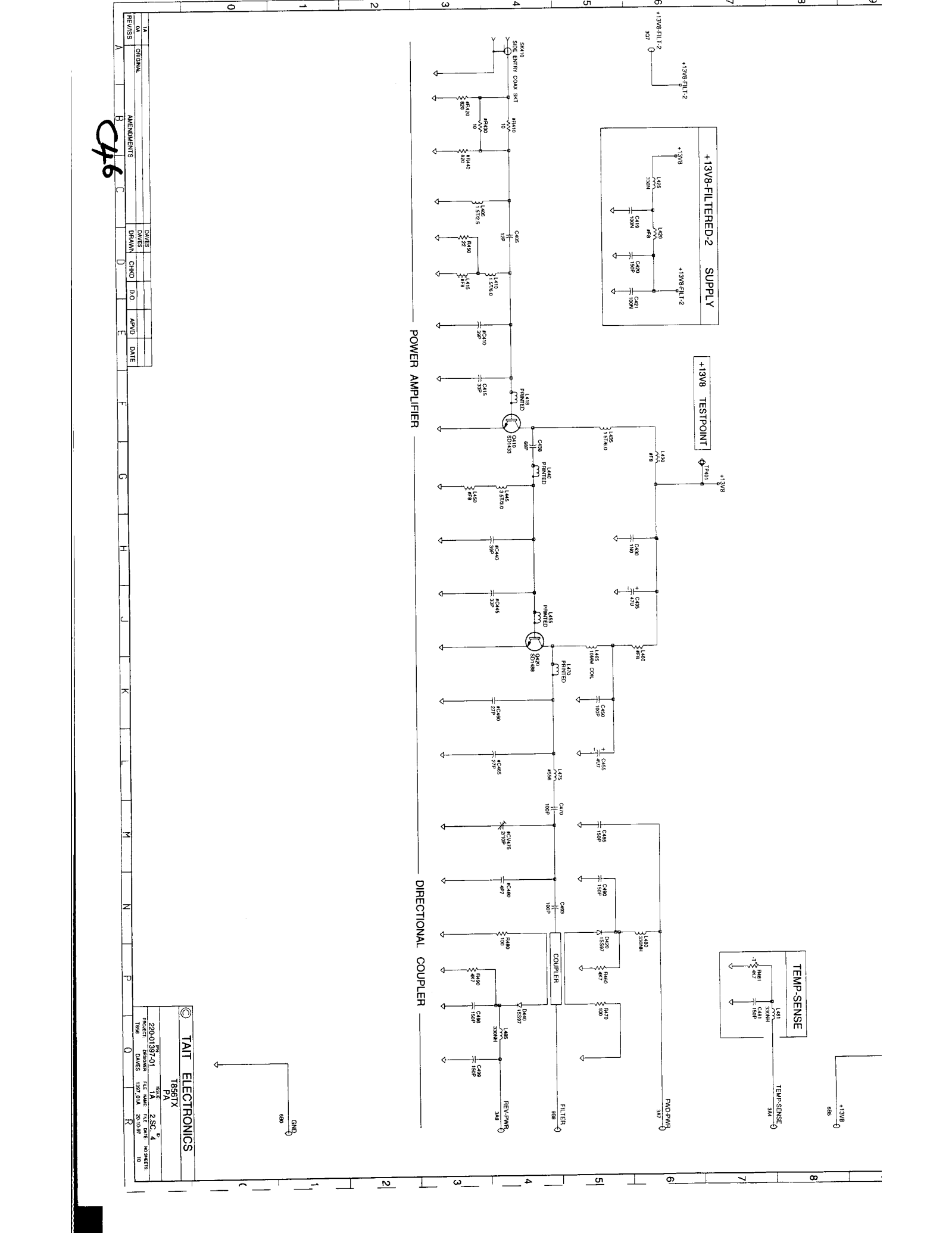

476

REV	DATE	BY	CHKD	DO	APVD	DATE
1A	ORIGINAL					
B	AMENDMENTS					
C						
D						
E						
F						
G						
H						
J						
K						
M						
N						
P						
R						

TAIT ELECTRONICS
 1896TX PA
 220-01597-01
 2 SC
 1896 DAVES 197.01A 20-10-97 10

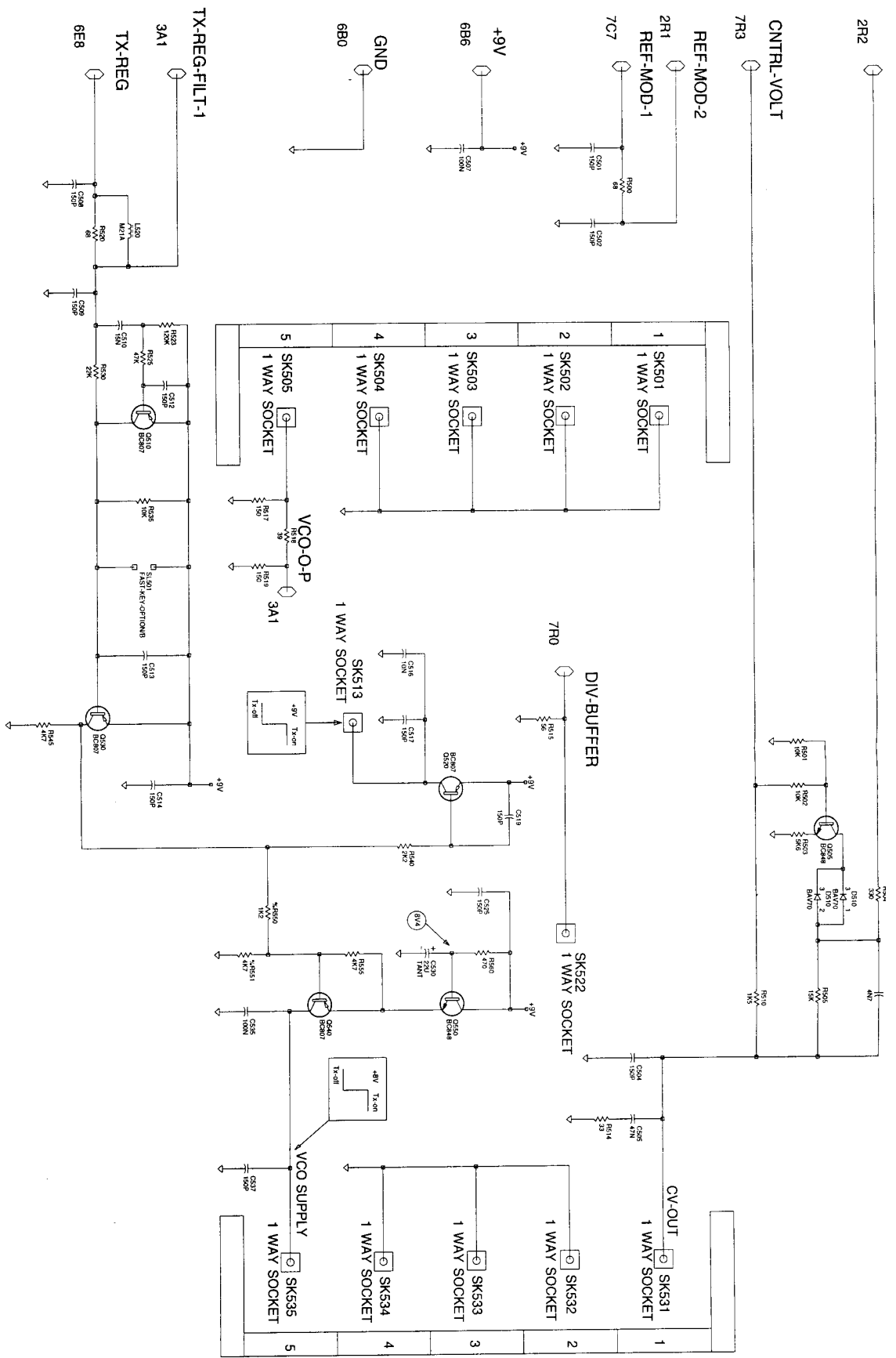

REV	BY	CHKD	DATE
1A	DAVES	DAVES	
1B	DAVES	DAVES	
1C	DAVES	DAVES	
1D	DAVES	DAVES	
1E	DAVES	DAVES	
1F	DAVES	DAVES	
1G	DAVES	DAVES	
1H	DAVES	DAVES	
1I	DAVES	DAVES	
1J	DAVES	DAVES	
1K	DAVES	DAVES	
1L	DAVES	DAVES	
1M	DAVES	DAVES	
1N	DAVES	DAVES	
1O	DAVES	DAVES	
1P	DAVES	DAVES	
1Q	DAVES	DAVES	
1R	DAVES	DAVES	

TAIT ELECTRONICS
 T966TY
 VCO-SUB-ASSY
 220-01997-01
 1A 2 SC 5
 1898 DAVES 1387 014 20-10-67

417

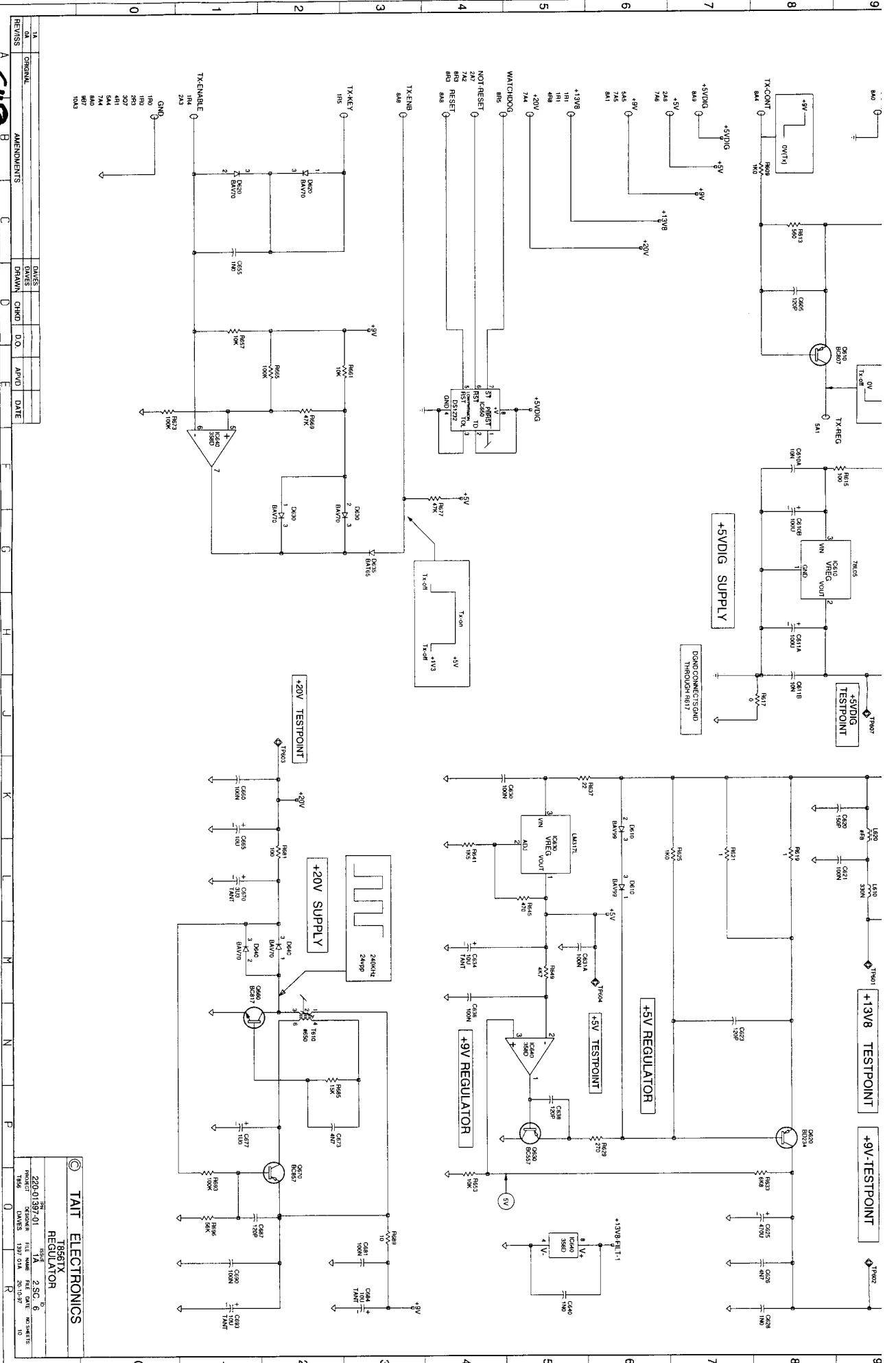

418

1A	ORIGINAL	DAVES	DAVES	CHMD	D.O.	APVD	DATE
REVISED	AMENDMENTS	DRAWN	DO				

TAT ELECTRONICS
 1856TX
 REGULATOR
 220-01397-01
 1A 2 SC 6
 PROJECT NUMBER FILE NAME FILE DATE WORKSHEET
 1856 DAVES 1397 516 03/97 10

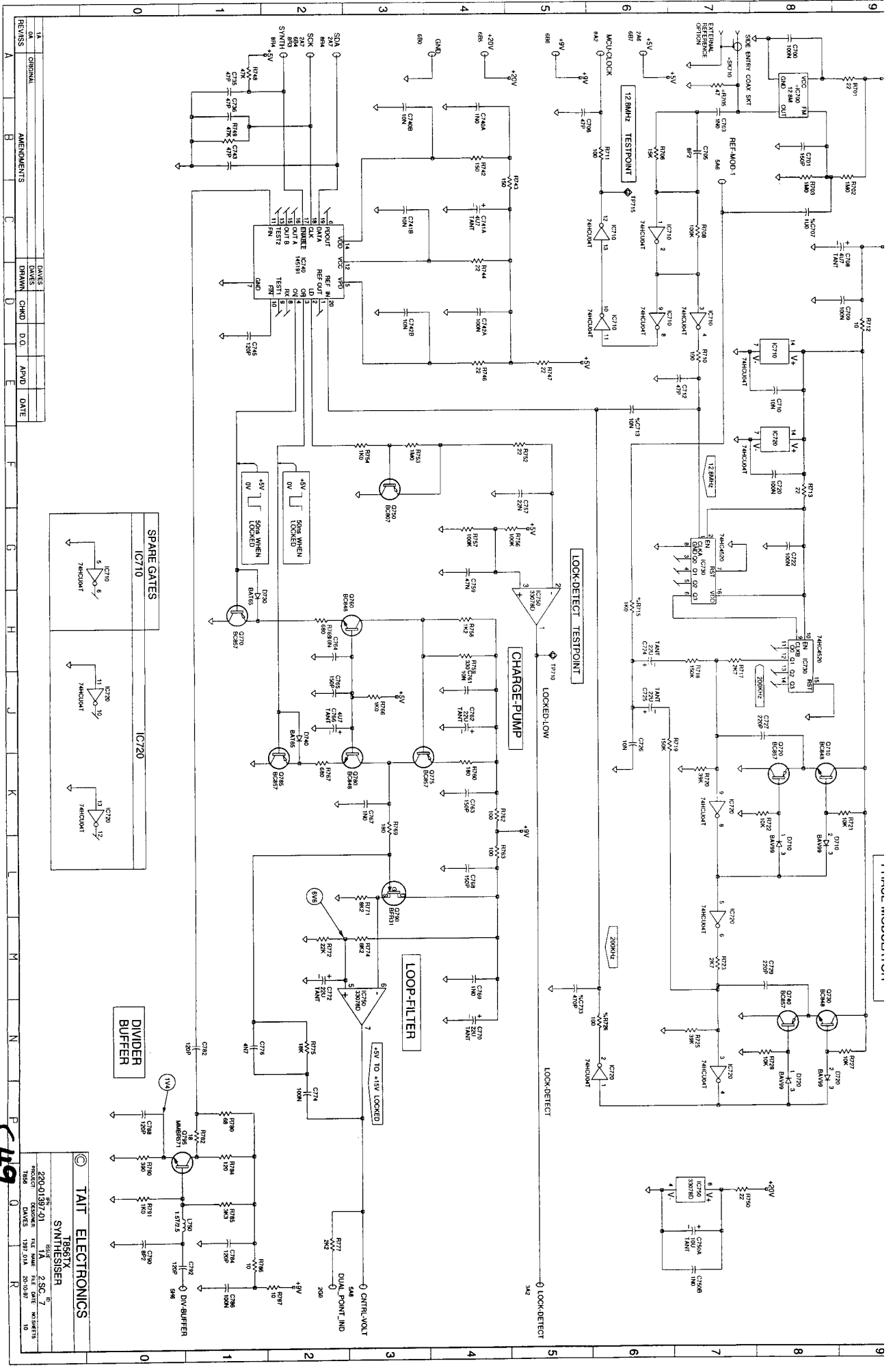

REV	DATE	BY	CHKD	DATE
1A	ORIGINAL	DAVES	DAVIS	
2	AMENDMENTS	DAVES	CHND	
3	AMENDMENTS	DAVES	D.O.	
4	AMENDMENTS	DAVES	APVD	

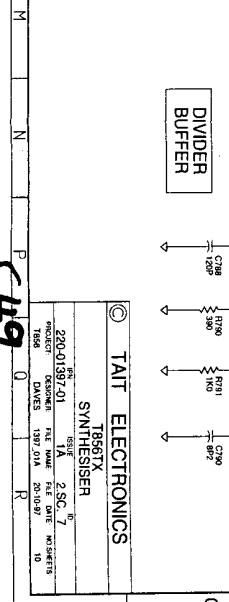
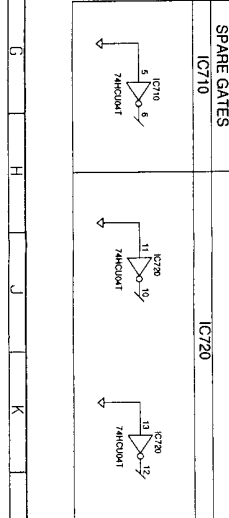

TAIT ELECTRONICS

19887K
SYNTHESIZER

220-01397-01 1A 2 SC 7

INSTRUMENT ENGINEER FILE NAME REF DATE WORKSHEET
 1000 1000 DAVES 1988 01 10

c49

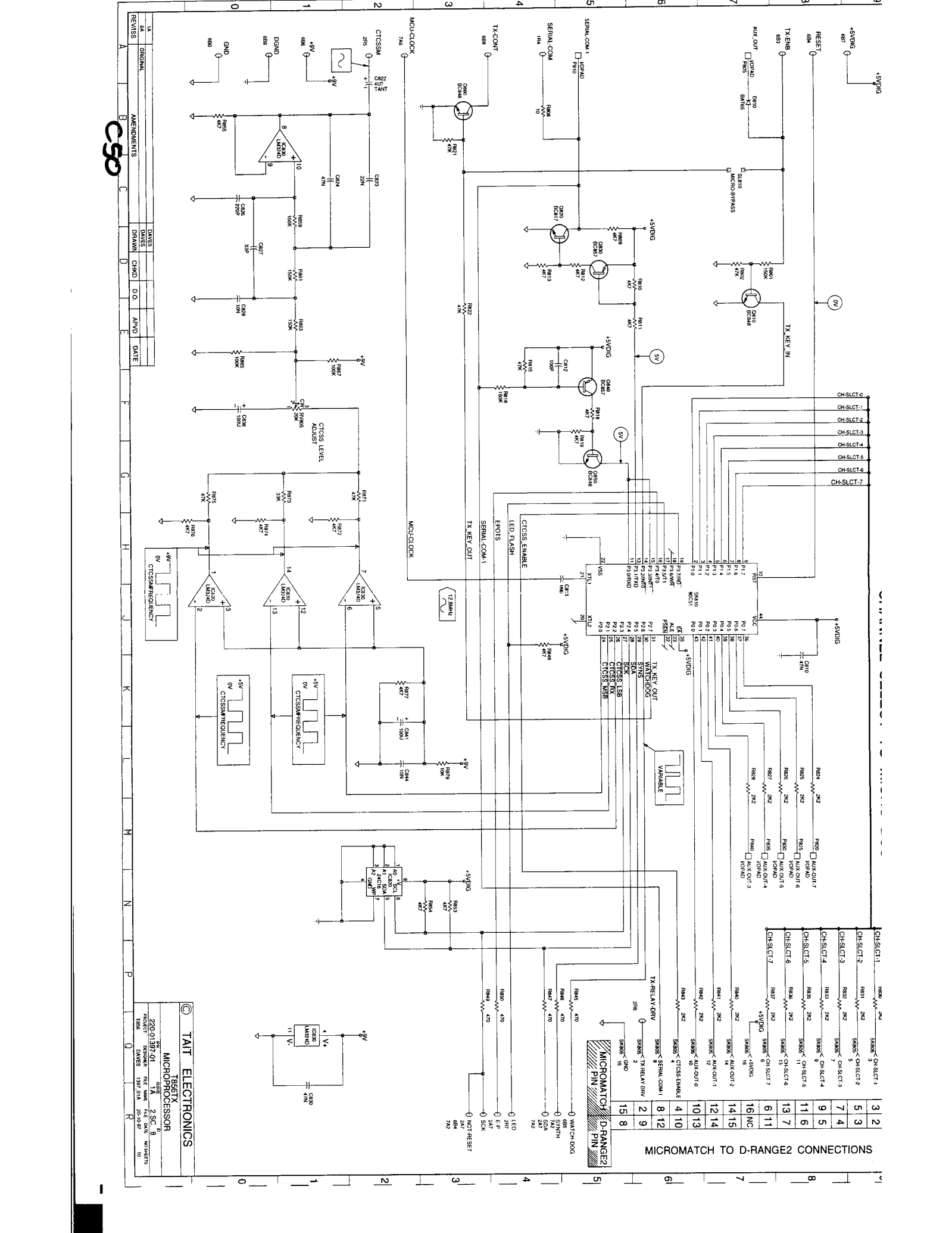

0 1 2 3 4 5 6 7 8 9

1A	ORIGINAL	CHANGES	APPROVED	DATE
REVISIONS	AMENDMENTS	DESIGN	CHKD	DATE

CSO

TAIT ELECTRONICS
 TMS86TX MICROPROCESSOR
 220 OLSON DRIVE
 FREDERICK, MARYLAND 21701
 PHONE: (301) 441-1100
 FAX: (301) 441-1101
 DAVES 1987 Q1A 25-10-87

MICROMATCH TO D-RANGE2 CONNECTIONS

CH-SLCT-1	3 2
CH-SLCT-2	5 3
CH-SLCT-3	7 4
CH-SLCT-4	9 5
CH-SLCT-5	11 6
CH-SLCT-6	13 7
CH-SLCT-7	6 11
16 NC	
14 15	
12 14	
10 13	
8 12	
2 9	
15 8	

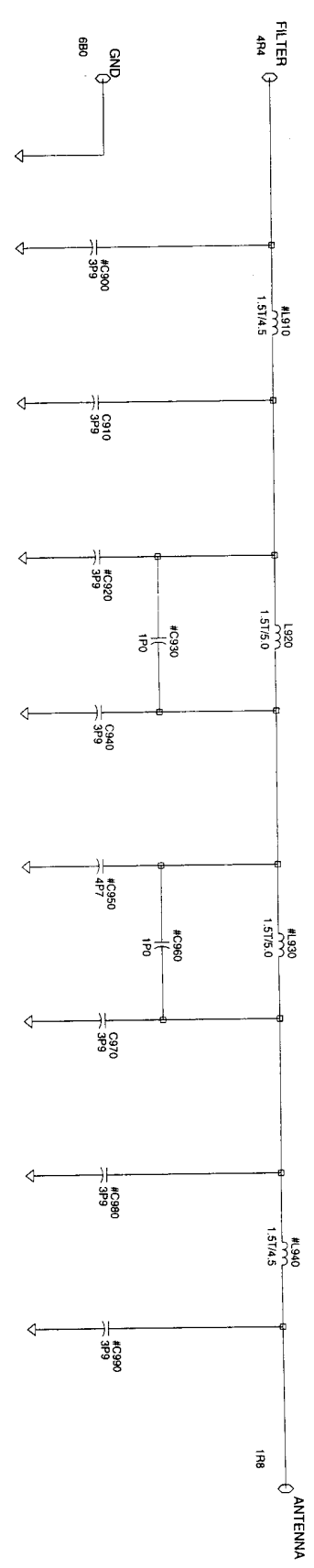

HARMONIC-FILTER

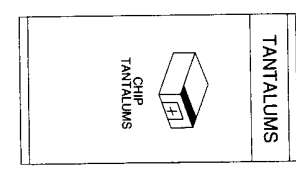
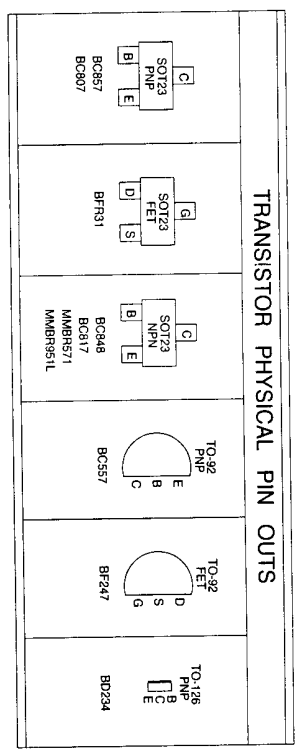
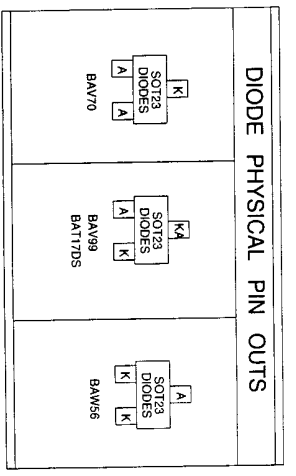

1A	ORIGINAL	DAVES																		
0A		DAVES																		
REVISIONS	A	AMENDMENTS	B	C	D	E	F	G	H	J	K									
		DRAWN	CHKD	D.O.	APVD	DATE														

TAIT ELECTRONICS

 1856TX

 HARMONIC-FILTER

 PROJECT: 220-01397-01

 ISSUE: 1A

 FILE NAME: 1397_1A

 FILE DATE: 25/10/97

 DRAFTER: DAVES

 DATE: 25/10/97

 NO SHEETS: 10

 SHEET NO: 10

CSI

TOP SIDE PRODUCT INDICATORS								
-10	-13	-15	-20	-23	-25	-30	-35	-

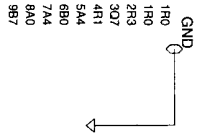
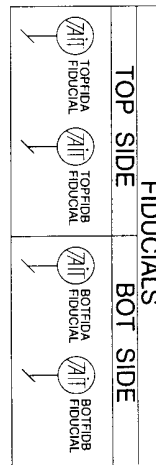
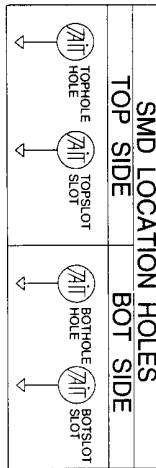

1A	REVISED	DAVES	CHKD	D.O.	APVD	DATE
A	AMENDMENTS	DRAWN	D		E	

C52

© TAIT ELECTRONICS
 T8561TX
 OUT OF CIRCUIT DATA
 PROJECT: 220-01397-01
 DESIGNER: DAVES
 FILE NAME: 1397_01A
 FILE DATE: 20-10-97
 NO SHEETS: 10

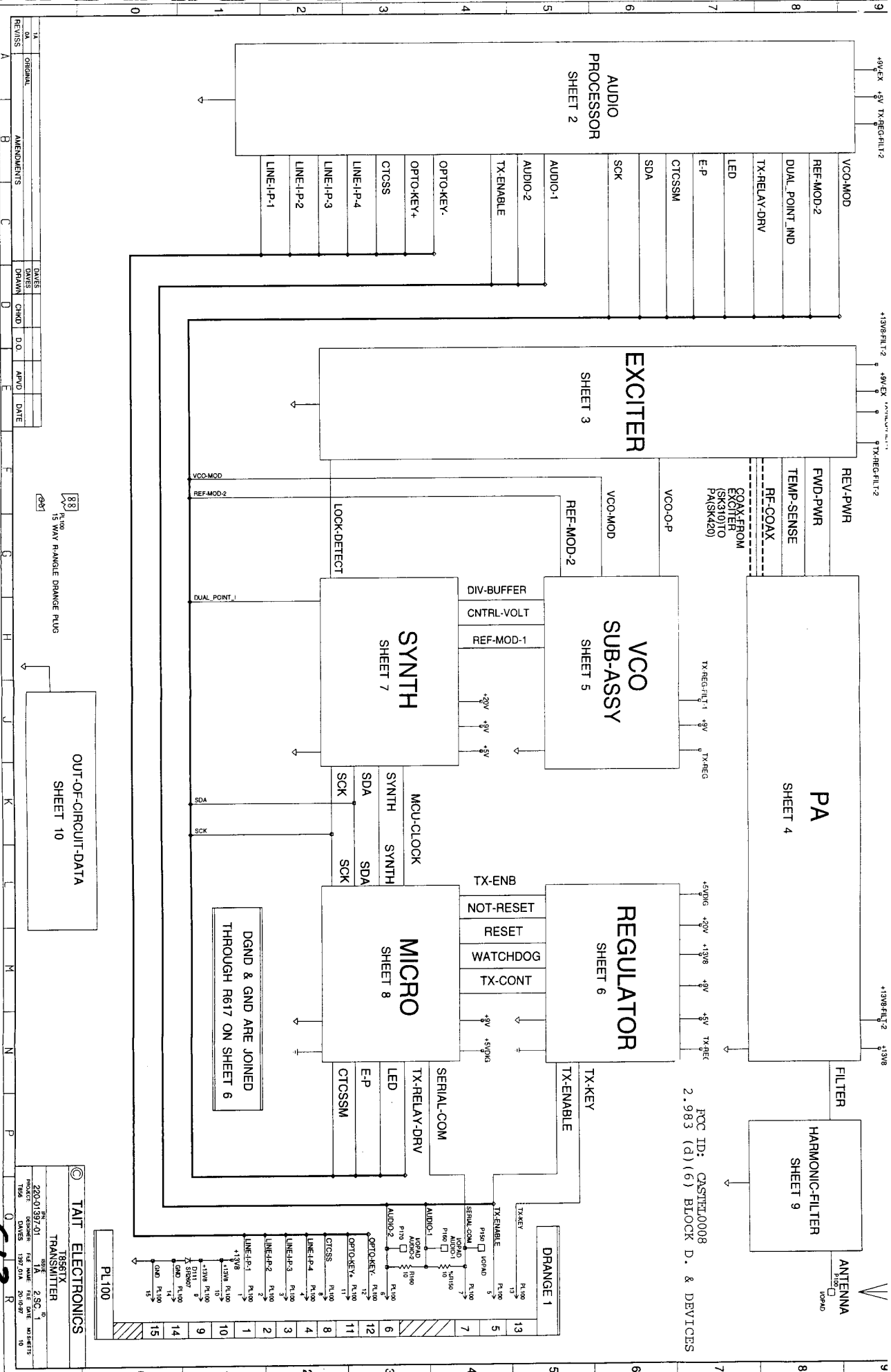

REV	DATE	BY	CHKD	APPD	DATE
01	08/01/01	DAVES	CHMD		
02	08/01/01	DAVES	CHMD		
03	08/01/01	DAVES	CHMD		
04	08/01/01	DAVES	CHMD		
05	08/01/01	DAVES	CHMD		
06	08/01/01	DAVES	CHMD		
07	08/01/01	DAVES	CHMD		
08	08/01/01	DAVES	CHMD		
09	08/01/01	DAVES	CHMD		
10	08/01/01	DAVES	CHMD		

888 15 WAY RANGE DRANGE PLUG
 8981

OUT-OF-CIRCUIT-DATA
 SHEET 10

TAT ELECTRONICS
 18887X
 TRANSMITTER
 PROJECT 220-01397-01 TA 2 SC 1
 DATE 08/01/01
 DRAWN BY DAVES
 CHECKED BY CHMD
 APPROVED BY

C43

FCC ID: CASTEL0008
 2.983 (d) (6) BLOCK D. & DEVICES

CH4

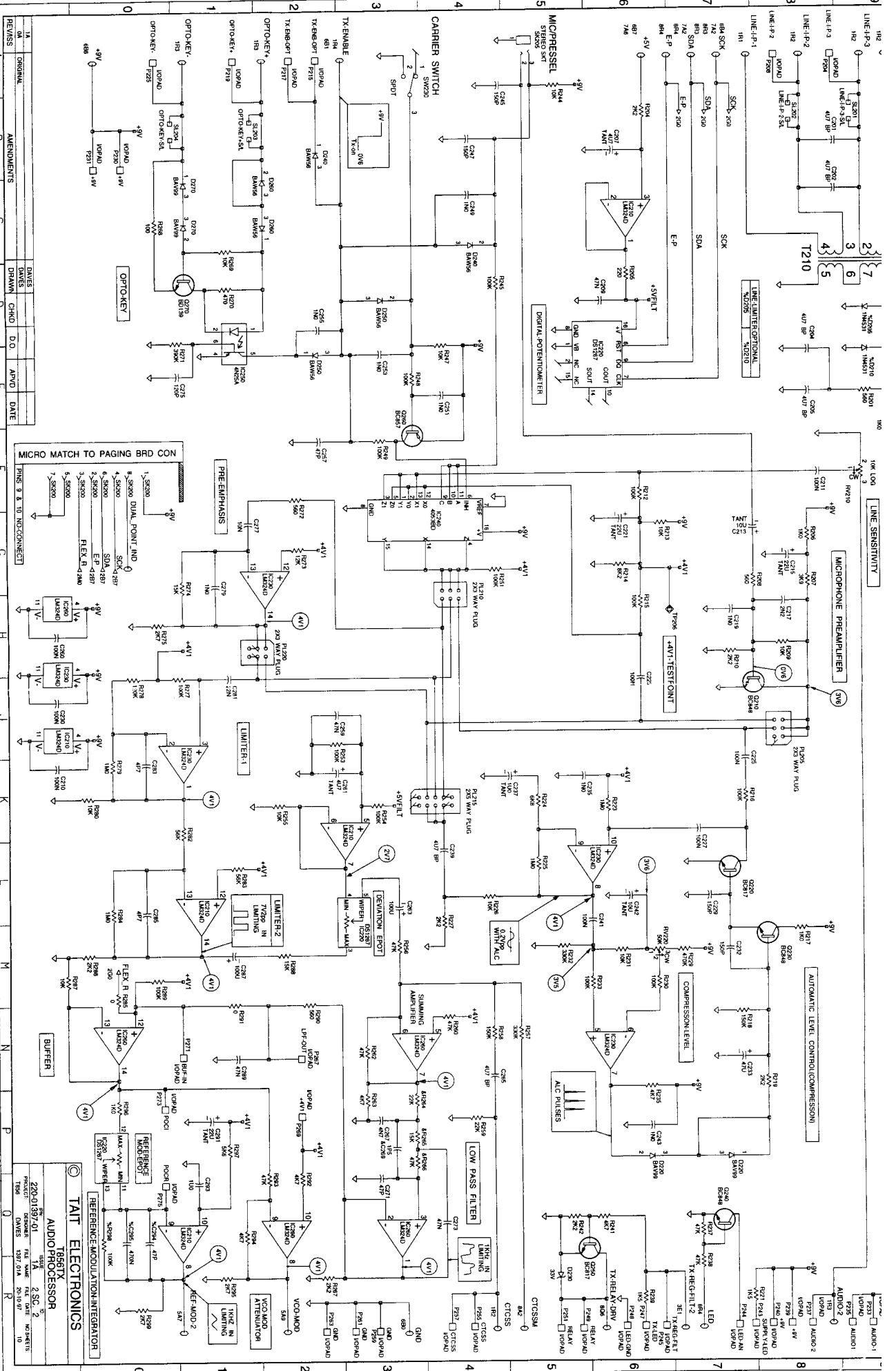

REV	DATE	BY	CHKD	APP'D	DATE
1A	01	ORIGINAL			
REVIEWS					
AMENDMENTS			DRAWS		

MICRO MATCH TO PAGING BRD CON
 PINS 9 & 10 DISCONNECTED

TAIT ELECTRONICS
1856TX
AUDIO PROCESSOR

22001897/01
 2 SC 15
 1898
 DAVES 1387 014 20-10-97