

LABORATORY TEST REPORT
RADIO PERFORMANCE MEASUREMENTS

for the

TBCHHA BASE STATION Transceiver

Tested in accordance with:

FCC 47 CFR Parts 22 and 90

RSS-119 Issue 12
RSS-Gen Issue 4

Report Revision:

1

Issue Date:

20 April 2018

PREPARED BY:

Alfred Schinkelshoek

Test Technician

CHECKED & APPROVED BY:

M. C. James

Laboratory Technical Manager



IANZ
ACCREDITED LABORATORY

FCC REGISTRATION: 838288
IC LISTING REGISTRATION: SITE# 737A-1

All tests reported herein have been performed in accordance with the laboratory's scope of accreditation.

This document must not be reproduced except in full, without the written permission of the Compliance Laboratory Manager

TELTEST Laboratories (A Division of Tait Communications)
PO Box 1645, 558 Wairakei Road, Christchurch, New Zealand.

FCC ID: CASTBCHHA
IC : 737A-TBCHHA

Page 1 of 52

Telephone: 64 3 358 3399
FAX: 64 3 359 4632

Report Revision: 1
Issue Date: 20 April 2018

TABLE OF CONTENTS

REVISION.....	3
INTRODUCTION	4
STATEMENT OF COMPLIANCE.....	5
MODULATION TYPES, NECESSARY BANDWIDTH & EMISSION DESIGNATORS	6
TEST RESULTS	8
TRANSMITTER OUTPUT POWER (CONDUCTED).....	8
TRANSMITTER AUDIO FREQUENCY RESPONSE - PRE-EMPHASIS	9
TRANSMITTER MODULATION LIMITING.....	11
TRANSMITTER OCCUPIED BANDWIDTH AND SPECTRUM MASKS	13
TRANSMITTER SPURIOUS EMISSIONS (CONDUCTED)	26
TRANSMITTER SPURIOUS EMISSIONS (RADIATED).....	34
TRANSIENT FREQUENCY BEHAVIOR	38
TRANSMITTER FREQUENCY STABILITY - TEMPERATURE	45
TRANSMITTER FREQUENCY STABILITY - VOLTAGE.....	47
RECEIVER SPURIOUS EMISSIONS (CONDUCTED)	48
TRANSMITTER STANDBY SPURIOUS EMISSIONS (CONDUCTED)	49
TEST EQUIPMENT LIST	50
ANNEX A – TEST SETUP DETAILS	52

REVISION

Date	Revision	Comments
20 April 2018	1	Initial test report

INTRODUCTION

Type approval testing of the TBCHHA, 50 Watt, BASE STATION transceiver in order to demonstrate compliance with FCC 47 Parts 22 & 90, and RSS-119 Issue 12 & RSS-Gen Issue 4. This radio supports analogue, APCO P25 phase-1 and APCO P25 phase-2 modulations.

Type Approval Testing of the TB9415HH
Frequency range 378 → 420 MHz

REPORT PREPARED FOR

Tait Limited
245 Wooldridge Road
Harewood
Christchurch 8051
New Zealand

DESCRIPTION OF SAMPLE

Manufacturer Tait Limited
Equipment: BASE STATION Transceiver
Type: TBCHHA
Product Code: TB9415HH00000A4BA
Quantity: 1

Modulation		Channel Spacing	Speech Channels	Symbol Rate (symbols/sec)	Data Rate (bps)
Analogue FM		12.5 kHz	1	-	-
APCO P25 Phase 1	C4FM (TIA 102)	12.5 kHz	1	4800	9600
APCO P25 Phase 1 Linear Simulcast Modulation	CQPSK (TIA 102)	12.5 kHz	1	4800	9600
APCO P25 Phase 2	H-DQPSK(2 slot TDMA) (TIA 102)	12.5 kHz	2	6000	12000

HARDWARE & SOFTWARE

Quantity: 1

Description	Product Code	Serial Number	Firmware Version	Hardware Version
Reciter 378-420 MHz	T01-01103-JAAA	18274593	p25-2.45.00.0004	01.00
Power Amplifier	T01-01121-JAAA	18274594	1.09.00.0002	0.06
Power Management Unit	TBA30A0-0100	18252210	0316	01.00
Front Panel	T01-01110-BACA	18275027	1.09.00.0002	00.04

TEST CONDITIONS

All testing was performed between 6 March → 20 April 2018, and under the following conditions:

Ambient temperature: 15°C → 30°C
Relative Humidity: 20% → 75%
Standard Test Voltage 120 V_{AC}

STATEMENT OF COMPLIANCE

We, TELTEST LABORATORIES of 558 Wairakei Road, Christchurch, New Zealand, declare under our sole responsibility that the product:

Equipment: BASE STATION Transceiver
Type: TBCHHA
Product Code: TB9415HH00000A4BA
Quantity: 1

to which this declaration relates, is in conformity with the following standards:

FCC 47 CFR Parts 22 and 90

RSS-119 Issue 12 & RSS-Gen Issue 4

Signature: 

Mike James
Technical Manager

Date: 3 May 2018

MODULATION TYPES, NECESSARY BANDWIDTH & EMISSION DESIGNATORS

MODULATION TYPES:

F3E	Analogue Frequency Modulation (FM)	
F1E	P25 phase 1 Digital Voice	9600 bps
F1D	P25 phase 1 Digital Data	9600 bps
F7W	P25 phase 1 Digital Voice/Data	9600 bps
D1W	P25 Phase 1 Linear Simulcast Modulation Digital Voice	9600 bps
F7W	P25 phase 2 Digital Voice / Data	12000 bps

CHANNEL SPACING: 12.5 kHz

EMISSION DESIGNATORS:

	12.5 kHz
Analog FM	11K0F3E
Digital Voice P25 phase 1	8K10F1E
Digital Data P25 phase 1	8K10F1D
Digital Voice/Data phase 1	8K10F7W
Digital Voice P25 phase 1 LSM	8K70D1W
Digital Voice/Data P25 phase 1 LSM	8K70D7W
Digital Voice/Data P25 phase 2	9K80D7W

CALCULATIONS

Equation: $B_n = 2M + 2Dk$

(M is highest modulating frequency; D is peak allowable deviation; k is a constant of 1 for FM)

Analogue Voice 12.5 kHz Channel Spacing

Necessary bandwidth

M = 3.0 kHz

D = 2.5 kHz

$$B_n = (2 \times 3.0) + (2 \times 2.5) \times 1$$

$$= 11.0 \text{ kHz}$$

Emission Designator

11K0F3E

F3E represents an FM voice transmission

APCO P25 Phase 1:

Digital Voice / Data (C4FM - 4 level frequency shift keying)

Digital Voice/data transmissions use a 4 level frequency shift keying modulation scheme.

The necessary bandwidth has been measured using the 99% energy rule, and in accordance with FCC KDB 971168 D01 and RSS-Gen 4.6.1.

Digital Voice 12.5 kHz Channel Spacing

99% bandwidth

= 8.1 kHz

Emission Designator

8K10F1E

F1E represents a digital FM voice transmission

Digital Data 12.5 kHz Channel Spacing

99% bandwidth

= 8.1 kHz

Emission Designator

8K10F1D

F1D represents a digital FM data transmission

Digital Voice and Data 12.5 kHz Channel Spacing

99% bandwidth

= 8.1 kHz

Emission Designator

8K10F7W

F7W represents a digital FM transmission containing both voice and data.

Linear Simulcast Modulation (LSM):

Digital Voice/data transmissions use a CQPSK modulation scheme.
The necessary bandwidth has been measured using the 99% energy rule, and in accordance with FCC KDB 971168 D01 and RSS-Gen 4.6.1.

CQPSK Digital Data 12.5 kHz Bandwidth

99% bandwidth
= 8.7 kHz

Emission Designator
8K70D1W

D1W represents a single channel containing quantized or digital information combining two modulation modes simultaneously (amplitude + angle) for a voice transmission.

CQPSK Digital Data 12.5 kHz Bandwidth

99% bandwidth
= 8.7 kHz

Emission Designator
8K70D7W

D7W represents a single channel containing quantized or digital information combining two modulation modes simultaneously (amplitude + angle) for a transmission containing both voice and data.

APCO P25 Phase 2:

Digital Voice/data transmissions use a differential phase shift keying modulation scheme.
The necessary bandwidth has been measured using the 99% energy rule, and in accordance with FCC KDB 971168 D01 and RSS-Gen 4.6.1.

H-DQPSK Digital Data 12.5 kHz Bandwidth

99% bandwidth
= 9.8 kHz

Emission Designator
9K80D7W

D7W represents two or more channels containing quantized or digital information combining of two modulation modes simultaneously (amplitude + angle) for a data/telephony combination.

TEST RESULTS

TRANSMITTER OUTPUT POWER (CONDUCTED)

SPECIFICATION: FCC 47 CFR 2.1046
RSS-119 5.4

GUIDE: TIA-102.CAAA-C 2.2.1

MEASUREMENT PROCEDURE:

1. Refer Annex A for Equipment set up.
2. The coaxial attenuator has an impedance of 50 Ohms.
3. The unmodulated output power was measured with an RF Power meter.

MEASUREMENT RESULTS:

Manufacturer's Rated Output Power:

Switchable: 50 W and 5 W

Nominal 50 W	406.1 MHz	413.1 MHz	419.9 MHz
Measured	47.3	46.3	47.1
Variation (%)	-5.5	-7.4	-5.8
Variation (dB)	-0.2	-0.3	-0.3
Nominal 5 W	406.1 MHz	413.1 MHz	419.9 MHz
Measured	4.6	4.6	4.6
Variation (%)	-7.3	-8.6	-8.5
Variation (dB)	-0.3	-0.4	-0.4
Measurement Uncertainty	± 0.6 dB		

LIMIT CLAUSES:

FCC 47 CFR 90.205 (s)

The output power shall not exceed by more than 20%... the manufacturer's rated output power for the particular transmitter specifically listed on the authorization.

RSS-119 5.4

The output power shall be within ±1.0 dB of the manufacturer's rated power.

TRANSMITTER AUDIO FREQUENCY RESPONSE - PRE-EMPHASIS

SPECIFICATION: FCC 47 CFR 2.1047 (a)

GUIDE: TIA/EIA-603E 2.2.6

MEASUREMENT PROCEDURE:

1. Refer Annex A for Equipment set up.
2. An audio input tone of 1000 Hz was applied with the level set to obtain 20% of maximum deviation. This was used as the 0 dB reference point.
3. The AF was varied while the audio level was held constant.
4. The response in dB relative to 1000 Hz was measured.

MEASUREMENT RESULTS:

See the plots on the following pages for 12.5 kHz channel spacing tested at 50 W transmit power.

LIMIT CLAUSE: TIA/EIA-603E 3.2.6

MEASUREMENT UNCERTAINTY: $\pm 1.5\%$

SPECIFICATION: FCC CFR 2.1047 (a)

Tx FREQUENCY: 406.1 MHz 12.5 kHz Channel Spacing

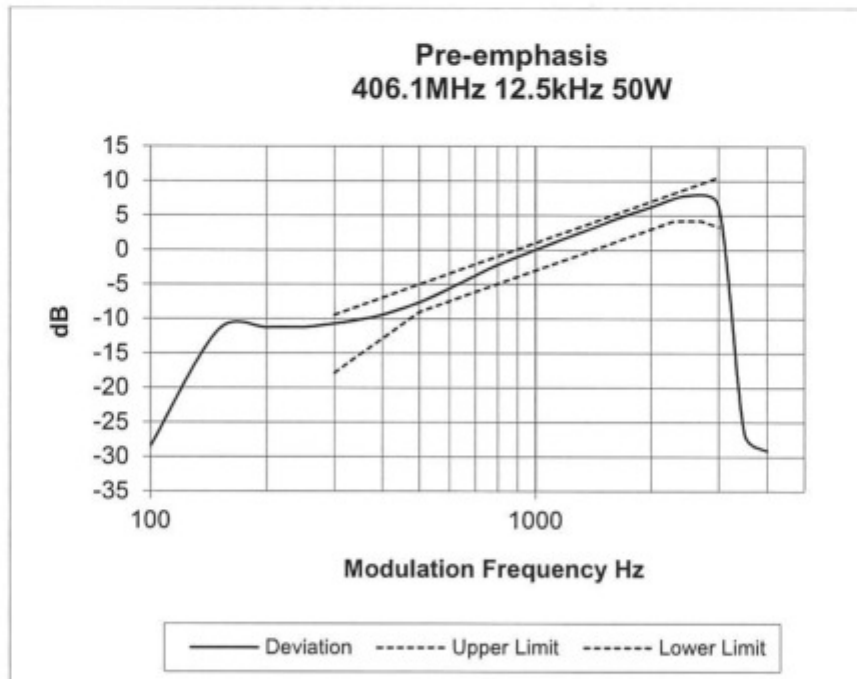

Transmitter Audio Frequency Response – Pre-emphasis

SPECIFICATION: FCC CFR 2.1047 (a)

Tx FREQUENCY: 413.1 MHz

12.5 kHz Channel Spacing

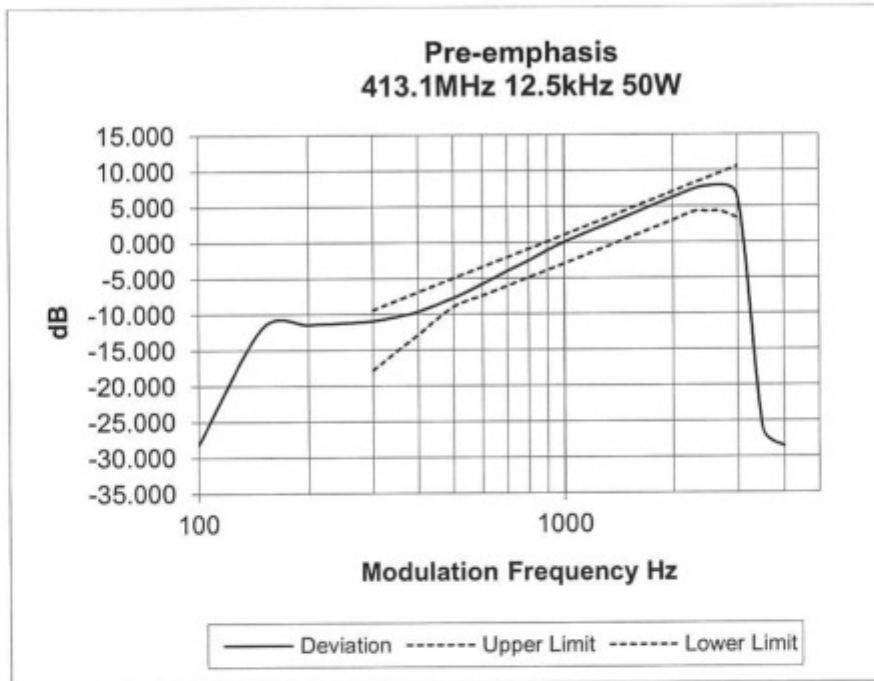

SPECIFICATION: FCC CFR 2.1047 (a)

Tx FREQUENCY: 419.9 MHz

12.5 kHz Channel Spacing

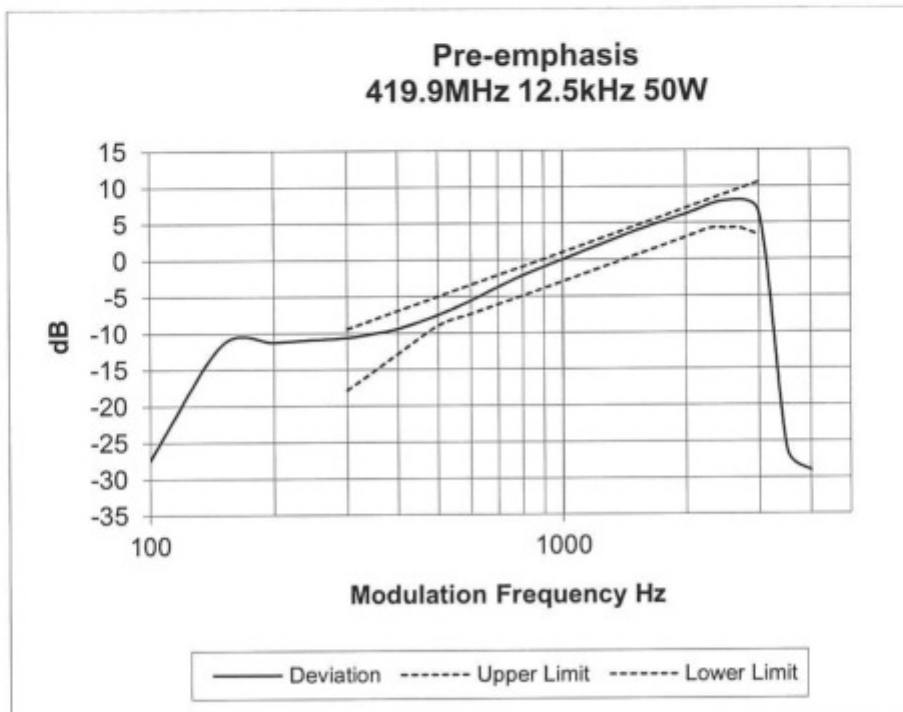

TRANSMITTER MODULATION LIMITING

SPECIFICATION: FCC 47 CFR 2.1047 (b)

GUIDE: TIA/EIA-603E 2.2.3

MEASUREMENT PROCEDURE:

1. Refer Annex A for Equipment set up.
2. The modulation response was measured at three audio frequencies while varying the input level.
3. Measurements were made for both Positive and Negative Deviation.

MEASUREMENT RESULTS:

See the plots on the following pages for 12.5 kHz channel spacing.

LIMIT CLAUSE: TIA/EIA-603E 1.3.4.4

MEASUREMENT UNCERTAINTY: $\pm 1.5\%$

Tx FREQUENCY: 406.1 MHz

12.5 kHz Channel Spacing

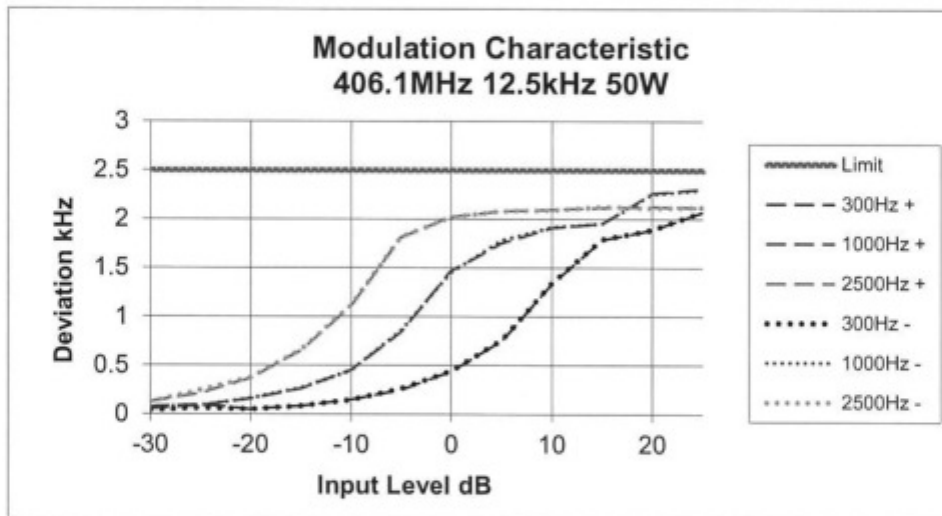

Transmitter Modulation Limiting

SPECIFICATION: FCC CFR 2.1047 (b)

Tx FREQUENCY: 413.1 MHz

12.5 kHz Channel Spacing

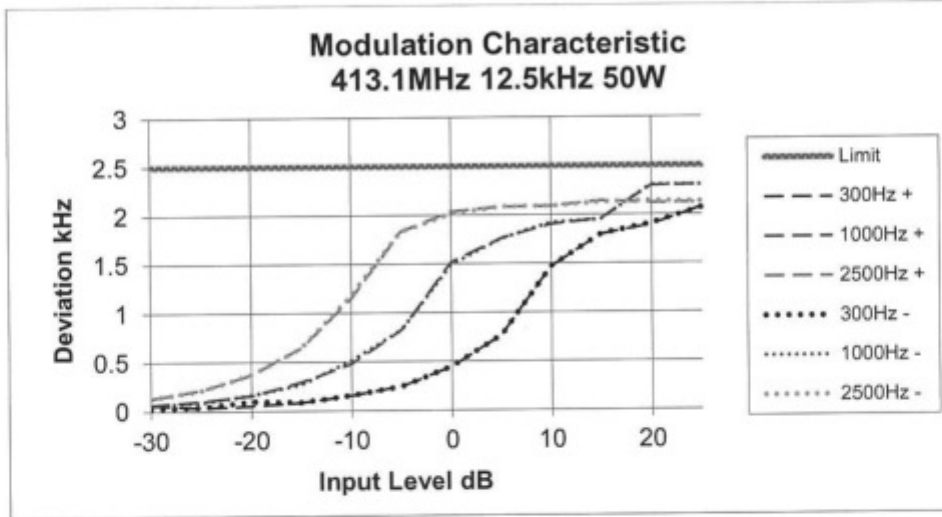

Transmitter Modulation Limiting

SPECIFICATION: FCC CFR 2.1047 (b)

Tx FREQUENCY: 419.9 MHz

12.5 kHz Channel Spacing

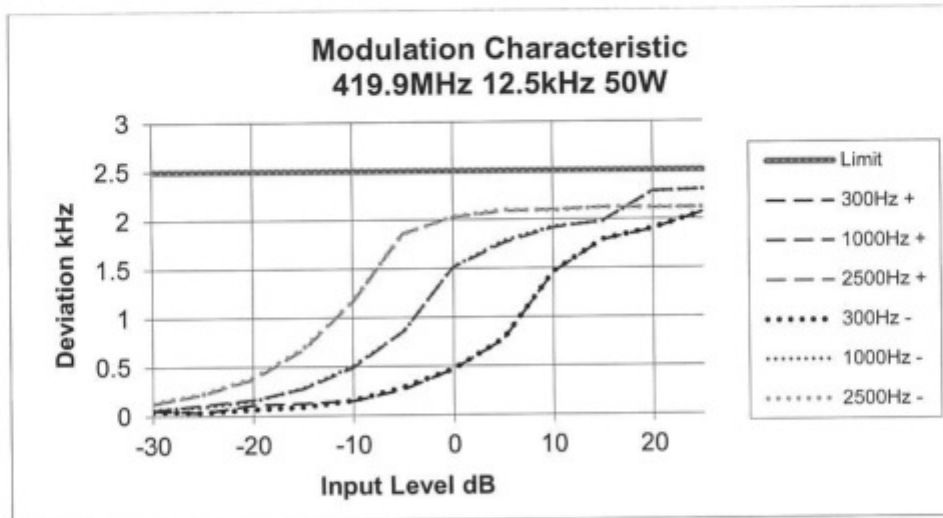

TRANSMITTER OCCUPIED BANDWIDTH AND SPECTRUM MASKS

SPECIFICATION: FCC 47 CFR 2.1049 (c) RSS-119 5.5

GUIDE: TIA/EIA-603E 2.2.11 (Analog)
TIA-102.CAAA-C 2.2.5 (Digital)

MEASUREMENT PROCEDURE:

1. Refer Annex A for Equipment Set up.
The EUT was modulated with an internally generated pseudo random bit sequence at the appropriate Baud rates.
2. The Occupied Bandwidth was measured on the Spectrum Analyser, with bandwidth settings as follows.
Emission Mask D – Resolution Bandwidth = 100 Hz, Video Bandwidth = 1 kHz

MEASUREMENT RESULTS:

See the plots on the following pages for 12.5 kHz channel spacing.

MEASUREMENT UNCERTAINTY 95% $\pm 0.65\text{dB}$

LIMIT CLAUSE: FCC 47 CFR 90.210 RSS-119 5.5

EMISSION MASKS

Emission Mask D 12.5 kHz Channel Spacing Analog, Digital Voice/Data

DATA SPEED

Digital Voice/Data 12.5 kHz Channel Spacing 9600 bps (P25 Phase I)
Digital Voice/Data 12.5 kHz Channel Spacing 12000 bps (P25 Phase II)

Occupied Bandwidth and Spectrum Masks

ANALOGUE VOICE

SPECIFICATION: FCC CFR 2.1049 (c)

RSS-119 5.5

Tx FREQUENCY: 406.1 MHz 50 W 12.5 kHz Channel Spacing

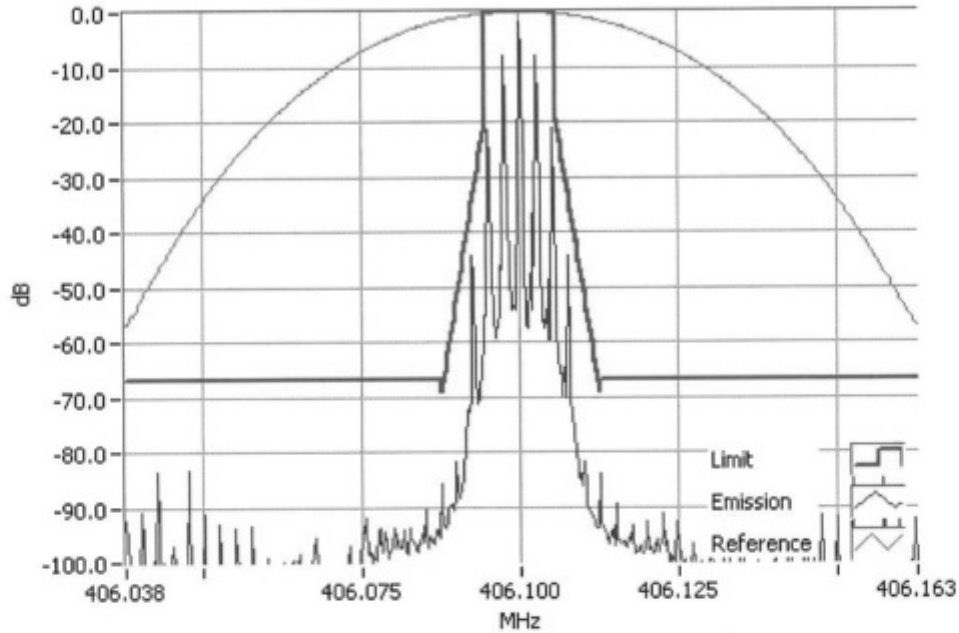

Analogue Modulation 406.1000MHz Mask D 50W
RBW=100Hz, VBW=1000Hz, Detector Mode=Peak
Result=Pass

Tx FREQUENCY: 406.1 MHz 5 W 12.5 kHz Channel Spacing

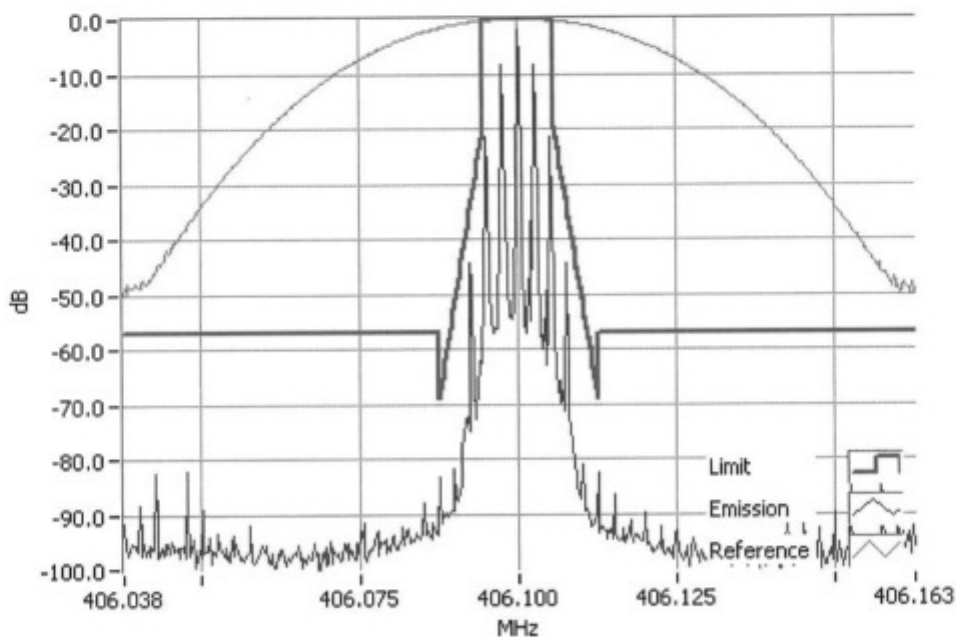

Analogue Modulation 406.1000MHz Mask D 5W
RBW=100Hz, VBW=1000Hz, Detector Mode=Peak
Result=Pass

Occupied Bandwidth and Spectrum Masks

ANALOGUE VOICE

SPECIFICATION: FCC CFR 2.1049 (c)

RSS-119 5.5

Tx FREQUENCY: 413.1 MHz 50 W 12.5 kHz Channel Spacing

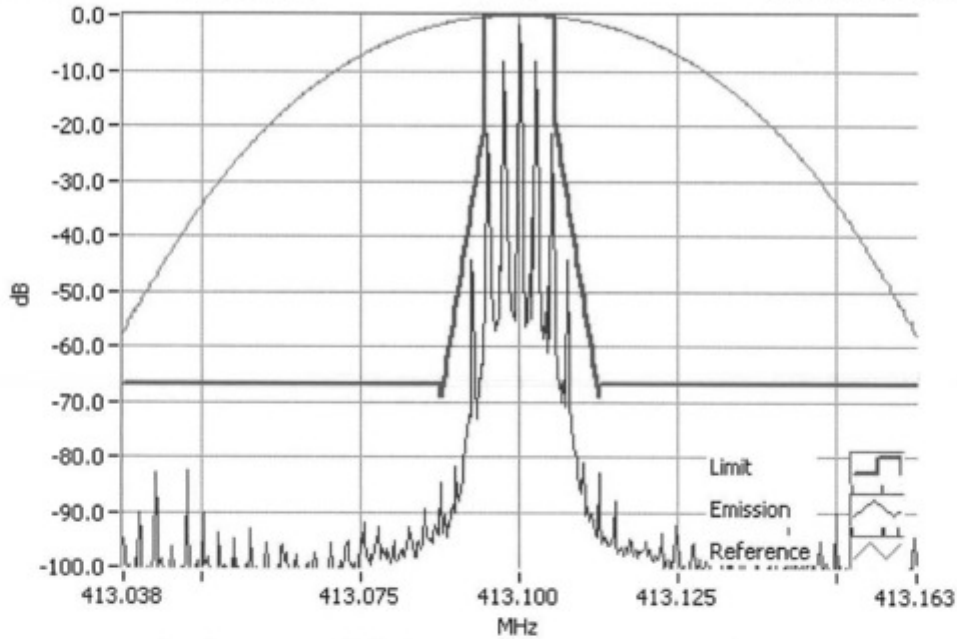

Analogue Modulation 413.1000MHz Mask D 50W
RBW=100Hz, VBW=1000Hz, Detector Mode=Peak
Result=Pass

Tx FREQUENCY: 413.1 MHz 5 W 12.5 kHz Channel Spacing

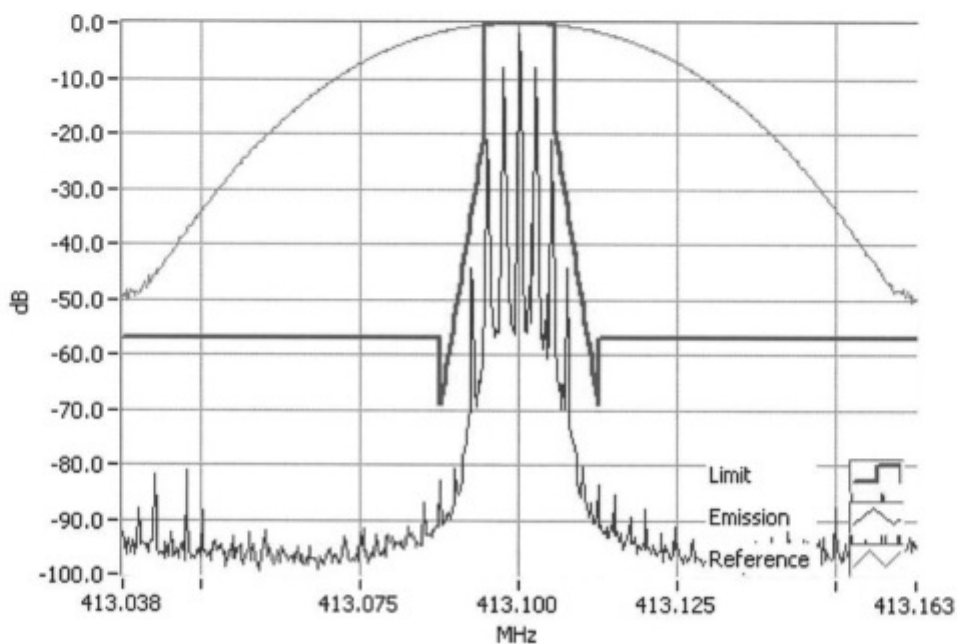

Analogue Modulation 413.1000MHz Mask D 5W
RBW=100Hz, VBW=1000Hz, Detector Mode=Peak
Result=Pass

Occupied Bandwidth and Spectrum Masks

ANALOGUE VOICE

SPECIFICATION: FCC CFR 2.1049 (c)

RSS-119 5.5

Tx FREQUENCY: 419.9 MHz 50 W 12.5 kHz Channel Spacing

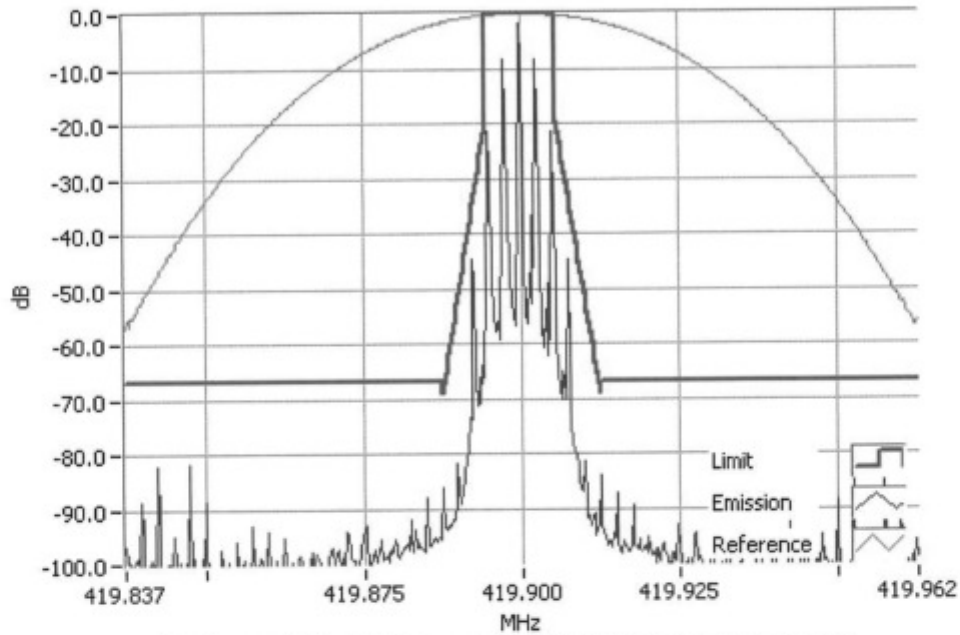

Analogue Modulation 419.9000MHz Mask D 50W
RBW=100Hz, VBW=1000Hz, Detector Mode=Peak
Result=Pass

Tx FREQUENCY: 419.9 MHz 5 W 12.5 kHz Channel Spacing

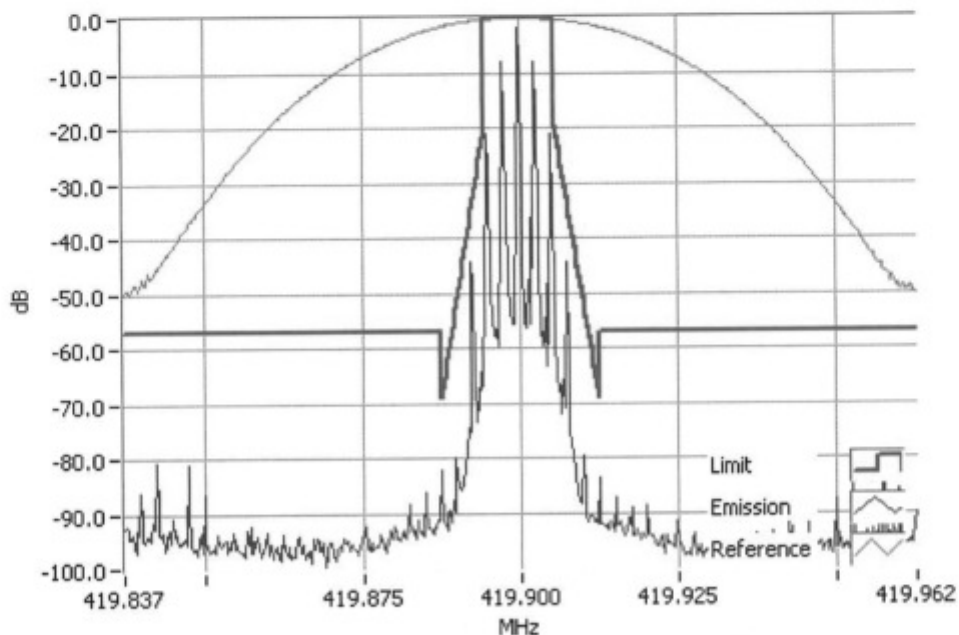

Analogue Modulation 419.9000MHz Mask D 5W
RBW=100Hz, VBW=1000Hz, Detector Mode=Peak
Result=Pass

Occupied Bandwidth and Spectrum Masks

APCO P25 phase-1 C4FM

SPECIFICATION: FCC CFR 2.1049 (c) RSS-119 5.5

Tx FREQUENCY: 406.1 MHz 50 W 12.5 kHz Channel Spacing

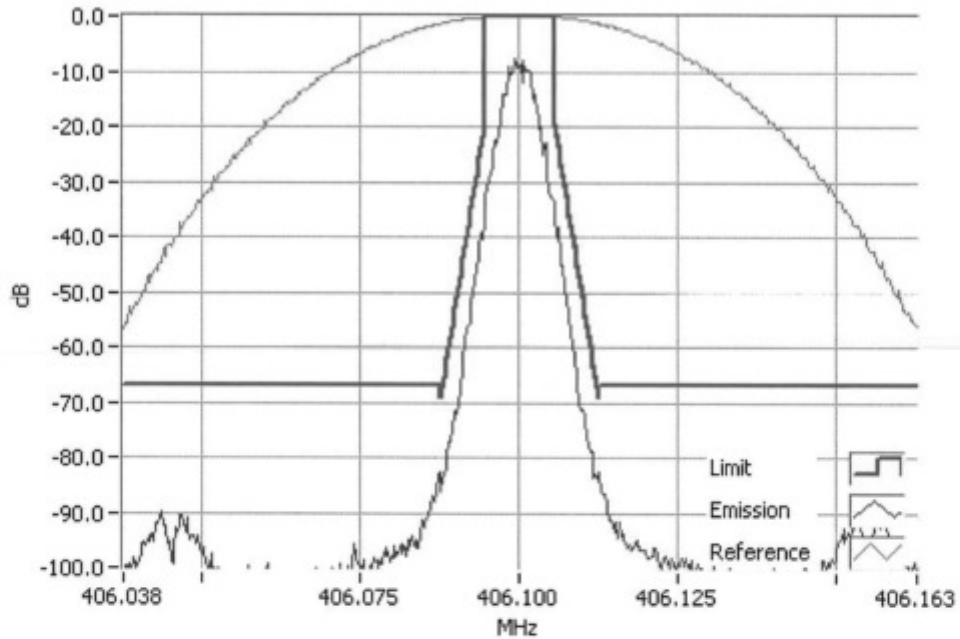

P25 Ph I C4FM 406.1000MHz Mask D 50W
RBW=100Hz, VBW=1000Hz, Detector Mode=Peak
Result=Pass

Tx FREQUENCY: 406.1 MHz 5 W 12.5 kHz Channel Spacing

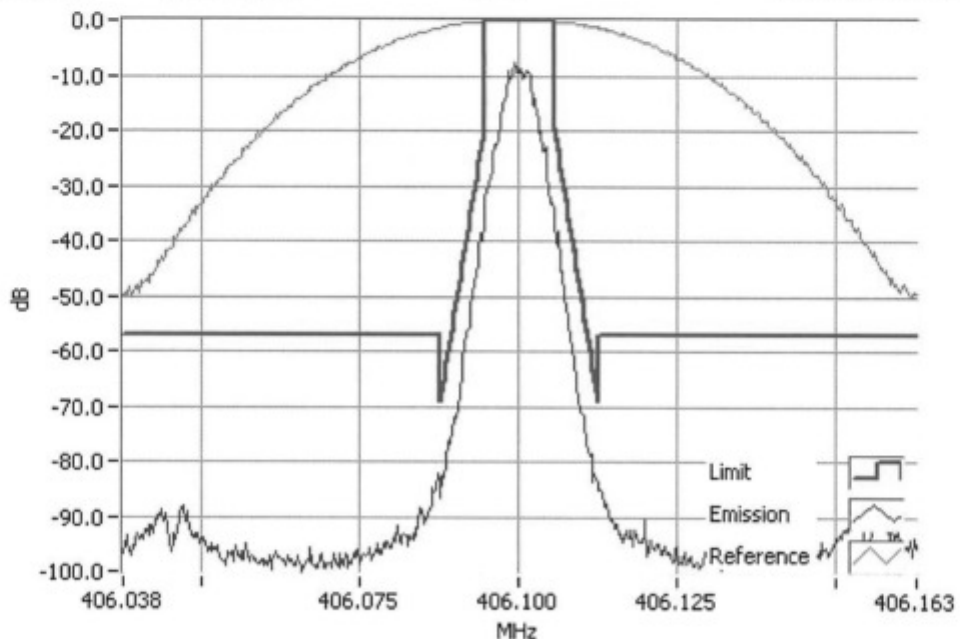

P25 Ph I C4FM 406.1000MHz Mask D 5W
RBW=100Hz, VBW=1000Hz, Detector Mode=Peak
Result=Pass

Occupied Bandwidth and Spectrum Masks

APCO P25 phase-1 C4FM

SPECIFICATION: FCC CFR 2.1049 (c) RSS-119 5.5

Tx FREQUENCY: 413.1 MHz 50 W 12.5 kHz Channel Spacing

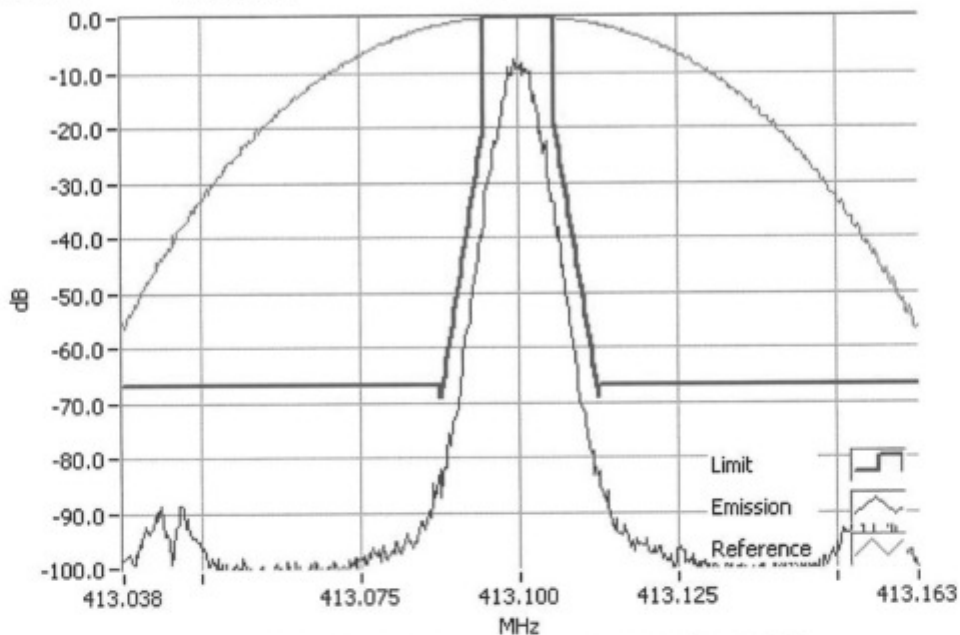

P25 Ph I C4FM 413.1000MHz Mask D 50W
RBW=100Hz, VBW=1000Hz, Detector Mode=Peak
Result=Pass

Tx FREQUENCY: 413.1 MHz 5 W 12.5 kHz Channel Spacing

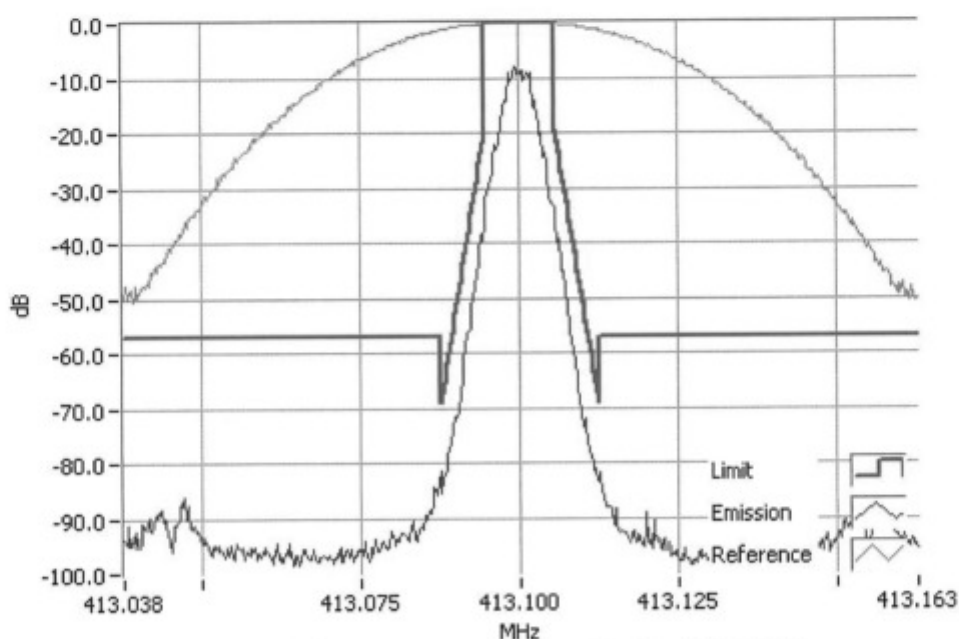

P25 Ph I C4FM 413.1000MHz Mask D 5W
RBW=100Hz, VBW=1000Hz, Detector Mode=Peak
Result=Pass

Occupied Bandwidth and Spectrum Masks

APCO P25 phase-1 C4FM

SPECIFICATION: FCC CFR 2.1049 (c) RSS-119 5.5

Tx FREQUENCY: 419.9 MHz 50 W 12.5 kHz Channel Spacing

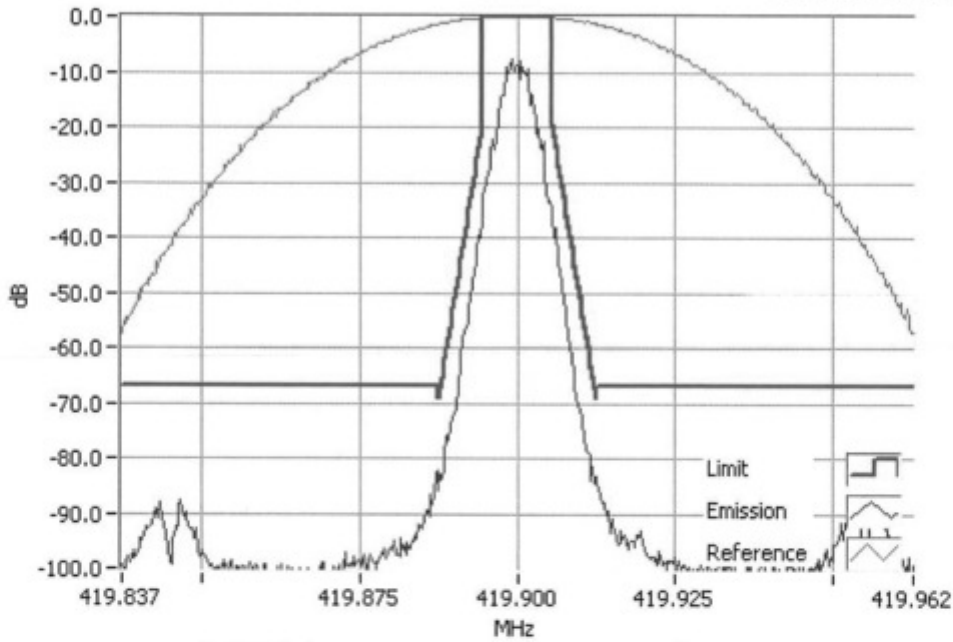

P25 Ph I C4FM 419.9000MHz Mask D 50W
RBW=100Hz, VBW=1000Hz, Detector Mode=Peak
Result=Pass

Tx FREQUENCY: 419.9 MHz 5 W 12.5 kHz Channel Spacing

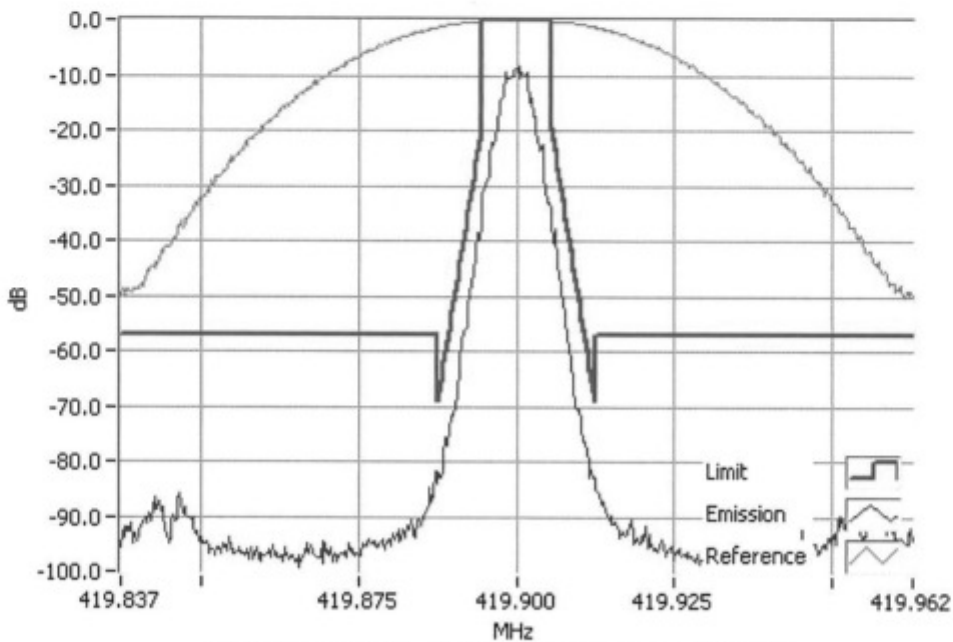

P25 Ph I C4FM 419.9000MHz Mask D 5W
RBW=100Hz, VBW=1000Hz, Detector Mode=Peak
Result=Pass

Occupied Bandwidth and Spectrum Masks

APCO P25 phase-1 LSM

SPECIFICATION: FCC CFR 2.1049 (c) RSS-119 5.5

Tx FREQUENCY: 406.1 MHz 50 W 12.5 kHz Channel Spacing

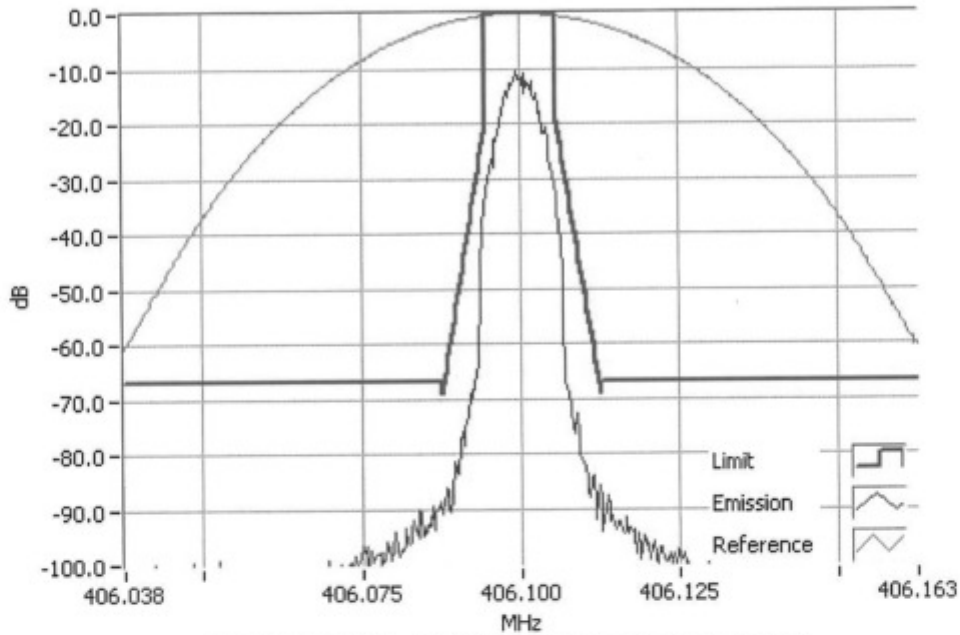

P25 Ph I LSM 406.1000MHz Mask D 50W
RBW=100Hz, VBW=1000Hz, Detector Mode=Peak
Result=Pass

Tx FREQUENCY: 406.1 MHz 5 W 12.5 kHz Channel Spacing

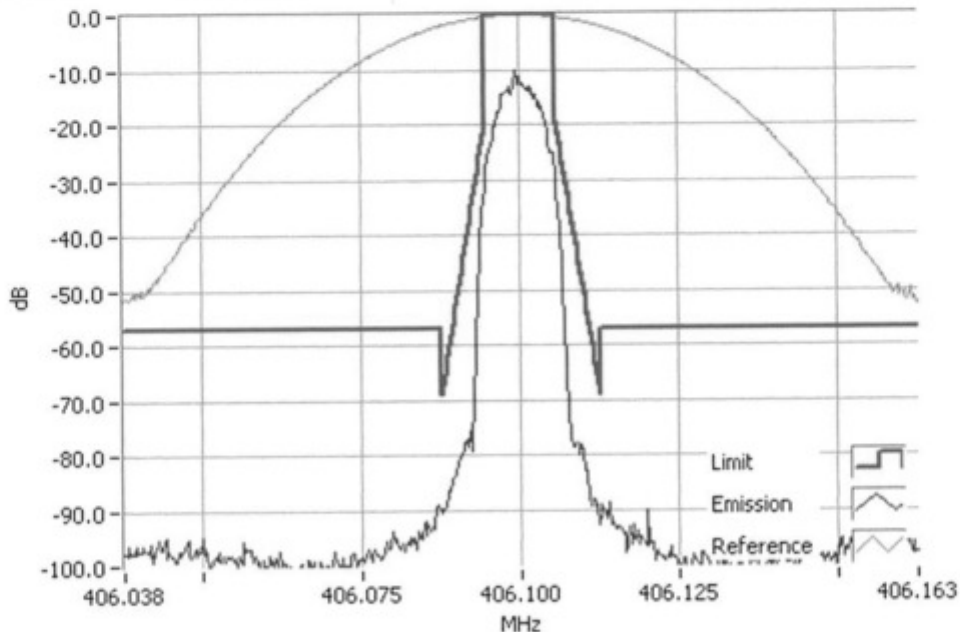

P25 Ph I LSM 406.1000MHz Mask D 5W
RBW=100Hz, VBW=1000Hz, Detector Mode=Peak
Result=Pass

Occupied Bandwidth and Spectrum Masks

APCO P25 phase-1 LSM

SPECIFICATION: FCC CFR 2.1049 (c) RSS-119 5.5

Tx FREQUENCY: 413.1 MHz 50 W 12.5 kHz Channel Spacing

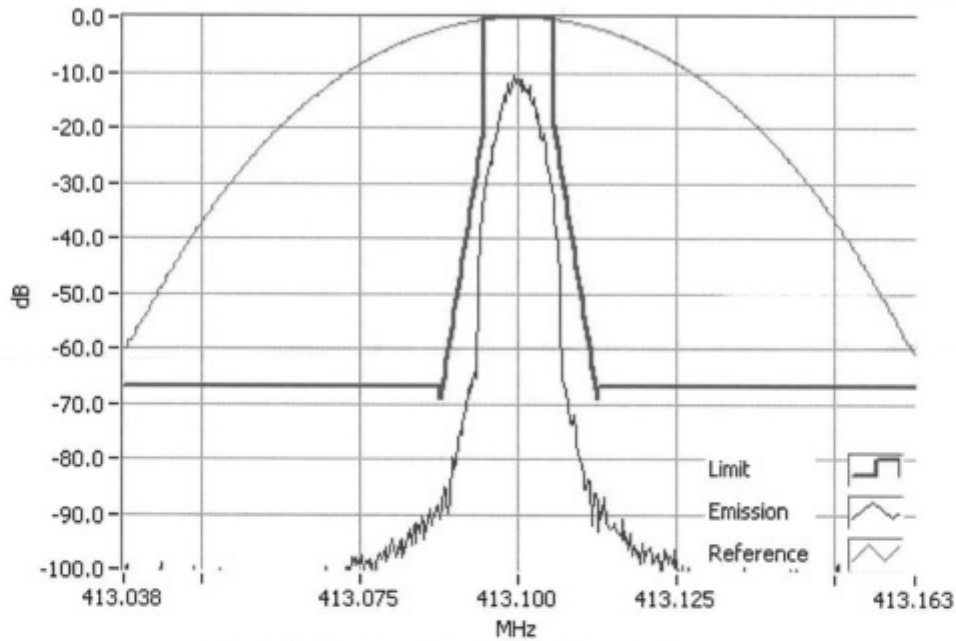

P25 Ph I LSM 413.1000MHz Mask D 50W
RBW=100Hz, VBW=1000Hz, Detector Mode=Peak
Result=Pass

Tx FREQUENCY: 413.1 MHz 5 W 12.5 kHz Channel Spacing

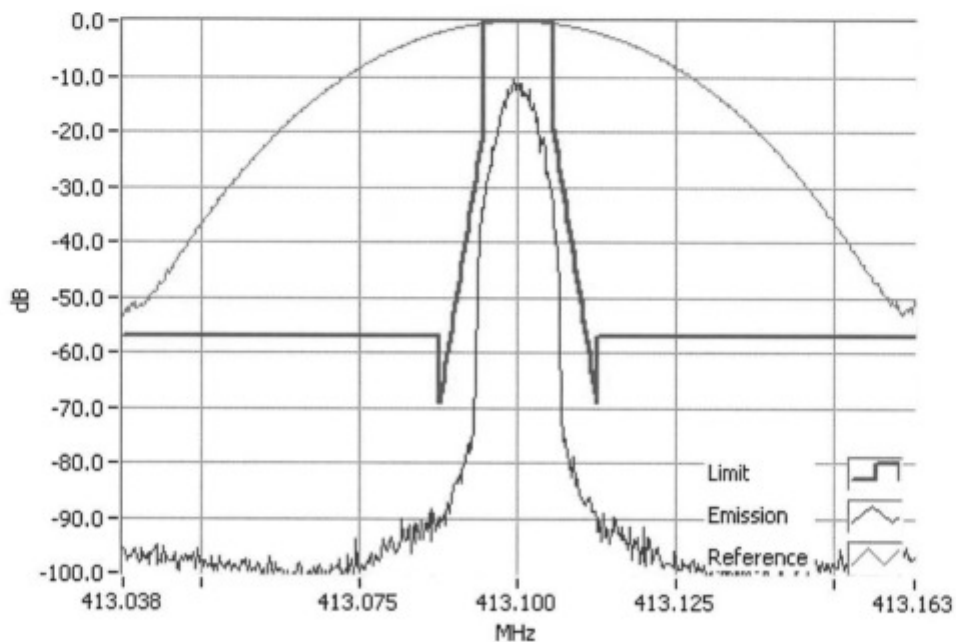

P25 Ph I LSM 413.1000MHz Mask D 5W
RBW=100Hz, VBW=1000Hz, Detector Mode=Peak
Result=Pass

Occupied Bandwidth and Spectrum Masks

APCO P25 phase-1 LSM

SPECIFICATION: FCC CFR 2.1049 (c) RSS-119 5.5

Tx FREQUENCY: 419.1 MHz 50 W 12.5 kHz Channel Spacing

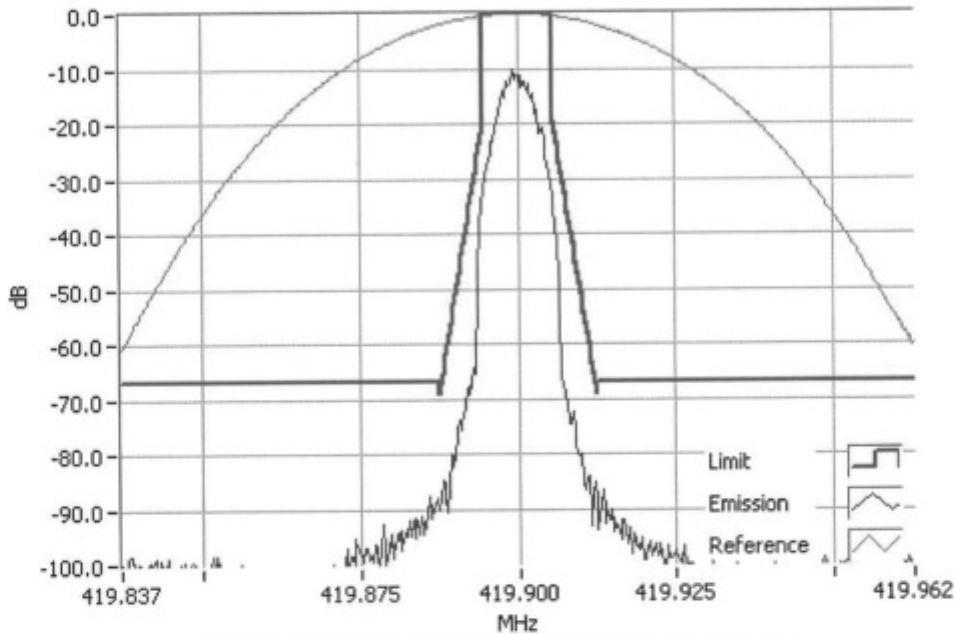

P25 Ph I LSM 419.9000MHz Mask D 50W
RBW=100Hz, VBW=1000Hz, Detector Mode=Peak
Result=Pass

Tx FREQUENCY: 419.1 MHz 5 W 12.5 kHz Channel Spacing

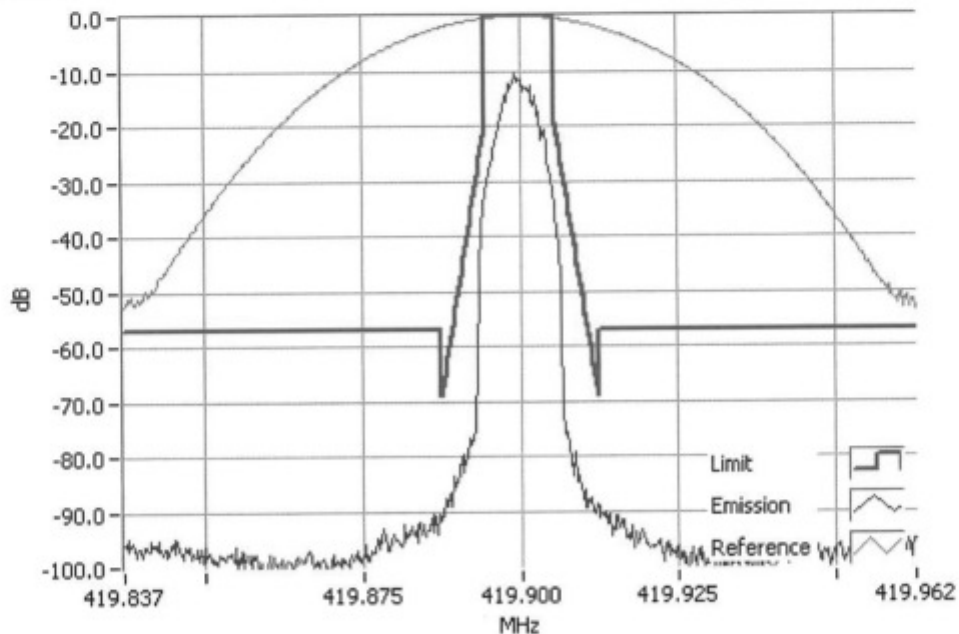

P25 Ph I LSM 419.9000MHz Mask D 5W
RBW=100Hz, VBW=1000Hz, Detector Mode=Peak
Result=Pass

Occupied Bandwidth and Spectrum Masks

APCO P25 phase-2

SPECIFICATION: FCC CFR 2.1049 (c) RSS-119 5.5

Tx FREQUENCY: 406.1 MHz 50 W 12.5 kHz Channel Spacing

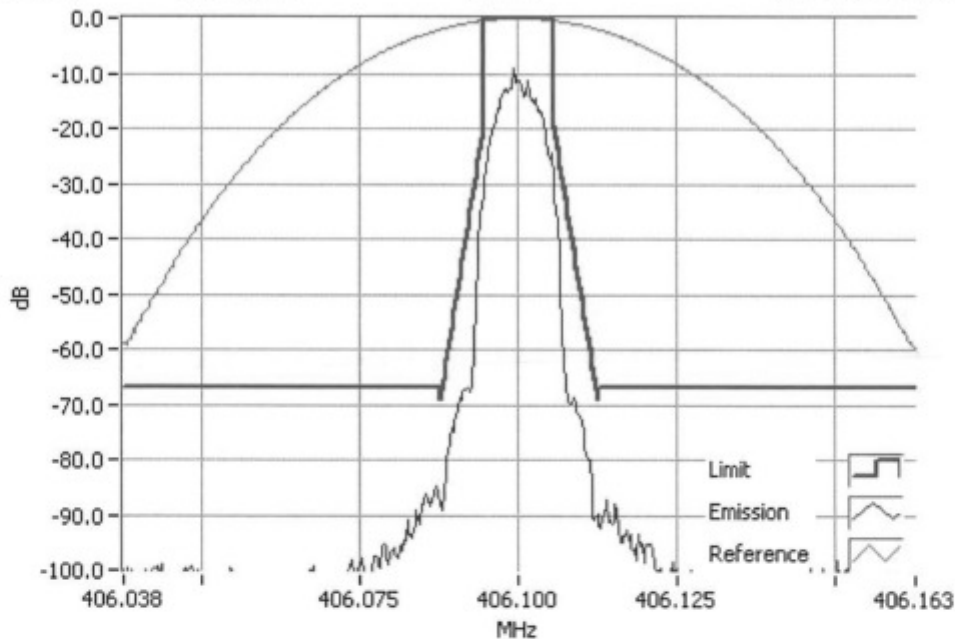

P25 Ph II H-DQPSK 406.1000MHz Mask D 50W
RBW=100Hz, VBW=1000Hz, Detector Mode=Peak
Result=Pass

Tx FREQUENCY: 406.1 MHz 5 W 12.5 kHz Channel Spacing

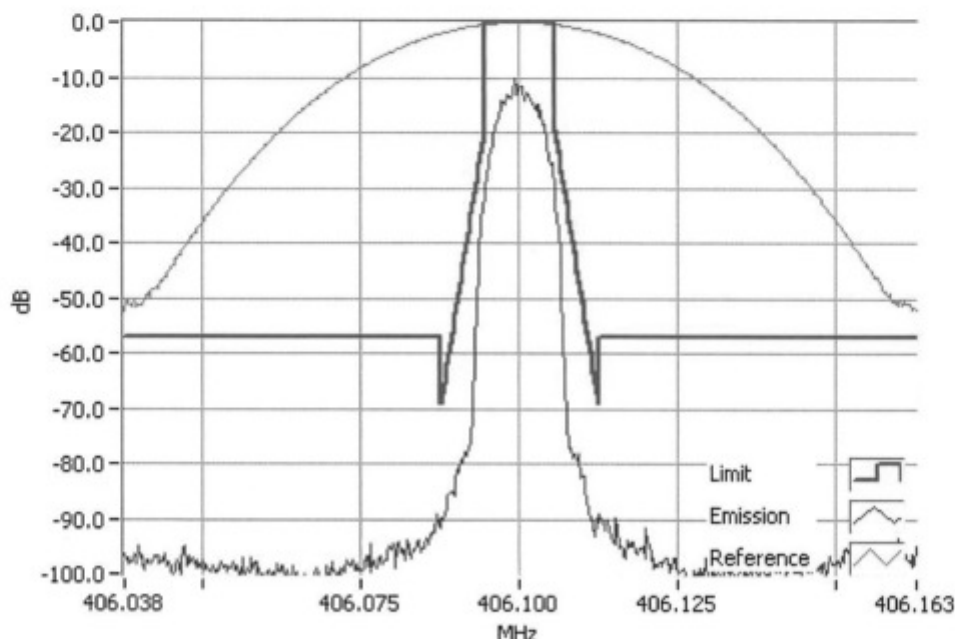

P25 Ph II H-DQPSK 406.1000MHz Mask D 5W
RBW=100Hz, VBW=1000Hz, Detector Mode=Peak
Result=Pass

Occupied Bandwidth and Spectrum Masks

APCO P25 phase-2

SPECIFICATION: FCC CFR 2.1049 (c) RSS-119 5.5

Tx FREQUENCY: 413.1 MHz 50 W 12.5 kHz Channel Spacing

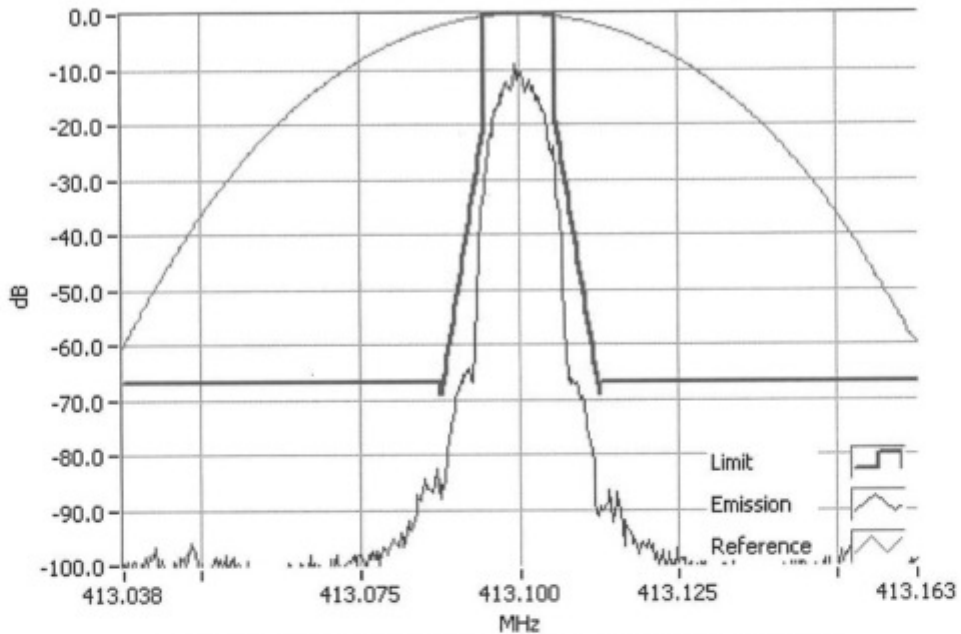

**P25 Ph II H-DQPSK 413.1000MHz Mask D 50W
RBW=100Hz, VBW=1000Hz, Detector Mode=Peak
Result=Pass**

Tx FREQUENCY: 413.1 MHz 5 W 12.5 kHz Channel Spacing

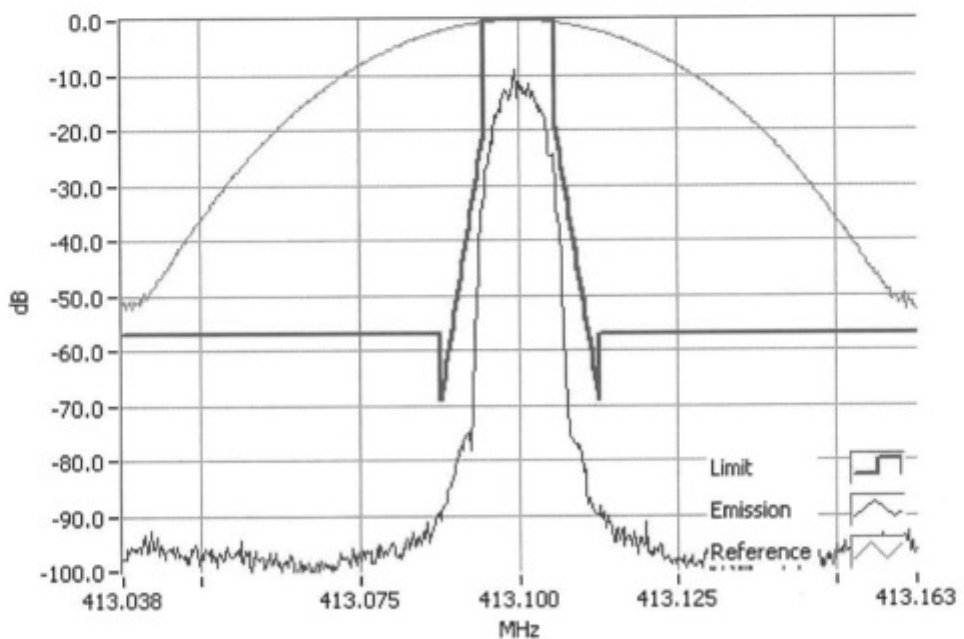

**P25 Ph II H-DQPSK 413.1000MHz Mask D 5W
RBW=100Hz, VBW=1000Hz, Detector Mode=Peak
Result=Pass**

Occupied Bandwidth and Spectrum Masks

APCO P25 phase-2

SPECIFICATION: FCC CFR 2.1049 (c) RSS-119 5.5

Tx FREQUENCY: 419.9 MHz 50 W 12.5 kHz Channel Spacing

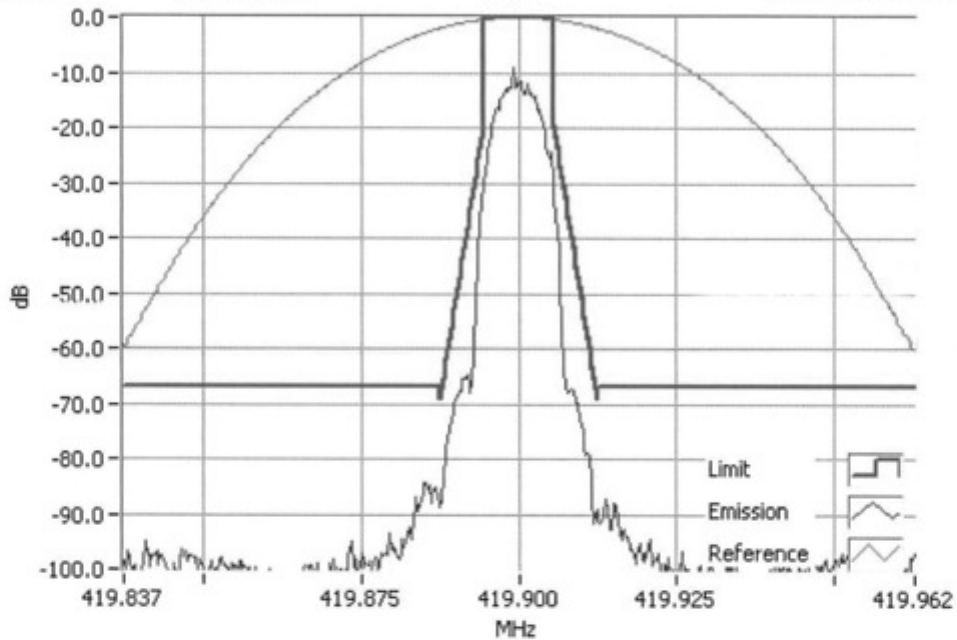

P25 Ph II H-DQPSK 419.9000MHz Mask D 50W
RBW=100Hz, VBW=1000Hz, Detector Mode=Peak
Result=Pass

Tx FREQUENCY: 419.9 MHz 5 W 12.5 kHz Channel Spacing

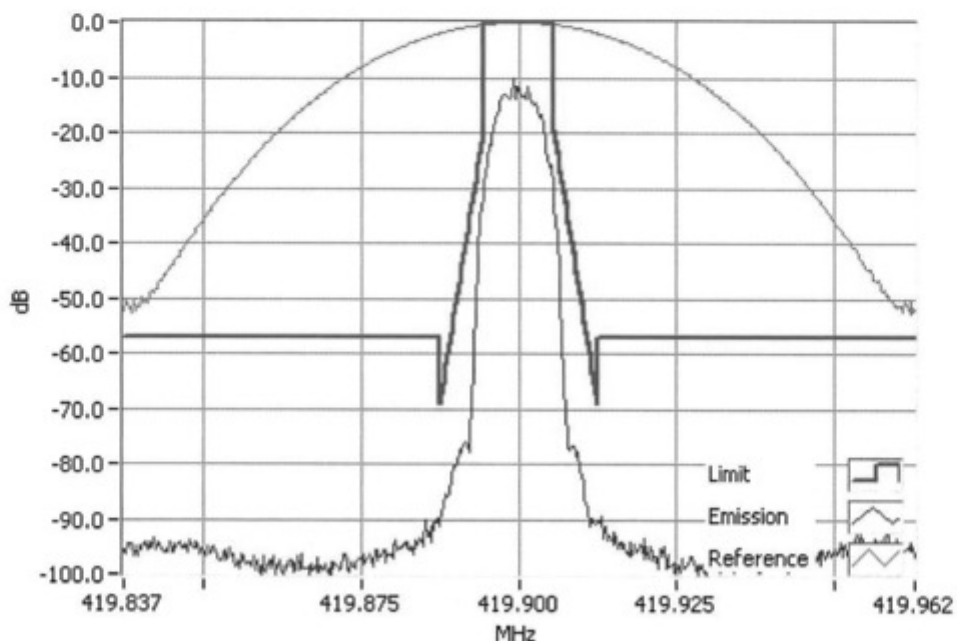

P25 Ph II H-DQPSK 419.9000MHz Mask D 5W
RBW=100Hz, VBW=1000Hz, Detector Mode=Peak
Result=Pass

TRANSMITTER SPURIOUS EMISSIONS (CONDUCTED)

SPECIFICATIONS: FCC 47 CFR 2.1051

RSS-119 5.8

GUIDE: TIA-102.CAAA-C 2.2.7

MEASUREMENT PROCEDURE:

1. Refer Annex A for equipment set up.
2. The frequency range examined was from the lowest frequency generated within the EUT, to a frequency higher than the 10th Harmonic: 100 kHz to Fc-BW
Fc+ BW to 10Fc GHz
3. A Pre-scan is performed with a resolution bandwidth of 1 kHz, and a video bandwidth of 3 kHz. If any emissions are found to be within 20 dB of the limit a second measurement is made with the carrier modulated, and a resolution bandwidth of 10 kHz, and a video bandwidth of 30 kHz.

Spurious emissions which were attenuated by more than 20 dB below the limit were not recorded.

A photograph of the test set-up is included below.

MEASUREMENT RESULTS:

See the tables and plots on the following pages for 12.5 kHz channel spacings.

LIMIT CLAUSES: FCC 47 CFR 90.210

RSS-119 5.8

Photo: Conducted Emissions Test Setup

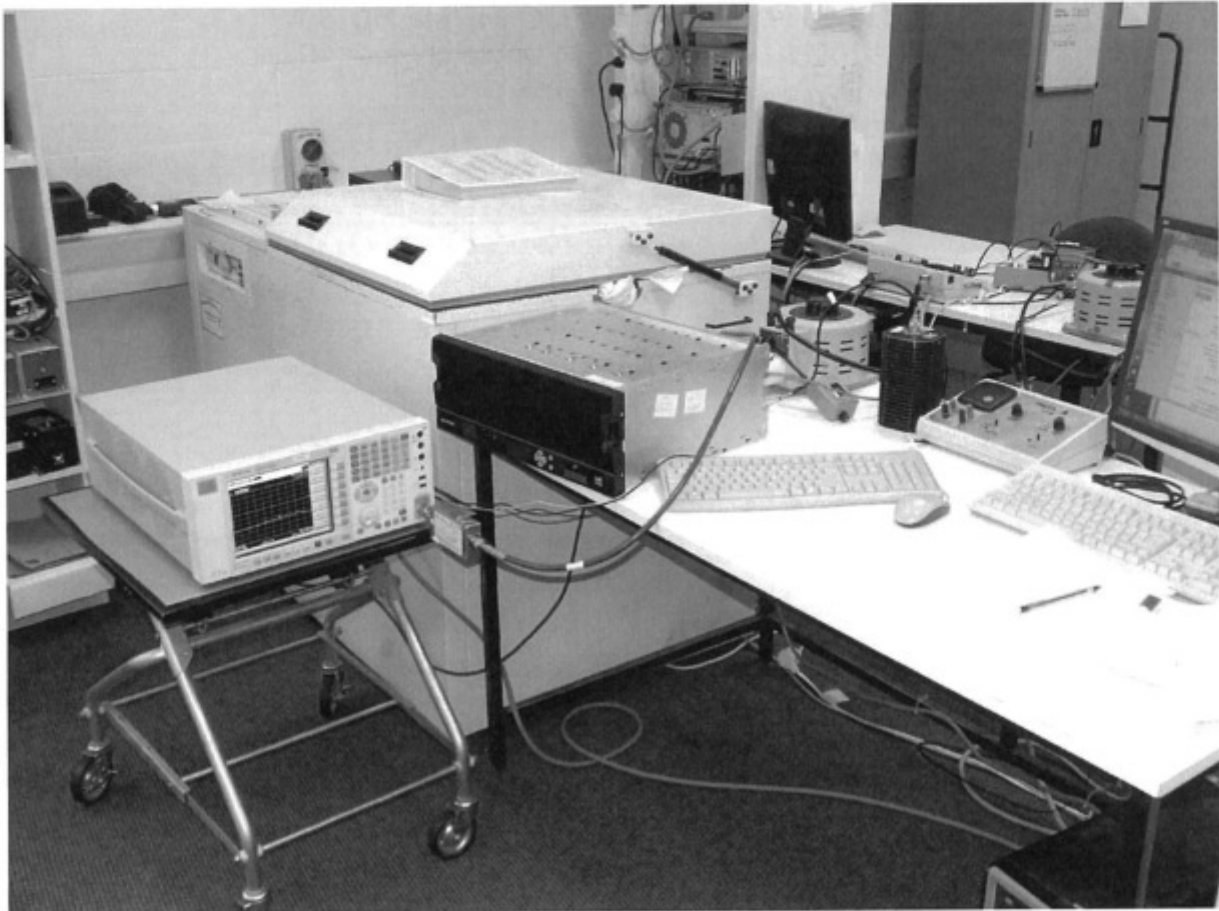

Spurious Emissions (Tx Conducted)

SPECIFICATION: FCC CFR 2.1051

RSS-119 5.8

Tx FREQUENCY: 406.1 MHz

12.5 kHz Channel Spacing 406.1 MHz @ 50 W Emission Mask D

Emission Frequency (MHz)	Level (dBm)	Level (dBc)
2842.6994	-37.4	-84.4

12.5 kHz Channel Spacing 406.1 MHz @ 5 W Emission Mask D

Emission Frequency (MHz)	Level (dBm)	Level (dBc)
~	~	~
Measurement Uncertainty:	≤ 2.75 GHz ± 3.0 dB	
No other emissions were detected at a level greater than 20 dB below the limit.		

TELTEST Laboratories
Tait Ltd
Report Number 3900

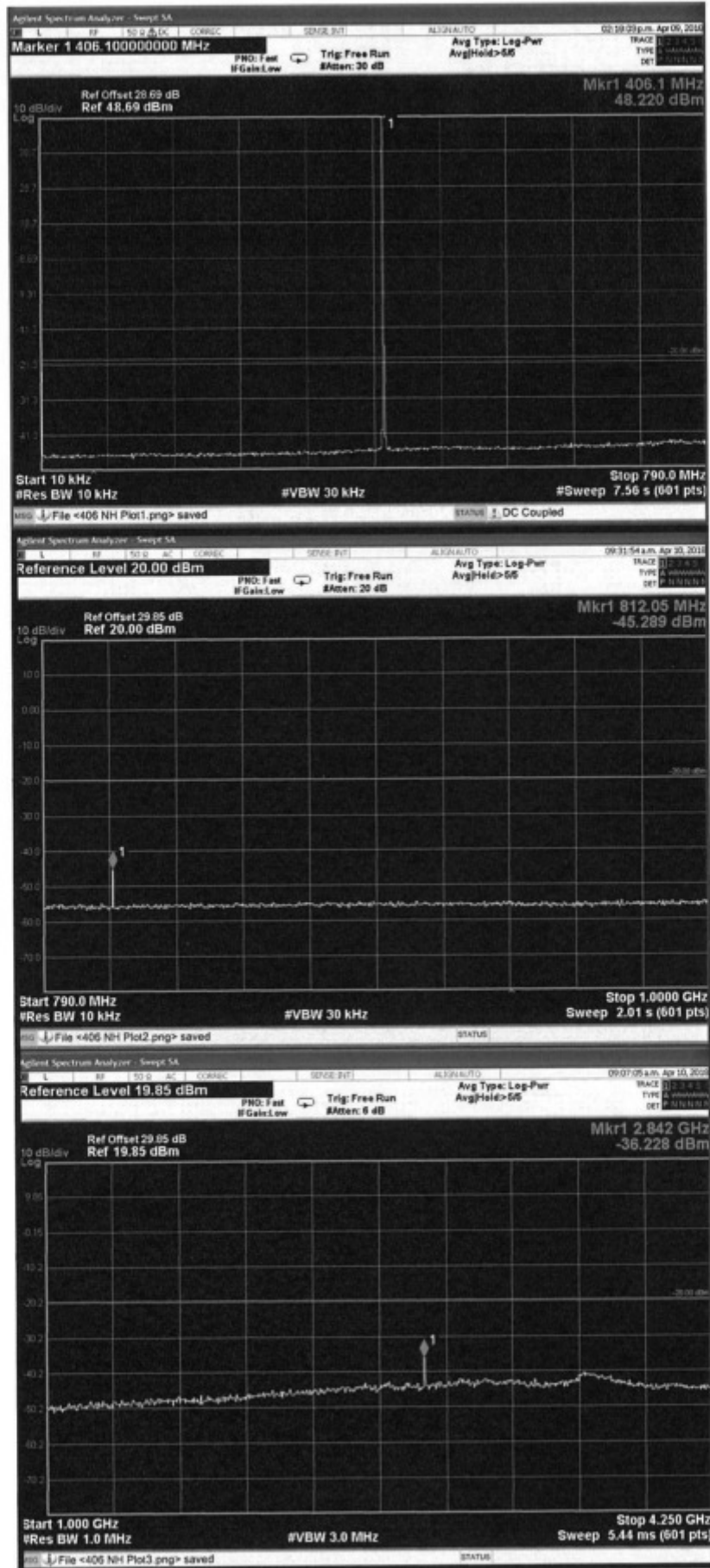

Spurious Emissions (Tx Conducted)

SPECIFICATION: FCC CFR 2.1051

RSS-119 5.8

12.5 kHz Channel Spacing

413.1 MHz @ 50 W

Emission Mask D

Emission Frequency (MHz)	Level (dBm)	Level (dBc)
2891.6995	-38.0	-85.0

12.5 kHz Channel Spacing

413.1 MHz @ 5 W

Emission Mask D

Emission Frequency (MHz)	Level (dBm)	Level (dBc)
~	~	~
Measurement Uncertainty:	≤ 2.75 GHz ± 3.0 dB	
No other emissions were detected at a level greater than 20 dB below the limit.		

Spurious Emissions (Tx Conducted)



Spurious Emissions (Tx Conducted)

SPECIFICATION: FCC CFR 2.1051

RSS-119 5.8

12.5 kHz Channel Spacing

419.9 MHz @ 50 W

Emission Mask D

Emission Frequency (MHz)	Level (dBm)	Level (dBc)
2939.2994	-38.3	-85.3

12.5 kHz Channel Spacing

419.9 MHz @ 5 W

Emission Mask D

Emission Frequency (MHz)	Level (dBm)	Level (dBc)
~	~	~
Measurement Uncertainty:	≤ 2.75 GHz ± 3.0 dB	
No other emissions were detected at a level greater than 20 dB below the limit.		

Spurious Emissions (Tx Conducted)

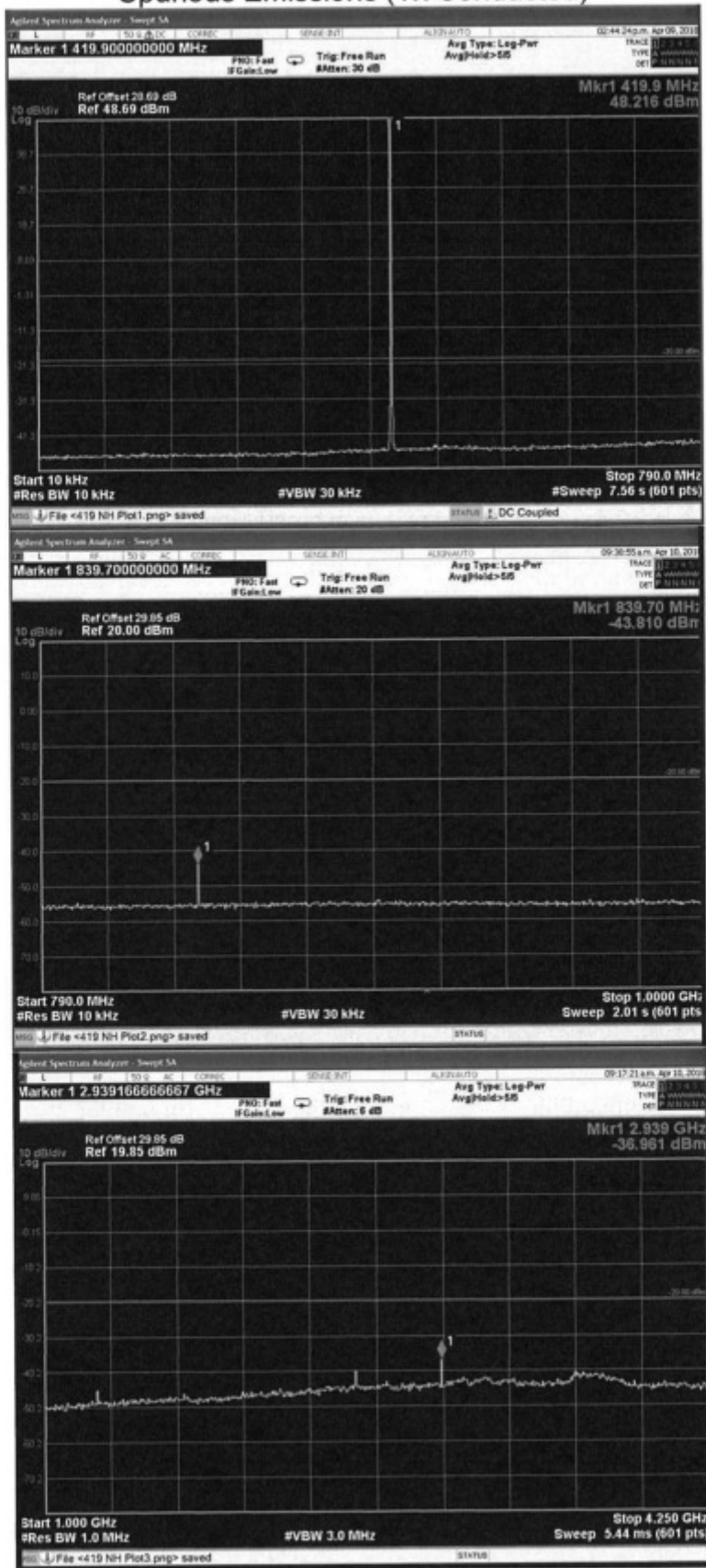

Spurious Emissions (Tx Conducted)

TELTEST Laboratories
Tait Ltd
Report Number 3900

SPECIFICATION: FCC CFR 2.1051 RSS-119 5.8
LIMITS: FCC 47 CFR 90.210 RSS-119 5.8

Carrier Output Power	Emission Mask D 12.5 kHz Channel Spacing $50 + 10 \text{ Log}_{10} (P_{\text{Watts}})$	
	50 W	-20 dBm
5 W	-20 dBm	-57 dBc

TRANSMITTER SPURIOUS EMISSIONS (RADIATED)

SPECIFICATION: FCC 47 CFR 2.1053

GUIDE: TIA-102.CAAA-C 2.2.6

MEASUREMENT PROCEDURE:

Initial Scan:

1. The EUT is placed in the S-Line TEM cell and emissions are measured from 30 MHz to 800 MHz. Any emission within 20 dB of the limit is then re-tested on the OATS.
2. The EUT is placed in the reverberation chamber and emissions are measured from 800 MHz to the upper frequency required. Any emission within 20 dB of the limit is then re-tested on the OATS.
3. The harmonics emissions up to the 6th harmonic of the fundamental frequency are measured on the OATS

OATS Measurement:

1. The EUT is placed on a wooden turntable at a distance of three metres from the test antenna. The output terminal is connected to an RF dummy load.
2. The test antenna is raised from 1 m to 4 m to obtain a maximum reading; the turntable is then rotated through 360° to obtain the maximum response of each spurious emission. Valid emissions are determined by switching the EUT on and off.
3. The EUT is then replaced by a signal generator and substitution antenna to make measurements by the substitution method.

MEASUREMENT RESULTS:

See the tables on the following pages

LIMIT CLAUSE: FCC 47 CFR 90.210

Spurious Emissions (Tx Radiated)

SPECIFICATION: FCC CFR 2.1053

12.5 kHz Channel Spacing 406.1 MHz @ 50 W Emission Mask D

Emission Frequency (MHz)	Level (dBm)	Level (dBc)
~	~	~

12.5 kHz Channel Spacing 406.1 MHz @ 5 W Emission Mask D

Emission Frequency (MHz)	Level (dBm)	Level (dBc)
~	~	~
Measurement Uncertainty	± 4.6 dB	
No emissions were detected at a level greater than 20 dB below the limit.		

12.5 kHz Channel Spacing 413.1 MHz @ 50 W Emission Mask D

Emission Frequency (MHz)	Level (dBm)	Level (dBc)
~	~	~

12.5 kHz Channel Spacing 413.1 MHz @ 5 W Emission Mask D

Emission Frequency (MHz)	Level (dBm)	Level (dBc)
~	~	~
Measurement Uncertainty	± 4.6 dB	
No emissions were detected at a level greater than 20 dB below the limit.		

12.5 kHz Channel Spacing 419.9 MHz @ 50 W Emission Mask D

Emission Frequency (MHz)	Level (dBm)	Level (dBc)
~	~	~

12.5 kHz Channel Spacing 419.9 MHz @ 5 W Emission Mask D

Emission Frequency (MHz)	Level (dBm)	Level (dBc)
~	~	~
Measurement Uncertainty	± 4.6 dB	
No emissions were detected at a level greater than 20 dB below the limit.		

LIMITS: FCC CFR 2.1053

Carrier Output Power	Emission Mask D 12.5 kHz Channel Spacing $50 + 10 \text{ Log}_{10} (P_{\text{Watts}})$	
50 W	-20 dBm	-67 dBc
5 W	-20 dBm	-57 dBc

Tx Radiated Emissions - Continued

Open Area Test Site Results:

12.5 kHz Channel Spacing

419.9 MHz @ 50 W

Emission Mask D

Harmonics Emission Frequency (MHz)	Level (dBm)	Level (dBc)
839.800000	-65.29	-112.29
1259.700000	-55.41	-102.41
1679.600000	-59.53	-106.53
2099.500000	-64.81	-111.81
2519.400000	-68.22	-115.22
2939.300000	-67.79	-114.79
Measurement Uncertainty	± 4.6 dB	

Sample Calculation	Measurement					Result	
	Reference	Substitution					
Emission Frequency (MHz)	Reference Level (dBm)	Sig-gen Level	Cable and Attenuator Gain	Antenna Gain (dBd)	Path and Boresight corrections	dBm	nW
839.800000	-97.38	-48.33	-16.73	-0.35	0.12	-65.29	0.3
		A	B	C	D	E	

Result (E) = A+B+C+D

Photo: OATS Setup



TRANSIENT FREQUENCY BEHAVIOR

SPECIFICATION: FCC 47 CFR 90.214 RSS-119 5.9

GUIDE: TIA-102.CAAA-C 2.2.18

MEASUREMENT PROCEDURE:

1. Refer Annex A for equipment set up.
2. Measurements and plots were made following the TIA procedure.

MEASUREMENT RESULTS:

See the tables and plots on the following pages for 12.5 kHz channel spacings.

LIMIT CLAUSES: FCC 47 CFR 90.214 RSS-119 5.9

Transient Frequency Behaviour

SPECIFICATION: FCC 47 CFR 90.214

RSS-119 5.9

Tx FREQUENCY: 406.1 MHz 50 W

12.5 kHz Channel Spacing

406.1 MHz @ 50 W Tx

TRANSIENT RESPONSE PERIOD	CARRIER PEAK VARIATION FROM NORMAL	
	Key ON (kHz)	Key OFF (kHz)
t1	-0.6	N/A
t2	-0.6	N/A
t3	N/A	-0.7

Confirm that during periods t1 and t3 the frequency difference does not exceed the value of one channel separation.	YES	NO
	✓	<input type="checkbox"/>
Confirm that during the period t2 the frequency difference does not exceed half a channel separation.	YES	NO
	✓	<input type="checkbox"/>
Confirm that during the period t2 to t3 the frequency difference does not exceed the frequency error limit.	YES	NO
	✓	<input type="checkbox"/>

Measurement Uncertainty: Frequency \pm 130 Hz; Time \pm 0.2%

LIMIT: FCC 47 CFR 90.214

TRANSIENT PERIODS	FREQUENCY RANGE	
	150 MHz – 174 MHz	421 MHz – 512 MHz
t1 (ms)	5 ms	10 ms
t2 (ms)	20 ms	25 ms
t3 (ms)	5 ms	10 ms

LIMIT: RSS-119 5.9

Transient Frequency Behaviour for Equipment Designed to Operate on 12.5 kHz Channels			
TRANSIENT PERIODS	Maximum Frequency Difference	FREQUENCY RANGE	
		138 – 174 MHz	406.1 – 470 MHz
t1 (ms)	\pm 12.5 kHz	5 ms	10 ms
t2 (ms)	\pm 6.25 kHz	20 ms	25 ms
t3 (ms)	\pm 12.5 kHz	5 ms	10 ms

Note: RSS-119 5.9 - If the transmitter carrier output power rating is 6 Watts or less, the frequency difference during the time periods t1 and t3 may exceed the maximum frequency difference for these time periods.

Transient Frequency Behaviour

SPECIFICATION: FCC 47 CFR 90.214

RSS-119 5.9

Tx FREQUENCY: 406.1 MHz

50 W

12.5 kHz Channel Spacing

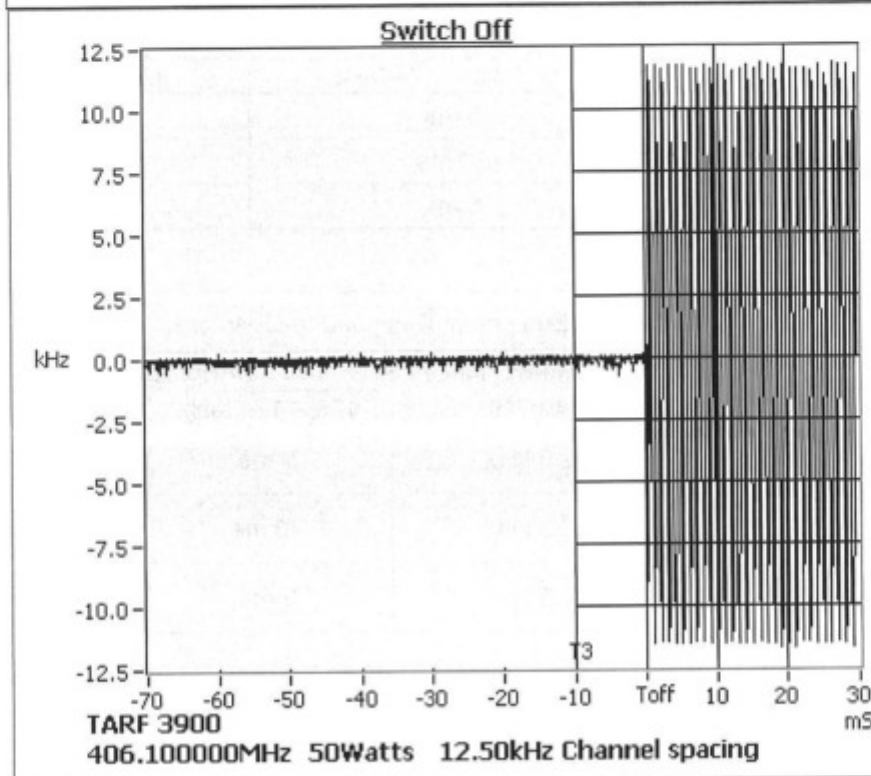
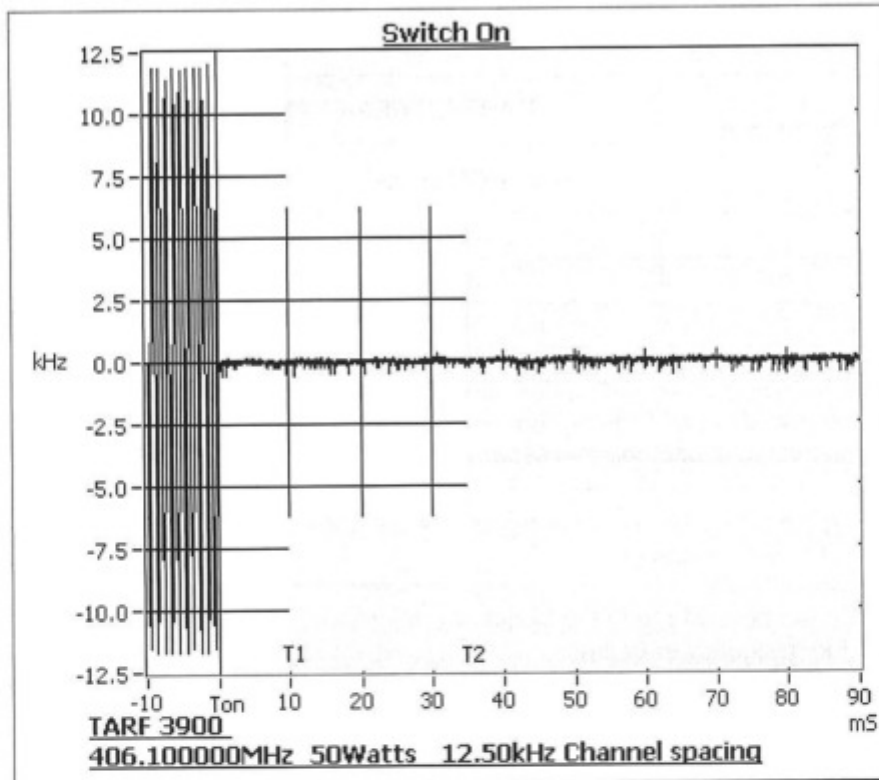

Transient Frequency Behaviour

SPECIFICATION: FCC 47 CFR 90.214

Tx FREQUENCY: 413.1 MHz 50 W 25.0 kHz Channel Spacing

413.1 MHz @ 50 W Tx

TRANSIENT RESPONSE PERIOD	CARRIER PEAK VARIATION FROM NORMAL	
	Key ON (kHz)	Key OFF (kHz)
t1	-0.6	N/A
t2	-0.6	N/A
t3	N/A	-0.5

Confirm that during periods t1 and t3 the frequency difference does not exceed the value of one channel separation.	YES	NO
	✓	<input type="checkbox"/>
Confirm that during the period t2 the frequency difference does not exceed half a channel separation.	YES	NO
	✓	<input type="checkbox"/>
Confirm that during the period t2 to t3 the frequency difference does not exceed the frequency error limit.	YES	NO
	✓	<input type="checkbox"/>

Measurement Uncertainty: Frequency ± 130 Hz; Time ± 0.2%

LIMIT: FCC 47 CFR 90.214

TRANSIENT PERIODS	FREQUENCY RANGE	
	150 MHz – 174 MHz	421 MHz – 512 MHz
t1 (ms)	5 ms	10 ms
t2 (ms)	20 ms	25 ms
t3 (ms)	5 ms	10 ms

LIMIT: RSS-119 5.9

Transient Frequency Behaviour for Equipment Designed to Operate on 12.5 kHz Channels			
TRANSIENT PERIODS	Maximum Frequency Difference	FREQUENCY RANGE	
		138 – 174 MHz	406.1 – 470 MHz
t1 (ms)	± 12.5 kHz	5 ms	10 ms
t2 (ms)	± 6.25 kHz	20 ms	25 ms
t3 (ms)	± 12.5 kHz	5 ms	10 ms

Note: RSS-119 5.9 - If the transmitter carrier output power rating is 6 Watts or less, the frequency difference during the time periods t1 and t3 may exceed the maximum frequency difference for these time periods,

Transient Frequency Behavior

SPECIFICATION: FCC 47 CFR 90.214

Tx FREQUENCY: 413.1 MHz 50 W 25.0 kHz Channel Spacing

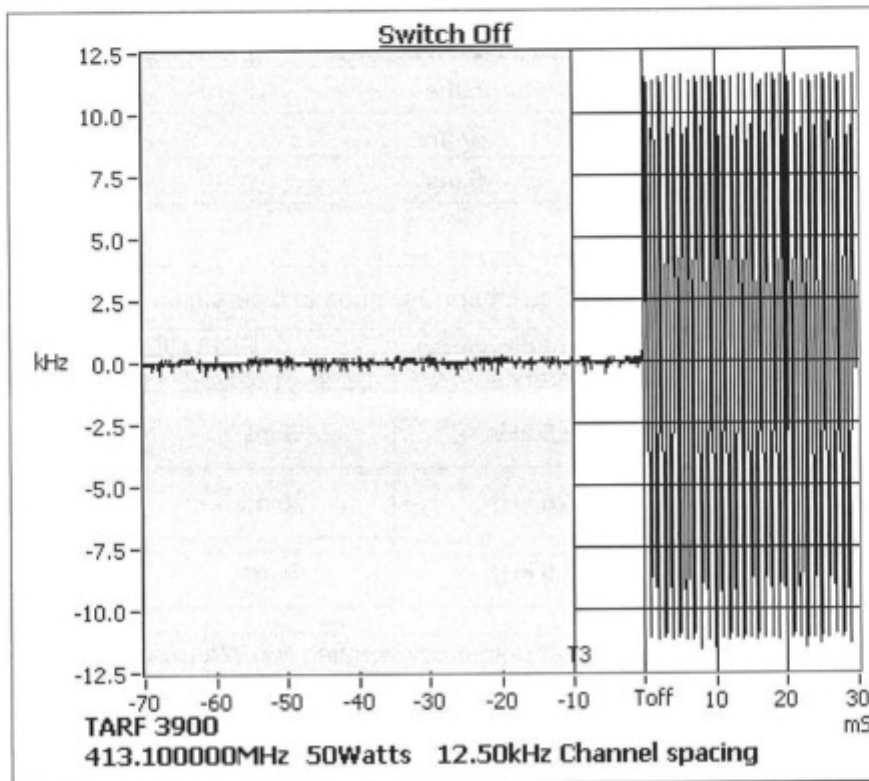
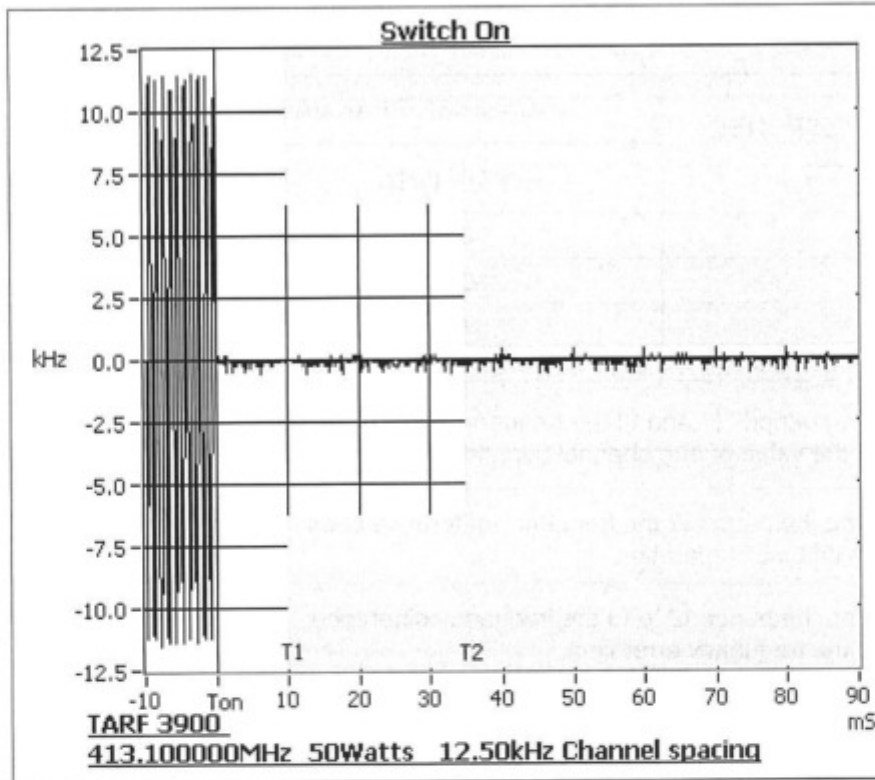

Transient Frequency Behaviour

SPECIFICATION: FCC 47 CFR 90.214

RSS-119 5.9

Tx FREQUENCY: 419.9 MHz 50 W

12.5 kHz Channel Spacing

419.9 MHz @ 50 W Tx

TRANSIENT RESPONSE PERIOD	CARRIER PEAK VARIATION FROM NORMAL	
	Key ON (kHz)	Key OFF (kHz)
t1	-0.8	N/A
t2	-0.7	N/A
t3	N/A	-0.6

Confirm that during periods t1 and t3 the frequency difference does not exceed the value of one channel separation.	YES	NO
	✓	<input type="checkbox"/>
Confirm that during the period t2 the frequency difference does not exceed half a channel separation.	YES	NO
	✓	<input type="checkbox"/>
Confirm that during the period t2 to t3 the frequency difference does not exceed the frequency error limit.	YES	NO
	✓	<input type="checkbox"/>

Measurement Uncertainty: Frequency \pm 130 Hz; Time \pm 0.2%

LIMIT: FCC 47 CFR 90.214

TRANSIENT PERIODS	FREQUENCY RANGE	
	150 MHz – 174 MHz	421 MHz – 512 MHz
t1 (ms)	5 ms	10 ms
t2 (ms)	20 ms	25 ms
t3 (ms)	5 ms	10 ms

LIMIT: RSS-119 5.9

Transient Frequency Behaviour for Equipment Designed to Operate on 12.5 kHz Channels			
TRANSIENT PERIODS	Maximum Frequency Difference	FREQUENCY RANGE	
		138 – 174 MHz	406.1 – 470 MHz
t1 (ms)	\pm 12.5 kHz	5 ms	10 ms
t2 (ms)	\pm 6.25 kHz	20 ms	25 ms
t3 (ms)	\pm 12.5 kHz	5 ms	10 ms

Note: RSS-119 5.9 - If the transmitter carrier output power rating is 6 Watts or less, the frequency difference during the time periods t1 and t3 may exceed the maximum frequency difference for these time periods.

Transient Frequency Behaviour

SPECIFICATION: FCC 47 CFR 90.214

RSS-119 5.9

Tx FREQUENCY: 419.9 MHz

50 W

12.5 kHz Channel Spacing

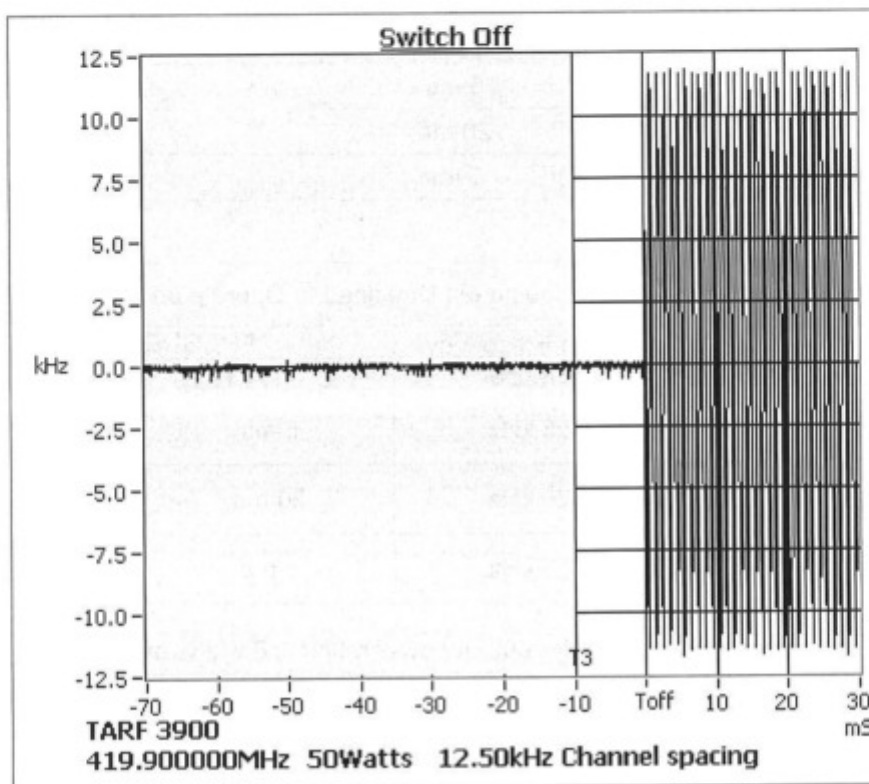
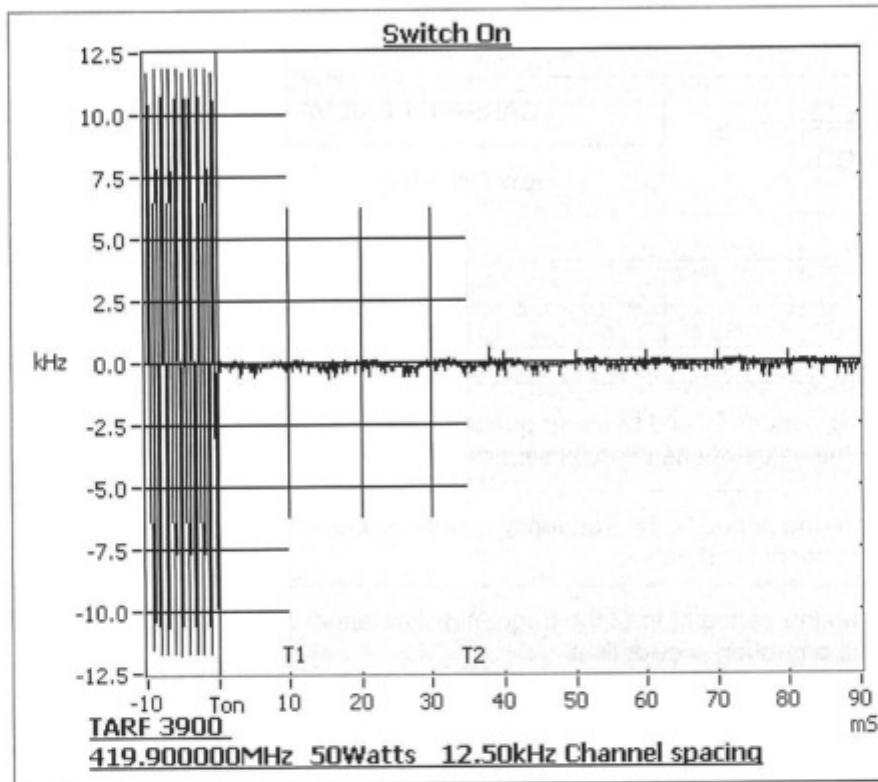

TRANSMITTER FREQUENCY STABILITY - TEMPERATURE

SPECIFICATION: FCC 47 CFR 2.1055 (a) (1)

RSS-119 5.3

GUIDE: TIA-102.CAAA-C 2.2.2

MEASUREMENT PROCEDURE:

1. Refer Annex A for equipment set up.
2. The EUT was tested for frequency error from -30° C to +50° C in 10° C increments
3. The frequency error was recorded in parts per million (ppm).

MEASUREMENT RESULTS:

See the plots on the following pages for 12.5 kHz channel spacing.

Temperature (°C)	Error (ppm)		
	406.1 MHz	413.1 MHz	419.9 MHz
-30	-0.15	-0.14	-0.15
-20	-0.32	-0.32	-0.32
-10	-0.32	-0.32	-0.31
0	-0.17	-0.17	-0.17
10	-0.18	-0.18	-0.19
20	-0.33	-0.31	-0.32
30	-0.28	-0.27	-0.27
40	-0.24	-0.25	-0.25
50	-0.16	-0.16	-0.17
Measurement Uncertainty	$\pm 7 \times 10^{-8}$		

LIMIT: FCC 47 CFR 90.213

RSS-119 5.3

Channel Spacing (kHz)	Frequency Error (ppm)
12.5	1.5

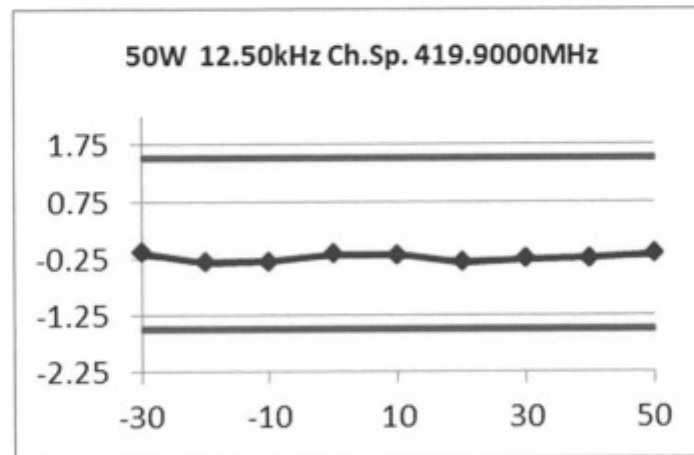
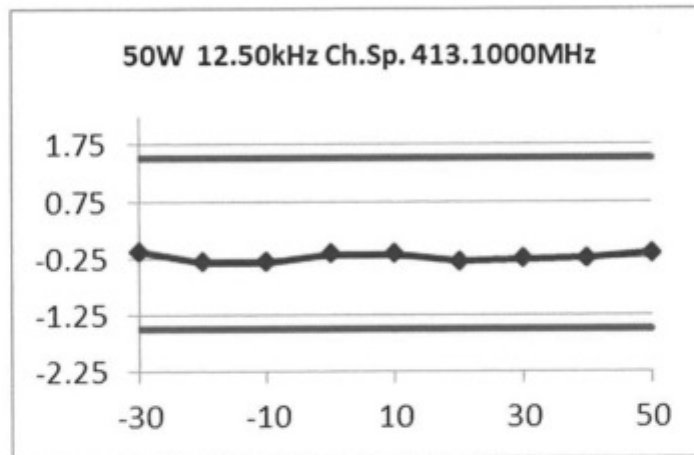
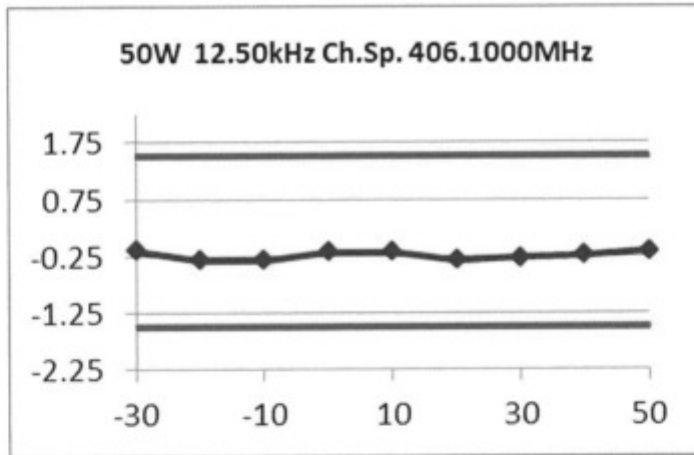

TRANSMITTER FREQUENCY STABILITY - VOLTAGE

SPECIFICATION: FCC 47 CFR 2.1055 (d) (1)

RSS-119 5.3

GUIDE: TIA-102.CAAA-C 2.2.2

MEASUREMENT PROCEDURE:

1. Refer Annex A for equipment set up.
2. The EUT was tested for frequency error at an input voltage to the radio of 85% to 115%.
3. The frequency error was recorded in parts per million (ppm).

MEASUREMENT RESULTS:

Voltage	FREQUENCY ERROR (ppm) for 12.5 kHz		
	406.1 MHz	413.1 MHz	419.9 MHz
120 V _{AC}	-0.31	-0.27	-0.30
102 V _{AC}	-0.30	-0.29	-0.30
138 V _{AC}	-0.30	-0.29	-0.29
Measurement Uncertainty	$\pm 7 \times 10^{-8}$		

LIMIT CLAUSES: FCC 47 CFR 90.213

RSS-119 5.3

Channel Spacing (kHz)	Frequency Error (ppm)
12.5	1.5

RECEIVER SPURIOUS EMISSIONS (CONDUCTED)

SPECIFICATION: RSS-119 5.11

GUIDE: TIA-102.CAAA-C 2.1.2

MEASUREMENT PROCEDURE:

1. Refer Annex A for Equipment set up diagram.
2. The frequency range examined was from 30 MHz to 3 times the highest tunable frequency.
3. Spurious emissions which were attenuated more than 20 dB below the limit were not recorded.

406.2 MHz Receive (Receiver Input Port)		
Emission Frequency (MHz)	Level (nW)	Level (dBm)
~	~	~
Measurement Uncertainty	≤ 2.75 GHz ± 3.0 dB	
No emissions were detected within 20 dB of Limit.		

413.2 MHz Receive (Receiver Input Port)		
Emission Frequency (MHz)	Level (nW)	Level (dBm)
~	~	~
Measurement Uncertainty	≤ 2.75 GHz ± 3.0 dB	
No emissions were detected within 20 dB of Limit.		

419.8 MHz Receive (Receiver Input Port)		
Emission Frequency (MHz)	Level (nW)	Level (dBm)
~	~	~
Measurement Uncertainty	≤ 2.75 GHz ± 3.0 dB	
No emissions were detected within 20 dB of Limit.		

LIMIT CLAUSE: RSS-Gen 6(b)

LIMIT	30 → 1000 MHz	2 nW	- 57 dBm
	> 1000 MHz	5 nW	- 53 dBm

TRANSMITTER STANDBY SPURIOUS EMISSIONS (CONDUCTED)

SPECIFICATION: RSS-119 5.11

GUIDE: TIA-102.CAAA-C 2.1.2

MEASUREMENT PROCEDURE:

4. Refer Annex A for Equipment set up diagram.
5. The frequency range examined was from 30 MHz to 3 times highest tunable frequency.
6. Spurious emissions which were attenuated more than 20 dB below the limit were not recorded.

406.1 MHz Transmitter Standby (Transmitter RF Output Port)		
Emission Frequency (MHz)	Level (nW)	Level (dBm)
~	~	~
Measurement Uncertainty	≤2.75 GHz ± 3.0 dB	
No emissions were detected within 20 dB of Limit.		

413.1 MHz Transmitter Standby (Transmitter RF Output Port)		
Emission Frequency (MHz)	Level (nW)	Level (dBm)
~	~	~
Measurement Uncertainty	≤2.75 GHz ± 3.0 dB	
No emissions were detected within 20 dB of Limit.		

419.9 MHz Transmitter Standby (Transmitter RF Output Port)		
Emission Frequency (MHz)	Level (nW)	Level (dBm)
~	~	~
Measurement Uncertainty	≤2.75 GHz ± 3.0 dB	
No emissions were detected within 20 dB of Limit.		

LIMIT CLAUSE: RSS-Gen 6(b)

LIMIT	30 → 1000 MHz	2 nW	- 57 dBm
		> 1000 MHz	5 nW

TEST EQUIPMENT LIST

Equipment Type	Information	Manufacturer	Model No	Serial No#	Tait ID	Cal Due
Signal Generator	Analog 1GHz	Hewlett Packard	HP8648A	3430U00344	E3579	25-Sep-18
Signal Generator	Analog 4GHz	Agilent	E4422B	GB40050320	E3788	28-Sep-18
Antenna	Reference Dipoles	Emco	3121C DB1	9510-1164	E3559	14-Apr-19
Antenna	18GHz DRG	Emco	DRG3115	9512-4638	E3560	15-May-20
Antenna	18GHz DRG	Emco	DRG3115	2084	E3076	
Spectrum Analyser	26.5GHz	Agilent	PXA N9030A	MY49432161	E4907	18-Oct-18
Transient Limiter	9kHz to 200MHz	Agilent	11947A	3107A03657	E4982	29-Sep-18
RF Attenuator	20dB 50W	Weinschel	24-20-44	AW1266	E3562	20-Dec-18
RF Attenuator	20dB 25W	Weinschel	33-20-33	BD5871	E3673	20-Dec-18
RF Load	150W	Bird	8166	524	E3625	20-Dec-18
Coax Cable	2m Black	Suhner	RG214HF/Nm/Nm/2000	TeltestBlack2	E4623	20-Dec-18
Spectrum Analyser	13.2GHz	Hewlett Packard	HP8562E	3821A00779	E3715	2-Oct-18
LISN		Emco	3825/2	9204-1961	E3040	4-Oct-18
Oscilloscope	400MHz	Tektronics	TDS380	B017095	E3782	29-Sep-19
Signal Generator	TREVA2 Analog 3.3GHz	Rohde & Schwarz	SML03 1090.3000.13	100597	E4050	10-Oct-18
Spectrum Analyser	13.2GHz	Agilent	E4445A	MY42510072	E4139	15-Oct-18
Coax Cable	OATS Turntable Cable 1	Intelcom	RG214	OATS1	E4621	1-Jan-19
Coax Cable	OATS Tower Cable	Intelcom	RG214	OATS2	E4622	1-Jan-19
OATS	Antenna Tower	Electrometrics	EM-4720-2	112	E4447	
OATS	Controller	Electrometrics	EM-4700	119	E4445	
OATS	Turntable	Electrometrics	EM-4704A	105	E4446	
Coax Cable	2m Black	Suhner	RG214HF/Nm/Nm/2000	TeltestBlack6	E4849	20-Dec-18
Coax Cable	Reverb - 4.5m Multiflex 141	TeltestBlue6	MF 141	TeltestBlue6	E4843	20-Dec-18
Coax Cable	Reverb - 2m Multiflex 141	TeltestBlue5	MF 141	TeltestBlue5	E4844	20-Dec-18
Coax Cable	Reverb - 2m Multiflex 141	TeltestBlue4	MF 141	TeltestBlue4	E4845	20-Dec-18
Coax Cable	Reverb - 1m Multiflex 141	TeltestBlue2	MF 141	TeltestBlue2	E4847	20-Dec-18
Coax Cable	Reverb - 1m Multiflex 141	TeltestBlue1	MF 141	TeltestBlue1	E4848	20-Dec-18
Power Meter	Reverb - USB interface for NRT Z44	Rohde & Schwarz	NRT Z5	100586	E4852	
Power Meter	Reverb - 0.2 - 4GHz directional power meter	Rohde & Schwarz	NRT Z44	105151	E4853	11-Oct-18
RF Chamber	Reverb - Stirrer controller for reverb chamber	Teseq	Stirrer Controller	29765.1	E4854	
RF Chamber	Reverb - 0.5 - 18GHz Reverberation Chamber	Teseq	RVC XS	29765	E4855	
Antenna	Reverb - 1-18GHz DRG	Schwarzbeck	BBHA 9120 D	9120D-885	E4857	
Antenna	Reverb - 1-18GHz DRG	Schwarzbeck	BBHA 9120 D	9120D-884	E4858	

TELTEST Laboratories
Tait Ltd
Report Number 3900

RF Amplifier	Pre-amplifier	Agilent	87405C	MY47010688	E4941	9-Oct-18
Power Supply	60V/25A	Agilent	N5767A	3111A05573	E4979	10-Oct-18
Coax Cable	OATS Turntable Cable 2	Intelcom	RG215	OATS3	E4995	1-Jan-19
Signal Generator	Digital 4GHz	Agilent	E4437B	US39260389	E4764	30-Sep-19
Testware	Reverb Emissions		28 May 2015	-	-	

* NOTE: Items without calibration dates are calibrated immediately before use, or set using calibrated instruments.

ANNEX A – TEST SETUP DETAILS

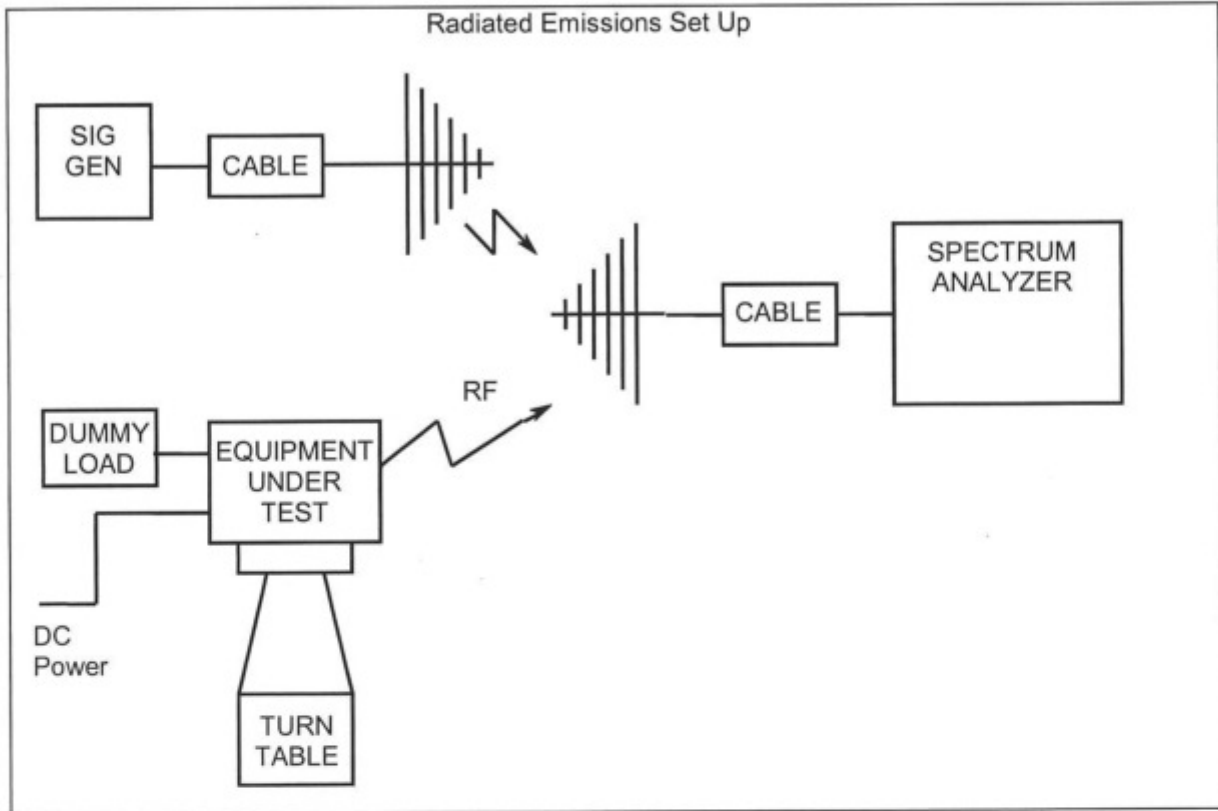

All other testing is performed using the Teltest Radio **EVA**luation system (TREVA), which is configured as shown below. The Spectrum Analyser is connected to the EUT via the attenuator network for Conducted Emissions testing, and Occupied Bandwidth.

