

TB7100 base station
TB8100 base station
TB9100 base station

TBA0STU / TBA0STP Calibration and Test Unit Operation Manual



Tait Contact Information

Tait Radio Communications Corporate Head Office

Tait Electronics Ltd
P.O. Box 1645
Christchurch
New Zealand

For the address and telephone number of regional offices, refer to the TaitWorld website:

Website: <http://www.taitworld.com>

Technical Support

For assistance with specific technical issues, contact Technical Support:

E-mail: support@taitworld.com

Website: <http://support.taitworld.com>



To our European customers:

Tait Electronics Limited is an environmentally responsible company which supports waste minimization and material recovery. The European Union's Waste Electrical and Electronic Equipment Directive requires that this product be disposed of separately from the general waste stream when its service life is over. Please be environmentally responsible and dispose through the original supplier, your local municipal waste "separate collection" service, or contact Tait Electronics Limited.

Contents

Preface	4
Scope of Manual	4
Enquiries and Comments	4
Updates of Manual and Equipment	4
Copyright	4
Disclaimer	4
Document Conventions	5
Associated Documentation	5
Publication Record	6
1 Introduction	7
2 Modification History	9
3 Using the CTU with a TB7100	11
4 Using the CTU with a TB8100	19
5 Using the CTU with a TB9100	27
Appendix A - CTU Accessories	35
Appendix B - CTU Block Diagram	39

Preface

Scope of Manual

This manual provides information on using the TBA0STU/TBA0STP base station Calibration and Test Unit (CTU) with a Tait base station. It describes the input and output connectors and controls available on the CTU, and includes a description of the accessories supplied with the CTU. A block diagram is also provided.

Enquiries and Comments

If you have any enquiries regarding this manual, or any comments, suggestions and notifications of errors, please contact Technical Support (refer to [“Tait Contact Information”](#) on page 2).

Updates of Manual and Equipment

In the interests of improving the performance, reliability or servicing of the equipment, Tait Electronics Ltd reserves the right to update the equipment or this manual or both without prior notice.

Copyright

All information contained in this manual is the property of Tait Electronics Ltd. All rights are reserved. This manual may not, in whole or in part, be copied, photocopied, reproduced, translated, stored, or reduced to any electronic medium or machine-readable form, without prior written permission from Tait Electronics Ltd. All trade names referenced are the service mark, trademark or registered trademark of the respective manufacturers.

Disclaimer

There are no warranties extended or granted by this manual. Tait Electronics Ltd accepts no responsibility for damage arising from use of the information contained in the manual or of the equipment and software it describes. It is the responsibility of the user to ensure that use of such information, equipment and software complies with the laws, rules and regulations of the applicable jurisdictions.

Document Conventions

Within this manual, four types of alerts are given to the reader: Warning, Caution, Important and Note. The following paragraphs illustrate each type of alert and its associated symbol.



Warning!! This alert is used when there is a potential risk of death or serious injury.



Caution This alert is used when there is a risk of minor or moderate injury to people.



Important This alert is used to warn about the risk of equipment damage or malfunction.



Note This alert is used to highlight information that is required to ensure procedures are performed correctly.

Associated Documentation

TB7100 Calibration Application online Help.
TB7100 Programming Application online Help.
TB7100 Installation and Operation Manual.
TB7100 Specifications Manual.

TB8100 Calibration Kit User's Manual and online Help.
TB8100 Service Kit and Alarm Center User's Manuals and online Help.
TB8100 Installation and Operation Manual.
TB8100 Specifications Manual.
TB8100 Service Manual.

TB9100 Calibration Software User's Manual and online Help.
TB9100 Customer Service Software User's Manual and online Help.
TB9100 Installation and Operation Manual.
TB9100 Specifications Manual.
TB9100 Network Installation Guide.

Technical notes are published from time to time to describe applications for Tait products, to provide technical details not included in manuals, and to offer solutions for any problems that arise.

All available product documentation is provided on the Product CD supplied with the base station. Updates may also be published on the Tait Technical Support website (<http://support.taitworld.com>).

Publication Record

Issue	Publication Date	Description
1	September 2005	First release

1 Introduction

The base station calibration and test unit (CTU) is designed to make it easier to connect a Tait base station to standard test equipment, and to a PC running the appropriate programming and calibration software. The CTU can be used with TB7100, TB8100 and TB9100 base stations, and comes with a selection of connection cables, tuning tools and other accessories (refer to [“Appendix A - CTU Accessories”](#) on page 35).



Note Some features of the CTU are used with only one base station, while others serve different functions with different base stations. Any differences in function are explained in each chapter.

This manual describes both the TBA0STU and TBA0STP CTUs. The only difference between the units is that the TBA0STP was not supplied with the TB7100 CTU adaptor board. For information on the earlier TBA0ST1 CTU which was introduced with the TB8100 base station, refer to TN-778.

2 Modification History

This chapter provides details about any production modifications made to the CTU that may affect its performance, or the way in which it interacts with the TB7100, TB8100 or TB9100 base stations.

AC Coupled Unbalanced Audio Input

The unbalanced input on the CTU was changed from DC to AC coupled in August 2005. This modification (fitting a capacitor) was necessary because the unbalanced input on TB8100 TaitNet and TaitNet RS-232 system interface boards was changed at that time from AC to DC coupled. This change was made for paging, and the version of these boards was changed from 0 to 1. If your reciter is fitted with a version 1 TaitNet or TaitNet RS-232 board, you must use a CTU that is AC coupled. If the CTU and system interface board are both DC coupled, and the test equipment is not AC coupled, the DC signal will directly pull the modulator carrier frequency.

CTUs with the serial number 18012507 and higher incorporate the change on the PCB, but earlier CTUs must be modified as described in TN-1082. To check if your CTU has been modified, use a multimeter to check the continuity between the centre pin of the unbalanced input BNC connector (UB INPUT) and pin 6 of the 15-way system interface connector (or pin 5 of the 25-way connector). An open circuit indicates the capacitor is fitted, a short circuit indicates the capacitor is not fitted.

To check the version of a system interface board, run the Service Kit and select Monitor > Module Details > Reciter. In the **Versions** area, the **System Interface** field displays the version number.

3 Using the CTU with a TB7100

The CTU provides a selection of input and output connectors that allow the TB7100 base station to be connected to standard test equipment. These inputs, outputs and associated controls are identified in [Figure 3.1 on page 12](#), and their functions are explained in the paragraphs which follow. Some items are not used with the TB7100, and others serve one function with the TB7100 and another with the TB8100 or TB9100. Any differences in function are described in the table that accompanies [Figure 3.1](#). A block diagram of the CTU is provided in [Figure B.1 on page 40](#).

The CTU is designed to make it easier to tune or calibrate TB7100 modules. It also allows a user to monitor and control the inputs and outputs available on the TB7100 system interface connector.



Note Digital/programming input switch 6 is used to control Rx Inhibit in the TB7100. Setting this switch to active will prevent any audio output from the base station. Be careful not to set this switch by accident.

[Figure 3.2 on page 16](#) shows a typical connection setup between the CTU and a TB7100 base station. Refer to the TB7100 Calibration Application online Help for details on tuning and calibrating TB7100 modules. Refer also to the TB7100 Installation and Operation Manual for information on using the CTU to set up the TB7100 for various modes of operation.

Figure 3.1 CTU connections and controls

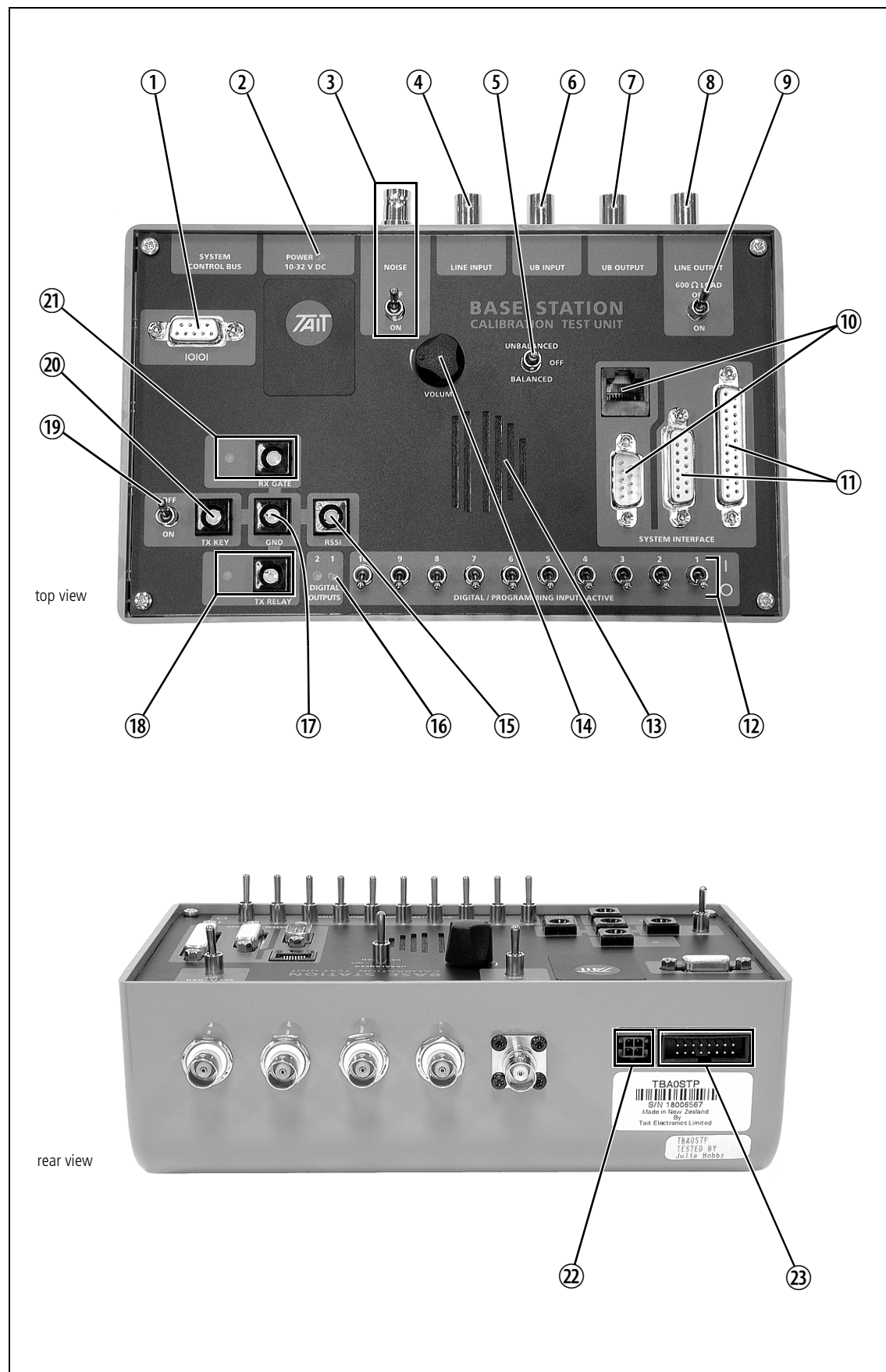

	TB7100	TB8100	TB9100	
①	not used	programming port	serial port	①
②	power LED	power LED	power LED	②
③	not used	noise source output and on/off switch	noise source output and on/off switch	③
④	balanced line input	balanced line input	analog line input	④
⑤	speaker audio selection switch	speaker audio selection switch	speaker audio selection switch	⑤
⑥	unbalanced line input	unbalanced line input	not used	⑥
⑦	unbalanced line output	unbalanced line output	not used	⑦
⑧	balanced line output	balanced line output	analog line output	⑧
⑨	600Ω load on/off switch	600Ω load on/off switch	600Ω load on/off switch	⑨
⑩	not used	not used	system interface connectors	⑩
⑪	system interface connector ^a	system interface connectors	not used	⑪
⑫	digital input switches ^b	digital input switches	digital input switches	⑫
⑬	speaker	speaker	speaker	⑬
⑭	speaker volume control	speaker volume control	speaker volume control	⑭
⑮	RSSI output	RSSI output	digital output 0	⑮
⑯	not used	digital output LEDs	not used	⑯
⑰	ground connector	ground connector	ground connector	⑰
⑱	Tx Relay output and LED	Tx Relay output and LED; digital out 3 (TaitNet)	digital input 4	⑱
⑲	keying switch for the transmitter	keying switch for the transmitter	keying switch for the transmitter	⑲
⑳	Tx Key input	Tx Key input	Tx Key input	⑳
㉑	Rx Gate output and LED	Rx Gate output and LED	Rx Gate output and LED	㉑
㉒	not used	DC input	DC input	㉒
㉓	not used	system control bus connector	not used	㉓

a. The TB7100 uses the 25-way connector with the TB7100 CTU adaptor board (refer to [“The TB7100 CTU Adaptor Board”](#) on page 17).

b. Switches 1 to 4 can be configured as digital inputs or channel select. Switch 6 is used for Rx inhibit. The other switches are not used. Refer to [“DIGITAL/PROGRAMMING INPUTS”](#) on page 15 for more information.

- ① **IOIOI** Not used with TB7100.
- ② **POWER** The POWER LED is lit when the CTU is powered up. The TB7100 system interface provides power to the CTU over the 25-way system interface connector ⑩ (see also [Figure 3.2 on page 16](#)). This supply powers the noise source, speaker, LEDs, and RS-232 communications.
- Connecting power directly to the DC input connector ② on the CTU is unnecessary, but will not damage the CTU.
-  **Note** You do not need to provide power to the CTU at all in order to make audio level measurements or to use the digital inputs and outputs. Lack of power will not affect these interfaces.
- ③ **NOISE** Not used with TB7100.
- ④ **LINE INPUT** The CTU makes audio at this input available to the TB7100 transmitter (it connects LINE INPUT to the balanced line input on the system interface connectors).
- ⑤ **UNBALANCED/OFF/BALANCED** This switch directs either the balanced or unbalanced receiver output audio to the CTU speaker. When set to “OFF”, no audio is present on the speaker.
- ⑥ **UB INPUT** This input is connected to the unbalanced line input on the system interface connectors.
- ⑦ **UB OUTPUT** This output is connected to the unbalanced line output on the system interface connectors. Audio on this line can be monitored on the CTU speaker.
- ⑧ **LINE OUTPUT** The CTU makes audio from the TB7100 receiver available on this connector (it connects LINE OUTPUT to the balanced line output on the system interface connector). LINE OUTPUT is connected directly to pins 1 & 2 on the connector (i.e. it is not grounded). The audio on LINE OUTPUT can be monitored on the CTU speaker.
- ⑨ **600Ω LOAD** This switch connects or disconnects the 600Ω load across the balanced LINE OUTPUT. This allows the output to be terminated correctly for calibration procedures. Turn the switch on if the LINE OUTPUT is not otherwise terminated.
- ⑩ **SYSTEM INTERFACE** Not used with TB7100.
- ⑪ **SYSTEM INTERFACE** The 25-way connector is used with the TB7100 CTU adaptor board to connect to the 25-way connector on the rear of the TB7100.

- ⑫ **DIGITAL/
PROGRAMMING
INPUTS** These switches let you set the digital inputs into the TB7100 high or low, and are connected to the digital inputs on the system interface connector. Switches 1 to 4 can be used for channel selection, and switch 6 is used to control Rx Inhibit. The remaining switches are not used with the TB7100.
- The active state of the digital inputs is defined by the setting in the Programming Application software (Channel Setup > Programmable I/O > Digital tab: AUX_GPI1, AUX_GPI2, AUX_GPI3, AUX_GPIO4). The default setting is non-inverted: 0 = active, 1 = inactive.
- ⑬ **Speaker** The CTU is fitted with a 0.5 W 16Ω speaker. Audio from LINE OUTPUT or UB OUTPUT can be connected to this speaker.
- ⑭ **VOLUME** This controls the volume of the speaker. Rotate clockwise to increase the volume, and anticlockwise to decrease the volume.
- ⑮ **RSSI** This output is used to monitor the RSSI output from the 25-way system interface connector.
- ⑯ **DIGITAL OUTPUTS** Not used with TB7100.
- ⑰ **GND** This banana socket can be used as ground with RX GATE, TX KEY and RSSI. It is connected to the CTU and system interface connector ground.
- ⑱ **TX RELAY** This output is connected to the Tx Relay output on the 25-way system interface connector. The LED is lit when the output is activated.
- ⑲ **TX KEY Switch** Set this switch to “ON” to key the transmitter. When the switch is in the “OFF” position, applying a signal to the TX KEY banana socket will control the state of the transmitter.
- ⑳ **TX KEY socket** Ground this input to key the transmitter. Alternatively, turn on the TX KEY switch (⑲).
- ㉑ **RX GATE** This output is connected to the Rx Gate output on the system interface connectors. The adjacent LED is lit when the receiver gate is open.
- ㉒ **POWER** Not used with TB7100.
- ㉓ **SYSTEM CONTROL
BUS** Not used with TB7100.

Figure 3.2 Example CTU connection to a TB7100

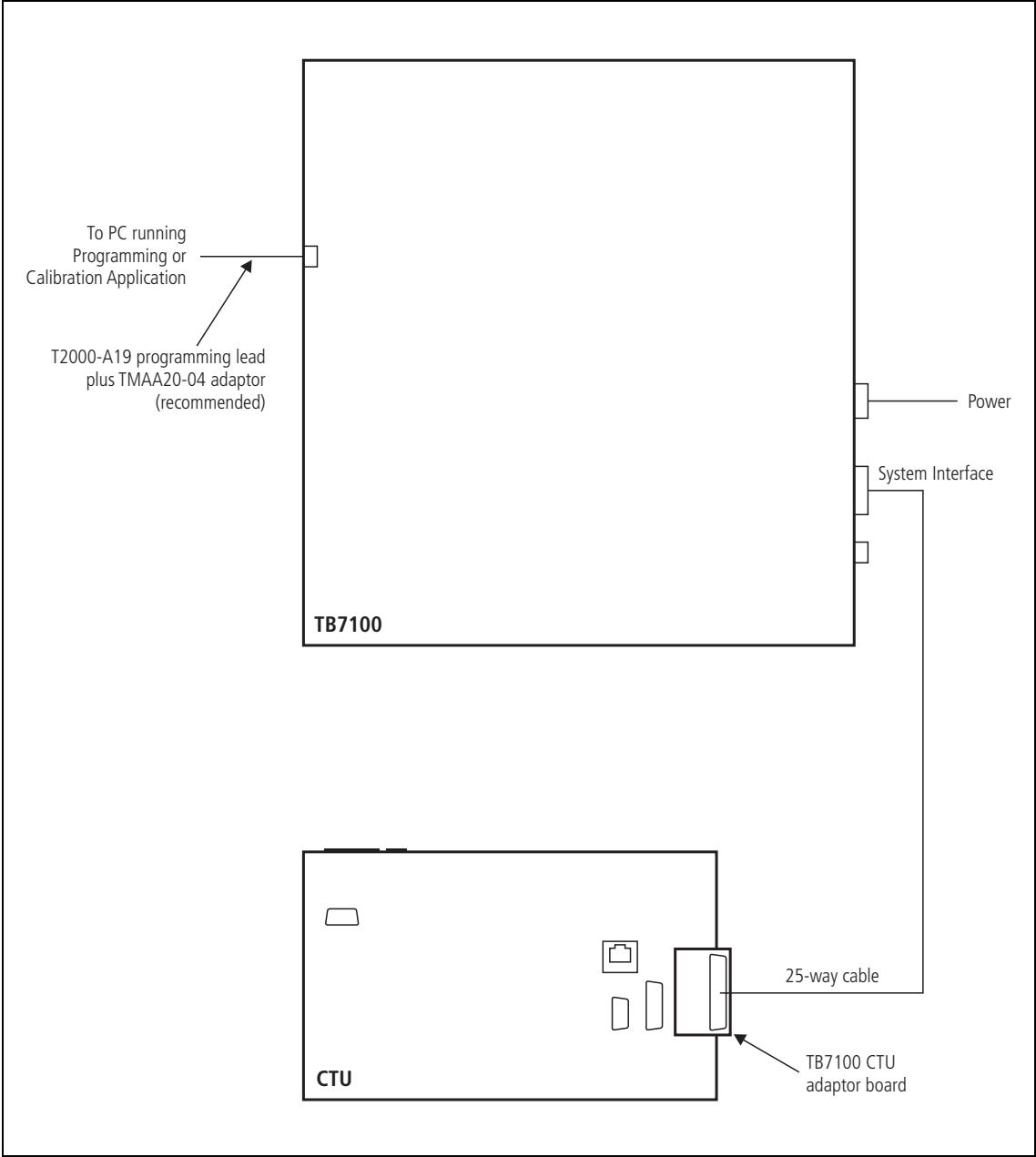

The TB7100 CTU Adaptor Board

You must use the TB7100 CTU adaptor board when connecting a TB7100 base station to the CTU. The CTU adaptor board plugs into the 25-way system interface connector on the CTU. It is designed to make the I/O of the TB7100 system interface compatible with the I/O of the CTU system interface. The LEDs and test points on the adaptor board are described below.

Figure 3.3 LEDs and test points on the TB7100 CTU adaptor board

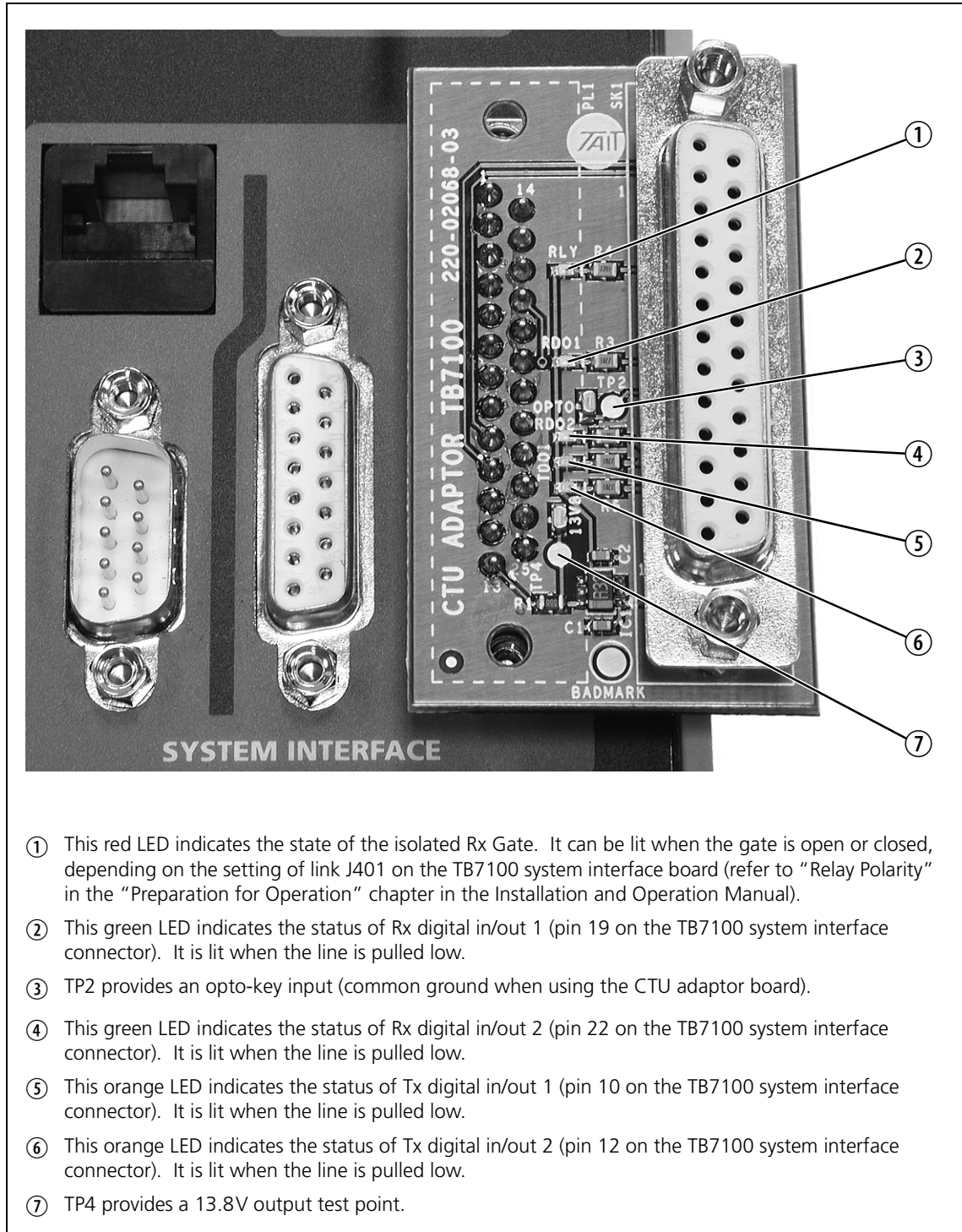

- ① This red LED indicates the state of the isolated Rx Gate. It can be lit when the gate is open or closed, depending on the setting of link J401 on the TB7100 system interface board (refer to "Relay Polarity" in the "Preparation for Operation" chapter in the Installation and Operation Manual).
- ② This green LED indicates the status of Rx digital in/out 1 (pin 19 on the TB7100 system interface connector). It is lit when the line is pulled low.
- ③ TP2 provides an opto-key input (common ground when using the CTU adaptor board).
- ④ This green LED indicates the status of Rx digital in/out 2 (pin 22 on the TB7100 system interface connector). It is lit when the line is pulled low.
- ⑤ This orange LED indicates the status of Tx digital in/out 1 (pin 10 on the TB7100 system interface connector). It is lit when the line is pulled low.
- ⑥ This orange LED indicates the status of Tx digital in/out 2 (pin 12 on the TB7100 system interface connector). It is lit when the line is pulled low.
- ⑦ TP4 provides a 13.8V output test point.

**Note**

You can also use the TB7100 CTU adaptor board with the earlier TBA0ST1 and TBA0STP CTUs (using the supplied 25-way cable). As the adaptor board was not supplied with these CTUs, you can order it separately under the product code TBB0STU-TBB. Contact your nearest Tait Dealer or Customer Service Organisation for more information.

4 Using the CTU with a TB8100

The CTU provides a selection of input and output connectors that allow the TB8100 base station to be connected to standard test equipment, and also to a PC running the Service Kit or Calibration Kit software. These inputs, outputs and associated controls are identified in [Figure 4.1 on page 20](#), and their functions are explained in the paragraphs which follow. Some items are not used with the TB8100, and others serve one function with the TB8100 and another with the TB7100 or TB9100. Any differences in function are described in the table that accompanies [Figure 4.1](#). A block diagram of the CTU is provided in [Figure B.1 on page 40](#).

The CTU is designed to make it easier to program, tune or calibrate TB8100 modules. It also allows a user to monitor and control the inputs and outputs available on the reciter's system interface connector.

[Figure 4.3 on page 26](#) shows a typical connection setup between the CTU and a TB8100 base station. Refer to the TB8100 Calibration Kit documentation for details on how to use the CTU for tuning and calibrating TB8100 modules.



Important

Do not power the CTU from a PMU fitted with a 48V auxiliary power supply board. The maximum supply voltage for the CTU is 32VDC. Use either a PMU 12VDC or 24VDC auxiliary output, or an external power supply. Note that the auxiliary output can be supplied to the CTU via the system interface connector on the reciter if the auxiliary DC power cable is fitted, as well as via a direct connection to the PMU auxiliary output.

Figure 4.1 CTU connections and controls

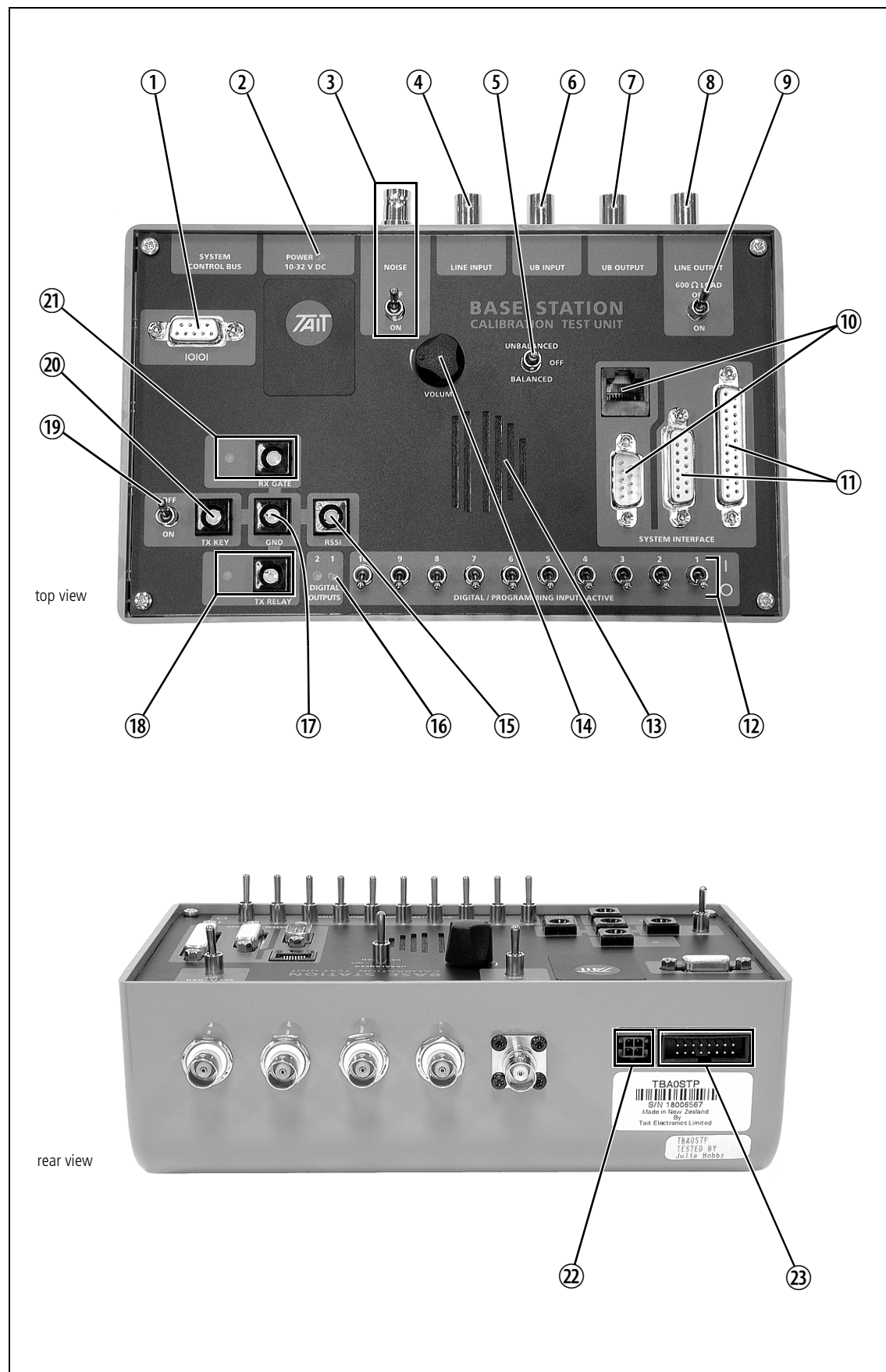

	TB7100	TB8100	TB9100	
①	not used	programming port	serial port	①
②	power LED	power LED	power LED	②
③	not used	noise source output and on/off switch	noise source output and on/off switch	③
④	balanced line input	balanced line input	analog line input	④
⑤	speaker audio selection switch	speaker audio selection switch	speaker audio selection switch	⑤
⑥	unbalanced line input	unbalanced line input	not used	⑥
⑦	unbalanced line output	unbalanced line output	not used	⑦
⑧	balanced line output	balanced line output	analog line output	⑧
⑨	600Ω load on/off switch	600Ω load on/off switch	600Ω load on/off switch	⑨
⑩	not used	not used	system interface connectors	⑩
⑪	system interface connector ^a	system interface connectors	not used	⑪
⑫	digital input switches ^b	digital input switches	digital input switches	⑫
⑬	speaker	speaker	speaker	⑬
⑭	speaker volume control	speaker volume control	speaker volume control	⑭
⑮	RSSI output	RSSI output	digital output 0	⑮
⑯	not used	digital output LEDs	not used	⑯
⑰	ground connector	ground connector	ground connector	⑰
⑱	Tx Relay output and LED	Tx Relay output and LED; digital out 3 (TaitNet)	digital input 4	⑱
⑲	keying switch for the transmitter	keying switch for the transmitter	keying switch for the transmitter	⑲
⑳	Tx Key input	Tx Key input	Tx Key input	⑳
㉑	Rx Gate output and LED	Rx Gate output and LED	Rx Gate output and LED	㉑
㉒	not used	DC input	DC input	㉒
㉓	not used	system control bus connector	not used	㉓

a. The TB7100 uses the 25-way connector with the TB7100 CTU adaptor board (refer to [“The TB7100 CTU Adaptor Board”](#) on page 17).

b. Switches 1 to 4 can be configured as digital inputs or channel select. Switch 6 is used for Rx inhibit. The other switches are not used. Refer to [“DIGITAL/PROGRAMMING INPUTS”](#) on page 15 for more information.

① **IOIOI** This is an RS-232 serial port. Connect it to a PC running the Service Kit or Calibration Kit software when calibrating or tuning the base station. You must also connect a system control bus cable between the CTU (via connector ③) and the reciter for this interface to work.

② **POWER** The POWER LED is lit when the CTU is powered up. You can supply power to the CTU in the following ways (see [Figure 4.3 on page 26](#)):

- connect power directly using the DC input socket ②
- let the reciter provide power over the system control bus connector ③
- let the reciter's system interface provide power over the system interface connector ①. This requires that you connect power to the reciter's auxiliary DC input connector adjacent to the system interface.

You can safely connect power to two or more of these connectors at the same time.



Note You do not need to provide power to the CTU at all in order to make audio level measurements or to use the digital inputs and outputs. Lack of power will not affect these interfaces.



Important Do not power the CTU from a PMU fitted with a 48V auxiliary power supply board. The maximum supply voltage for the CTU is 32VDC. Use either a PMU 12VDC or 24VDC auxiliary output, or an external power supply. Note that the auxiliary output can be supplied to the CTU via the system interface connector on the reciter if the auxiliary DC power cable is fitted, as well as via a direct connection to the PMU auxiliary output.

③ **NOISE** The CTU's internal, wide bandwidth noise source is available on this output. You can connect the NOISE socket to the RF input on the reciter and use it to tune the receiver's front end. The adjacent switch turns the noise on and off. The bandwidth of the noise source is approximately 50MHz to 1 GHz, and the output level is approximately -130 dBm/Hz . This output level is equivalent to -91 dBm typical for a narrow bandwidth receiver, -89 dBm typical for mid bandwidth, and -88 dBm typical for wide bandwidth.

④ **LINE INPUT** The CTU makes audio at this input available to the TB8100 transmitter (it connects LINE INPUT to the balanced line input on the system interface connectors).

⑤ **UNBALANCED/OFF/
BALANCED** This switch directs either the balanced or unbalanced receiver output audio to the CTU speaker. When set to "OFF", no audio is present on the speaker.

- ⑥ **UB INPUT** This input is connected to the unbalanced line input on the system interface connectors.



Note In August 2005, the unbalanced input on the CTU was changed from DC to AC coupled. Refer to [“AC Coupled Unbalanced Audio Input”](#) on page 9 for more details.

- ⑦ **UB OUTPUT** This output is connected to the unbalanced line output on the system interface connectors. Audio on this line can be monitored on the CTU speaker.

- ⑧ **LINE OUTPUT** The CTU makes audio from the TB8100 receiver available on this connector (it connects LINE OUTPUT to the balanced line output on the system interface connectors). LINE OUTPUT is connected directly to pins 1 & 2 on the connectors (i.e. it is not grounded). The audio on LINE OUTPUT can be monitored on the CTU speaker.

- ⑨ **600Ω LOAD** This switch connects or disconnects the 600Ω load across the balanced LINE OUTPUT. This allows the output to be terminated correctly for calibration procedures. Turn the switch on if the LINE OUTPUT is not otherwise terminated.

- ⑩ **SYSTEM INTERFACE** Not used with TB8100.

- ⑪ **SYSTEM INTERFACE** These connect to the 25-way or 15-way system interface connector on the rear of the reciter.

- ⑫ **DIGITAL/
PROGRAMMING
INPUTS** These switches let you set the digital inputs into the TB8100 high or low. The switches are connected to the digital inputs on the system interface connectors, as described in the table below. The standard switch settings are as follows:

1 = high, inactive, 5V (10kΩ pull-up to 5V)
0 = low, active, 0V

The CTU is a generic test unit, so not all digital I/O lines can be exercised or monitored. This applies in particular to the ability to monitor bidirectional I/O lines, as these are connected only to switches, not LEDs (see also DIGITAL OUTPUTS ⑩).

CTU Switch	System Interface Board			
	Pin	Isolated	Isolated E&M	TaitNet/ TaitNet RS-232
1	14	digital in 1	digital in 1	digital in 1
2	15	digital in 2	digital in 2	—
3	16	digital in/out 3	digital in/out 3	—
4	17	digital in/out 4	digital in/out 4	—
5	18	digital in/out 5	digital in/out 5	—
6	19	digital in/out 6	digital in/out 6	—
7	20	digital in 7	—	—
8	21	digital in 8	—	—
9	22	digital in 9	—	—
10	23	digital in 10	—	—



Note The complete lists of pin allocations for each system interface board are provided in the Installation Guide, Installation and Operation Manual, or Service Kit (Configure > Base Station > System Interface).

External Channel Selection

Digital inputs can be used for external channel selection. The active state of the digital inputs, when used for channel selection, is defined by the setting in the Service Kit software (Configure > Base Station > System Interface > Channel Selection > Invert). The default setting is non-inverted: 0 = active, 1 = inactive. Refer to the Service Kit documentation for details on how to configure external channel selection.

Bidirectional Inputs/Outputs

Bidirectional signals (e.g. digital in/out 3) can operate as either digital inputs or digital outputs, based on how Task Manager is configured. Bidirectional signals use the same Task Manager processes to set and read the status of digital inputs and outputs. When a bidirectional pin has its output activated, reading the input status of that pin will reflect the current status on that line. Thus, it is possible to use a bidirectional pin for input-only or output-only actions, if only that specific action is configured for that digital pin number in Task Manager.

Figure 4.2 System interface bidirectional inputs/outputs

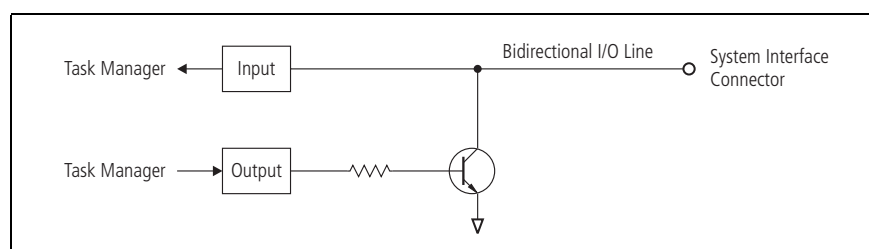

- ⑬ **Speaker** The CTU is fitted with a 0.5 W 16Ω speaker. Audio from LINE OUTPUT or UB OUTPUT can be connected to this speaker.

- ⑭ **VOLUME** This controls the volume of the speaker. Rotate clockwise to increase the volume, and anticlockwise to decrease the volume.

- ⑮ **RSSI** This output is used to monitor the RSSI output from the 25-way system interface connector. (Not available if the system interface connector is 15-way.)

- ⑯ **DIGITAL OUTPUTS** These LEDs indicate the status of the digital output lines on the system interface connectors, as described in the table below. They are lit when the digital output lines are active. Note that the table only shows the digital outputs which can be monitored by the LEDs.

CTU LED	System Interface Board		
	Isolated	Isolated E&M	TaitNet/ TaitNet RS-232
1	pin 11 - digital out 1	pin 11 - digital out 1	pin 12 - digital out 1
2	pin 12 - digital out 2	pin 12 - digital out 2	pin 13 - digital out 2

- ⑰ **GND** This banana socket can be used as ground with RX GATE, TX KEY and RSSI. It is connected to the CTU and system interface connector ground.

- ⑱ **TX RELAY** This output is connected to the Tx Relay output on the 25-way system interface connector, and to digital output 3 on the 15-way system interface connector. The LED is lit when the output is activated.

- ⑲ **TX KEY Switch** Set this switch to “ON” to key the transmitter. When the switch is in the “OFF” position, applying a signal to the TX KEY banana socket will control the state of the transmitter.

- ⑳ **TX KEY socket** Ground this input to key the transmitter. Alternatively, turn on the TX KEY switch (⑲).

- ㉑ **RX GATE** This output is connected to the Rx Gate output on the system interface connectors. The adjacent LED is lit when the receiver gate is open.

- ㉒ **POWER** Connect a 10 to 32VDC power supply to this input. This supply powers the noise source, speaker, LEDs, and RS-232 communications.

This DC input connector is not used if power is supplied via the system control bus or system interface connectors.



Important

Do not power the CTU from a PMU fitted with a 48V auxiliary power supply board. The maximum supply voltage for the CTU is 32VDC. Use either a PMU 12VDC or 24VDC auxiliary output, or an external power supply. Note that the auxiliary output can be supplied to the CTU via the system interface connector on the reciter if the auxiliary DC power cable is fitted, as well as via a direct connection to the PMU auxiliary output.

②③ **SYSTEM CONTROL BUS**

This connects to the system control bus connector on the front of the reciter for tuning, calibration and programming. You can also calibrate a PA when it is linked to a reciter and CTU via the system control bus.



Note

If you need to make your own system control bus cable, the recommended maximum length of the cable is one metre (39 inches).

Figure 4.3 Example CTU connection to a TB8100 reciter

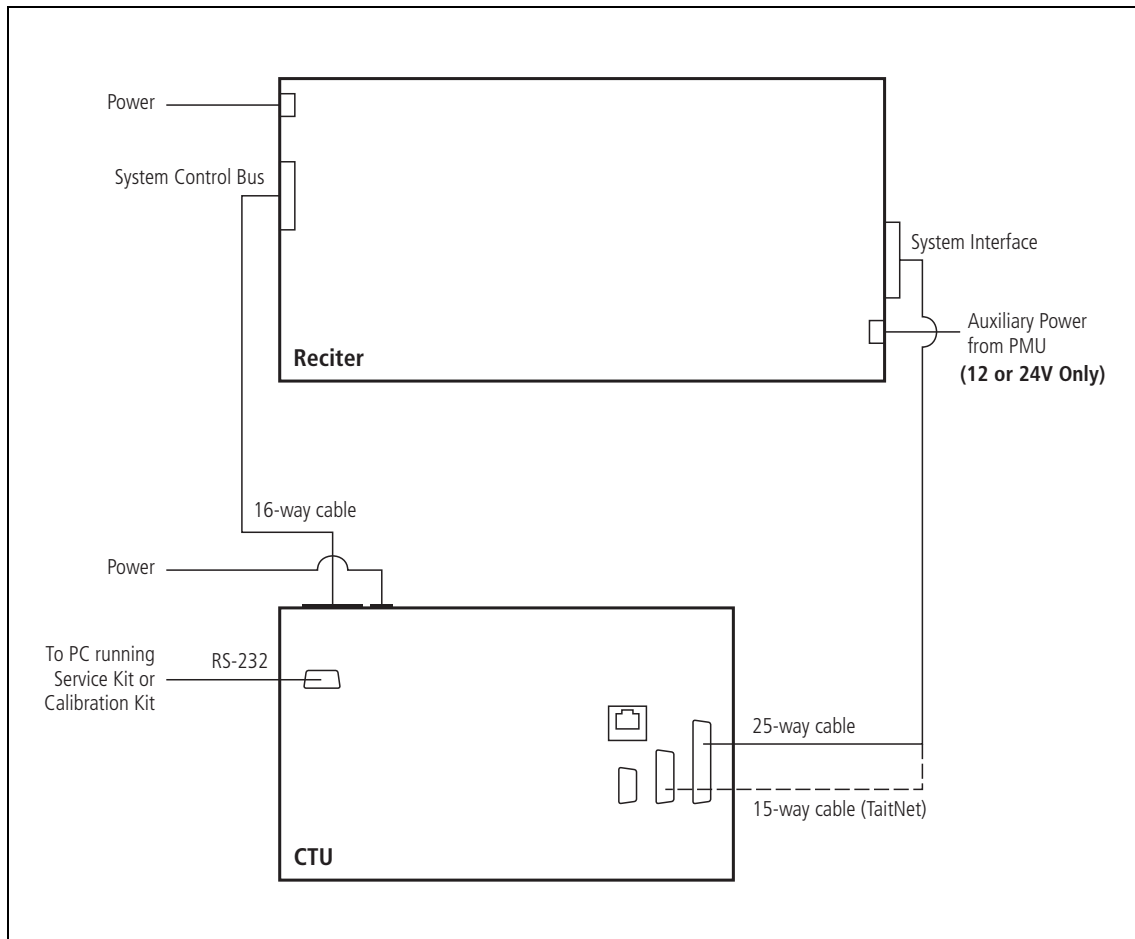

5 Using the CTU with a TB9100

The CTU provides a selection of input and output connectors that allow the TB9100 base station to be connected to standard test equipment, and also to a PC running the Customer Service Software or Calibration Software. These inputs, outputs and associated controls are identified in [Figure 5.1 on page 28](#), and their functions are explained in the paragraphs which follow. Some items are not used with the TB9100, and others serve one function with the TB9100 and another with the TB7100 or TB8100. Any differences in function are described in the table that accompanies [Figure 5.1](#). A block diagram of the CTU is provided in [Figure B.1 on page 40](#).

The CTU is designed to make it easier to program, tune or calibrate TB9100 modules. It also allows a user to monitor the digital output and control the digital inputs on the reciter's 9-way DIG D-range connector.

[Figure 5.2 on page 33](#) shows a typical connection setup between the CTU and a TB9100 base station. Refer to the TB9100 Calibration Software documentation for details on how to use the CTU for tuning and calibrating TB9100 modules.

Figure 5.1 CTU connections and controls

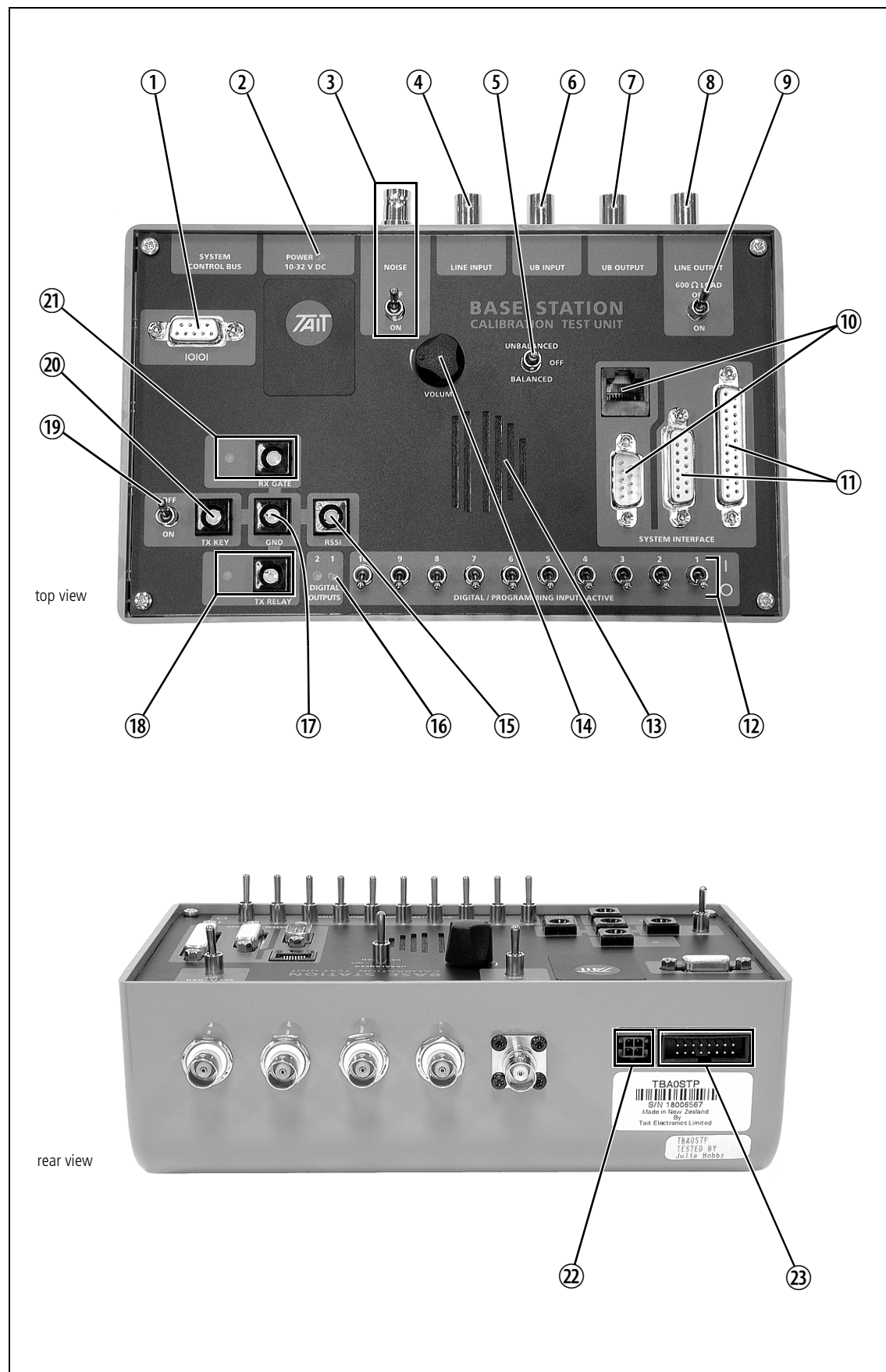

	TB7100	TB8100	TB9100	
①	not used	programming port	serial port	①
②	power LED	power LED	power LED	②
③	not used	noise source output and on/off switch	noise source output and on/off switch	③
④	balanced line input	balanced line input	analog line input	④
⑤	speaker audio selection switch	speaker audio selection switch	speaker audio selection switch	⑤
⑥	unbalanced line input	unbalanced line input	not used	⑥
⑦	unbalanced line output	unbalanced line output	not used	⑦
⑧	balanced line output	balanced line output	analog line output	⑧
⑨	600Ω load on/off switch	600Ω load on/off switch	600Ω load on/off switch	⑨
⑩	not used	not used	system interface connectors	⑩
⑪	system interface connector ^a	system interface connectors	not used	⑪
⑫	digital input switches ^b	digital input switches	digital input switches	⑫
⑬	speaker	speaker	speaker	⑬
⑭	speaker volume control	speaker volume control	speaker volume control	⑭
⑮	RSSI output	RSSI output	digital output 0	⑮
⑯	not used	digital output LEDs	not used	⑯
⑰	ground connector	ground connector	ground connector	⑰
⑱	Tx Relay output and LED	Tx Relay output and LED; digital out 3 (TaitNet)	digital input 4	⑱
⑲	keying switch for the transmitter	keying switch for the transmitter	keying switch for the transmitter	⑲
⑳	Tx Key input	Tx Key input	Tx Key input	⑳
㉑	Rx Gate output and LED	Rx Gate output and LED	Rx Gate output and LED	㉑
㉒	not used	DC input	DC input	㉒
㉓	not used	system control bus connector	not used	㉓

a. The TB7100 uses the 25-way connector with the TB7100 CTU adaptor board (refer to [“The TB7100 CTU Adaptor Board”](#) on page 17).

b. Switches 1 to 4 can be configured as digital inputs or channel select. Switch 6 is used for Rx inhibit. The other switches are not used. Refer to [“DIGITAL/PROGRAMMING INPUTS”](#) on page 15 for more information.

① **IOIOI** This is an RS-232 serial port. Connect it to a PC running the calibration software when calibrating or tuning the base station.

② **POWER** The POWER LED is lit when the CTU is powered up. Power to the CTU is supplied using the POWER socket (see ② below).



Note You do not need to provide power to the CTU at all in order to make audio level measurements, or to use the digital inputs and outputs. Lack of power will not affect these interfaces.



Important Do not power the CTU from a PMU fitted with a 48V auxiliary power supply board. The maximum supply voltage for the CTU is 32VDC. Use either a PMU 12VDC or 24VDC auxiliary output, or an external power supply.

③ **NOISE** The CTU's internal, wide bandwidth noise source is available on this output. You can connect the NOISE socket to the RF input on the reciter and use it to tune the receiver's front end. The adjacent switch turns the noise on and off. The bandwidth of the noise source is approximately 50MHz to 1 GHz, and the output level is approximately -130 dBm/Hz. This output level is equivalent to -91 dBm typical for a narrow bandwidth receiver, -89 dBm typical for mid bandwidth, and -88 dBm typical for wide bandwidth.

④ **LINE INPUT** The CTU makes audio at this input available to the TB9100 transmitter (it connects LINE INPUT to the analog RJ45 connector).

⑤ **UNBALANCED/OFF/
BALANCED** Selects which audio output is sent to the CTU speaker. Select "BALANCED" to direct the audio on LINE OUTPUT to the speaker. If you select "OFF", no audio is present on the speaker.

⑥ **UB INPUT** Not used with TB9100.

⑦ **UB OUTPUT** Not used with TB9100.

⑧ **LINE OUTPUT** The CTU makes audio from the TB9100 receiver available on this connector (it connects LINE OUTPUT to the balanced line output on the analog RJ45 system interface connector). LINE OUTPUT is connected directly to pins 1 & 2 (i.e. it is not grounded). The audio on LINE OUTPUT can also be monitored on the CTU speaker.

- ⑨ **600Ω LOAD** This switch connects or disconnects the 600Ω load across the LINE OUTPUT. This allows the output to be terminated correctly for calibration procedures. Turn the switch on if the LINE OUTPUT socket is not otherwise terminated.
- ⑩ **SYSTEM INTERFACE** The RJ45 connector is used for the analog line and the 9-way connector is used for digital I/O. Connect the RJ45 to the RJ45 AUD connector on the reciter and the 9-way connector to the 9-way DIG connector on the reciter.
- ⑪ **SYSTEM INTERFACE** Not used with TB9100.
- ⑫ **DIGITAL/
PROGRAMMING
INPUTS** These switches let you set the digital inputs into the TB9100 high or low. Only the first four are used with TB9100. These switches are connected to the digital input lines on the 9-way system interface connector. Digital inputs can be used for external channel selection. Refer to the Customer Service Software documentation for details on how to configure this.



Note The TB9100 digital inputs are numbered 0 to 4 on the CSS, which correspond to digital inputs 1 to 4 and TX RELAY on the CTU.

TB9100 Digital Input	CTU Digital Input
0	Switch 1
1	Switch 2
2	Switch 3
3	Switch 4
4	TX RELAY (see ⑱)

Set the switch to position “1” to set the digital input high. Set the switch to position “0” to set the digital input low.

- ⑬ **Speaker** The CTU is fitted with a 0.5 W 16Ω speaker. Audio from LINE OUTPUT can be connected to this speaker.
- ⑭ **VOLUME** This controls the volume of the speaker. Rotate clockwise to increase the volume, and anticlockwise to decrease the volume.
- ⑮ **RSSI** This banana socket is used as digital output 0 by the TB9100.
- ⑯ **DIGITAL OUTPUTS** Not used with TB9100.

- ⑰ **GND** This banana socket can be used as ground with RX GATE, TX KEY, RSSI, and TX RELAY. It is connected to the CTU and system interface connector ground.
- ⑱ **TX RELAY** This banana socket is used by the TB9100 as digital input 4. Ground this input to set the input low. The LED alongside is not used by the TB9100.
- ⑲ **TX KEY switch** Set this switch to “ON” to key the transmitter. When the switch is in the “OFF” position, applying a signal to the TX KEY banana socket will control the state of the transmitter.
- ⑳ **TX KEY socket** Ground this input to key the transmitter. Alternatively, turn on the TX KEY switch (⑲).
- ㉑ **RX GATE** This LED is lit when the base station puts audio on the analog line. The adjacent socket is connected to the Rx Gate output (E & M output) on the analog RJ45 SYSTEM INTERFACE connector.
- ㉒ **POWER** Connect a 10 to 32VDC power supply to this input. This supply powers the noise source, speaker, LEDs, and RS-232 communications.



Important

Do not power the CTU from a PMU fitted with a 48V auxiliary power supply board. The maximum supply voltage for the CTU is 32VDC. Use either a PMU 12VDC or 24VDC auxiliary output, or an external power supply.

- ㉓ **SYSTEM CONTROL BUS** Not used with TB9100.

Figure 5.2 Example CTU connection to a TB9100 reciter

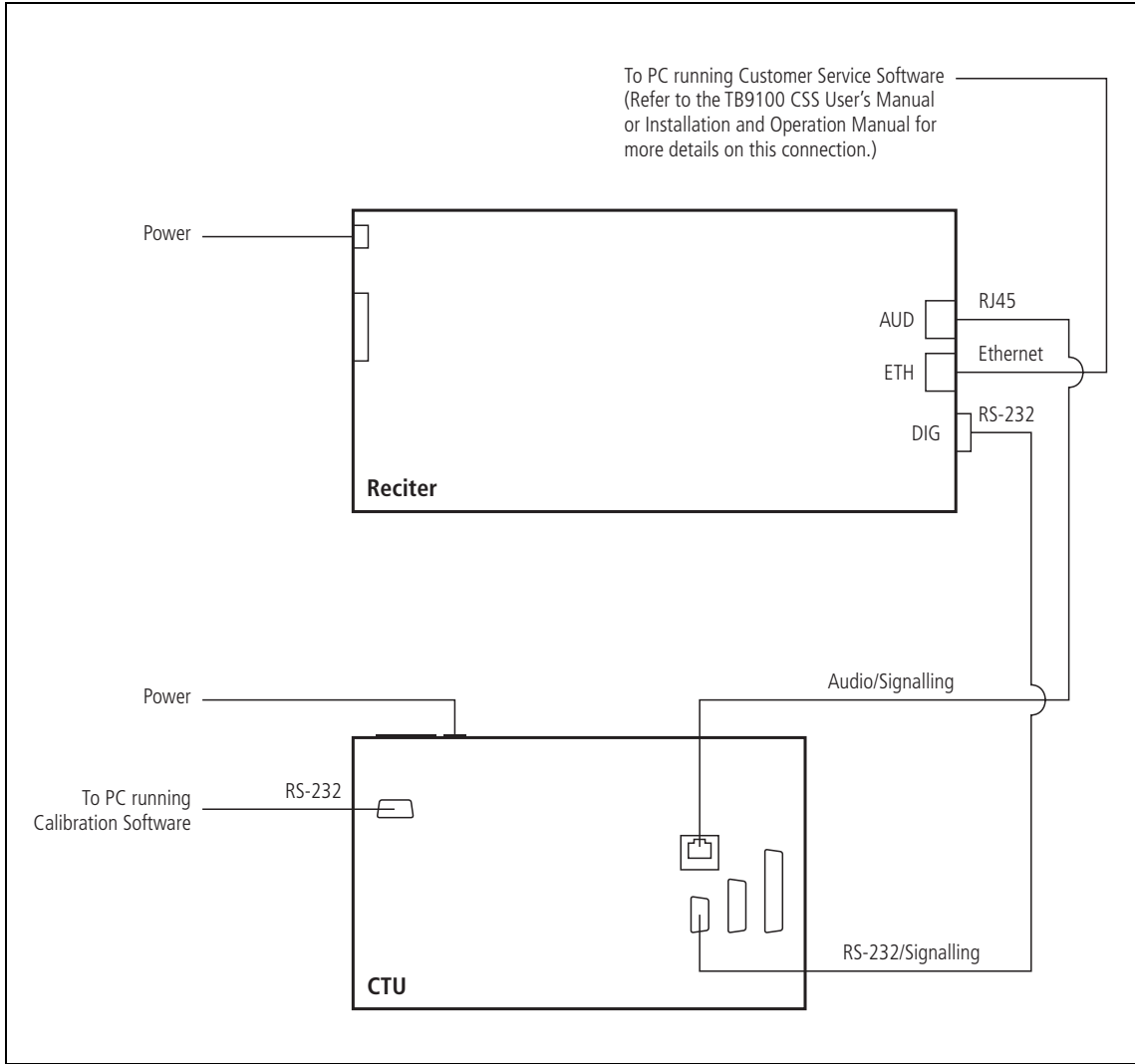

Appendix A - CTU Accessories

The TBA0STU base station CTU is supplied with the following accessories:

- a selection of cables which allow the CTU to be connected to a TB7100, TB8100, or TB9100 base station
- an adaptor board for connecting the CTU to a TB7100 base station
- DC power cables
- a DC power connector for use with the PMU auxiliary DC output (refer to [“Using a PMU to Power the CTU” on page 37](#))
- tuning tools.

These accessories are described and identified in [Figure A.1 on page 36](#).

Figure A.1 Accessories supplied with the TBA0STU base station CTU

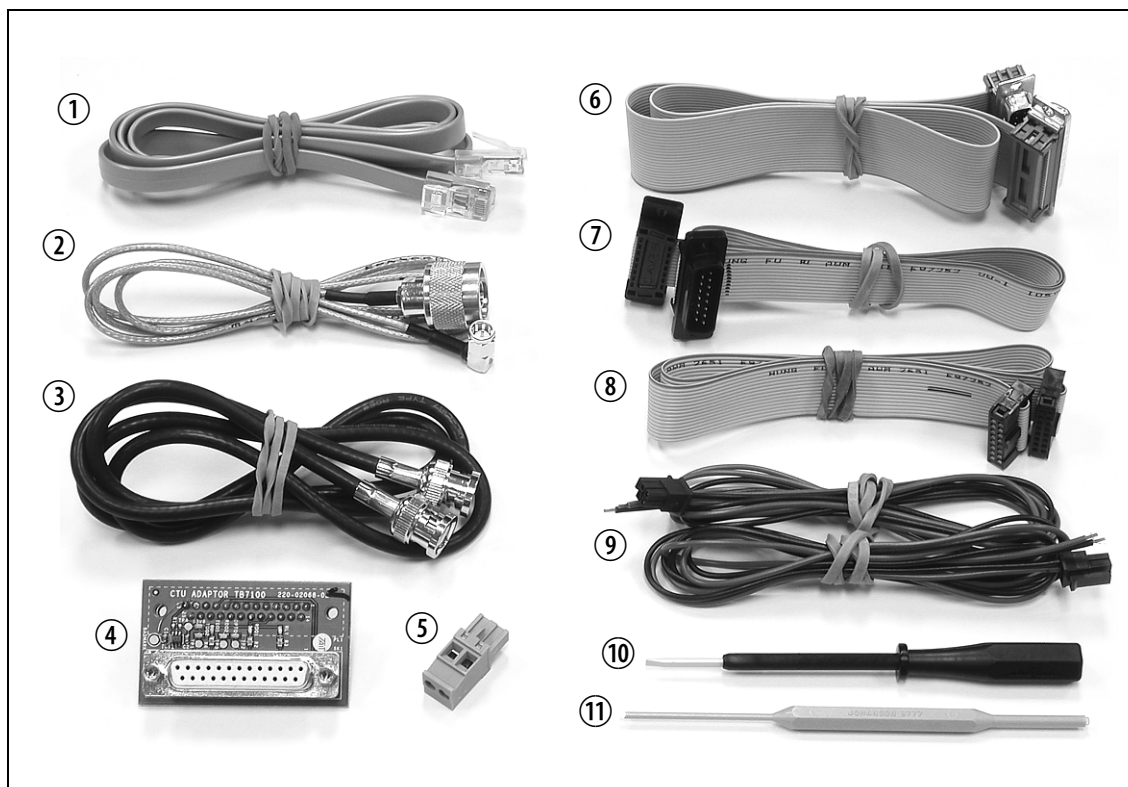

	Part Number	Description	TB7100	TB8100	TB9100
①	219-03003-00	RJ45 cable			✓
②	219-02893-00	SMA-to-N-type cable		✓	✓
③	219-02892-00	BNC-to-BNC cable	✓	✓	✓
④	TBB0STU-TBB	TB7100 CTU adaptor board for use with 25-way cable	✓		
⑤	240-00022-11	power connector for PMU auxiliary DC output		✓	✓
⑥	219-02888-00	25-way cable (D-range)	✓	✓	
⑦	219-02889-00	15-way cable (TaitNet D-range)		✓	
⑧	219-02890-00	16-way cable (system control bus)		✓	✓
⑨	219-02891-00	DC power cables		✓	✓
⑩	937-00012-00	tuning tool (Murata ceramic)	✓	✓	✓
⑪	937-00013-00	tuning tool (Johanson 8777)		✓	✓

Using a PMU to Power the CTU

The CTU can be powered from the auxiliary DC output at the rear of the PMU¹. Connect the CTU to the PMU using one of the supplied DC power cables ⑨ fitted with the supplied power connector ⑤ (as shown in Figure A.1).

The pin allocations for the 2-way auxiliary DC output connector on the PMU² are given in the following table.

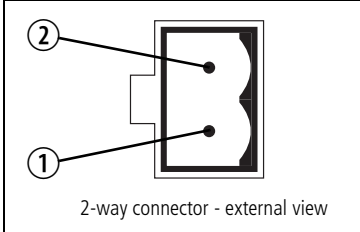
	Pin	Description
 2-way connector - external view	1	+V output
	2	ground



Important

Do not power the CTU from a PMU fitted with a 48V auxiliary power supply board. The maximum supply voltage for the CTU is 32VDC. Use either a PMU 12VDC or 24VDC auxiliary output, or an external power supply. Note that the auxiliary output can be supplied to the CTU via the system interface connector on the reciter if the auxiliary DC power cable is fitted, as well as via a direct connection to the PMU auxiliary output.

1. The PMU must be fitted with an optional auxiliary power supply board.
2. This type of connector is fitted to PMUs manufactured from August 2004 onwards .

Appendix B - CTU Block Diagram

A block diagram of the CTU is provided on following page.

Figure B.1 CTU Block Diagram

