

REPORT NUMBER 2229

JUNE 2005

## RADIO PERFORMANCE MEASUREMENTS

On the TBAL0 Base Station Transceiver

### FCC ID: CASTBAL0

Comprising of:

FUNCTIONAL DESCRIPTION	PRODUCT DESIGNATION CODE	SERIAL NUMBER
Reciter	TBA40L2-0B00	18008128
Power Amplifier	TBA90L0-0000 TBA71L0-0000	18009502 18007939
Power Management Unit	TBA30A1-1100	18004551
High Stability Oscillator	T801-20-000	13122298

In accordance with

FCC 47 CFR Parts 22 & 90

PREPARED BY: Garry Pringle \_\_\_\_\_  
Test Technician

CHECKED & APPROVED BY: Hamish Newton \_\_\_\_\_  
Senior Technician



All tests reported herein have been performed in accordance with the laboratory's scope of accreditation

This document must not be reproduced except in full, without the written permission of the Compliance Laboratory Manager.

## REPORT ON :

Type Approval Testing of the TBAL0 in accordance with:

FCC 47 CFR Parts 22 & 90

FCC ID: CASTBAL0

## PREPARED FOR :

Tait Electronics Ltd  
PO Box 1645  
558 Wairakei Rd  
Christchurch  
New Zealand

## DISTRIBUTION :

TELTest Laboratory	Mr S Crompton	Copy No 1
Tait Electronics Ltd	Mr. Des Fox	Copy No 2
Tait Electronics Ltd	Mr. Ian MacKay	Copy No 3

## APPROVED :

Hamish Newton  
Senior Technician

Date :

Copy No:

## TABLE OF CONTENTS

<b>DECLARATION OF CONFORMITY</b> .....	<b>4</b>
<b>TEST CONDITIONS</b> .....	<b>5</b>
<b>NECESSARY BANDWIDTH AND EMISSION DESIGNATORS</b> .....	<b>5</b>
<b>TEST RESULTS</b> .....	<b>7</b>
TRANSMITTER OUTPUT POWER (CONDUCTED) .....	7
TRANSMITTER AUDIO FREQUENCY RESPONSE - PRE-EMPHASIS .....	8
TRANSMITTER MODULATION LIMITING .....	9
TRANSMITTER MODULATION LIMITING .....	10
<i>ANALOGUE VOICE</i> .....	12
<i>FFSK</i> .....	20
<i>Paging - POCSAG</i> .....	28
SPURIOUS EMISSIONS (CONDUCTED).....	52
SPURIOUS EMISSIONS (RADIATED).....	55
TRANSMITTER FREQUENCY STABILITY (TEMPERATURE) .....	58
TRANSMITTER FREQUENCY STABILITY (VOLTAGE) .....	61
<b>TEST EQUIPMENT USED</b> .....	<b>62</b>
<b>APPENDIX A</b> .....	<b>63</b>
TEST SETUP DETAILS.....	63

## DECLARATION OF CONFORMITY

We, TELTEST LABORATORIES of 558 Wairakei Road, Christchurch New Zealand, declare under our sole responsibility that the product:

Equipment: Base Station Transceiver

Type: TBAL0

FUNCTIONAL DESCRIPTION	PRODUCT DESIGNATION CODE	SERIAL NUMBER
Reciter	TBA40L2-0B00	18008128
Power Amplifier	TBA90L0-0000 TBA71L0-0000	18009502 18007939
Power Management Unit	TBA30A1-1100	18004551
High Stability Oscillator	T801-20-000	13122298

Quantity: 1 each

To which this declaration relates is in conformity with the following standards:

### FCC 47 CFR Parts 22 & 90

Signature: \_\_\_\_\_

S. A. Crompton  
Compliance Laboratory Manager.

Date: \_\_\_\_\_



## 2. FFSK – Fast frequency shift keying

### 25kHz Bandwidth

Necessary bandwidth

Emission Designator

M = 1.8 kHz

D = 3.0 kHz

### 9K60F2D

F2D represents a FM data transmission with the use of a modulating sub carrier

$$\begin{aligned} B_n &= 3.6 + 6 \times 1 \\ &= 9.6\text{kHz} \end{aligned}$$

## 3. Paging - POCSAG

### 12.5kHz Bandwidth

Necessary bandwidth

Emission Designator

Baud rate = 512

M = 512

D = 2.25kHz

### 5K90F1D

F1D represents a FM data transmission without the use of a modulating sub carrier

$$\begin{aligned} B_n &= 512 + 4500 \times 1.2 \\ &= 5.9 \text{ kHz} \end{aligned}$$

Baud rate = 1200

M = 1200

D = 2.25kHz

### 6K60F1D

F1D represents a FM data transmission without the use of a modulating sub carrier

$$\begin{aligned} B_n &= 1200 + 4500 \times 1.2 \\ &= 6.6 \text{ kHz} \end{aligned}$$

Baud rate = 2400

M = 2400

D = 2.25kHz

### 7K80F1D

F1D represents a FM data transmission without the use of a modulating sub carrier

$$\begin{aligned} B_n &= 2400 + 4500 \times 1.2 \\ &= 7.8 \text{ kHz} \end{aligned}$$

### 25kHz Bandwidth

Necessary bandwidth

Emission Designator

Baud rate = 512

M = 512

D = 4.5kHz

### 11K3F1D

F1D represents a FM data transmission without the use of a modulating sub carrier

$$\begin{aligned} B_n &= 512 + 9000 \times 1.2 \\ &= 11.3 \text{ kHz} \end{aligned}$$

Baud rate = 1200

M = 1200

D = 4.5kHz

### 12K0F1D

F1D represents a FM data transmission without the use of a modulating sub carrier

$$\begin{aligned} B_n &= 1200 + 9000 \times 1.2 \\ &= 12.0\text{kHz} \end{aligned}$$

Baud rate = 2400

M = 2400

D = 4.5kHz

### 13K2F1D

F1D represents a FM data transmission without the use of a modulating sub carrier

$$\begin{aligned} B_n &= 2400 + 9000 \times 1.2 \\ &= 13.2 \text{ kHz} \end{aligned}$$

## Test Results

### TRANSMITTER OUTPUT POWER (CONDUCTED)

SPECIFICATION: FCC 47 CFR 2.1046

GUIDE: TIA/EIA-603B 2.2.1

**MEASUREMENT PROCEDURE:**

1. Refer Appendix A for Equipment set up.
2. The coaxial attenuator has an impedance of 50 Ohms.
3. The unmodulated output power was measured with an RF Power meter.

**MEASUREMENT RESULTS:**

Power Amplifier: 100W		
Frequency	100 W nominal	10 W nominal
937.5 MHz	88.03	8.98
Variation from Nominal (%)	-11.97	-10.20
929.5 MHz	89.9	9.1
Variation from Nominal (%)	-10.1	-9.0
Measurement Uncertainty (dB)	+0.63 -0.68	

12v Power Amplifier: 5W		
Frequency	5 W nominal	1 W nominal
937.5 MHz	4.48	0.93
Variation from Nominal (%)	-10.40	-7.00
929.5 MHz	4.59	0.96
Variation from Nominal (%)	-8.20	-4.00
Measurement Uncertainty (dB)	+0.63 -0.68	

LIMIT CLAUSE: FCC 47 CFR 90.205 (r)

Radio Type: Base Station Transceiver  
Frequency Band: 935 MHz ~ 940 MHz

The output power shall not exceed by more than 20% the manufacturer's rated output power for the particular transmitter.

TRANSMITTER AUDIO FREQUENCY RESPONSE - PRE-EMPHASIS

SPECIFICATION: FCC 47 CFR 2.1047 (a)

GUIDE: TIA/EIA-603B 2.2.6

MEASUREMENT PROCEDURE:

1. Refer Appendix A for Equipment set up.
2. An audio input tone of 1000Hz was applied with the level set to obtain 20% of maximum deviation. This was used as the 0dB reference point.
3. The AF was varied while the audio level was held constant.
4. The response in dB relative to 1000Hz was measured.

MEASUREMENT RESULTS:

See the plot below for 12.5 kHz channel spacing.

LIMIT CLAUSE: TIA/EIA-603B 3.2.6

Tx FREQUENCY: 937.6 MHz 12.5 kHz Channel Spacing

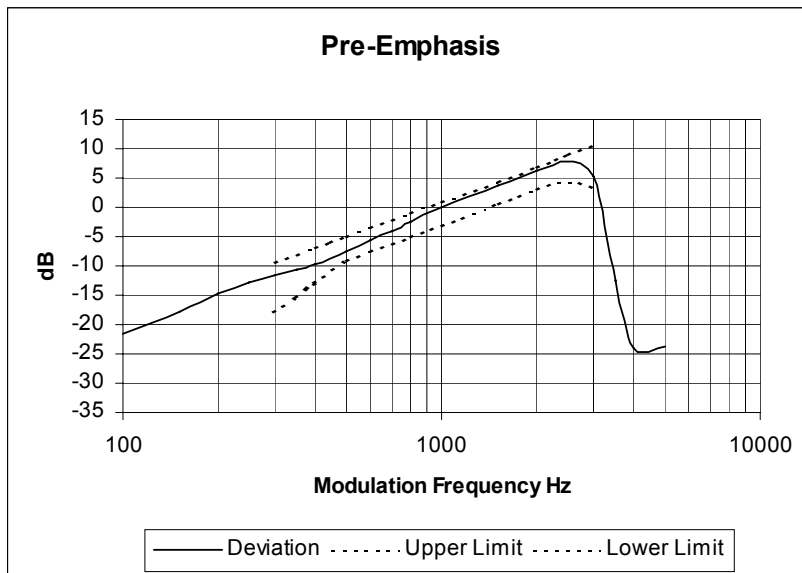

Tx FREQUENCY: 929.5 MHz 25 kHz Channel Spacing

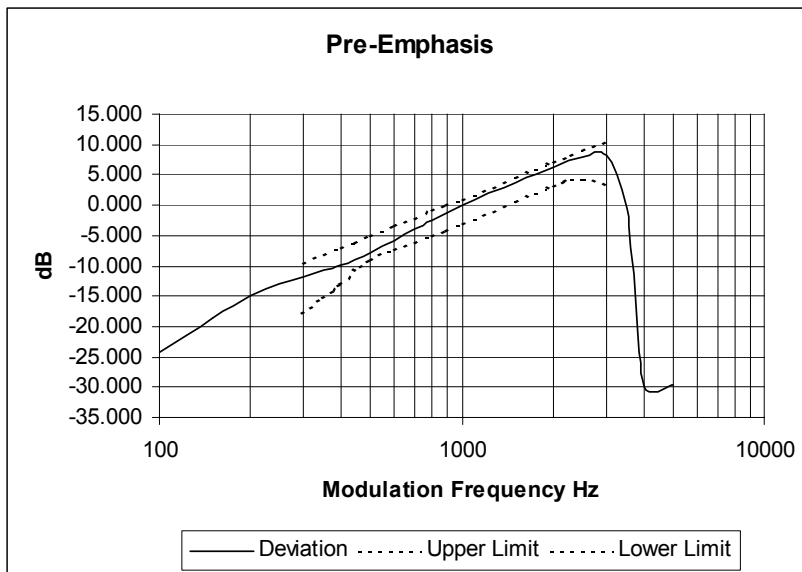



## TRANSMITTER MODULATION LIMITING

SPECIFICATION: FCC 47 CFR 2.1047 (b)

### MEASUREMENT PROCEDURE:

1. Refer Appendix A for Equipment set up.
2. The modulation response was measured at three audio frequencies while varying the input level.
3. Measurements were made for both Positive and Negative Deviation.

### MEASUREMENT RESULTS:

See the plots below for 12.5 kHz channel spacing.

LIMIT CLAUSE: TIA/EIA-603B 1.3.4.4

Tx FREQUENCY: 937.6 MHz 12.5 kHz Channel Spacing

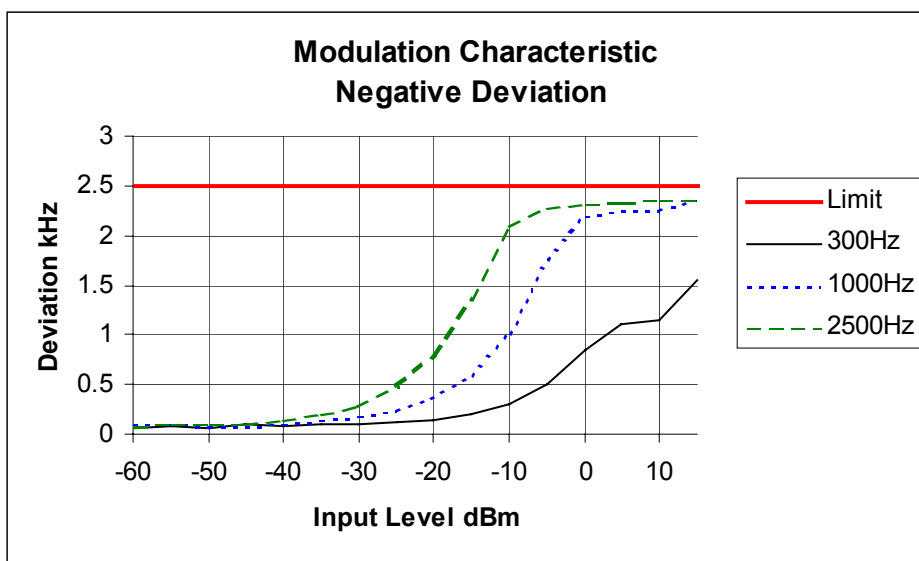
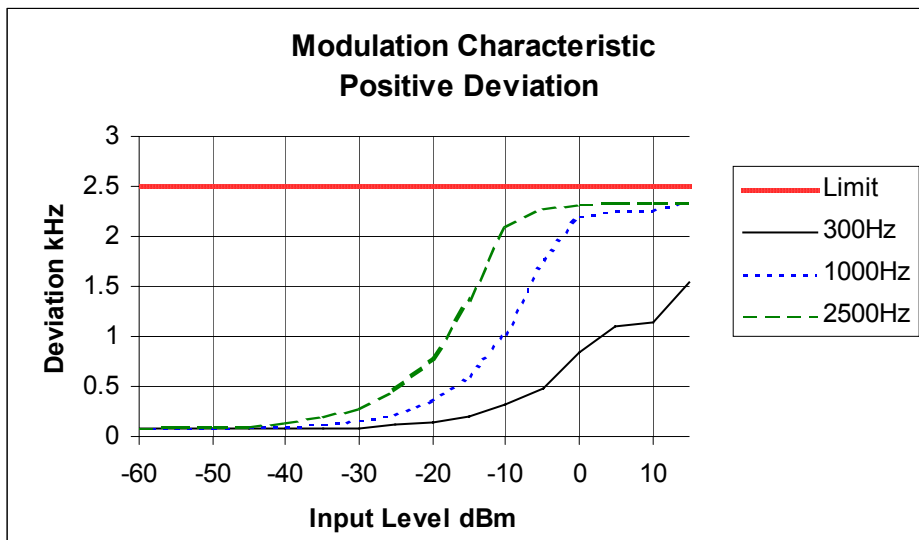

TRANSMITTER MODULATION LIMITING

SPECIFICATION: FCC 47 CFR 2.1047 (b)

Tx FREQUENCY: 929.5 MHz 25 kHz Channel Spacing

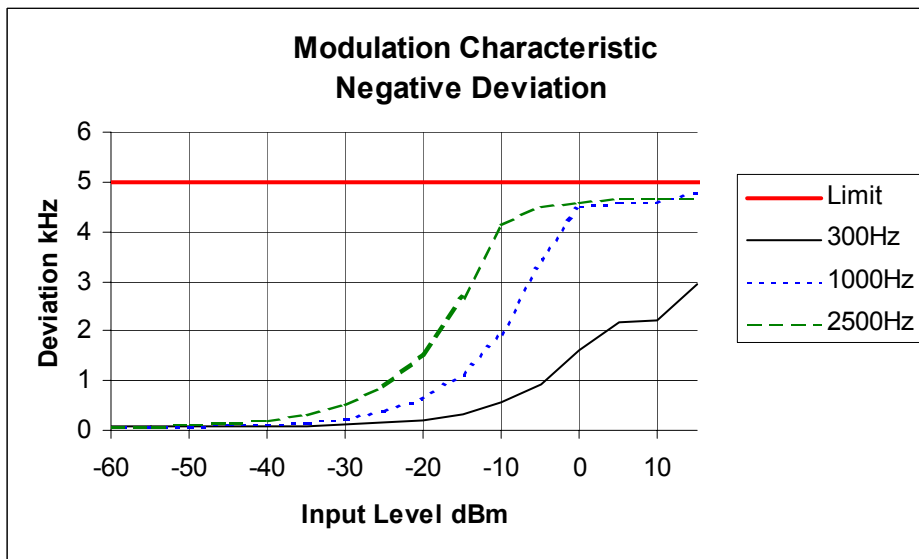
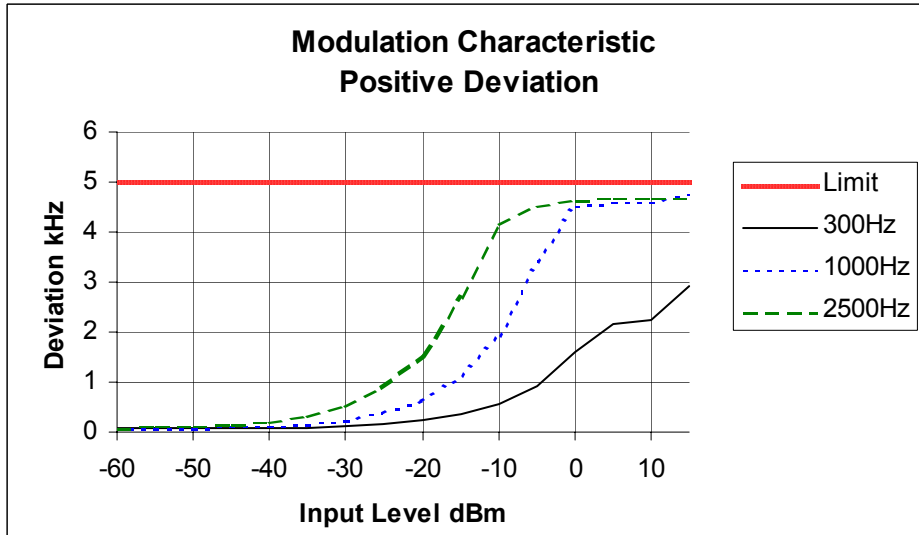

## OCCUPIED BANDWIDTH

SPECIFICATION: FCC 47 CFR 2.1049 (c)

GUIDE: TIA/EIA-603B 2.2.11

**MEASUREMENT PROCEDURE:**

1. Refer Appendix A for Equipment Set up.
2. For analogue measurements: The EUT was modulated by a 2500Hz tone at an input level 16dB above a level that produced 50% deviation. The input level was established at the frequency of maximum response of the audio modulating circuit.  
For Data measurements: The EUT was modulated with an externally generated bit sequence at the appropriate Baud rates.
3. The Occupied Bandwidth was measured on the Spectrum Analyser, with bandwidth settings as shown on measurement graphs.

**MEASUREMENT RESULTS:**

See the plots on the following pages.

LIMIT CLAUSE: FCC 47 CFR 90.210  
FCC 47 CFR 22.359

929 – 930 MHz		
Emission Mask B	12.5 kHz Channel Spacing	Analogue
Emission Mask B	12.5 kHz Channel Spacing	FFSK
Emission Mask G	12.5 kHz Channel Spacing	Paging
Emission Mask G	25.0 kHz Channel Spacing	Paging
935 – 940 MHz		
Emission Mask I	12.5 kHz Channel Spacing	Analogue
Emission Mask I	12.5 kHz Channel Spacing	FFSK
Emission Mask G	12.5 kHz Channel Spacing	Paging
Emission Mask G	25.0 kHz Channel Spacing	Paging

**DATA SPEED**

FFSK	12.5 kHz Channel Spacing	1200 bps
Paging	12.5 kHz Channel Spacing	512 1200 2400 Baud
Paging	25.0 kHz Channel Spacing	512 1200 2400 Baud

OCCUPIED BANDWIDTH

ANALOGUE VOICE

SPECIFICATION: FCC CFR 2.1049 (c)

Tx FREQUENCY: 929.5 MHz 100 W 12.5 kHz Channel Spacing

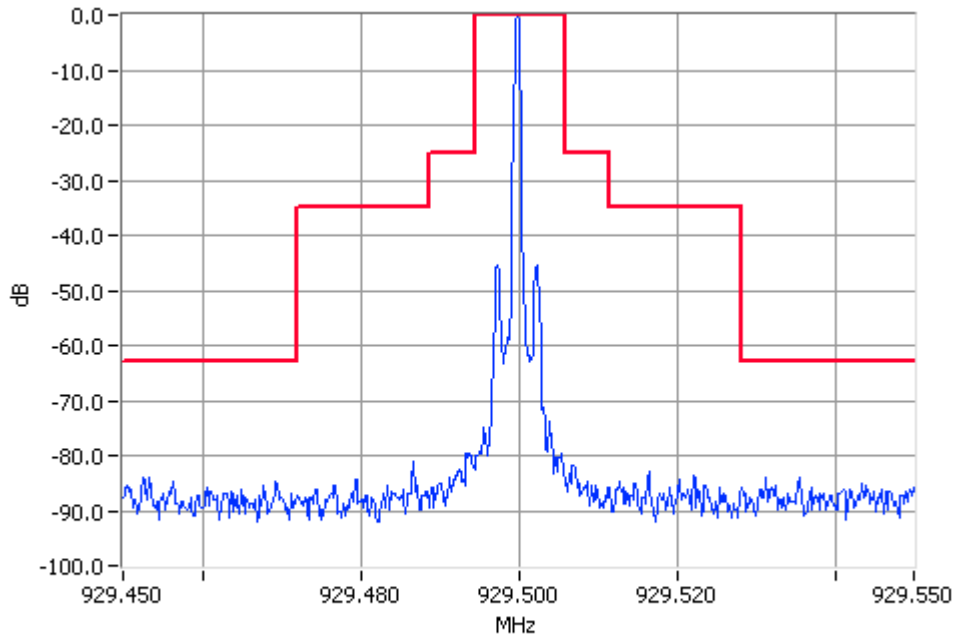

Unmodulated 929.5000MHz Mask B 100W Pass  
RBW=300Hz VBW=3000Hz

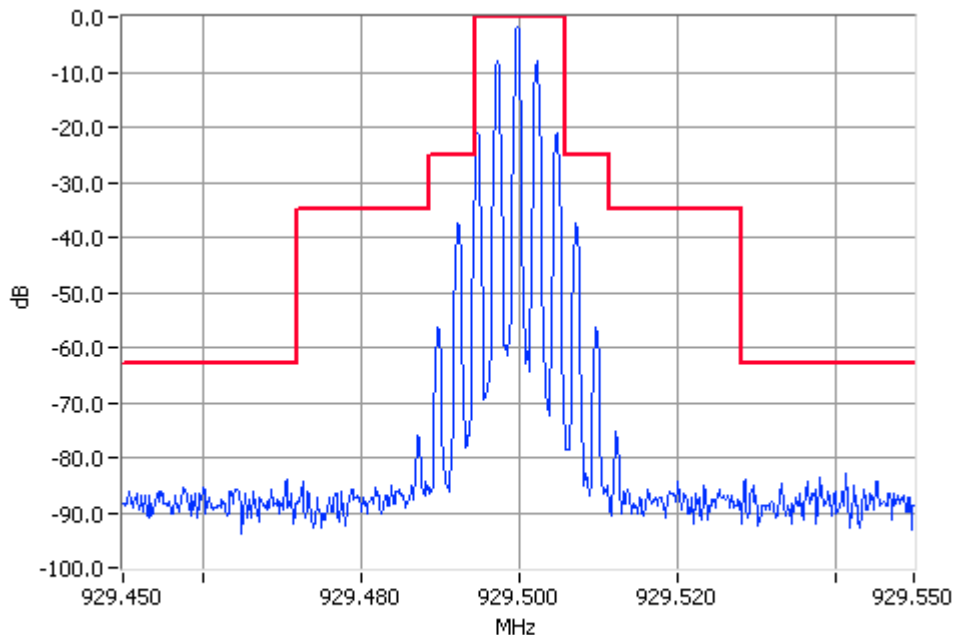

Analogue Modulation 929.5000MHz Mask B 100W Pass  
RBW=300Hz VBW=3000Hz

OCCUPIED BANDWIDTH

ANALOGUE VOICE

SPECIFICATION: FCC CFR 2.1049 (c)

Tx FREQUENCY: 929.5 MHz 100 W 25 kHz Channel Spacing

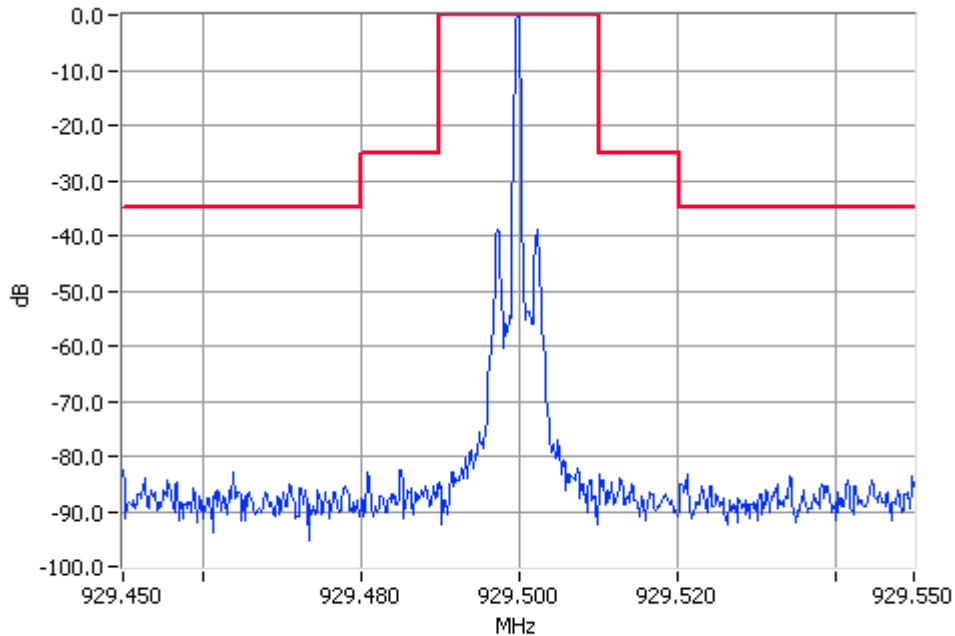

Unmodulated 929.5000MHz Mask B 100W Pass  
RBW=300Hz VBW=3000Hz

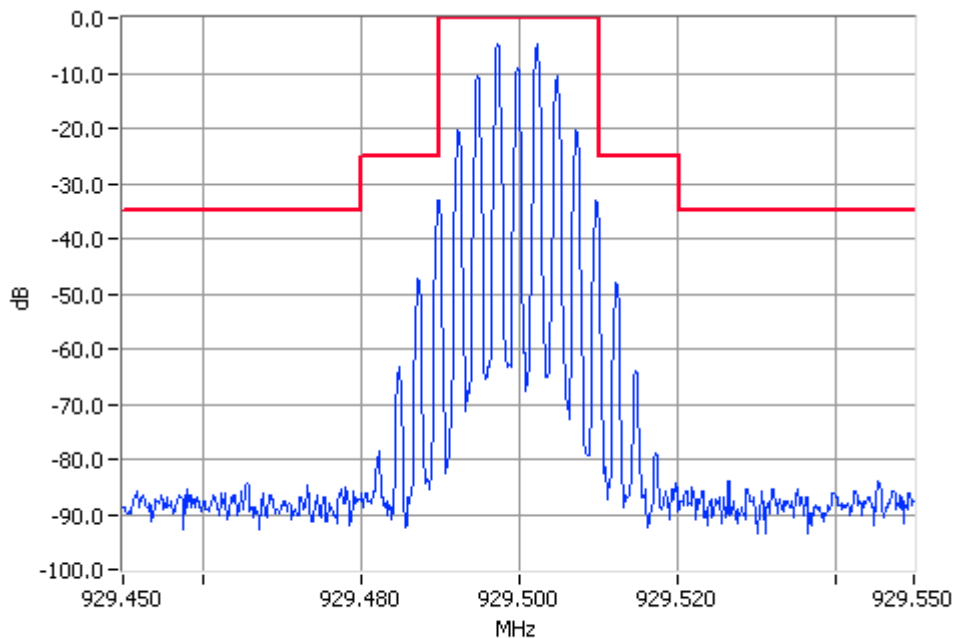

Analogue Modulation 929.5000MHz Mask B 100W Pass  
RBW=300Hz VBW=3000Hz

OCCUPIED BANDWIDTH

ANALOGUE VOICE

SPECIFICATION: FCC CFR 2.1049 (c)

Tx FREQUENCY: 929.5 MHz 10 W 12.5 kHz Channel Spacing

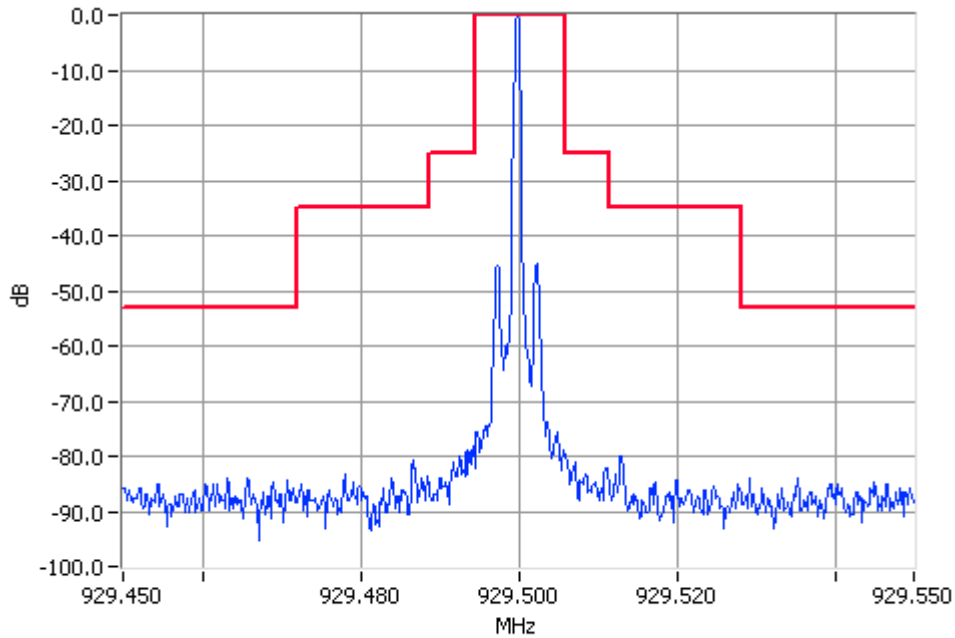

Unmodulated 929.5000MHz Mask B 10W Pass  
RBW=300Hz VBW=3000Hz

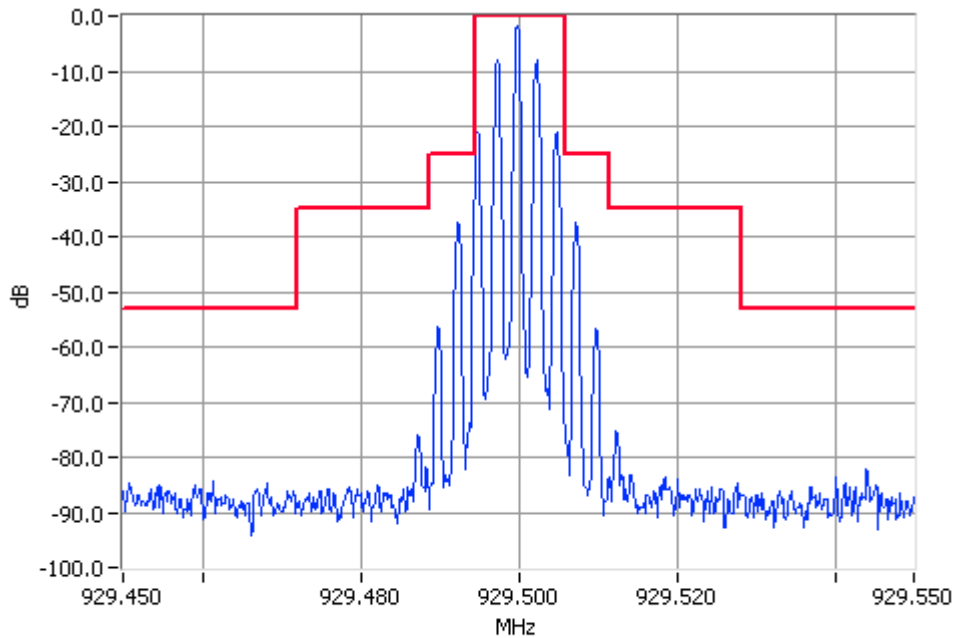

Analogue Modulation 929.5000MHz Mask B 10W Pass  
RBW=300Hz VBW=3000Hz

OCCUPIED BANDWIDTH

ANALOGUE VOICE

SPECIFICATION: FCC CFR 2.1049 (c)

Tx FREQUENCY: 929.5 MHz 10 W 25 kHz Channel Spacing

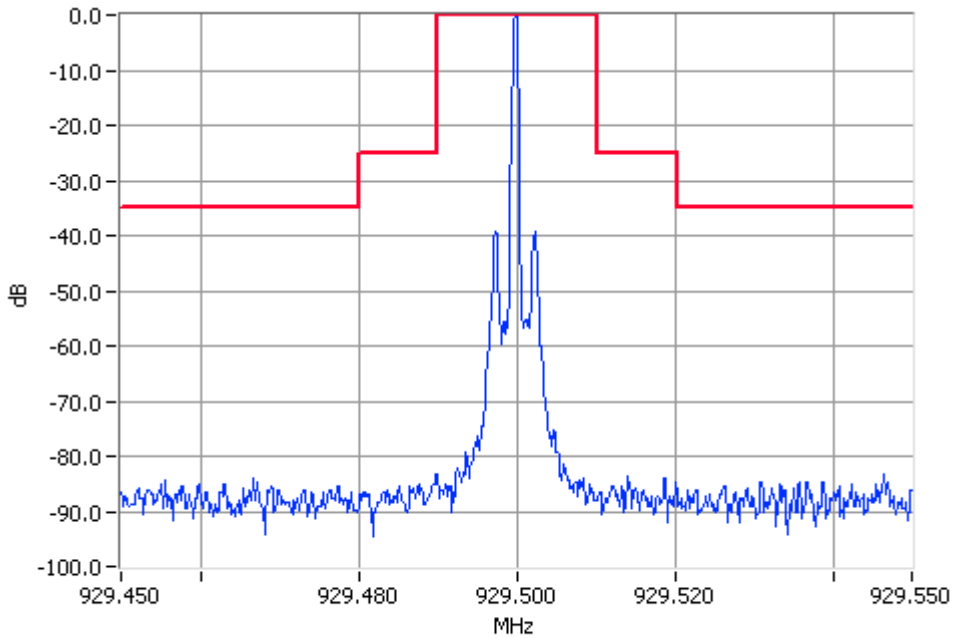

Unmodulated 929.5000MHz Mask B 10W Pass  
RBW=300Hz VBW=3000Hz

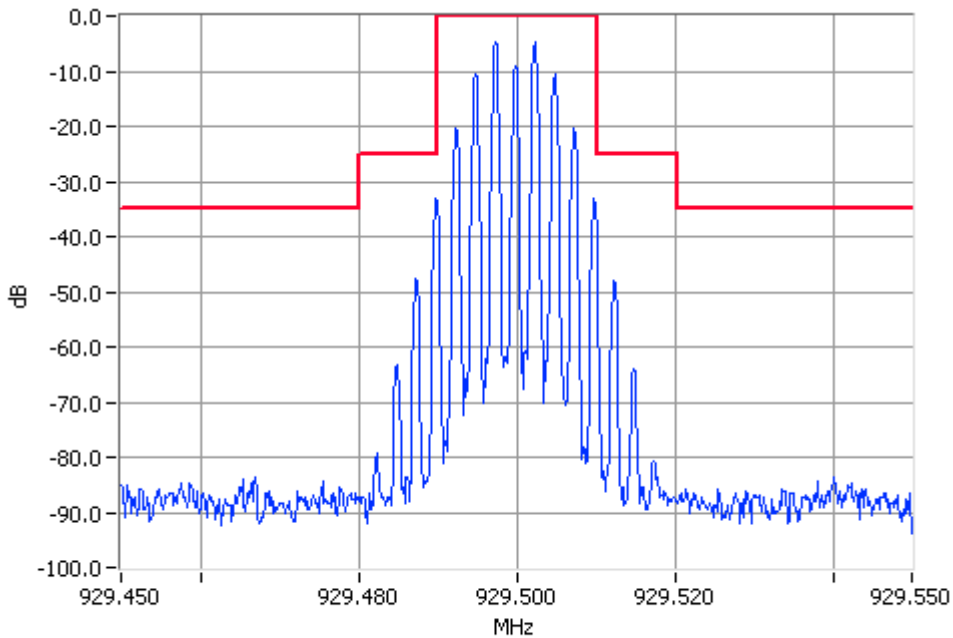

Analogue Modulation 929.5000MHz Mask B 10W Pass  
RBW=300Hz VBW=3000Hz

OCCUPIED BANDWIDTH

ANALOGUE VOICE

SPECIFICATION: FCC CFR 2.1049 (c)

Tx FREQUENCY: 937.6 MHz 100 W 12.5 kHz Channel Spacing

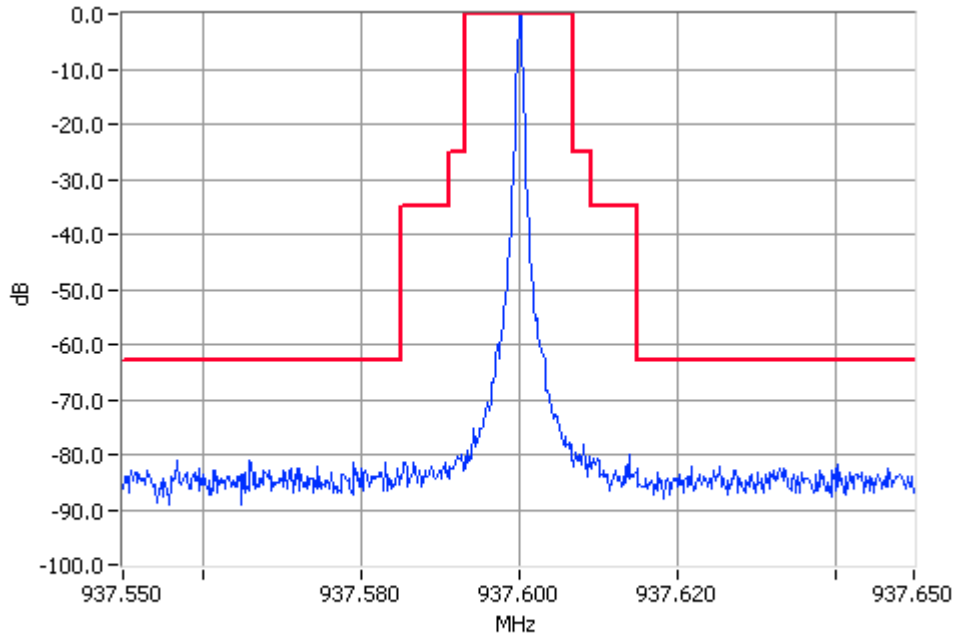

Unmodulated 937.600MHz Mask I 100W Pass  
RBW=300Hz VBW=3000Hz

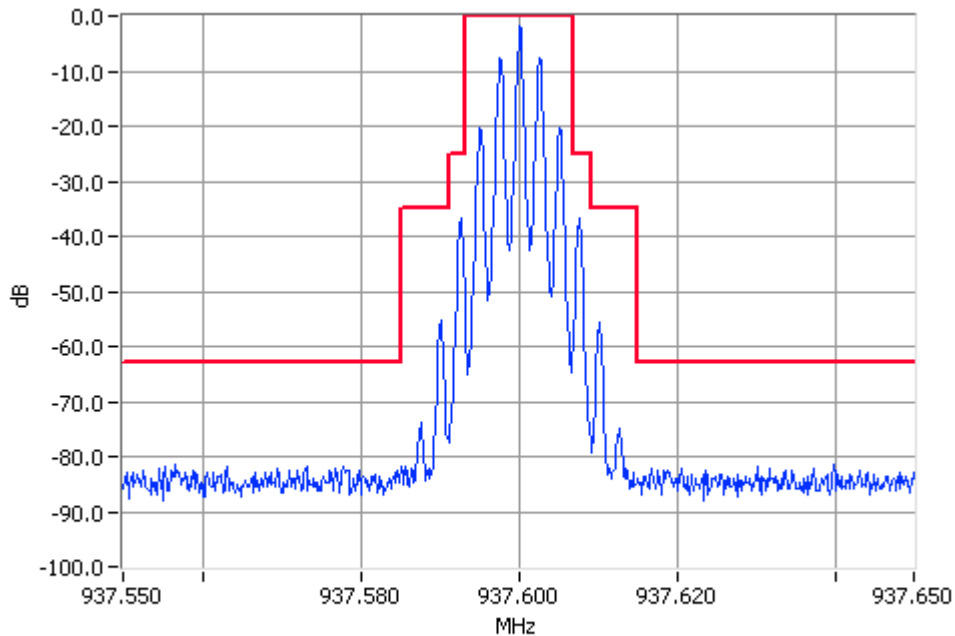

Analogue Modulation 937.600MHz Mask I 100W Pass  
RBW=300Hz VBW=3000Hz



OCCUPIED BANDWIDTH

ANALOGUE VOICE

SPECIFICATION: FCC CFR 2.1049 (c)

Tx FREQUENCY: 937.6 MHz 10 W 12.5 kHz Channel Spacing

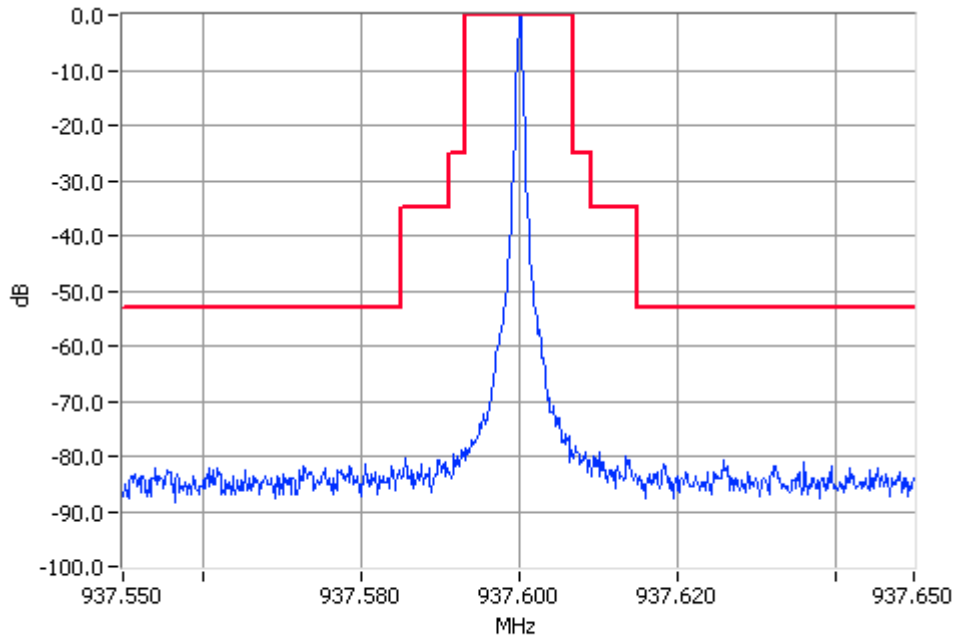

Unmodulated 937.6000MHz Mask I 10W Pass  
RBW=300Hz VBW=3000Hz

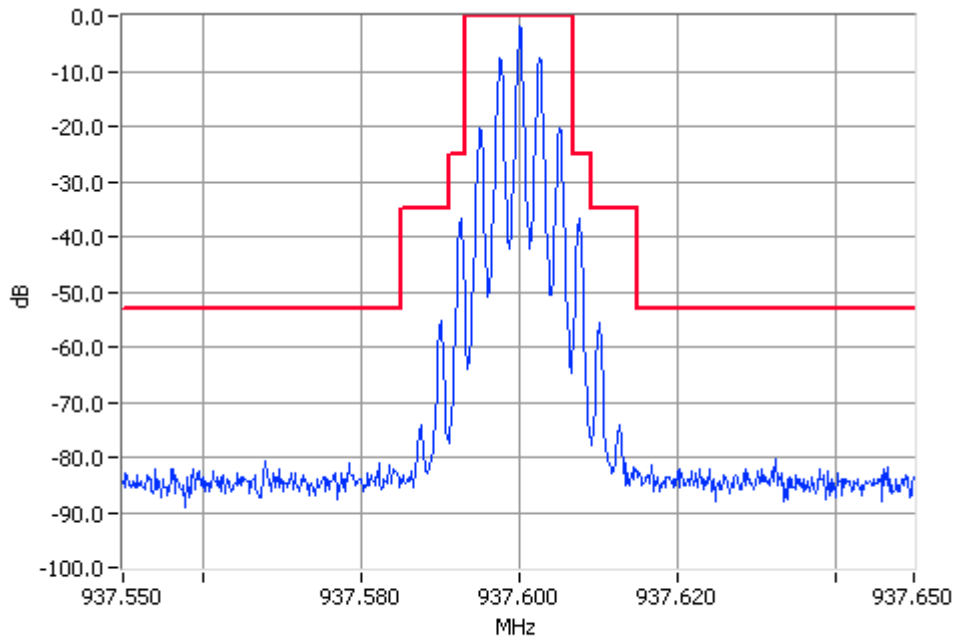

Analogue Modulation 937.6000MHz Mask I 10W Pass  
RBW=300Hz VBW=3000Hz

OCCUPIED BANDWIDTH

ANALOGUE VOICE

SPECIFICATION: FCC CFR 2.1049 (c)

Tx FREQUENCY: 937.6 MHz 100 W 25 kHz Channel Spacing

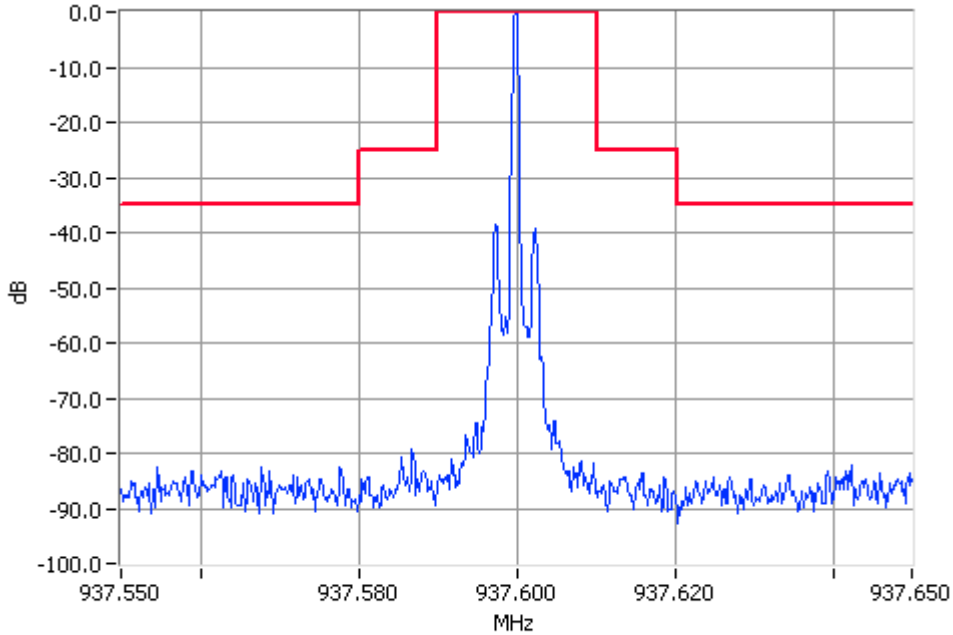

Unmodulated 937.6000MHz Mask B 100W Pass  
RBW=300Hz VBW=3000Hz

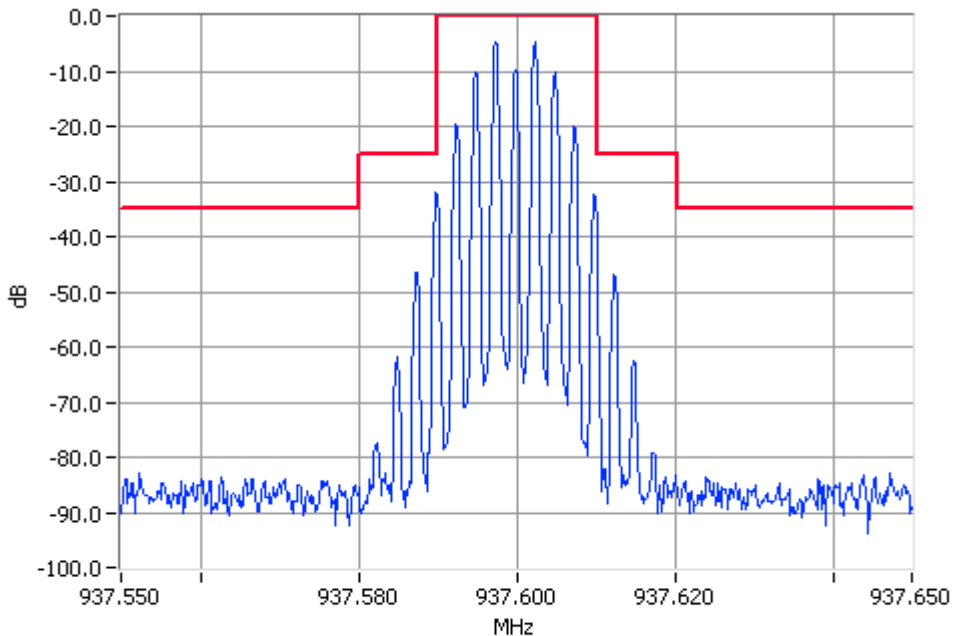

Analogue Modulation 937.6000MHz Mask B 100W Pass  
RBW=300Hz VBW=3000Hz

OCCUPIED BANDWIDTH

ANALOGUE VOICE

SPECIFICATION: FCC CFR 2.1049 (c)

Tx FREQUENCY: 937.6 MHz 10 W 25 kHz Channel Spacing

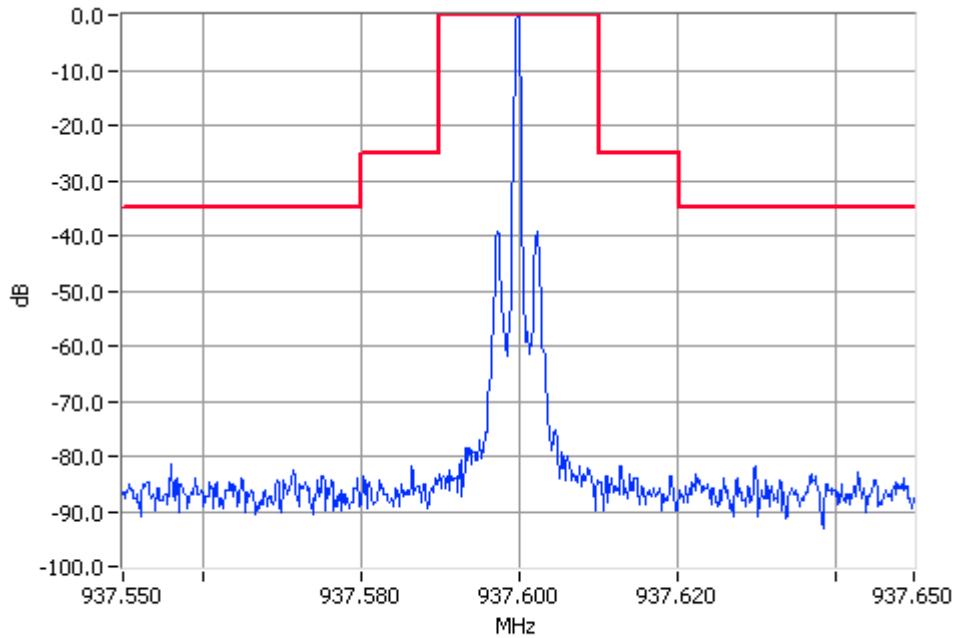

Unmodulated 937.6000MHz Mask B 10W Pass  
RBW=300Hz VBW=3000Hz

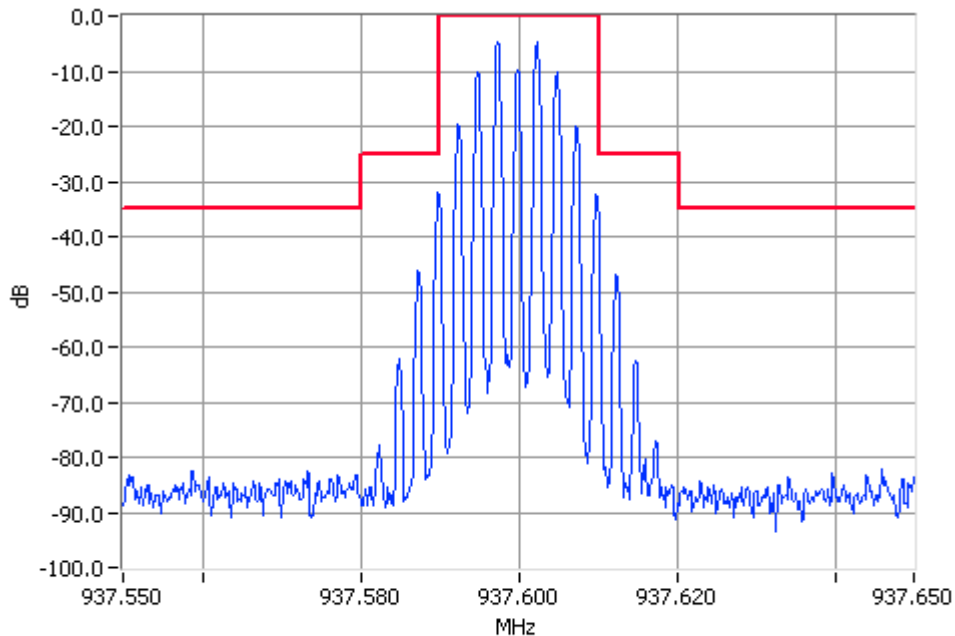

Analogue Modulation 937.6000MHz Mask B 10W Pass  
RBW=300Hz VBW=3000Hz

OCCUPIED BANDWIDTH

FFSK

SPECIFICATION: FCC CFR 2.1049 (c)

Tx FREQUENCY: 929.5 MHz 100 W 12.5 kHz Channel Spacing

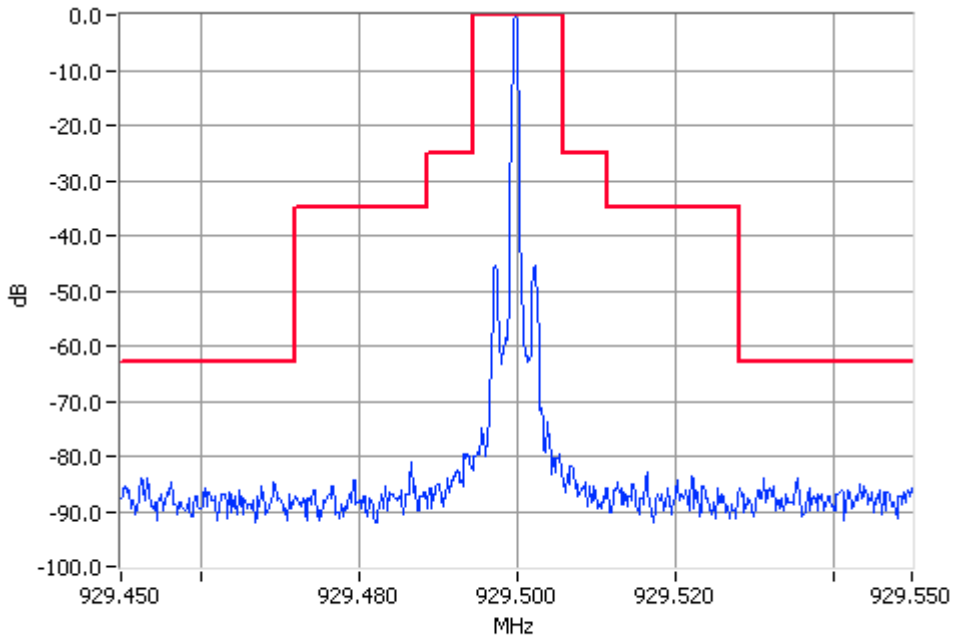

Unmodulated 929.5000MHz Mask B 100W Pass  
RBW=300Hz VBW=3000Hz

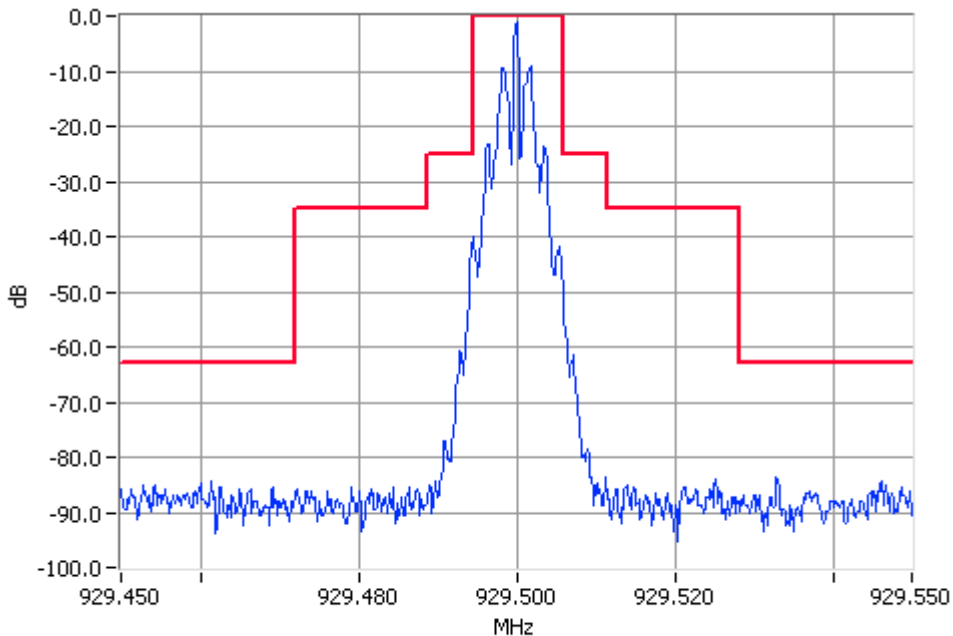

Digital Modulation 929.5000MHz Mask B 100W Pass  
RBW=300Hz VBW=3000Hz

OCCUPIED BANDWIDTH

FFSK

SPECIFICATION: FCC CFR 2.1049 (c)

Tx FREQUENCY: 929.5 MHz 10 W 12.5 kHz Channel Spacing

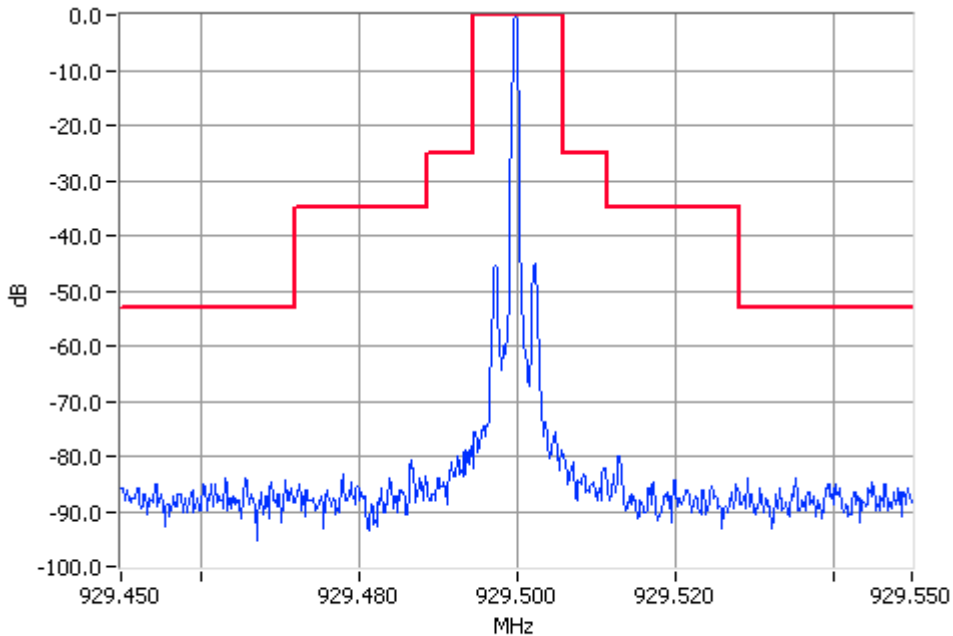

Unmodulated 929.5000MHz Mask B 10W Pass  
RBW=300Hz VBW=3000Hz

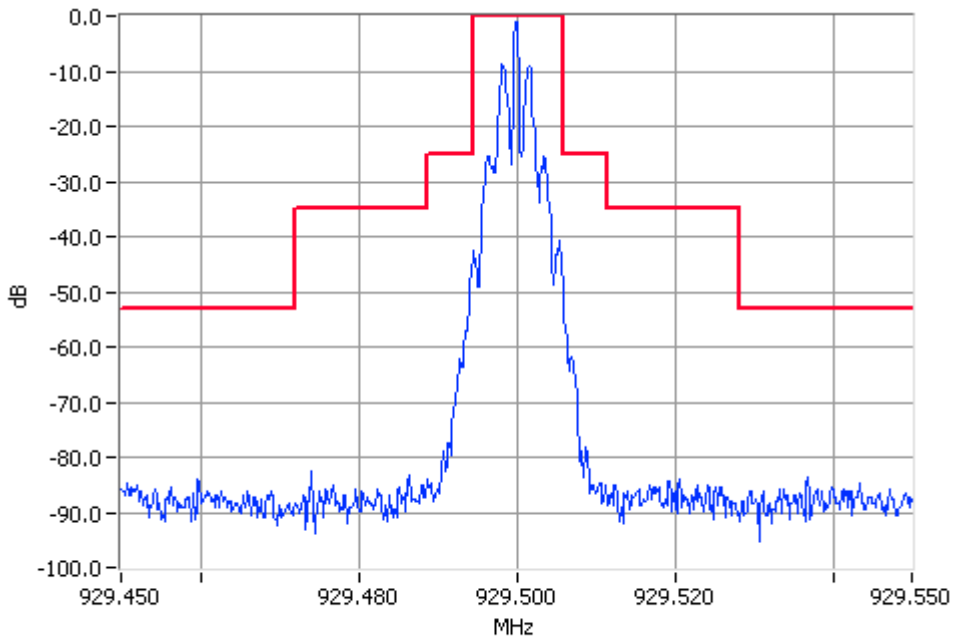

Digital Modulation 929.5000MHz Mask B 10W Pass  
RBW=300Hz VBW=3000Hz

OCCUPIED BANDWIDTH

FFSK

SPECIFICATION: FCC CFR 2.1049 (c)

Tx FREQUENCY: 929.5 MHz 100 W 25 kHz Channel Spacing

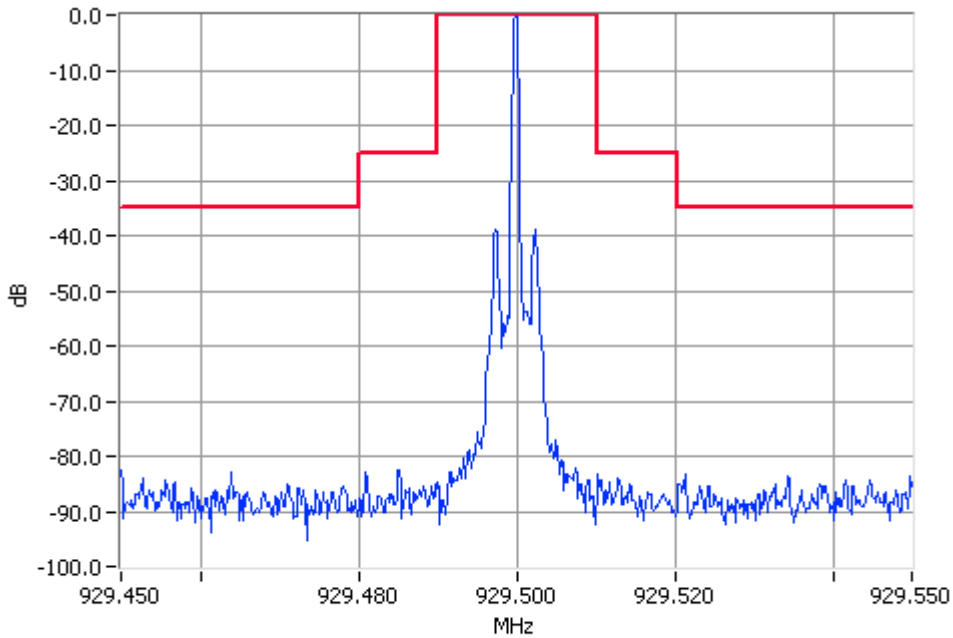

Unmodulated 929.5000MHz Mask B 100W Pass  
RBW=300Hz VBW=3000Hz

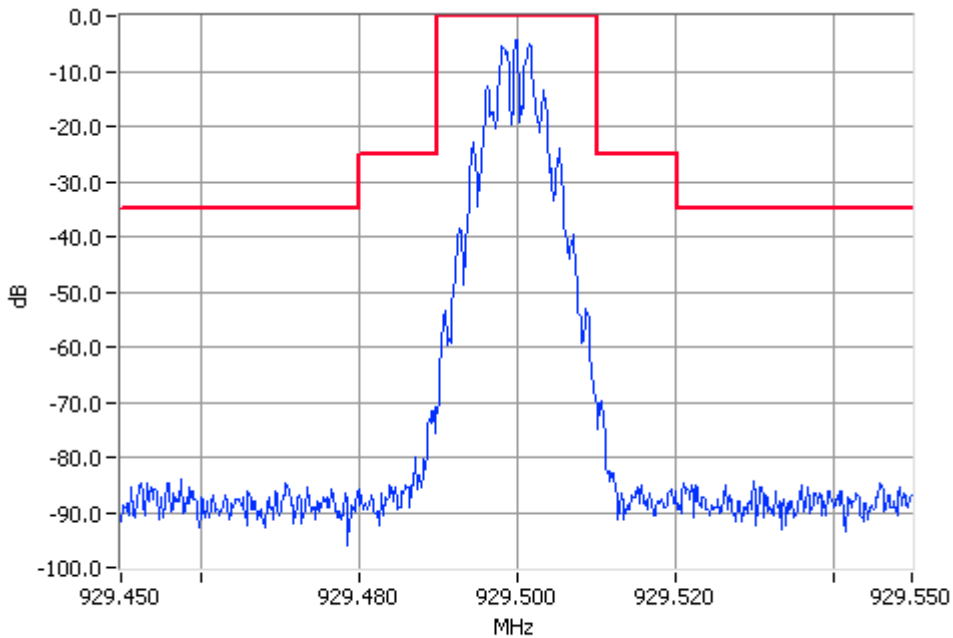

Digital Modulation 929.5000MHz Mask B 100W Pass  
RBW=300Hz VBW=3000Hz

OCCUPIED BANDWIDTH

FFSK

SPECIFICATION: FCC CFR 2.1049 (c)

Tx FREQUENCY: 929.5 MHz 10 W 25 kHz Channel Spacing

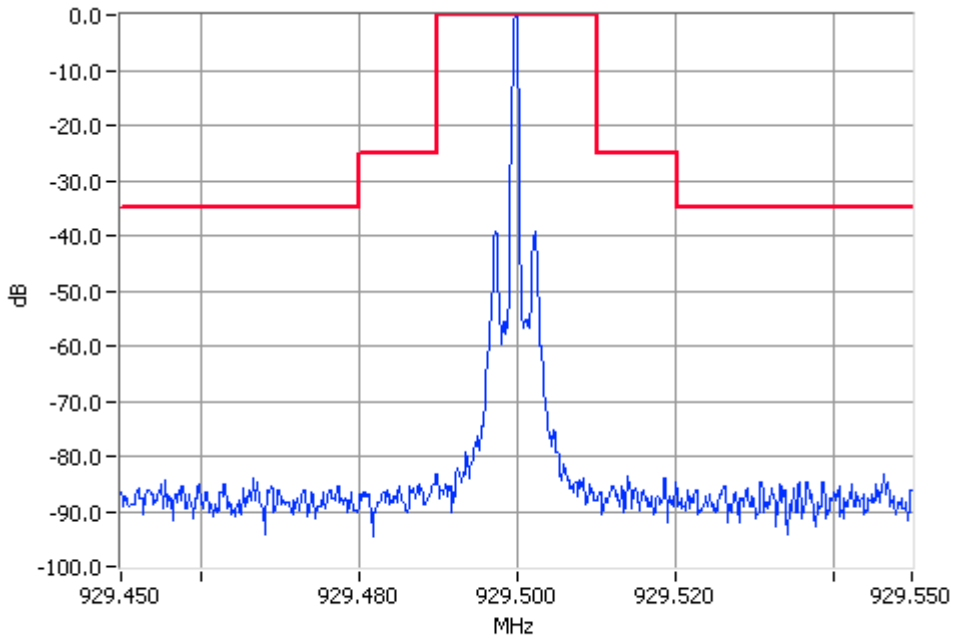

Unmodulated 929.5000MHz Mask B 10W Pass  
RBW=300Hz VBW=3000Hz

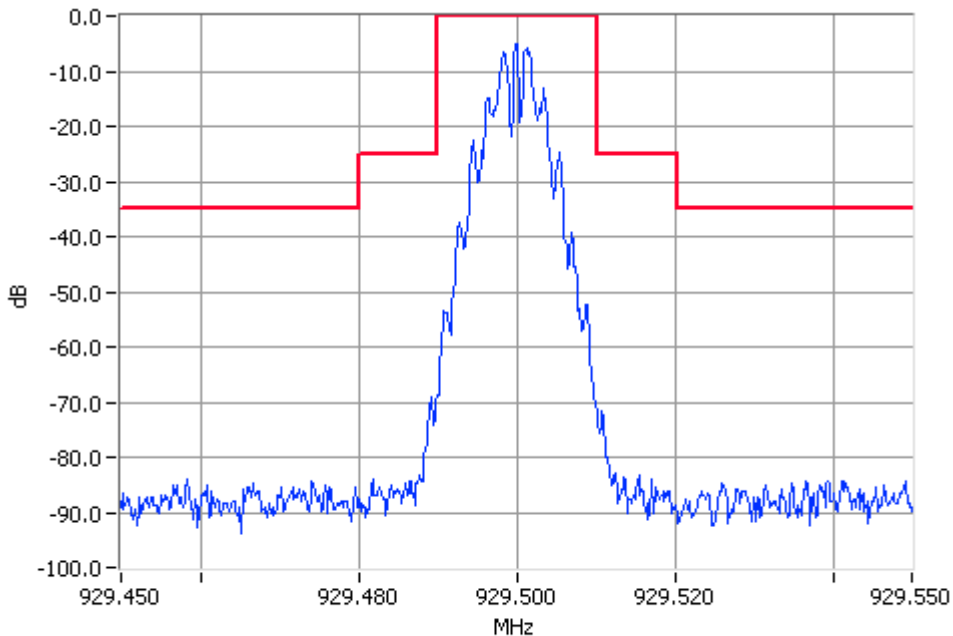

Digital Modulation 929.5000MHz Mask B 10W Pass  
RBW=300Hz VBW=3000Hz

OCCUPIED BANDWIDTH

FFSK

SPECIFICATION: FCC CFR 2.1049 (c)

Tx FREQUENCY: 937.6 MHz 100 W 12.5 kHz Channel Spacing

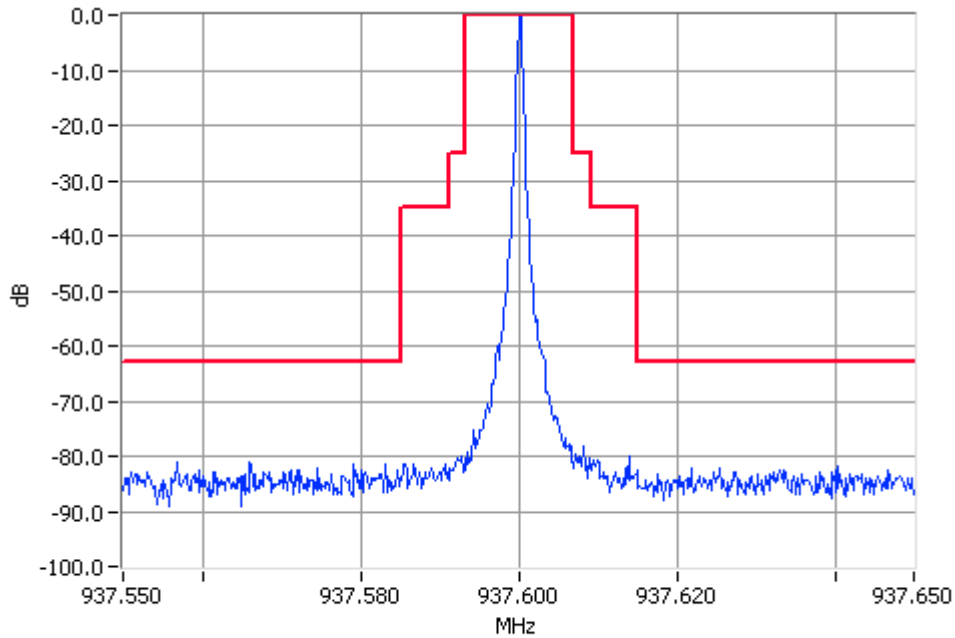

Unmodulated 937.6000MHz Mask I 100W Pass  
RBW=300Hz VBW=3000Hz

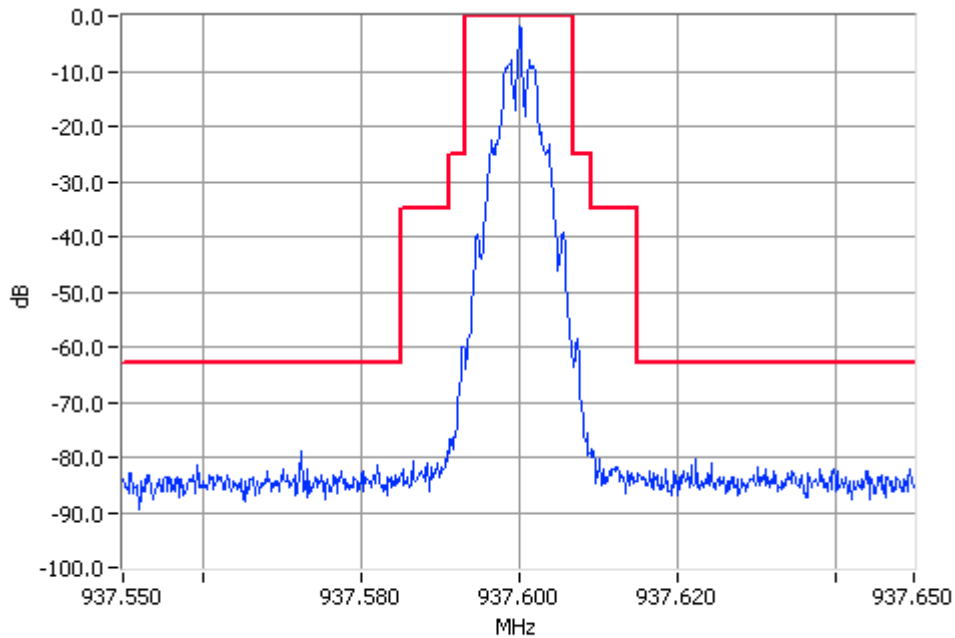

Digital Modulation 937.6000MHz Mask I 100W Pass  
RBW=300Hz VBW=3000Hz



OCCUPIED BANDWIDTH

FFSK

SPECIFICATION: FCC CFR 2.1049 (c)

Tx FREQUENCY: 937.6 MHz 10 W 12.5 kHz Channel Spacing

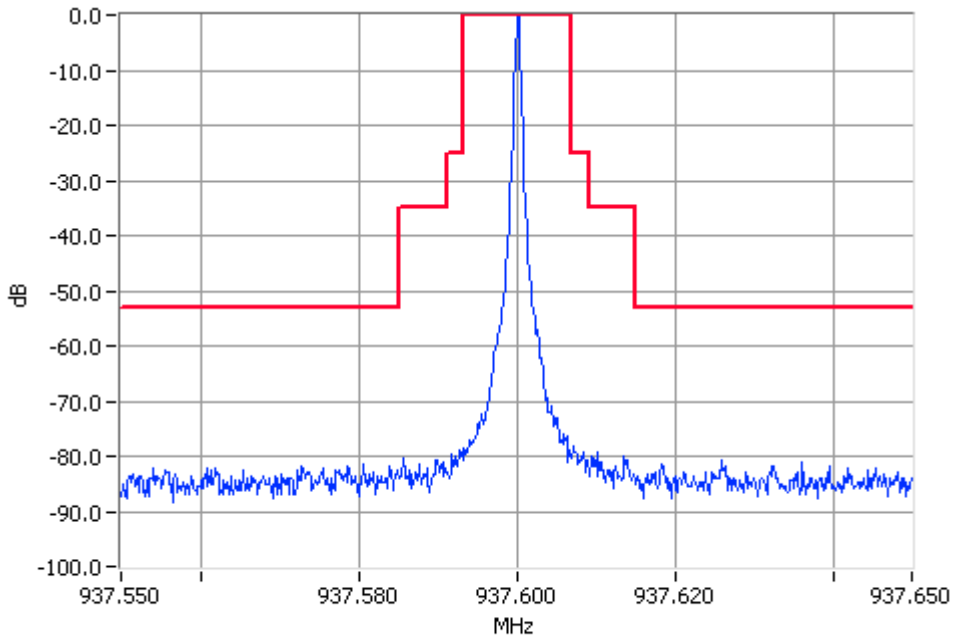

Unmodulated 937.6000MHz Mask I 10W Pass  
RBW=300Hz VBW=3000Hz

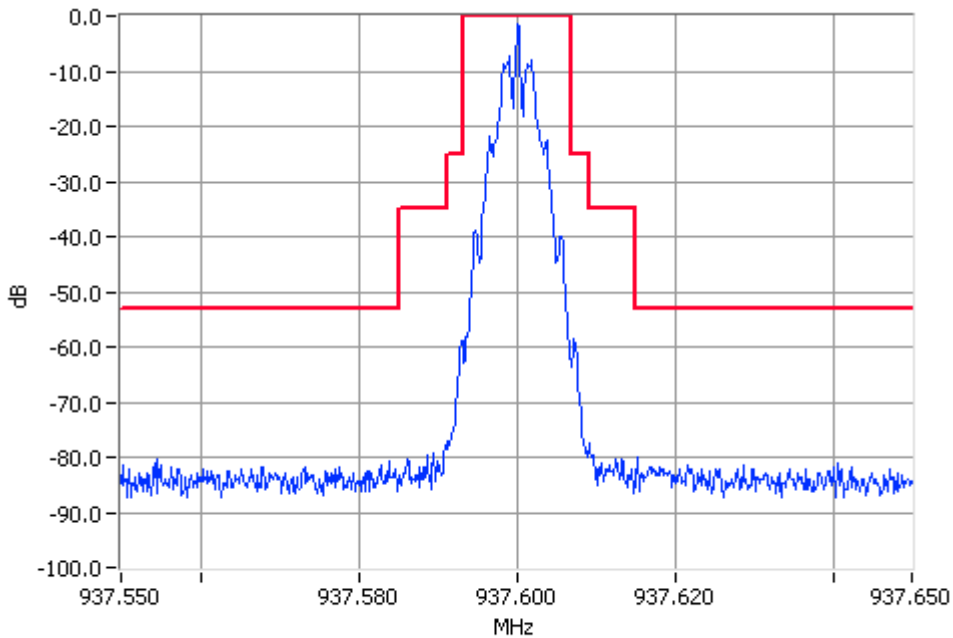

Digital Modulation 937.6000MHz Mask I 10W Pass  
RBW=300Hz VBW=3000Hz

OCCUPIED BANDWIDTH

FFSK

SPECIFICATION: FCC CFR 2.1049 (c)

Tx FREQUENCY: 937.6 MHz 100 W 25 kHz Channel Spacing

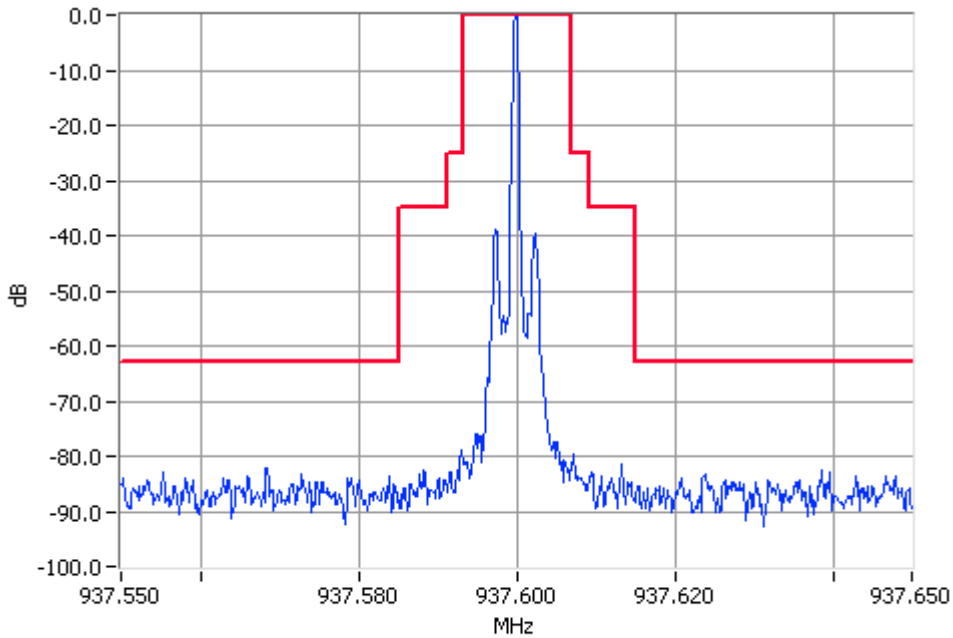

Unmodulated 937.6000MHz Mask I 100W Pass  
RBW=300Hz VBW=3000Hz

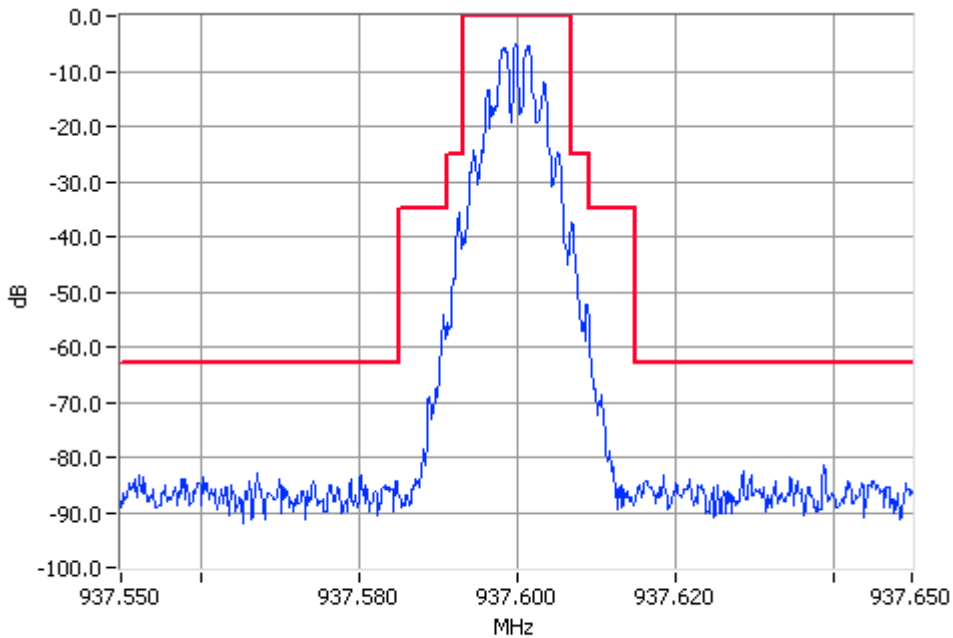

Digital Modulation 937.6000MHz Mask I 100W Pass  
RBW=300Hz VBW=3000Hz

OCCUPIED BANDWIDTH

FFSK

SPECIFICATION: FCC CFR 2.1049 (c)

Tx FREQUENCY: 937.6 MHz 10 W 25 kHz Channel Spacing

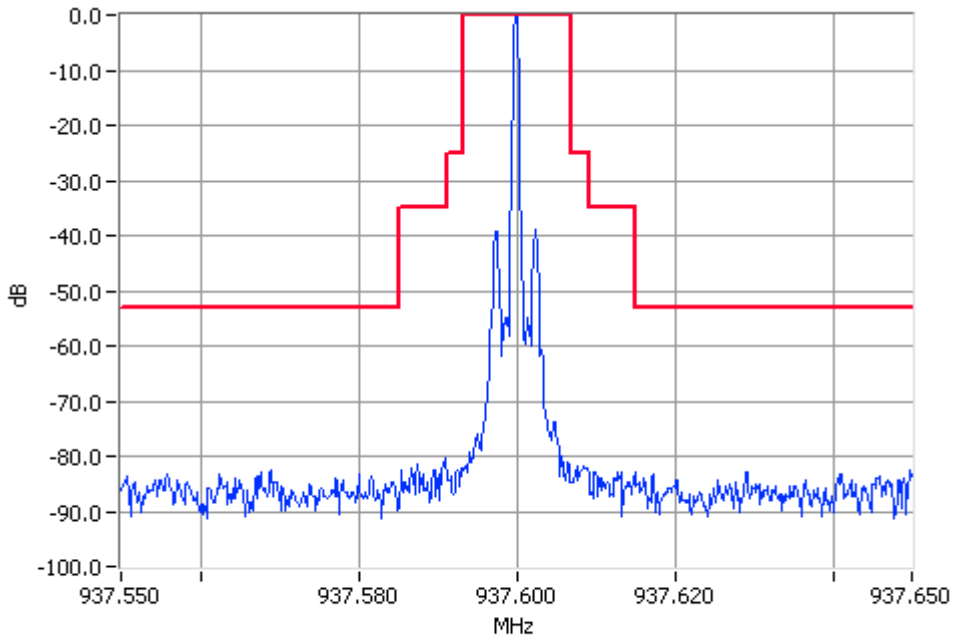

Unmodulated 937.6000MHz Mask I 10W Pass  
RBW=300Hz VBW=3000Hz

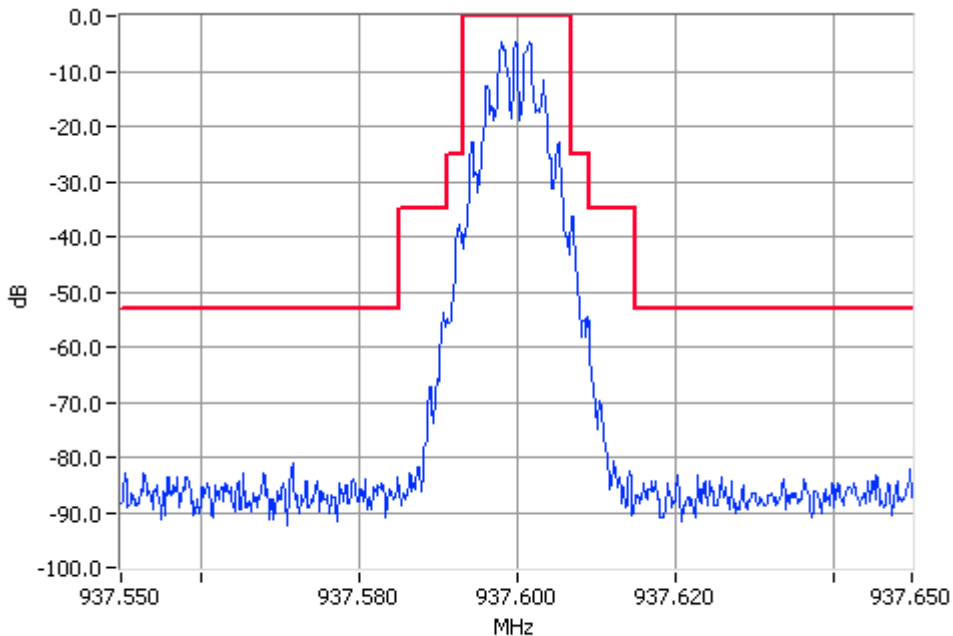

Digital Modulation 937.6000MHz Mask I 10W Pass  
RBW=300Hz VBW=3000Hz

OCCUPIED BANDWIDTH

Paging - POCSAG

SPECIFICATION: FCC CFR 2.1049 (c)

Tx FREQUENCY: 929.5 MHz 100 W 12.5 kHz Channel Spacing

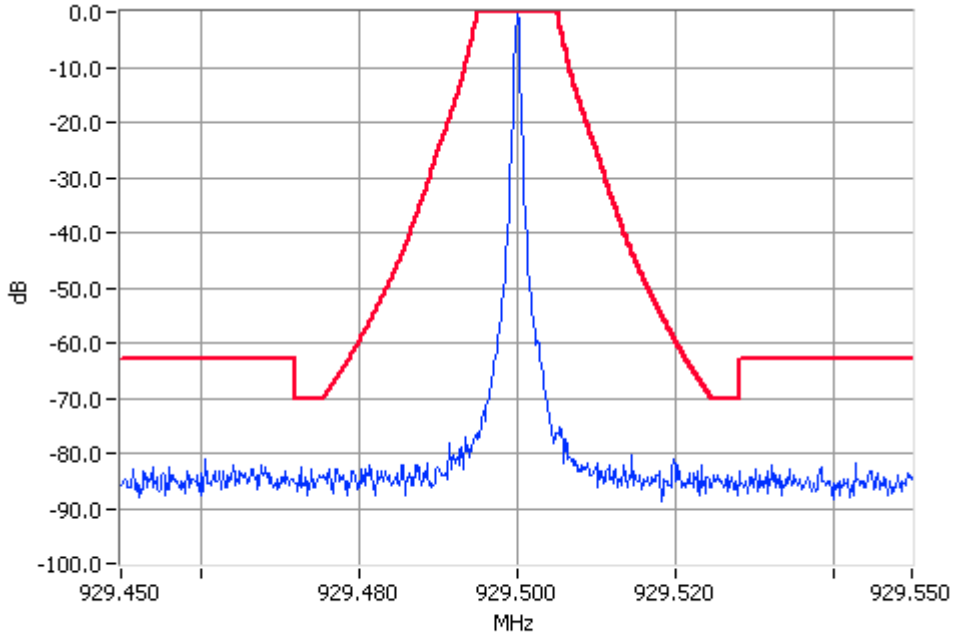

Unmodulated 929.500MHz Mask G 100W Pass  
RBW=300Hz VBW=3000Hz

512 Baud

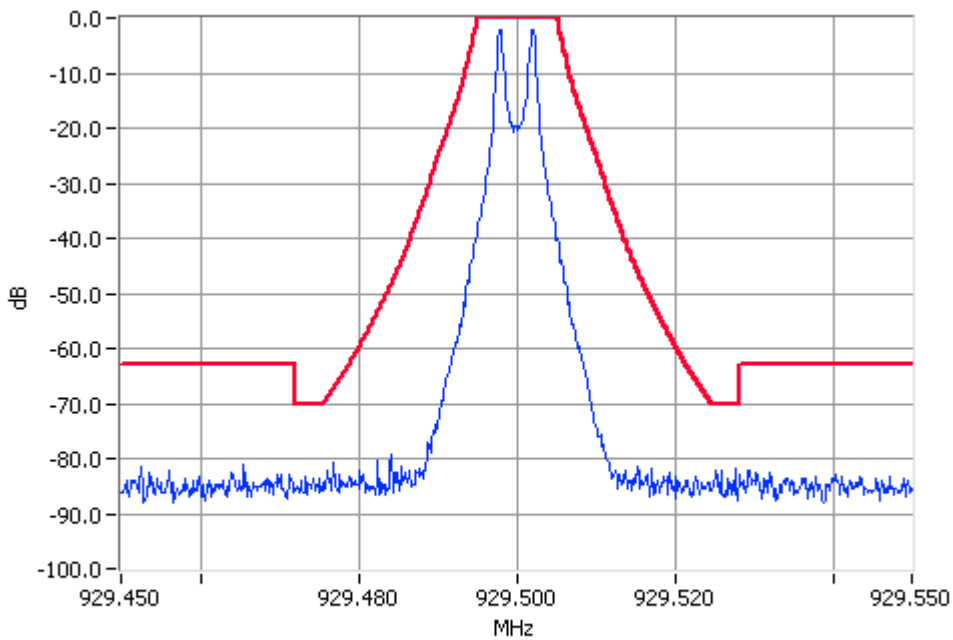

Paging Modulation 929.500MHz Mask G 100W Pass  
RBW=300Hz VBW=3000Hz

OCCUPIED BANDWIDTH

Paging - POCSAG

SPECIFICATION: FCC CFR 2.1049 (c)

Tx FREQUENCY: 929.5 MHz 100 W 12.5 kHz Channel Spacing

1200 Baud

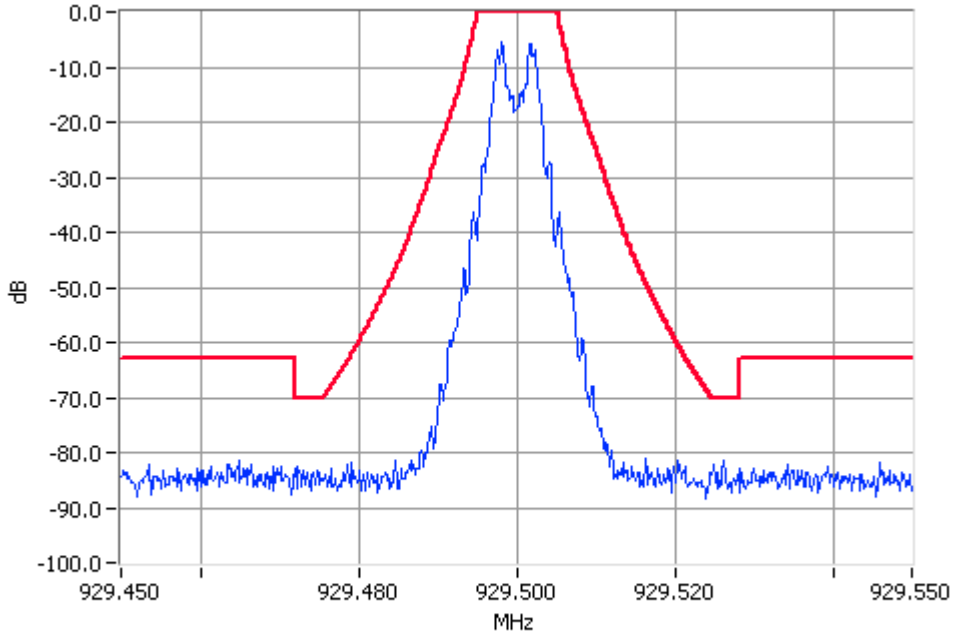

Paging Modulation 929.5000MHz Mask G 100W Pass  
RBW=300Hz VBW=3000Hz

2400 Baud

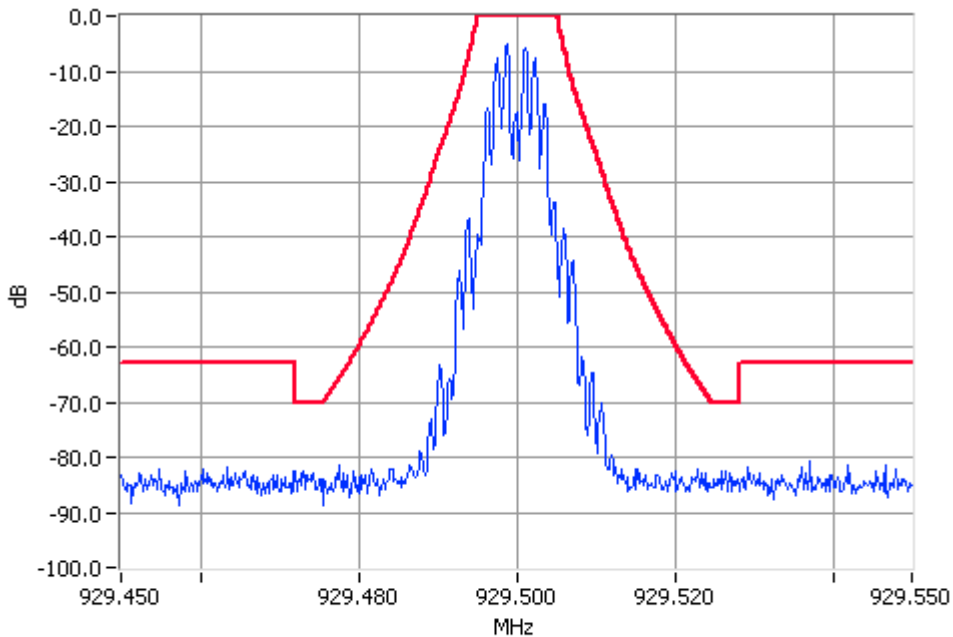

Paging Modulation 929.5000MHz Mask G 100W Pass  
RBW=300Hz VBW=3000Hz

OCCUPIED BANDWIDTH

Paging - POCSAG

SPECIFICATION: FCC CFR 2.1049 (c)

Tx FREQUENCY: 929.5 MHz 10 W 12.5 kHz Channel Spacing

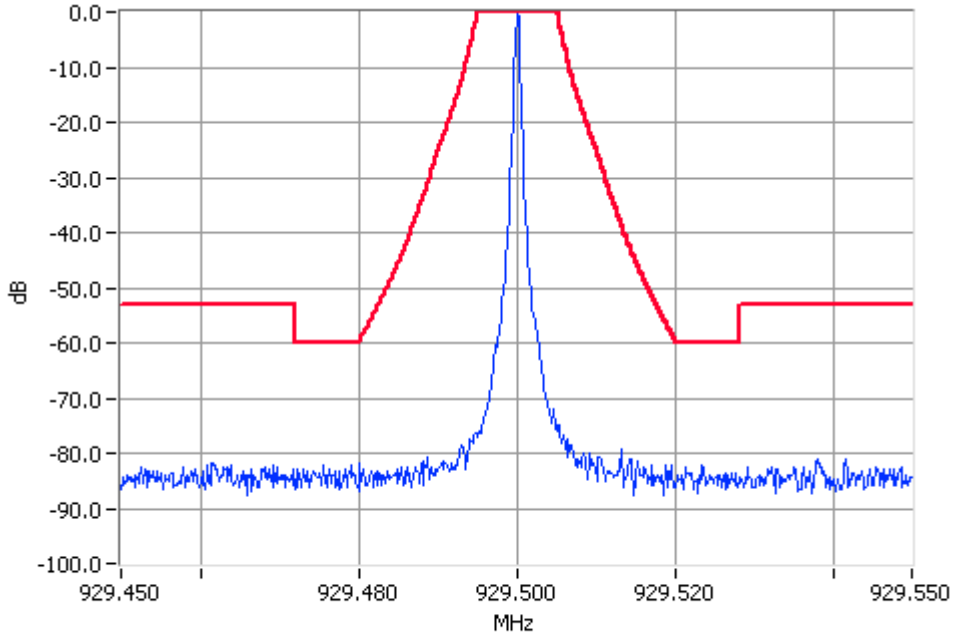

Unmodulated 929.5000MHz Mask G 10W Pass  
RBW=300Hz VBW=3000Hz

512 Baud

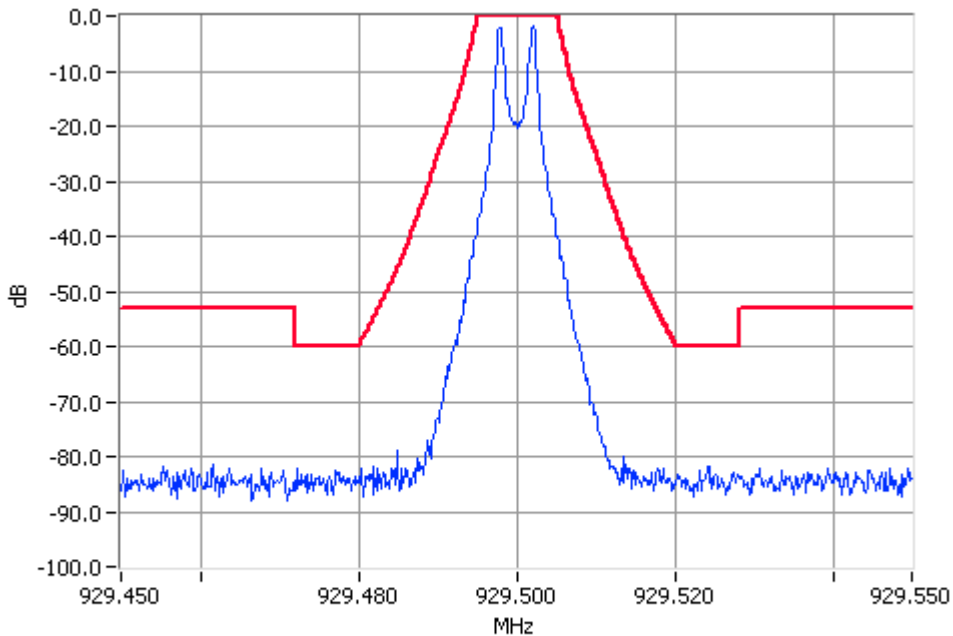

Paging Modulation 929.5000MHz Mask G 10W Pass  
RBW=300Hz VBW=3000Hz

OCCUPIED BANDWIDTH

Paging - POCSAG

SPECIFICATION: FCC CFR 2.1049 (c)

Tx FREQUENCY: 929.5 MHz 10 W 12.5 kHz Channel Spacing

1200 Baud

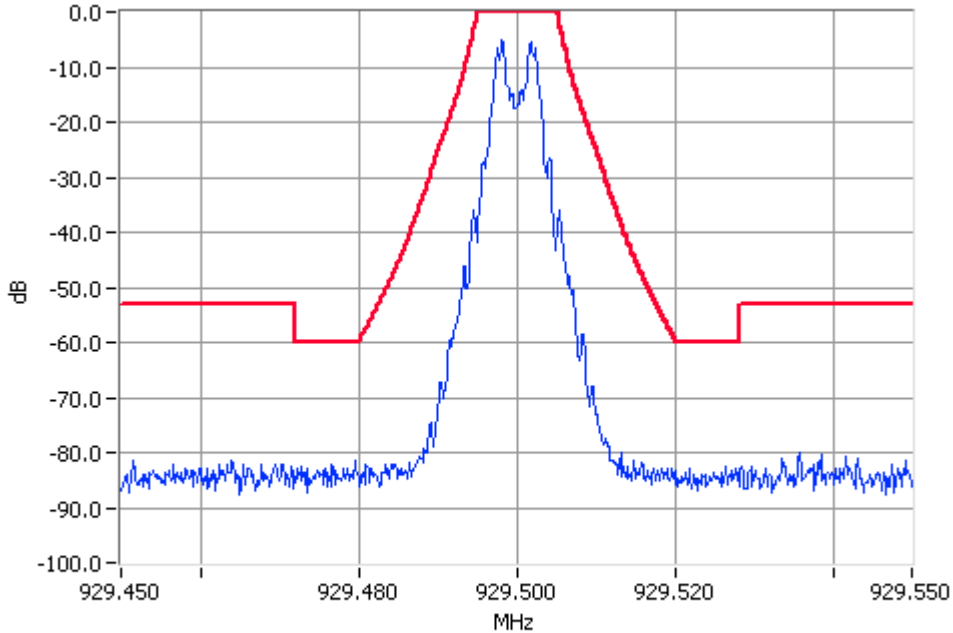

Paging Modulation 929.5000MHz Mask G 10W Pass  
RBW=300Hz VBW=3000Hz

2400 Baud

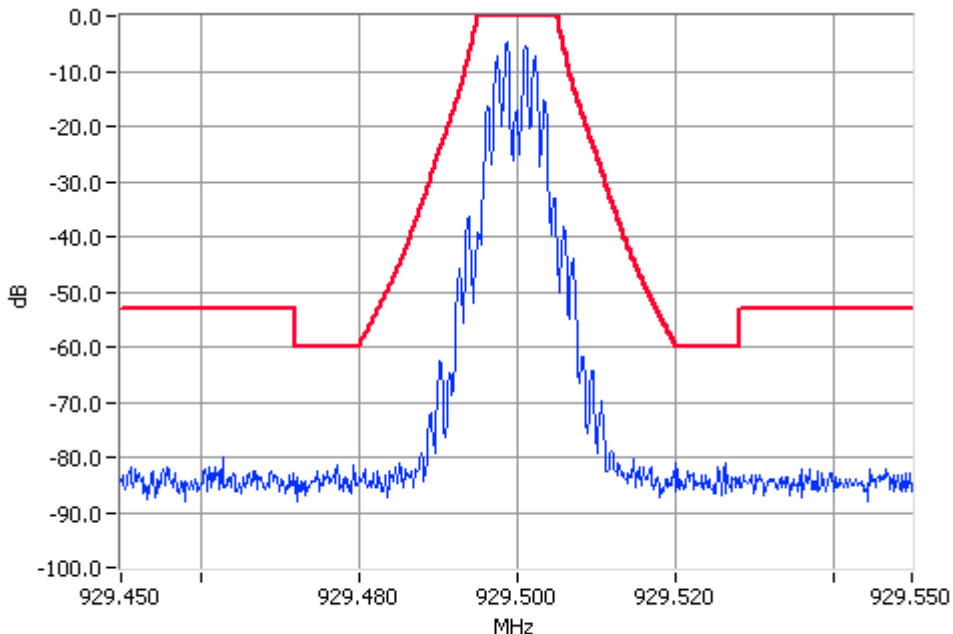

Paging Modulation 929.5000MHz Mask G 10W Pass  
RBW=300Hz VBW=3000Hz

OCCUPIED BANDWIDTH

Paging - POCSAG

SPECIFICATION: FCC CFR 2.1049 (c)

Tx FREQUENCY: 929.5 MHz 100 W 25 kHz Channel Spacing

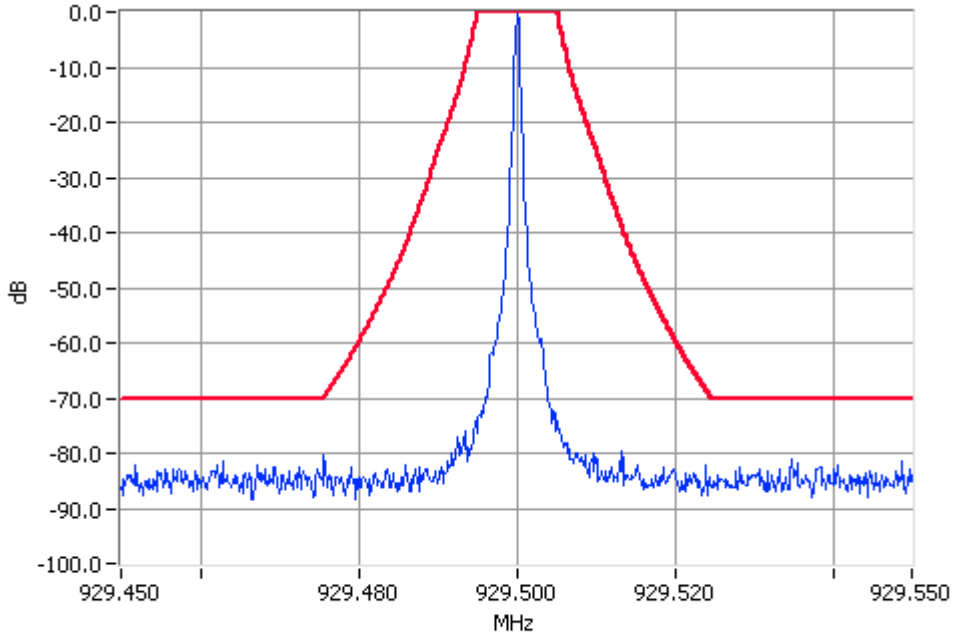

Unmodulated 929.5000MHz Mask G 100W Pass  
RBW=300Hz VBW=3000Hz

512 Baud

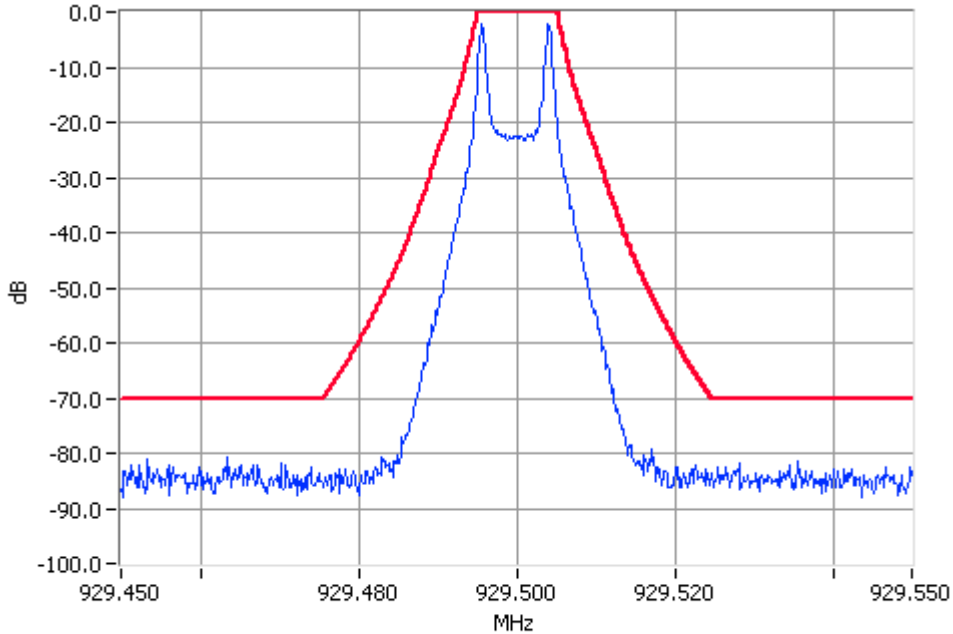

Paging Modulation 929.5000MHz Mask G 100W Pass  
RBW=300Hz VBW=3000Hz



OCCUPIED BANDWIDTH

Paging - POCSAG

SPECIFICATION: FCC CFR 2.1049 (c)

Tx FREQUENCY: 929.5 MHz 100 W 25 kHz Channel Spacing

1200 Baud

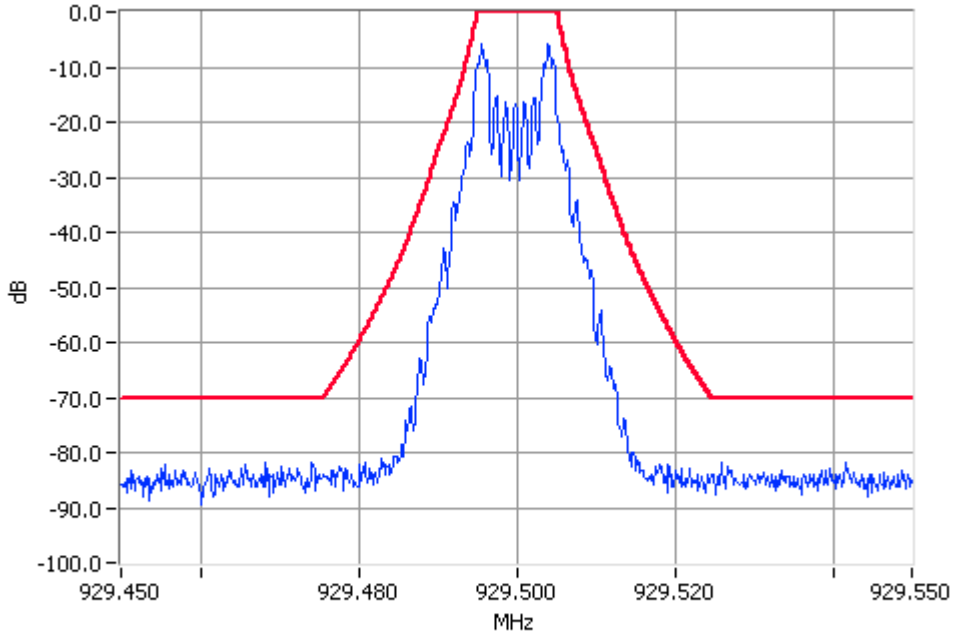

Paging Modulation 929.5000MHz Mask G 100W Pass  
RBW=300Hz VBW=3000Hz

2400 Baud

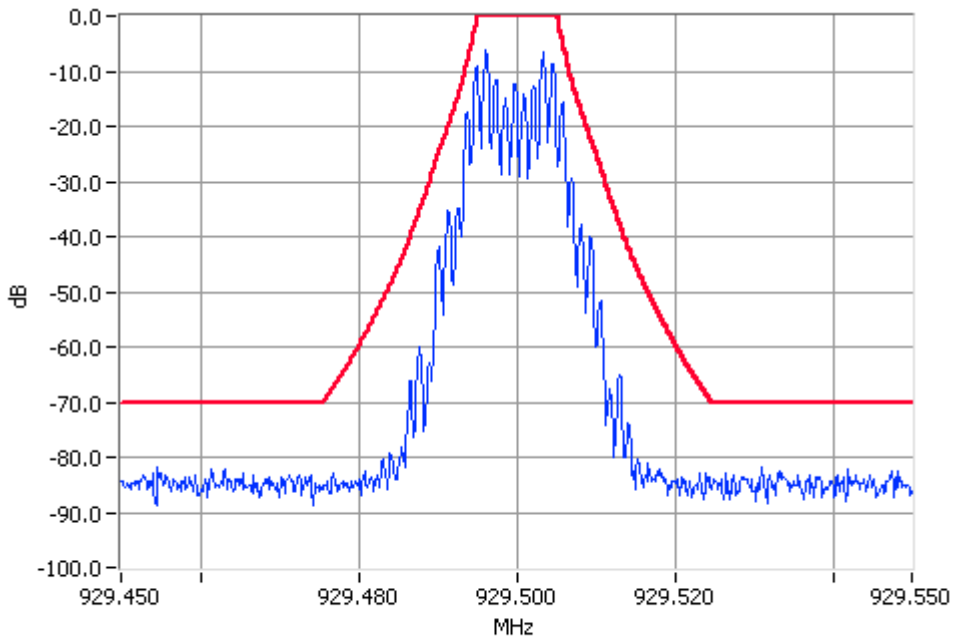

Paging Modulation 929.5000MHz Mask G 100W Pass  
RBW=300Hz VBW=3000Hz

OCCUPIED BANDWIDTH

Paging - POCSAG

SPECIFICATION: FCC CFR 2.1049 (c)

Tx FREQUENCY: 929.5 MHz 10 W 25 kHz Channel Spacing

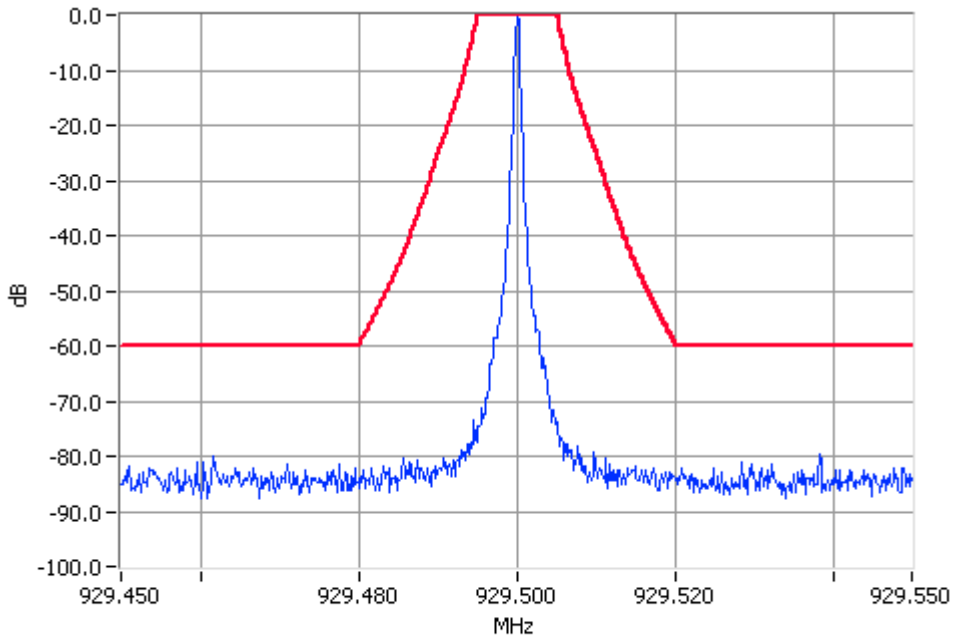

Unmodulated 929.5000MHz Mask G 10W Pass  
RBW=300Hz VBW=3000Hz

512 Baud

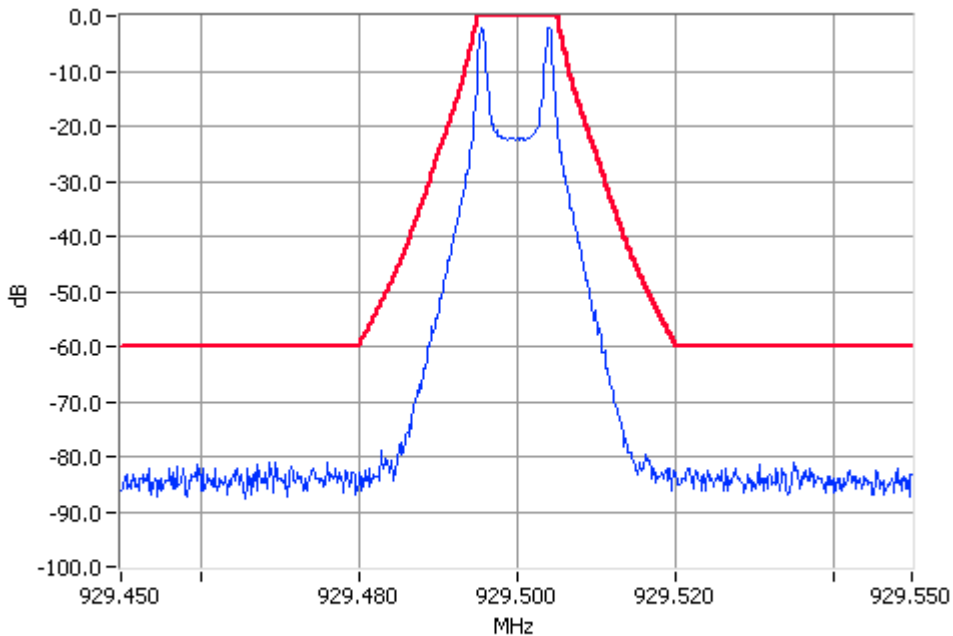

Paging Modulation 929.5000MHz Mask G 10W Pass  
RBW=300Hz VBW=3000Hz

OCCUPIED BANDWIDTH

Paging - POCSAG

SPECIFICATION: FCC CFR 2.1049 (c)

Tx FREQUENCY: 929.5 MHz 10 W 25 kHz Channel Spacing

1200 Baud

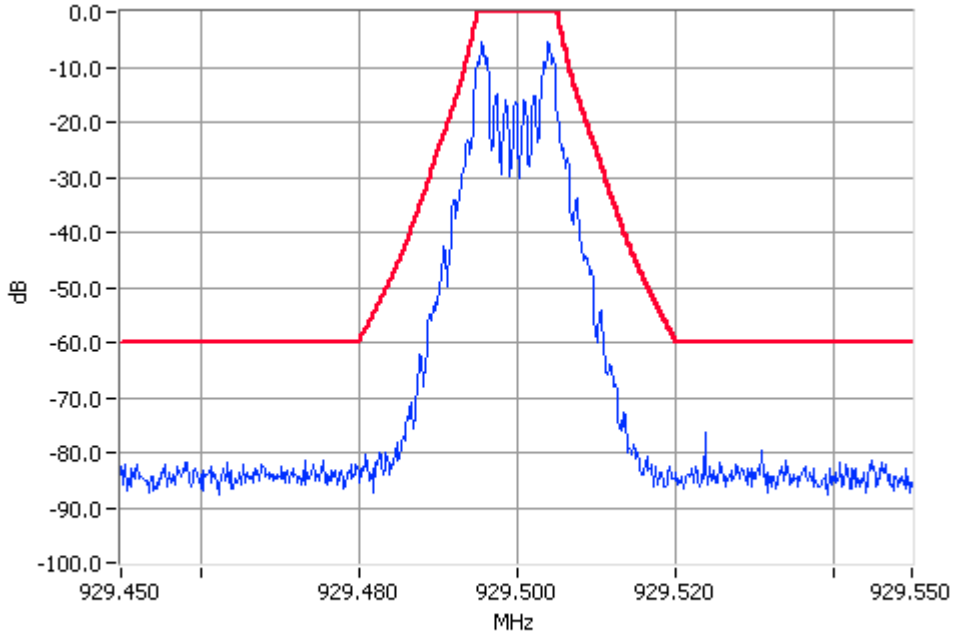

Paging Modulation 929.5000MHz Mask G 10W Pass  
RBW=300Hz VBW=3000Hz

2400 Baud

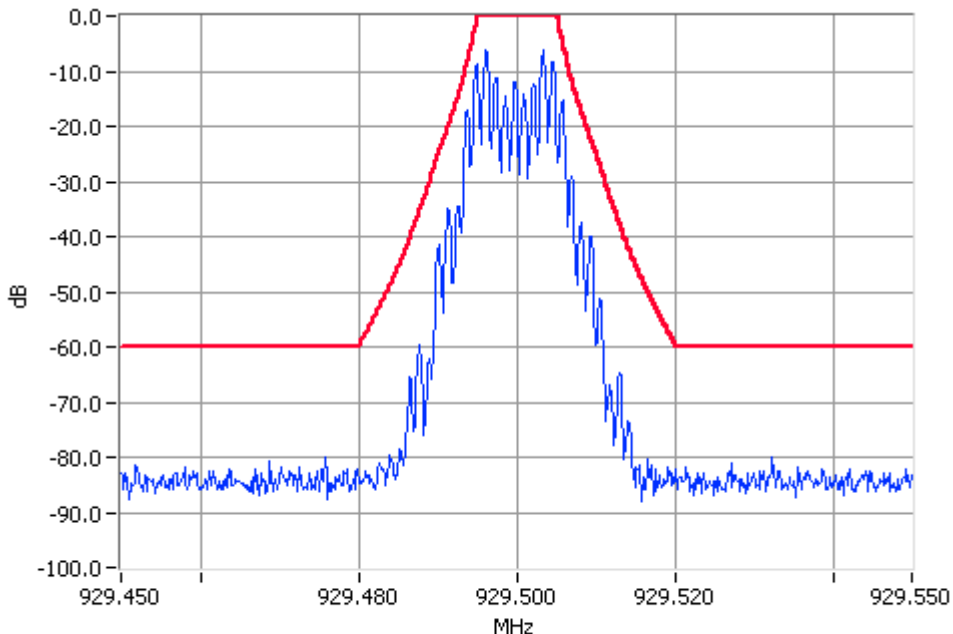

Paging Modulation 929.5000MHz Mask G 10W Pass  
RBW=300Hz VBW=3000Hz

OCCUPIED BANDWIDTH

Paging - POCSAG

SPECIFICATION: FCC CFR 2.1049 (c)

Tx FREQUENCY: 929.5 MHz 5 W 12.5 kHz Channel Spacing

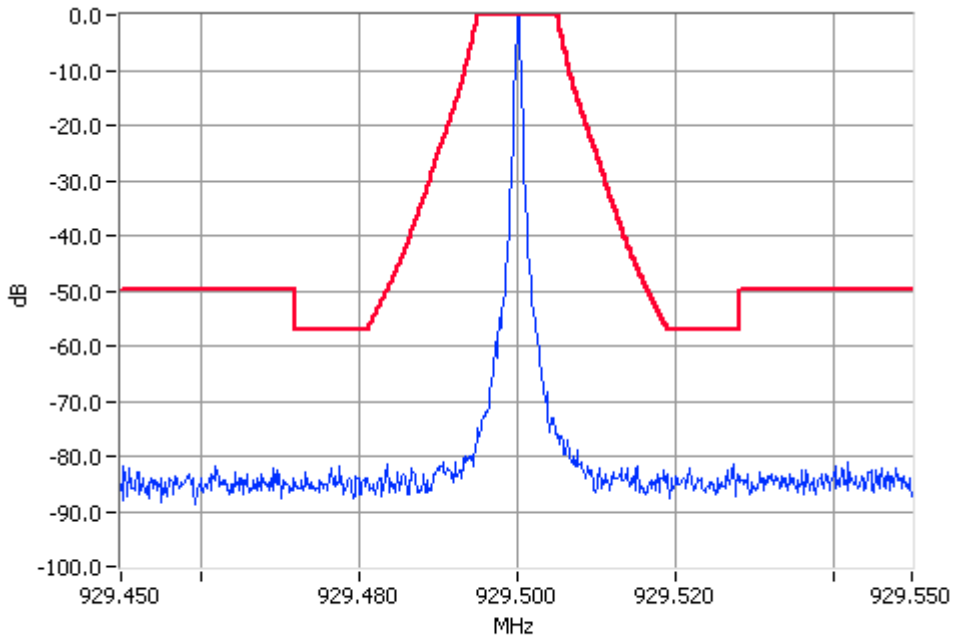

Unmodulated 929.5000MHz Mask G 5W Pass  
RBW=300Hz VBW=3000Hz

512 Baud

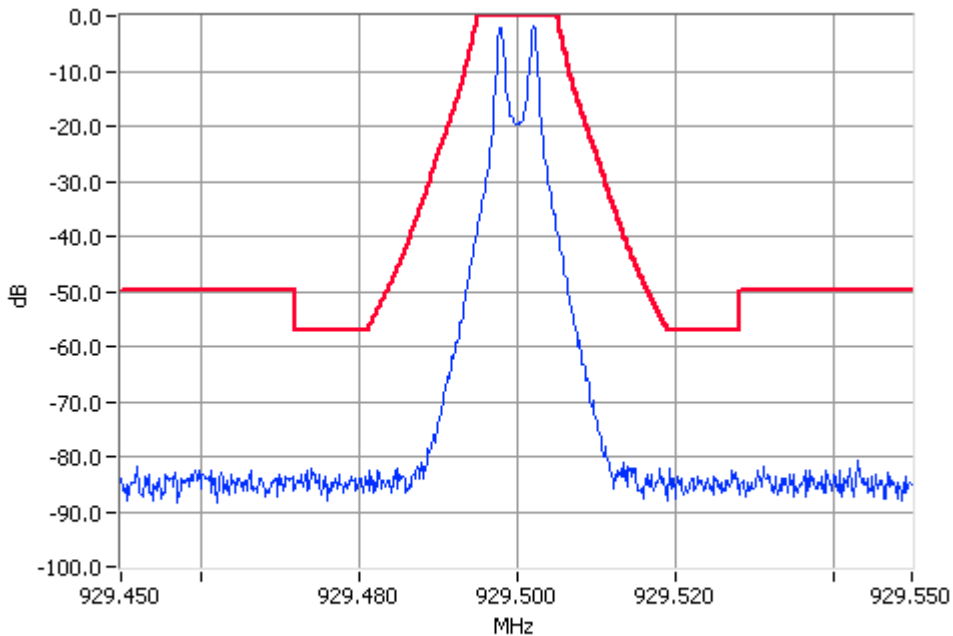

Paging Modulation 929.5000MHz Mask G 5W Pass  
RBW=300Hz VBW=3000Hz

OCCUPIED BANDWIDTH

Paging - POCSAG

SPECIFICATION: FCC CFR 2.1049 (c)

Tx FREQUENCY: 929.5 MHz 5 W 12.5 kHz Channel Spacing

1200 Baud

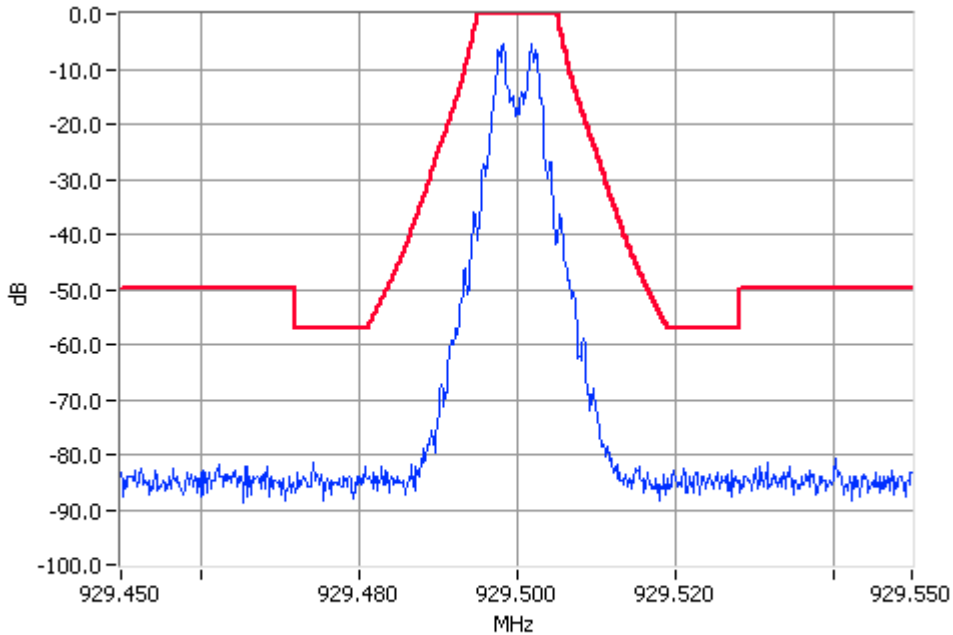

Paging Modulation 929.5000MHz Mask G 5W Pass  
RBW=300Hz VBW=3000Hz

2400 Baud

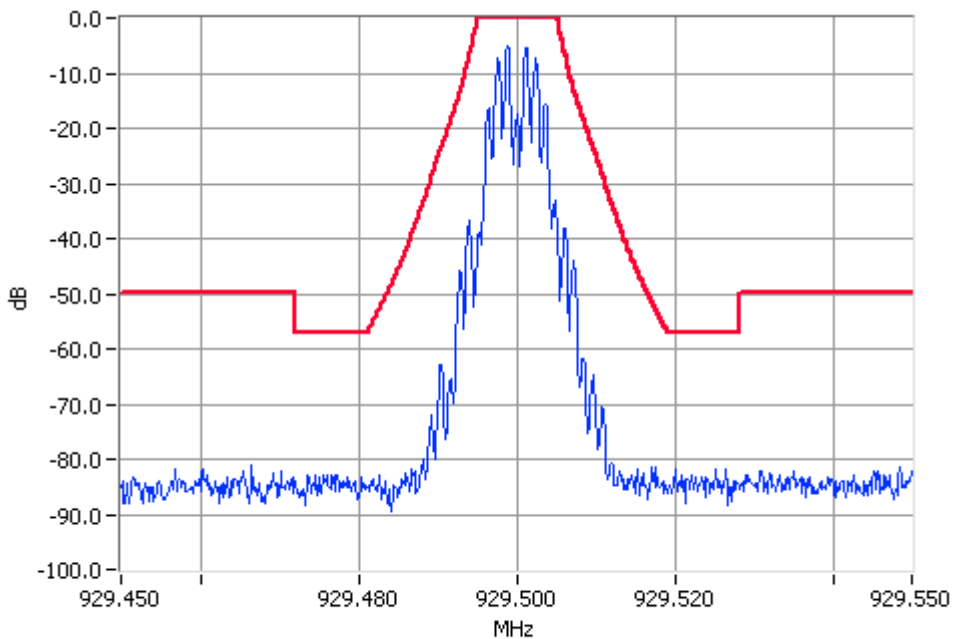

Paging Modulation 929.5000MHz Mask G 5W Pass  
RBW=300Hz VBW=3000Hz

OCCUPIED BANDWIDTH

Paging - POCSAG

SPECIFICATION: FCC CFR 2.1049 (c)

Tx FREQUENCY: 929.5 MHz 1 W 12.5 kHz Channel Spacing

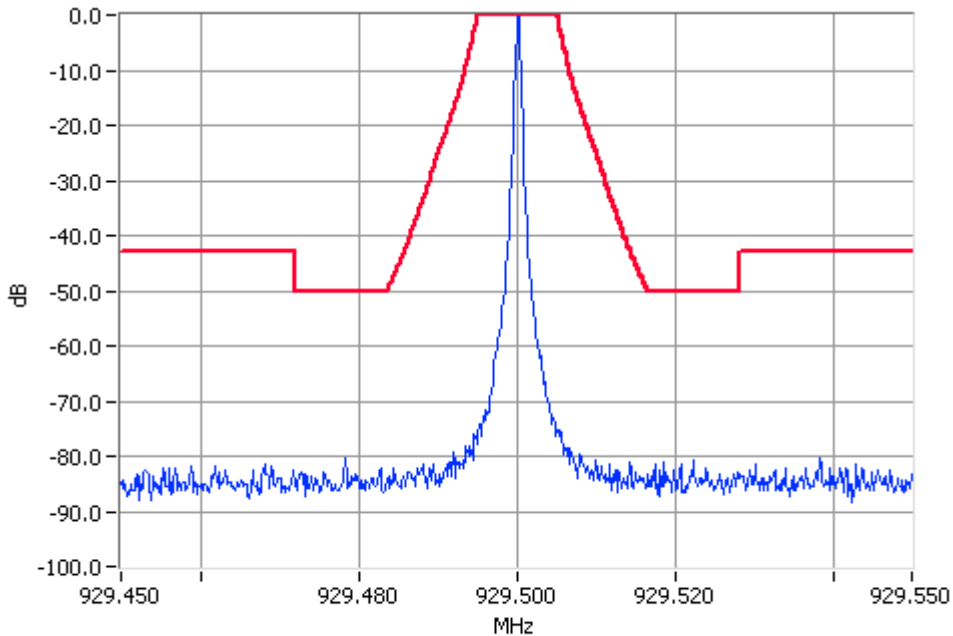

Unmodulated 929.5000MHz Mask G 1W Pass  
RBW=300Hz VBW=3000Hz

512 Baud

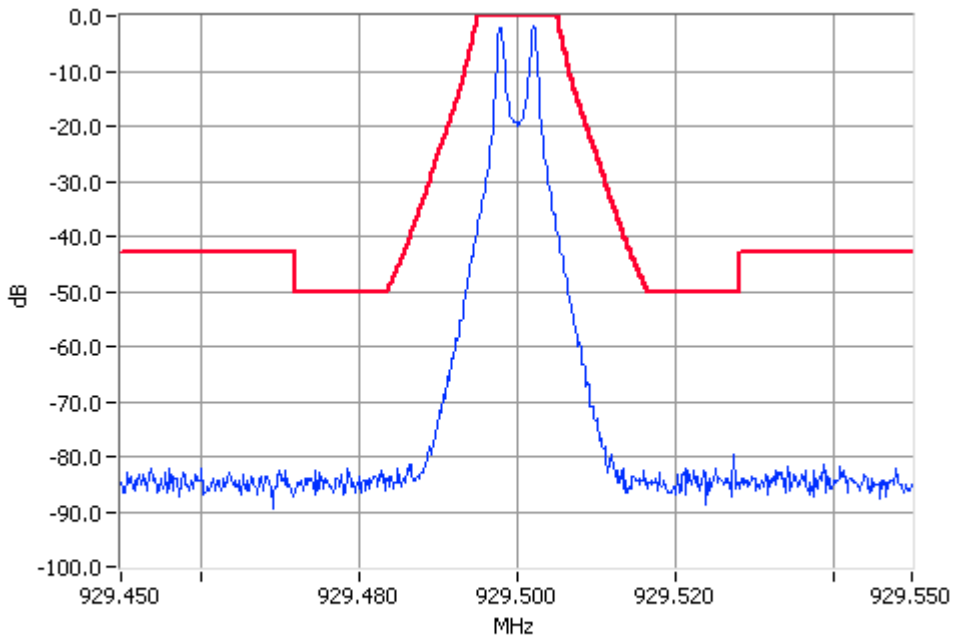

Paging Modulation 929.5000MHz Mask G 1W Pass  
RBW=300Hz VBW=3000Hz

OCCUPIED BANDWIDTH

Paging - POCSAG

SPECIFICATION: FCC CFR 2.1049 (c)

Tx FREQUENCY: 929.5 MHz 1 W 12.5 kHz Channel Spacing

1200 Baud

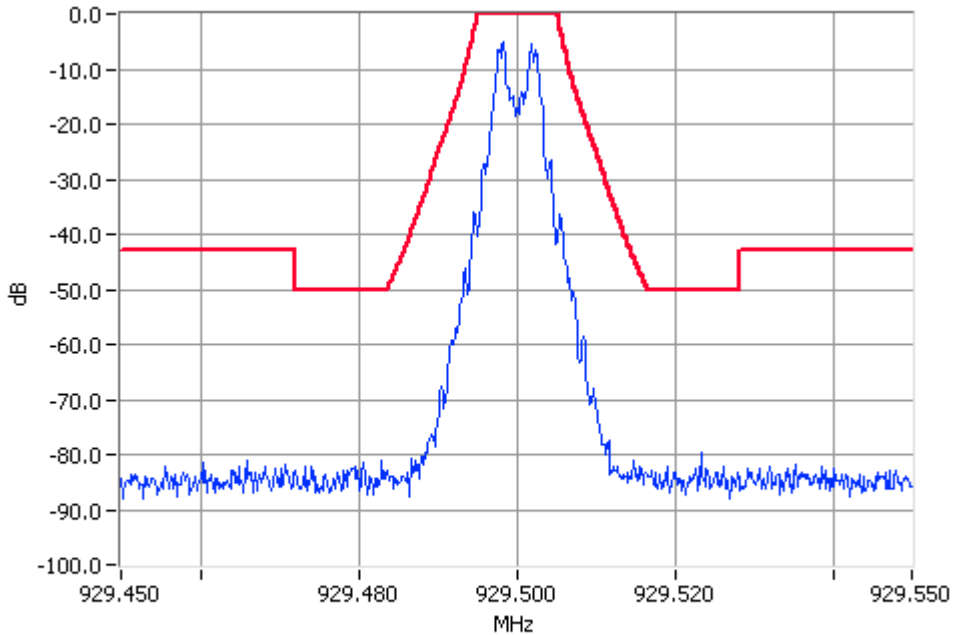

Paging Modulation 929.5000MHz Mask G 1W Pass  
RBW=300Hz VBW=3000Hz

2400 Baud

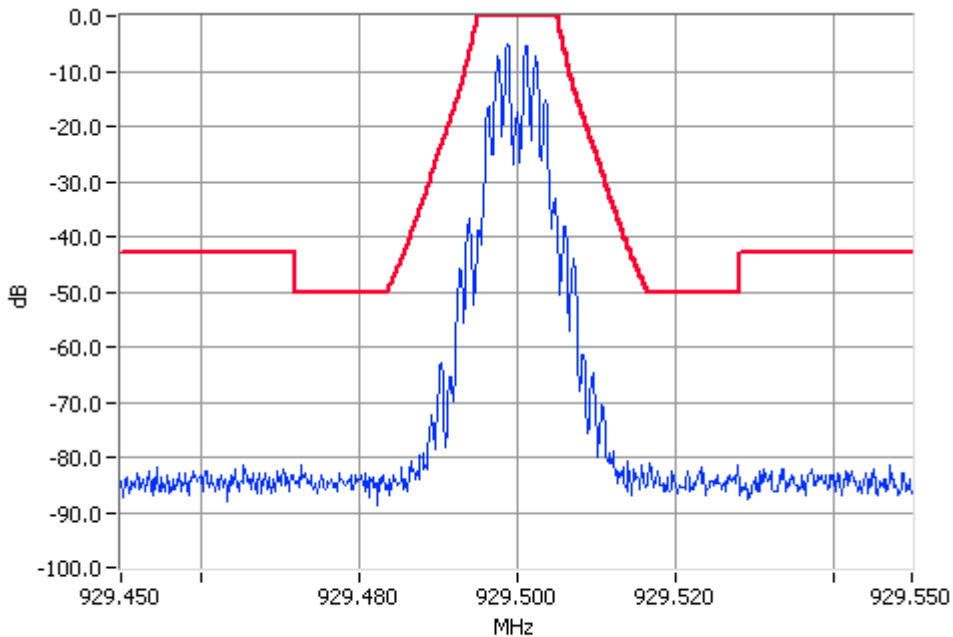

Paging Modulation 929.5000MHz Mask G 1W Pass  
RBW=300Hz VBW=3000Hz

OCCUPIED BANDWIDTH

Paging - POCSAG

SPECIFICATION: FCC CFR 2.1049 (c)

Tx FREQUENCY: 929.5 MHz 5 W 25 kHz Channel Spacing

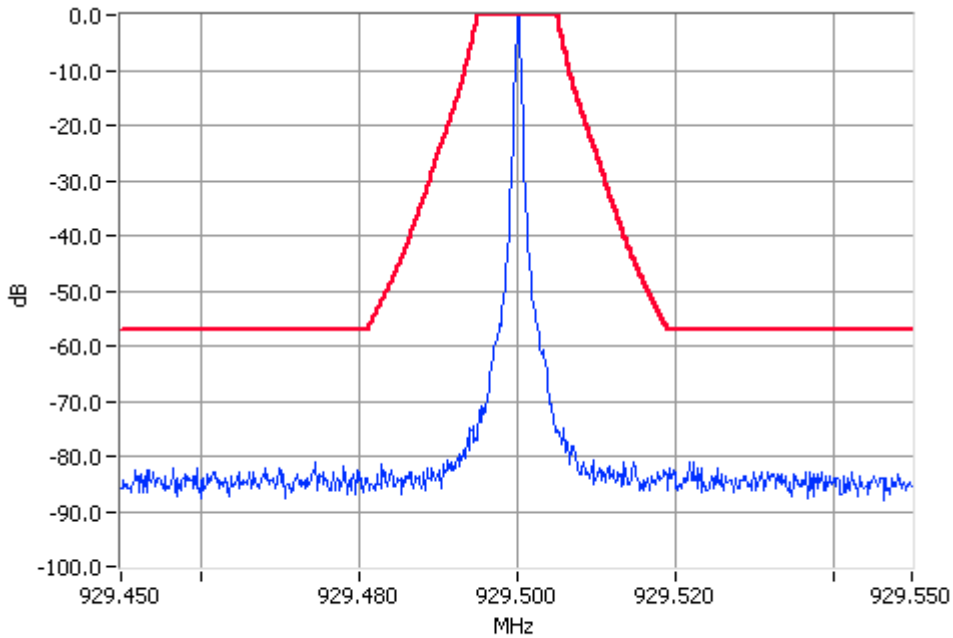

Unmodulated 929.5000MHz Mask G 5W Pass  
RBW=300Hz VBW=3000Hz

512 Baud

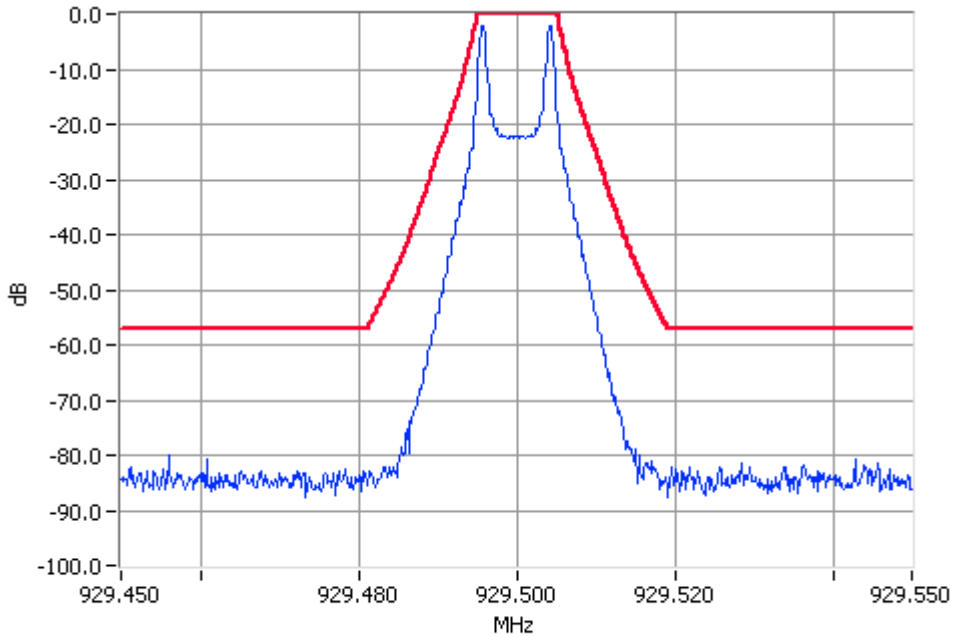

Paging Modulation 929.5000MHz Mask G 5W Pass  
RBW=300Hz VBW=3000Hz



OCCUPIED BANDWIDTH

Paging - POCSAG

SPECIFICATION: FCC CFR 2.1049 (c)

Tx FREQUENCY: 929.5 MHz 5 W 25 kHz Channel Spacing

1200 baud

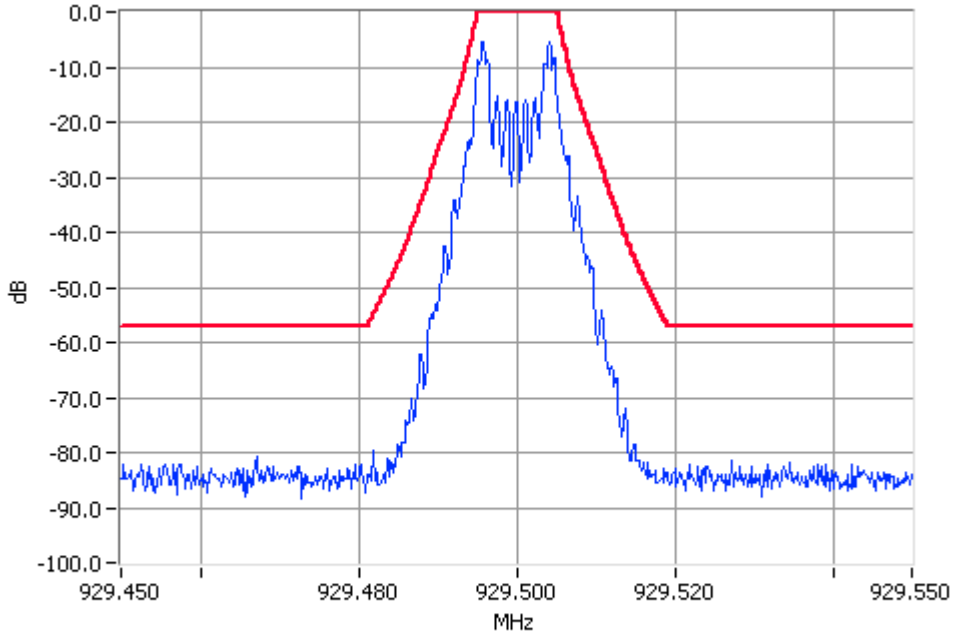

Paging Modulation 929.5000MHz Mask G 5W Pass  
RBW=300Hz VBW=3000Hz

2400 Baud

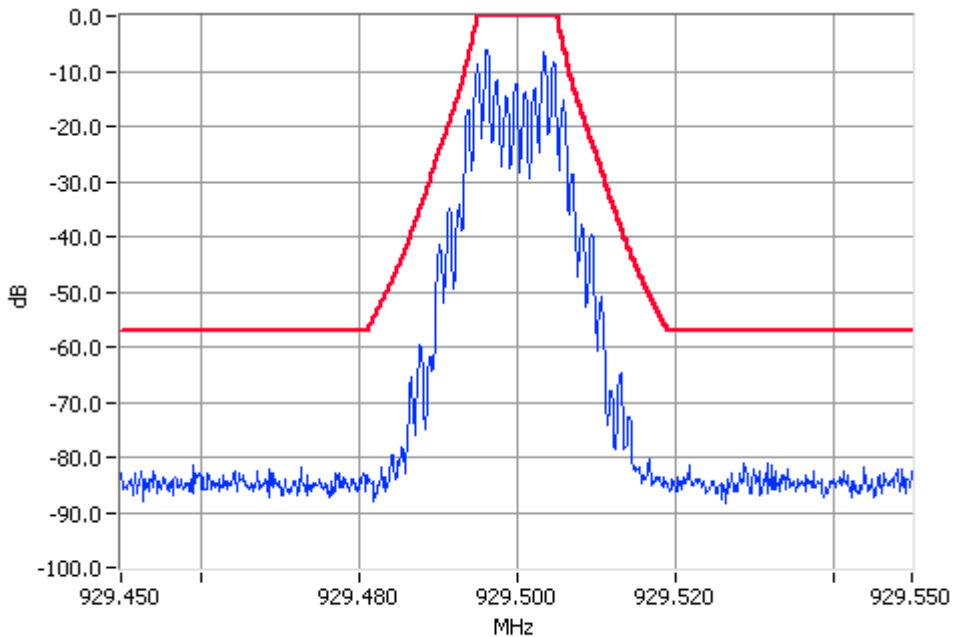

Paging Modulation 929.5000MHz Mask G 5W Pass  
RBW=300Hz VBW=3000Hz

OCCUPIED BANDWIDTH

Paging - POCSAG

SPECIFICATION: FCC CFR 2.1049 (c)

Tx FREQUENCY: 929.5 MHz 1 W 25 kHz Channel Spacing

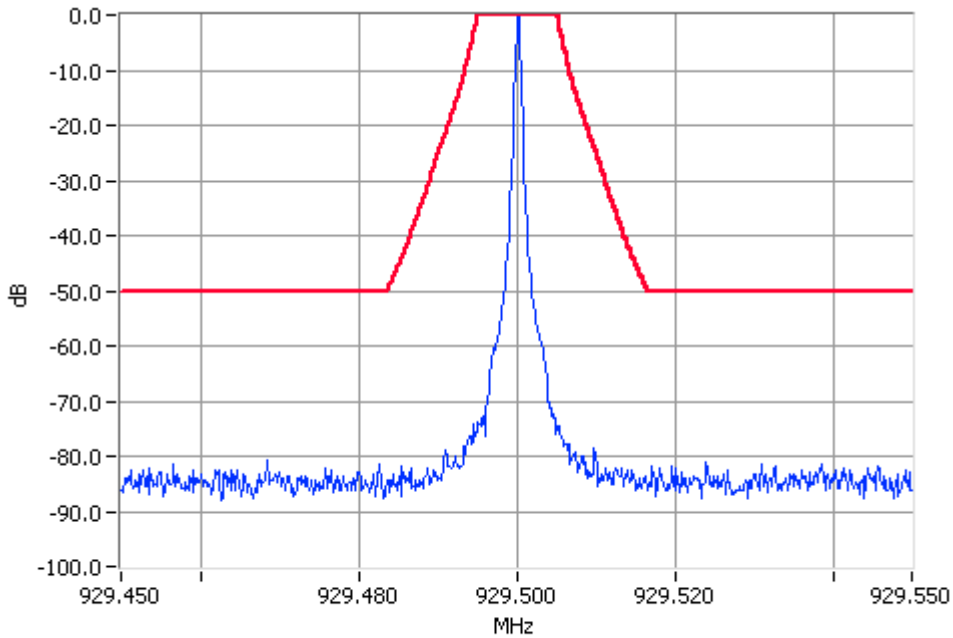

Unmodulated 929.5000MHz Mask G 1W Pass  
RBW=300Hz VBW=3000Hz

512 Baud

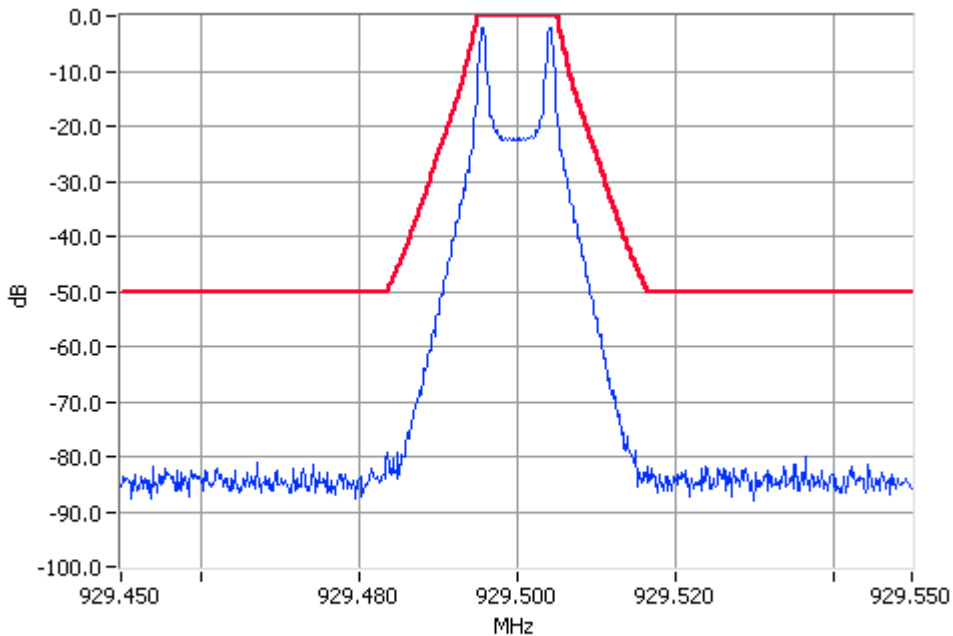

Paging Modulation 929.5000MHz Mask G 1W Pass  
RBW=300Hz VBW=3000Hz

OCCUPIED BANDWIDTH

Paging - POCSAG

SPECIFICATION: FCC CFR 2.1049 (c)

Tx FREQUENCY: 929.5 MHz 1 W 25 kHz Channel Spacing

1200 Baud

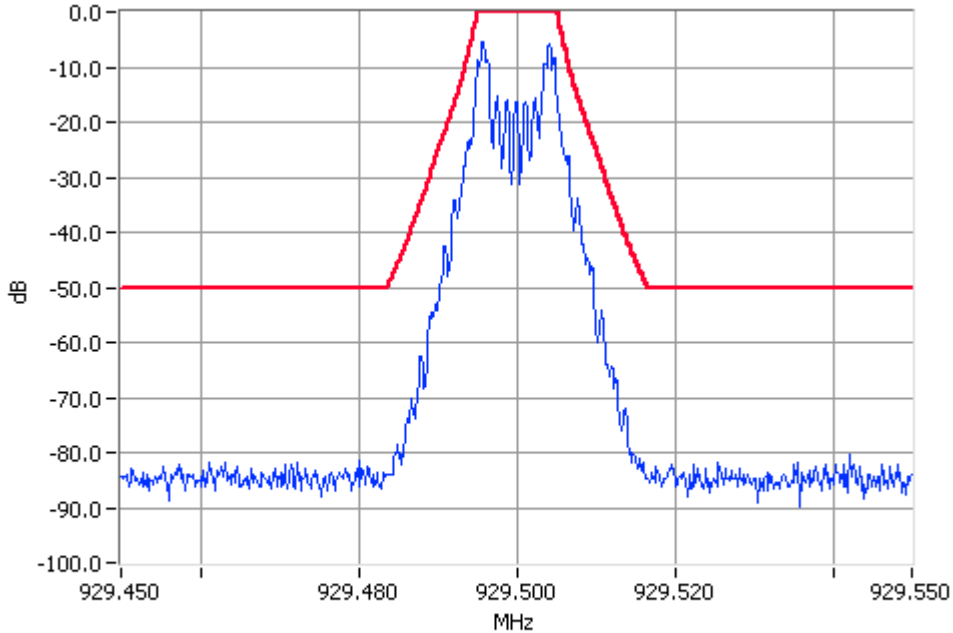

Paging Modulation 929.5000MHz Mask G 1W Pass  
RBW=300Hz VBW=3000Hz

2400 Baud

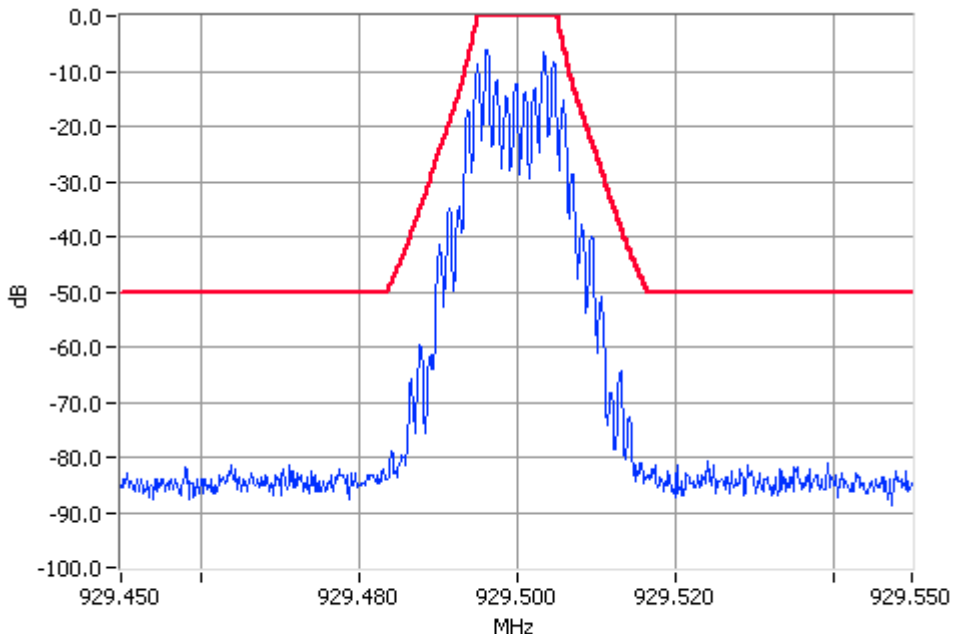

Paging Modulation 929.5000MHz Mask G 1W Pass  
RBW=300Hz VBW=3000Hz

OCCUPIED BANDWIDTH

Paging - POCSAG

SPECIFICATION: FCC CFR 2.1049 (c)

Tx FREQUENCY: 937.5 MHz 100 W 12.5 kHz Channel Spacing

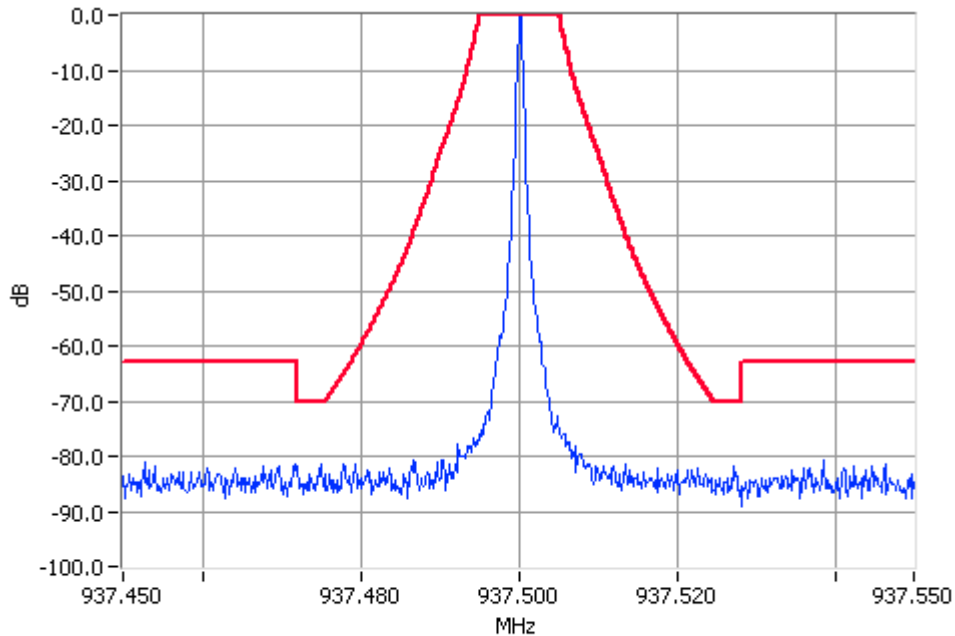

Unmodulated 937.5000MHz Mask G 100W Pass  
RBW=300Hz VBW=3000Hz

512 Baud

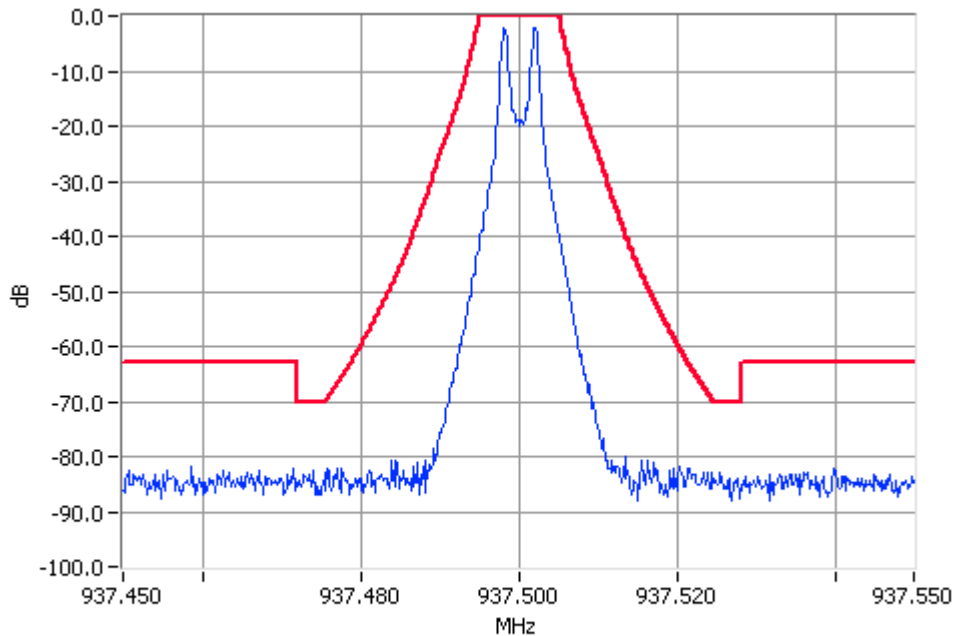

Paging Modulation 937.5000MHz Mask G 100W Pass  
RBW=300Hz VBW=3000Hz

OCCUPIED BANDWIDTH

Paging - POCSAG

SPECIFICATION: FCC CFR 2.1049 (c)

Tx FREQUENCY: 937.5 MHz 100 W 12.5 kHz Channel Spacing

1200 Baud

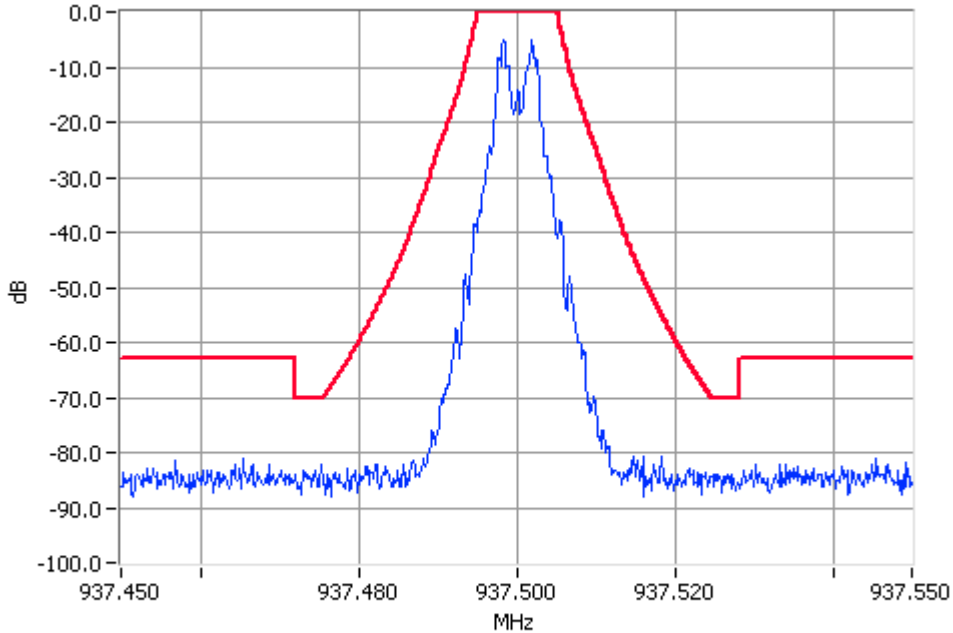

Paging Modulation 937.5000MHz Mask G 100W Pass  
RBW=300Hz VBW=3000Hz

2400 Baud

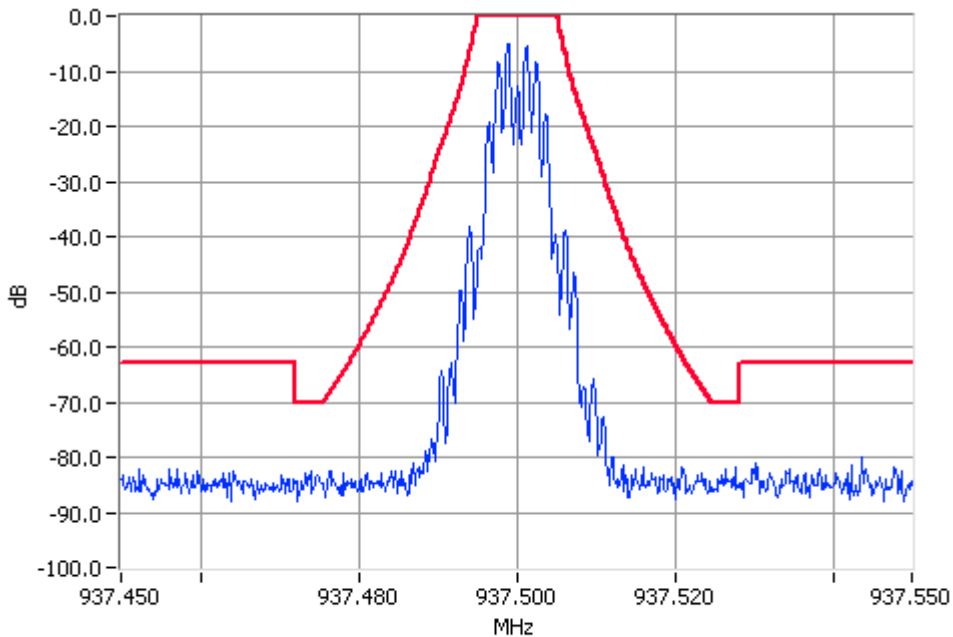

Paging Modulation 937.5000MHz Mask G 100W Pass  
RBW=300Hz VBW=3000Hz

OCCUPIED BANDWIDTH

Paging - POCSAG

SPECIFICATION: FCC CFR 2.1049 (c)

Tx FREQUENCY: 937.5 MHz 10 W 12.5 kHz Channel Spacing

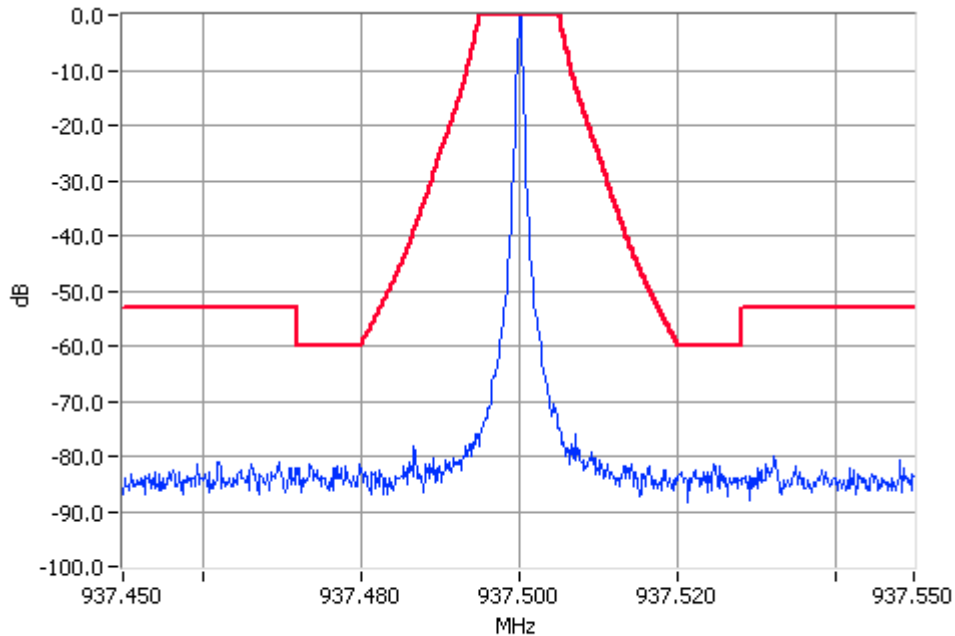

Unmodulated 937.5000MHz Mask G 10W Pass  
RBW=300Hz VBW=3000Hz

512 Baud

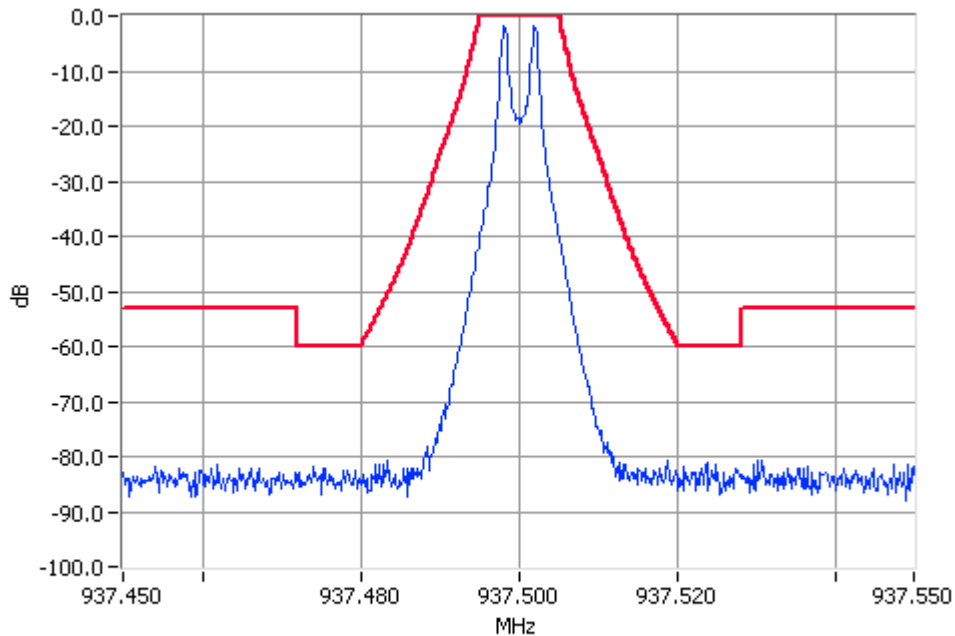

Paging Modulation 937.5000MHz Mask G 10W Pass  
RBW=300Hz VBW=3000Hz

OCCUPIED BANDWIDTH

Paging - POCSAG

SPECIFICATION: FCC CFR 2.1049 (c)

Tx FREQUENCY: 937.5 MHz 10 W 12.5 kHz Channel Spacing

1200 Baud

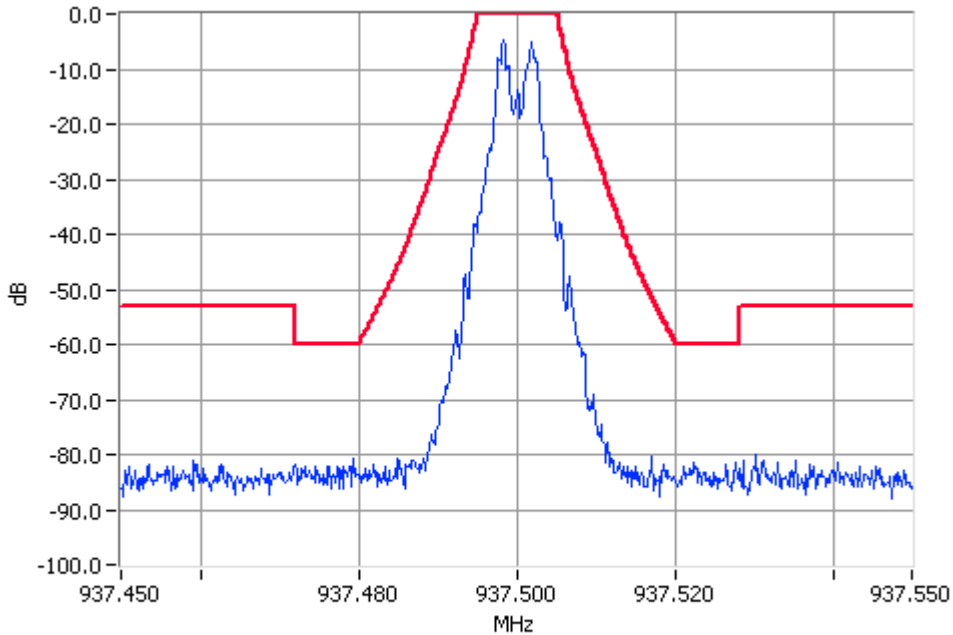

Paging Modulation 937.5000MHz Mask G 10W Pass  
RBW=300Hz VBW=3000Hz

2400 Baud

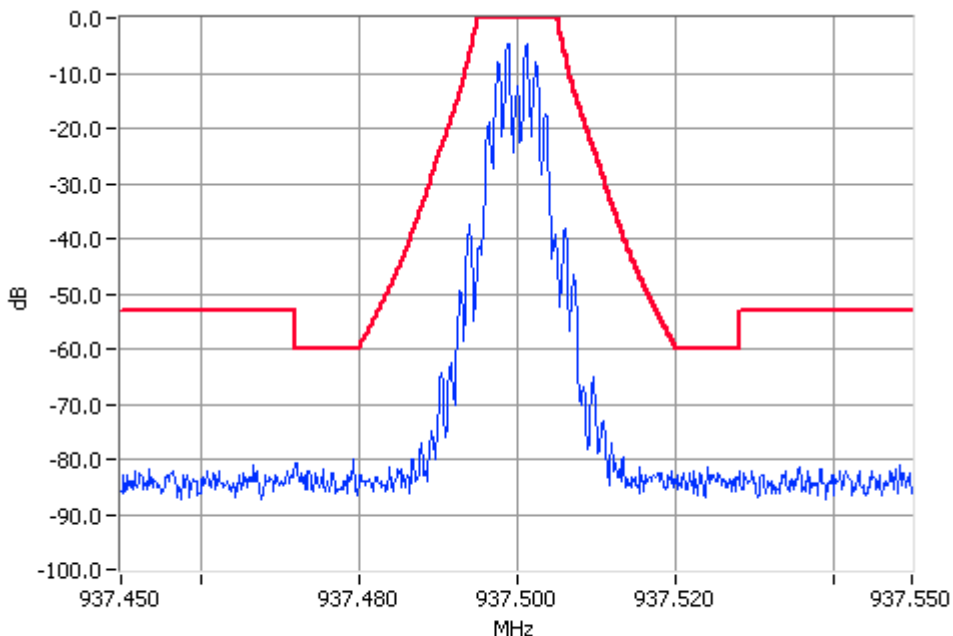

Paging Modulation 937.5000MHz Mask G 10W Pass  
RBW=300Hz VBW=3000Hz

OCCUPIED BANDWIDTH

Paging - POCSAG

SPECIFICATION: FCC CFR 2.1049 (c)

Tx FREQUENCY: 937.5 MHz 5 W 12.5 kHz Channel Spacing

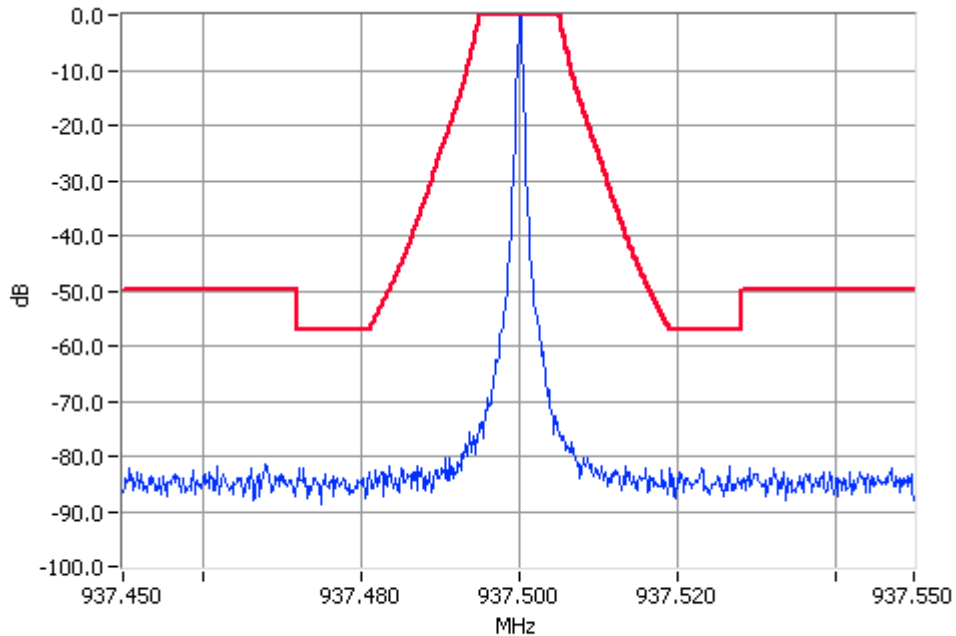

Unmodulated 937.5000MHz Mask G 5W Pass  
RBW=300Hz VBW=3000Hz

512 Baud

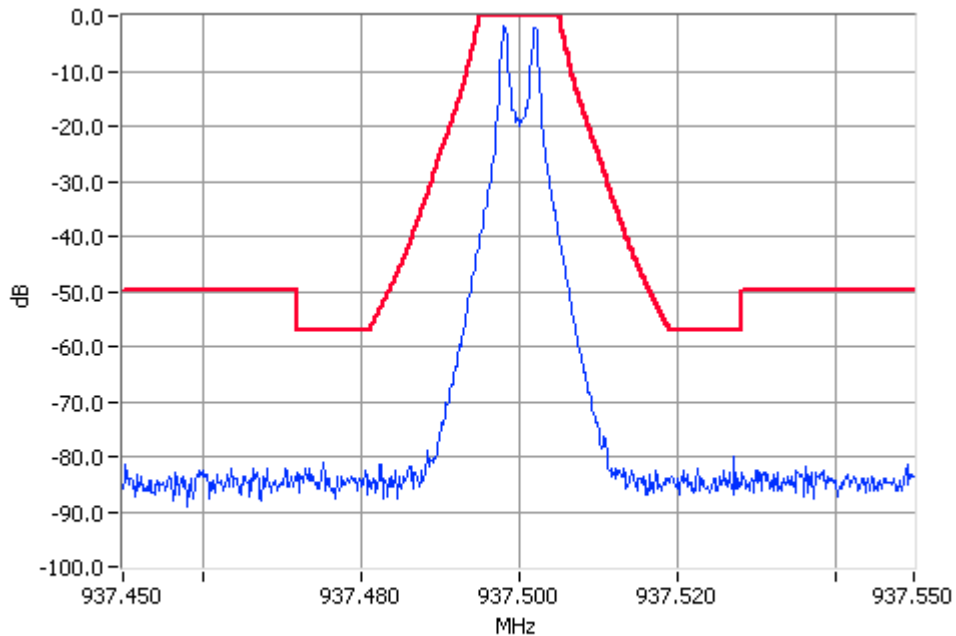

Paging Modulation 937.5000MHz Mask G 5W Pass  
RBW=300Hz VBW=3000Hz



OCCUPIED BANDWIDTH

Paging - POCSAG

SPECIFICATION: FCC CFR 2.1049 (c)

Tx FREQUENCY: 937.5 MHz 5 W 12.5 kHz Channel Spacing

1200 Baud

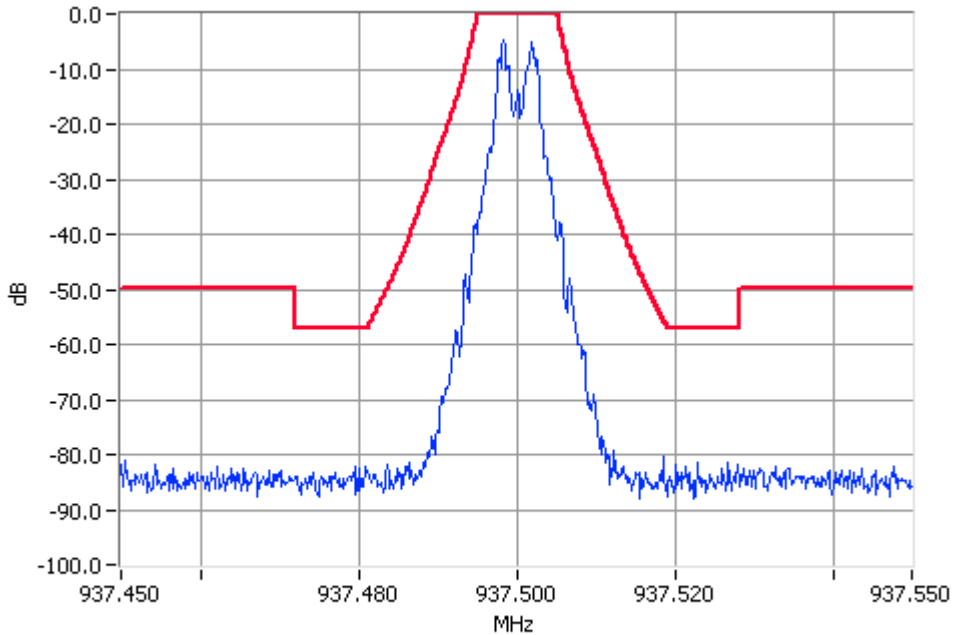

Paging Modulation 937.5000MHz Mask G 5W Pass  
RBW=300Hz VBW=3000Hz

2400 Baud

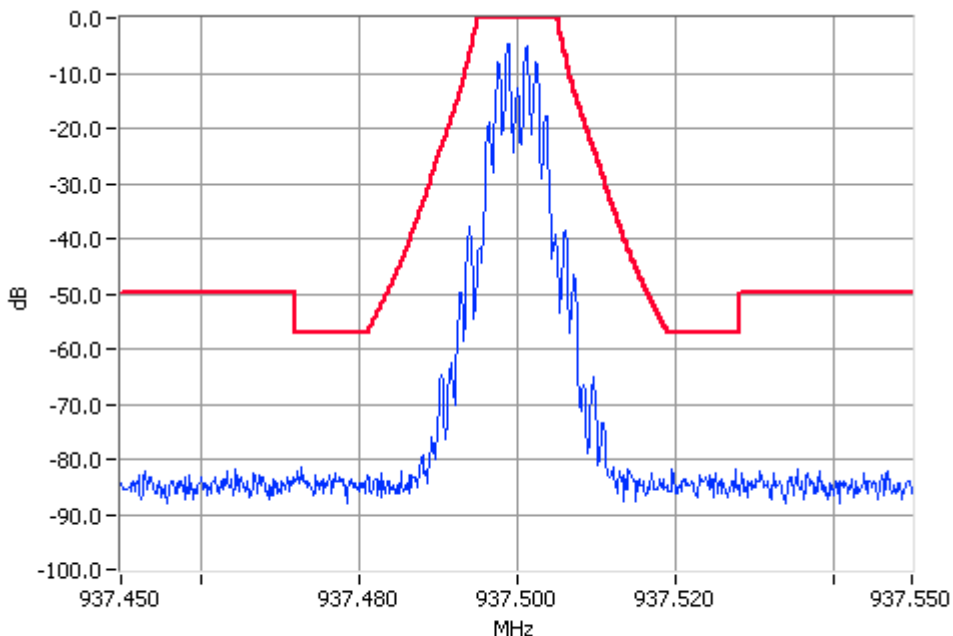

Paging Modulation 937.5000MHz Mask G 5W Pass  
RBW=300Hz VBW=3000Hz

OCCUPIED BANDWIDTH

Paging - POCSAG

SPECIFICATION: FCC CFR 2.1049 (c)

Tx FREQUENCY: 937.5 MHz 1 W 12.5 kHz Channel Spacing

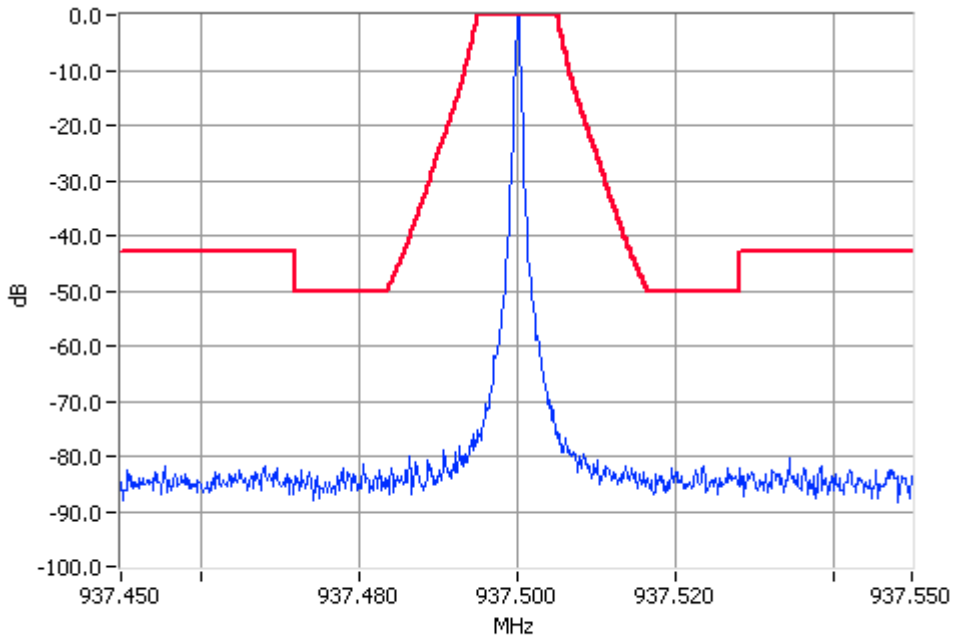

Unmodulated 937.5000MHz Mask G 1W Pass  
RBW=300Hz VBW=3000Hz

512 Baud

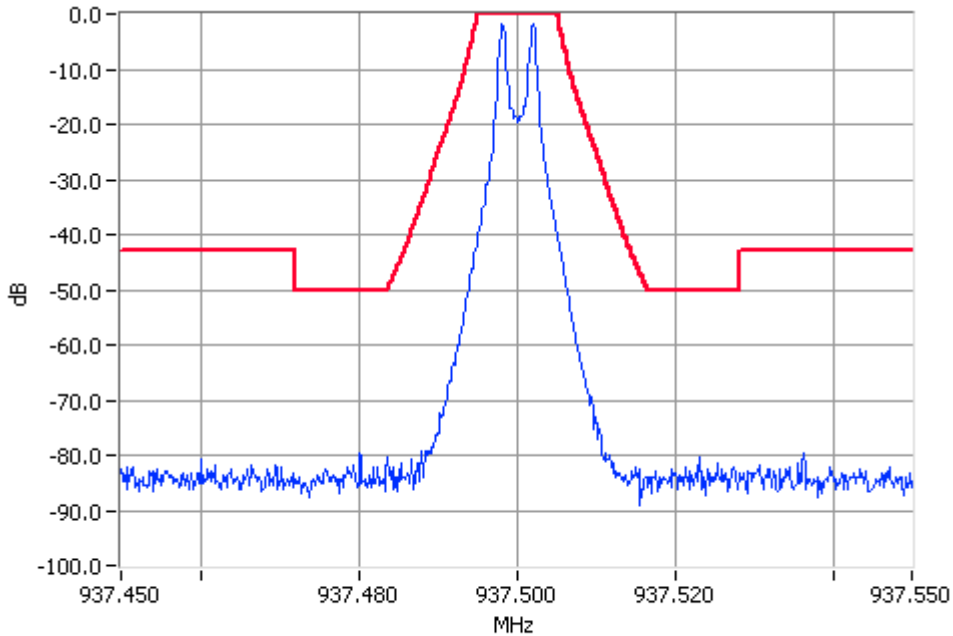

Paging Modulation 937.5000MHz Mask G 1W Pass  
RBW=300Hz VBW=3000Hz

OCCUPIED BANDWIDTH

Paging - POCSAG

SPECIFICATION: FCC CFR 2.1049 (c)

Tx FREQUENCY: 937.5 MHz 1 W 12.5 kHz Channel Spacing

1200 Baud

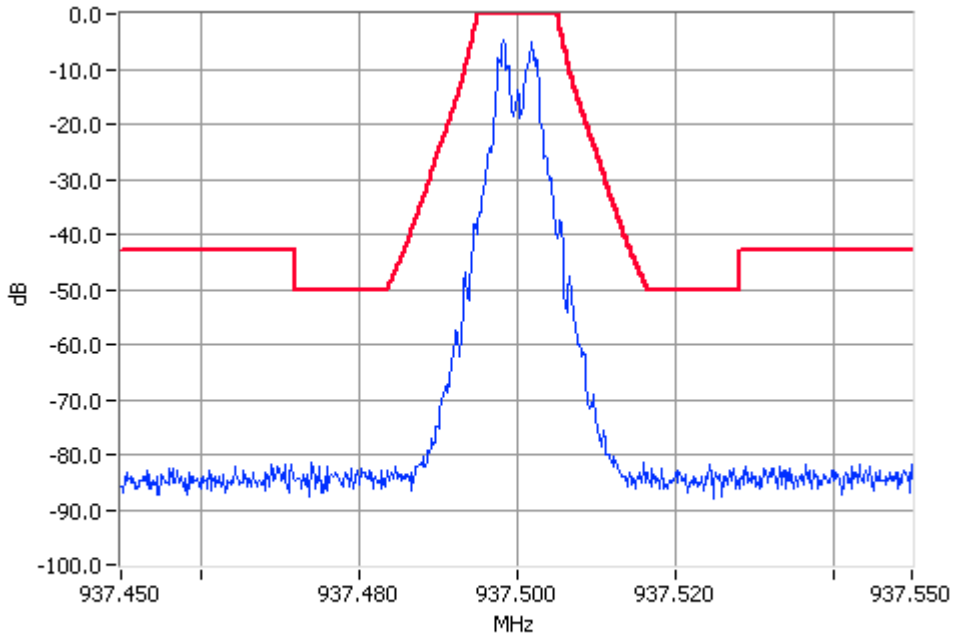

Paging Modulation 937.5000MHz Mask G 1W Pass  
RBW=300Hz VBW=3000Hz

2400 Baud

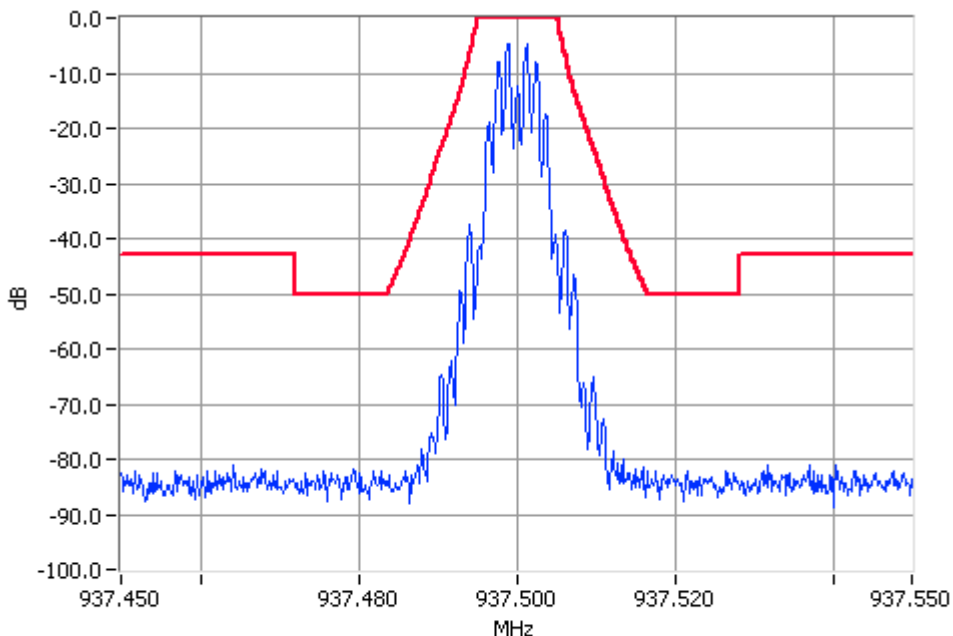

Paging Modulation 937.5000MHz Mask G 1W Pass  
RBW=300Hz VBW=3000Hz

## SPURIOUS EMISSIONS (CONDUCTED)

SPECIFICATION: FCC 47 CFR 2.1051

GUIDE: TIA/EIA-603B 2.2.13

### MEASUREMENT PROCEDURE:

1. Refer Appendix A for equipment set up.
2. The frequency range examined was from the lowest frequency generated within the EUT, to a frequency higher than the 10<sup>th</sup> Harmonic: 100kHz to Fc-BW  
Fc+BW to 10.0 GHz
3. A Pre-scan is performed with a resolution bandwidth of 1 kHz, and a video bandwidth of 3 kHz. If any emissions are found to be within 20dB of the limit a second measurement is made with the carrier modulated, and a resolution bandwidth of 10 kHz, and a video bandwidth of 30kHz.
4. Spurious emissions which were attenuated more than 20dB below the limit were not recorded.

### MEASUREMENT RESULTS:

See the tables on the following pages for 12.5 kHz channel spacing.

LIMIT CLAUSE: FCC 47 CFR 90.210

SPURIOUS EMISSIONS (CONDUCTED)

SPECIFICATION: FCC CFR 2.1051

Tx FREQUENCY: 937.6 MHz

Power Amplifier: 100W		
12.5 kHz Channel Spacing	937.6 MHz @ 100 W	Emission Mask I
Emission Frequency (MHz)	Level (dBm)	Level (dBc)
~	~	~
No emissions were detected at a level greater than 20 dB below the limit.		

Power Amplifier: 100W		
12.5 kHz Channel Spacing	937.6 MHz @ 10 W	Emission Mask I
Emission Frequency (MHz)	Level (dBm)	Level (dBc)
~	~	~
No emissions were detected at a level greater than 20 dB below the limit.		

LIMITS:

Carrier Output Power Watts	Emission Mask I 12.5 kHz Channel Spacing $43 + 10 \text{ Log}_{10} (P_{\text{Watts}})$	
100 W	-13 dBm	63 dBc
10 W	-13 dBm	53 dBc

SPURIOUS EMISSIONS (CONDUCTED)

SPECIFICATION: FCC CFR 2.1051

Tx FREQUENCY: 937.6 MHz

12v Power Amplifier: 5W		
12.5 kHz Channel Spacing	937.6 MHz @ 5 W	Emission Mask I
Emission Frequency (MHz)	Level (dBm)	Level (dBc)
~	~	~
No emissions were detected at a level greater than 20 dB below the limit.		

12v Power Amplifier: 1W		
12.5 kHz Channel Spacing	937.6 MHz @ 1 W	Emission Mask I
Emission Frequency (MHz)	Level (dBm)	Level (dBc)
~	~	~
No emissions were detected at a level greater than 20 dB below the limit.		

LIMITS:

Carrier Output Power Watts	Emission Mask I 12.5 kHz Channel Spacing $43 + 10 \text{ Log}_{10} (P_{\text{Watts}})$	
5 W	-13 dBm	50 dBc
1 W	-13 dBm	43 dBc

SPURIOUS EMISSIONS (RADIATED)

SPECIFICATION: FCC 47 CFR 2.1053

GUIDE: TIA/EIA-603B 2.2.12

MEASUREMENT PROCEDURE:

1. Refer Appendix A for equipment set up.
2. The EUT was placed on a wooden turntable at a distance of three metres from the test antenna. The output terminal was connected to an RF dummy load.
3. The turntable was rotated through 360° to obtain the maximum response of each spurious emission. Valid emissions were determined by switching the EUT on and off.
4. The EUT was replaced by a signal generator and substitution antenna to make measurements by the substitution method.

MEASUREMENT RESULTS:

See the tables on the following pages

LIMIT CLAUSE: FCC 47 CFR 90.210

SPURIOUS EMISSIONS (RADIATED)

SPECIFICATION: FCC CFR 2.1053

Tx FREQUENCY: 937.6 MHz

Power Amplifier: 100W		
12.5 kHz Channel Spacing	937.6 MHz @ 100 W	Emission Mask I
Emission Frequency (MHz)	Level (dBm)	Level (dBc)
3750.4000	-19.96	69.96
No other emissions were detected at a level greater than 20 dB below the limit.		

Power Amplifier: 100W		
12.5 kHz Channel Spacing	937.6 MHz @ 10 W	Emission Mask I
Emission Frequency (MHz)	Level (dBm)	Level (dBc)
~	~	~
No emissions were detected at a level greater than 20 dB below the limit.		

LIMITS:

Carrier Output Power Watts	Emission Mask I 12.5 kHz Channel Spacing $43 + 10 \text{ Log}_{10} (P_{\text{Watts}})$	
100 W	-13 dBm	63 dBc
10 W	-13 dBm	53 dBc



SPURIOUS EMISSIONS (RADIATED)

SPECIFICATION: FCC CFR 2.1053

Tx FREQUENCY: 937.6 MHz

12v Power Amplifier: 5W		
12.5 kHz Channel Spacing	937.6 MHz @ 5 W	Emission Mask I
Emission Frequency (MHz)	Level (dBm)	Level (dBc)
~	~	~
No emissions were detected at a level greater than 20 dB below the limit.		

12v Power Amplifier: 5W		
12.5 kHz Channel Spacing	937.6 MHz @ 1 W	Emission Mask I
Emission Frequency (MHz)	Level (dBm)	Level (dBc)
~	~	~
No emissions were detected at a level greater than 20 dB below the limit.		

LIMITS:

Carrier Output Power Watts	Emission Mask I 12.5 kHz Channel Spacing $43 + 10 \text{ Log}_{10} (P_{\text{Watts}})$	
5 W	-13 dBm	50 dBc
1 W	-13 dBm	43 dBc

TRANSMITTER FREQUENCY STABILITY (TEMPERATURE)

SPECIFICATION: FCC 47 CFR 2.1055 (a) (1)

GUIDE: TIA/EIA-603B 2.2.2

MEASUREMENT PROCEDURE:

1. Refer Appendix A for equipment set up.
2. The EUT was tested for frequency error from  $-30^{\circ}\text{C}$   $\rightarrow$   $+50^{\circ}\text{C}$  in  $10^{\circ}\text{C}$  increments
3. The frequency error was recorded in parts per million (ppm).

MEASUREMENT RESULTS:

See the plots on the following pages.

LIMIT CLAUSE: FCC 47 CFR 90.213	
Frequency Range	Frequency Error (ppm)
929 $\rightarrow$ 930 MHz	1.5
935 $\rightarrow$ 940 MHz	0.1
LIMIT CLAUSE: FCC 47 CFR 22.355	
Frequency Range	Frequency Error (ppm)
929 $\rightarrow$ 960 MHz	1.5

TRANSMITTER FREQUENCY STABILITY (TEMPERATURE)

SPECIFICATION: FCC 47 CFR 2.1055 (a) (1)

Tx FREQUENCY: 929.5 MHz 100W

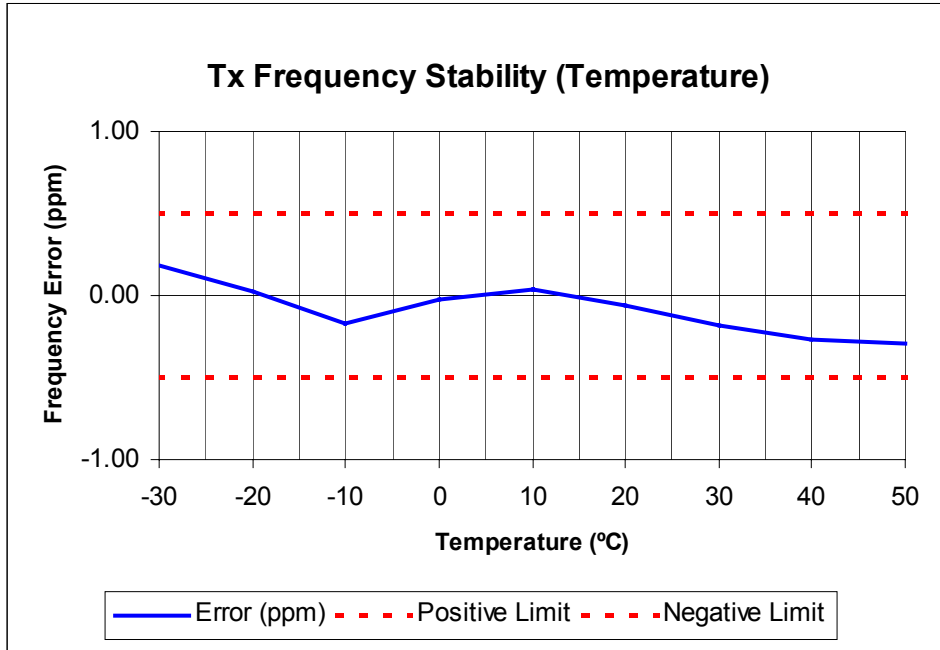

Tx FREQUENCY: 937.6 MHz 100W

(External 10 MHz Frequency Reference T801-20-000)

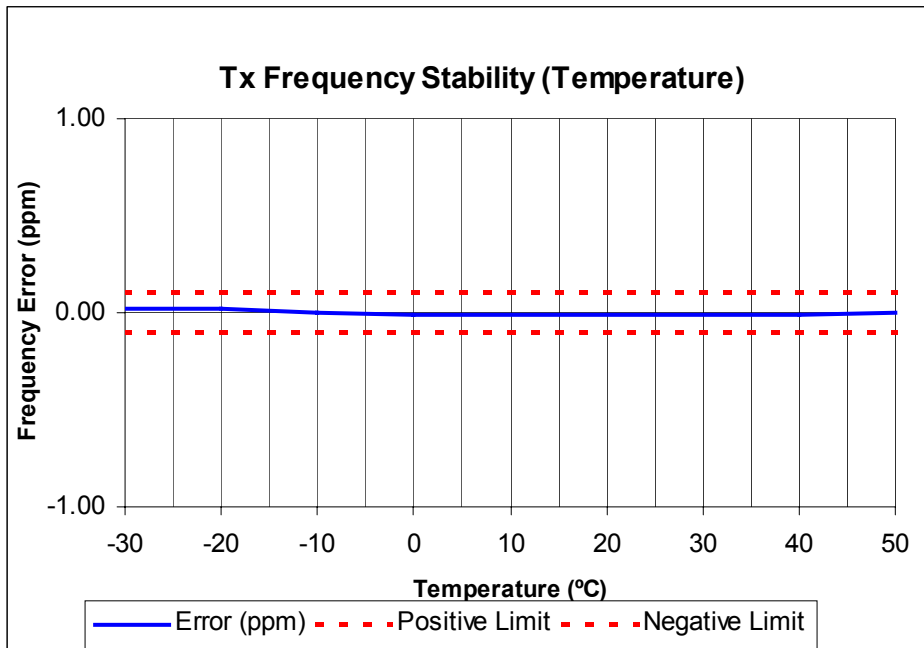

TRANSMITTER FREQUENCY STABILITY (TEMPERATURE)

SPECIFICATION: FCC 47 CFR 2.1055 (a) (1)

Tx FREQUENCY: 929.5 MHz 5W 12v POWER AMPLIFIER

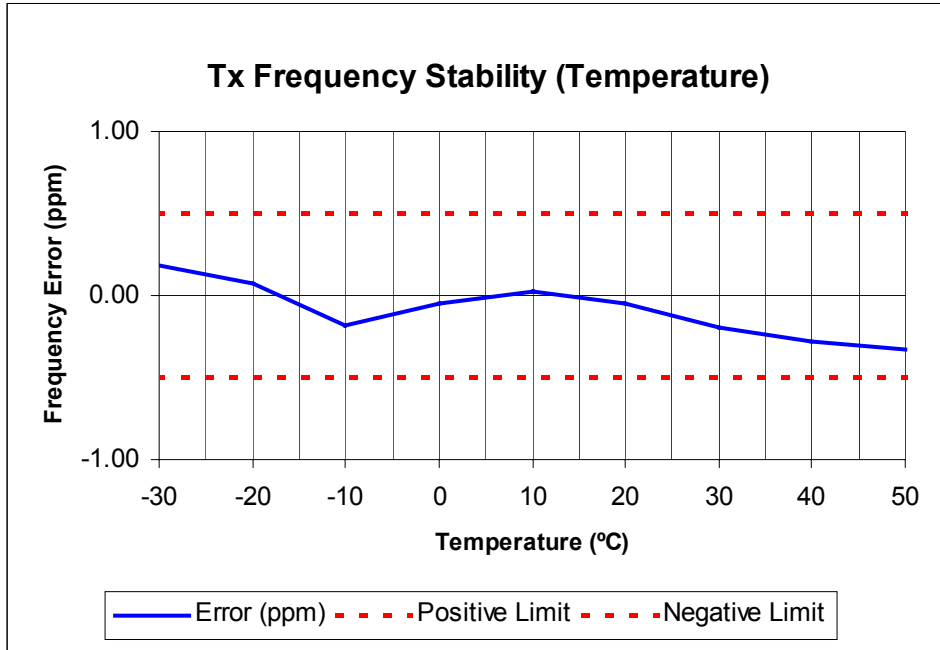

Tx FREQUENCY: 937.6 MHz 5W 12v POWER AMPLIFIER

(External 10 MHz Frequency Reference T801-20-000)

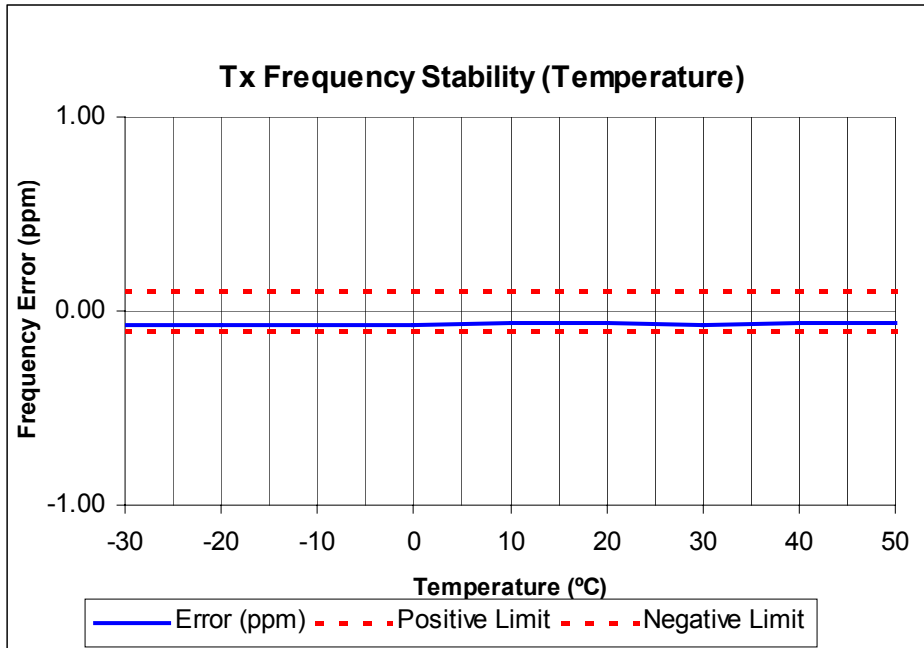

**TRANSMITTER FREQUENCY STABILITY (VOLTAGE)**

SPECIFICATION: FCC 47 CFR 2.1055 (d) (1)

GUIDE: TIA/EIA-603B 2.2.2

MEASUREMENT PROCEDURE:

1. Refer Appendix A for equipment set up.
2. The EUT was tested for frequency error at an input voltage to the radio of 85% to 115%.
3. The frequency error was recorded in parts per million (ppm).

MEASUREMENT RESULTS: 100W Power Amplifier

Frequency	FREQUENCY ERROR (ppm)		
	102 V ac	120 V ac	138 V ac
929.5 MHz	-0.01	-0.01	-0.01
937.6 MHz External 10 MHz Frequency Reference T801-20-000	-0.02	-0.01	-0.02

MEASUREMENT RESULTS: 5W 12V Power Amplifier

Frequency	FREQUENCY ERROR (ppm)		
	11.73 V ac	13.80 V ac	15.87 V ac
929.5 MHz	-0.03	-0.03	-0.03
937.6 MHz External 10 MHz Frequency Reference T801-20-000	-0.01	-0.01	-0.01

LIMIT CLAUSE: FCC 47 CFR 90.213

Frequency Range	Frequency Error (ppm)
929 → 930 MHz	1.5
935 → 940 MHz	0.1

LIMIT CLAUSE: FCC 47 CFR 22.355

Frequency Range	Frequency Error (ppm)
929 → 960 MHz	1.5

## TEST EQUIPMENT USED

No#	Equipment	Manufacturer	Model No	Serial No#	Tait ID	Cal Due
1	Signal Generator	Hewlett Packard	HP8642B (Opt 001)	2512A00176	E3064	07-Feb-06
11	Modulation Analyser	Hewlett Packard	HP8901B (Opt 002)	2441A00393	E3073	11-Sep-05
13	Audio Analyser	Hewlett Packard	HP8903A	2308A02597	E3074	15-Sep-05
37	Variac	Yamabishi	S-260-5	TX-533	E1737	On Use
43	Horn Antenna	Emco	DRG3115	2084	E3076	27-Sep-06
61	RF Attenuator 150W	Weinschel	40-20-33	CJ404	E3387	15-Nov-05
66	RF Attenuator 25W	Weinschel	33-20-33	BD5871	E3673	07-Nov-05
82	3m Coax Cable (BLUE)	Suhner	Sucoflex 104A	25033/4A	E3694	19-Nov-05
83	1m Coax Cable (BLUE)	Suhner	Sucoflex 104A	25006/4A	E3693	19-Nov-05
88	Spectrum Analyser	Hewlett Packard	HP8562E	3821A00779	E3715	14-Nov-05
115	Environ. Chamber	Contherm	5400 RHSLT.M	1416	E4051	14-Apr-06
116	Power Head	Hewlett Packard	HP11722A	2716A02037	E1575	10-Sep-05
135	Attenuator	Weinschel	67-30-33	BR0531	E4280	13-Aug-05
136	Multimeter	Fluke	77	35069359	E3237	09-Nov-05

## APPENDIX A

### TEST SETUP DETAILS

Radiated Emissions Set up.

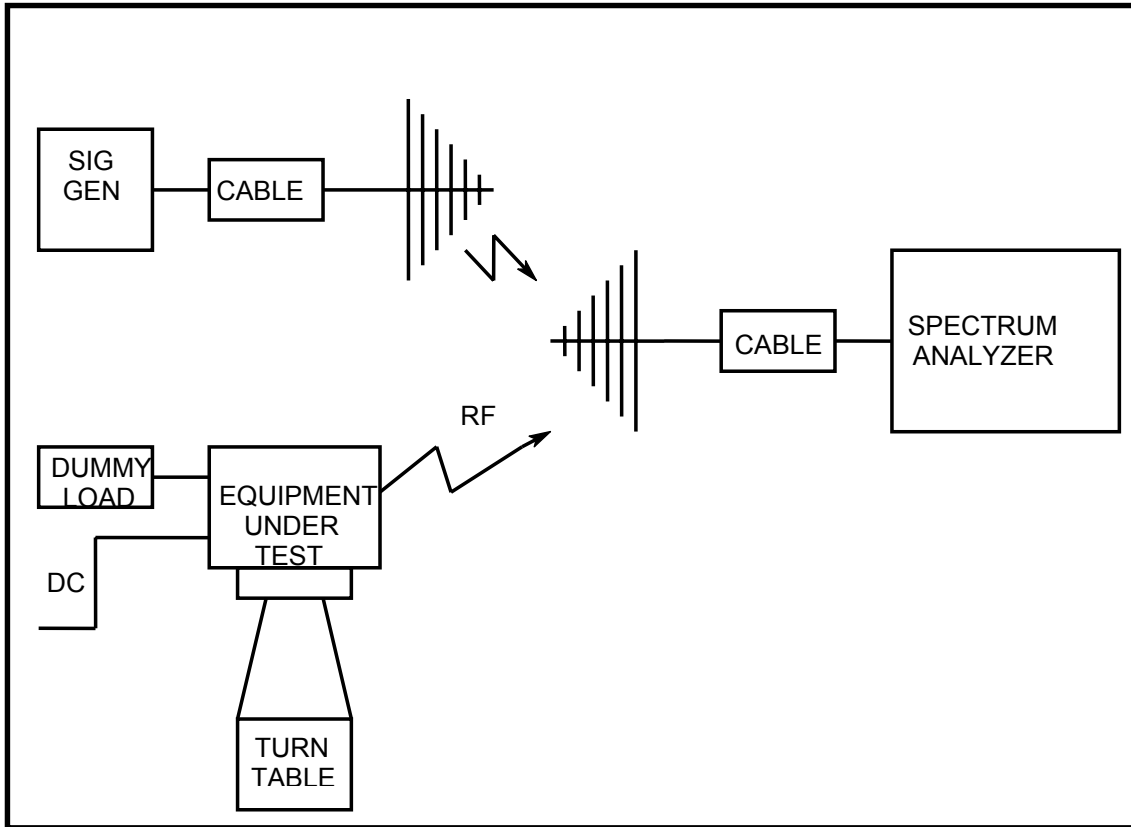

All other testing is performed using the Teltest Radio **EVAL**uation system (TREVA), which is configured as shown below. The Spectrum Analyser is connected to the EUT via the attenuator network for Conducted Emissions testing, and Occupied Bandwidth.

