

# Laboratory Test Report

For the  
TBAC0 Base Station Transceiver

Tested In accordance with

FCC 47 CFR Part 80 and 90T

Report Revision: 1  
Issue Date: 03-Nov-2005  
FCC ID: CASTBA9C0

PREPARED BY: Garry Pringle \_\_\_\_\_  
Test Technician

CHECKED & APPROVED BY: Hamish Newton \_\_\_\_\_  
Senior Technician



All tests reported herein have been performed in accordance with the laboratory's scope of accreditation

This document must not be reproduced except in full, without the written permission of the Compliance Laboratory Manager.

## TABLE OF CONTENTS

REVISION HISTORY .....	3
INTRODUCTION .....	4
REPORT PREPARED FOR .....	4
DESCRIPTION OF SAMPLE .....	4
STATEMENT OF COMPLIANCE.....	4
TEST CONDITIONS .....	5
NECESSARY BANDWIDTH AND EMISSION DESIGNATORS .....	5
TEST RESULTS.....	7
TRANSMITTER OUTPUT POWER (CONDUCTED) .....	7
TRANSMITTER AUDIO FREQUENCY RESPONSE - PRE-EMPHASIS .....	8
TRANSMITTER MODULATION LIMITING .....	10
OCCUPIED BANDWIDTH .....	13
<i>ANALOGUE VOICE</i> .....	14
<i>FFSK</i> .....	20
<i>DIGITAL DATA</i> .....	26
SPURIOUS EMISSIONS (CONDUCTED).....	32
SPURIOUS EMISSIONS (RADIATED).....	36
TRANSMITTER FREQUENCY STABILITY (TEMPERATURE) .....	40
TRANSMITTER FREQUENCY STABILITY (VOLTAGE) .....	42
TEST EQUIPMENT USED.....	43
APPENDIX A .....	44
TEST SETUP DETAILS.....	44

## Revision History

Date	Revision	Comments
03-Nov-2005	1	Initial test report

## Introduction

Type Approval Testing of the TBAC0, FCC ID: CASTBA9C0 Base Station Transceiver in accordance with:

FCC CFR 47 Part 80 and 90T

## Report Prepared For

Tait Electronics Ltd  
PO Box 1645  
558 Wairakei Rd  
Christchurch  
New Zealand

## Description of Sample

Equipment: Base Station Transceiver  
Type: TBAC0

The TBAC0 is a modular base station transceiver consisting of:

Module	Product Designation Code	Serial Number	Description
Reciter	TBA40C2-0B00 TBA40C2-0B00 <sup>1</sup>	18009809 18005716	Frequency Range 193 – 225 MHz
Power Amplifier	TBA90C0-0000 TBA90C0-0000 <sup>1</sup>	18005093 18004873	10 – 100 Watts in 1 Watt steps
Power Management Unit	TBA30A0-0000 TBA30A1-1100 <sup>1</sup>	18001020 18004274	Input 88 – 264 Vac 45 – 65 Hz Output: 28 Vdc
User Interface	TBA2020 TBA2020 <sup>1</sup>	18003380 18004611	-
High Stability Oscillator	T801-20-000 <sup>1</sup>	13122298	10 MHz output 0.01ppm

1. Used for Part 90T testing

## Statement of Compliance

The TBAC0 base station transceiver as tested in this report was found to conform to the following standards:

### FCC CFR 47 Part 80 and 90T



## Necessary Bandwidth and Emission Designators

### 3. Digital Data – C4FM (Data speed = 9600 bps)

Digital data transmissions use a 4 level frequency shift keying modulation scheme.

The necessary bandwidth as been measured using the 99% energy rule, and in accordance with TIA/EIA 102 CAAB 2.2.5.2

12.5kHz Bandwidth    99 % bandwidth  
6.6 kHz

Emission Designator

**6K60F2D**

F2D represents a FM data transmission with the use of a modulating sub carrier

25kHz Bandwidth    Necessary bandwidth  
9.6 kHz

Emission Designator

**9K60F2D**

F2D represents a FM data transmission with the use of a modulating sub carrier

## Test Results

### TRANSMITTER OUTPUT POWER (CONDUCTED)

SPECIFICATION: FCC 47 CFR 2.1046

GUIDE: TIA/EIA-603C 2.2.1

**MEASUREMENT PROCEDURE:**

1. Refer Annex A for Equipment set up.
2. The coaxial attenuator has an impedance of 50 Ohms.
3. The unmodulated output power was measured with an RF Power meter.

**MEASUREMENT RESULTS:**

*FCC 47 CFR 80.215*

216 – 220 MHz

Power Amplifier: 100W		
219.1 MHz	100 W nominal	10 W nominal
POWER (W)	99.4	9.9
Variation from Nominal (%)	-0.6	-0.1
Measurement Uncertainty (dB)	+0.63 -0.68	

*FCC 47 CFR 90.729*

Power Amplifier: 100W		
221.5 MHz	100 W nominal	10 W nominal
POWER (W)	99.6	9.60
Variation from Nominal (%)	-0.40	-4.00
Measurement Uncertainty (dB)	+0.63 -0.68	

LIMIT CLAUSE: FCC 47 CFR 90.205 (r)

Radio Type: Base Station Transceiver

The output power shall not exceed by more than 20% the manufacturer's rated output power for the particular transmitter.

TRANSMITTER AUDIO FREQUENCY RESPONSE - PRE-EMPHASIS

SPECIFICATION: FCC 47 CFR 2.1047 (a)

GUIDE: TIA/EIA-603C 2.2.6

MEASUREMENT PROCEDURE:

1. Refer Annex A for Equipment set up.
2. An audio input tone of 1000Hz was applied with the level set to obtain 20% of maximum deviation. This was used as the 0dB reference point.
3. The AF was varied while the audio level was held constant.
4. The response in dB relative to 1000Hz was measured.

LIMIT CLAUSE: TIA/EIA-603C 3.2.6

MEASUREMENT RESULTS:

219.1 MHz      12.5 kHz Channel Spacing      100 Watts

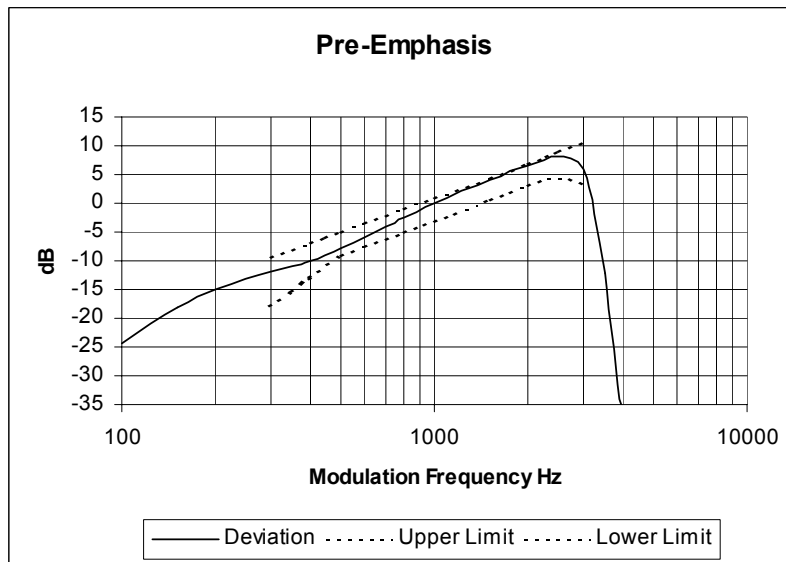

219.1 MHz      25.0 kHz Channel Spacing      100 Watts

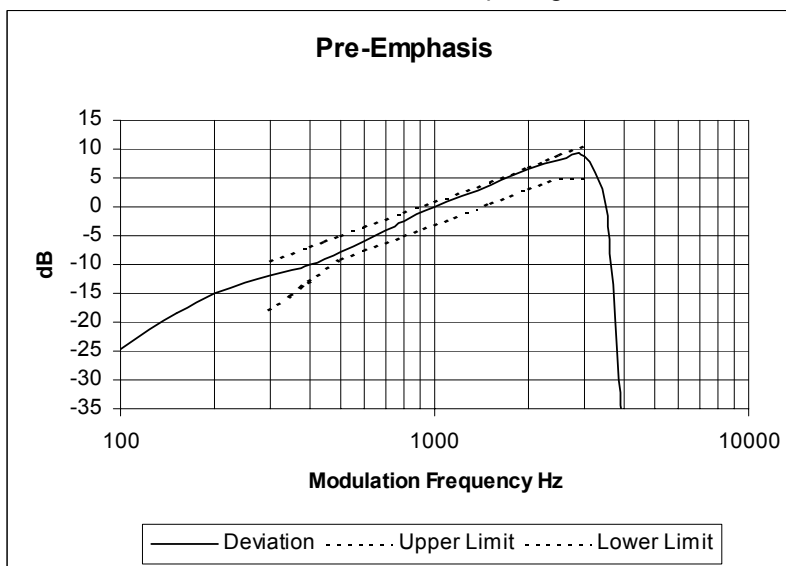



TRANSMITTER AUDIO FREQUENCY RESPONSE - PRE-EMPHASIS

SPECIFICATION: FCC CFR 2.1047 (a)

Tx FREQUENCY: 221.5 MHz 12.5 kHz Channel Spacing

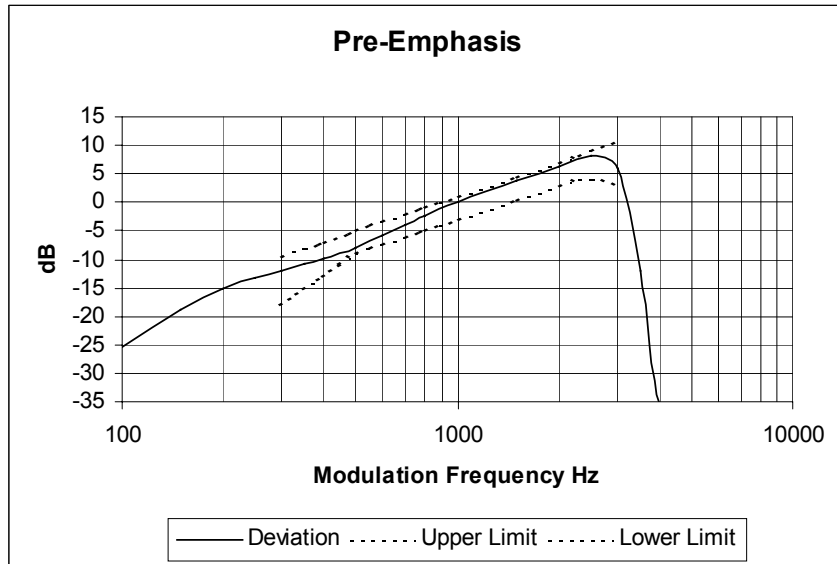

TRANSMITTER MODULATION LIMITING

SPECIFICATION: FCC 47 CFR 2.1047 (b)

MEASUREMENT PROCEDURE:

1. Refer Annex A for Equipment set up.
2. The modulation response was measured at three audio frequencies while varying the input level.
3. Measurements were made for both Positive and Negative Deviation.

LIMIT CLAUSE: TIA/EIA-603C 1.3.4.4

MEASUREMENT RESULTS:

Tx FREQUENCY: 219.1 MHz 12.5 kHz Channel Spacing

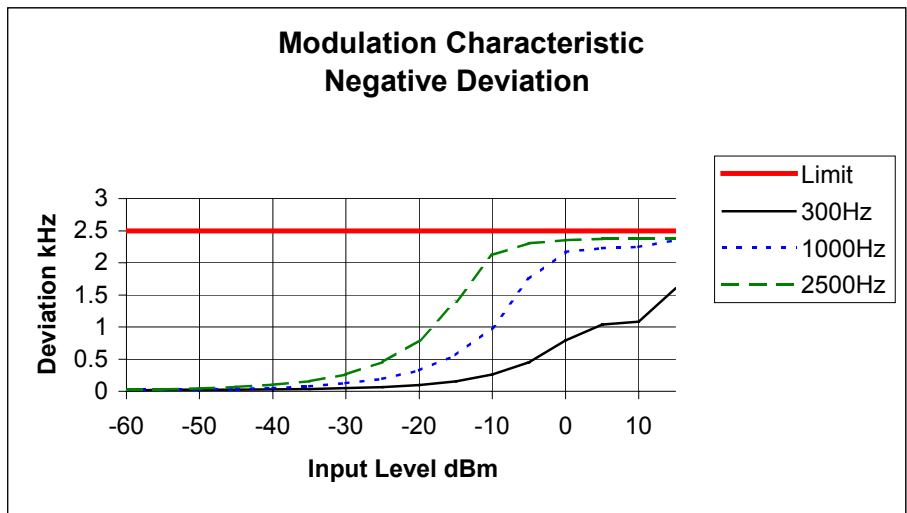
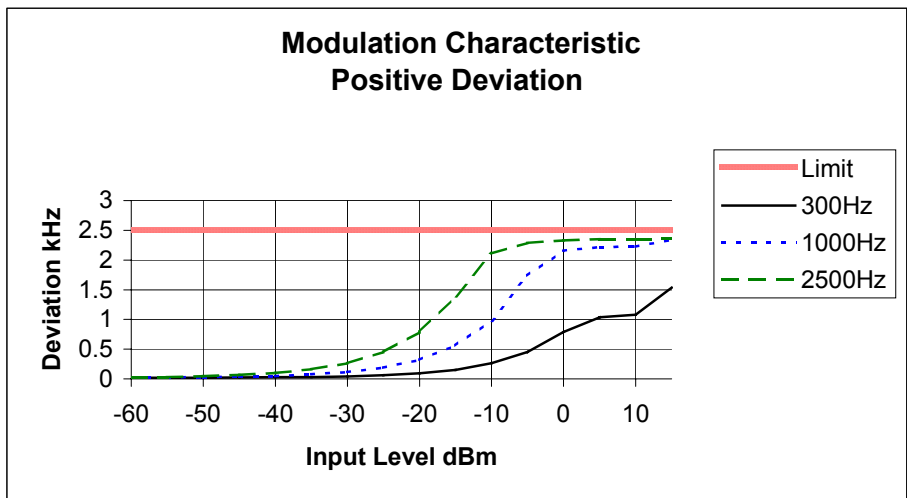

TRANSMITTER MODULATION LIMITING

SPECIFICATION: FCC CFR 2.1047 (b)

Tx FREQUENCY: 219.1 MHz 25.0 kHz Channel Spacing

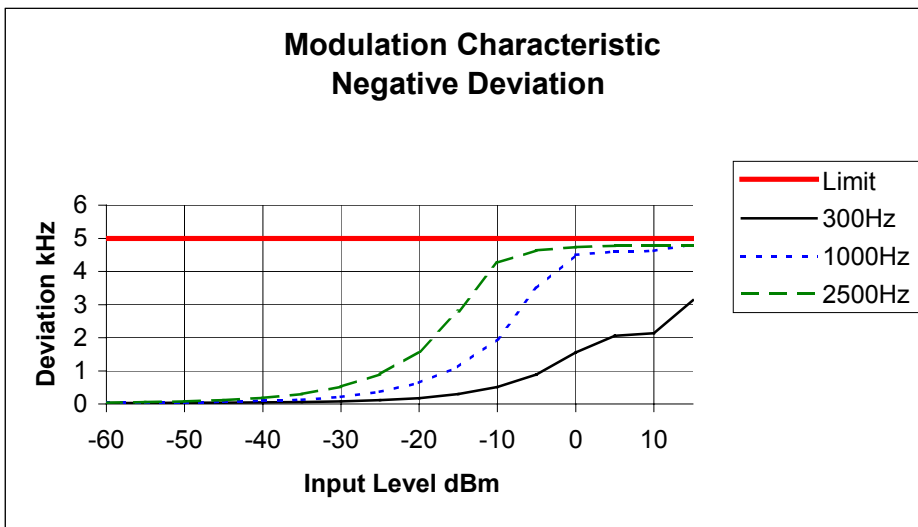
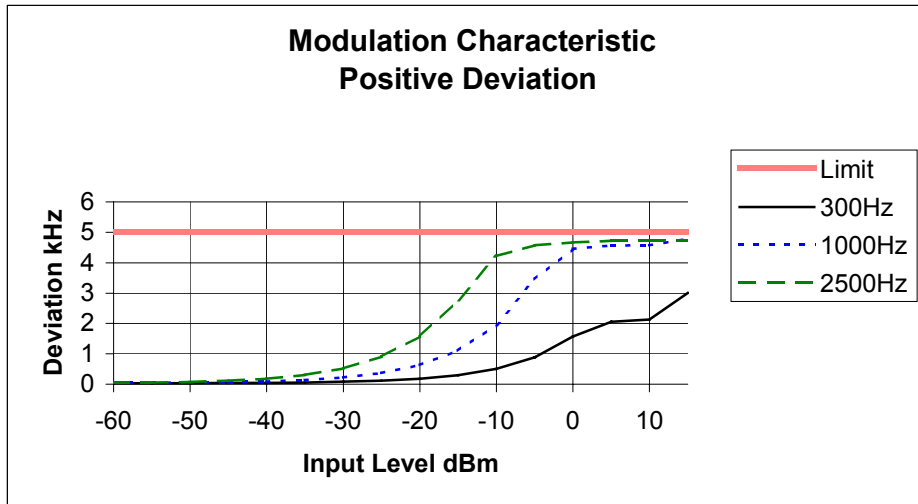

TRANSMITTER MODULATION LIMITING

SPECIFICATION: FCC CFR 2.1047 (b)

Tx FREQUENCY: 221.5 MHz 12.5 kHz Channel Spacing

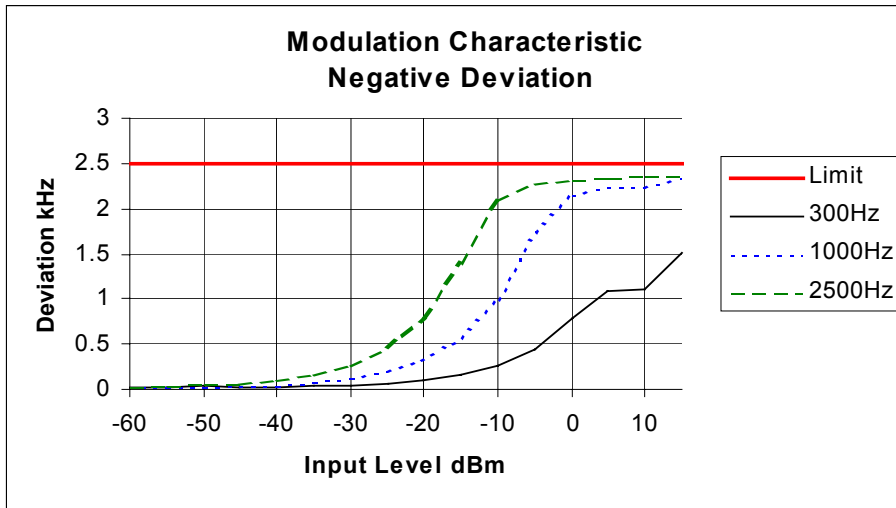
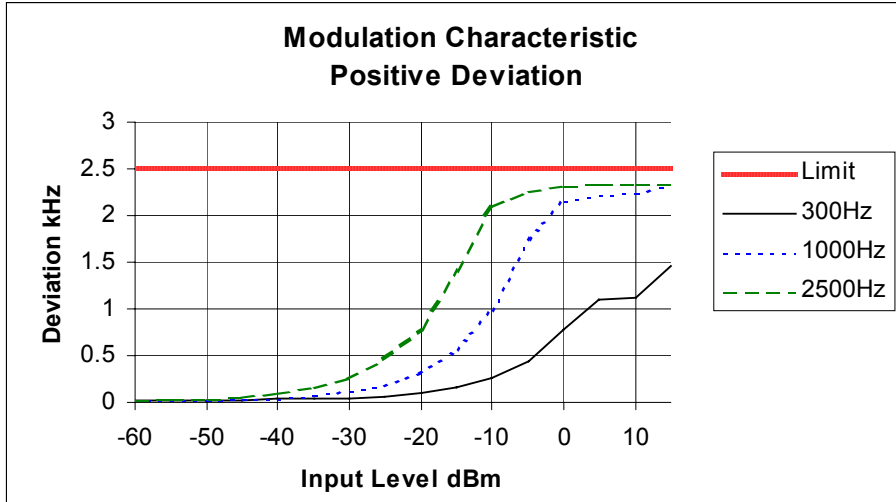

**OCCUPIED BANDWIDTH**

**SPECIFICATION:** FCC 47 CFR 2.1049 (c)  
FCC 47 CFR 80.211  
FCC 47 CFR 90.733 (d), (e)

**GUIDE:** TIA/EIA-603C 2.2.11

**MEASUREMENT PROCEDURE:**

1. Refer Annex A for Equipment Set up.
2. For analogue measurements: The EUT was modulated by a 2500Hz tone at an input level 16dB above a level that produced 50% deviation. The input level was established at the frequency of maximum response of the audio modulating circuit.  
For Data measurements: The EUT was modulated with an externally generated pseudo random bit sequence at the appropriate Baud rates.
3. The Occupied Bandwidth was measured on the Spectrum Analyser, with bandwidth settings as follows.

Emission Mask D – Resolution Bandwidth = 100Hz, Video Bandwidth = 1 kHz  
Emission Mask B, and C – Resolution bandwidth = 300Hz, Video Bandwidth = 3 kHz

**MEASUREMENT RESULTS:**

See the plots on the following pages for 12.5 kHz & 25.0 kHz channel spacings.

**LIMIT CLAUSE:** FCC 47 CFR 80.211 (f)  
FCC 47 CFR 90.210 (f)

216 – 220 MHz		
Emission Mask D	12.5 kHz Channel Spacing	Analogue Voice; FFSK, Digital data
Emission Mask B	25.0 kHz Channel Spacing	Analogue Voice;
Emission Mask C	25.0 kHz Channel Spacing	FFSK; Digital Data
220 – 222 MHz		
Emission Mask F x 5 (5 contiguous channels)	12.5 kHz Channel Spacing	Analogue Voice; FFSK, Digital data

**DATA SPEED**

FFSK	1200 bps	12.5 kHz Channel Spacing
FFSK	1200 bps	25.0 kHz Channel Spacing
Digital Data	9600 bps	12.5 kHz Channel Spacing
Digital Data	9600 bps	25.0 kHz Channel Spacing

OCCUPIED BANDWIDTH

ANALOGUE VOICE

SPECIFICATION: FCC CFR 2.1049 (c)

Tx FREQUENCY: 219.1 MHz 100 W 12.5 kHz Channel Spacing

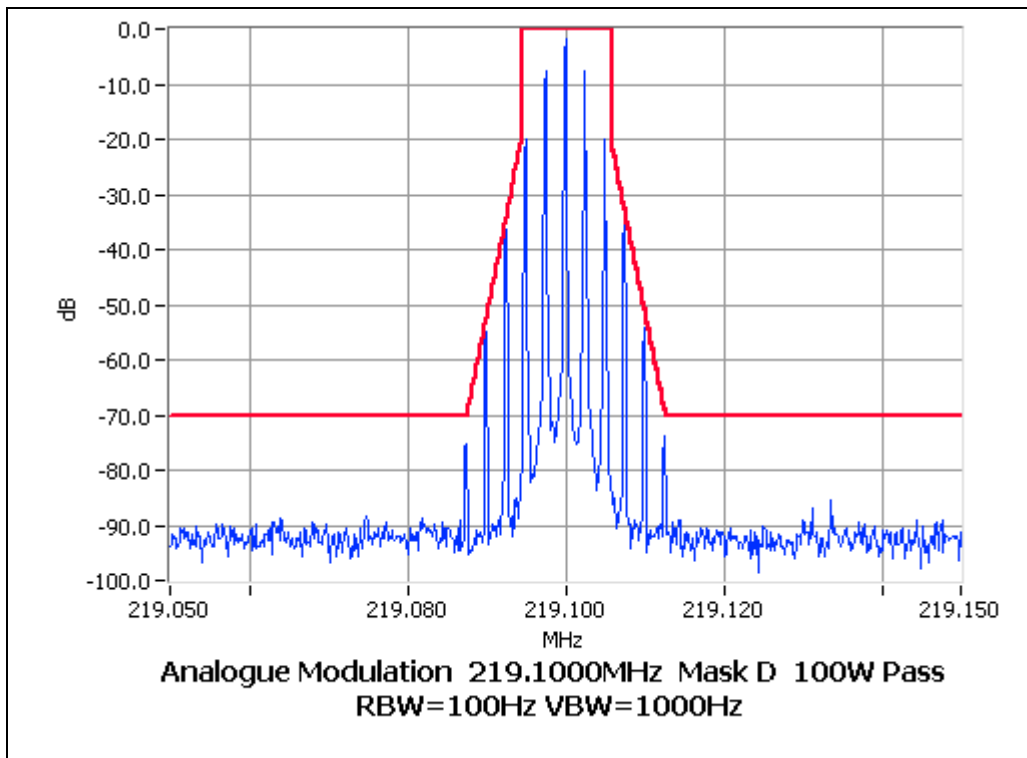
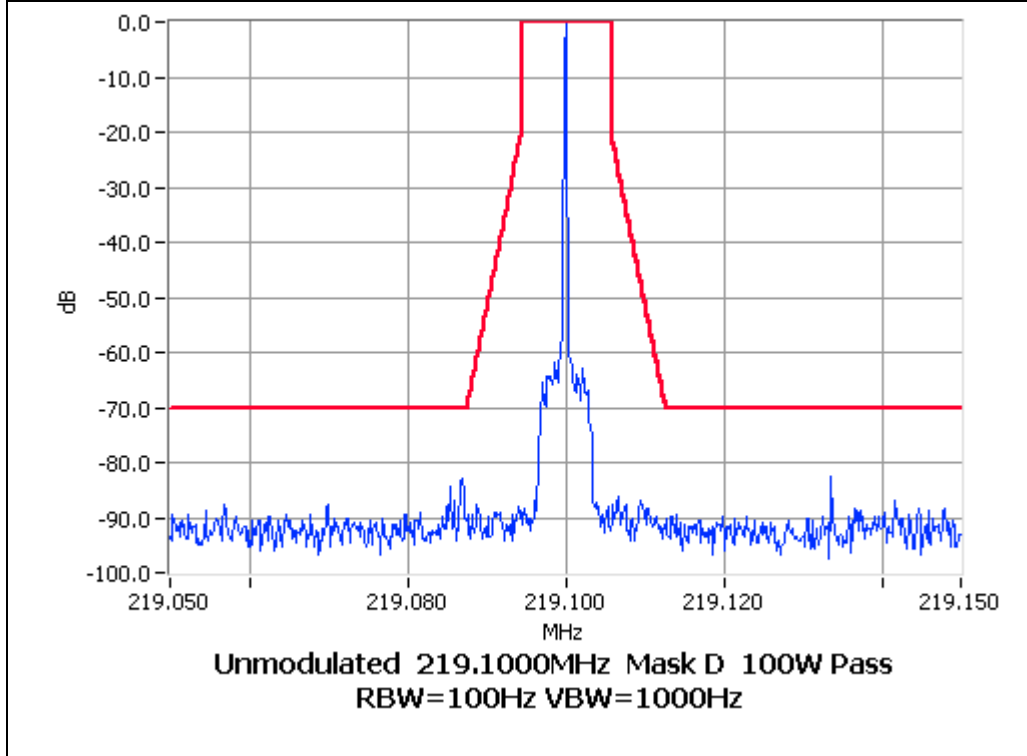

OCCUPIED BANDWIDTH

ANALOGUE VOICE

SPECIFICATION: FCC CFR 2.1049 (c)

Tx FREQUENCY: 219.1 MHz 10W 12.5 kHz Channel Spacing

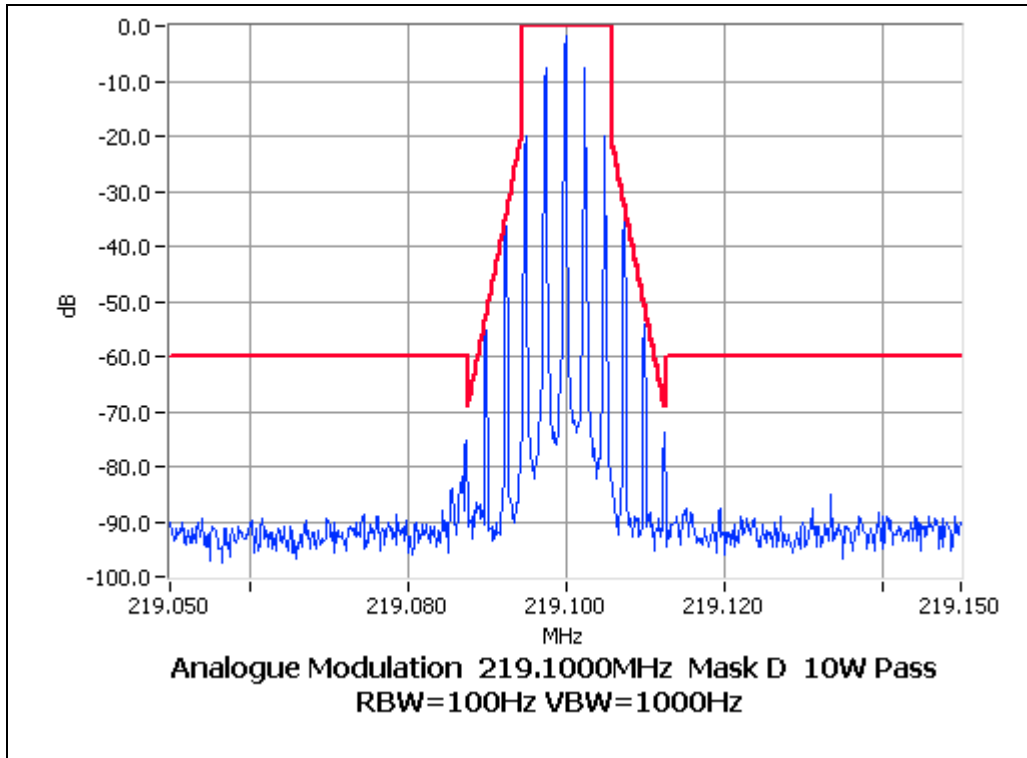
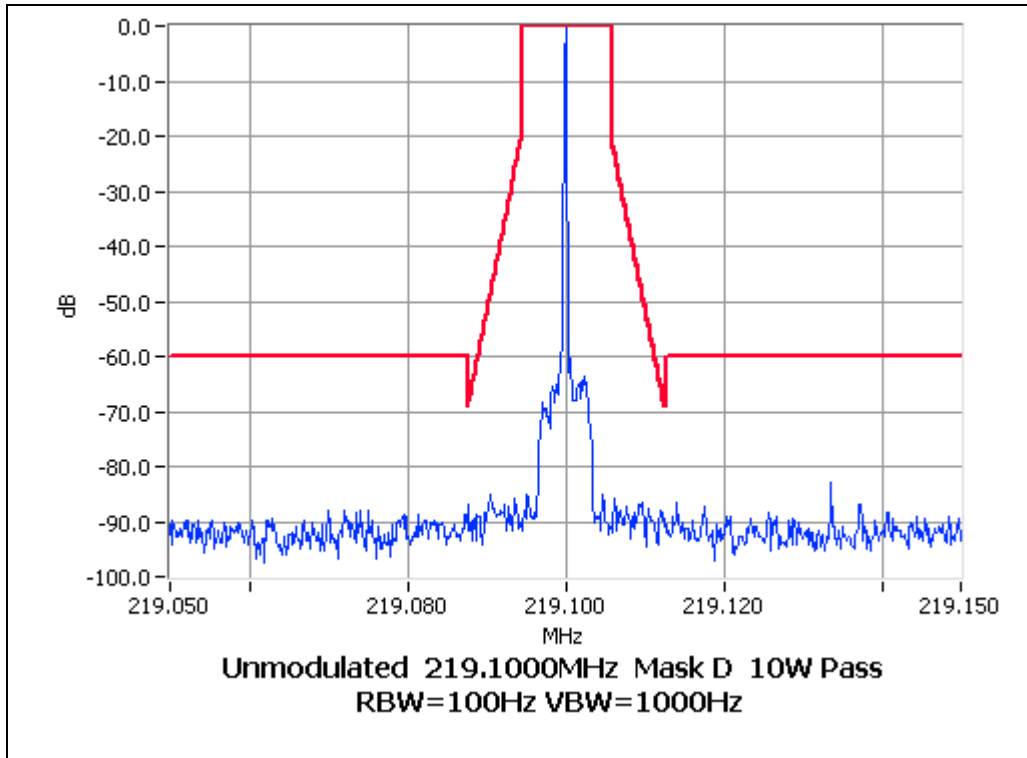

OCCUPIED BANDWIDTH

ANALOGUE VOICE

SPECIFICATION: FCC CFR 2.1049 (c)

Tx FREQUENCY: 219.1 MHz 100 W 25.0 kHz Channel Spacing

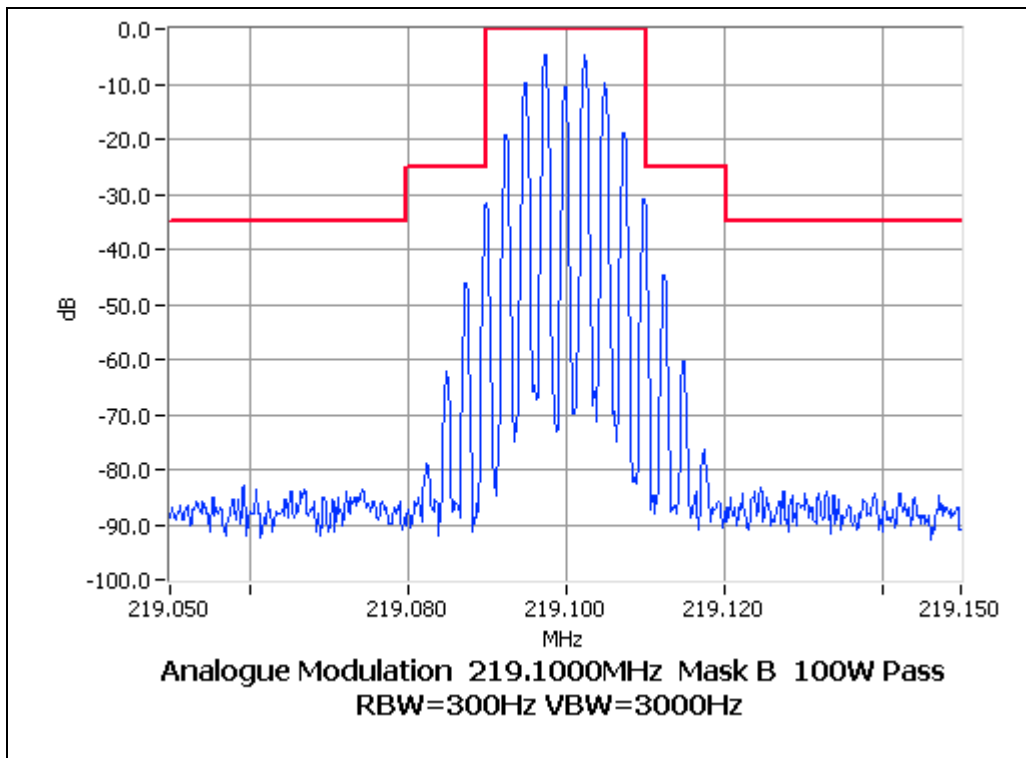
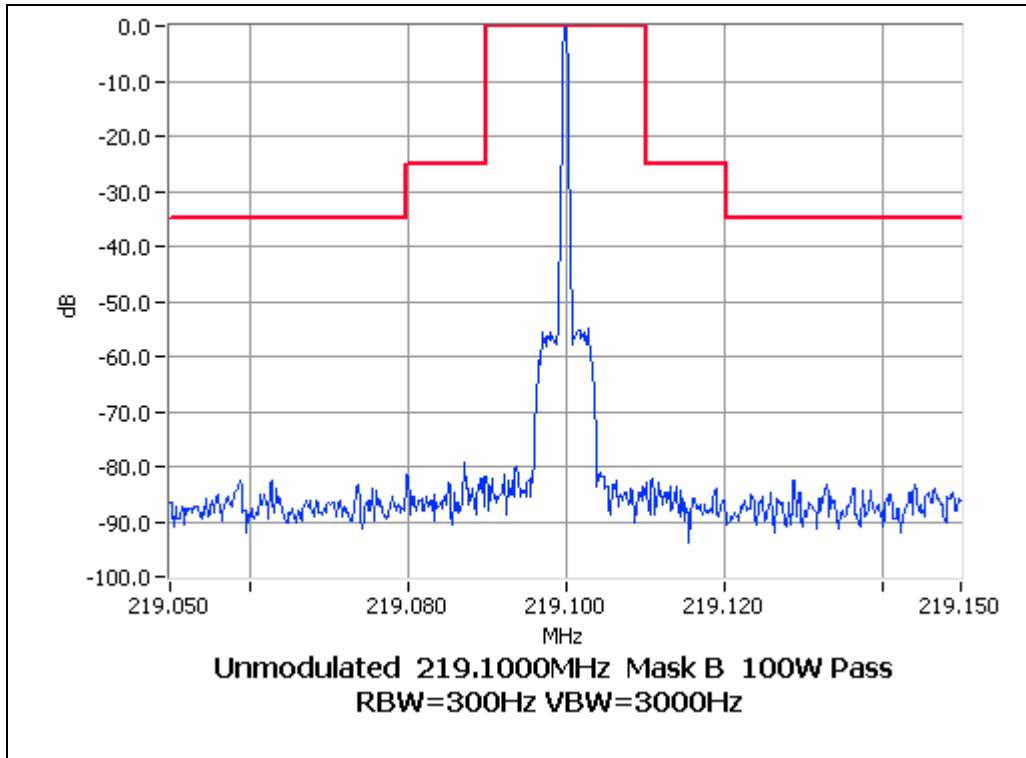



OCCUPIED BANDWIDTH

ANALOGUE VOICE

SPECIFICATION: FCC CFR 2.1049 (c)

Tx FREQUENCY: 219.1 MHz 10W 25.0 kHz Channel Spacing

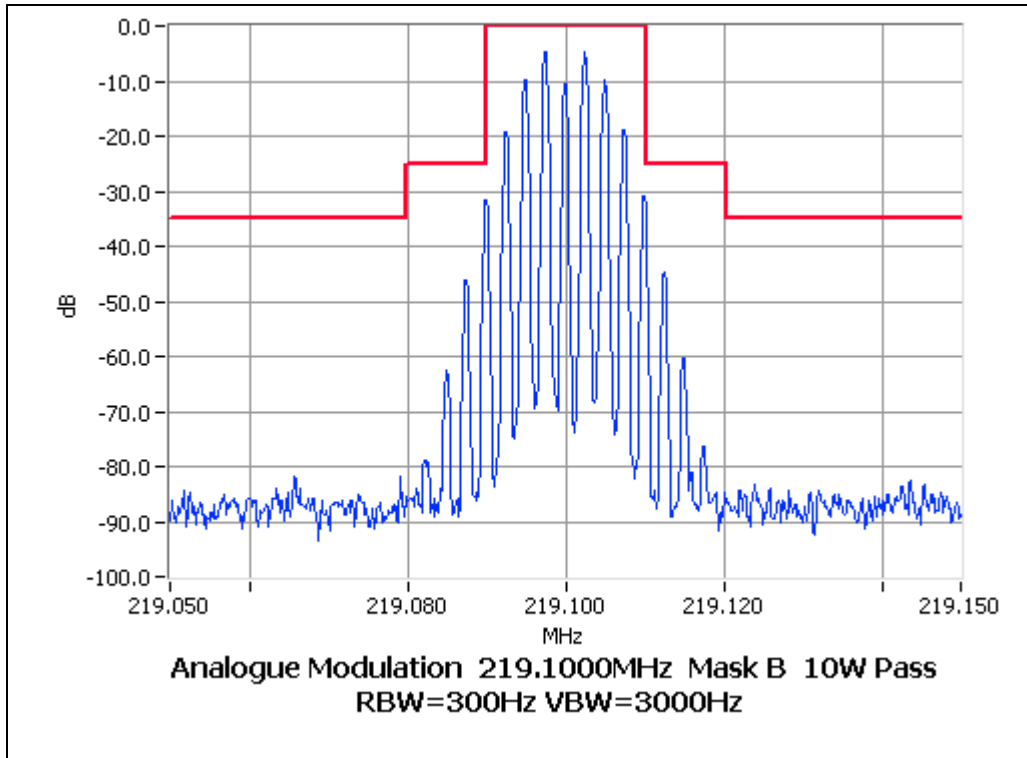
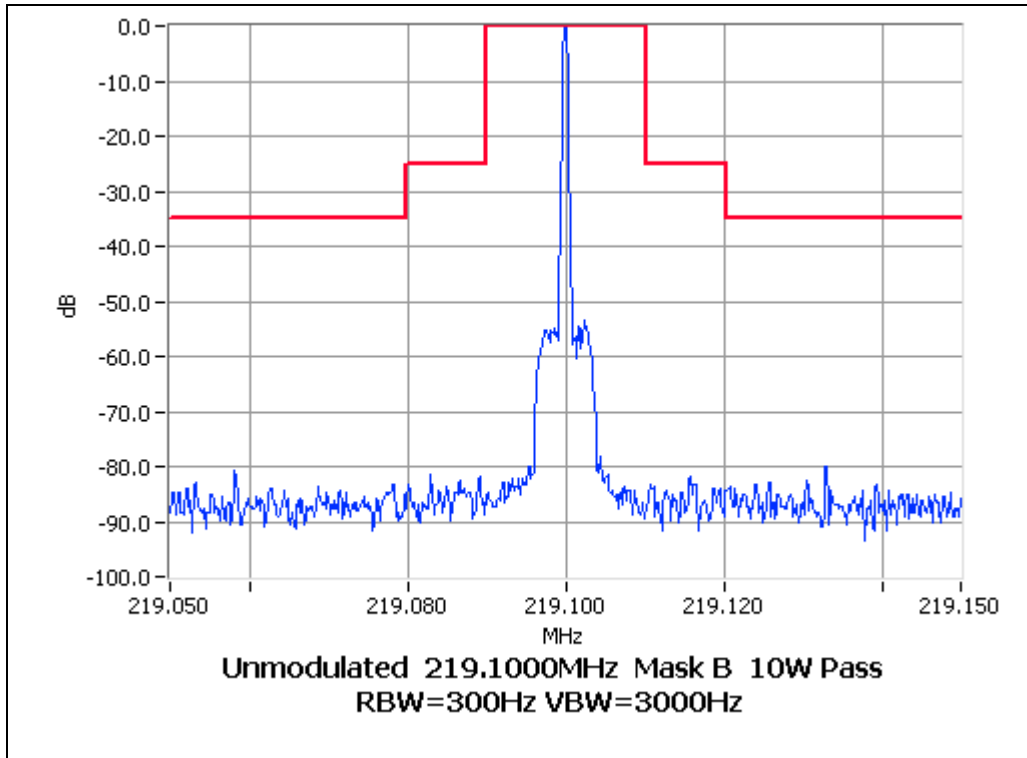

OCCUPIED BANDWIDTH

ANALOGUE VOICE

SPECIFICATION: FCC CFR 2.1049 (c)

Tx FREQUENCY: 221.5 MHz 100 W 12.5 kHz Channel Spacing

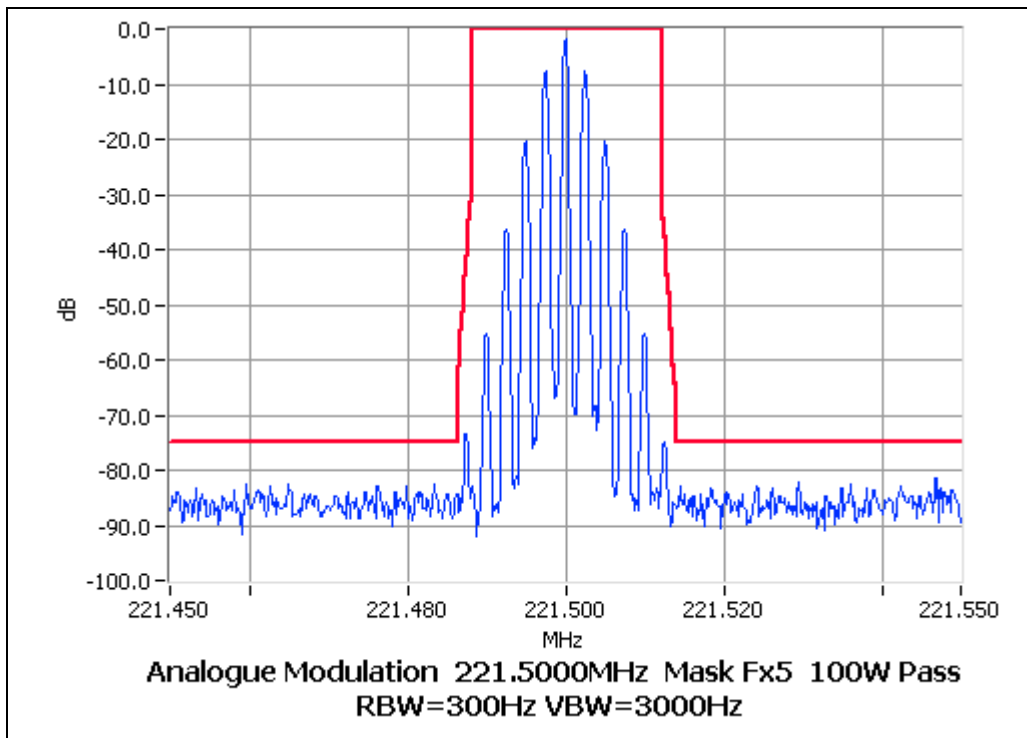
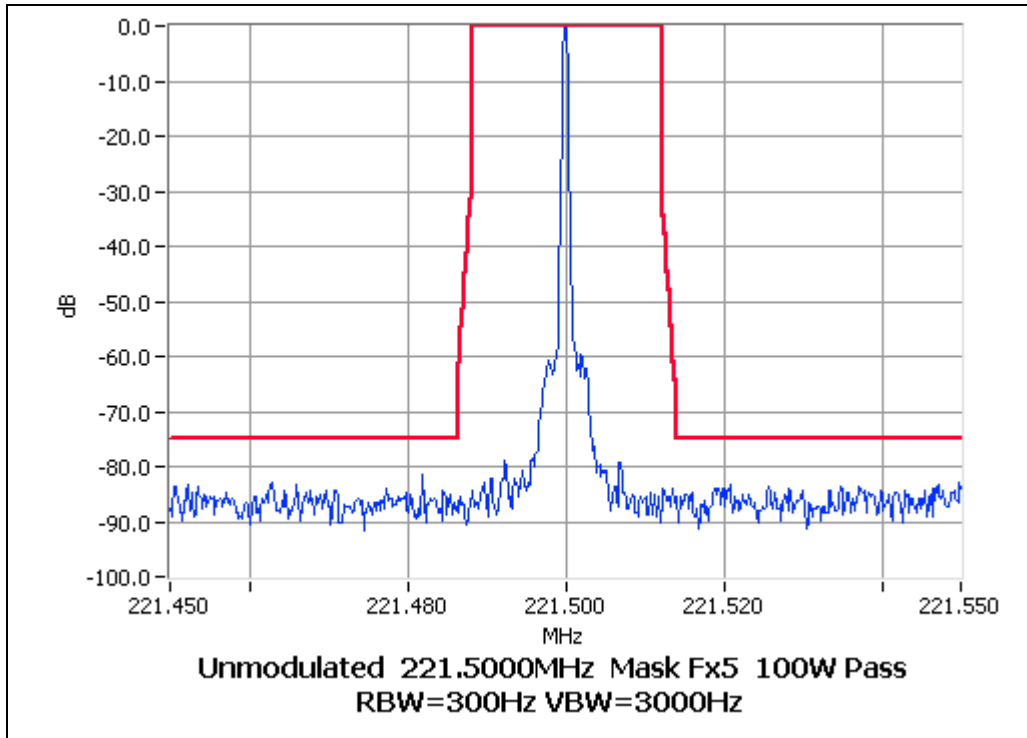

OCCUPIED BANDWIDTH

ANALOGUE VOICE

SPECIFICATION: FCC CFR 2.1049 (c)

Tx FREQUENCY: 221.5 MHz 10W 12.5 kHz Channel Spacing

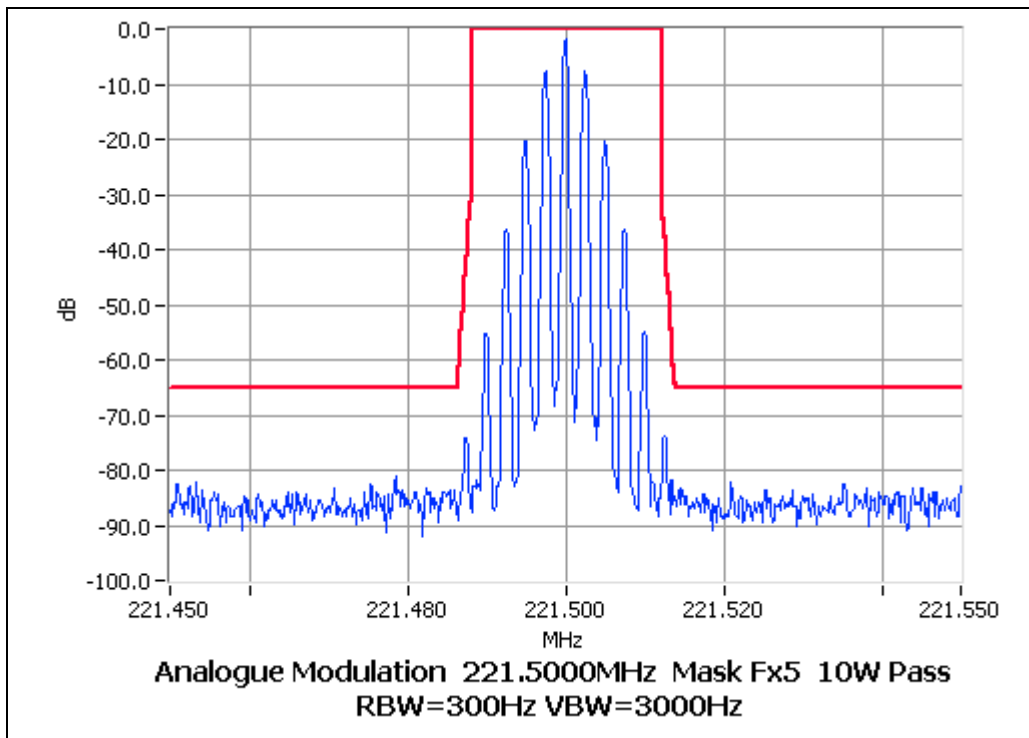
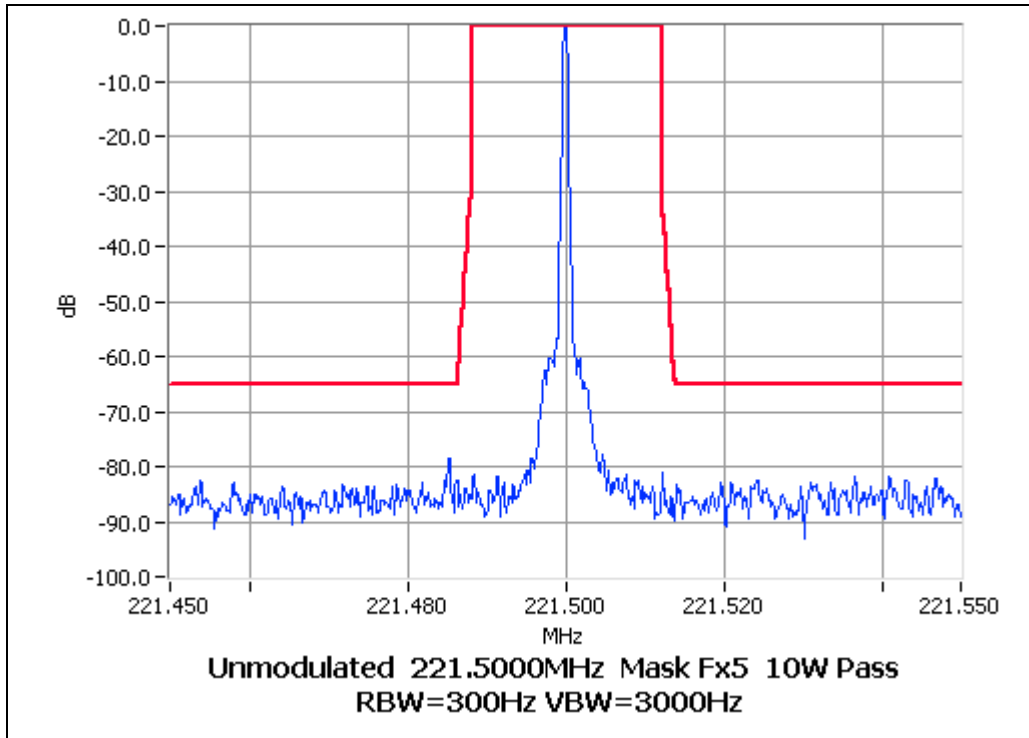

OCCUPIED BANDWIDTH

FFSK

SPECIFICATION: FCC CFR 2.1049 (c)

Tx FREQUENCY: 219.1 MHz 100W 12.5 kHz Channel Spacing

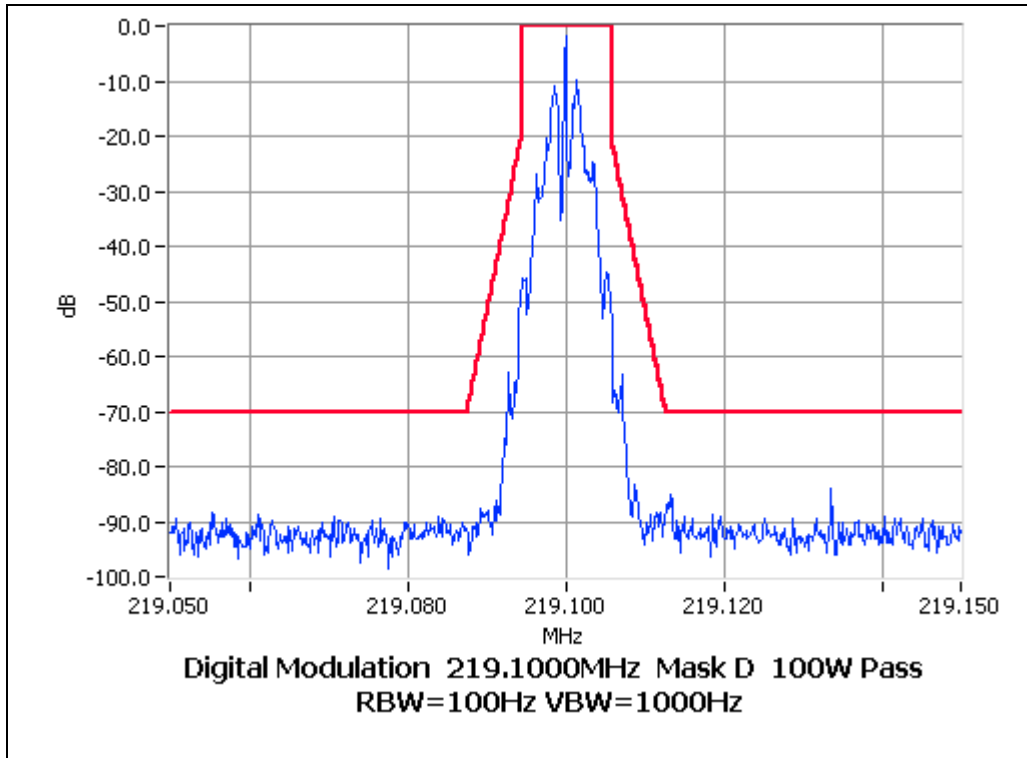
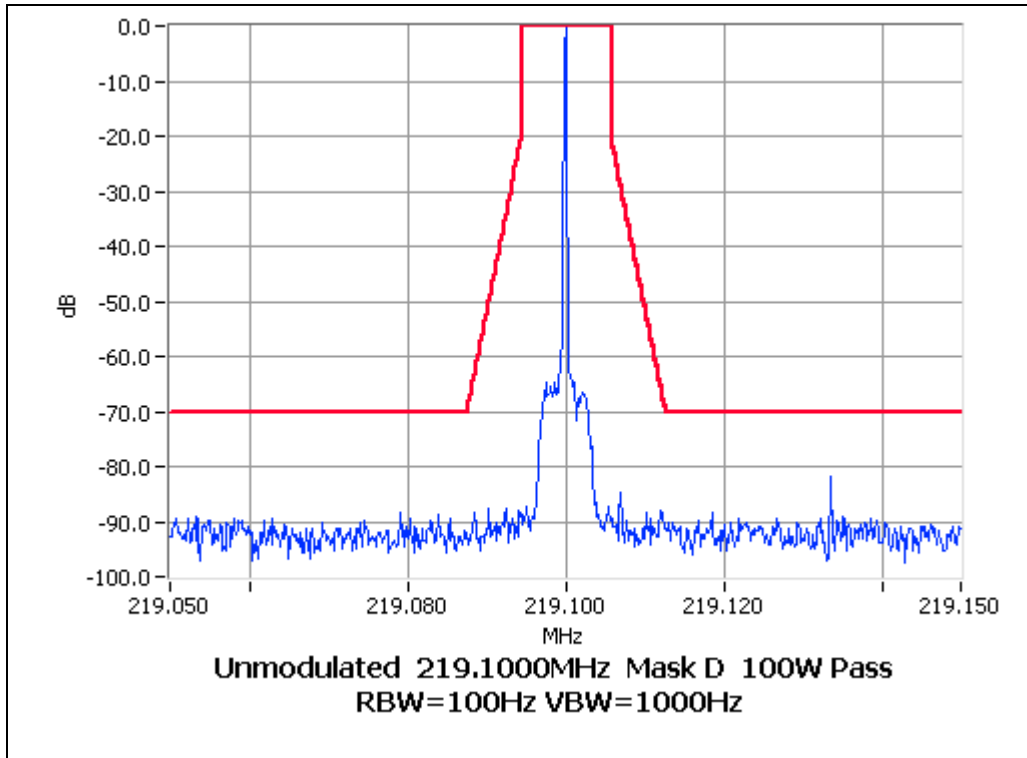

OCCUPIED BANDWIDTH

FFSK

SPECIFICATION: FCC CFR 2.1049 (c)

Tx FREQUENCY: 219.1 MHz 10W 12.5 kHz Channel Spacing

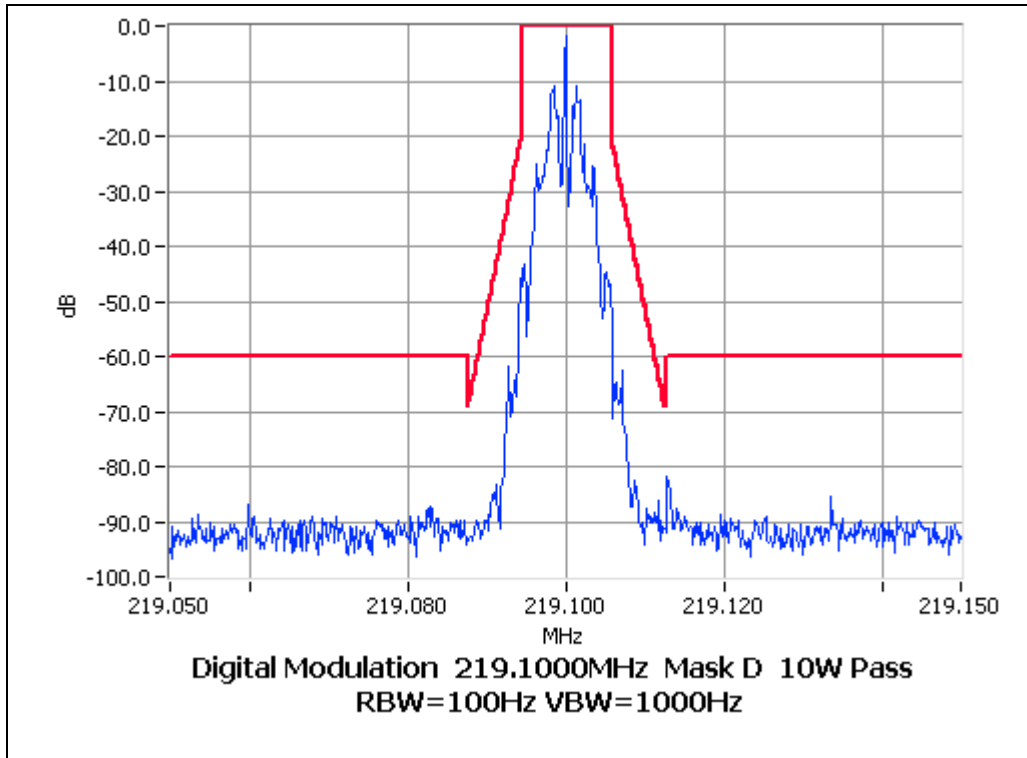
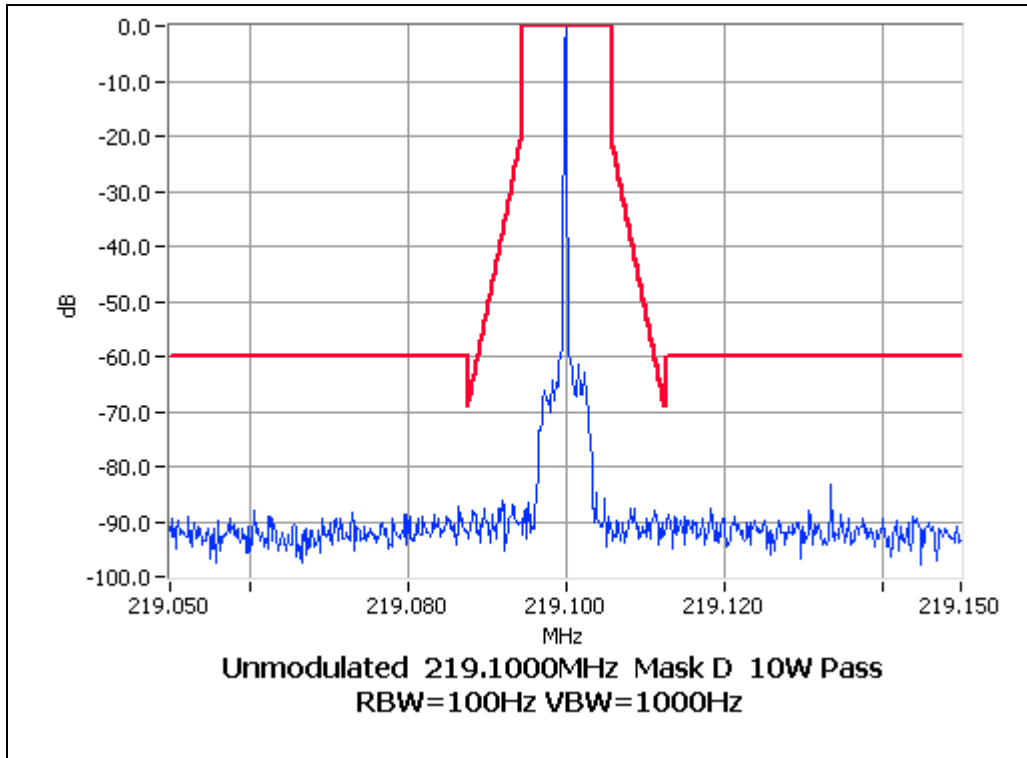

OCCUPIED BANDWIDTH

FFSK

SPECIFICATION: FCC CFR 2.1049 (c)

Tx FREQUENCY: 219.1 MHz 100W 25.0 kHz Channel Spacing

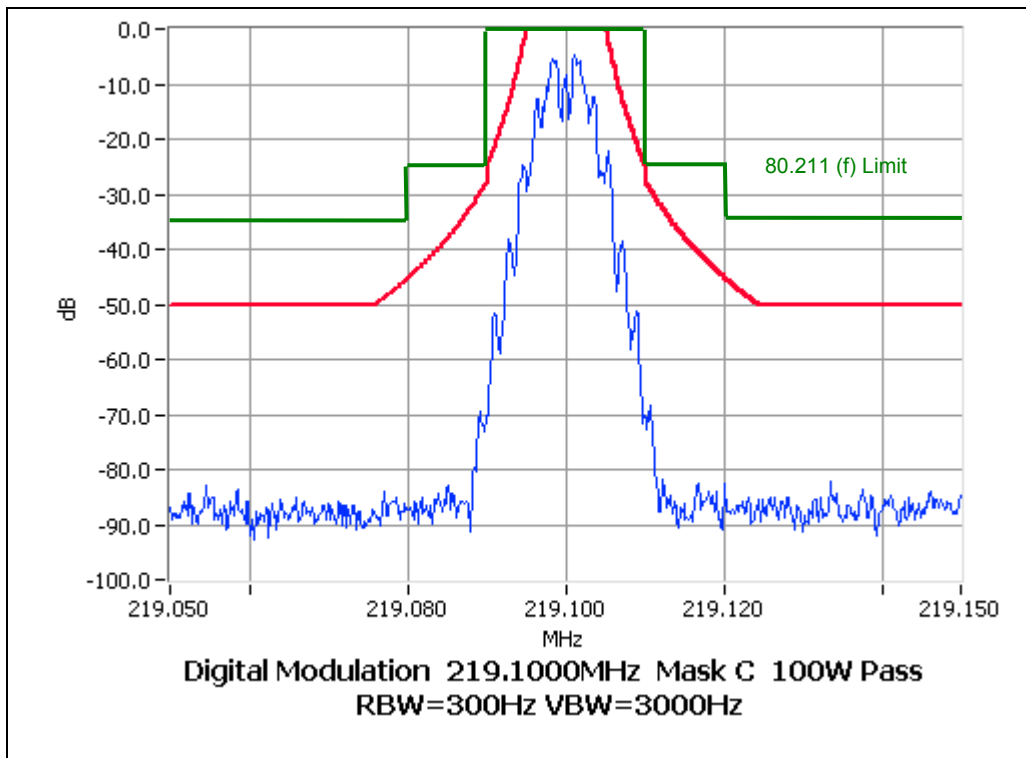
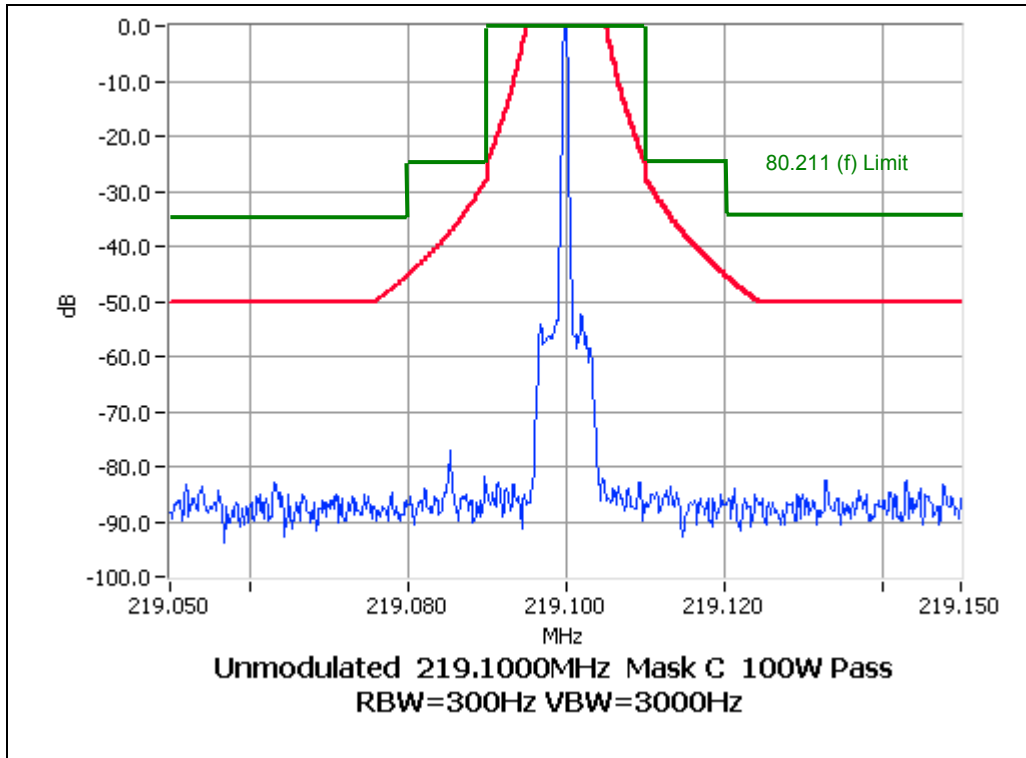

OCCUPIED BANDWIDTH

FFSK

SPECIFICATION: FCC CFR 2.1049 (c)

Tx FREQUENCY: 219.1 MHz 10W 25.0 kHz Channel Spacing

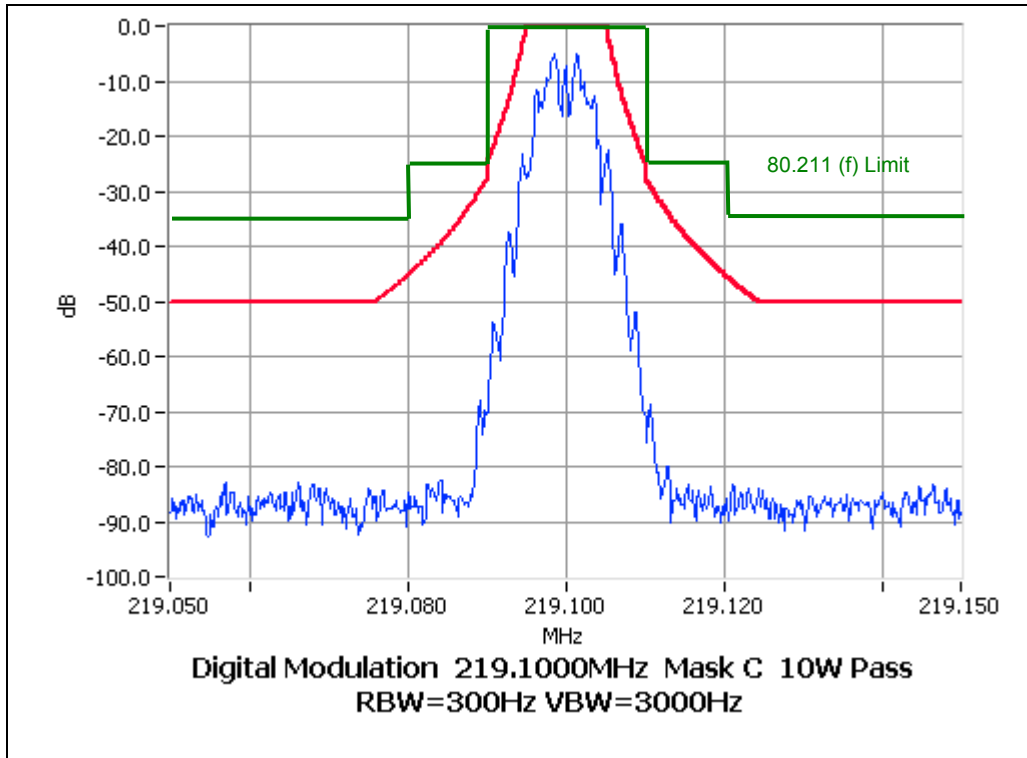
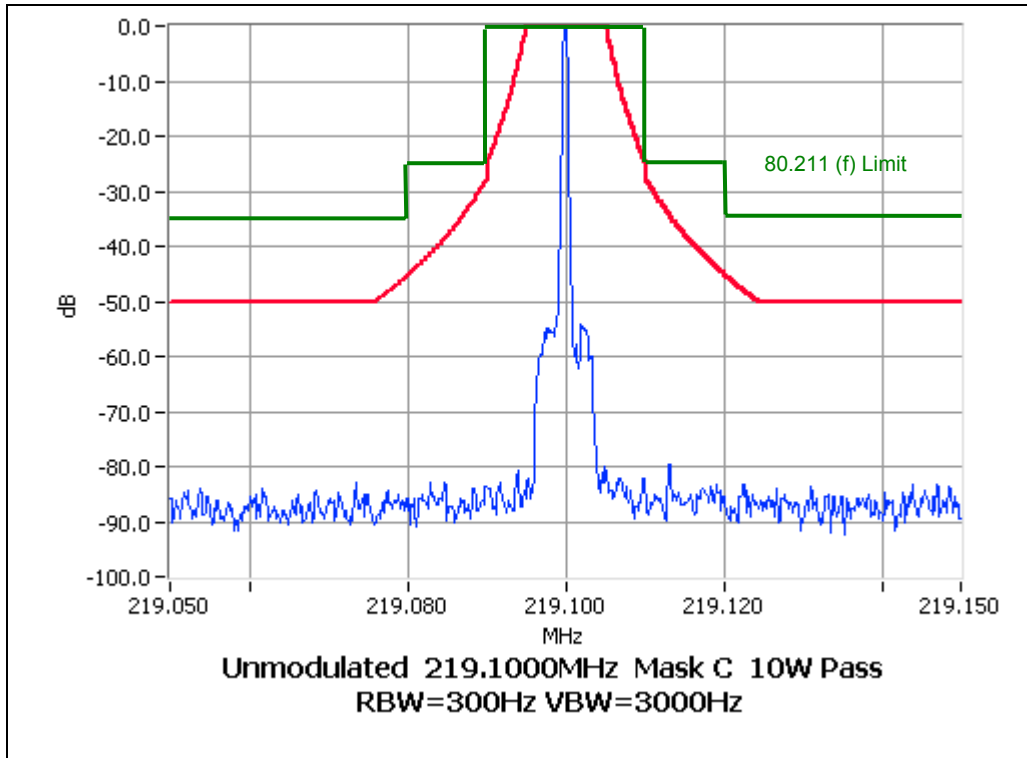

OCCUPIED BANDWIDTH

FFSK

SPECIFICATION: FCC CFR 2.1049 (c)

Tx FREQUENCY: 221.5 MHz 100W 12.5 kHz Channel Spacing

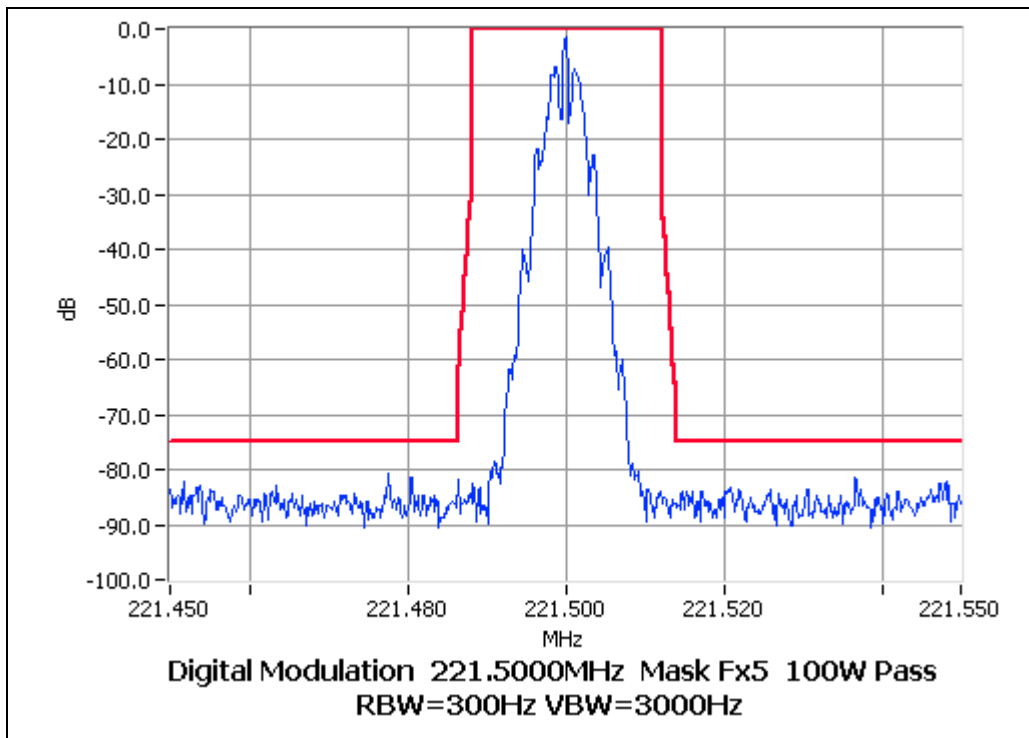
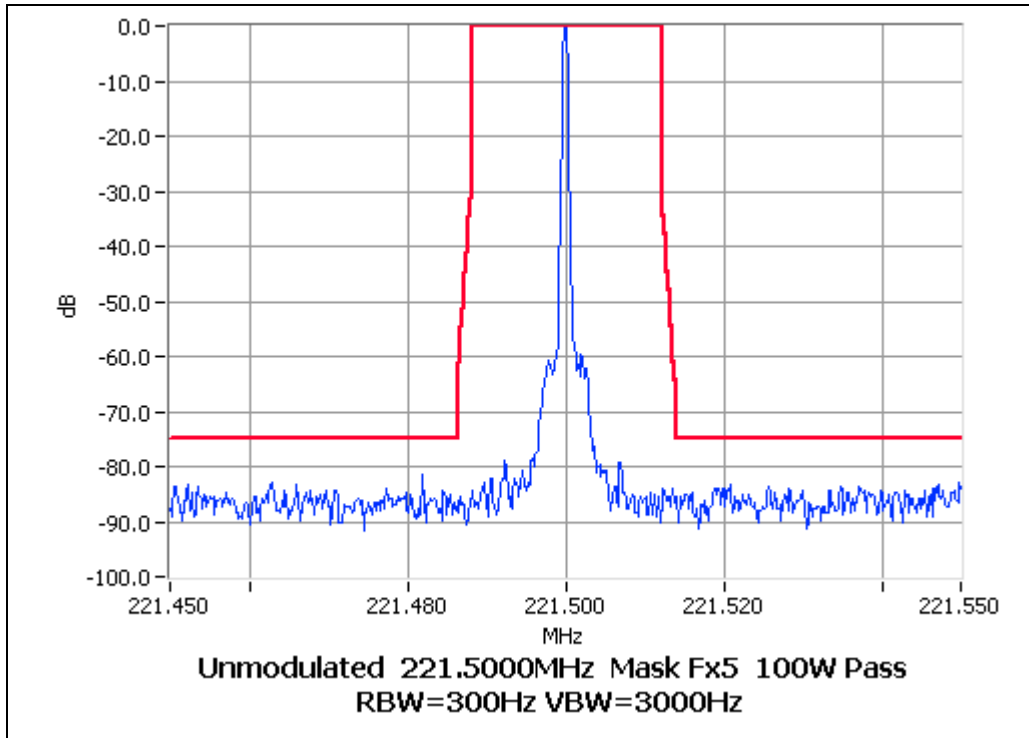



OCCUPIED BANDWIDTH

FFSK

SPECIFICATION: FCC CFR 2.1049 (c)

Tx FREQUENCY: 221.5 MHz 10W 12.5 kHz Channel Spacing

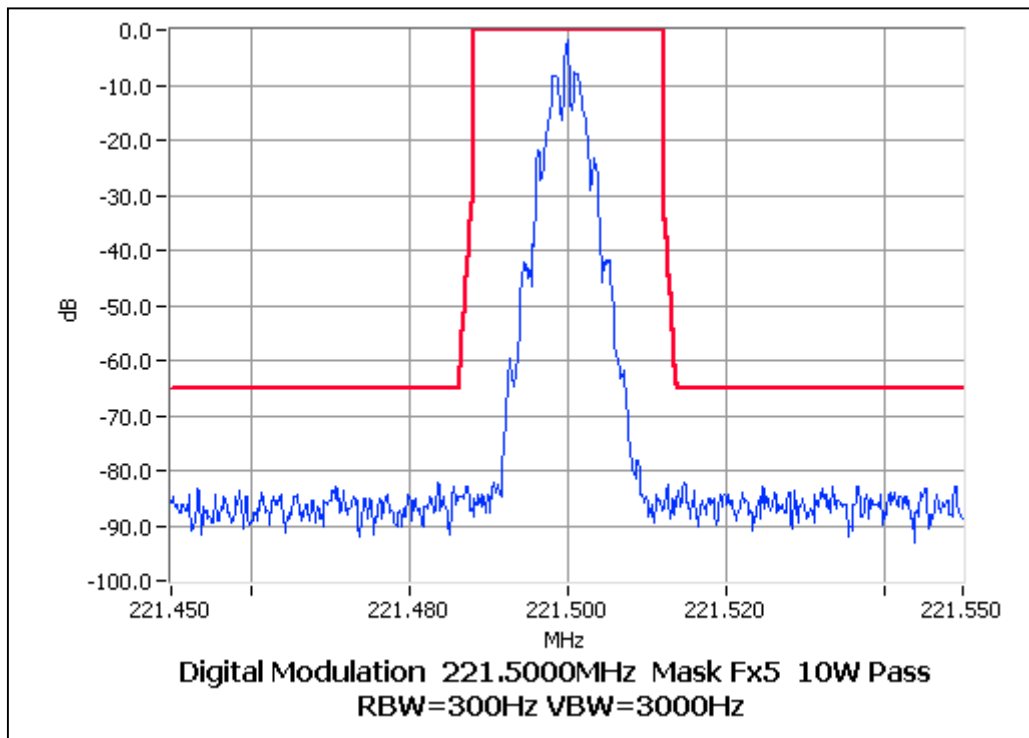
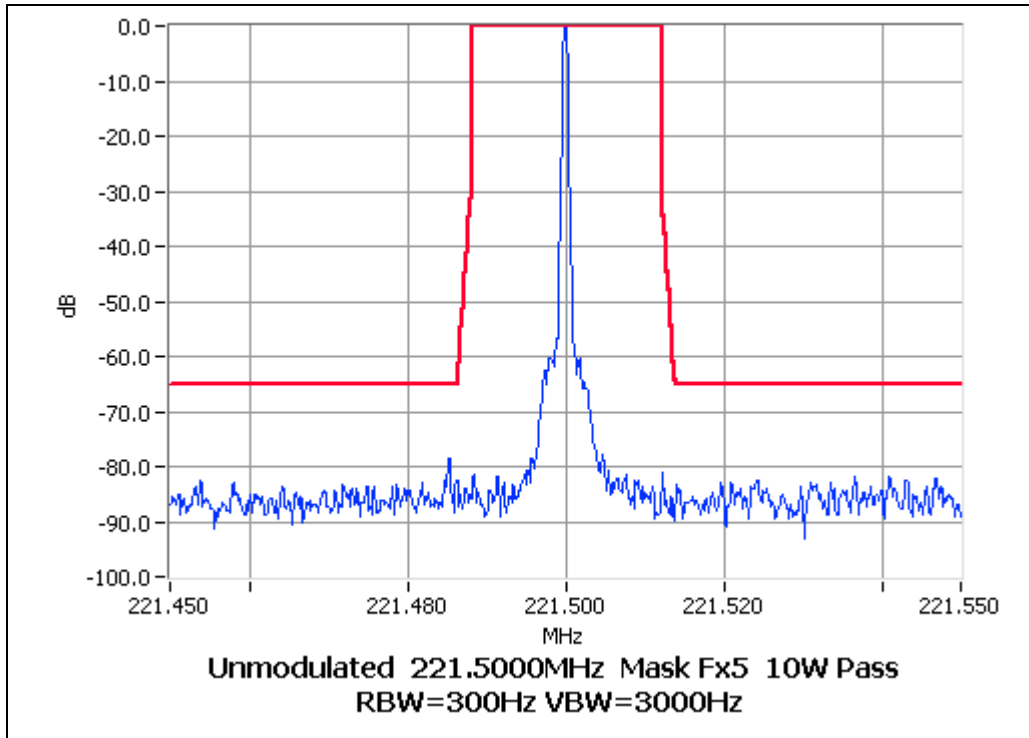

OCCUPIED BANDWIDTH

DIGITAL DATA

SPECIFICATION: FCC CFR 2.1049 (c)

Tx FREQUENCY: 219.1 MHz 100W 12.5 kHz Channel Spacing

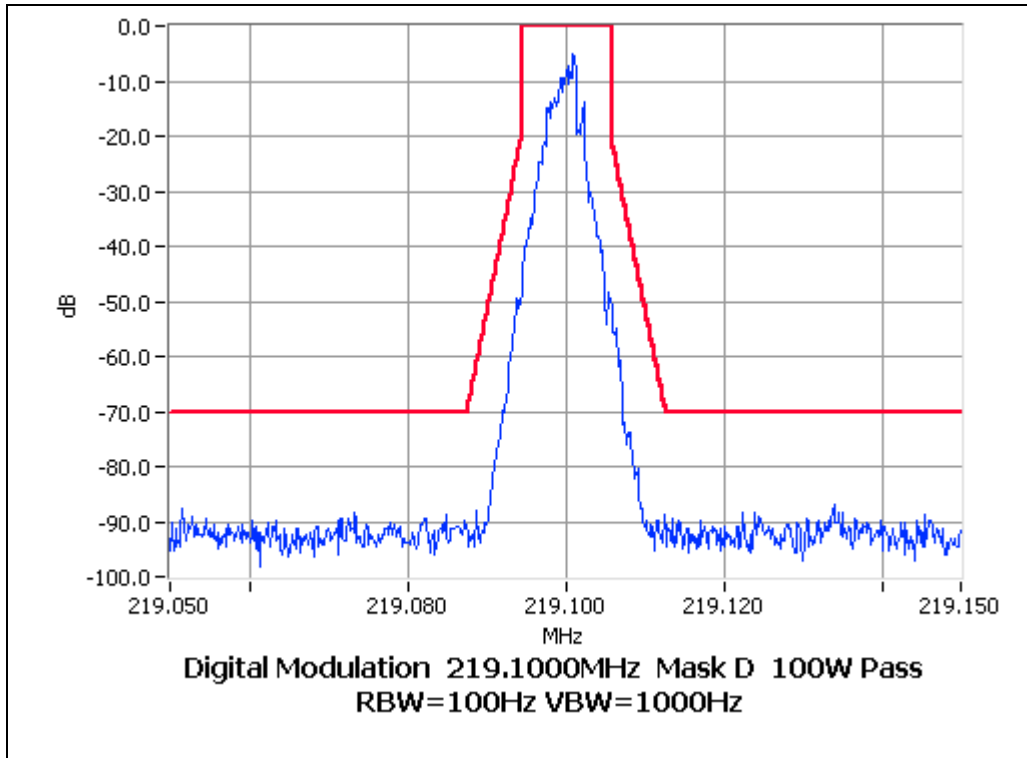
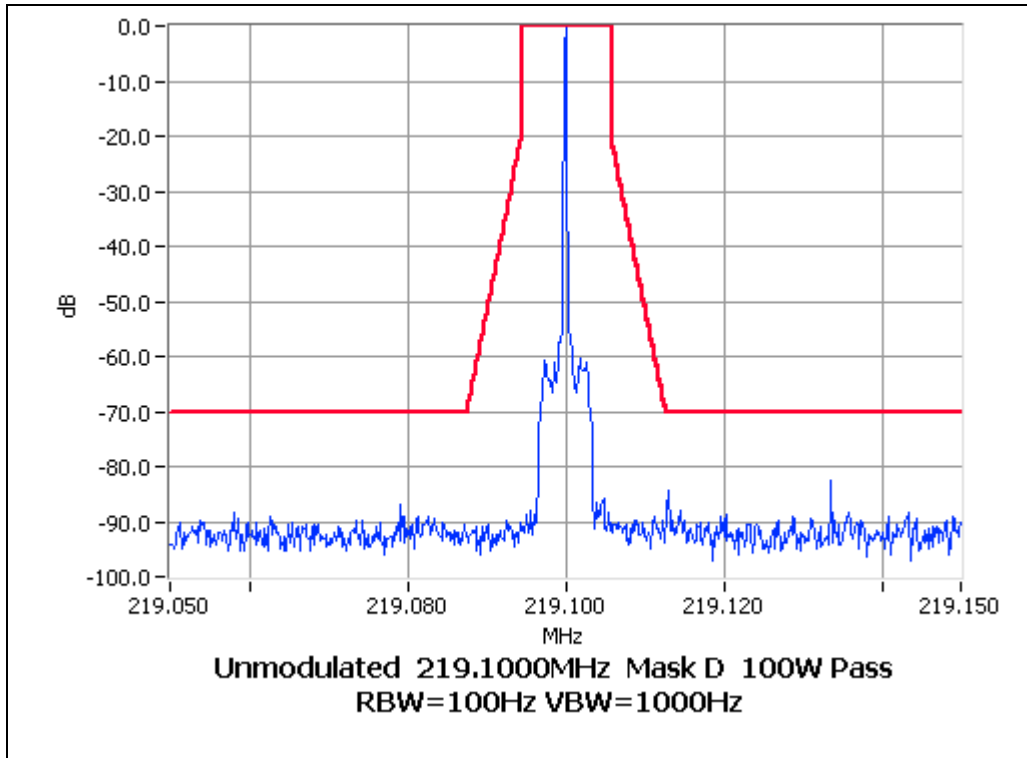

OCCUPIED BANDWIDTH

DIGITAL DATA

SPECIFICATION: FCC CFR 2.1049 (c)

Tx FREQUENCY: 219.1 MHz 10W 12.5 kHz Channel Spacing

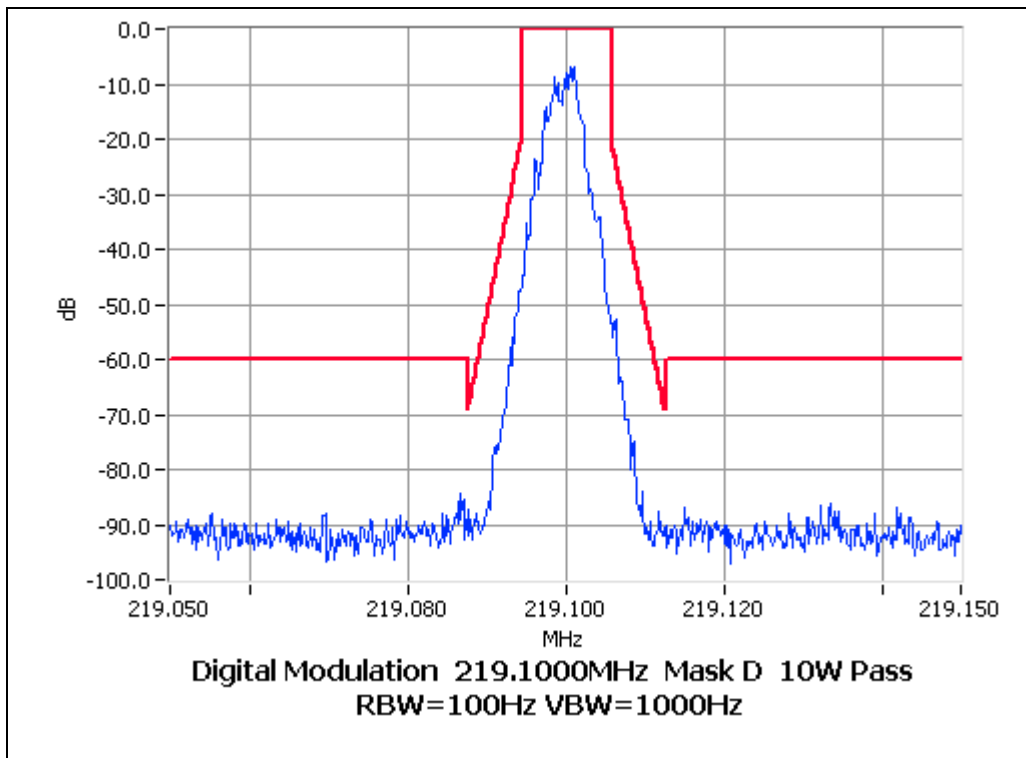
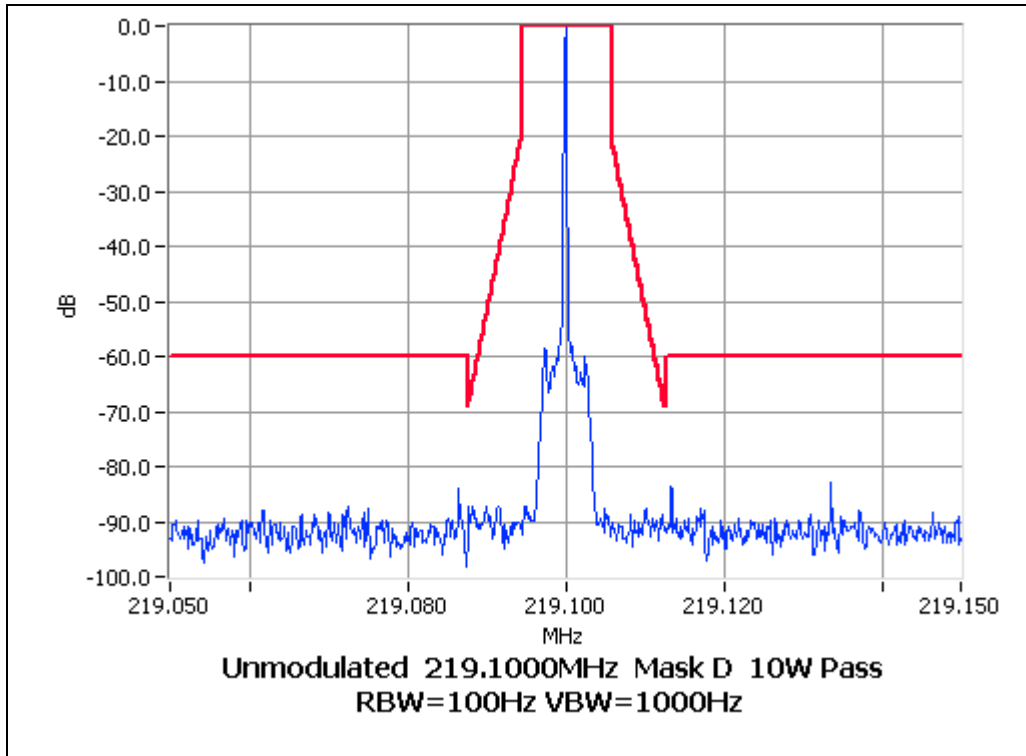

OCCUPIED BANDWIDTH

DIGITAL DATA

SPECIFICATION: FCC CFR 2.1049 (c)

Tx FREQUENCY: 219.1 MHz 100W 25.0 kHz Channel Spacing

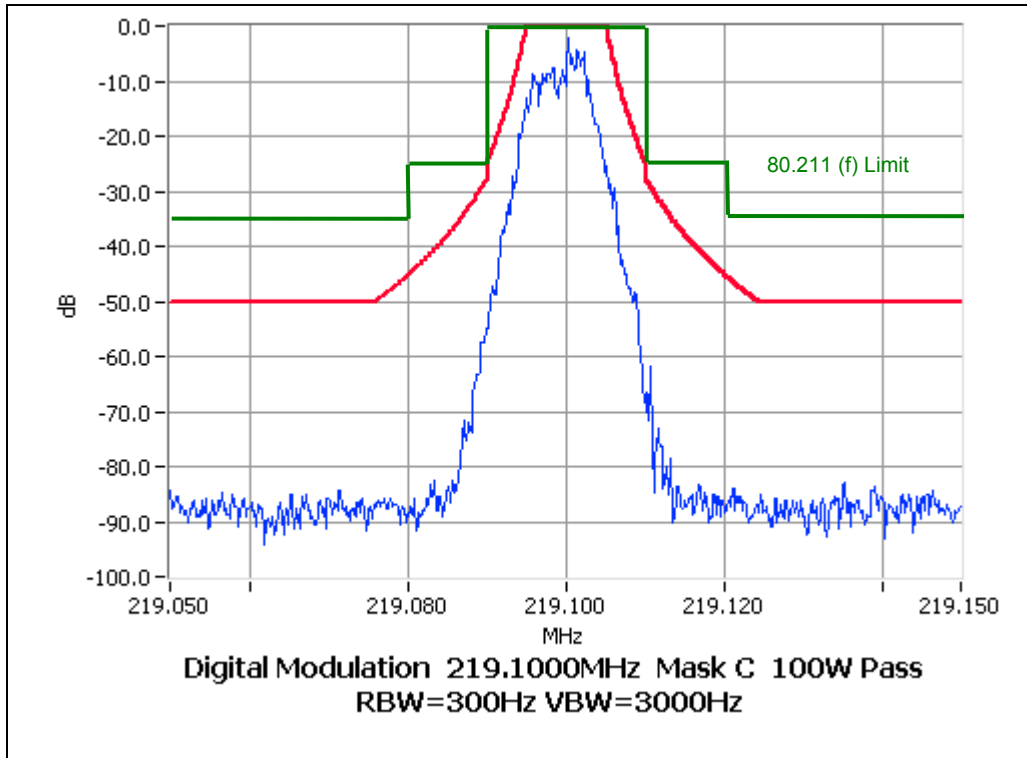
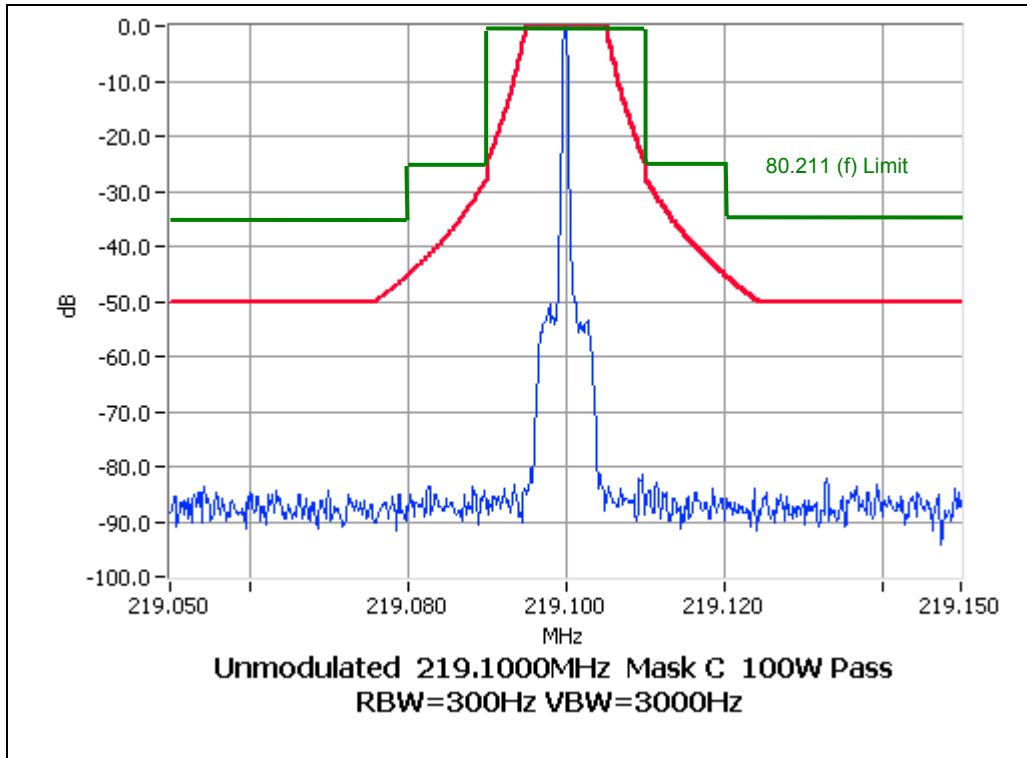

OCCUPIED BANDWIDTH

DIGITAL DATA

SPECIFICATION: FCC CFR 2.1049 (c)

Tx FREQUENCY: 219.1 MHz 10W 25.0 kHz Channel Spacing

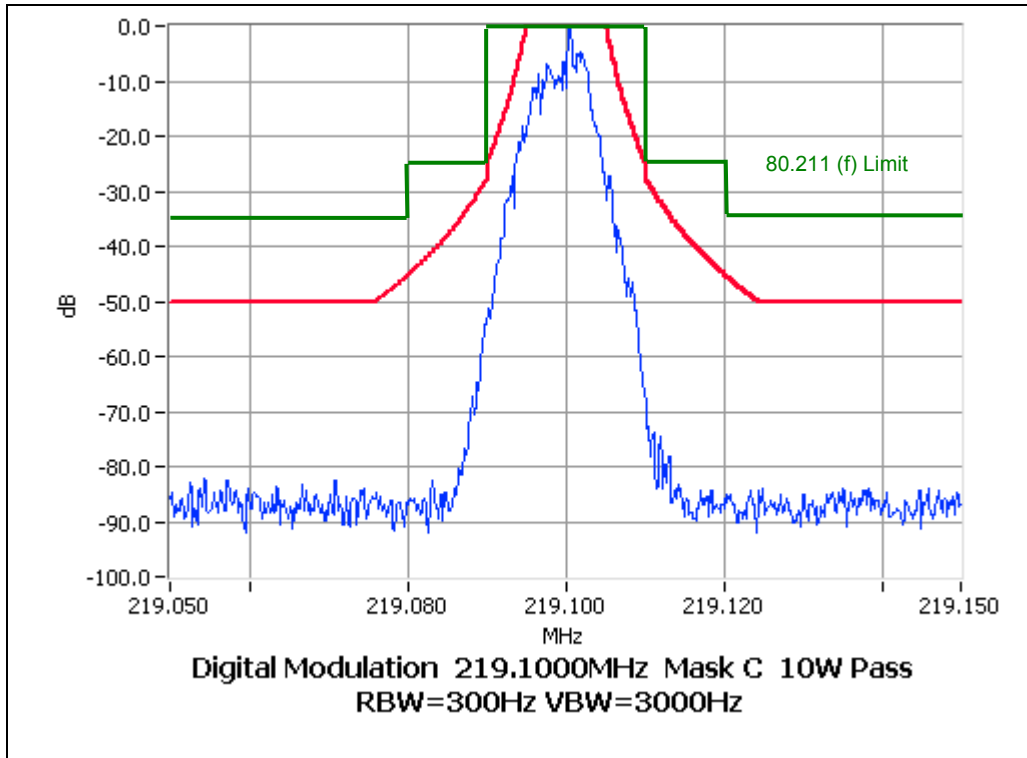
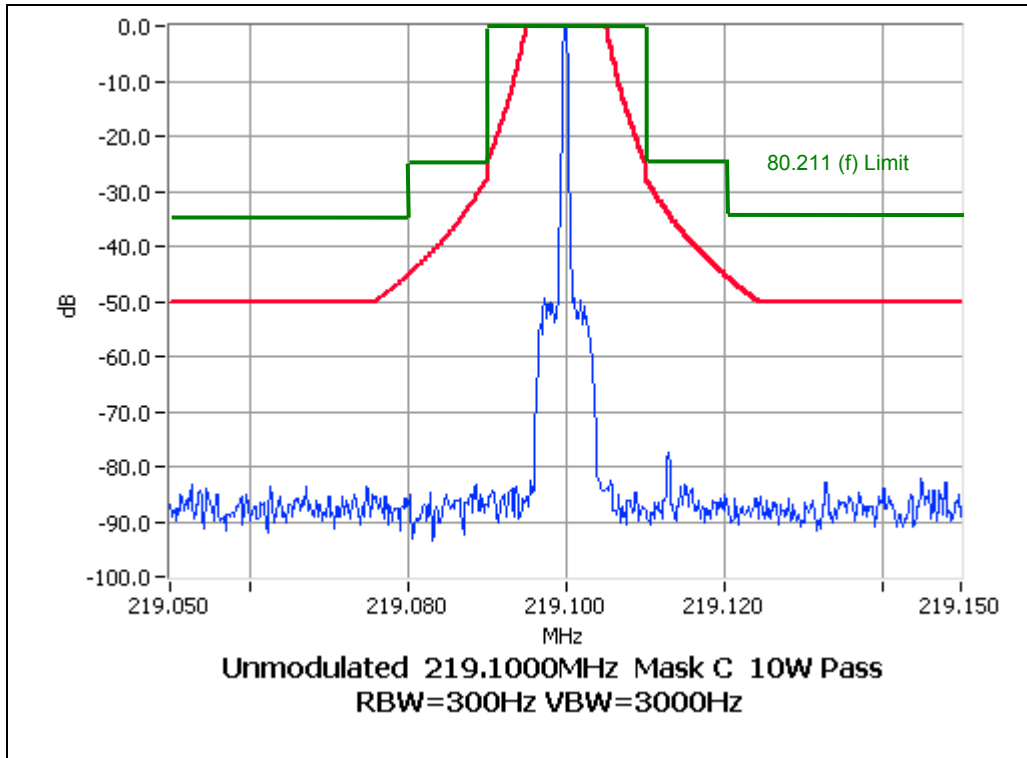

OCCUPIED BANDWIDTH

DIGITAL DATA

SPECIFICATION: FCC CFR 2.1049 (c)

Tx FREQUENCY: 221.5 MHz 100W 12.5 kHz Channel Spacing

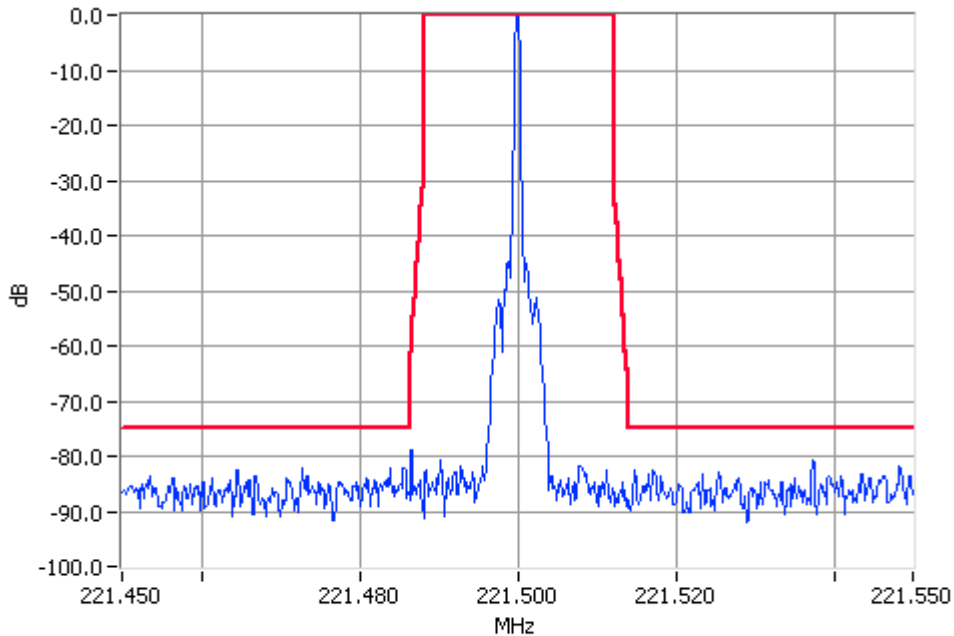

Unmodulated 221.5000MHz Mask Fx5 100W Pass  
RBW=300Hz VBW=3000Hz

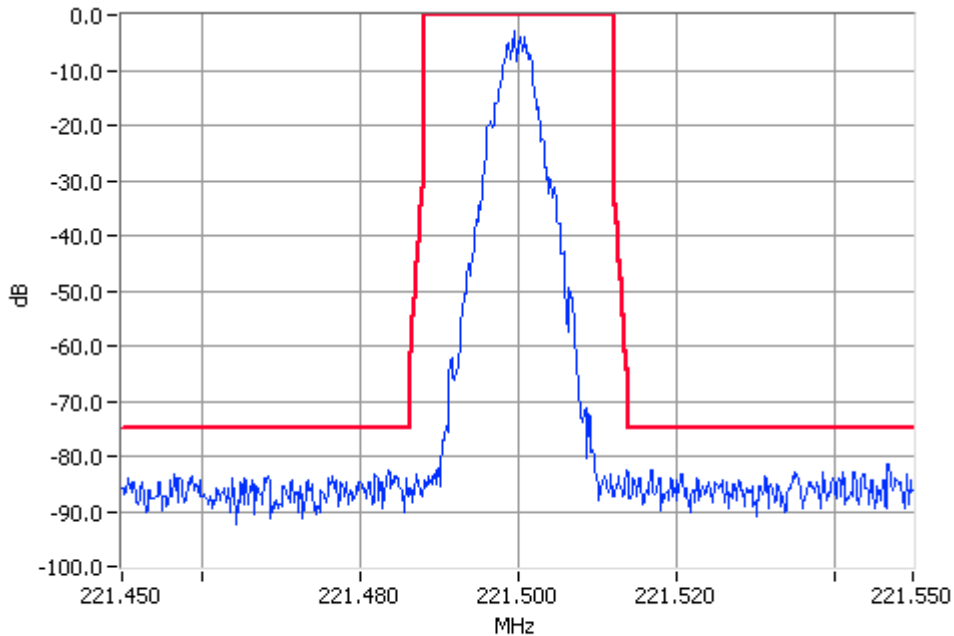

Digital Modulation 221.5000MHz Mask Fx5 100W Pass  
RBW=300Hz VBW=3000Hz

OCCUPIED BANDWIDTH

DIGITAL DATA

SPECIFICATION: FCC CFR 2.1049 (c)

Tx FREQUENCY: 221.5 MHz 10W 12.5 kHz Channel Spacing

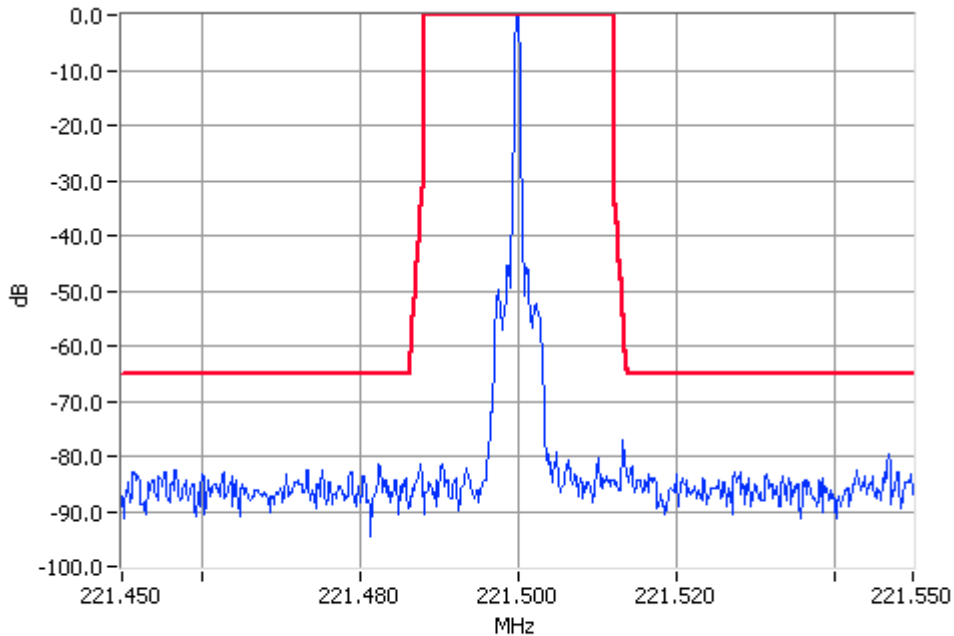

Unmodulated 221.5000MHz Mask Fx5 10W Pass  
RBW=300Hz VBW=3000Hz

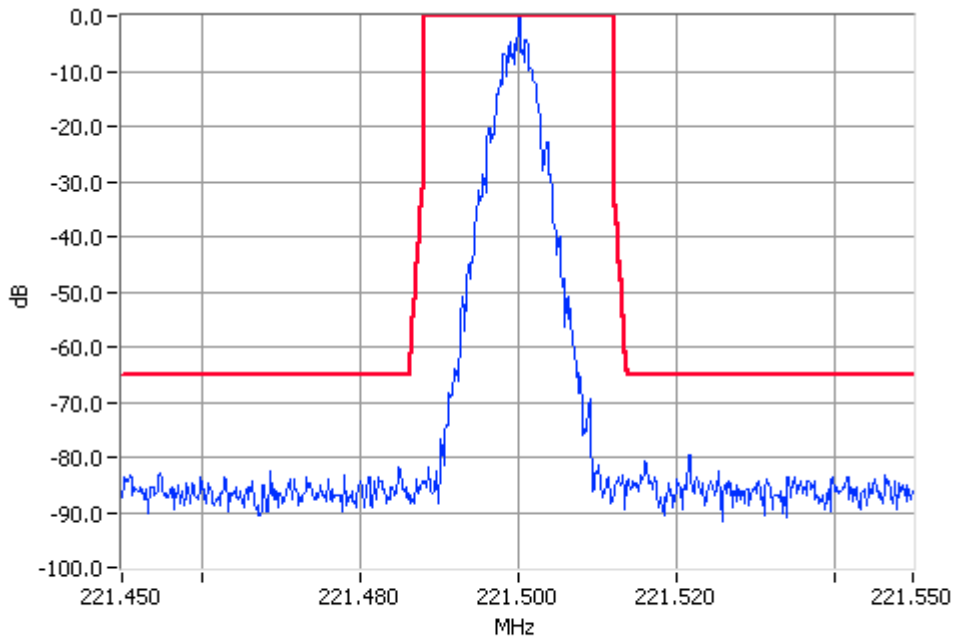

Digital Modulation 221.5000MHz Mask Fx5 10W Pass  
RBW=300Hz VBW=3000Hz

### SPURIOUS EMISSIONS (CONDUCTED)

SPECIFICATION: FCC 47 CFR 2.1051

GUIDE: TIA/EIA-603C 2.2.13

**MEASUREMENT PROCEDURE:**

1. Refer Annex A for equipment set up.
2. The frequency range examined was from the lowest frequency generated within the EUT, to a frequency higher than the 10<sup>th</sup> Harmonic:
3. A Pre-scan is performed with a resolution bandwidth of 1 kHz, and a video bandwidth of 3 kHz. If any emissions are found to be within 20dB of the limit a second measurement is made with the carrier modulated, and a resolution bandwidth of 10 kHz, and a video bandwidth of 30kHz.
4. Spurious emissions which were attenuated more than 20dB below the limit were not recorded.

**MEASUREMENT RESULTS:**

Power Amplifier: 100W		
25.0 kHz Channel Spacing	219.1 MHz @ 100 W	
Emission Frequency (MHz)	Level (dBm)	Level (dBc)
~	~	~
No emissions were detected at a level greater than 20 dB below the limit.		

**LIMITS:**

Carrier Output Power Watts	FCC 47 CFR 80.211 (f) $43 + 10 \text{ Log}_{10} (P_{\text{Watts}})$	
100 W	-13 dBm	63 dBc
10 W	-13 dBm	53 dBc









SPURIOUS EMISSIONS (RADIATED)

SPECIFICATION: FCC 47 CFR 2.1053

GUIDE: TIA/EIA-603C 2.2.12

MEASUREMENT PROCEDURE:

1. Refer Appendix A for equipment set up.
2. Initial Scan
  - a) The EUT is placed in S-Line TEM cell and emissions are measured from 30MHz to 1000MHz. The output terminal was connected to an RF dummy load.
  - b) Any emission within 10dB of the limit is then re-tested on the OATS, along with measurements from 1000MHz to the 10<sup>th</sup> harmonic of the fundamental.
3. OATS Measurement
  - a) The EUT was placed on a wooden turntable at a distance of three metres from the test antenna. The output terminal was connected to an RF dummy load.
  - b) The test antenna was raised from 1m to 4m to obtain a maximum reading, the turntable was then rotated through 360° to obtain the maximum response of each spurious emission. Valid emissions were determined by switching the EUT on and off.
  - c) The EUT was then replaced by a signal generator and substitution antenna to make measurements by the substitution method.

MEASUREMENT RESULTS:

Power Amplifier: 100W		
25.0 kHz Channel Spacing	219.1 MHz @ 100 W	
Emission Frequency (MHz)	Level (dBm)	Level (dBc)
~	~	~
No emissions were detected at a level greater than 20 dB below the limit.		

LIMITS:

Carrier Output Power Watts	FCC 47 CFR 80.211 (f) $43 + 10 \text{ Log}_{10} (P_{\text{Watts}})$	
100 W	-13 dBm	63 dBc
10 W	-13 dBm	53 dBc

SPURIOUS EMISSIONS (RADIATED)

SPECIFICATION: FCC CFR 2.1051

Power Amplifier: 100W		
25.0 kHz Channel Spacing		219.1 MHz @ 10 W
Emission Frequency (MHz)	Level (dBm)	Level (dBc)
~	~	~
No emissions were detected at a level greater than 20 dB below the limit.		

LIMITS:

Carrier Output Power Watts	FCC 47 CFR 80.211 (f) $43 + 10 \text{ Log}_{10} (P_{\text{Watts}})$	
100 W	-13 dBm	63 dBc
10 W	-13 dBm	53 dBc





**TRANSMITTER FREQUENCY STABILITY (TEMPERATURE)**

SPECIFICATION: FCC 47 CFR 2.1055 (a) (1)

GUIDE: TIA/EIA-603C 2.2.2

MEASUREMENT PROCEDURE:

1. Refer Annex A for equipment set up.
2. The EUT was tested for frequency error from  $-30^{\circ}\text{C}$  to  $+50^{\circ}\text{C}$  in  $10^{\circ}\text{C}$  increments
3. The frequency error was recorded in parts per million (ppm).

LIMIT CLAUSE: FCC 47 CFR 80.209	
Frequency Range	Frequency Error (ppm)
216 – 220 MHz	5.0
LIMIT CLAUSE: FCC 47 CFR 90.213	
Frequency Range	Frequency Error (ppm)
216 – 220 MHz	1.0
220 – 222 MHz	0.1

MEASUREMENT RESULTS

Tx FREQUENCY: 219.1 MHz 100 W

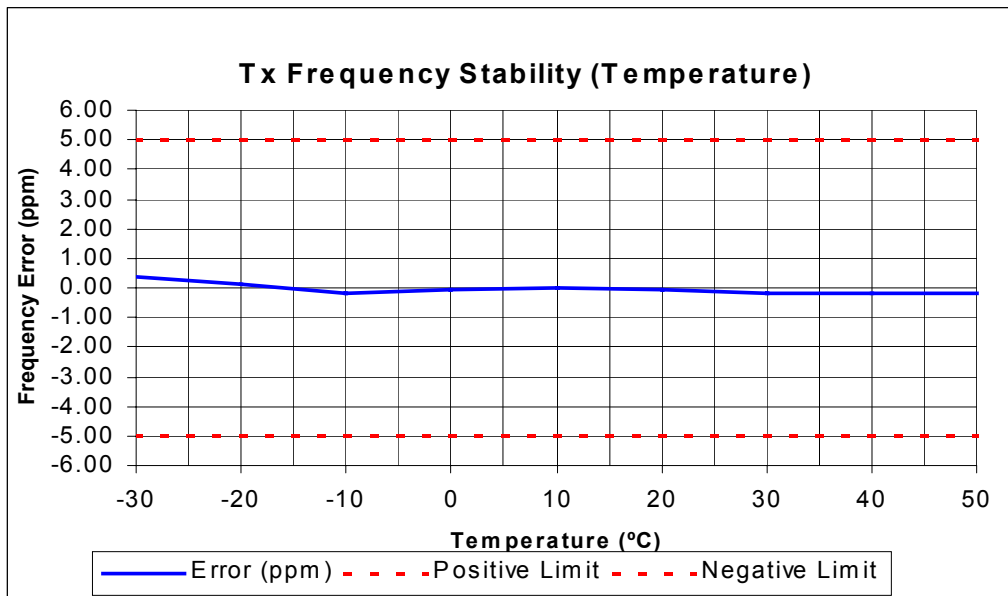



TRANSMITTER FREQUENCY STABILITY (TEMPERATURE)

SPECIFICATION: FCC 47 CFR 2.1055 (a) (1)

Tx FREQUENCY: 221.5 MHz 100W

(EUT Internal Frequency Reference)

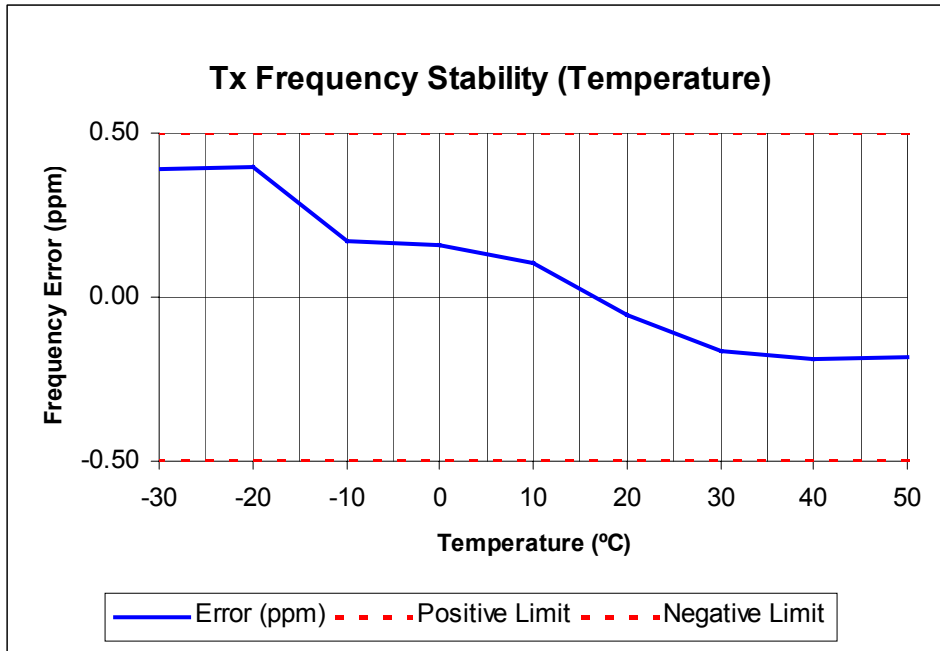

(External 10 MHz Frequency Reference T801-20-000)

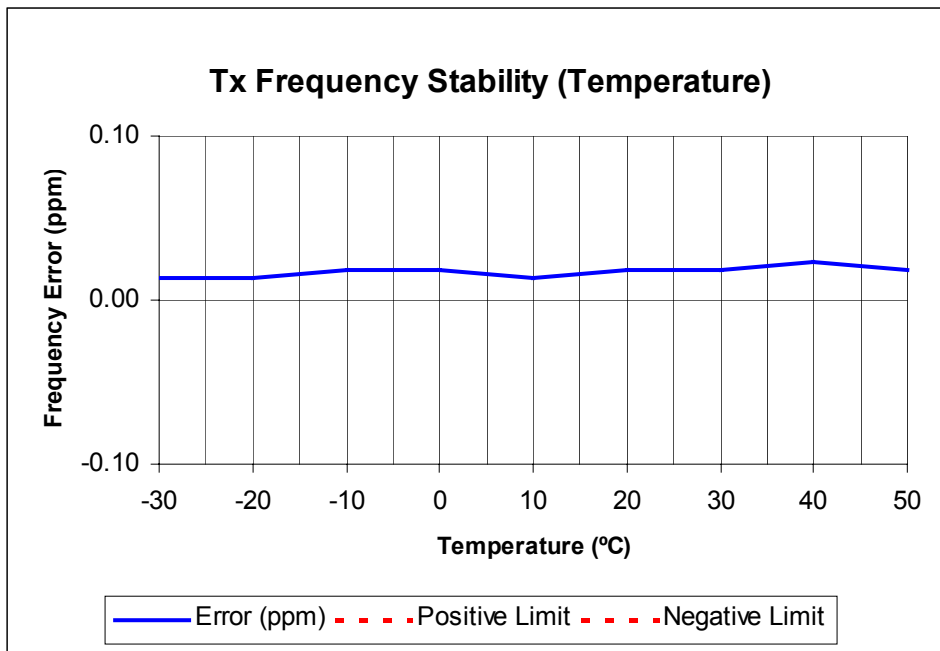

**TRANSMITTER FREQUENCY STABILITY (VOLTAGE)**

SPECIFICATION: FCC 47 CFR 2.1055 (d) (1)

GUIDE: TIA/EIA-603C 2.2.2

MEASUREMENT PROCEDURE:

1. Refer Annex A for equipment set up.
2. The EUT was tested for frequency error at an input voltage to the radio of 85% to 115%.
3. The frequency error was recorded in parts per million (ppm).

MEASUREMENT RESULTS:

Frequency	FREQUENCY ERROR (ppm) @		
	108 V ac	120 V ac	132 V ac
219.1 MHz	-0.15	-0.15	-0.15

Frequency 221.5 MHz	FREQUENCY ERROR (ppm)		
	102 V ac	120 V ac	138 V ac
EUT Internal Frequency Reference	-0.11	-0.12	-0.11
External 10 MHz Frequency Reference T801-20-000	0.01	0.00	0.01

LIMIT CLAUSE: FCC 47 CFR 80.209	
Frequency Range	Frequency Error (ppm)
216 – 220 MHz	5.0
LIMIT CLAUSE: FCC 47 CFR 90.213	
Frequency Range	Frequency Error (ppm)
216 – 220 MHz	1.0
220 – 222 MHz	0.1

## TEST EQUIPMENT USED

No#	Equipment	Manufacturer	Model No	Serial No#	Tait ID	Cal Due
1	Signal Generator	Hewlett Packard	HP8642B (Opt 001)	2512A00176	E3064	7-Feb-06
2	Signal Generator	Hewlett Packard	HP8648A	3430U00344	E3579	30-Nov-05
4	Signal Generator	Hewlett Packard	HP8648C	3443U00543	E3558	7-Feb-06
5	Signal Generator	Rohde & Schwarz	SMY01 1062.5502.11	841736/019	E3553	30-Nov-05
11	Modulation Analyser	Hewlett Packard	HP8901B (Opt 002)	2441A00393	E3073	30-Nov-05
13	Audio Analyser	Hewlett Packard	HP8903A	2308A02597	E3074	30-Nov-05
14	Power Head	Hewlett Packard	HP11722A	2320A00688	E3307	30-Nov-05
22	Oscilloscope	Tektronics	TDS340	B013611	E3585	30-Nov-05
40	Reference Dipoles	Emco	3121C DB1	9510-1164	E3559	17-Oct-06
42	Reference Horn Antenna	Emco	DRG3115	9512-4638	E3560	27-Sep-06
43	Horn Antenna	Emco	DRG3115	2084	E3076	27-Sep-06
46	S-LINE TEM CELL	Rohde & Schwarz	1089.9296.02	338232/003	E3636	
62	RF Attenuator 150W	Weinschel	57-10-34	LB590	E3674	30-Nov-05
65	RF Attenuator 50W	Weinschel	24-20-44	AW1266	E3562	30-Nov-05
66	RF Attenuator 25W	Weinschel	33-20-33	BD5871	E3673	30-Nov-05
70	RF Load 150W	Bird	8166	524	E3625	15-Nov-05
82	3m Coax Cable BLUE)	Suhner	Sucoflex 104A	25033/4A	E3694	19-Nov-05
87	Audio Analyser	Hewlett Packard	HP8903B	2818A04275	E3710	12-Nov-05
88	Spectrum Analyser	Hewlett Packard	HP8562E	3821A00779	E3715	14-Nov-05
100	Oscilloscope	Tektronics	TDS380	B017095	E3782	30-Nov-05
115	Environ. Chamber	Contherm	5400 RHSLT.M	1416	E4051	14-Apr-06
118	RF Attenuator	Weinschel	Model 1	BL9958	E4081	4-Jan-06
120	RF Splitter Combiner	Minicircuits	ZFSC-4-1	-	E4083	4-Jan-06
123	Spectrum Analyser	Agilent	E4445A	MY42510072	E4139	30-May-06
135	Attenuator	Weinschel	67-30-33	BR0531	E4280	13-Aug-05
136	Multimeter	Fluke	77	35069359	E3237	9-Nov-05
137	1m Multiflex Cable	Suhner	MF141	TT007		8-Aug-06
138	1m Multiflex Cable	Suhner	MF141	TT086		8-Aug-06

## APPENDIX A

### TEST SETUP DETAILS

Radiated Emissions Set up.

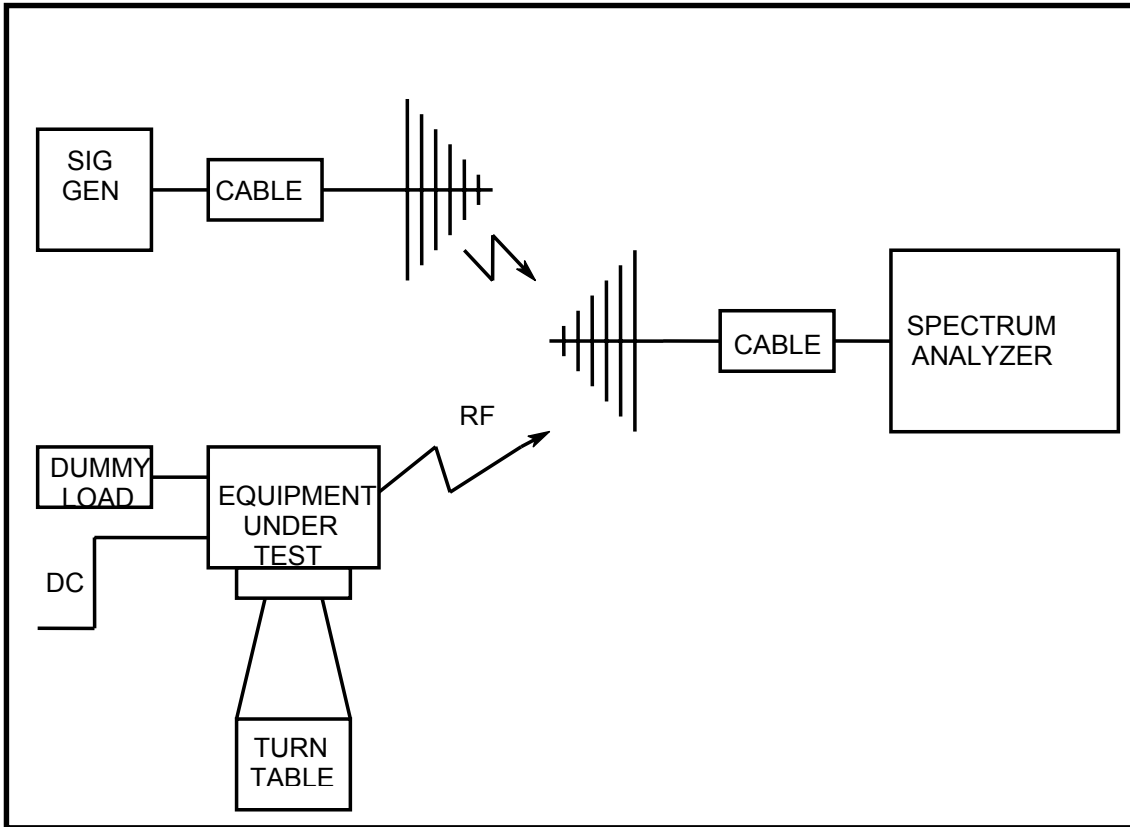

All other testing is performed using the Teltest Radio **EVAL**uation system (TREVA), which is configured as shown below. The Spectrum Analyser is connected to the EUT via the attenuator network for Conducted Emissions testing, and Occupied Bandwidth.

