



CERTIFICATION TEST REPORT

Report Number. : 12292105 -E1V1

Applicant : SRAM LLC
1000 W Fulton Market 4th Floor
Chicago, IL 60607 U.S.A

Model : 00010

FCC ID : C90-LSBB1

IC : 10161A-LSBB1

EUT Description : Left Shifter with AIREA and BLE Radios

Test Standard(s) : FCC 47 CFR PART 15 SUBPART C
ISED RSS-247 ISSUE 2
ISED RSS-GEN ISSUE 5

Date Of Issue:

June 15, 2018

Prepared by:

UL Verification Services Inc.
47173 Benicia Street
Fremont, CA 94538, U.S.A.
TEL: (510) 771-1000
FAX: (510) 661-0888



NVLAP LAB CODE 200065-0

REPORT REVISION HISTORY

Rev.	Issue Date	Revisions	Revised By
V1	06/15/18	Initial Issue	--

TABLE OF CONTENTS

REPORT REVISION HISTORY	2
TABLE OF CONTENTS	3
1. ATTESTATION OF TEST RESULTS	5
2. TEST METHODOLOGY	6
3. FACILITIES AND ACCREDITATION	6
4. CALIBRATION AND UNCERTAINTY	7
4.1. <i>MEASURING INSTRUMENT CALIBRATION</i>	<i>7</i>
4.2. <i>SAMPLE CALCULATION</i>	<i>7</i>
4.3. <i>MEASUREMENT UNCERTAINTY.....</i>	<i>7</i>
5. EQUIPMENT UNDER TEST.....	8
5.1. <i>DESCRIPTION OF EUT</i>	<i>8</i>
5.2. <i>MAXIMUM OUTPUT POWER.....</i>	<i>8</i>
5.3. <i>DESCRIPTION OF AVAILABLE ANTENNAS</i>	<i>8</i>
5.4. <i>SOFTWARE AND FIRMWARE.....</i>	<i>8</i>
5.5. <i>WORST-CASE CONFIGURATION AND MODE.....</i>	<i>8</i>
5.6. <i>DESCRIPTION OF TEST SETUP.....</i>	<i>9</i>
6. MEASUREMENT METHOD.....	12
7. TEST AND MEASUREMENT EQUIPMENT	13
8. ANTENNA PORT TEST RESULTS	14
8.1. <i>ON TIME AND DUTY CYCLE.....</i>	<i>14</i>
8.2. <i>99% BANDWIDTH.....</i>	<i>15</i>
8.3. <i>6 dB BANDWIDTH.....</i>	<i>16</i>
8.4. <i>OUTPUT POWER.....</i>	<i>17</i>
8.5. <i>AVERAGE POWER.....</i>	<i>18</i>
8.6. <i>POWER SPECTRAL DENSITY</i>	<i>19</i>
8.7. <i>CONDUCTED SPURIOUS EMISSIONS.....</i>	<i>20</i>
9. RADIATED TEST RESULTS.....	22
9.1. <i>LIMITS AND PROCEDURE.....</i>	<i>22</i>
9.2. <i>TRANSMITTER ABOVE 1 GHz</i>	<i>23</i>
9.3. <i>Worst Case Below 30MHz</i>	<i>33</i>
9.4. <i>Worst Case Below 1 GHz</i>	<i>35</i>

9.5. Worst Case 18-26 GHz.....	37
10. SETUP PHOTOS	39

1. ATTESTATION OF TEST RESULTS

COMPANY NAME: SRAM LLC
1000 W Fulton Market 4th Floor
Chicago, IL 60607 U.S.A

EUT DESCRIPTION: Left Shifter with AIREA and BLE Radios

MODEL: 00010

SERIAL NUMBER: 1133010252 (Conducted), 1133010216 (Radiated)

DATE TESTED: May 16 – 25 , 2018

APPLICABLE STANDARDS	
STANDARD	TEST RESULTS
CFR 47 Part 15 Subpart C	Complies
ISED RSS-247 Issue 2	Complies
ISED RSS-GEN Issue 5	Complies

UL Verification Services Inc. tested the above equipment in accordance with the requirements set forth in the above standards. All indications of Pass/Fail in this report are opinions expressed by UL Verification Services Inc. based on interpretations and/or observations of test results. Measurement Uncertainties were not taken into account and are published for informational purposes only. The test results show that the equipment tested is capable of demonstrating compliance with the requirements as documented in this report.

Note: The results documented in this report apply only to the tested sample, under the conditions and modes of operation as described herein. This document may not be altered or revised in any way unless done so by UL Verification Services Inc. and all revisions are duly noted in the revisions section. Any alteration of this document not carried out by UL Verification Services Inc. will constitute fraud and shall nullify the document. This report must not be used by the client to claim product certification, approval, or endorsement by NVLAP, NIST, any agency of the Federal Government, or any agency of the U.S. government.

Approved & Released For
UL Verification Services Inc. By:

Prepared By:



DAN CORONIA
CONSUMER TECHNOLOGY DIVISION
OPERATIONS LEADER
UL Verification Services Inc.

GLENN ESCANO
CONSUMER TECHNOLOGY DIVISION
TEST ENGINEER
UL Verification Services Inc

2. TEST METHODOLOGY

The tests documented in this report were performed in accordance with FCC CFR 47 Part 2, FCC CFR 47 Part 15, KDB 558074 D01 v04, ANSI C63.10-2013, RSS-GEN Issue 5, and RSS-247 Issue 2.

3. FACILITIES AND ACCREDITATION

The test sites and measurement facilities used to collect data are located at 47173 and 47266 Benicia Street, Fremont, California, USA. Line conducted emissions are measured only at the 47173 address. The following table identifies which facilities were utilized for radiated emission measurements documented in this report. Specific facilities are also identified in the test results sections.

47173 Benicia Street	47266 Benicia Street
<input checked="" type="checkbox"/> Chamber A (ISED:2324B-1)	<input type="checkbox"/> Chamber D (ISED:22541-1)
<input checked="" type="checkbox"/> Chamber B (ISED:2324B-2)	<input type="checkbox"/> Chamber E (ISED:22541-2)
<input type="checkbox"/> Chamber C (ISED:2324B-3)	<input type="checkbox"/> Chamber F (ISED:22541-3)
	<input type="checkbox"/> Chamber G (ISED:22541-4)
	<input type="checkbox"/> Chamber H (ISED:22541-5)

The above test sites and facilities are covered under FCC Test Firm Registration # 208313. Chambers A through C are covered under ISED company address code 2324B with site numbers 2324B -1 through 2324B-3, respectively. Chambers D through H are covered under ISED Canada company address code 22541 with site numbers 22541 -1 through 22541-5, respectively.

UL Verification Services Inc. is accredited by NVLAP, Laboratory Code 200065-0. The full scope of accreditation can be viewed at <http://nist.gov/standards/scopes/2000650.htm>.

4. CALIBRATION AND UNCERTAINTY

4.1. MEASURING INSTRUMENT CALIBRATION

The measuring equipment utilized to perform the tests documented in this report has been calibrated in accordance with the manufacturer's recommendations, and is traceable to recognized national standards.

4.2. SAMPLE CALCULATION

Where relevant, the following sample calculation is provided:

$$\begin{aligned} \text{Field Strength (dBuV/m)} &= \text{Measured Voltage (dBuV)} + \text{Antenna Factor (dB/m)} + \\ &\text{Cable Loss (dB)} - \text{Preamp Gain (dB)} \\ 36.5 \text{ dBuV} + 18.7 \text{ dB/m} + 0.6 \text{ dB} - 26.9 \text{ dB} &= 28.9 \text{ dBuV/m} \end{aligned}$$

4.3. MEASUREMENT UNCERTAINTY

Where relevant, the following measurement uncertainty levels have been estimated for tests performed on the apparatus:

PARAMETER	UNCERTAINTY
Worst Case Conducted Disturbance, 9KHz to 0.15 MHz	3.84 dB
Worst Case Conducted Disturbance, 0.15 to 30 MHz	3.65 dB
Worst Case Radiated Disturbance, 9KHz to 30 MHz	3.15 dB
Worst Case Radiated Disturbance, 30 to 1000 MHz	5.36 dB
Worst Case Radiated Disturbance, 1000 to 18000 MHz	4.32 dB
Worst Case Radiated Disturbance, 18000 to 26000 MHz	4.45 dB
Worst Case Radiated Disturbance, 26000 to 40000 MHz	5.24 dB

Uncertainty figures are valid to a confidence level of 95%.

5. EQUIPMENT UNDER TEST

5.1. DESCRIPTION OF EUT

The EUT is a Left Shifter with AIREA and BLE Radios, powered by CR2032 coin cell battery.

5.2. MAXIMUM OUTPUT POWER

The transmitter has a maximum conducted output power as follows:

Frequency Range (MHz)	Mode	Peak		Average	
		Output Power (dBm)	Output Power (mW)	Output Power (dBm)	Output Power (mW)
2402-2480	BLE	1.79	1.51	1.46	1.40

5.3. DESCRIPTION OF AVAILABLE ANTENNAS

The radio utilizes a chip antenna type number W3008C, with a maximum gain of 2.2dBi.

5.4. SOFTWARE AND FIRMWARE

The EUT firmware installed during testing was A-1.0.

The test utility software used during testing was Lightblue v2.6.4

5.5. WORST-CASE CONFIGURATION AND MODE

Radiated emissions below 1GHz and above 18GHz were performed with the EUT set to transmit at the channel with highest output power as worst-case scenario.

Band edge and radiated emissions between 1GHz and 18GHz were performed with the EUT set to transmit at the highest power on low, middle and high channels.

The fundamental of the EUT was investigated in three orthogonal orientations X, Y, Z, it was determined that X orientation was worst-case orientation; therefore, all final radiated testing was performed with the EUT in X orientation.

5.6. DESCRIPTION OF TEST SETUP

SUPPORT EQUIPMENT

Support Equipment List			
Description	Manufacturer	Model	Serial Number
Ipod Touch	Apple	MKJ02LL/A	CCQVRHY2GGNL

TEST SETUP

The EUT is powered by a CR2032 coin cell battery. The iPod Touch wirelessly sends commands to the EUT.

SETUP DIAGRAM FOR CONDUCTED TESTS

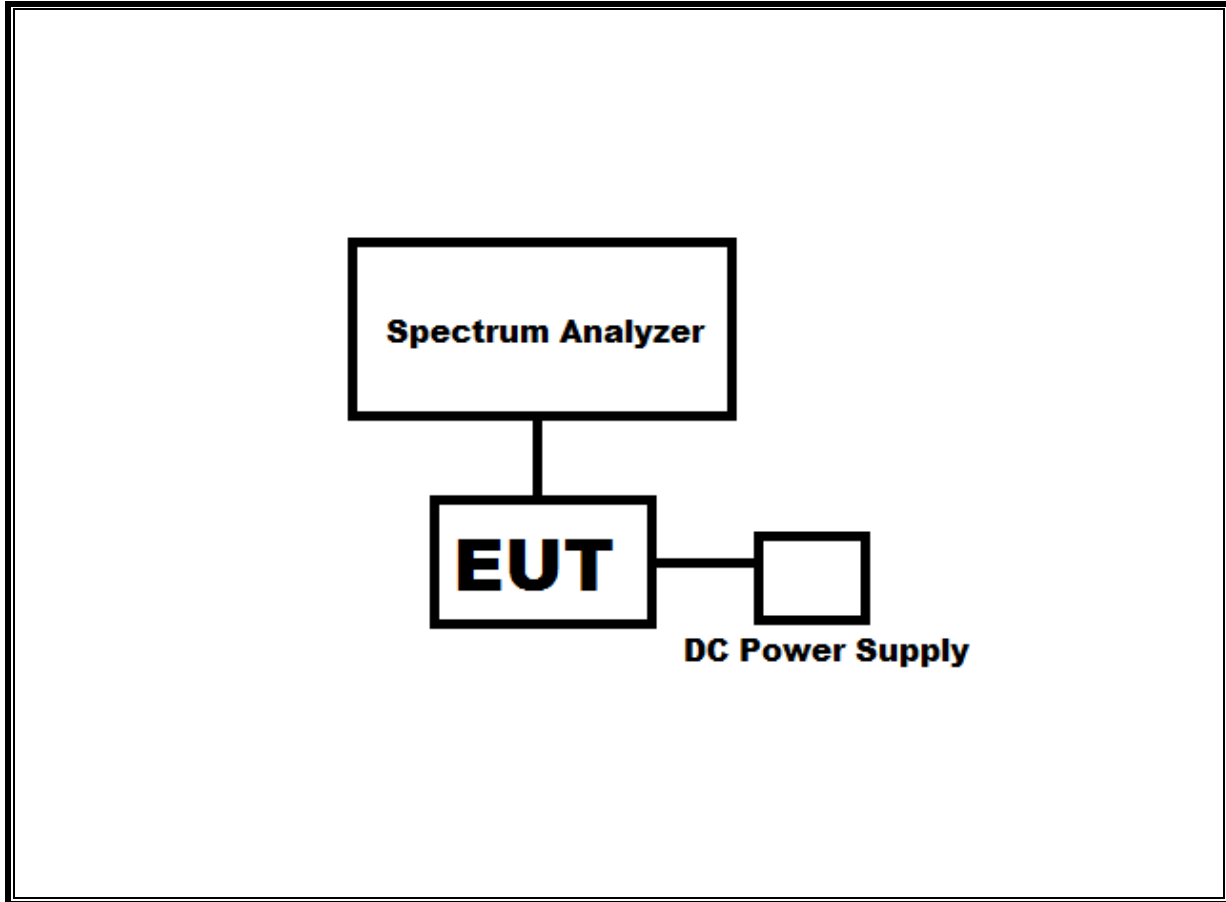

Note – The DC power supply is used only during testing. During normal operation the EUT is powered by a supplied CR2032, coin cell battery.

SETUP DIAGRAM FOR RADIATED TESTS

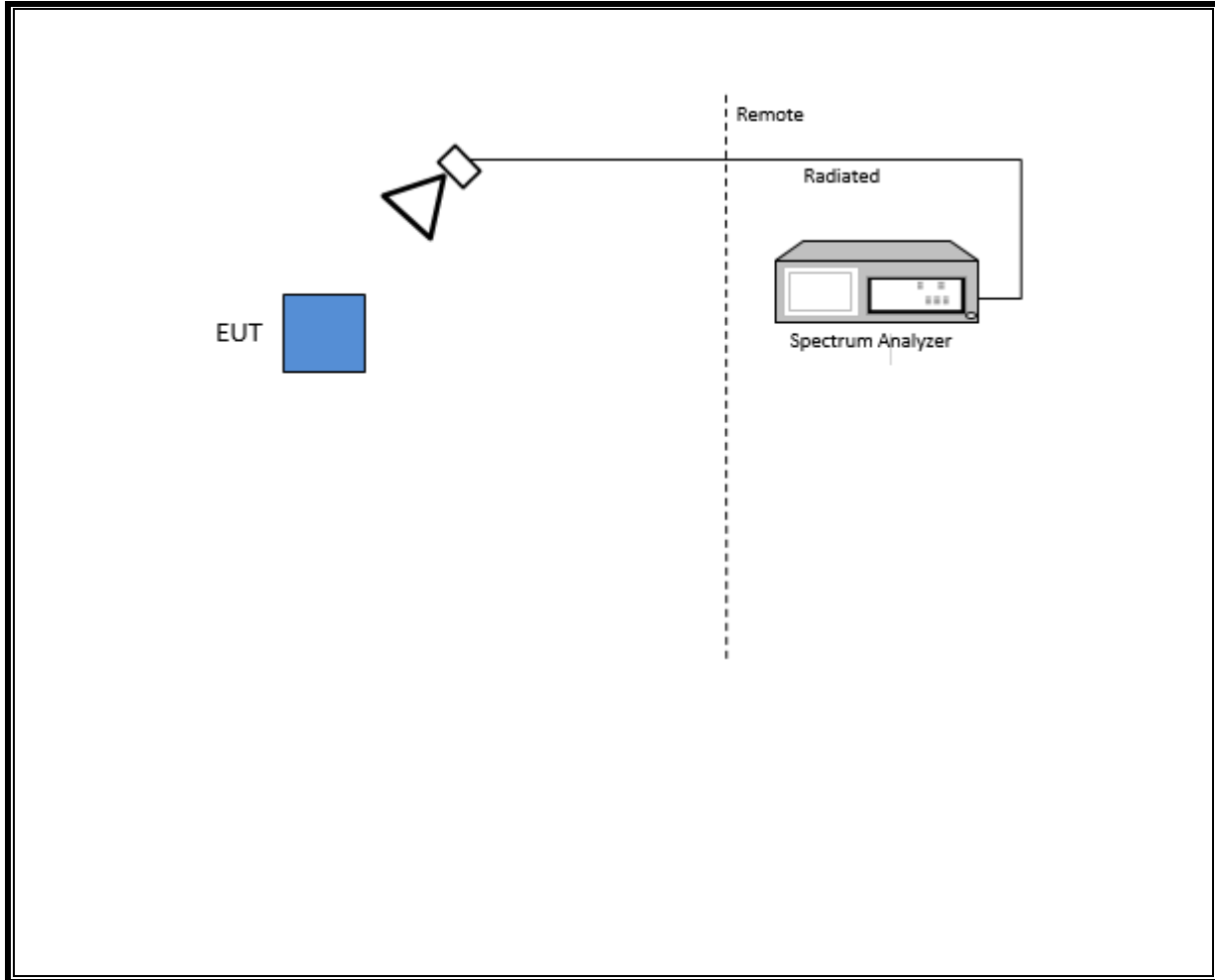

6. MEASUREMENT METHOD

On Time and Duty Cycle: KDB 558074 D01 v04, Section 6.

6 dB BW: KDB 558074 D01 v04, Section 8.1.

99% BW: ANSI C63.10-2013, Section 6.9.3.

Output Power: KDB 558074 D01 v04, Section 9.2.3.2.

Power Spectral Density: KDB 558074 D01 v04, Section 10.2.

Out-of-band emissions in non-restricted bands: KDB 558074 D01 v04, Section 11.1 a)

Out-of-band emissions in restricted bands: KDB 558074 D01 v04, Section 12.1.

Band-edge: KDB 558074 D01 v04, Section 12.1.

7. TEST AND MEASUREMENT EQUIPMENT

The following test and measurement equipment was utilized for the tests documented in this:

Test Equipment List					
Description	Manufacturer	Model	ID No.	Cal Date	Cal Due
Spectrum Analyzer	Agilent	N9030A	T1210	07/17/17	07/17/18
Antenna, Biconolog, 30MHz-1 GHz	Sunol Sciences	JB1	T130	10/16/17	10/16/18
Antenna, Horn, 1-18GHz	ETS Lindgren	3117	T862	06/09/17	06/09/18
RF Preamplifier, 10kHz - 1GHz	HP	8447D	T15	08/14/17	08/14/18
RF Preamplifier, 1 - 18GHz	Miteq	AFS42-00101800-25-S-42	T1165	11/25/17	11/25/18
RF Preamplifier, 1-8GHz	Miteq	AMF-4D-01000800-30-29P	T1573	11/25/17	11/25/18
High Pass Filter 3GHz	Micro-Tronics	HPM17543	T486	11/25/17	11/25/18
Antenna, Active Loop 9kHz – 30MHz	Com-Power	AL-130R	T1866	10/10/17	10/10/18
Antenna, Horn, 18-26GHz	ARA	MWH-1826G	T89	01/18/18	01/18/19
Spectrum Analyzer	Keysight	N9030A	T1113	12/21/17	12/21/18
RF Preamplifier, 1-26GHz	Agilent	8449B	T404	07/23/17	07/23/18
RF Power Meter	Agilent	N1911A	T229	08/14/17	08/14/18
RF Power Sensor	Agilent	N1921A	T413	06/22/17	06/22/18

Test Software List			
Description	Manufacturer	Model	Version
Radiated Software	UL	UL EMC	Ver 9.5, Dec 01, 2016
Antenna Port Software	UL	UL RF	Ver 7.8, Jan 10, 2018

8. ANTENNA PORT TEST RESULTS

8.1. ON TIME AND DUTY CYCLE

LIMITS

None; for reporting purposes only.

PROCEDURE

KDB 789033 Zero-Span Spectrum Analyzer Method.

ON TIME AND DUTY CYCLE RESULTS

Mode	ON Time B (msec)	Period (msec)	Duty Cycle x (linear)	Duty Cycle (%)	Duty Cycle Correction Factor (dB)	1/B Minimum VBW (kHz)
BLE	100.0	100.0	1.000	100.00%	0.00	0.010

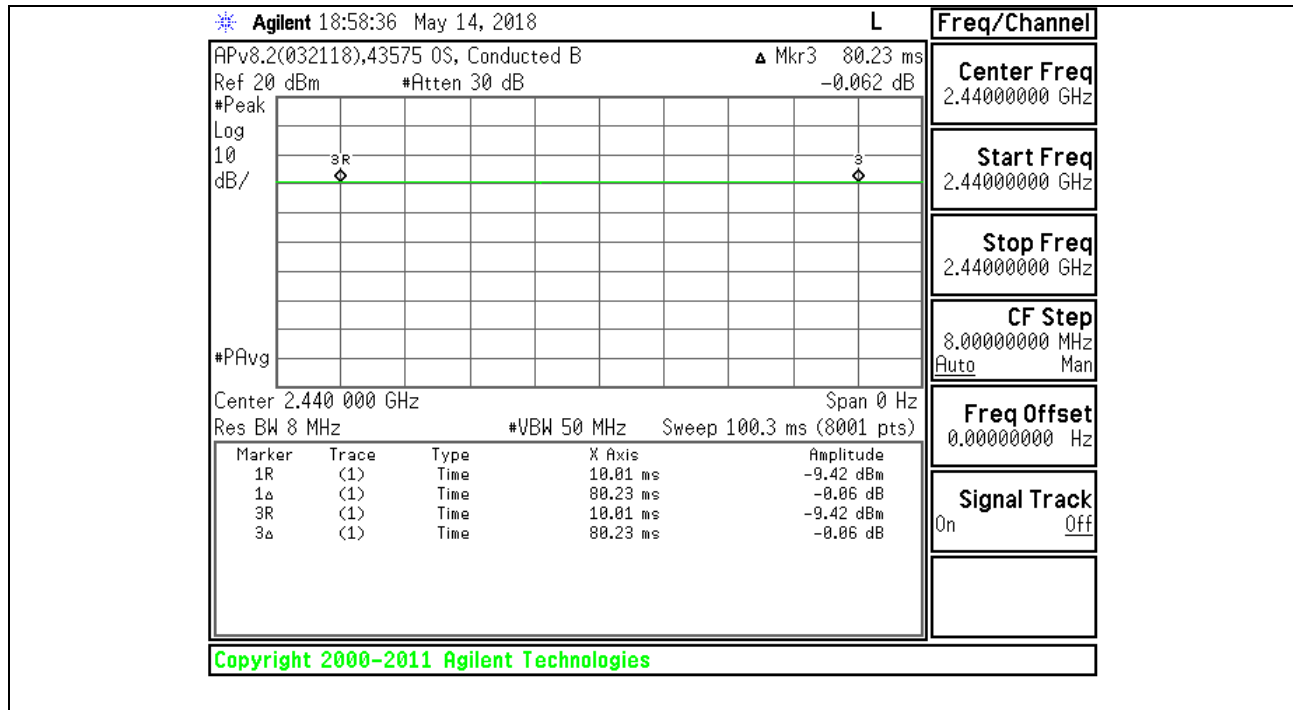

8.2. 99% BANDWIDTH

LIMITS

None; for reporting purposes only.

RESULTS

Channel	Frequency (MHz)	99% Bandwidth (MHz)
Low	2402	1.7808
Middle	2440	1.7880
High	2480	1.7816

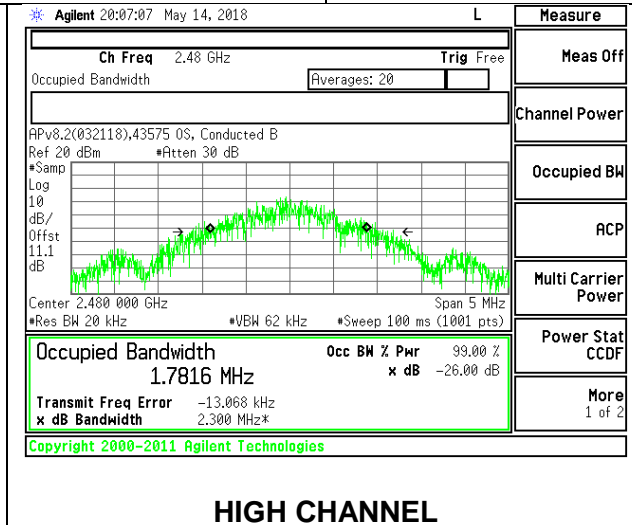
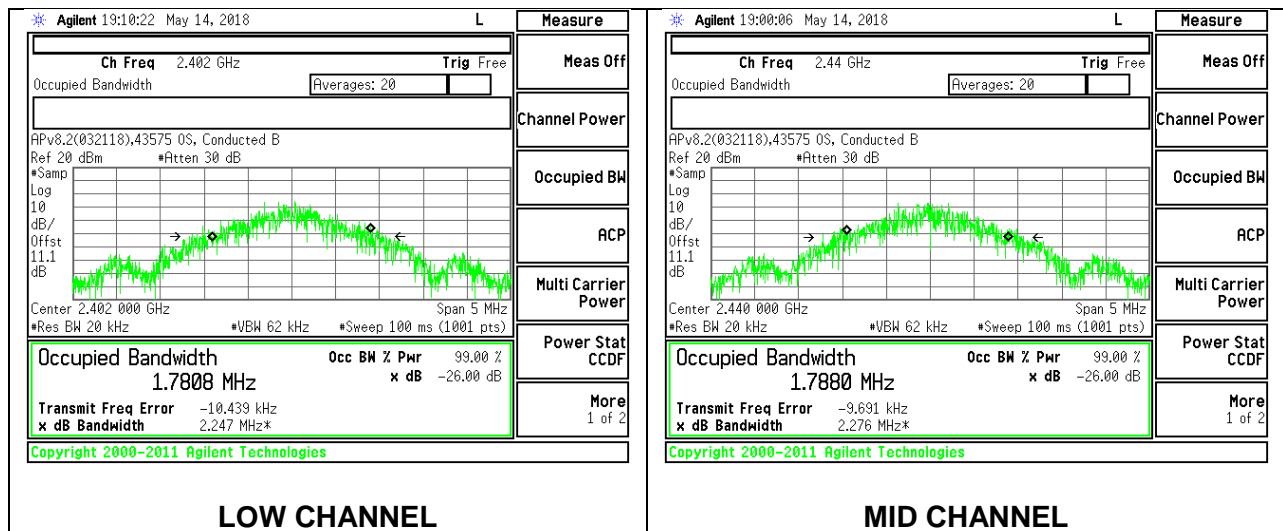

8.3. 6 dB BANDWIDTH

LIMITS

FCC §15.247 (a)(2)

RSS-247 5.2 (a)

The minimum 6 dB bandwidth shall be at least 500 kHz.

RESULTS

Channel	Frequency (MHz)	6 dB Bandwidth (MHz)	Minimum Limit (MHz)
Low	2402	0.870	0.5
Middle	2440	0.885	0.5
High	2480	0.891	0.5

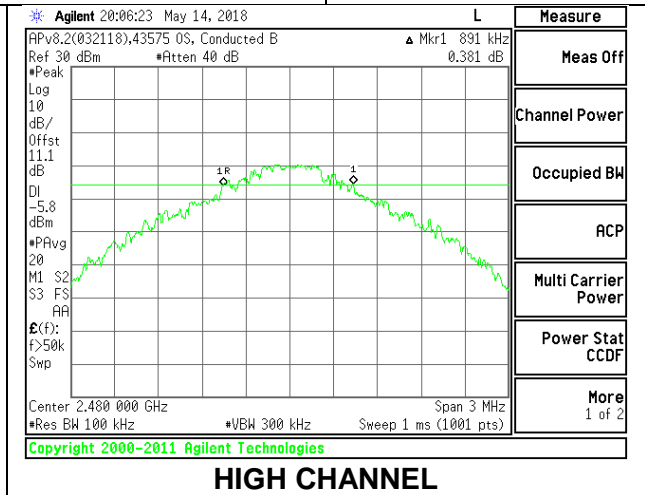
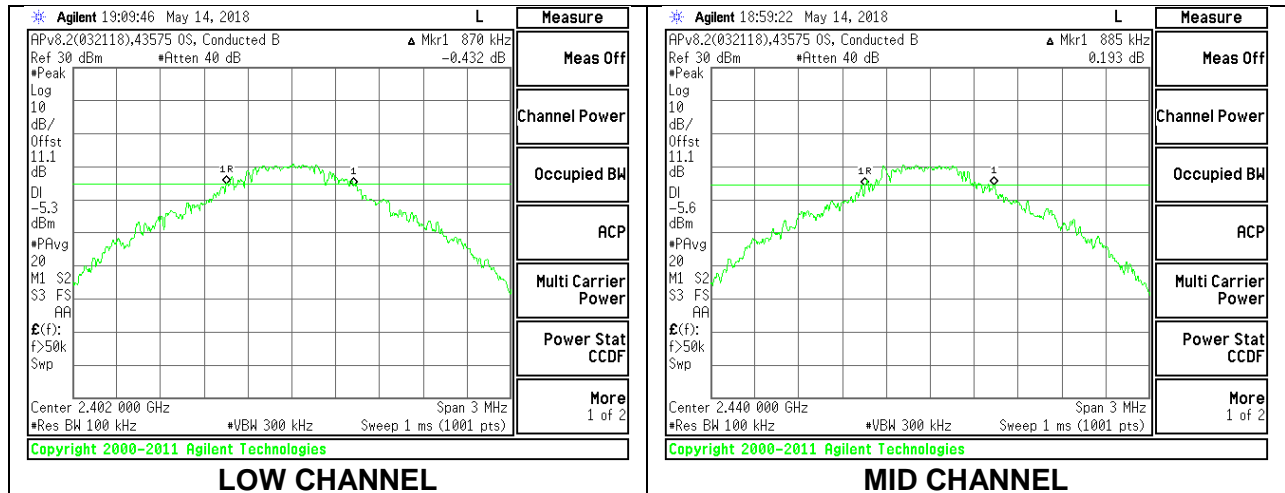

8.4. OUTPUT POWER

LIMITS

FCC §15.247 (b) (3)

RSS-247 5.4 (d)

The maximum antenna gain is less than or equal to 6 dBi, therefore the limit is 30 dBm.

TEST PROCEDURE

The transmitter output is connected to a power meter.

The transmitter output is connected to a power meter. The cable assembly insertion loss was entered as an offset in the power meter to allow for a gated peak reading of power.

RESULTS

Tested By:	43575 OS
Date:	05/23/18

Channel	Frequency (MHz)	Peak Power Reading (dBm)	Limit (dBm)	Margin (dB)
Low	2402	1.79	30	-28.210
Middle	2440	1.59	30	-28.410
High	2480	1.55	30	-28.450

8.5. AVERAGE POWER

LIMITS

None; for reporting purposes only.

TEST PROCEDURE

The transmitter output is connected to a power meter.

The transmitter output is connected to a power meter. The cable assembly insertion loss was entered as an offset in the power meter to allow for a gated average reading of power.

RESULTS

Tested By:	43575 OS
Date:	05/23/18

Channel	Frequency (MHz)	AV power (dBm)
Low	2402	1.46
Middle	2440	1.25
High	2480	1.23

8.6. POWER SPECTRAL DENSITY

LIMITS

FCC §15.247 (e)

RSS-247 (5.2) (b)

The power spectral density conducted from the transmitter to the antenna shall not be greater than 8 dBm in any 3 kHz band during any time interval of continuous transmission.

RESULTS

Channel	Frequency (MHz)	PSD (dBm/3kHz)	Limit (dBm/3kHz)	Margin (dB)
Low	2402	-11.18	8	-19.18
Middle	2440	-11.47	8	-19.47
High	2480	-11.68	8	-19.68

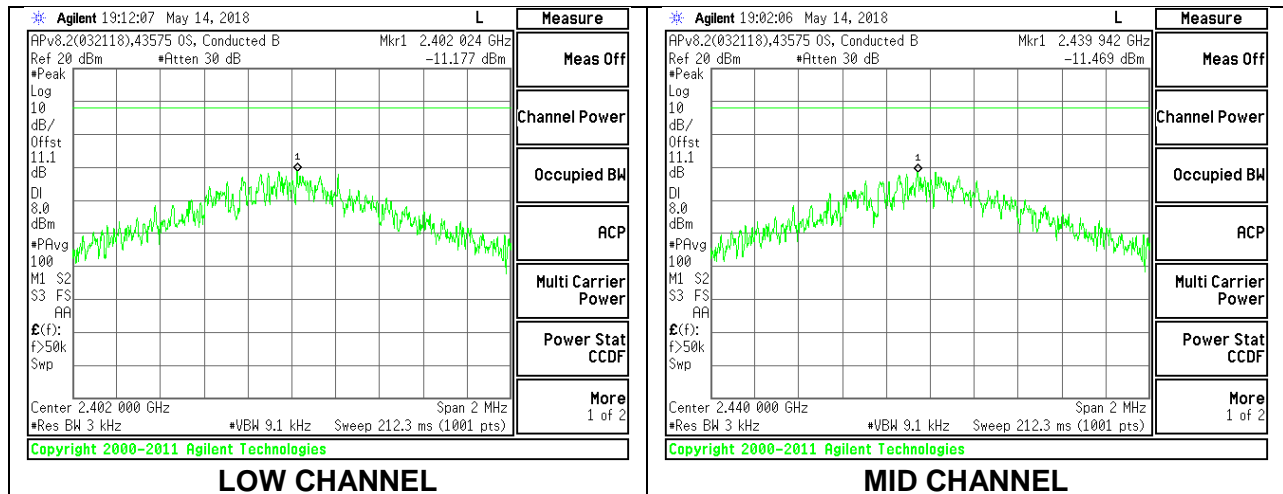

LOW CHANNEL

MID CHANNEL

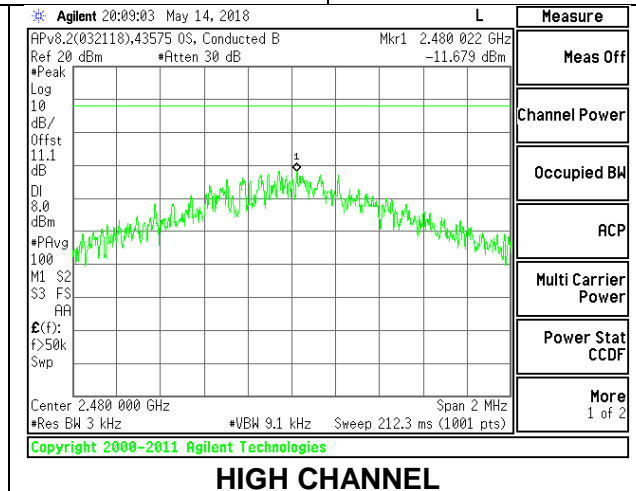

HIGH CHANNEL

8.7. CONDUCTED SPURIOUS EMISSIONS

LIMITS

FCC §15.247 (d)

RSS-247 5.5

Output power was measured based on the use of a peak measurement, therefore the required attenuation is 20 dB.

RESULTS

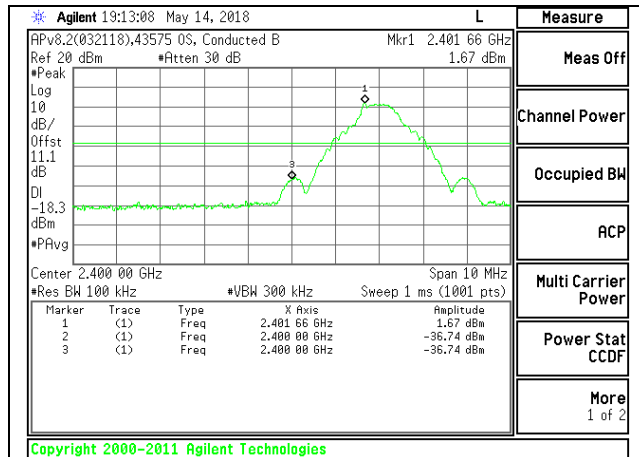

LOW CHANNEL BANDEDGE

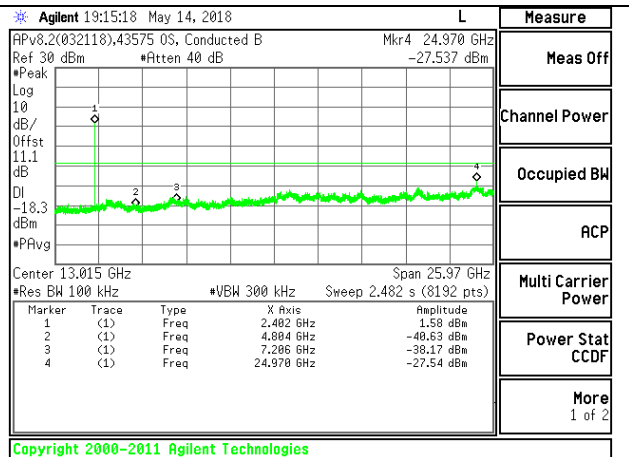

OUT-OF-BAND LOW CHANNEL

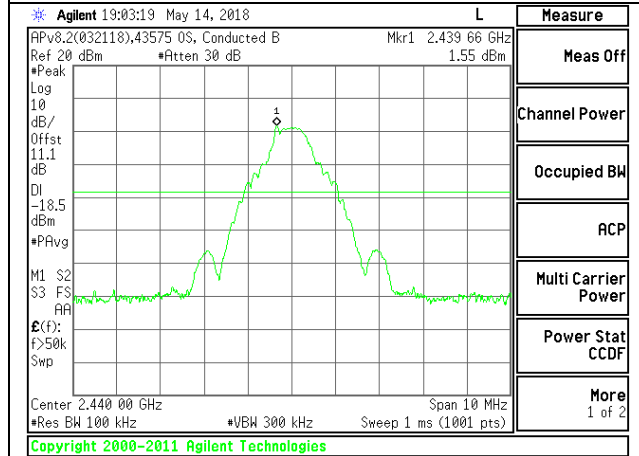

IN-BAND REFERENCE LEVEL

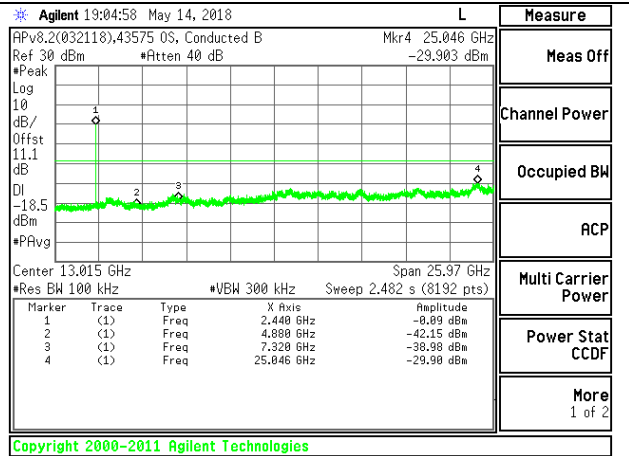

OUT-OF-BAND MID CHANNEL

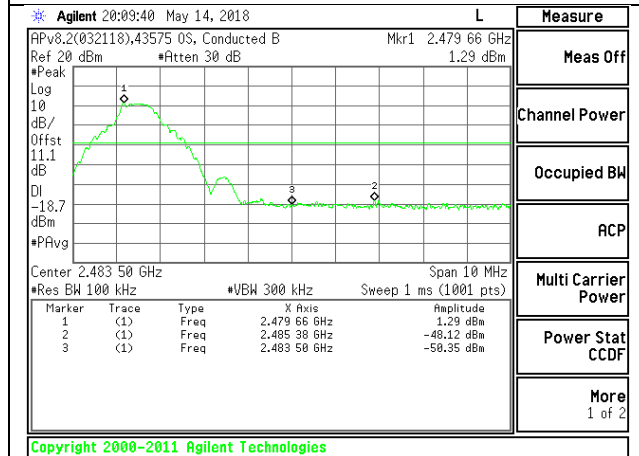

HIGH CHANNEL BANDEDGE

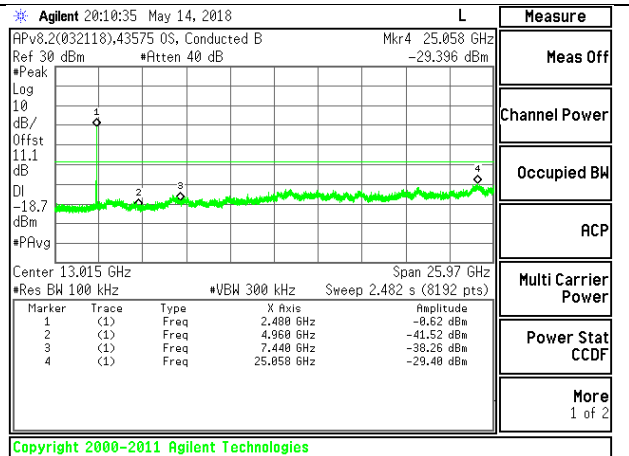

OUT-OF-BAND HIGH CHANNEL

9. RADIATED TEST RESULTS

9.1. LIMITS AND PROCEDURE

LIMITS

FCC §15.205 and §15.209

RSS-GEN, Section 8.9 and 8.10.

Frequency Range (MHz)	Field Strength Limit (uV/m) at 3 m	Field Strength Limit (dBuV/m) at 3 m
0.009-0.490	2400/F(kHz) @ 300 m	-
0.490-1.705	24000/F(kHz) @ 30 m	-
1.705 - 30	30 @ 30m	-
30 - 88	100	40
88 - 216	150	43.5
216 - 960	200	46
Above 960	500	54

TEST PROCEDURE

The EUT is placed on a non-conducting table 80 cm above the ground plane for measurement below 1GHz; 1.5 m above the ground plane for measurement above 1GHz. The antenna to EUT distance is 3 meters. The EUT is configured in accordance with ANSI C63.10. The EUT is set to transmit in a continuous mode.

For measurements below 1 GHz the resolution bandwidth is set to 100 kHz for peak detection measurements or 120 kHz for quasi-peak detection measurements. Peak detection is used unless otherwise noted as quasi-peak.

For pre-scans above 1 GHz the resolution bandwidth is set to 1 MHz; the video bandwidth is set to 30 KHz for peak measurements.

For final measurements above 1 GHz the resolution bandwidth is set to 1 MHz; the video bandwidth is set to 3 MHz for peak measurements and as applicable for average measurements.

The spectrum from 1 GHz to 18 GHz is investigated with the transmitter set to the lowest, middle, and highest channels in each applicable band. Below 1GHz and above 18GHz emissions, the channel with the highest output power was tested.

The frequency range of interest is monitored at a fixed antenna height and EUT azimuth. The EUT is rotated through 360 degrees to maximize emissions received. The antenna is scanned from 1 to 4 meters above the ground plane to further maximize the emission. Measurements are made with the antenna polarized in both the vertical and the horizontal positions.

9.2. TRANSMITTER ABOVE 1 GHz

BANDEDGE (LOW CHANNEL)

HORIZONTAL RESULT

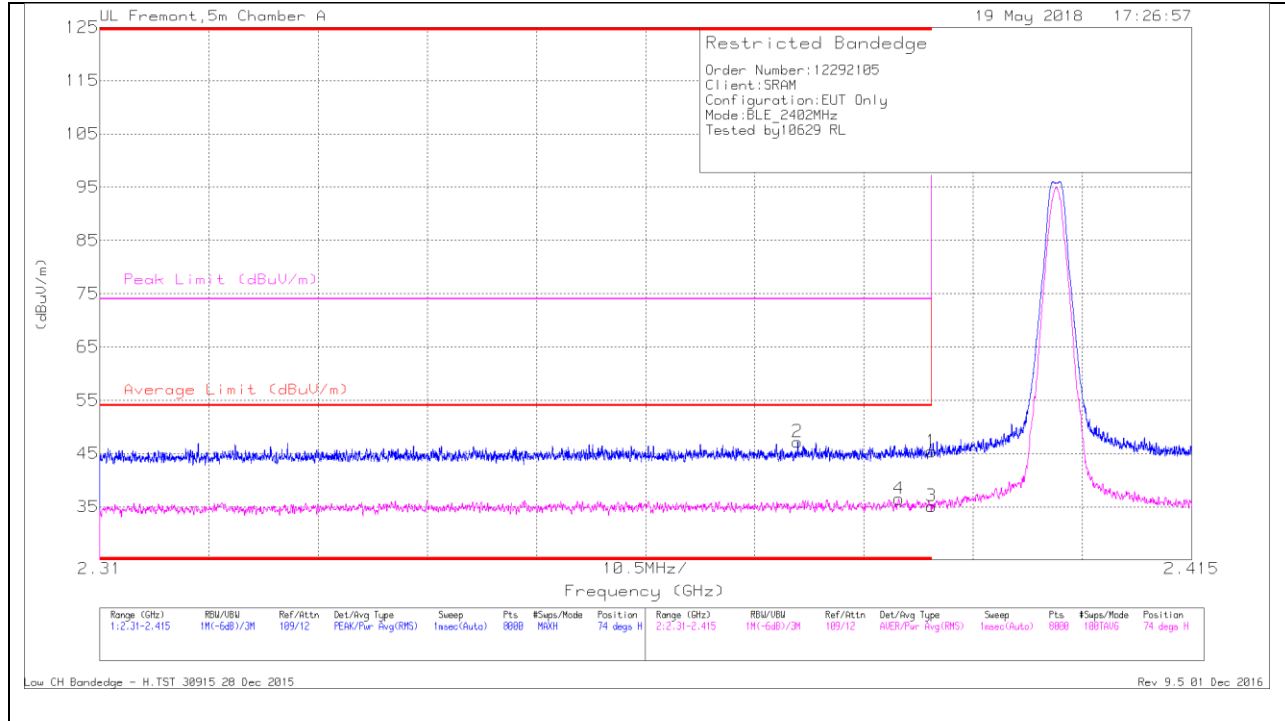

Trace Markers

Marker	Frequency (GHz)	Meter Reading (dBuV)	Det	AF T862 (dB/m)	Amp/Cb1/Ftr/Pad (dB)	DC Corr (dB)	Corrected Reading (dBuV/m)	Average Limit (dBuV/m)	Margin (dB)	Peak Limit (dBuV/m)	PK Margin (dB)	Azimuth (Degs)	Height (cm)	Polarity
2	* 2.377	38.87	Pk	31.7	-23.4	0	47.17	-	-	74	-26.83	74	381	H
4	* 2.387	28.08	RMS	31.8	-23.4	0	36.48	54	-17.52	-	-	74	381	H
1	* 2.39	36.99	Pk	31.8	-23.4	0	45.39	-	-	74	-28.61	74	381	H
3	* 2.39	26.72	RMS	31.8	-23.4	0	35.12	54	-18.88	-	-	74	381	H

* - indicates frequency in CFR47 Pt 15 / IC RSS-Restricted Band

Pk - Peak detector

RMS - RMS detection

VERTICAL RESULT

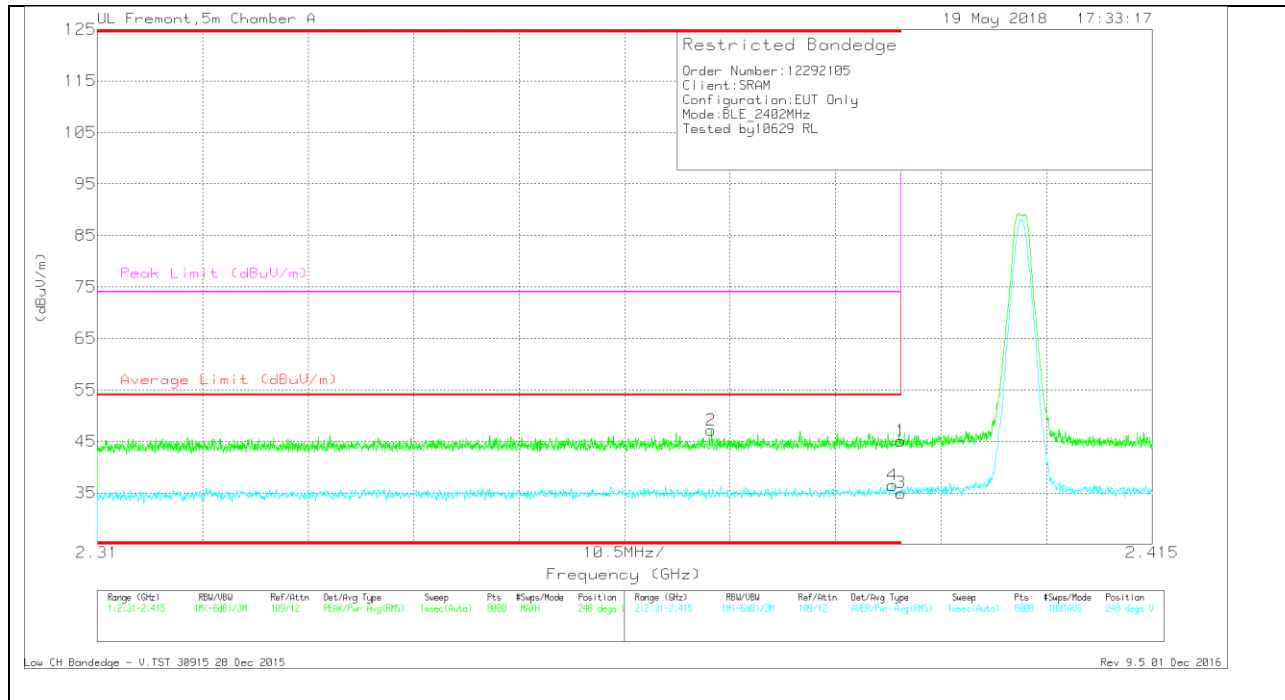

Trace Markers

Marker	Frequency (GHz)	Meter Reading (dBuV)	Det	AF T862 (dB/m)	Amp/Cbl/Ftr/Pad (dB)	DC Corr (dB)	Corrected Reading (dBuV/m)	Average Limit (dBuV/m)	Margin (dB)	Peak Limit (dBuV/m)	PK Margin (dB)	Azimuth (Degs)	Height (cm)	Polarity
1	* 2.39	36.69	PK	31.8	-23.4	0	45.09	-	-	74	-28.91	248	345	V
2	* 2.371	38.85	PK	31.7	-23.4	0	47.15	-	-	74	-26.85	248	345	V
3	* 2.39	26.59	RMS	31.8	-23.4	0	34.99	54	-19.01	-	-	248	345	V
4	* 2.389	28.07	RMS	31.8	-23.4	0	36.47	54	-17.53	-	-	248	345	V

* - indicates frequency in CFR47 Pt 15 / IC RSS-Restricted Band

PK - Peak detector

RMS - RMS detection

BANEDGE (HIGH CHANNEL)

HORIZONTAL RESULT

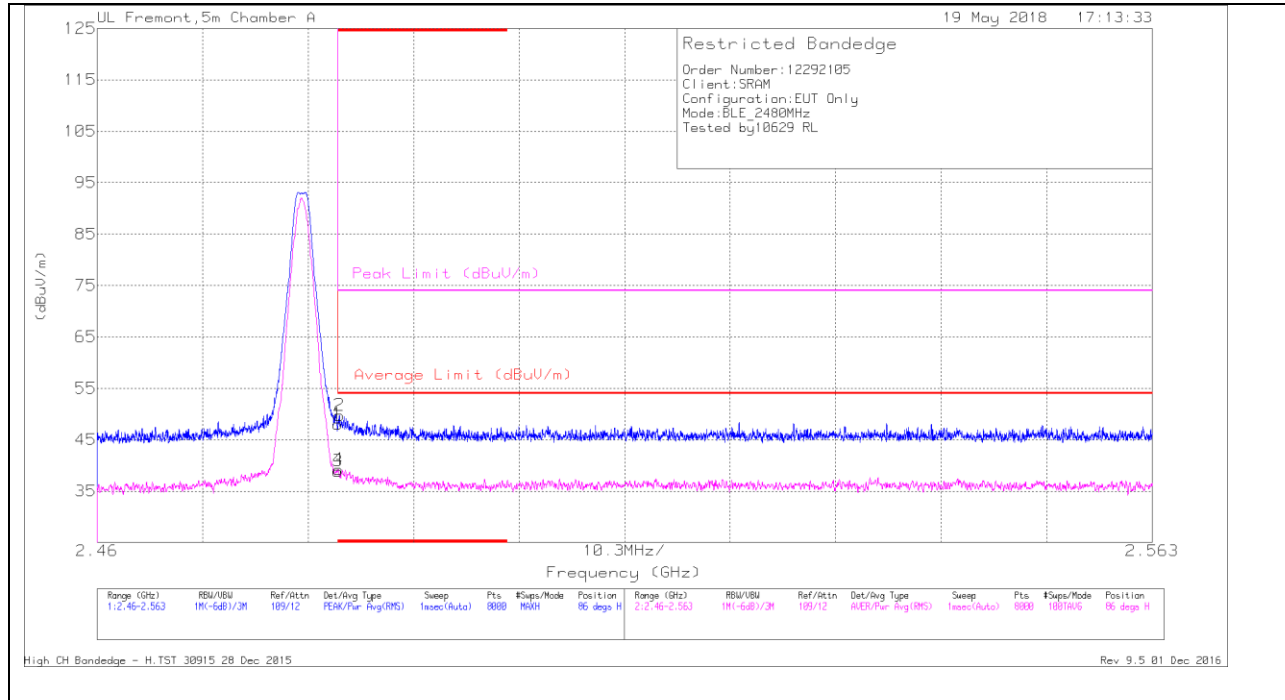

Trace Markers

Marker	Frequency (GHz)	Meter Reading (dBuV)	Det	AF TBEZ (dB/m)	Amp/Ch/Fltr/Pad (dB)	DC Corr (dB)	Corrected Reading (dBuV/m)	Average Limit (dBuV/m)	Margin (dB)	Peak Limit (dBuV/m)	PK Margin (dB)	Azimuth (Degs)	Height (cm)	Polarity
1	* 2.484	39.05	Pk	32.3	-23.3	0	48.05	-	-	74	-25.95	86	112	H
2	* 2.484	40.75	Pk	32.3	-23.3	0	49.75	-	-	74	-24.25	86	112	H
3	* 2.484	29.9	RMS	32.3	-23.3	0	38.9	54	-15.1	-	-	86	112	H
4	* 2.484	30.23	RMS	32.3	-23.3	0	39.23	54	-14.77	-	-	86	112	H

* - indicates frequency in CFR47 Pt 15 / IC RSS-Restricted Band

Pk - Peak detector

RMS - RMS detection

VERTICAL RESULT

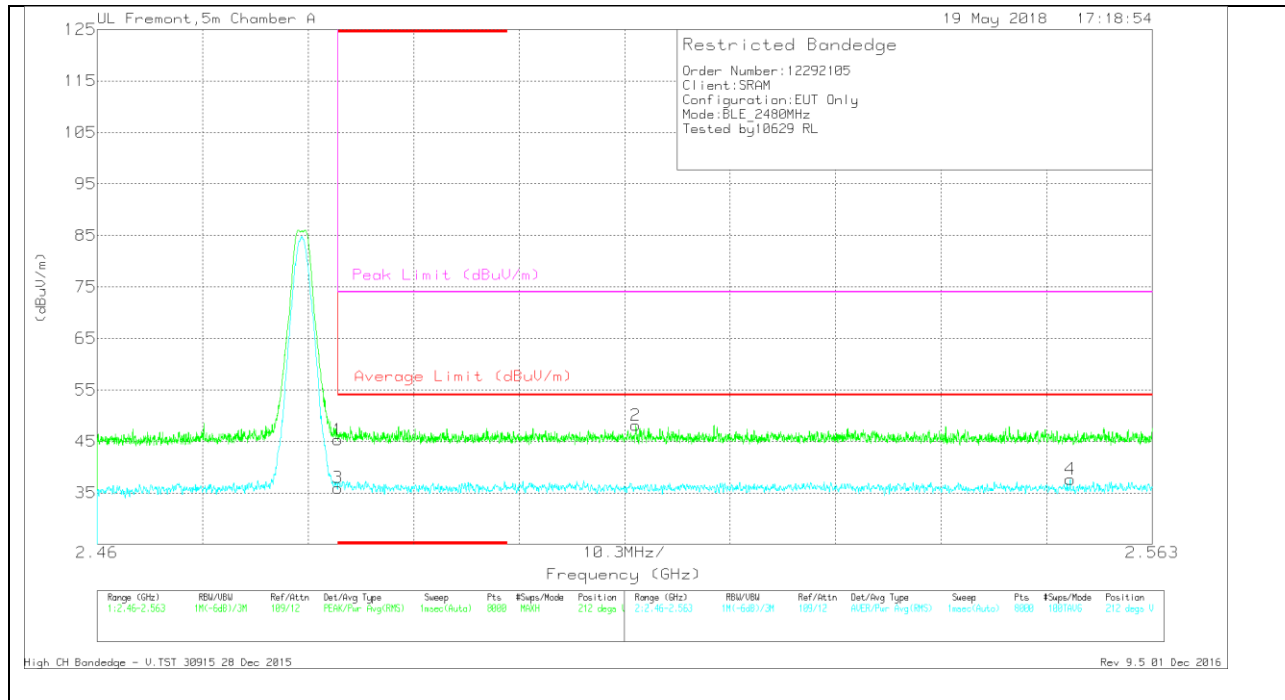

Trace Markers

Marker	Frequency (GHz)	Meter Reading (dBuV)	Det	AF T862 (dB/m)	Amp/Ch/Fltr/Pad (dB)	DC Corr (dB)	Corrected Reading (dBuV/m)	Average Limit (dBuV/m)	Margin (dB)	Peak Limit (dBuV/m)	PK Margin (dB)	Azimuth (Degs)	Height (cm)	Polarity
1	* 2.484	36.33	Pk	32.3	-23.3	0	45.33	-	-	74	-28.67	212	376	V
3	* 2.484	26.97	RMS	32.3	-23.3	0	35.97	54	-18.03	-	-	212	376	V
2	2.513	38.92	Pk	32.4	-23.2	0	48.12	-	-	74	-25.88	212	376	V
4	2.555	28.54	RMS	32.3	-23.2	0	37.64	54	-16.36	-	-	212	376	V

* - indicates frequency in CFR47 Pt 15 / IC RSS-Restricted Band

Pk - Peak detector

RMS - RMS detection

HARMONICS AND SPURIOUS EMISSIONS

LOW CHANNEL RESULTS

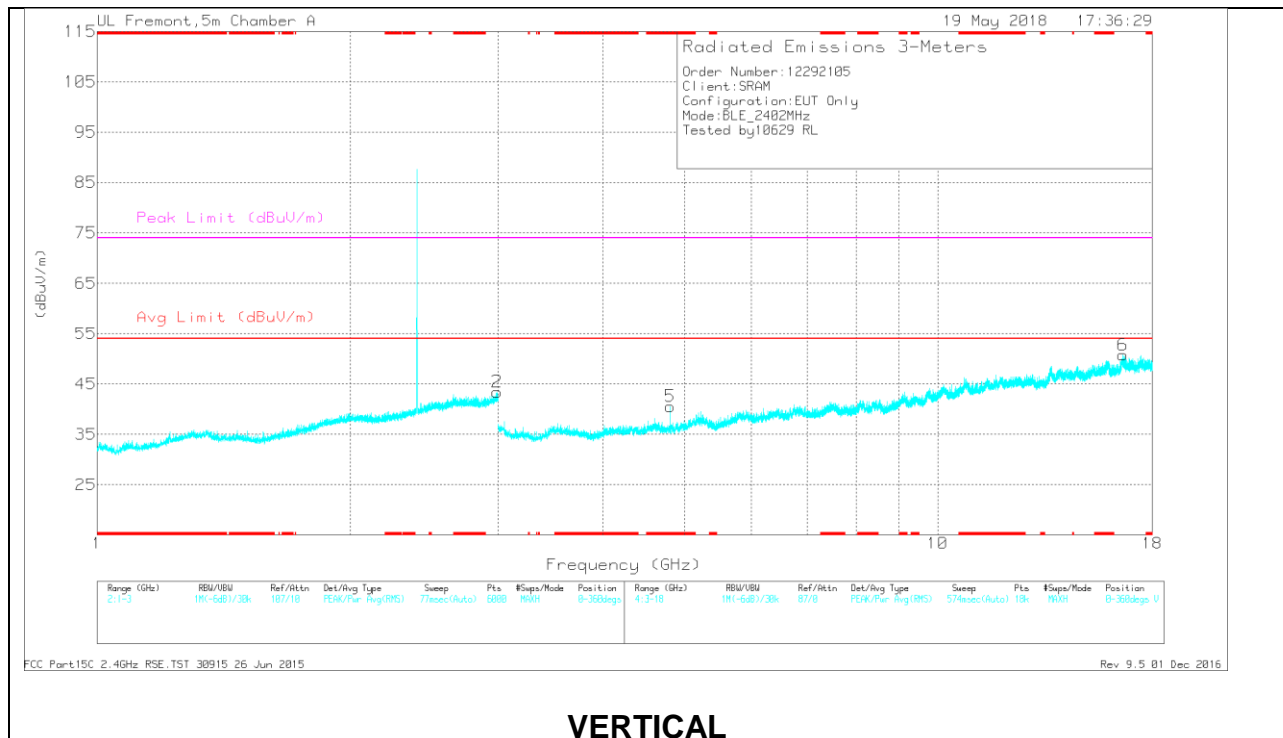
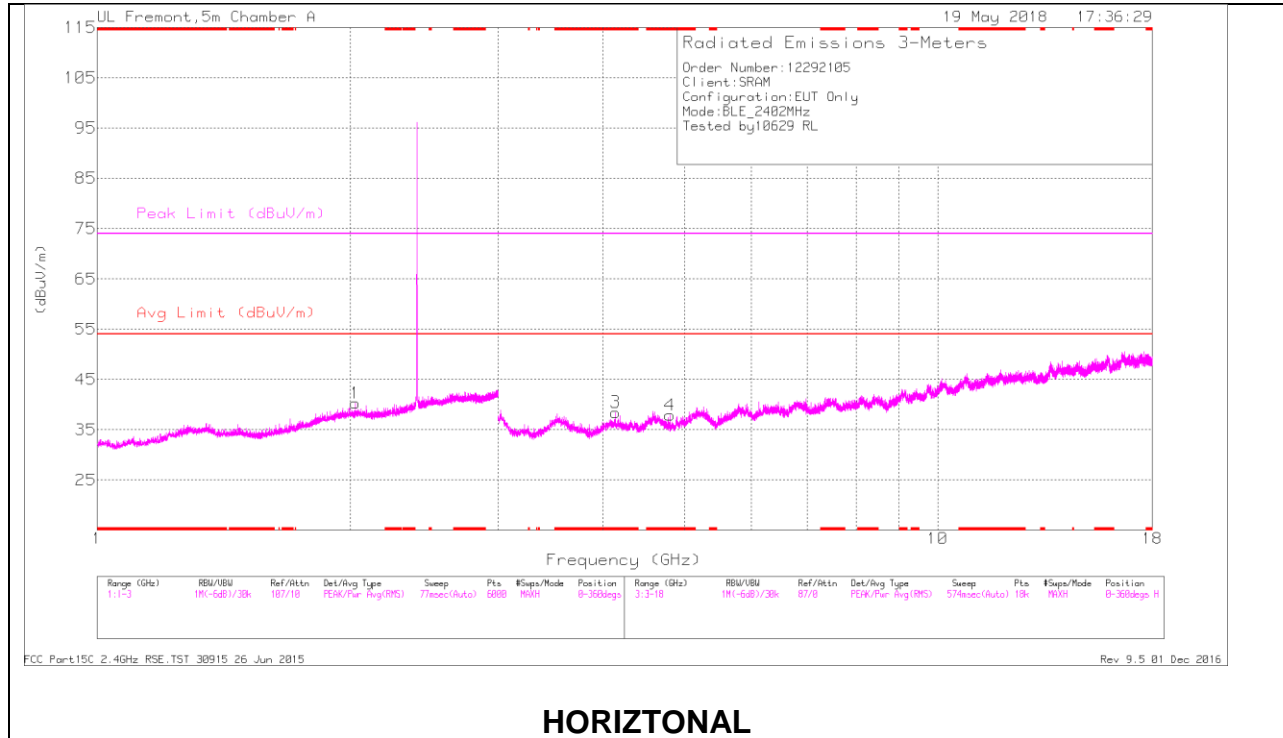

RADIATED EMISSIONS

Radiated Emissions

Marker	Frequency (GHz)	Meter Reading (dBuV)	Det	AF T862 (dB/m)	Amp/Cb/Fitr/ Pad (dB)	DC Corr (dB)	Corrected Reading (dBuV/m)	Avg Limit (dBuV/m)	Margin (dB)	Peak Limit (dBuV/m)	PK Margin (dB)	Azimuth (Degs)	Height (cm)	Polarity
3	* 4.803	38.74	PK2	34.2	-27.4	0	45.54	-	-	74	-28.46	100	102	H
	* 4.804	29.27	MAv1	34.2	-27.4	0	36.07	54	-17.93	-	-	100	102	H
4	* 4.139	35.78	PK2	33.4	-26.8	0	42.38	-	-	74	-31.62	267	111	H
	* 4.142	24.52	MAv1	33.4	-26.8	0	31.12	54	-22.88	-	-	267	111	H
5	* 4.804	39.53	PK2	34.2	-27.4	0	46.33	-	-	74	-27.67	289	235	V
	* 4.804	31.11	MAv1	34.2	-27.4	0	37.91	54	-16.09	-	-	289	235	V
1	2.03	32.26	Pk	31.4	-23.4	0	40.26	-	-	-	-	0-360	102	H
2	2.991	32.83	Pk	32.3	-21.7	0	43.43	-	-	-	-	0-360	101	V
6	16.61	26.46	Pk	41.4	-17.1	0	50.76	-	-	-	-	0-360	101	V

* - indicates frequency in CFR47 Pt 15 / IC RSS-Restricted Band

PK2 - KDB558074 Method: Maximum Peak

MAv1 - KDB558074 Option 1 Maximum RMS Average

MID CHANNEL RESULTS

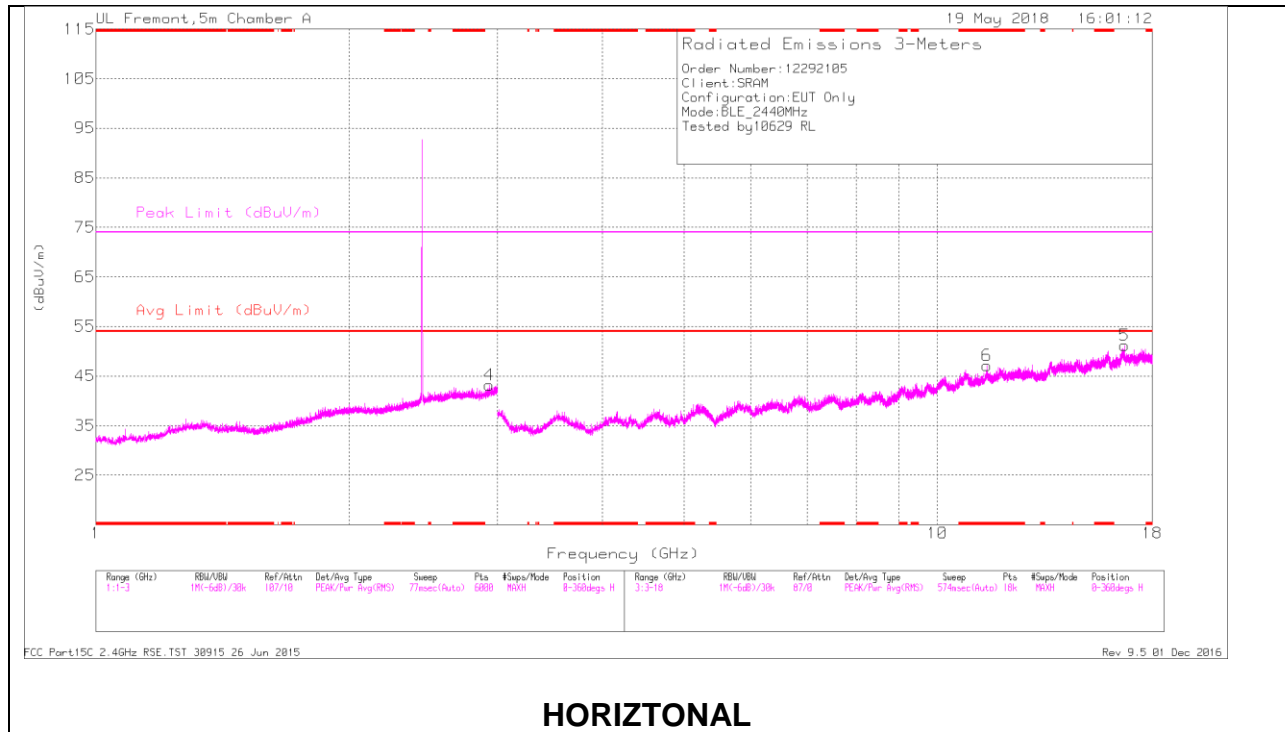

HORIZONTAL

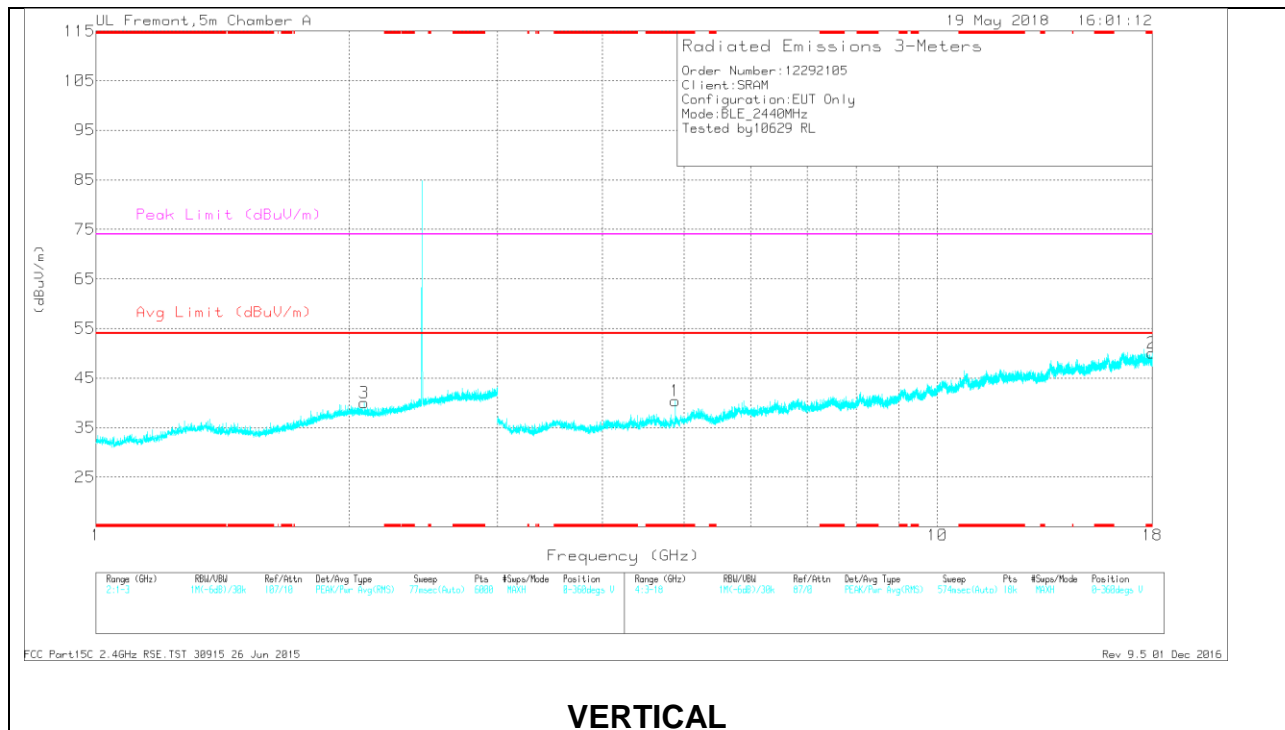

VERTICAL

RADIATED EMISSIONS

Radiated Emissions

Marker	Frequency (GHz)	Meter Reading (dBuV)	Det	AF T862 (dB/m)	Amp/Cb/Fitr/ Pad (dB)	DC Corr (dB)	Corrected Reading (dBuV/m)	Avg Limit (dBuV/m)	Margin (dB)	Peak Limit (dBuV/m)	PK Margin (dB)	Azimuth (Degs)	Height (cm)	Polarity
6	* 11.455	31.22	PK2	38.2	-17.8	0	51.62	-	-	74	-22.38	324	312	H
	* 11.454	20.8	MAv1	38.2	-17.8	0	41.2	54	-12.8	-	-	324	312	H
1	* 11.458	32.93	PK2	38.2	-17.9	0	53.23	-	-	74	-20.77	153	238	H
	* 11.451	20.99	MAv1	38.2	-17.9	0	41.29	54	-12.71	-	-	153	238	H
2	* 4.881	40.45	PK2	34.1	-26.7	0	47.85	-	-	74	-26.15	298	272	V
	* 4.88	32.12	MAv1	34.1	-26.7	0	39.52	54	-14.48	-	-	298	272	V
3	2.085	32.37	Pk	31.2	-23.5	0	40.07	-	-	-	-	0-360	101	V
4	2.934	32.94	Pk	32.2	-21.9	0	43.24	-	-	-	-	0-360	199	H
5	16.685	28.14	Pk	41.6	-18.5	0	51.24	-	-	-	-	0-360	101	H

* - indicates frequency in CFR47 Pt 15 / IC RSS-Restricted Band

PK2 - KDB558074 Method: Maximum Peak

MAv1 - KDB558074 Option 1 Maximum RMS Average

HIGH CHANNEL RESULTS

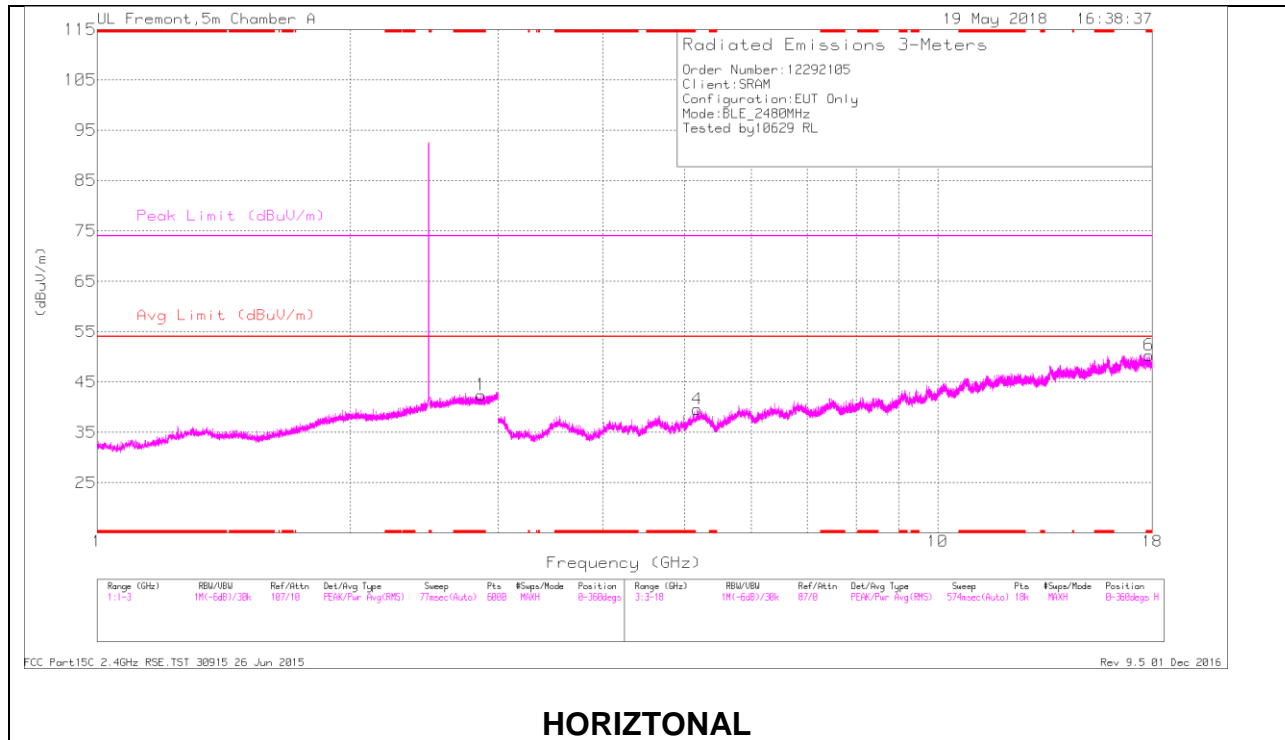

HORIZONTAL

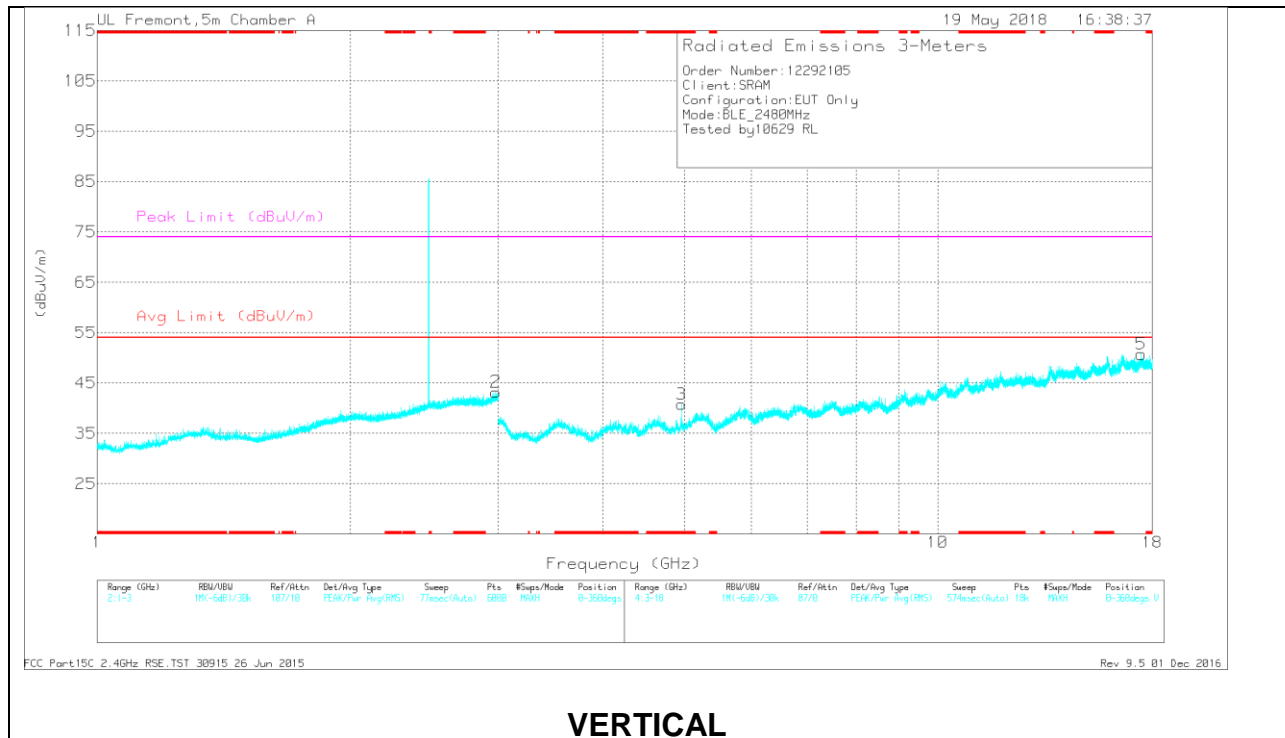

VERTICAL

RADIATED EMISSIONS

Radiated Emissions

Marker	Frequency (GHz)	Meter Reading (dBuV)	Det	AF T862 (dB/m)	Amp/Cb/Ftr/ Pad (dB)	DC Corr (dB)	Corrected Reading (dBuV/m)	Avg Limit (dBuV/m)	Margin (dB)	Peak Limit (dBuV/m)	PK Margin (dB)	Azimuth (Degs)	Height (cm)	Polarity
1	* 2.86	37	PK2	32.2	-22.1	0	47.1	-	-	74	-26.9	360	111	H
	* 2.861	25.99	MAv1	32.2	-22.1	0	36.09	54	-17.91	-	-	360	111	H
6	* 17.846	32.87	PK2	41.3	-18.3	0	55.87	-	-	74	-18.13	345	190	H
	* 17.841	22	MAv1	41.3	-18.4	0	44.9	54	-9.1	-	-	345	190	H
3	* 4.959	40.41	PK2	34.2	-27.4	0	47.21	-	-	74	-26.79	295	228	V
	* 4.96	31.96	MAv1	34.2	-27.4	0	38.76	54	-15.24	-	-	295	228	V
2	2.981	32.59	Pk	32.3	-21.7	0	43.19	-	-	-	-	0-360	101	V
4	5.179	30.2	Pk	34.4	-25	0	39.6	-	-	-	-	0-360	199	H
5	17.461	27.33	Pk	41.2	-17.8	0	50.73	-	-	-	-	0-360	101	V

* - indicates frequency in CFR47 Pt 15 / IC RSS-Restricted Band

PK2 - KDB558074 Method: Maximum Peak

MAv1 - KDB558074 Option 1 Maximum RMS Average

9.3. Worst Case Below 30MHz

FACE ON AND FACE OFF PLOTS

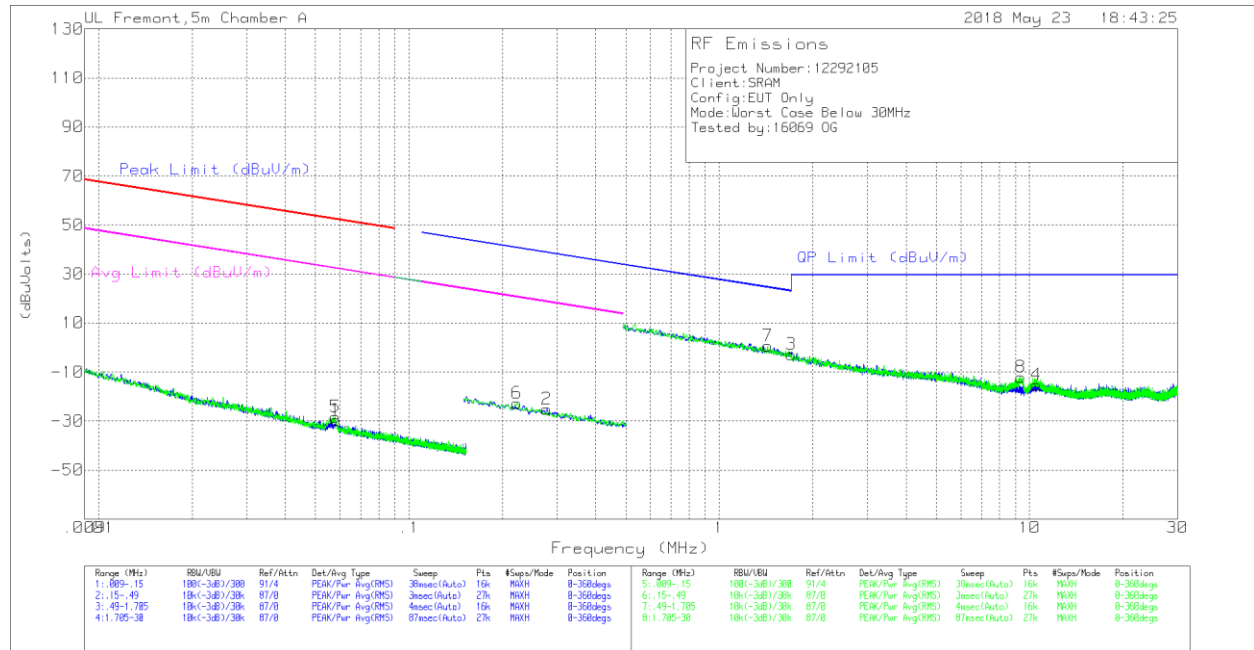

FCC 15.209 Below 30MHz TST 30915 22 Mar 2017

Rev 9.5 03 May 2018

NOTE: KDB 414788 OATS and Chamber Correlation Justification

- Based on FCC 15.31 (f) (2): measurements may be performed at a distance closer than that specified in the regulations; however, an attempt should be made to avoid making measurements in the near field.
- OATs and chamber correlation testing had been performed and chamber measured test result is the worst case test result.

Below 30MHz DATA

Marker	Frequency (MHz)	Meter Reading (dBuV)	Det	Loop Antenna (dB/m)	Cbl (dB)	Dist Corr 300m	Corrected Reading (dBuVolts)	Peak Limit (dBuV/m)	Margin (dB)	Avg Limit (dBuV/m)	Margin (dB)	Peak Limit (dBuV/m)	Margin (dB)	Avg Limit (dBuV/m)	Margin (dB)	Azimuth (Degs)
5	.05795	39.76	Pk	11.8	.1	-80	-28.34	52.32	-80.66	32.32	-60.66	-	-	-	-	0-360
1	.05812	38.34	Pk	11.8	.1	-80	-29.76	52.3	-82.06	32.3	-62.06	-	-	-	-	0-360
6	.22273	46.13	Pk	11	.1	-80	-22.77	-	-	-	-	40.66	-63.43	20.66	-43.43	0-360
2	.27858	43.93	Pk	10.9	.1	-80	-25.07	-	-	-	-	38.71	-63.78	18.71	-43.78	0-360

Pk - Peak detector

Marker	Frequency (MHz)	Meter Reading (dBuV)	Det	Loop Antenna (dB/m)	Cbl (dB)	Dist Corr 30m	Corrected Reading (dBuVolts)	QP Limit (dBuV/m)	Margin (dB)	Peak Limit (dBuV/m)	Margin (dB)	Avg Limit (dBuV/m)	Margin (dB)	Azimuth (Degs)
7	1.43358	29.13	Pk	11.3	.2	-40	.63	24.5	-23.87	-	-	-	-	0-360
3	1.70425	25.66	Pk	11.4	.2	-40	-2.74	23	-25.74	-	-	-	-	0-360
8	9.36798	16.47	Pk	11	.5	-40	-12.03	29.5	-41.53	-	-	-	-	0-360
4	10.53126	12.98	Pk	11.1	.5	-40	-15.42	29.5	-44.92	-	-	-	-	0-360

Pk - Peak detector

9.4. Worst Case Below 1 GHz

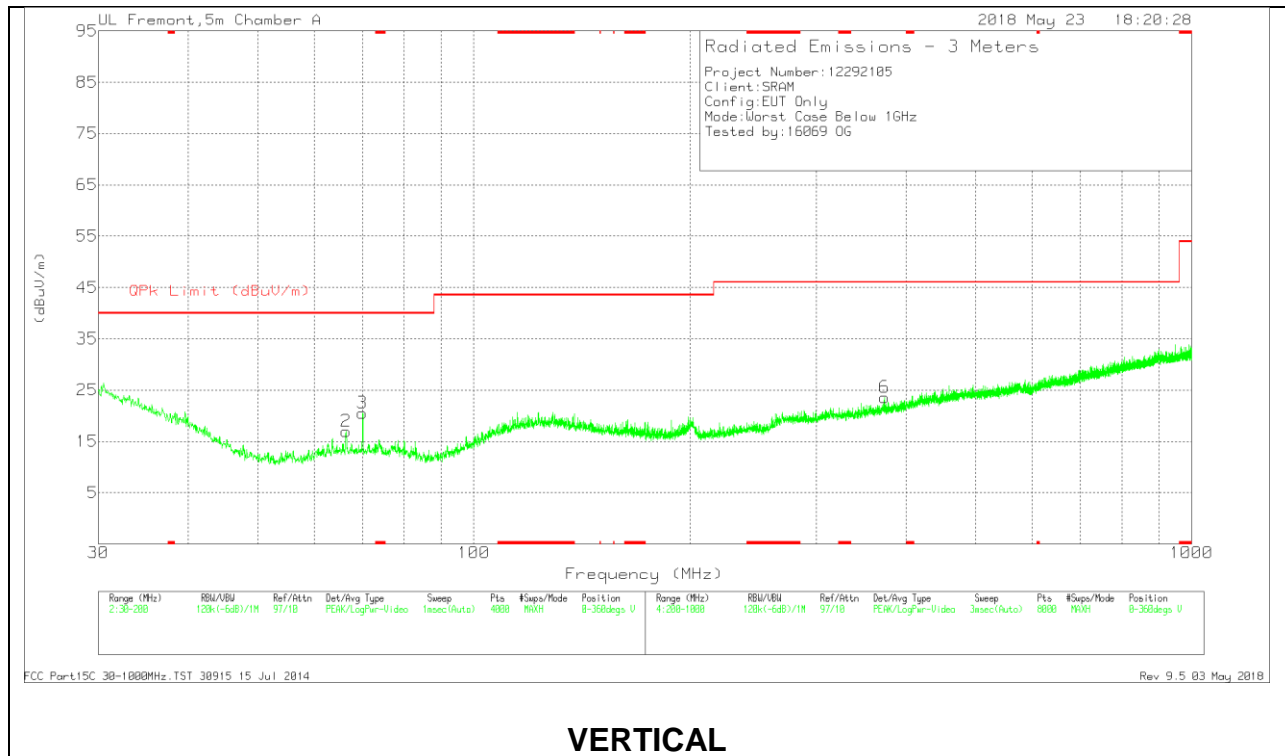
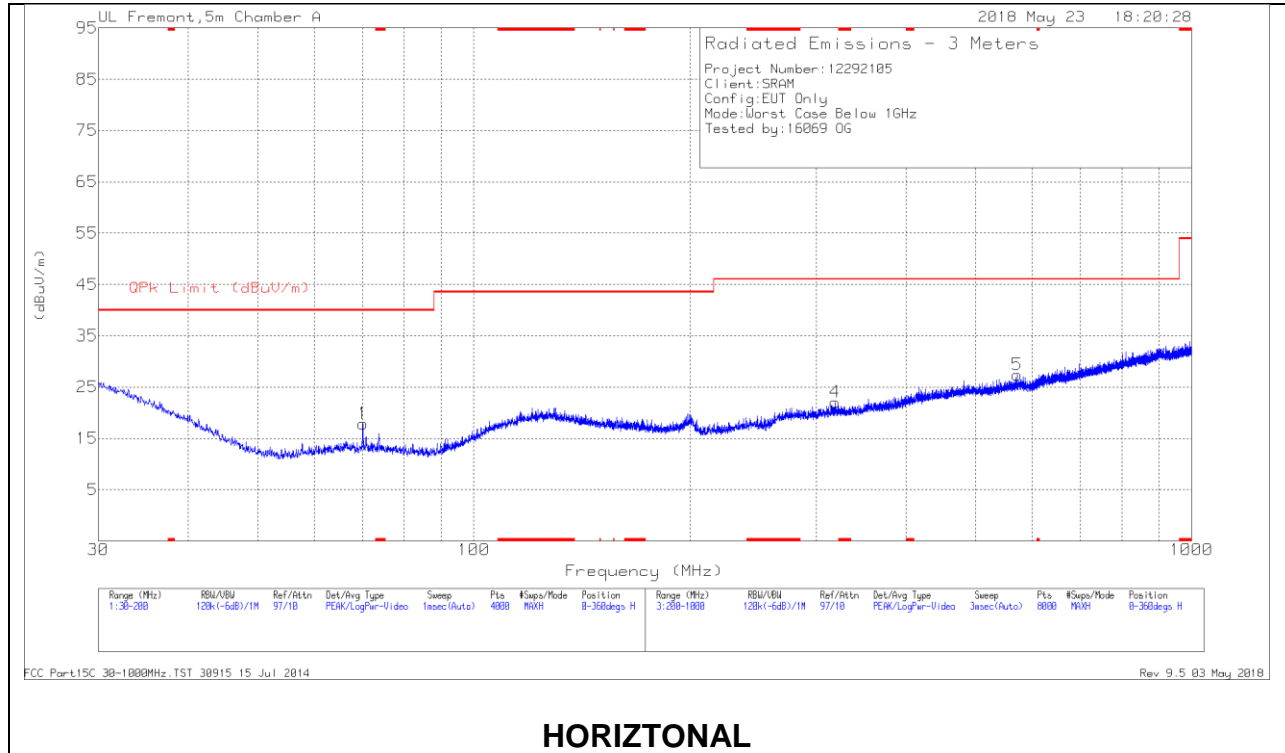

Below 1GHz Data

Marker	Frequency (MHz)	Meter Reading (dBuV)	Det	AF T130 (dB/m)	Amp/Cbl (dB/m)	Corrected Reading (dBuV/m)	QPk Limit (dBuV/m)	Margin (dB)	Azimuth (Degs)	Height (cm)	Polarity
2	66.3469	31.72	Pk	12.1	-26.8	17.02	40	-22.98	0-360	100	V
3	70.0029	35.08	Pk	12.1	-26.7	20.48	40	-19.52	0-360	100	V
1	70.0454	32.46	Pk	12.1	-26.7	17.86	40	-22.14	0-360	100	H
4	318.4154	28.7	Pk	17.9	-24.6	22	46.02	-24.02	0-360	400	H
6	373.1225	29.61	Pk	18.9	-24.9	23.61	46.02	-22.41	0-360	300	V
5	571.3483	29.96	Pk	22.6	-25.2	27.36	46.02	-18.66	0-360	200	H

* - indicates frequency in CFR47 Pt 15 / IC RSS-Restricted Band

Pk - Peak detector

9.5. Worst Case 18-26 GHz

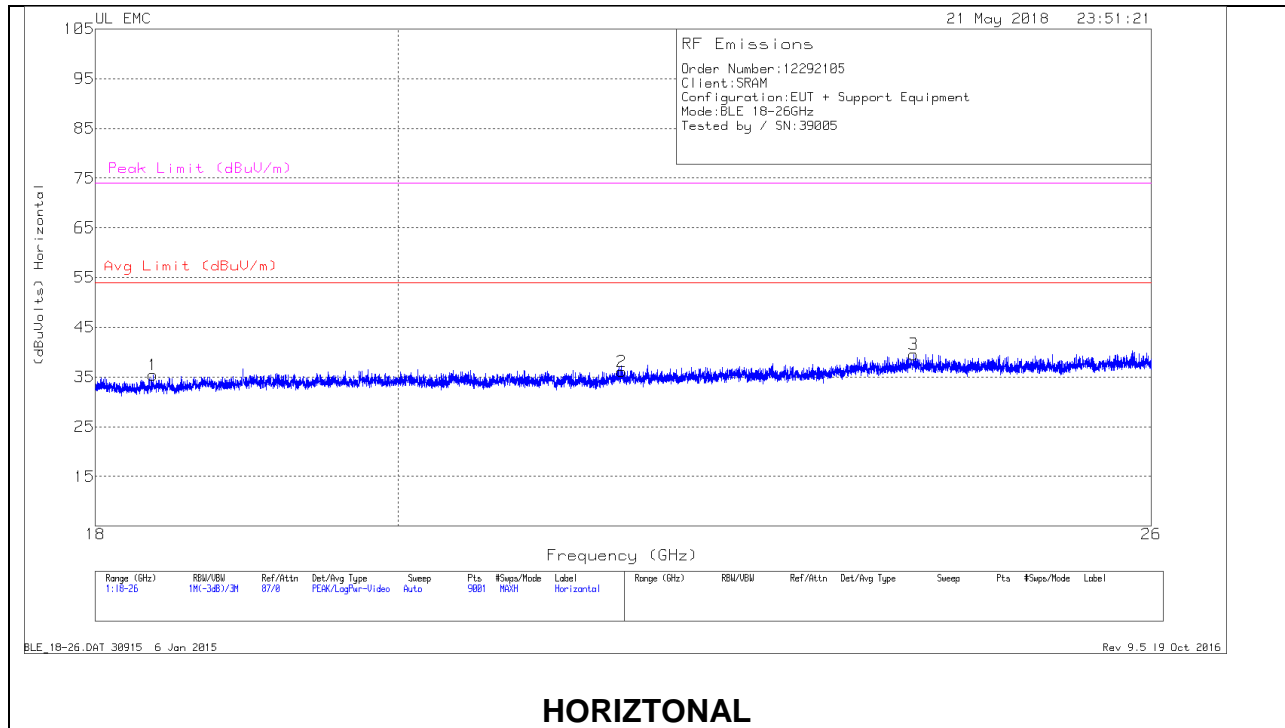

HORIZONTAL

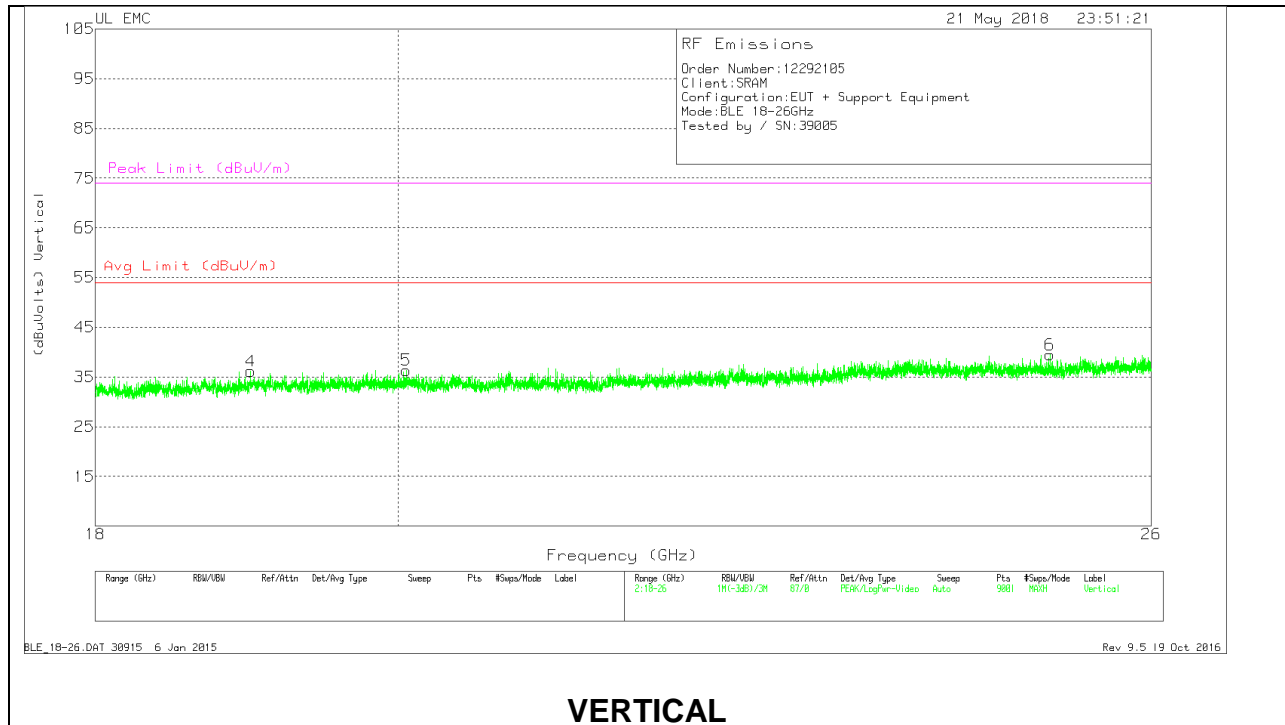

VERTICAL

18 – 26GHz DATA

Trace Markers

Marker	Frequency (GHz)	Meter Reading (dBuV)	Det	T449 AF (dB/m)	Amp/Cbl (dB)	Dist Corr (dB)	Corrected Reading (dBuVolts)	Avg Limit (dBuV/m)	Margin (dB)	Peak Limit (dBuV/m)	PK Margin (dB)
1	18.364	37.7	Pk	32.3	-25.1	-9.5	35.4	54	-18.6	74	-38.6
2	21.62	37.6	Pk	33.2	-25.2	-9.5	36.1	54	-17.9	74	-37.9
3	23.934	39.22	Pk	33.9	-24.1	-9.5	39.52	54	-14.48	74	-34.48
4	19	37.96	Pk	32.5	-24.8	-9.5	36.16	54	-17.84	74	-37.84
5	20.057	38.03	Pk	32.8	-25	-9.5	36.33	54	-17.67	74	-37.67
6	25.097	39.06	Pk	34.3	-24.4	-9.5	39.46	54	-14.54	74	-34.54

Pk - Peak detector