

TEST REPORT

Report Number: 14954500-E3V1

Applicant : SRAM LLC
1000 W Fulton Market 4th Floor
Chicago, IL 60607, United States

Model : 12300

Brand : SRAM

FCC ID : C9O-HKB1

IC : 10161A-HKB1

EUT Description : BICYCLE HEAD UNIT

Test Standard(s) : FCC 47 CFR PART 15 SUBPART C
ISED RSS-247 ISSUE 3
ISED RSS-GEN ISSUE 5 + A1 + A2

Date Of Issue:
2023-11-09

Prepared by:
UL VERIFICATION SERVICES
47173 Benicia Street
Fremont, CA 94538 U.S.A.
TEL: (510) 319-4000
FAX: (510) 661-0888



REPORT REVISION HISTORY

<u>Rev.</u>	<u>Issue Date</u>	<u>Revisions</u>	<u>Revised By</u>
V1	2023-11-09	Initial Issue	

TABLE OF CONTENTS

REPORT REVISION HISTORY	2
TABLE OF CONTENTS	3
1. ATTESTATION OF TEST RESULTS.....	5
2. TEST RESULTS SUMMARY	7
3. TEST METHODOLOGY	8
4. FACILITIES AND ACCREDITATION.....	8
5. DECISION RULES AND MEASUREMENT UNCERTAINTY.....	9
5.1. METROLOGICAL TRACEABILITY	9
5.2. DECISION RULES	9
5.3. MEASUREMENT UNCERTAINTY	9
5.4. SAMPLE CALCULATION.....	10
6. EQUIPMENT UNDER TEST	11
6.1. EUT DESCRIPTION.....	11
6.2. MAXIMUM OUTPUT POWER.....	11
6.3. DESCRIPTION OF AVAILABLE ANTENNAS.....	11
6.4. SOFTWARE AND FIRMWARE.....	11
6.5. WORST-CASE CONFIGURATION AND MODE.....	12
6.6. DESCRIPTION OF TEST SETUP.....	13
7. MEASUREMENT METHOD	15
8. TEST AND MEASUREMENT EQUIPMENT	16
9. ANTENNA PORT TEST RESULTS	17
9.1. ON TIME AND DUTY CYCLE	17
9.2. 99% BANDWIDTH.....	19
9.2.1. 802.11b MODE.....	20
9.2.2. 802.11g MODE.....	21
9.2.3. 802.11n HT20 MODE	22
9.2.4. 802.11n HT40 MODE	23
9.3. 6 dB BANDWIDTH	24
9.3.1. 802.11b MODE.....	25
9.3.2. 802.11g MODE.....	26
9.3.3. 802.11n HT20 MODE	27
9.3.4. 802.11n HT40 MODE	28

9.4.	<i>OUTPUT POWER</i>	29
9.4.1.	802.11b MODE.....	30
9.4.2.	802.11g MODE.....	31
9.4.3.	802.11n HT20 MODE	32
9.4.4.	802.11n HT40 MODE	33
9.5.	<i>POWER SPECTRAL DENSITY</i>	34
9.5.1.	802.11b MODE.....	35
9.5.2.	802.11g MODE.....	36
9.5.3.	802.11n HT20 MODE	37
9.5.4.	802.11n HT40 MODE	38
9.6.	<i>CONDUCTED SPURIOUS EMISSIONS</i>	39
9.6.1.	802.11b MODE.....	40
9.6.2.	802.11g MODE.....	41
9.6.3.	802.11n HT20 MODE	42
9.6.4.	802.11n HT40 MODE	43
10.	RADIATED TEST RESULTS	44
10.1.	<i>TRANSMITTER ABOVE 1 GHz</i>	46
10.1.1.	TX ABOVE 1 GHz 802.11b MODE IN THE 2.4 GHz BAND.....	46
10.1.2.	TX ABOVE 1 GHz 802.11g MODE IN THE 2.4 GHz BAND.....	56
10.1.3.	TX ABOVE 1 GHz 802.11n HT20 MODE IN THE 2.4 GHz BAND.....	66
10.1.4.	TX ABOVE 1 GHz 802.11n HT40 MODE IN THE 2.4 GHz BAND.....	77
10.2.	<i>WORST CASE BELOW 30MHz</i>	87
10.3.	<i>WORST CASE BELOW 1 GHz</i>	89
10.4.	<i>WORST CASE 18-26 GHz</i>	91
11.	AC POWER LINE CONDUCTED EMISSIONS	93
11.1.1.	AC Power Line Norm.....	94
12.	SETUP PHOTOS	96

1. ATTESTATION OF TEST RESULTS

COMPANY NAME: SRAM LLC
1000 W Fulton Market 4th Floor
Chicago, IL 60607, United States

EUT DESCRIPTION: Bicycle Head Unit

MODEL: 12300

BRAND: SRAM

SERIAL NUMBER: Radiated: 00416GA23270005 and 00416GA23270009
Conducted: 00413PA232960044 and 00413PA232960035

SAMPLE RECEIPT DATE: 2023-09-22 and 2023-09-28

DATE TESTED: 2023-09-29 to 2023-10-20

APPLICABLE STANDARDS	
STANDARD	TEST RESULTS
CFR 47 Part 15 Subpart C	Complies
ISED RSS-247 Issue 3	Complies
ISED RSS-GEN Issue 5 + A1 + A2	Complies

UL Verification Services Inc. tested the above equipment in accordance with the requirements set forth in the above standards. The test results show that the equipment tested is capable of demonstrating compliance with the requirements as documented in this report.

The results documented in this report apply only to the tested sample, under the conditions and modes of operation as described herein. It is the manufacturer's responsibility to assure that additional production units of this model are manufactured with identical electrical and mechanical components. All samples tested were in good operating condition throughout the entire test program. Measurement Uncertainties are published for informational purposes only and were not taken into account unless noted otherwise.

This document may not be altered or revised in any way unless done so by UL Verification Services Inc. and all revisions are duly noted in the revisions section. Any alteration of this document not carried out by UL Verification Services Inc. will constitute fraud and shall nullify the document. This report must not be used by the client to claim product certification, approval, or endorsement by A2LA, NIST, any agency of the Federal Government, or any agency of the U.S. government.

Approved & Released For
UL Verification Services Inc. By:



Dan Corona
Operations Leader
Consumer Technology Division
UL Verification Services Inc.

Prepared By:



Gerardo Abrego
Senior Test Engineer
Consumer Technology Division
UL Verification Services Inc.

1st Reviewed By:



Vien Tran
Senior Laboratory Engineer
Consumer Technology Division
UL Verification Services Inc.

2nd Reviewed By:



Kiya Kedida
Senior Project Engineer
Consumer Technology Division
UL Verification Services Inc.

2. TEST RESULTS SUMMARY

This report contains data provided by the customer which can impact the validity of results. UL Verification Services Inc. is only responsible for the validity of results after the integration of the data provided by the customer.

Below is a list of the data provided by the customer:

- 1) Antenna gain and type (see section 6.3)

FCC Clause	ISED Clause	Requirement	Result	Comment
See Comment		Duty Cycle	Reporting purposes only	ANSI C63.10 Section 11.6.
-	RSS-GEN 6.7	99% OBW	Reporting purposes only	ANSI C63.10 Section 6.9.3.
15.247 (a) (2)	RSS-247 5.2 (a)	6dB BW	Compliant	None.
15.247 (b) (3)	RSS-247 5.4 (d)	Output Power	Compliant	None.
See Comment		Average power	Reporting purposes only	Per ANSI C63.10, Section 11.9.2.3.2.
15.247 (e)	RSS-247 5.2 (b)	PSD	Compliant	None.
15.247 (d)	RSS-247 5.5	Conducted Spurious Emissions	Compliant	None.
15.209, 15.205	RSS-GEN 8.9, 8.10	Radiated Emissions	Compliant	None.
15.207	RSS-Gen 8.8	AC Mains Conducted Emissions	Compliant	None.

3. TEST METHODOLOGY

The tests documented in this report were performed in accordance with FCC CFR 47 Part 2, FCC CFR 47 Part 15, ANSI C63.10-2013, KDB 558074 D01 15.247 Meas Guidance v05, KDB 414788 D01 Radiated Test Site v01r01, RSS-GEN Issue 5 + A1 + A2, and RSS-247 Issue 3.

4. FACILITIES AND ACCREDITATION

UL Verification Services Inc. is accredited by A2LA, Certificate Number 0751.05, for all testing performed within the scope of this report. Testing was performed at the locations noted below.

	Address	ISED CABID	ISED Company Number	FCC Registration
<input checked="" type="checkbox"/>	Building 1: 47173 Benicia Street Fremont, CA 94538, U.S.A	US0104	2324A	550739
<input type="checkbox"/>	Building 2: 47266 Benicia Street Fremont, CA 94538, U.S.A	US0104	2324A	550739
<input checked="" type="checkbox"/>	Building 4: 47658 Kato Rd Fremont, CA 94538, U.S.A	US0104	2324A	550739

5. DECISION RULES AND MEASUREMENT UNCERTAINTY

5.1. METROLOGICAL TRACEABILITY

All test and measuring equipment utilized to perform the tests documented in this report are calibrated on a regular basis, with a maximum time between calibrations of one year or the manufacturers' recommendation, whichever is less, and where applicable is traceable to recognized national standards.

5.2. DECISION RULES

The Decision Rule is based on Simple Acceptance in accordance with ISO Guide 98-4:2012 Clause 8.2. (Measurement uncertainty is not taken into account when stating conformity with a specified requirement.)

5.3. MEASUREMENT UNCERTAINTY

Where relevant, the following measurement uncertainty levels have been estimated for tests performed on the apparatus:

PARAMETER	U _{Lab}
Radio Frequency (Spectrum Analyzer)	141.16 Hz
Occupied Bandwidth	1.22%
Power Spectral Density	2.47 dB
RF Power Measurement Direct Method Using Power Meter	1.3 dB (PK) / 0.45 dB (AV)
Unwanted Emissions, Conducted	1.94 dB
Worst Case Conducted Disturbance, 9kHz to 0.15 MHz	3.78 dB
Worst Case Conducted Disturbance, 0.15 to 30 MHz	3.40 dB
Worst Case Radiated Disturbance, 9kHz to 30 MHz	2.87 dB
Worst Case Radiated Disturbance, 30 to 1000 MHz	6.01 dB
Worst Case Radiated Disturbance, 1000 to 18000 MHz	4.73 dB
Worst Case Radiated Disturbance, 18000 to 26000 MHz	4.51 dB
Worst Case Radiated Disturbance, 26000 to 40000 MHz	5.29 dB
Time Domain Measurements	3.39%
Temperature	0.57°C
Humidity	3.39%
DC Supply Voltages	0.57%

Uncertainty figures are valid to a confidence level of 95%.

5.4. SAMPLE CALCULATION

RADIATED EMISSIONS

Where relevant, the following sample calculation is provided:

Field Strength (dBuV/m) = Measured Voltage (dBuV) + Antenna Factor (dB/m) + Cable Loss (dB) – Preamp Gain (dB)

$$36.5 \text{ dBuV} + 18.7 \text{ dB/m} + 0.6 \text{ dB} - 26.9 \text{ dB} = 28.9 \text{ dBuV/m}$$

MAINS CONDUCTED EMISSIONS

Where relevant, the following sample calculation is provided:

Final Voltage (dBuV) = Measured Voltage (dBuV) + Cable Loss (dB) + Limiter Factor (dB) + LISN Insertion Loss.

$$36.5 \text{ dBuV} + 0 \text{ dB} + 10.1 \text{ dB} + 0 \text{ dB} = 46.6 \text{ dBuV}$$

6. EQUIPMENT UNDER TEST

6.1. EUT DESCRIPTION

The EUT is a Bicycle Head Unit.

6.2. MAXIMUM OUTPUT POWER

The transmitter has a maximum average conducted output power as follows:

2.4GHz BAND

Frequency Range (MHz)	Mode	Output Power (dBm)	Output Power (mW)
1Tx			
2412 - 2462	802.11b	18.63	72.95
2412 - 2462	802.11g	16.49	44.57
2412 - 2462	802.11n HT20	13.39	21.83
2422 - 2452	802.11n HT40	15.71	37.24

6.3. DESCRIPTION OF AVAILABLE ANTENNAS

The antenna(s) gain and type, as provided by the manufacturer' are as follows:

The Qualcomm Radio utilizes a PIFA antenna, with a maximum gain of 2.08 dBi.

6.4. SOFTWARE AND FIRMWARE

The EUT firmware installed, and the test utility software used during testing was FVIN: H-2.0.

6.5. WORST-CASE CONFIGURATION AND MODE

Radiated emissions below 1GHz, above 18GHz, and power line conducted emission were performed with the EUT set to transmit at the channel with highest output power as worst-case scenario.

Band edge and radiated emissions between 1GHz and 18GHz were performed with the EUT set to transmit at the highest power on low, middle, and high channels.

The fundamental of the EUT was investigated in three orthogonal orientations X,Y,Z, it was determined that X orientation was worst-case orientation; therefore, all final radiated testing was performed with the EUT in X orientation.

Worst-case data rates as provided by the client were:

802.11b mode: 1 Mbps

802.11g mode: 6 Mbps

802.11n HT20mode: MCS0

802.11n HT40mode: MCS0

6.6. DESCRIPTION OF TEST SETUP

SUPPORT TEST EQUIPMENT						
Description	Manufacturer	Model	Serial Number	FCC ID/ DoC		
Laptop	Lenovo	ThinkPad P15s	F53D168E-F6F2-4FE5-92C6-008E22EB6B88	-		
Laptop AC/DC Adapter	Lenovo	ADLX65YCC2D	8SSA10R16875C2TJ	-		
I/O CABLES (CONDUCTED TEST)						
Cable No.	Port	# of Identical Ports	Connector Type	Cable Type	Cable Length (m)	Remarks
1	AC	1	2-Prong	Un-shielded	1	AC Mains to LT AC/DC Adapter
2	DC	1	DC	Un-shielded	1.5	AC/DC Adapter to Laptop
3	USB	1	USB A to USB C	Un-shielded	1	Laptop to EUT
4	SMA	1	SMA	Un-shielded	0.1	EUT to Spectrum Analyzer
5	AC	1	3-Prong	Un-shielded	1.5	AC Mains to Spectrum Analyzer
I/O CABLES (RADIATED TEST EMISSIONS)						
Cable No.	Port	# of Identical Ports	Connector Type	Cable Type	Cable Length (m)	Remarks
1	AC	1	2-Prong	Un-shielded	1	AC Mains to LT AC/DC Adapter
2	DC	1	DC	Un-shielded	1.5	AC/DC Adapter to Laptop
3	USB	1	USB A to USB C	Un-shielded	1	Laptop to EUT
4	AC	1	3-Prong	Un-shielded	1.5	AC Mains to Spectrum Analyzer

TEST SETUP

For the purposes of testing, the EUT is connected to a laptop via USB A to USB C for radiated emissions above 1GHz. The EUT is normally powered by a Li-Ion battery at 3.85V. The laptop is used for setting up purposes and was used during testing.

SETUP DIAGRAM

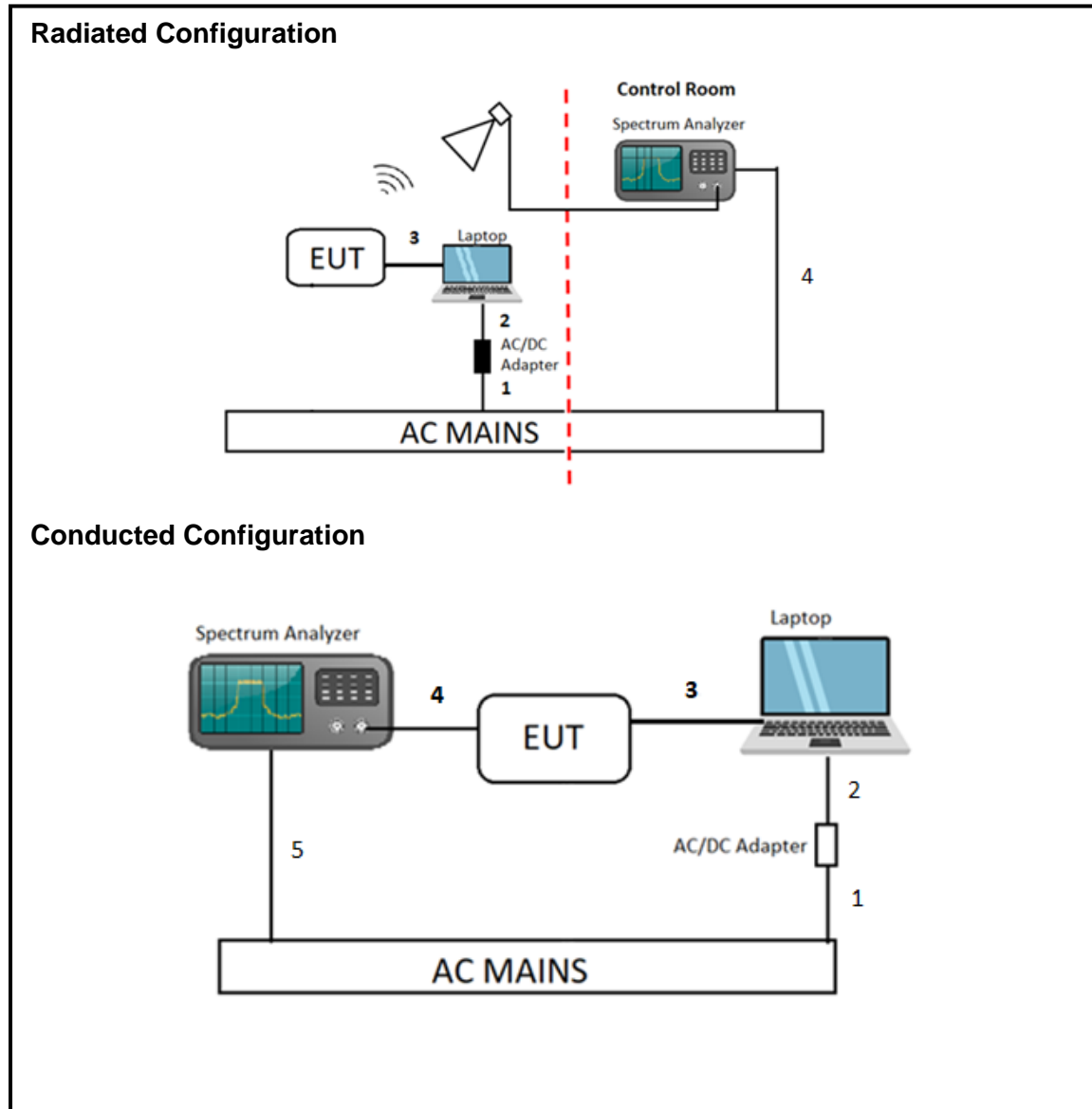

7. MEASUREMENT METHOD

On Time and Duty Cycle: ANSI C63.10 Section 11.6.

Occupied BW (99%): ANSI C63.10-2013 Section 6.9.3

6 dB BW: ANSI C63.10 Subclause -11.8.1 RBW \geq DTS BW

Output Power: ANSI C63.10 Subclause -11.9.2.3.2 Method AVGPM-G (Measurement using a gated RF average-reading power meter)

PSD: ANSI C63.10 Subclause -11.10.3 Method AVGPSD-1

Radiated emissions non-restricted frequency bands: ANSI C63.10 Subclause -11.11

Radiated emissions restricted frequency bands: ANSI C63.10 Subclause -11.12.1

Conducted emissions in restricted frequency bands: ANSI C63.10 Subclause -11.12.2

Band-edge: ANSI C63.10 Subclause -11.13.3.2 Integration method -Peak detection

Band-edge: ANSI C63.10 Subclause -11.13.3.3 Integration method -Trace averaging with continuous transmission at full power

Band-edge: ANSI C63.10 Subclause -11.13.3.4 Integration method -Trace averaging across ON and OFF times DC correction

AC Power Line Conducted Emissions: ANSI C63.10-2013, Section 6.2.

Radiated Spurious Emissions Below 30MHz: ANSI C63.10-2013 Section 6.4

8. TEST AND MEASUREMENT EQUIPMENT

The following test and measurement equipment was utilized for the tests documented in this report:

TEST EQUIPMENT LIST					
Description	Manufacturer	Model	ID Num	Cal Due	Last Cal
Antenna, Broadband Hybrid, 30MHz to 3000MHz	Sunol Sciences Corp.	JB3	232075	2024-03-31	2023-03-13
Amplifier, 9KHz to 1GHz, 32dB	SONOMA INSTRUMENT	310	175953	2024-03-31	2023-03-03
Antenna, Horn 1-18GHz	ETS-Lindgren (Cedar Park, Texas)	3117	223083	2023-10-25	2022-10-25
RF Filter Box, 1-18GHz, 8 Port	UL-FR1	SAC 8 port rf box 1	197920	2024-05-31	2023-05-17
Antenna, Horn 18 to 26.5GHz	A.R.A	MWH-1826/B	199659	2023-12-06	2022-02-06
Amplifier 18-26.5GHz, +5Vdc, 60dB min	AMPLICAL	AMP18G26.5-60	234683	2024-03-29	2023-03-18
Antenna, Horn 26.5 to 40GHz	A.R.A.	MWH-2640/B	199661	2023-12-06	2022-12-06
RF Amplifier Assembly, 26-40GHz, 60dB Gain	AMPLICAL	AMP26G40-60	234684	2024-03-29	2023-03-18
Antenna, Passive Loop 30Hz - 1MHz	ELECTRO METRICS	EM-6871	170013	2024-07-31	2023-07-28
Antenna, Passive Loop 100KHz - 30MHz	ELECTRO METRICS	EM-6872	170015	2024-07-31	2023-07-28
Spectrum Analyzer, PSA, 3Hz to 44GHz	Agilent Technologies	N9030A	80396	2024-01-31	2023-01-27
EMI TEST RECEIVER	Rohde & Schwarz	ESW44	225688	2024-02-29	2023-02-14
Power Meter, P-series single channel	Keysight Technologies Inc	N1911A	90754	2024-01-25	2023-01-25
Power Sensor, P - series, 50MHz to 18GHz, Wideband	Keysight Technologies Inc	N1921A	81319	2024-01-31	2023-01-25
10dB Fixed Attenuator	Pasternack Enterprises	PE7087-10	N/A	Verified	Verified
AC Line Conducted					
EMI Test Receiver 9kHz-7GHz	Rohde & Schwarz	ESR	93091	2024-02-29	2023-02-29
LISN for Conducted Emissions CISPR-16	FISCHER CUSTOM COMMUNICATIONS	FCC-LISN-50/250-25-2-01-480V	175764	2024-01-31	2023-01-31
Transient Limiter	TE	TBFL1	207996	2024-08-31	2023-08-31
UL TEST SOFTWARE LIST					
Radiated Software	UL	UL EMC	Version 9.5, 01 May 2023-01-05		
Conducted Software	UL	UL EMC	2022-08-16		
AC Line Conducted Software	UL	UL EMC	Version 9.5, 2023-03-03		

NOTES:

1. Equipment listed above that calibrated during the testing period was set for test after the calibration.
2. Equipment listed above that has a calibration due date during the testing period, the testing is completed before equipment expiration date.

9. ANTENNA PORT TEST RESULTS

9.1. ON TIME AND DUTY CYCLE

LIMITS

None; for reporting purposes only.

PROCEDURE

KDB 558074 Zero-Span Spectrum Analyzer Method.

ON TIME AND DUTY CYCLE RESULTS

Mode	ON Time B (msec)	Period (msec)	Duty Cycle x (linear)	Duty Cycle (%)	Duty Cycle Correction Factor (dB)	1/B Minimum VBW (kHz)
2.4GHz Band						
802.11b 1TX	12.430	12.540	0.991	99.12	0.00	0.010
802.11g 1TX	2.064	2.101	0.982	98.24	0.00	0.010
802.11n HT20 1TX	1.924	1.961	0.981	98.11	0.00	0.010
802.11n HT40 1TX	0.948	0.999	0.949	94.89	0.23	1.055



DUTY CYCLE 802.11b 1TX MODE



DUTY CYCLE 802.11g 1TX MODE



DUTY CYCLE 802.11n HT20 1TX MODE



DUTY CYCLE 802.11n HT40 1TX MODE

9.2. 99% BANDWIDTH

LIMITS

None; for reporting purposes only.

RESULTS

9.2.1. 802.11b MODE

1TX Antenna 1 MODE

Channel	Frequency (MHz)	99% Bandwidth (MHz)
Low 1	2412	13.777
Mid 6	2437	13.509
High 11	2462	13.939

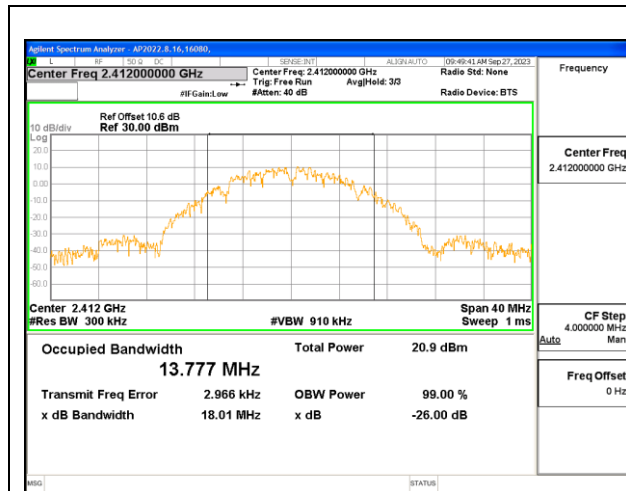

LOW CHANNEL 1

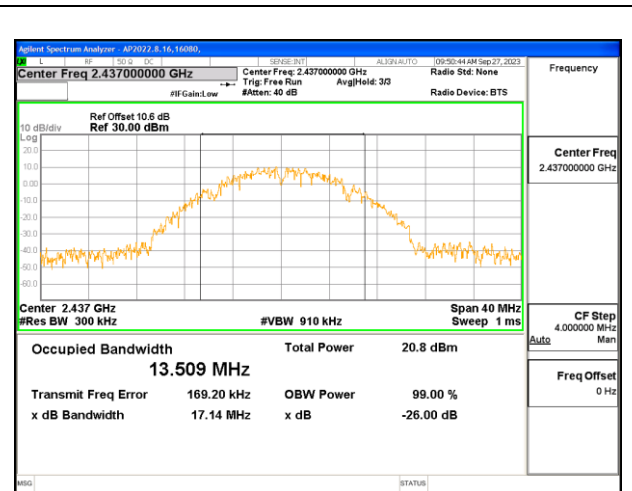

MID CHANNEL 6

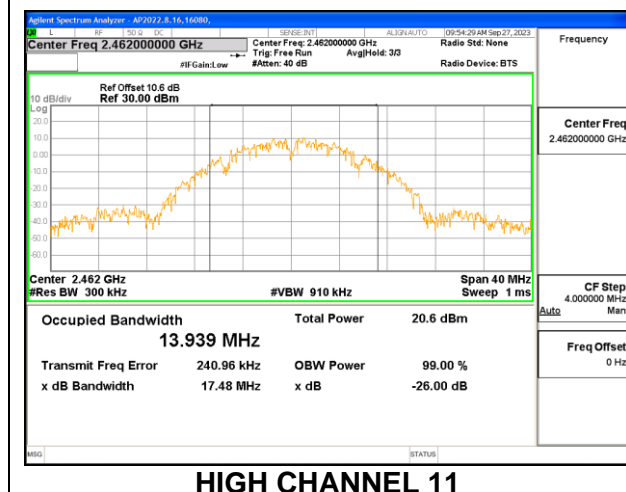

HIGH CHANNEL 11

9.2.2. 802.11g MODE

1TX Antenna 1 MODE

Channel	Frequency (MHz)	99% Bandwidth (MHz)
Low 1	2412	16.577
Mid 6	2437	16.394
High 11	2462	16.517

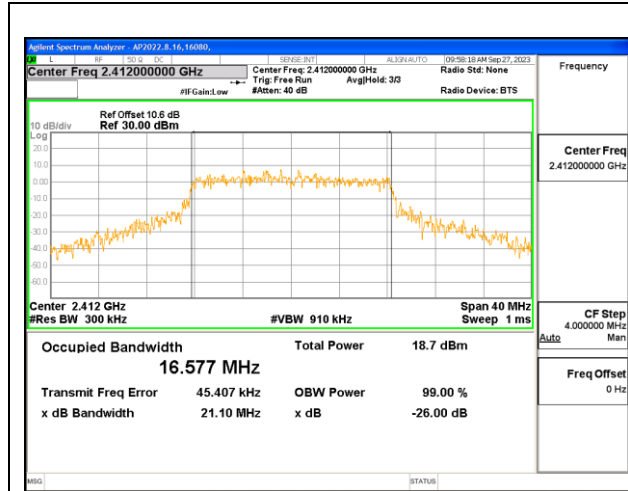

LOW CHANNEL 1

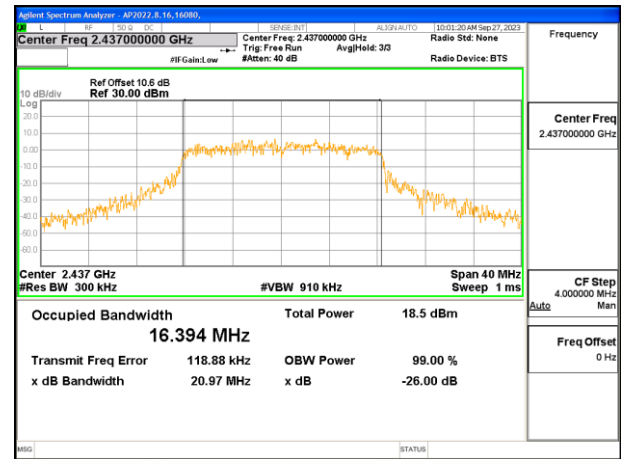

MID CHANNEL 6

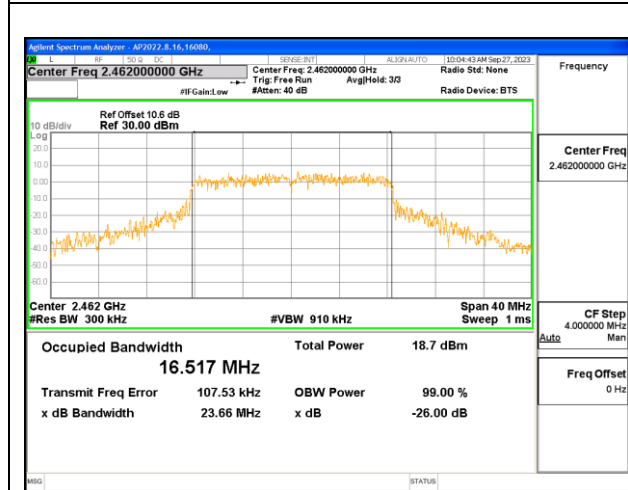

HIGH CHANNEL 11

9.2.3. 802.11n HT20 MODE

1TX Antenna 1 MODE

Channel	Frequency (MHz)	99% Bandwidth (MHz)
Low 1	2412	17.750
Mid 6	2437	17.632
High 11	2462	17.750

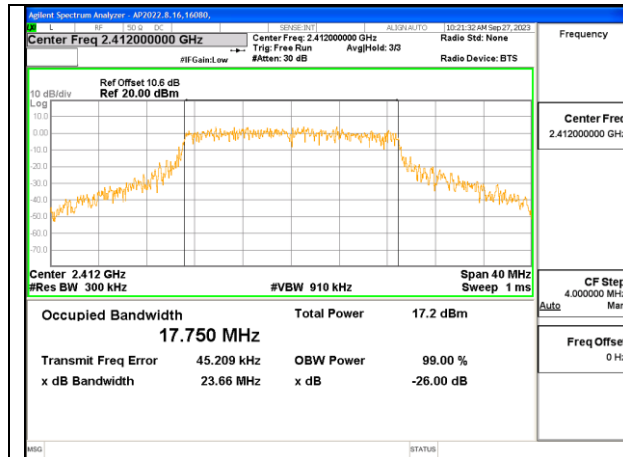

LOW CHANNEL 1

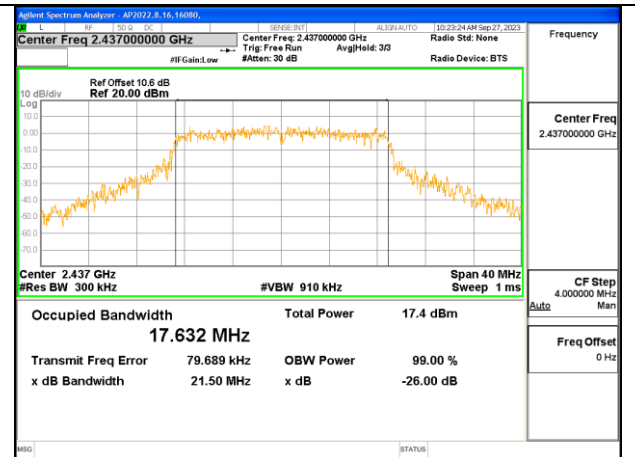

MID CHANNEL 6

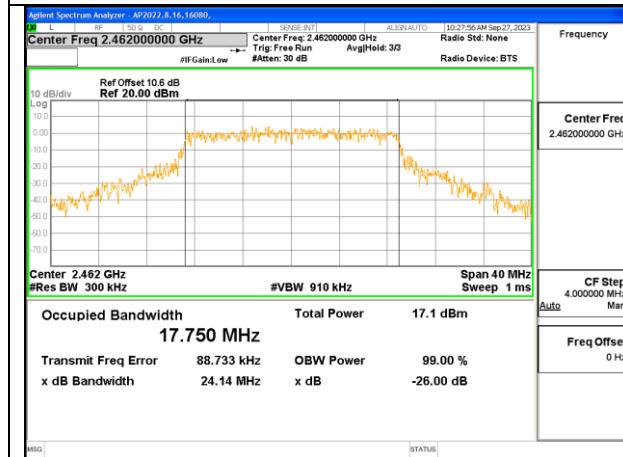

HIGH CHANNEL 11

9.2.4. 802.11n HT40 MODE

1TX Antenna 1 MODE

Channel	Frequency (MHz)	99% Bandwidth (MHz)
Low 3	2422	36.272
Mid 6	2437	36.038
High 9	2452	36.207

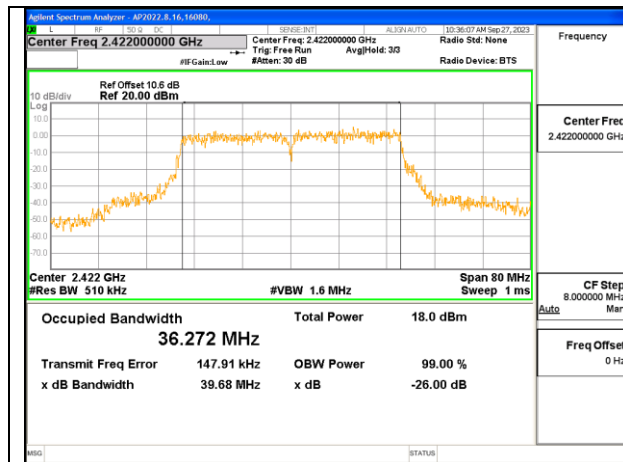

LOW CHANNEL 3

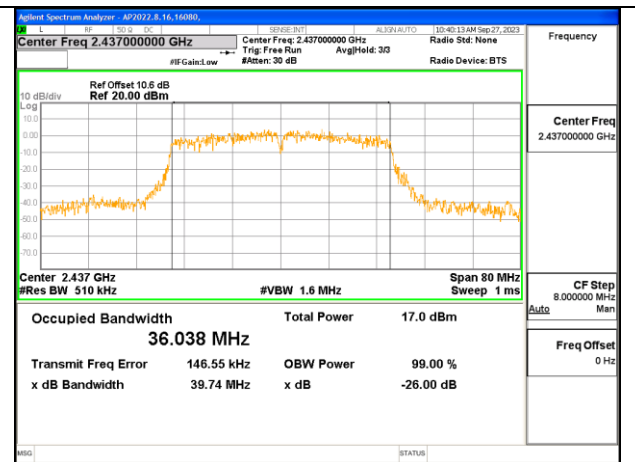

MID CHANNEL 6

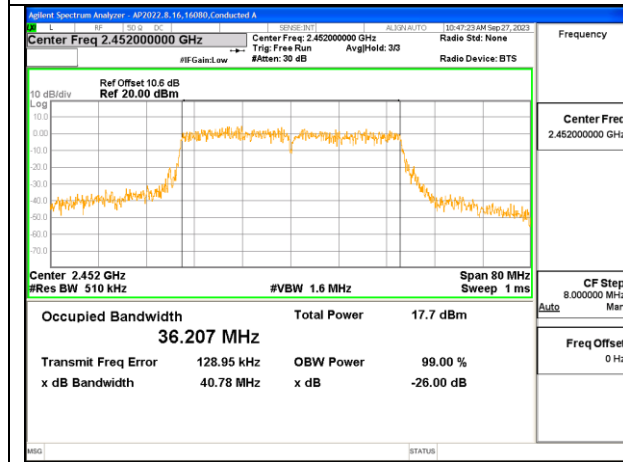

HIGH CHANNEL 9

9.3. 6 dB BANDWIDTH

LIMITS

FCC §15.247 (a) (2)

RSS-247 5.2 (a)

The minimum 6 dB bandwidth shall be at least 500 kHz.

RESULTS

9.3.1. 802.11b MODE

1TX Antenna 1 MODE

Channel	Frequency (MHz)	6 dB Bandwidth (MHz)	Minimum Limit (MHz)
Low 1	2412	8.20	0.5
Mid 6	2437	7.96	0.5
High 11	2462	8.68	0.5

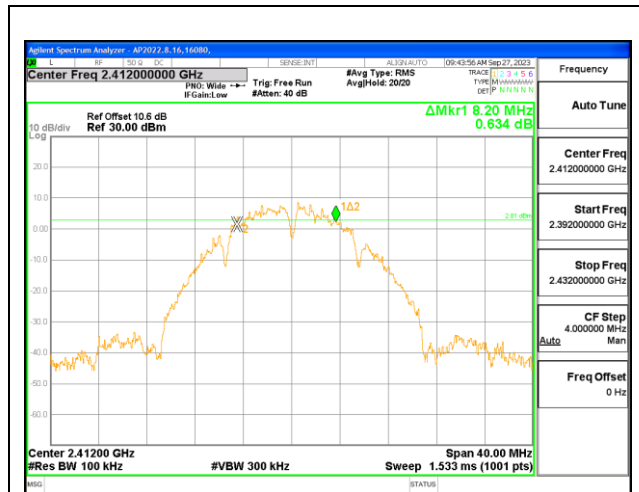

LOW CHANNEL 1

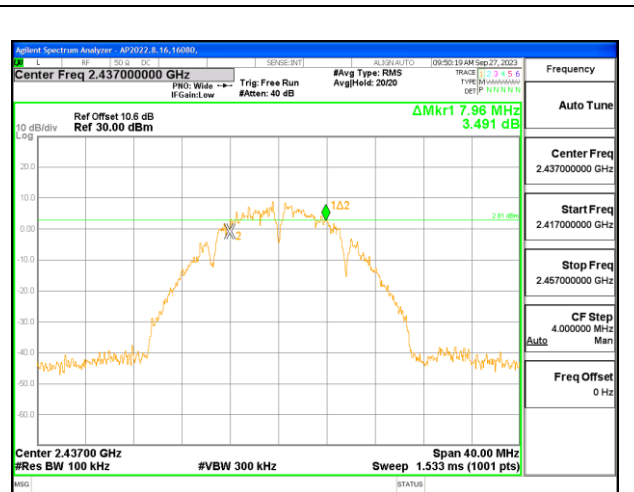

MID CHANNEL 6

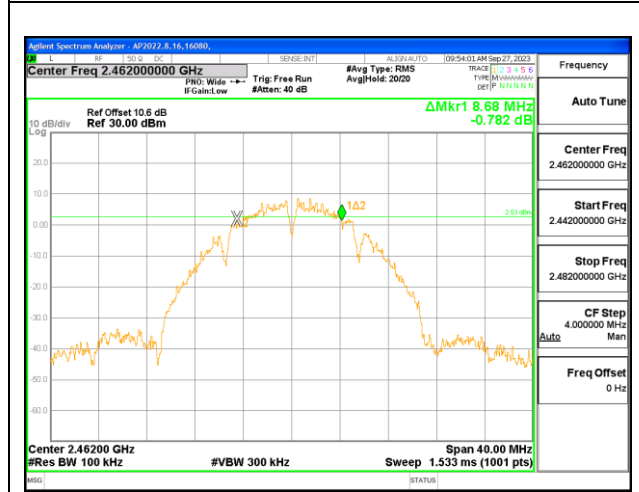

HIGH CHANNEL 11

9.3.2. 802.11g MODE

1TX Antenna 1 MODE

Channel	Frequency	6 dB Bandwidth	Minimum Limit
	(MHz)	(MHz)	(MHz)
Low 1	2412	16.44	0.5
Mid 6	2437	16.40	0.5
High 11	2462	16.52	0.5

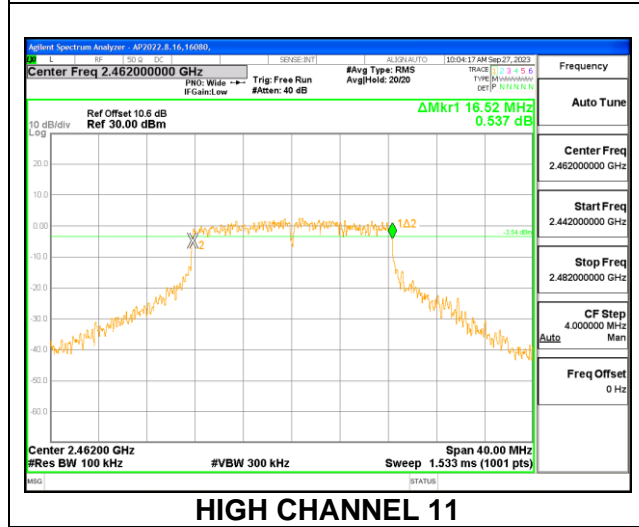
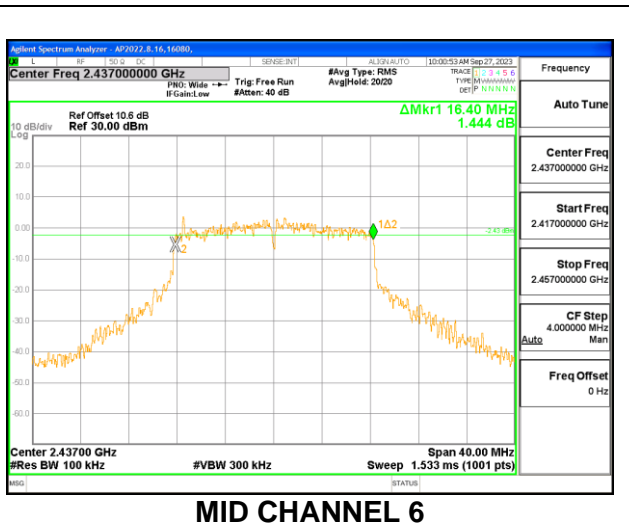
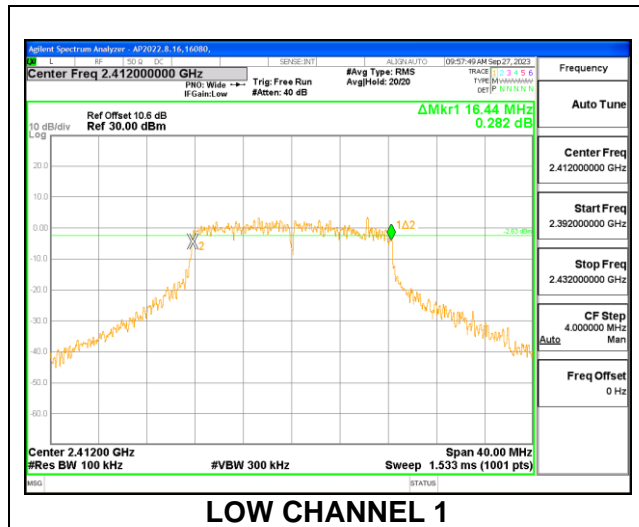

9.3.3. 802.11n HT20 MODE

1TX Antenna 1 MODE

Channel	Frequency (MHz)	6 dB Bandwidth (MHz)	Minimum Limit (MHz)
Low 1	2412	17.68	0.5
Mid 6	2437	17.28	0.5
High 11	2462	17.72	0.5

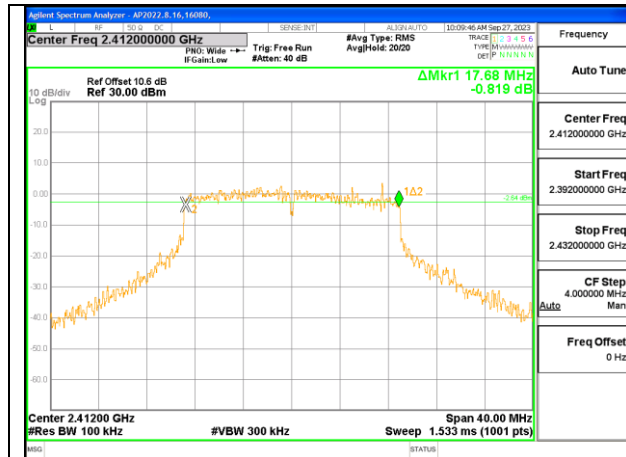

LOW CHANNEL 1

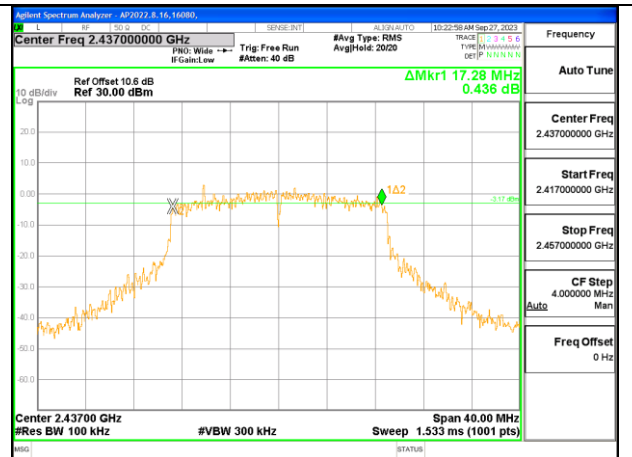

MID CHANNEL 6

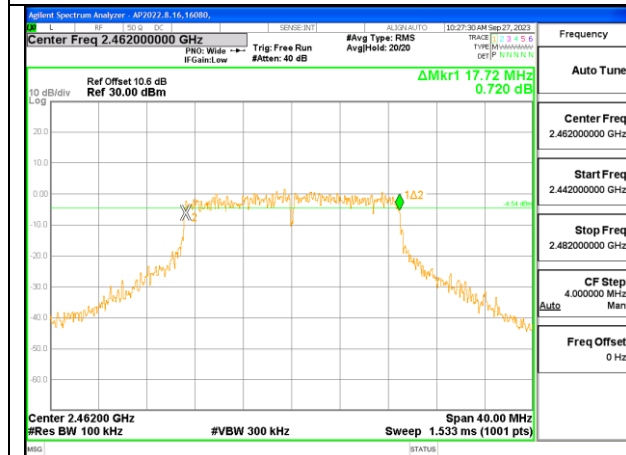

HIGH CHANNEL 11

9.3.4. 802.11n HT40 MODE

1TX Antenna 1 MODE

Channel	Frequency (MHz)	6 dB Bandwidth (MHz)	Minimum Limit (MHz)
Low 3	2422	36.24	0.5
Mid 6	2437	35.28	0.5
High 9	2452	36.48	0.5

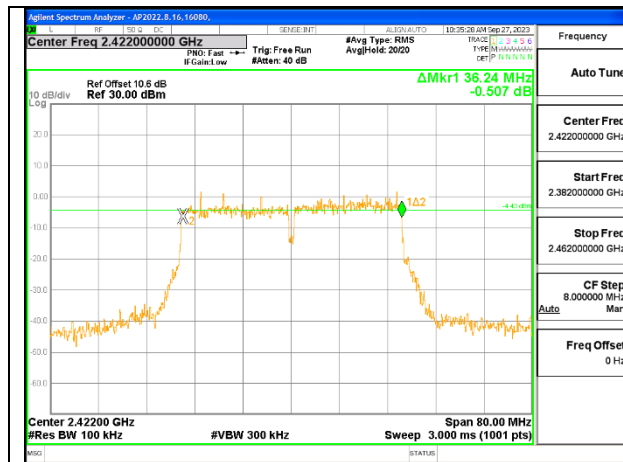

LOW CHANNEL 3

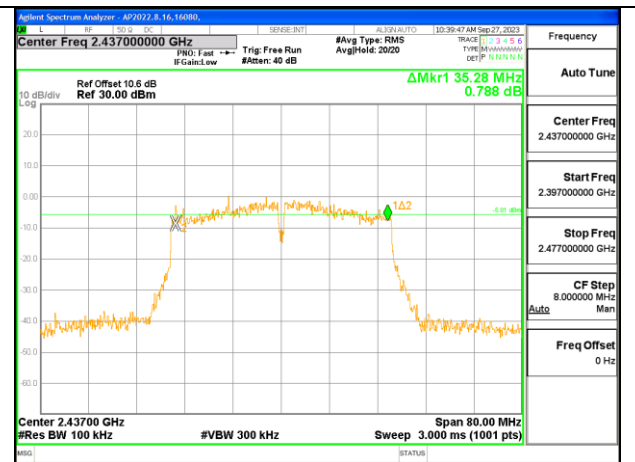

MID CHANNEL 6

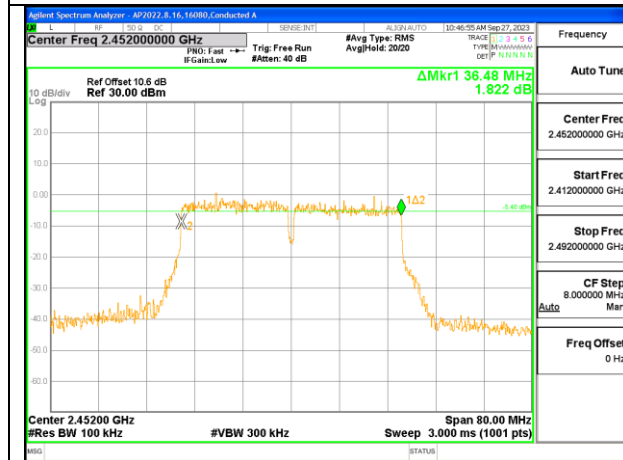

HIGH CHANNEL 9

9.4. OUTPUT POWER

LIMITS

FCC §15.247 (b) (3)

RSS-247 5.4 (d)

For systems using digital modulation in the 902–928 MHz, 2400–2483.5 MHz, and 5725–5850 MHz bands: 1 Watt, based on the use of antennas with directional gains that do not exceed 6 dBi. If transmitting antennas of directional gain greater than 6 dBi are used, the conducted output power from the intentional radiator shall be reduced by the amount in dB that the directional gain of the antenna exceeds 6 dBi.

TEST PROCEDURE

The transmitter output is connected to a power meter.

The power output was measured on the EUT antenna port using SMA cable with 10dB attenuator connected to a power meter via wideband power sensor. Gated average output power was read directly from the power meter.

DIRECTIONAL ANTENNA GAIN

For 1 TX:

There is only one transmitter output therefore the directional gain is equal to the antenna gain.

RESULTS

9.4.1. 802.11b MODE

1TX Antenna 1 MODE

Test Engineer:	ZS 16080
Test Date:	2023-09-27

Limits

Channel	Frequency (MHz)	Directional Gain (dBi)	FCC Power Limit (dBm)	ISED Power Limit (dBm)	ISED EIRP Limit (dBm)	Max Power (dBm)
Low 1	2412	2.08	30.00	30	36	30.00
Mid 6	2437	2.08	30.00	30	36	30.00
High 11	2462	2.08	30.00	30	36	30.00

Results

Channel	Frequency (MHz)	Meas Power (dBm)	Total Corr'd Power (dBm)	Power Limit (dBm)	Margin (dB)
Low 1	2412	18.63	18.63	30.00	-11.37
Mid 6	2437	18.57	18.57	30.00	-11.43
High 11	2462	18.53	18.53	30.00	-11.47

9.4.2. 802.11g MODE

1TX Antenna 1 MODE

Test Engineer:	ZS 16080
Test Date:	2023-09-27

Limits

Channel	Frequency (MHz)	Directional Gain (dBi)	FCC Power Limit (dBm)	ISED Power Limit (dBm)	ISED EIRP Limit (dBm)	Max Power (dBm)
Low 1	2412	2.08	30.00	30	36	30.00
Mid 6	2437	2.08	30.00	30	36	30.00
High 11	2462	2.08	30.00	30	36	30.00

Results

Channel	Frequency (MHz)	Meas Power (dBm)	Total Corr'd Power (dBm)	Power Limit (dBm)	Margin (dB)
Low 1	2412	16.42	16.42	30.00	-13.58
Mid 6	2437	16.49	16.49	30.00	-13.51
High 11	2462	16.49	16.49	30.00	-13.51

9.4.3. 802.11n HT20 MODE

1TX Antenna 1 MODE

Test Engineer:	ZS 16080
Test Date:	2023-09-27

Limits

Channel	Frequency (MHz)	Directional Gain (dBi)	FCC Power Limit (dBm)	ISED Power Limit (dBm)	ISED EIRP Limit (dBm)	Max Power (dBm)
Low 1	2412	2.08	30.00	30	36	30.00
Mid 6	2437	2.08	30.00	30	36	30.00
High 11	2462	2.08	30.00	30	36	30.00

Results

Channel	Frequency (MHz)	Meas Power (dBm)	Total Corr'd Power (dBm)	Power Limit (dBm)	Margin (dB)
Low 1	2412	13.32	13.32	30.00	-16.68
Mid 6	2437	13.39	13.39	30.00	-16.61
High 11	2462	12.72	12.72	30.00	-17.28

9.4.4. 802.11n HT40 MODE

1TX Antenna 1 MODE

Test Engineer:	ZS 16080
Test Date:	2023-09-27

Limits

Channel	Frequency (MHz)	Directional Gain (dBi)	FCC Power Limit (dBm)	ISED Power Limit (dBm)	ISED EIRP Limit (dBm)	Max Power (dBm)
Low 3	2422	2.08	30.00	30	36	30.00
Mid 6	2437	2.08	30.00	30	36	30.00
High 9	2452	2.08	30.00	30	36	30.00

Results

Channel	Frequency (MHz)	Meas Power (dBm)	Total Corr'd Power (dBm)	Power Limit (dBm)	Margin (dB)
Low 3	2412	15.71	15.71	30.00	-14.29
Mid 6	2437	15.16	15.16	30.00	-14.84
High 9	2462	14.71	14.71	30.00	-15.29

9.5. POWER SPECTRAL DENSITY

LIMITS

FCC §15.247 (e)

RSS-247 (5.2) (b)

The power spectral density conducted from the transmitter to the antenna shall not be greater than 8 dBm in any 3 kHz band during any time interval of continuous transmission.

RESULTS

RBW setting used 30kHz according to ANSI 63.10, Section 11.10.3 Method AVGPS-1

9.5.1. 802.11b MODE

1TX Antenna 1 MODE

Duty Cycle CF (dB)	0.00	Included in Calculations of Corr'd PSD
---------------------------	------	---

PSD Results

Channel	Frequency (MHz)	Chain 0 Meas (dBm/30kHz)	Total Corr'd PSD (dBm/30kHz)	Limit (dBm/30kHz)	Margin (dB)
Low 1	2412	-3.096	-3.096	8.0	-11.1
Mid 6	2437	-2.837	-2.837	8.0	-10.8
High 11	2462	-3.058	-3.058	8.0	-11.1

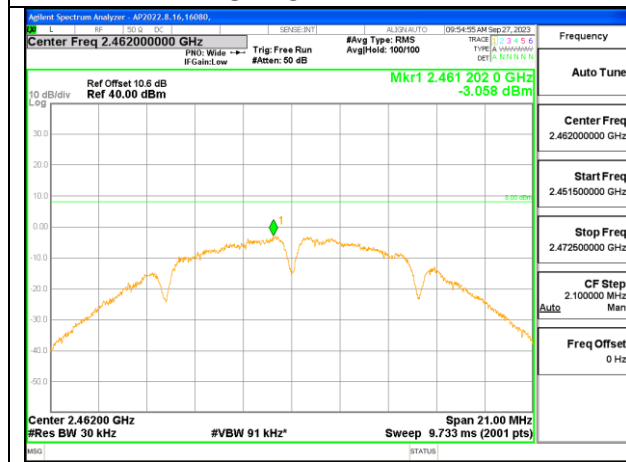
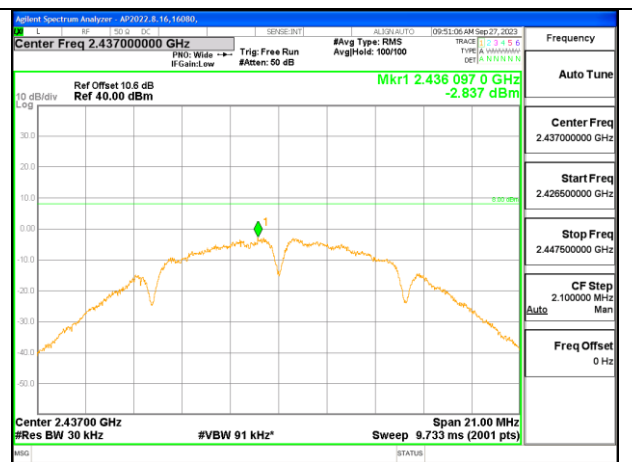
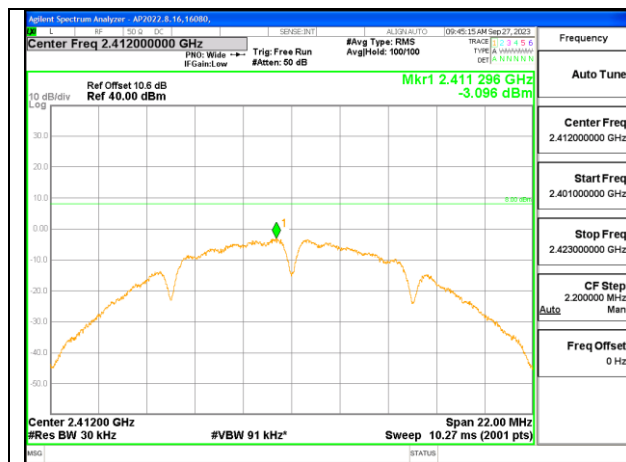

9.5.2. 802.11g MODE

1TX Antenna 1 MODE

Duty Cycle CF (dB)	0.00	Included in Calculations of Corr'd PSD
---------------------------	------	---

PSD Results

Channel	Frequency (MHz)	Chain 0 Meas (dBm/30kHz)	Total Corr'd PSD (dBm/30kHz)	Limit (dBm/30kHz)	Margin (dB)
Low 1	2412	-7.323	-7.323	8.0	-15.3
Mid 6	2437	-7.092	-7.092	8.0	-15.1
High 11	2462	-7.474	-7.474	8.0	-15.5

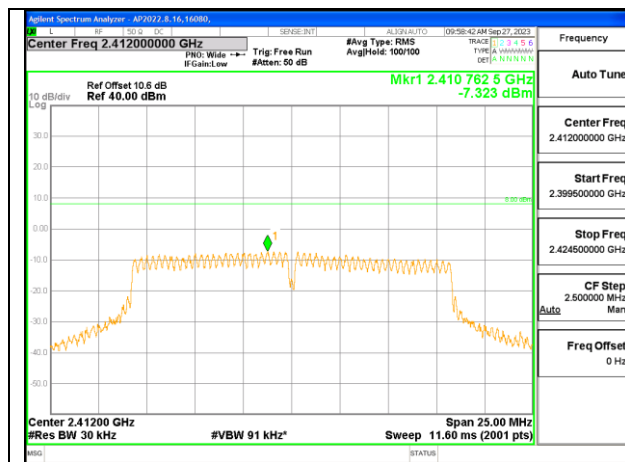

LOW CHANNEL 1

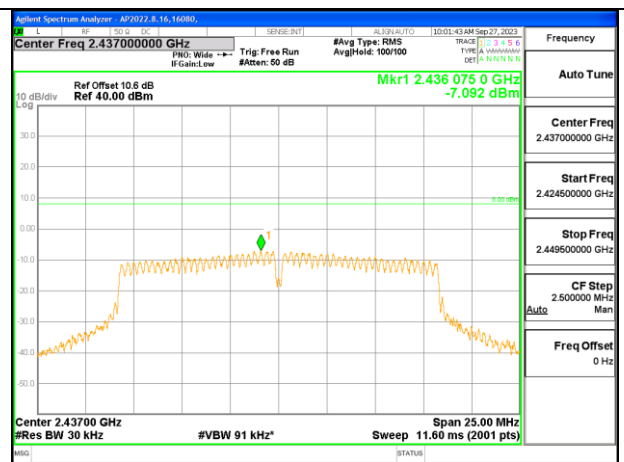

MID CHANNEL 6

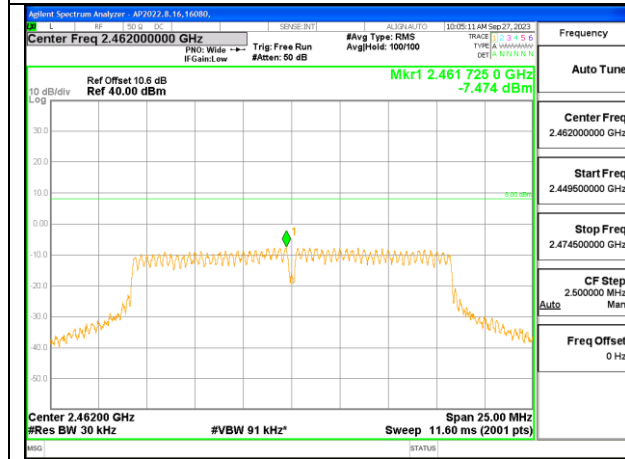

HIGH CHANNEL 11

9.5.3. 802.11n HT20 MODE

1TX Antenna 1 MODE

Duty Cycle CF (dB)	0.00	Included in Calculations of Corr'd PSD
---------------------------	------	---

PSD Results

Channel	Frequency (MHz)	Chain 0 Meas (dBm/30kHz)	Total Corr'd PSD (dBm/30kHz)	Limit (dBm/30kHz)	Margin (dB)
Low 1	2412	-8.547	-8.547	8.0	-16.5
Mid 6	2437	-8.554	-8.554	8.0	-16.6
High 11	2462	-8.930	-8.930	8.0	-16.9

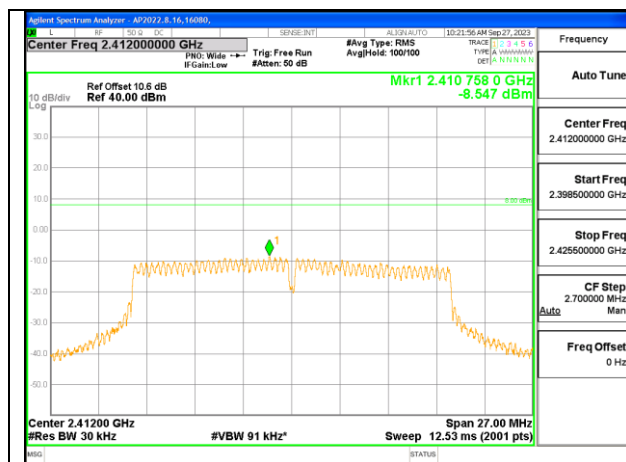

LOW CHANNEL 1

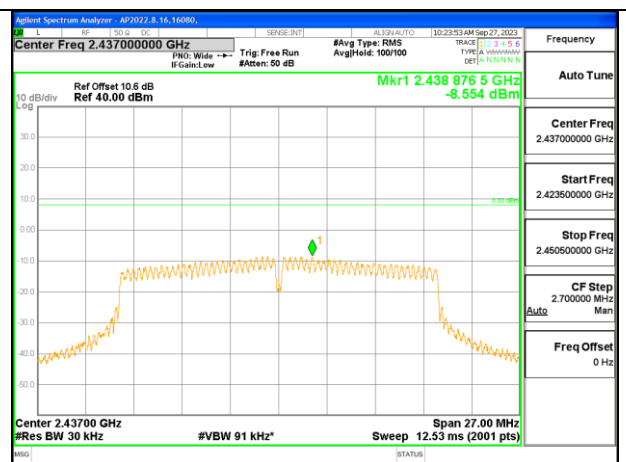

MID CHANNEL 6

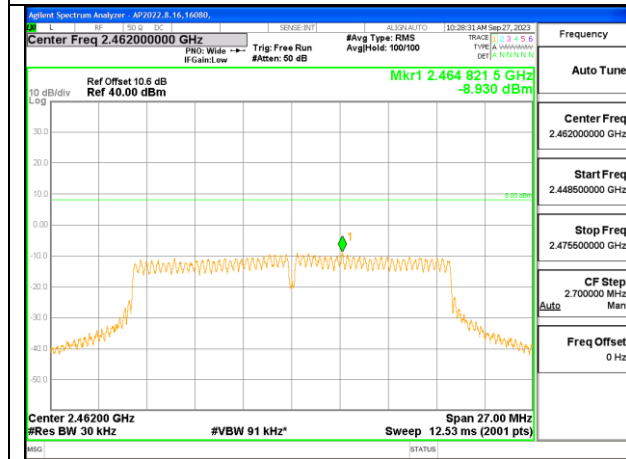

HIGH CHANNEL 11

9.5.4. 802.11n HT40 MODE

1TX Antenna 1 MODE

Duty Cycle CF (dB)	0.23	Included in Calculations of Corr'd PSD
--------------------	------	--

PSD Results

Channel	Frequency (MHz)	Chain 0 Meas (dBm/30kHz)	Total Corr'd PSD (dBm/30kHz)	Limit (dBm/30kHz)	Margin (dB)
Low 3	2422	-12.089	-11.859	8.0	-19.9
Mid 6	2437	-11.151	-10.921	8.0	-18.9
High 9	2452	-12.123	-11.893	8.0	-19.9

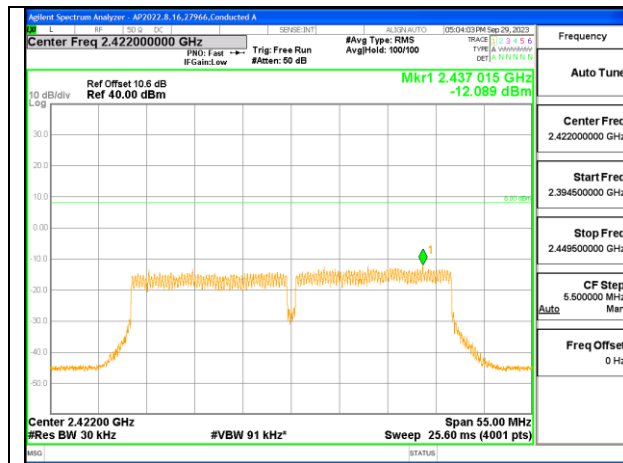

LOW CHANNEL 3

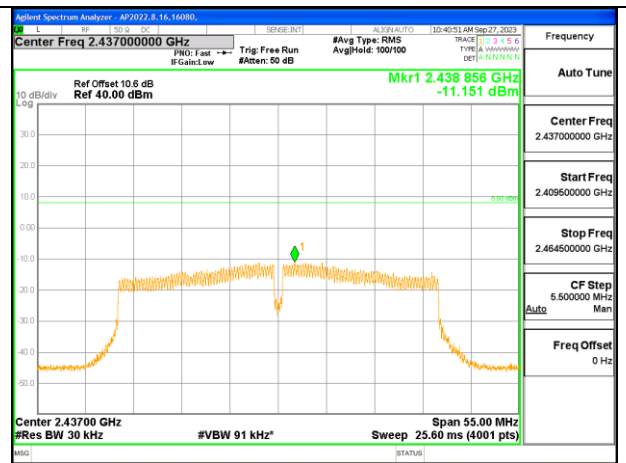

MID CHANNEL 6

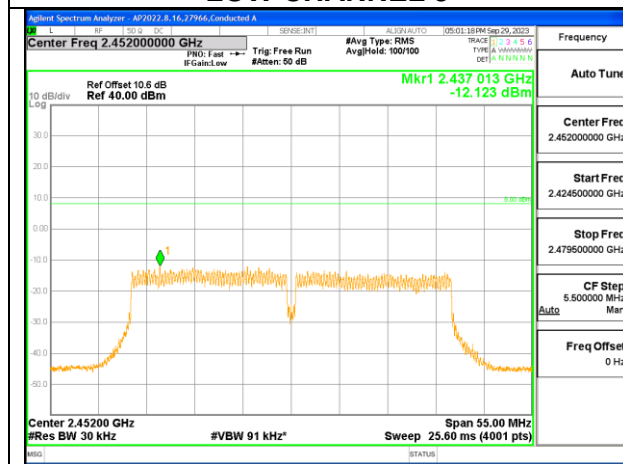

HIGH CHANNEL 9

9.6. CONDUCTED SPURIOUS EMISSIONS

LIMITS

FCC §15.247 (d)

RSS-247 5.5

Output power was measured based on the use of a RMS averaging measurement; spurious emissions are required to be 30dBc.

RESULTS

9.6.1. 802.11b MODE

1TX Antenna 1 MODE

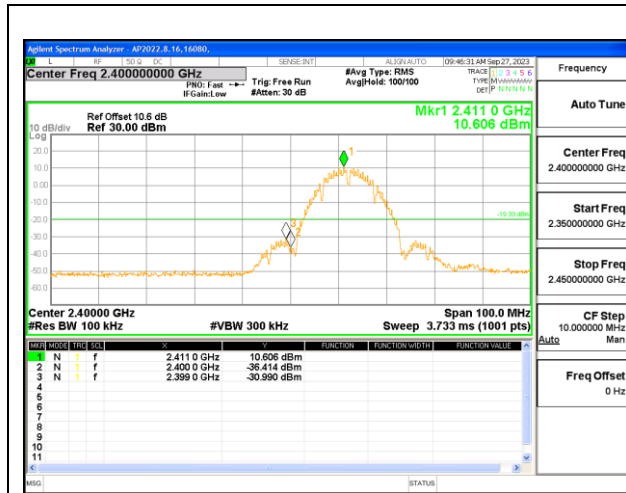

LOW CHANNEL 1 BANDEDGE



OUT-OF-BAND LOW CHANNEL 1

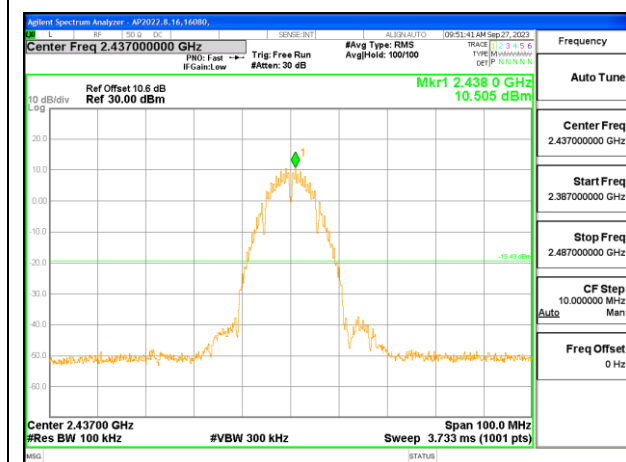

IN-BAND REFERENCE LEVEL

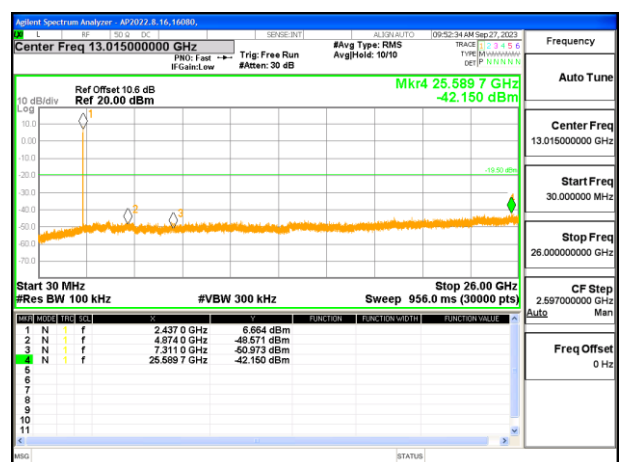

OUT-OF-BAND MID CHANNEL

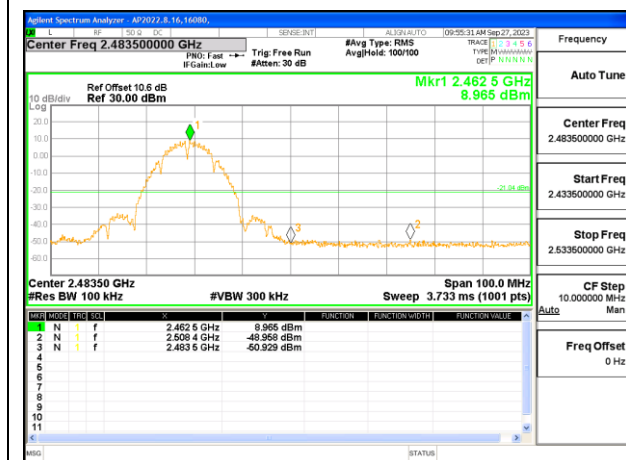

HIGH CHANNEL 11 BANDEDGE

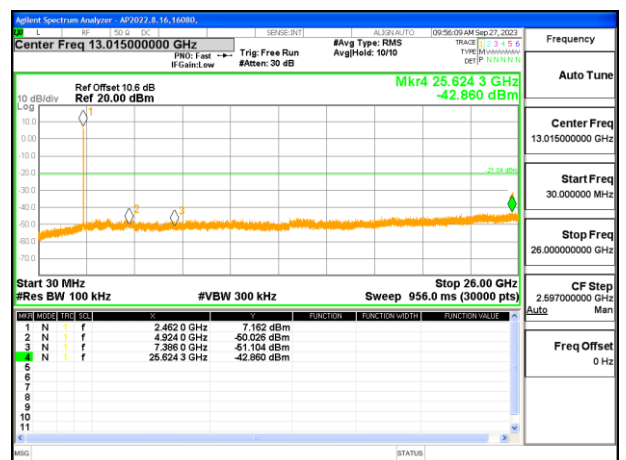

OUT-OF-BAND HIGH CHANNEL 11

9.6.2. 802.11g MODE

1TX Antenna 1 MODE

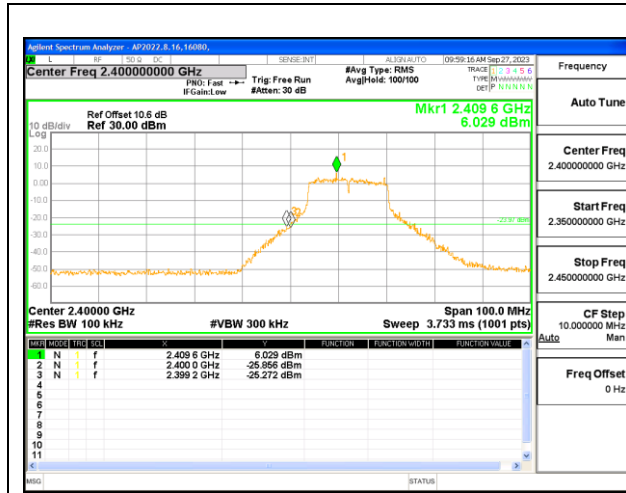

LOW CHANNEL 1 BANDEDGE

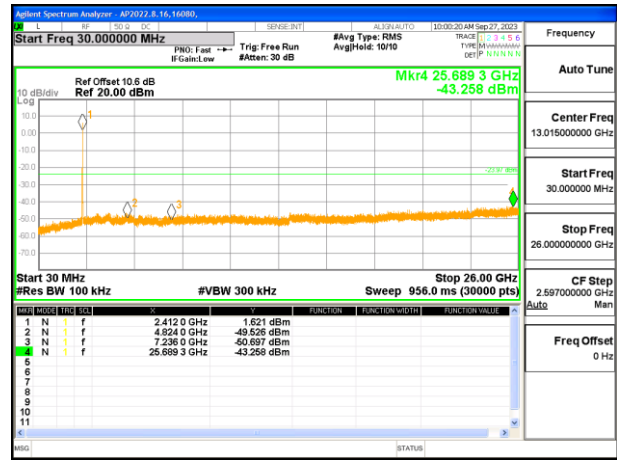

OUT-OF-BAND LOW CHANNEL 1

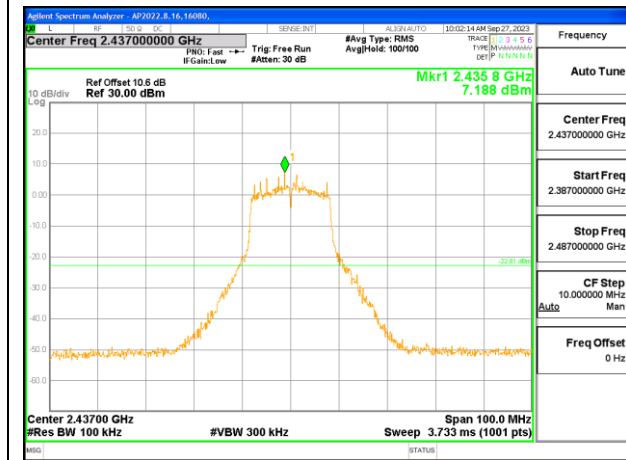

IN-BAND REFERENCE LEVEL

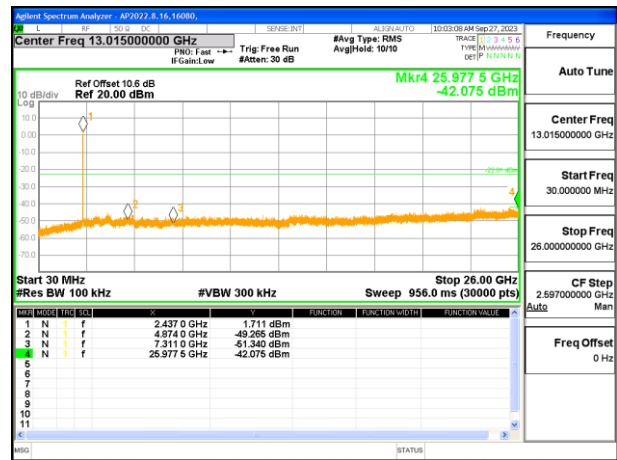

OUT-OF-BAND MID CHANNEL

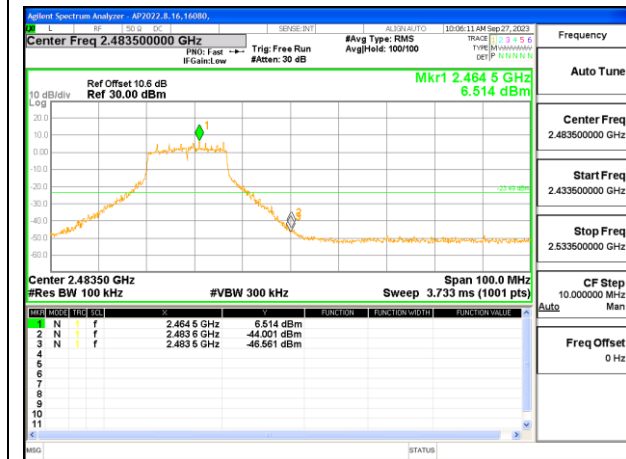

HIGH CHANNEL 11 BANDEDGE

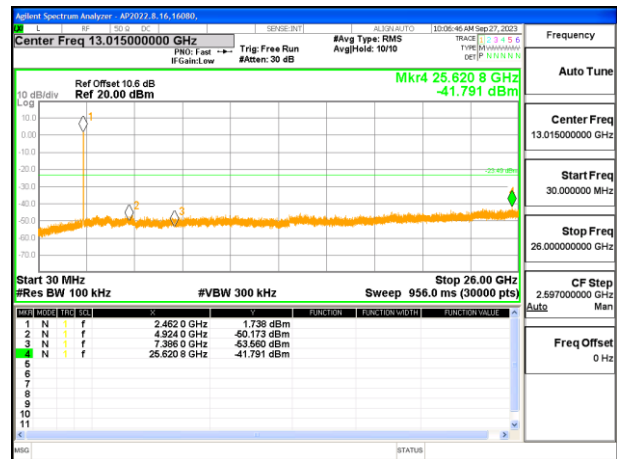

OUT-OF-BAND HIGH CHANNEL 11

9.6.3. 802.11n HT20 MODE

1TX Antenna 1 MODE

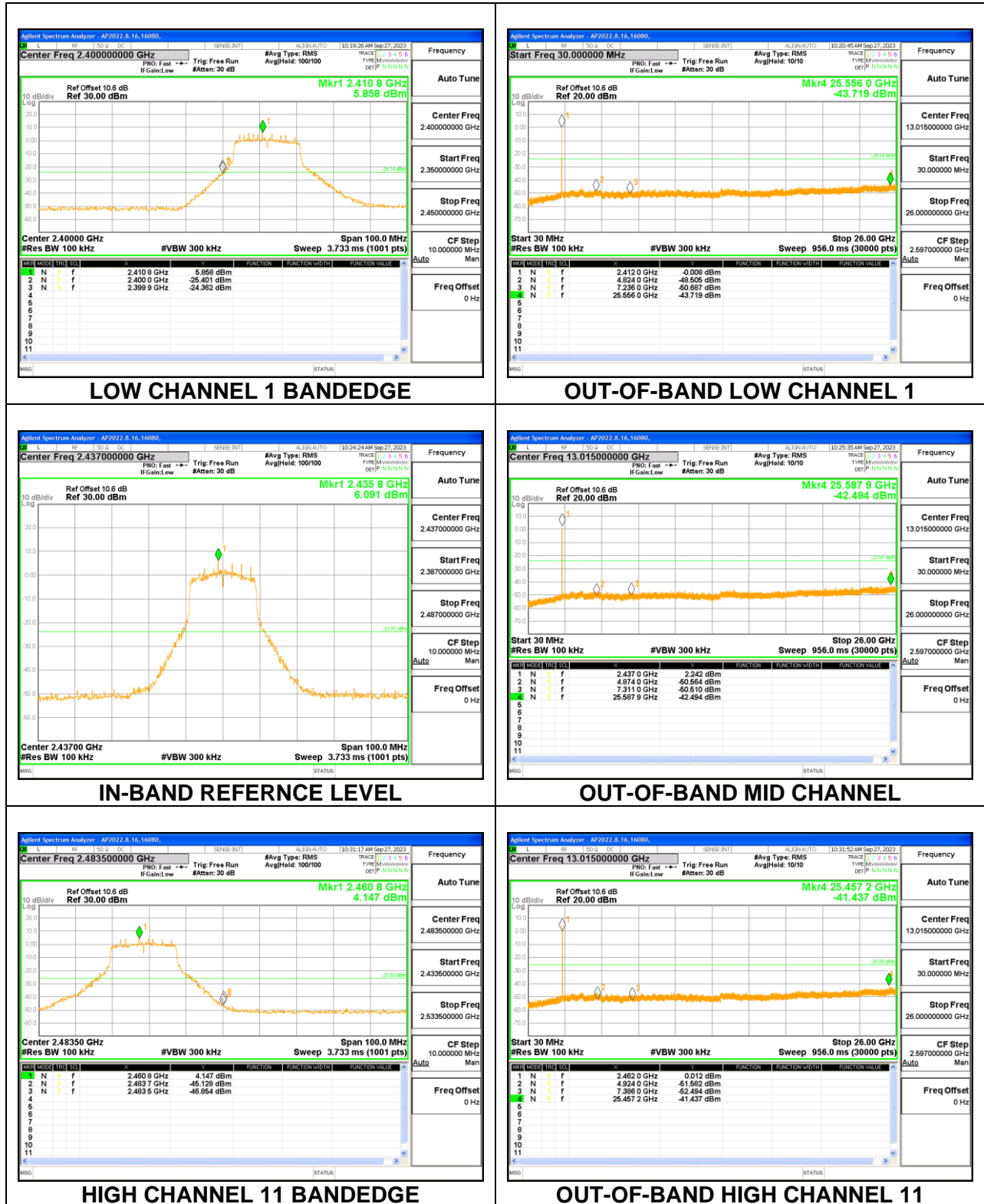

9.6.4. 802.11n HT40 MODE

1TX Antenna 1 MODE

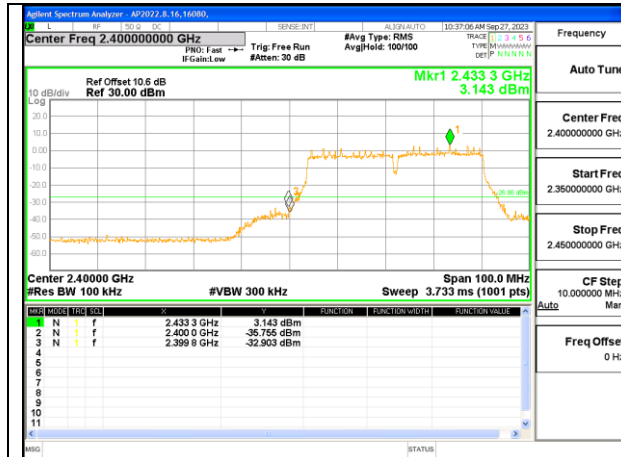

LOW CHANNEL 3 BANDEDGE

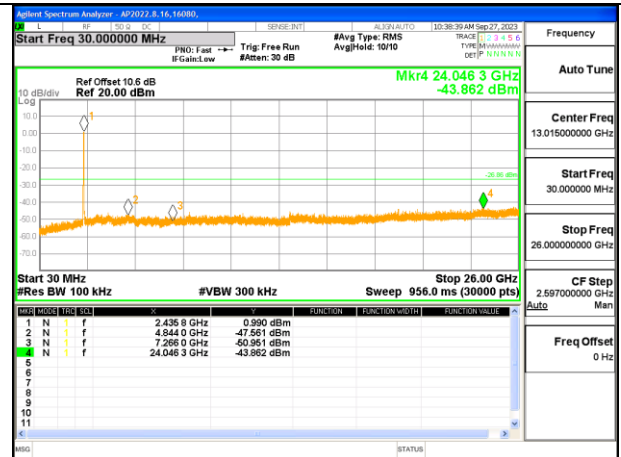

OUT-OF-BAND LOW CHANNEL 3

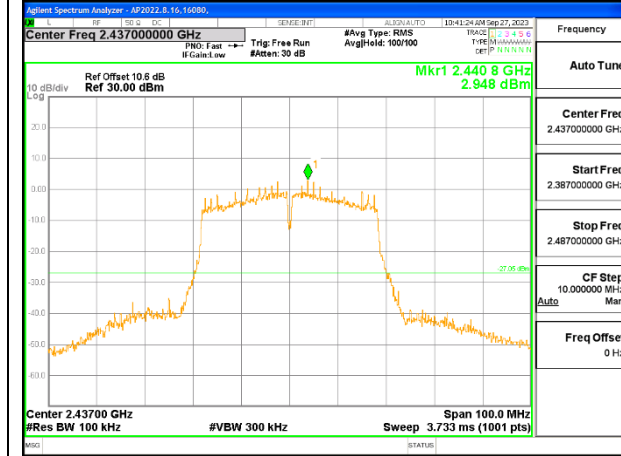

IN-BAND REFERENCE LEVEL

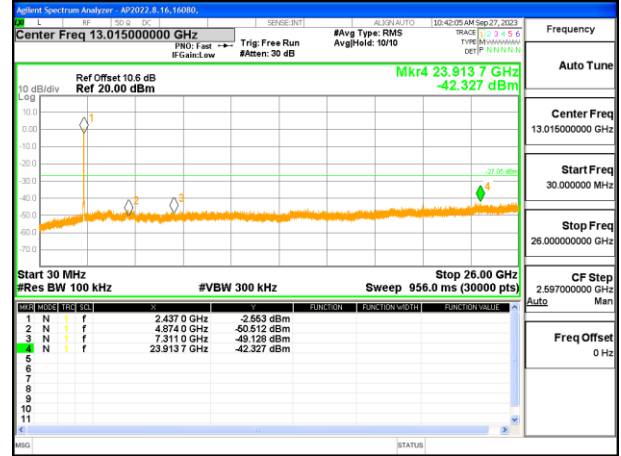

OUT-OF-BAND MID CHANNEL

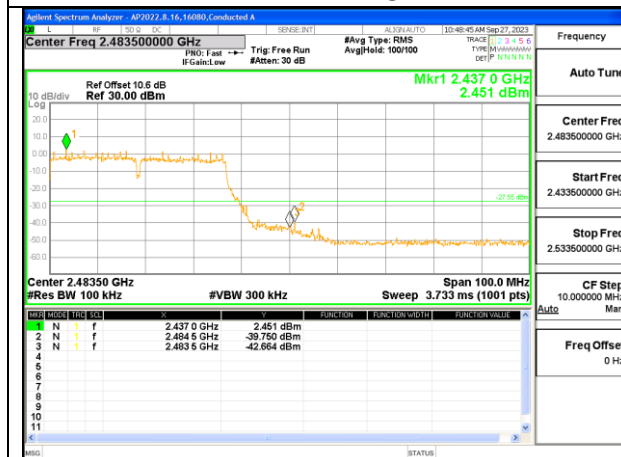

HIGH CHANNEL 9 BANDEDGE

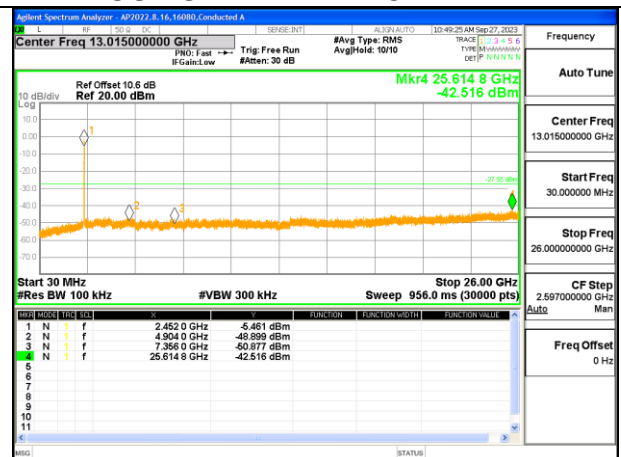

OUT-OF-BAND HIGH CHANNEL 9

10. RADIATED TEST RESULTS

LIMITS

FCC §15.205 and §15.209

RSS-GEN, Section 8.9 and 8.10

Frequency Range (MHz)	Field Strength Limit (uV/m) at 3 m	Field Strength Limit (dBuV/m) at 3 m
0.009-0.490	2400/F(kHz) @ 300 m	-
0.490-1.705	24000/F(kHz) @ 30 m	-
1.705 - 30	30 @ 30m	-
30 - 88	100	40
88 - 216	150	43.5
216 - 960	200	46
Above 960	500	54

TEST PROCEDURE

The EUT is placed on a non-conducting table 80 cm above the ground plane for measurement below 1GHz; 1.5 m above the ground plane for measurement above 1GHz. The antenna to EUT distance is 3 meters. The EUT is configured in accordance with ANSI C63.10. The EUT is set to transmit in a continuous mode.

For measurements below 1 GHz the resolution bandwidth is set to 100 kHz for peak detection measurements or 120 kHz for quasi-peak detection measurements in the 30-1000MHz range, 9kHz for peak and/or quasi-peak detection measurements in the 0.15-30MHz range and 200Hz for peak and/or quasi-peak detection measurements in the 9 to 150kHz range. Peak detection is used unless otherwise noted as quasi-peak or average (9-90kHz and 110-490kHz).

For pre-scans above 1 GHz the resolution bandwidth is set to 1 MHz; the video bandwidth is set to 30 KHz for peak measurements.

For final measurements above 1 GHz the resolution bandwidth is set to 1 MHz; the video bandwidth is set to 3 MHz for peak measurements and as applicable for average measurements.

The spectrum from 1 GHz to 18 GHz is investigated with the transmitter set to the lowest, middle, and highest channels in each applicable band. Below 1GHz and above 18GHz emissions, the channel with the highest output power was tested.

The frequency range of interest is monitored at a fixed antenna height and EUT azimuth. The EUT is rotated through 360 degrees to maximize emissions received. The antenna is scanned from 1 to 4 meters above the ground plane to further maximize the emission. Measurements are made with the antenna polarized in both the vertical and the horizontal positions.

For below 30MHz testing, investigation was done on three antenna orientations (parallel, perpendicular, and ground-parallel), parallel and perpendicular are the worst orientations, therefore testing was performed on these two orientations only.

Based on FCC 15.31 (f) (2): measurements may be performed at a distance closer than that specified in the regulations; however, an attempt should be made to avoid making measurements in the near field.

KDB 414788 Open Field Site (OFS) and Chamber Correlation Justification

OFS and chamber correlation testing had been performed and chamber measured test result is the worst-case test result.

NOTE: The limits in CFR 47, Part 15, Subpart C, paragraph 15.209(a), are identical to those in RSS-Gen section 8.9, Table 6, since the measurements are performed in terms of magnetic field strength and converted to electric field strength levels (as reported in the table), using the free space impedance of 377 Ohms. For example, the measurement at frequency X kHz resulted in a level of Y dBuV/m, which is equivalent to $Y - 51.5 = Z$ dBuA/m, which has the same margin, W dB, to the corresponding RSS-Gen Table 6 limit as it has to 15.209(a) limit.

10.1. TRANSMITTER ABOVE 1 GHz

10.1.1. TX ABOVE 1 GHz 802.11b MODE IN THE 2.4 GHz BAND

1TX Antenna 1 MODE

BANDEDGE (LOW CHANNEL, CH 1)

HORIZONTAL RESULT

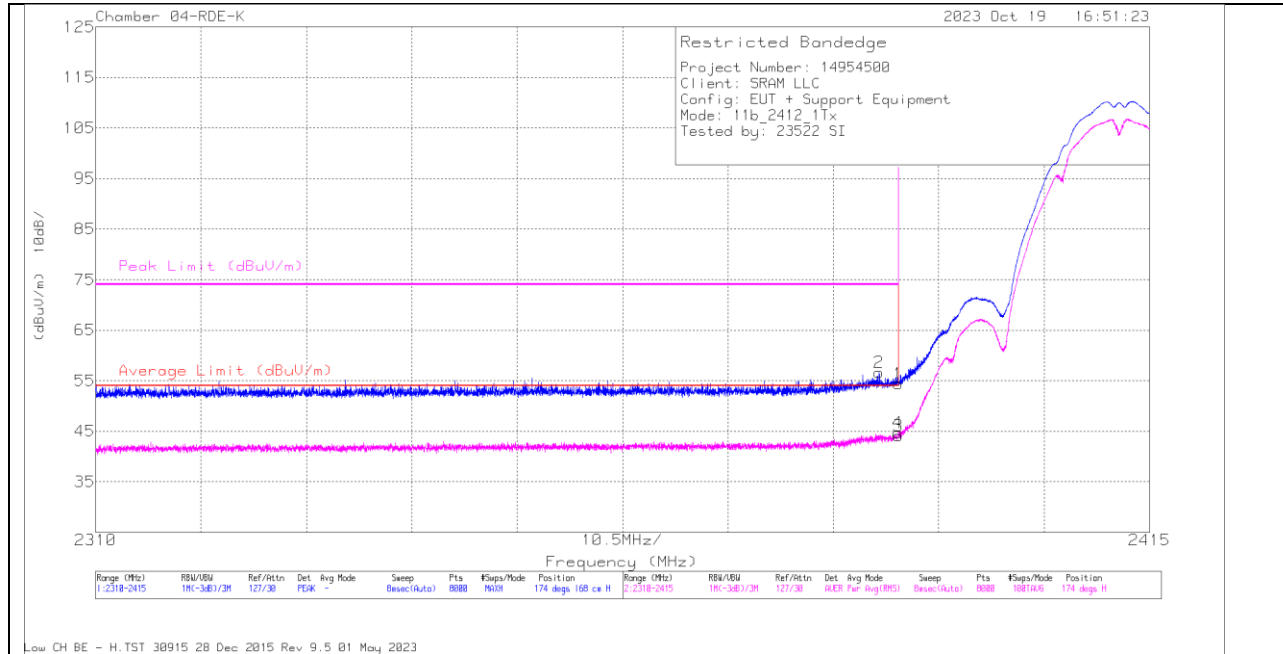

Trace Markers

Marker	Frequency (MHz)	Meter Reading (dBuV)	Det	223083 ACF 3m (dB/m)	Cb/Amp (dB)	Corrected Reading (dBuV/m)	Average Limit (dBuV/m)	Margin (dB)	Peak Limit (dBuV/m)	PK Margin (dB)	Azimuth (Degs)	Height (cm)	Polarity
1	* 2390	57.13	PK	31.8	-34.5	54.43	-	-	74	-19.57	174	168	H
2	* 2388.066	59.28	PK	31.8	-34.5	56.58	-	-	74	-17.42	174	168	H
3	* 2390	46.81	RMS	31.8	-34.5	44.11	54	-9.89	-	-	174	168	H
4	* 2389.93	47.4	RMS	31.8	-34.5	44.7	54	-9.3	-	-	174	168	H

* - indicates frequency in CFR47 Pt 15 / IC RSS-Restricted Band
 Pk - Peak detector
 RMS - RMS detection

VERTICAL RESULT

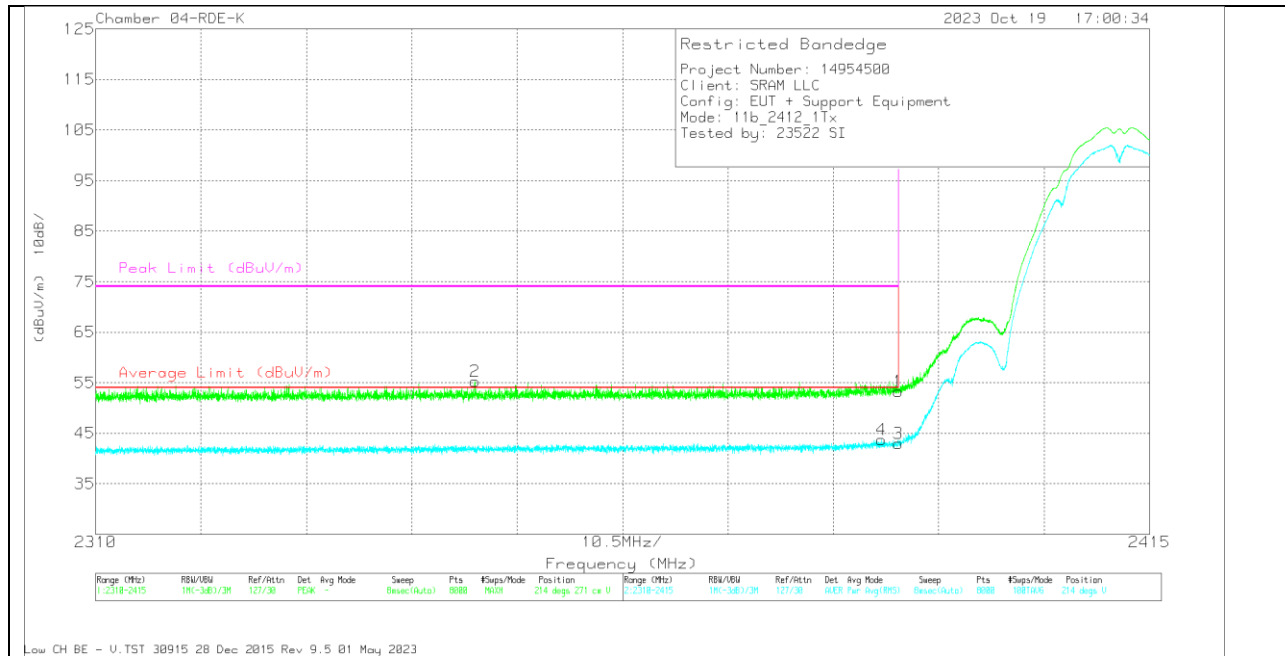

Trace Markers

Marker	Frequency (MHz)	Meter Reading (dBuV)	Det	223083 ACF 3m (dB/m)	Cbl/Amp (dB)	Corrected Reading (dBuV/m)	Average Limit (dBuV/m)	Margin (dB)	Peak Limit (dBuV/m)	PK Margin (dB)	Azimuth (Degs)	Height (cm)	Polarity
1	* 2390	55.97	Pk	31.8	-34.5	53.27	-	-	74	-20.73	214	271	V
2	* 2347.78	58.31	Pk	31.6	-34.7	55.21	-	-	74	-18.79	214	271	V
3	* 2390	45.7	RMS	31.8	-34.5	43	54	-11	-	-	214	271	V
4	* 2388.276	46.37	RMS	31.8	-34.5	43.67	54	-10.33	-	-	214	271	V

* - indicates frequency in CFR47 Pt 15 / IC RSS-Restricted Band
 Pk - Peak detector
 RMS - RMS detection

BANDEDGE (HIGH CHANNEL, CH 11)

HORIZONTAL RESULT

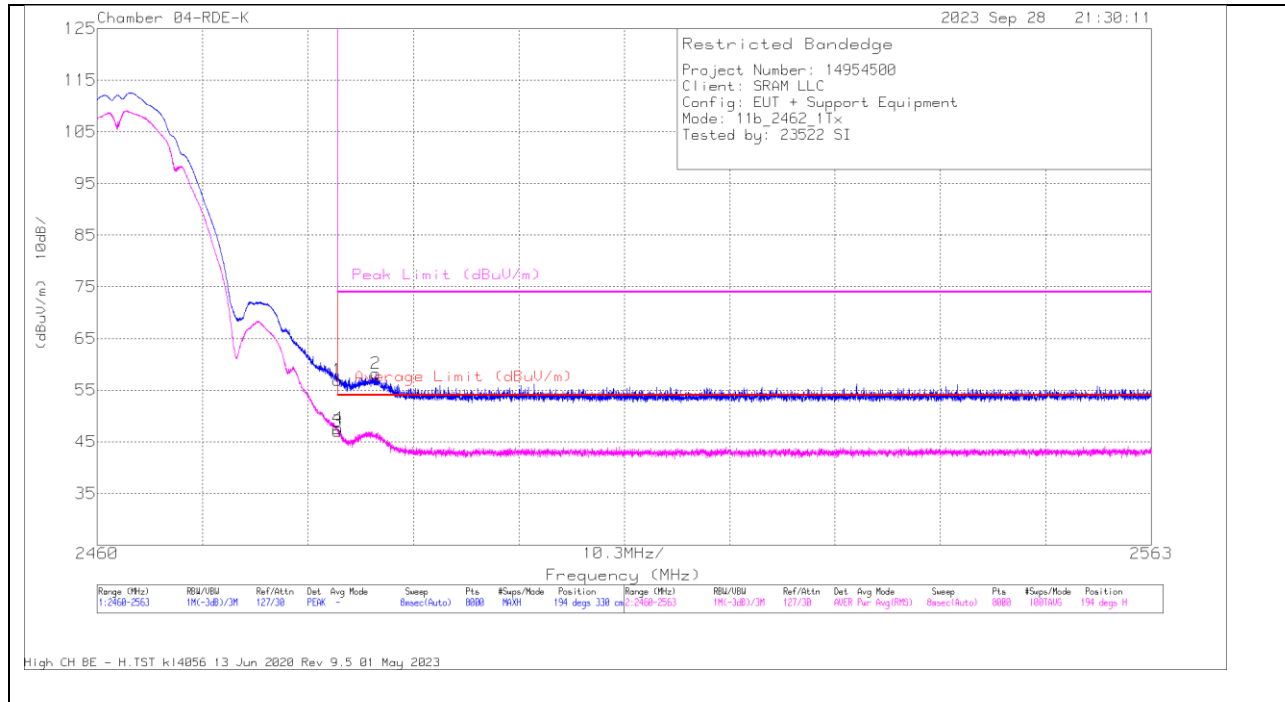

Trace Markers

Marker	Frequency (MHz)	Meter Reading (dBuV)	Det	223083 ACF 3m (dB/m)	Cbl/Amp (dB)	Corrected Reading (dBuV/m)	Average Limit (dBuV/m)	Margin (dB)	Peak Limit (dBuV/m)	PK Margin (dB)	Azimuth (Degs)	Height (cm)	Polarity
1	* 2483.5	58.84	PK	32.2	-34.1	56.94	-	-	74	-17.06	194	330	H
2	* 2487.222	60.1	PK	32.2	-34.1	58.2	-	-	74	-15.8	194	330	H
3	* 2483.5	48.91	RMS	32.2	-34.1	47.01	54	-6.99	-	-	194	330	H
4	* 2483.513	49.5	RMS	32.2	-34.1	47.6	54	-6.4	-	-	194	330	H

* - indicates frequency in CFR47 Pt 15 / IC RSS-Restricted Band
 PK - Peak detector
 RMS - RMS detection

VERTICAL RESULT

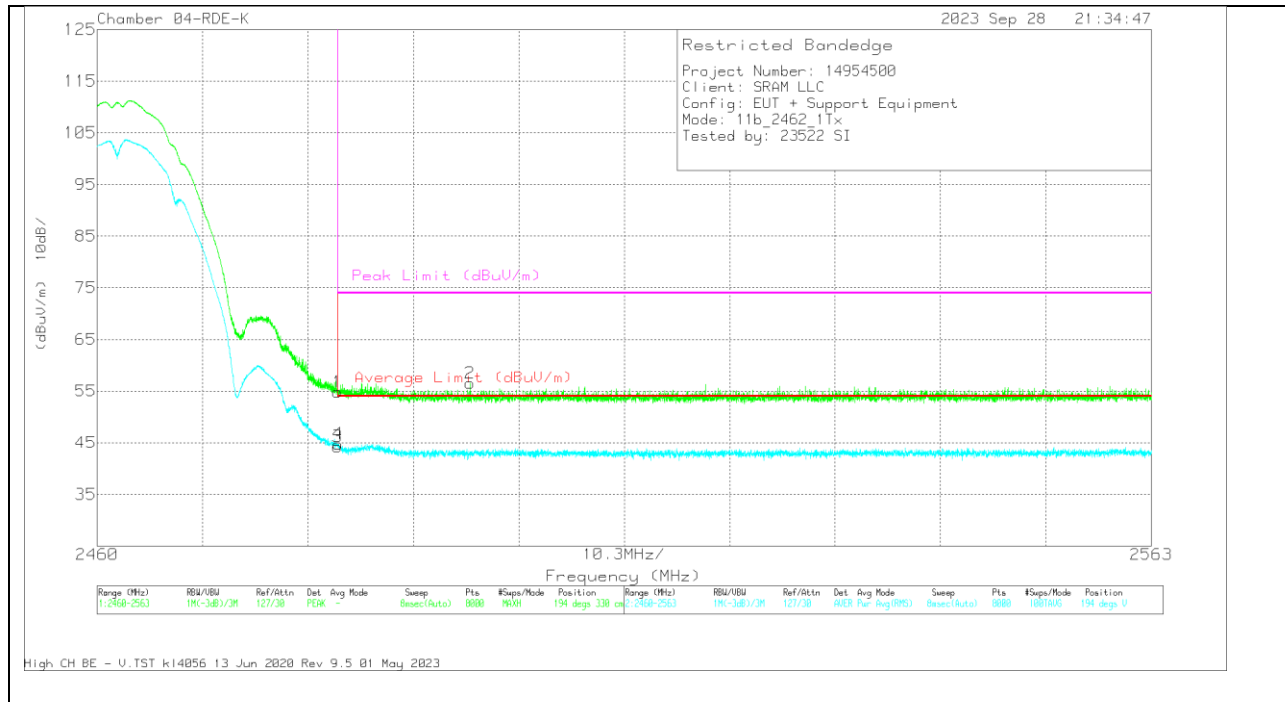

Trace Markers

Marker	Frequency (MHz)	Meter Reading (dBuV)	Det	223083 ACF 3m (dB/m)	Cbl/Amp (dB)	Corrected Reading (dBuV/m)	Average Limit (dBuV/m)	Margin (dB)	Peak Limit (dBuV/m)	PK Margin (dB)	Azimuth (Degs)	Height (cm)	Polarity
1	* 2483.5	56.7	Pk	32.2	-34.1	54.8	-	-	74	-19.2	194	330	V
2	* 2496.429	58.4	PK	32.2	-34.1	56.5	-	-	74	-17.5	194	330	V
3	* 2483.5	46.14	RMS	32.2	-34.1	44.24	54	-9.76	-	-	194	330	V
4	* 2483.539	46.68	RMS	32.2	-34.1	44.78	54	-9.22	-	-	194	330	V

* - indicates frequency in CFR47 Pt 15 / IC RSS-Restricted Band
 Pk - Peak detector
 RMS - RMS detection

HARMONICS AND SPURIOUS EMISSIONS

LOW CHANNEL, CH 1 RESULTS

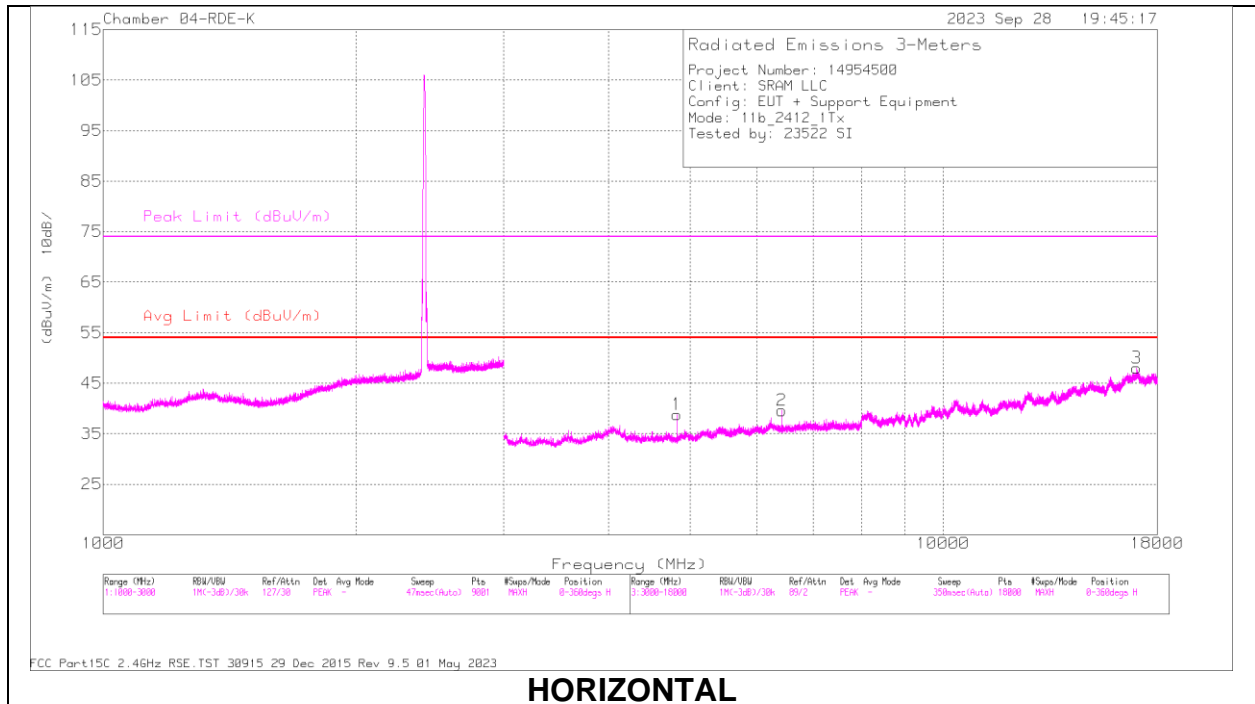

HORIZONTAL

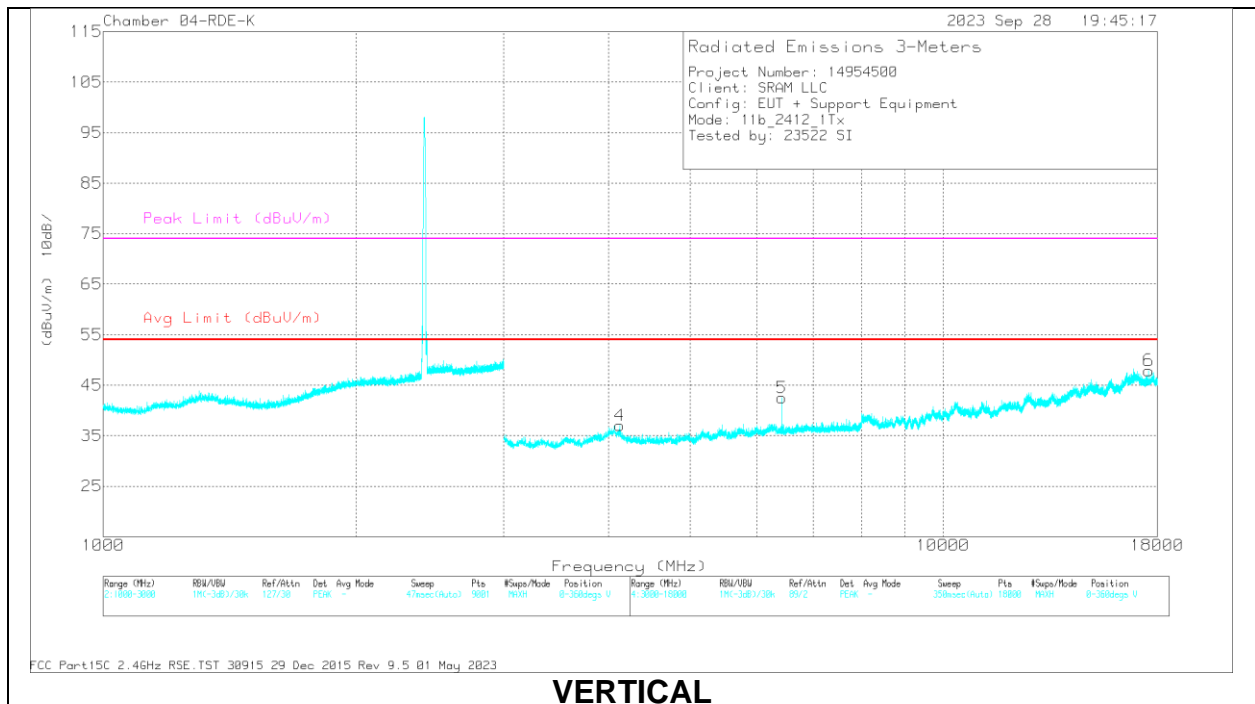

VERTICAL