



CERTIFICATION TEST REPORT

Report Number. : 12292162-E1V2

Applicant : SRAM LLC
1000 W Fulton Market 4th Floor
Chicago, IL 60607 U.S.A

Model : 00210

FCC ID : C90-BOXB1

IC : 10161A-BOXB1

EUT Description : Universal Shifter with AIREA and BLE Radios.

Test Standard(s) : FCC 47 CFR PART 15 SUBPART C
ISED RSS-247 ISSUE 2
ISED RSS-GEN ISSUE 5

Date Of Issue:

June 27, 2018

Prepared by:

UL Verification Services Inc.
47173 Benicia Street
Fremont, CA 94538, U.S.A.
TEL: (510) 771-1000
FAX: (510) 661-0888



REPORT REVISION HISTORY

Rev.	Issue Date	Revisions	Revised By
V1	06/15/18	Initial Issue	--
V2	06/27/18	Updated Section 5.3	Steven Tran

TABLE OF CONTENTS

REPORT REVISION HISTORY	2
TABLE OF CONTENTS	3
1. ATTESTATION OF TEST RESULTS	5
2. TEST METHODOLOGY	6
3. FACILITIES AND ACCREDITATION	6
4. CALIBRATION AND UNCERTAINTY	7
4.1. <i>MEASURING INSTRUMENT CALIBRATION</i>	<i>7</i>
4.2. <i>SAMPLE CALCULATION</i>	<i>7</i>
4.3. <i>MEASUREMENT UNCERTAINTY.....</i>	<i>7</i>
5. EQUIPMENT UNDER TEST.....	8
5.1. <i>DESCRIPTION OF EUT</i>	<i>8</i>
5.2. <i>MAXIMUM OUTPUT POWER.....</i>	<i>8</i>
5.3. <i>DESCRIPTION OF AVAILABLE ANTENNAS</i>	<i>8</i>
5.4. <i>SOFTWARE AND FIRMWARE.....</i>	<i>8</i>
5.5. <i>WORST-CASE CONFIGURATION AND MODE.....</i>	<i>8</i>
5.6. <i>DESCRIPTION OF TEST SETUP.....</i>	<i>9</i>
6. MEASUREMENT METHOD.....	12
7. TEST AND MEASUREMENT EQUIPMENT	13
8. ANTENNA PORT TEST RESULTS	14
8.1. <i>ON TIME AND DUTY CYCLE.....</i>	<i>14</i>
8.2. <i>99% BANDWIDTH.....</i>	<i>15</i>
8.3. <i>6 dB BANDWIDTH.....</i>	<i>16</i>
8.4. <i>OUTPUT POWER.....</i>	<i>17</i>
8.5. <i>AVERAGE POWER.....</i>	<i>18</i>
8.6. <i>POWER SPECTRAL DENSITY</i>	<i>19</i>
8.7. <i>CONDUCTED SPURIOUS EMISSIONS.....</i>	<i>20</i>
9. RADIATED TEST RESULTS.....	22
9.1. <i>LIMITS AND PROCEDURE.....</i>	<i>22</i>
9.2. <i>TRANSMITTER ABOVE 1 GHz</i>	<i>23</i>
9.3. <i>WORST CASE BELOW 30MHz.....</i>	<i>33</i>
9.4. <i>WORST CASE BELOW 1 GHz.....</i>	<i>35</i>

9.5.	WOSRT CASE 18-26 GHz.....	37
10.	SETUP PHOTOS	39

1. ATTESTATION OF TEST RESULTS

COMPANY NAME: SRAM LLC
1000 W Fulton Market 4th Floor
Chicago, IL 60607 U.S.A

EUT DESCRIPTION: Universal Shifter with AIREA and BLE Radios.

MODEL: 00210

SERIAL NUMBER: 1154040031 (Conducted), 1154040036 (Radiated)

DATE TESTED: May 17th, 2018 – 25th, 2018

APPLICABLE STANDARDS	
STANDARD	TEST RESULTS
CFR 47 Part 15 Subpart C	Complies
ISED RSS-247 Issue 2	Complies
ISED RSS-GEN Issue 5	Complies

UL Verification Services Inc. tested the above equipment in accordance with the requirements set forth in the above standards. All indications of Pass/Fail in this report are opinions expressed by UL Verification Services Inc. based on interpretations and/or observations of test results. Measurement Uncertainties were not taken into account and are published for informational purposes only. The test results show that the equipment tested is capable of demonstrating compliance with the requirements as documented in this report.

Note: The results documented in this report apply only to the tested sample, under the conditions and modes of operation as described herein. This document may not be altered or revised in any way unless done so by UL Verification Services Inc. and all revisions are duly noted in the revisions section. Any alteration of this document not carried out by UL Verification Services Inc. will constitute fraud and shall nullify the document. This report must not be used by the client to claim product certification, approval, or endorsement by NVLAP, NIST, any agency of the Federal Government, or any agency of the U.S. government.

Approved & Released For
UL Verification Services Inc. By:

Prepared By:



DAN CORONIA
CONSUMER TECHNOLOGY DIVISION
OPERATIONS LEADER
UL Verification Services Inc.

GLENN ESCANO
CONSUMER TECHNOLOGY DIVISION
TEST ENGINEER
UL Verification Services Inc

2. TEST METHODOLOGY

The tests documented in this report were performed in accordance with FCC CFR 47 Part 2, FCC CFR 47 Part 15, KDB 558074 D01 v04, ANSI C63.10-2013, RSS-GEN Issue 5, and RSS-247 Issue 2.

3. FACILITIES AND ACCREDITATION

The test sites and measurement facilities used to collect data are located at 47173 and 47266 Benicia Street, Fremont, California, USA. Line conducted emissions are measured only at the 47173 address. The following table identifies which facilities were utilized for radiated emission measurements documented in this report. Specific facilities are also identified in the test results sections.

47173 Benicia Street	47266 Benicia Street
<input checked="" type="checkbox"/> Chamber A (ISED:2324B-1)	<input type="checkbox"/> Chamber D (ISED:22541-1)
<input checked="" type="checkbox"/> Chamber B (ISED:2324B-2)	<input type="checkbox"/> Chamber E (ISED:22541-2)
<input type="checkbox"/> Chamber C (ISED:2324B-3)	<input type="checkbox"/> Chamber F (ISED:22541-3)
	<input type="checkbox"/> Chamber G (ISED:22541-4)
	<input type="checkbox"/> Chamber H (ISED:22541-5)

The above test sites and facilities are covered under FCC Test Firm Registration # 208313. Chambers A through C are covered under ISED company address code 2324B with site numbers 2324B -1 through 2324B-3, respectively. Chambers D through H are covered under ISED Canada company address code 22541 with site numbers 22541 -1 through 22541-5, respectively.

UL Verification Services Inc. is accredited by NVLAP, Laboratory Code 200065-0. The full scope of accreditation can be viewed at <http://nist.gov/standards/scopes/2000650.htm>.

4. CALIBRATION AND UNCERTAINTY

4.1. MEASURING INSTRUMENT CALIBRATION

The measuring equipment utilized to perform the tests documented in this report has been calibrated in accordance with the manufacturer's recommendations, and is traceable to recognized national standards.

4.2. SAMPLE CALCULATION

Where relevant, the following sample calculation is provided:

$$\begin{aligned} \text{Field Strength (dBuV/m)} &= \text{Measured Voltage (dBuV)} + \text{Antenna Factor (dB/m)} + \\ &\text{Cable Loss (dB)} - \text{Preamp Gain (dB)} \\ 36.5 \text{ dBuV} + 18.7 \text{ dB/m} + 0.6 \text{ dB} - 26.9 \text{ dB} &= 28.9 \text{ dBuV/m} \end{aligned}$$

4.3. MEASUREMENT UNCERTAINTY

Where relevant, the following measurement uncertainty levels have been estimated for tests performed on the apparatus:

PARAMETER	UNCERTAINTY
Worst Case Radiated Disturbance, 9KHz to 30 MHz	3.15 dB
Worst Case Radiated Disturbance, 30 to 1000 MHz	5.36 dB
Worst Case Radiated Disturbance, 1000 to 18000 MHz	4.32 dB
Worst Case Radiated Disturbance, 18000 to 26000 MHz	4.45 dB

Uncertainty figures are valid to a confidence level of 95%.

5. EQUIPMENT UNDER TEST

5.1. DESCRIPTION OF EUT

The EUT is a Universal Shifter with AIREA and BLE Radios, powered by CR2032, coin cell battery.

5.2. MAXIMUM OUTPUT POWER

The transmitter has a maximum peak conducted output power as follows:

Frequency Range (MHz)	Mode	Peak		Average	
		Output Power (dBm)	Output Power (mW)	Output Power (dBm)	Output Power (mW)
2402 - 2480	BLE	4.42	2.77	4.18	2.62

5.3. DESCRIPTION OF AVAILABLE ANTENNAS

The radio utilizes a chip antenna, Johanson Technology 2450AT07A0100T, with a maximum gain of 1.0 dBi.

5.4. SOFTWARE AND FIRMWARE

The EUT firmware installed during testing was A-1.0.

The test utility software used during testing was Lightblue v2.6.4

5.5. WORST-CASE CONFIGURATION AND MODE

Radiated emissions below 1GHz and above 18GHz were performed with the EUT set to transmit at the channel with highest output power as worst-case scenario.

Band edge and radiated emissions between 1GHz and 18GHz were performed with the EUT set to transmit at the highest power on low, middle and high channels.

The fundamental of the EUT was investigated in three orthogonal orientations X, Y, Z, it was determined that X orientation was worst-case orientation; therefore, all final radiated testing was performed with the EUT in X orientation.

5.6. DESCRIPTION OF TEST SETUP

SUPPORT EQUIPMENT

Support Equipment List			
Description	Manufacturer	Model	Serial Number
Ipod Touch	Apple	MKJ02LL/A	CCQVRHY2GGNL

TEST SETUP

The EUT is powered by a CR2032, coin cell battery. The iPod Touch wirelessly sends commands to the EUT.

SETUP DIAGRAM FOR CONDUCTED TESTS

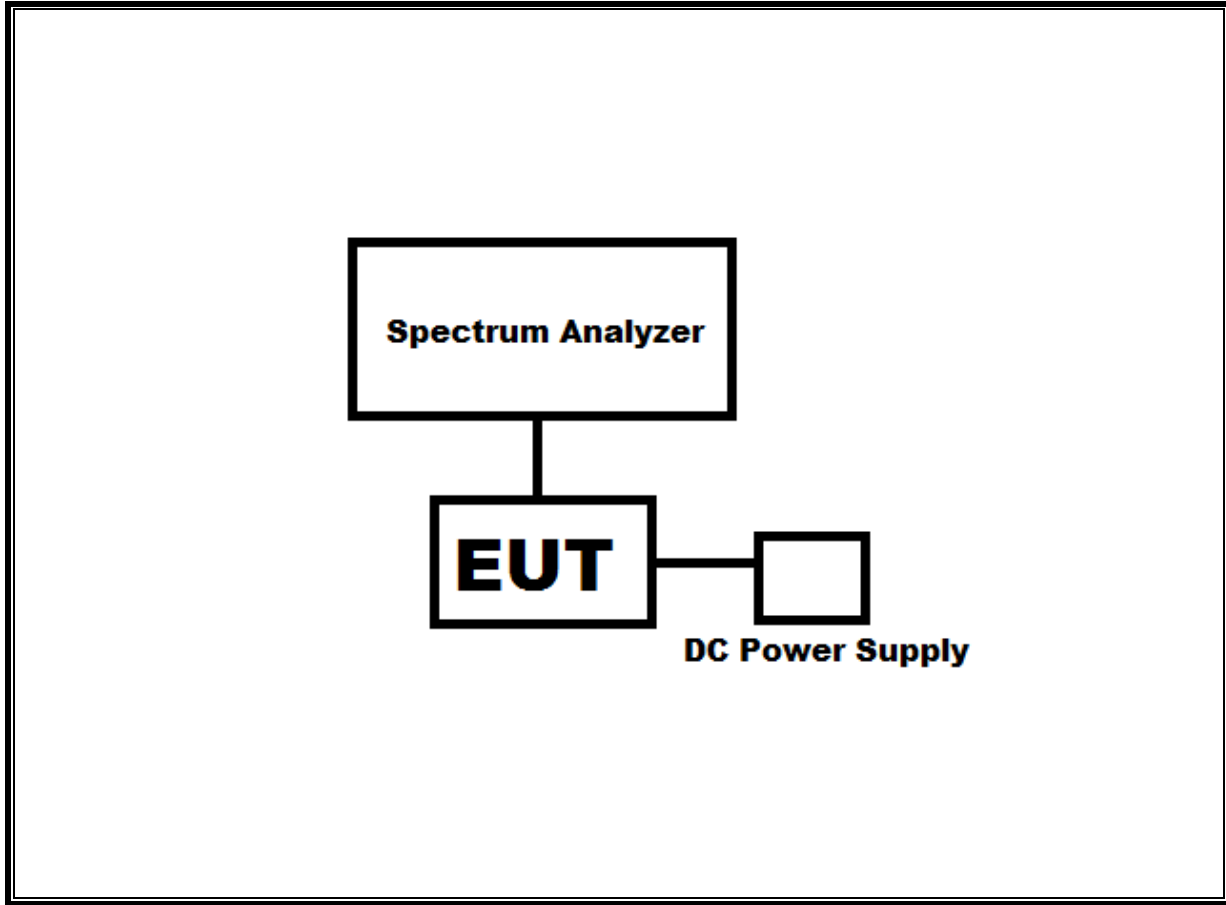

The EUT is powered by a CR2032, coin cell battery. The iPod Touch wirelessly sends commands to the EUT.

SETUP DIAGRAM FOR RADIATED TESTS

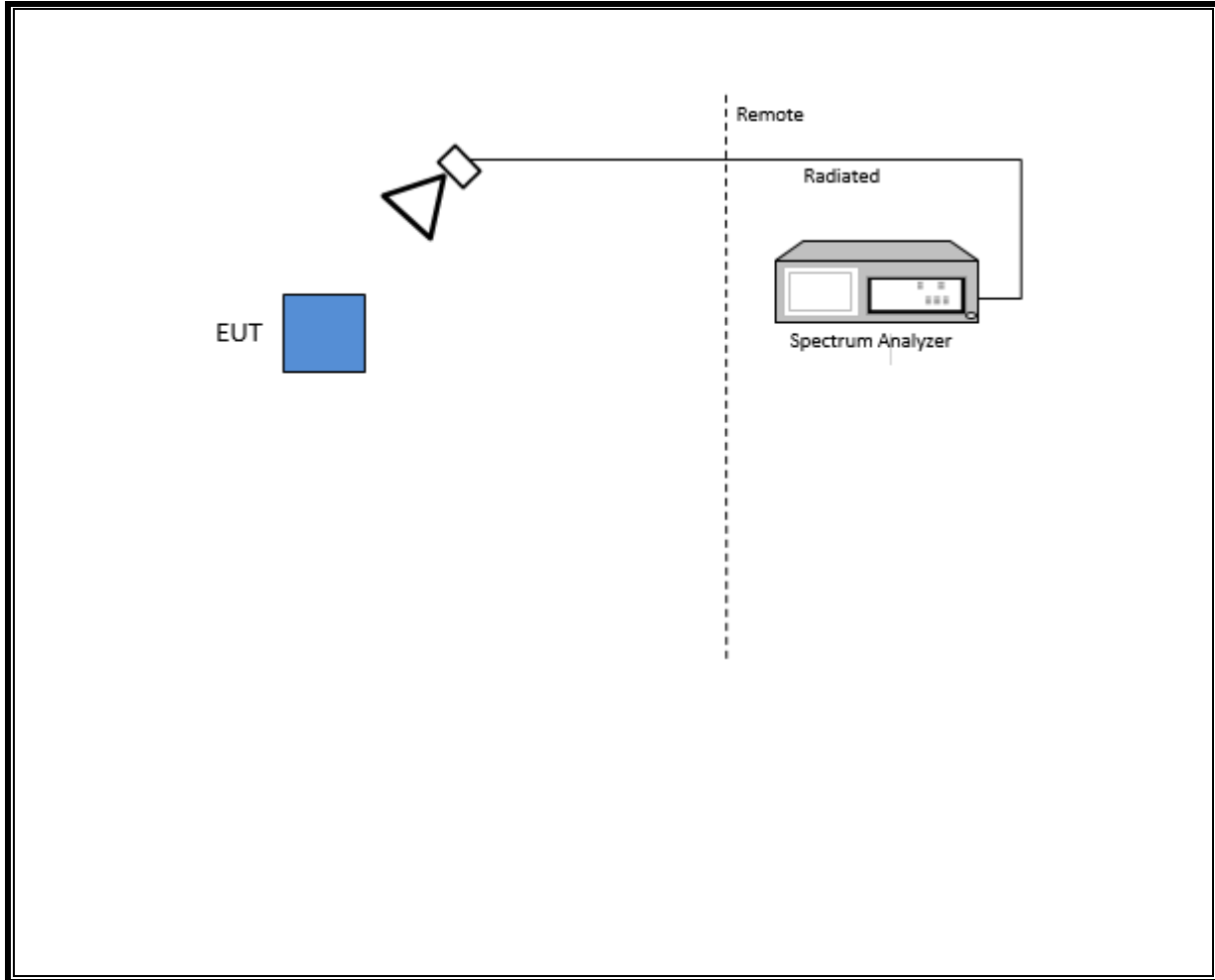

6. MEASUREMENT METHOD

On Time and Duty Cycle: KDB 558074 D01 v04, Section 6.

6 dB BW: KDB 558074 D01 v04, Section 8.1.

99% BW: ANSI C63.10-2013, Section 6.9.3.

Output Power: KDB 558074 D01 v04, Section 9.2.3.2

Power Spectral Density: KDB 558074 D01 v04, Section 10.2.

Out-of-band emissions in non-restricted bands: KDB 558074 D01 v04, Section 11.1 a)

Out-of-band emissions in restricted bands: KDB 558074 D01 v04, Section 12.1.

Band-edge: KDB 558074 D01 v04, Section 12.1.

7. TEST AND MEASUREMENT EQUIPMENT

The following test and measurement equipment was utilized for the tests documented in this:

Test Equipment List					
Description	Manufacturer	Model	ID No.	Cal Date	Cal Due
Spectrum Analyzer	Agilent	N9030A	T1454	01/08/18	01/08/19
Spectrum Analyzer	Agilent	N9030A	T1466	04/16/18	04/16/19
Antenna, Biconolog, 30MHz-2000MHz	Sunol Sciences	JB1	T130	10/16/17	10/16/18
Antenna, Horn, 1-18GHz	ETS Lindgren	3117	T862	06/09/17	06/09/18
Antenna, Horn, 1-18GHz	ETS Lindgren	3117	T863	06/09/17	06/09/18
RF Preamplifier, 10kHz - 1GHz	HP	8447D	T15	08/14/17	08/14/18
RF Preamplifier, 1 - 18GHz	Miteq	AFS42-00101800-25-S-42	T1165	11/25/17	11/25/18
RF Preamplifier, 1 - 18GHz	Miteq	AFS42-00101800-25-S-42	T493	04/03/18	04/03/19
Antenna, Active Loop 9kHz – 30MHz	Com-Power	AL-130R	T1866	10/10/17	10/10/18
Antenna, Horn, 18-26GHz	ARA	MWH-1826G	T89	01/18/18	01/18/19
Spectrum Analyzer	Keysight	N9030A	T1113	12/21/17	12/21/18
RF Preamplifier, 1-26GHz	Agilent	8449B	T404	07/23/17	07/23/18

Test Software List			
Description	Manufacturer	Model	Version
Antenna Port Software	UL	UL RF	Ver 7.9, Jan 24, 2018
Radiated Software	UL	UL EMC	Ver 9.5, Dec 01, 2016

8. ANTENNA PORT TEST RESULTS

8.1. ON TIME AND DUTY CYCLE

LIMITS

None; for reporting purposes only.

PROCEDURE

KDB 558074 Zero-Span Spectrum Analyzer Method.

ON TIME AND DUTY CYCLE RESULTS

Mode	ON Time B (msec)	Period (msec)	Duty Cycle x (linear)	Duty Cycle (%)	Duty Cycle Correction Factor (dB)	1/B Minimum VBW (kHz)
BLE	1.000	1.000	1.000	100.00%	0.00	0.010

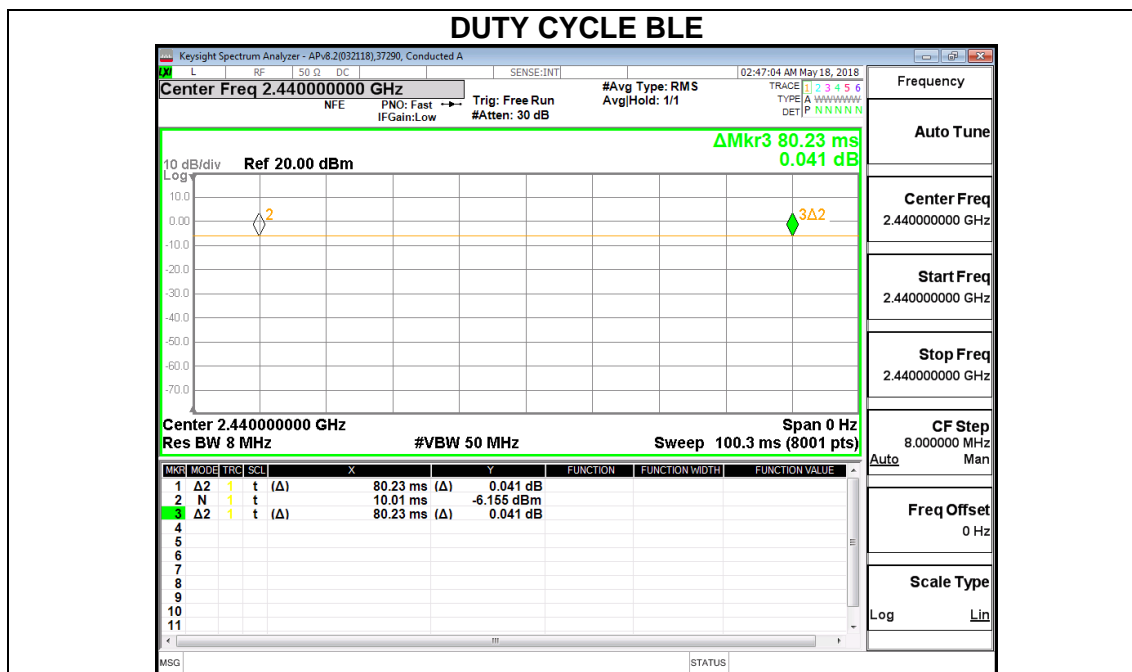

8.2. 99% BANDWIDTH

LIMITS

None; for reporting purposes only.

RESULTS

Channel	Frequency (MHz)	99% Bandwidth (MHz)
Low	2402	1.7839
Middle	2440	1.7929
High	2480	1.8433

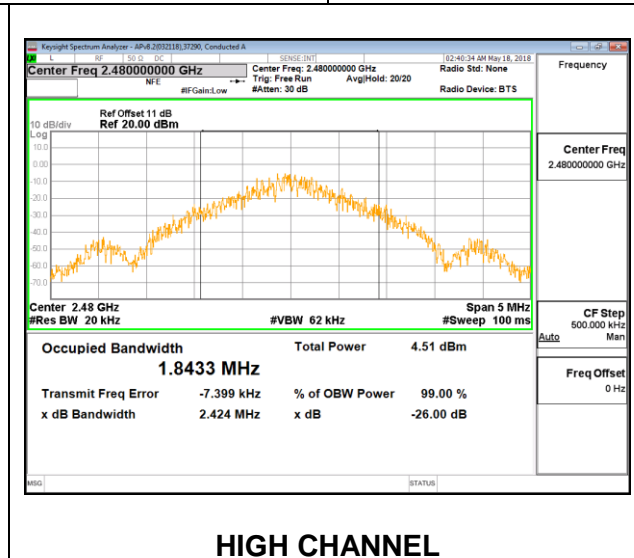
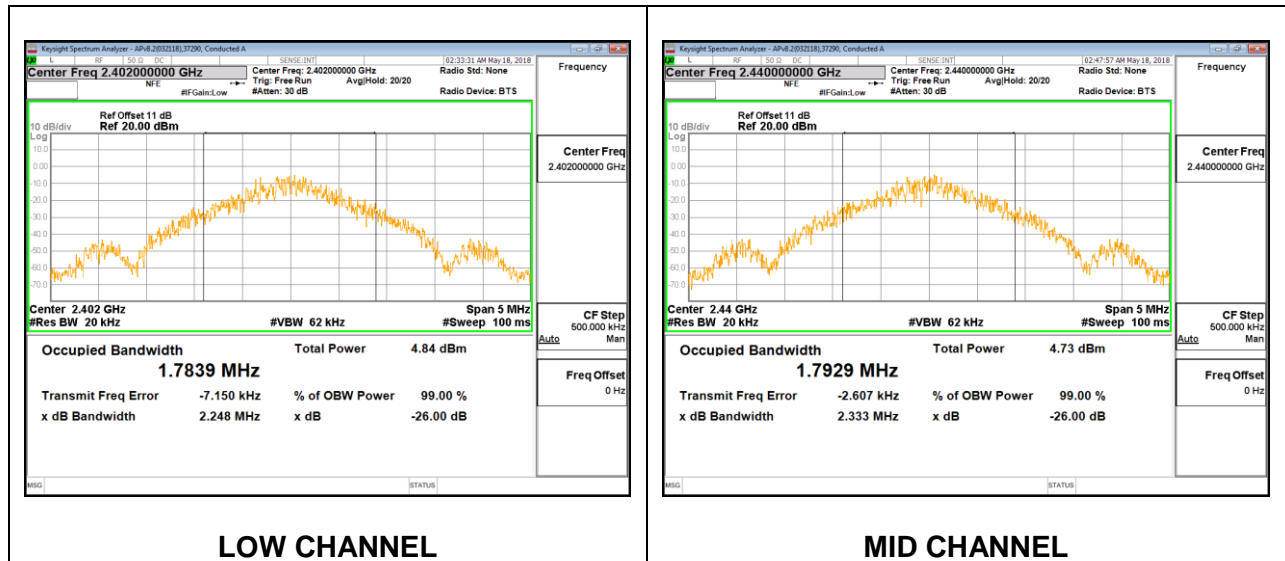

8.3. 6 dB BANDWIDTH

LIMITS

FCC §15.247 (a) (2)

RSS-247 5.2 (a)

The minimum 6 dB bandwidth shall be at least 500 kHz.

RESULTS

Channel	Frequency (MHz)	6 dB Bandwidth (MHz)	Minimum Limit (MHz)
Low	2402	0.852	0.5
Middle	2440	0.798	0.5
High	2480	0.741	0.5

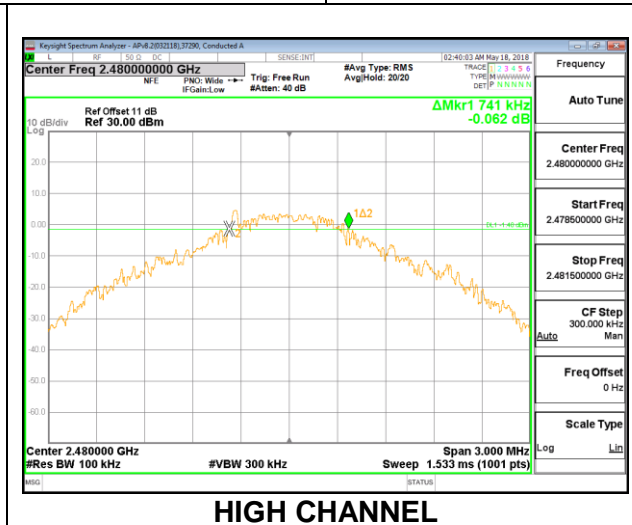
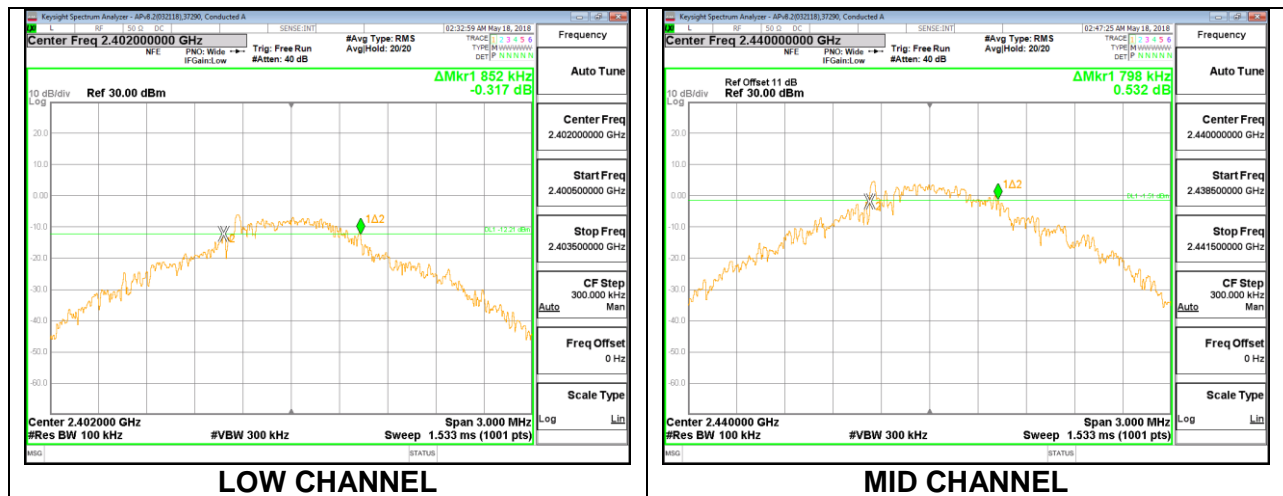

8.4. OUTPUT POWER

LIMITS

FCC §15.247 (b) (3)

RSS-247 5.4 (d)

The maximum antenna gain is less than or equal to 6 dBi, therefore the limit is 30 dBm.

TEST PROCEDURE

The transmitter output is connected to a power meter. The cable assembly insertion loss was entered as an offset in the power meter to allow for a gated peak reading of power.

RESULTS

Tested By:	39005 RA
Date:	5/14/2018

Channel	Frequency (MHz)	Peak Power Reading (dBm)	Limit (dBm)	Margin (dB)
Low	2402	4.39	30	-25.61
Middle	2440	4.42	30	-25.58
High	2480	4.28	30	-25.72

8.5. AVERAGE POWER

LIMITS

None; for reporting purposes only.

TEST PROCEDURE

The transmitter output is connected to a power meter. The cable assembly insertion loss was entered as an offset in the power meter to allow for a gated average reading of power.

RESULTS

Tested By:	39005 RA
Date:	5/14/2018

Channel	Frequency (MHz)	AV power (dBm)
Low	2402	4.18
Middle	2440	4.15
High	2480	4.06

8.6. POWER SPECTRAL DENSITY

LIMITS

FCC §15.247 (e)

RSS-247 (5.2) (b)

The power spectral density conducted from the transmitter to the antenna shall not be greater than 8 dBm in any 3 kHz band during any time interval of continuous transmission.

RESULTS

Channel	Frequency (MHz)	PSD (dBm/3kHz)	Limit (dBm/3kHz)	Margin (dB)
Low	2402	-8.415	8	-16.42
Middle	2440	-8.486	8	-16.49
High	2480	-8.749	8	-16.75

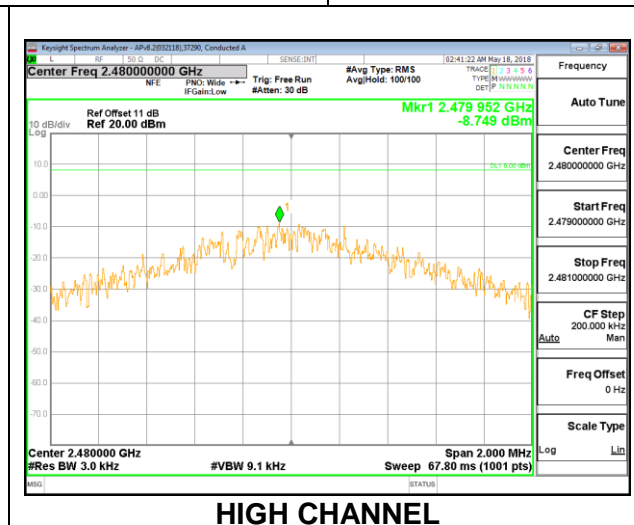
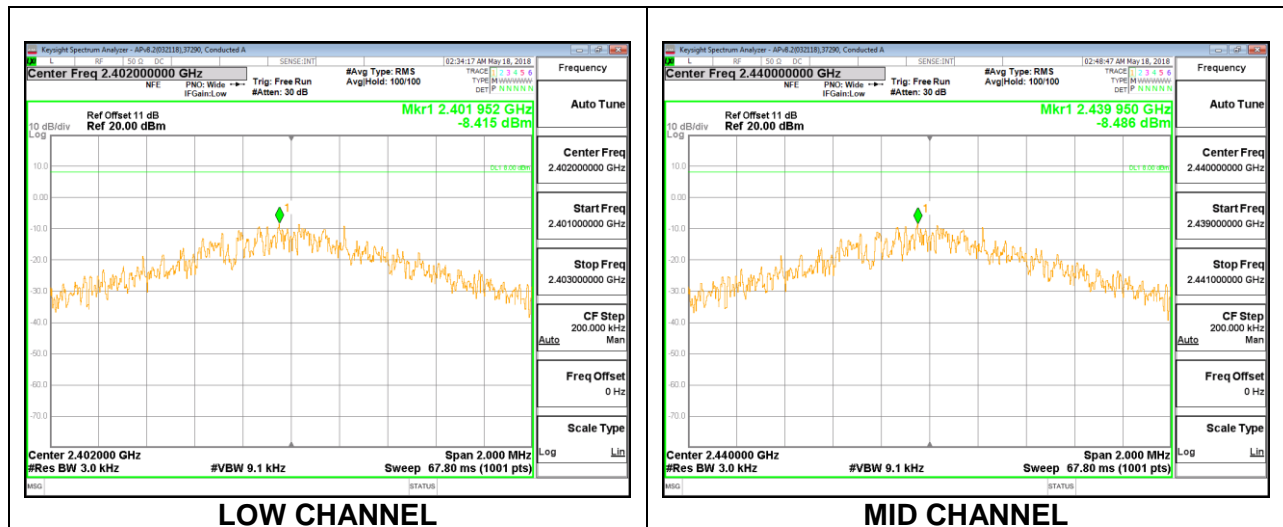

8.7. CONDUCTED SPURIOUS EMISSIONS

LIMITS

FCC §15.247 (d)

RSS-247 5.5

Output power was measured based on the use of a peak measurement, therefore the required attenuation is 20 dB.

TEST PROCEDURE

The transmitter output is connected to a spectrum analyzer. The resolution bandwidth is set to 100 kHz. The video bandwidth is set to 300 kHz.

The spectrum from 30 MHz to 26 GHz is investigated with the transmitter set to the lowest, middle, and highest channels.

RESULTS

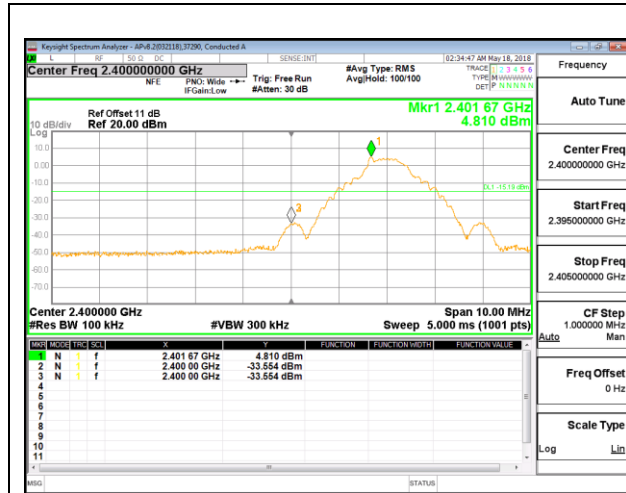

LOW CHANNEL BANDEDGE

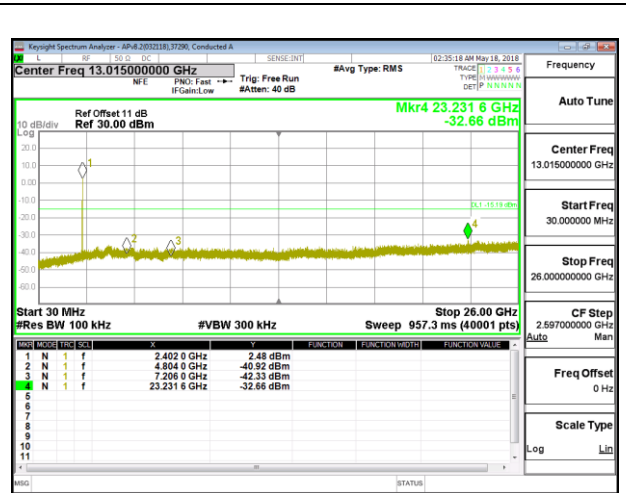

LOW CHANNEL BANDEDGE

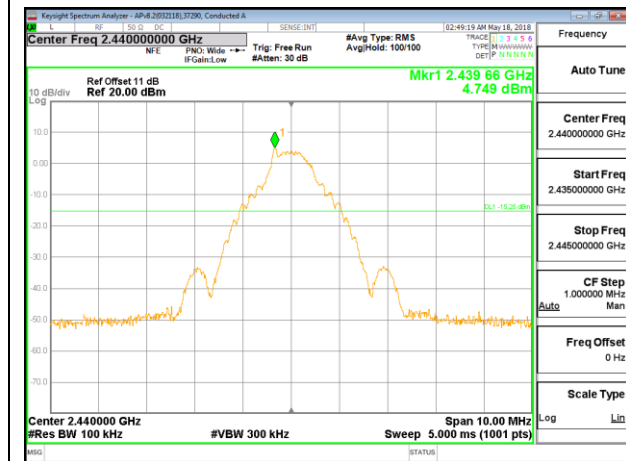

IN-BAND REFERENCE LEVEL

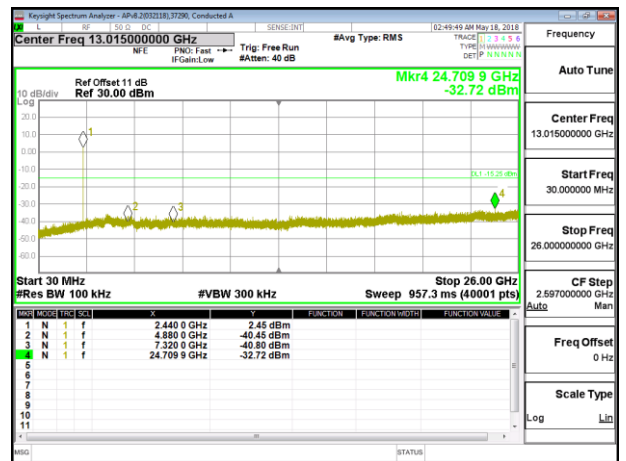

OUT-OF-BAND MID CHANNEL

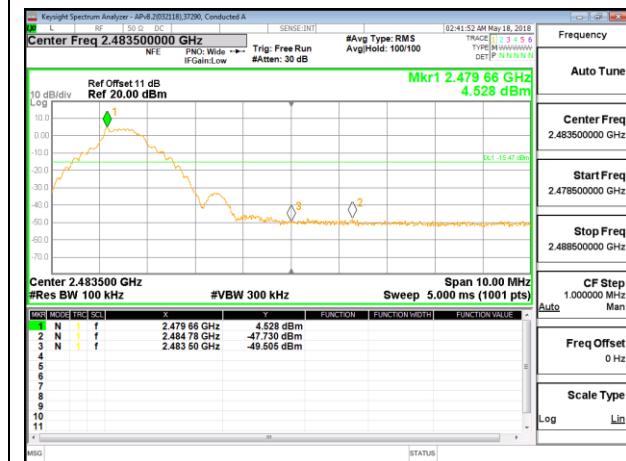

HIGH CHANNEL BANDEDGE

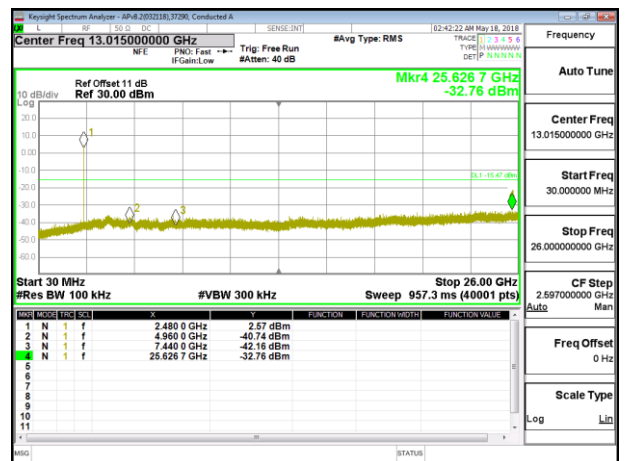

HIGH CHANNEL BANDEDGE

9. RADIATED TEST RESULTS

9.1. LIMITS AND PROCEDURE

LIMITS

FCC §15.205 and §15.209

RSS-GEN, Section 8.9 and 8.10.

Frequency Range (MHz)	Field Strength Limit (uV/m) at 3 m	Field Strength Limit (dBuV/m) at 3 m
0.009-0.490	2400/F(kHz) @ 300 m	-
0.490-1.705	24000/F(kHz) @ 30 m	-
1.705 - 30	30 @ 30m	-
30 - 88	100	40
88 - 216	150	43.5
216 - 960	200	46
Above 960	500	54

TEST PROCEDURE

The EUT is placed on a non-conducting table 80 cm above the ground plane for measurement below 1GHz; 1.5 m above the ground plane for measurement above 1GHz. The antenna to EUT distance is 3 meters. The EUT is configured in accordance with ANSI C63.10. The EUT is set to transmit in a continuous mode.

For measurements below 1 GHz the resolution bandwidth is set to 100 kHz for peak detection measurements or 120 kHz for quasi-peak detection measurements. Peak detection is used unless otherwise noted as quasi-peak.

For pre-scans above 1 GHz the resolution bandwidth is set to 1 MHz; the video bandwidth is set to 30 KHz for peak measurements.

For final measurements above 1 GHz the resolution bandwidth is set to 1 MHz; the video bandwidth is set to 3 MHz for peak measurements and as applicable for average measurements.

The spectrum from 1 GHz to 18 GHz is investigated with the transmitter set to the lowest, middle, and highest channels in each applicable band. Below 1GHz and above 18GHz emissions, the channel with the highest output power was tested.

The frequency range of interest is monitored at a fixed antenna height and EUT azimuth. The EUT is rotated through 360 degrees to maximize emissions received. The antenna is scanned from 1 to 4 meters above the ground plane to further maximize the emission. Measurements are made with the antenna polarized in both the vertical and the horizontal positions.

9.2. TRANSMITTER ABOVE 1 GHz

BANDEDGE (LOW CHANNEL)

HORIZONTAL RESULT

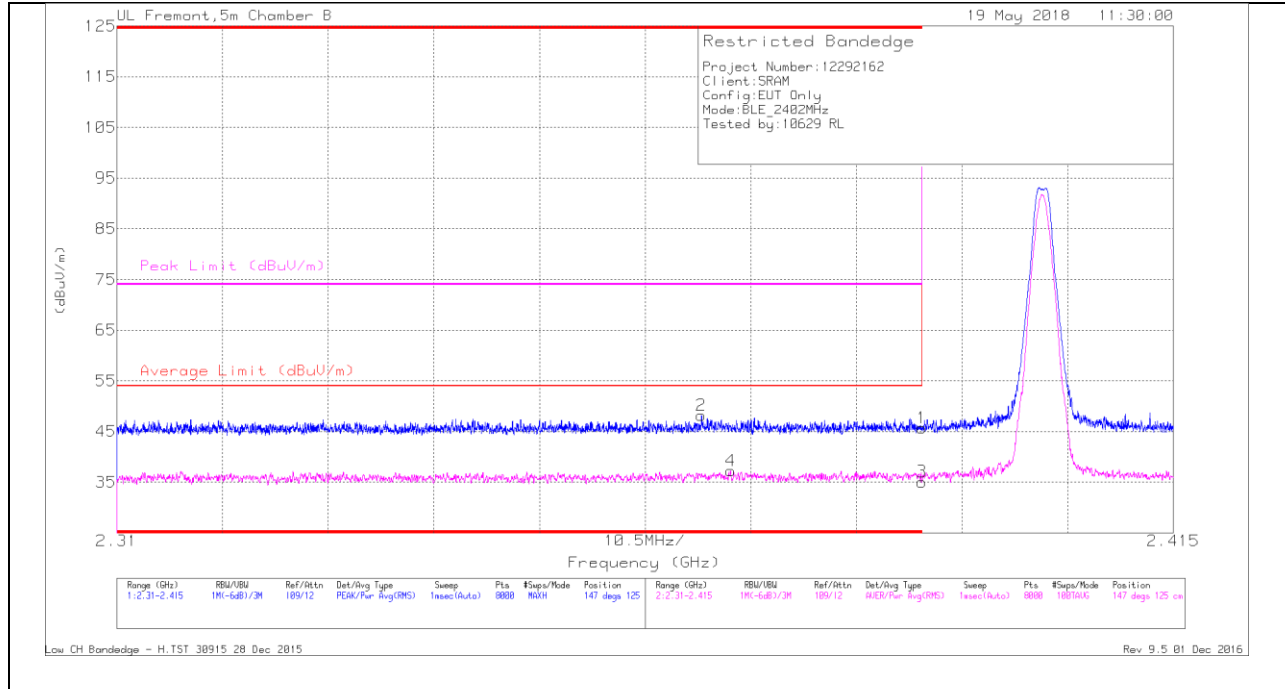

Trace Markers

Marker	Frequency (GHz)	Meter Reading (dBuV)	Det	AF T863 (dB/m)	Amp/Cbl/Filtr/Pad (dB)	DC Corr (dB)	Corrected Reading (dBuV/m)	Average Limit (dBuV/m)	Margin (dB)	Peak Limit (dBuV/m)	PK Margin (dB)	Azimuth (Degs)	Height (cm)	Polarity
1	* 2.39	35.17	Pk	32	-21.5	0	45.67	-	-	74	-28.33	147	125	H
2	* 2.368	37.69	Pk	31.9	-21.4	0	48.19	-	-	74	-25.81	147	125	H
3	* 2.39	24.58	RMS	32	-21.5	0	35.08	54	-18.92	-	-	147	125	H
4	* 2.371	26.6	RMS	31.9	-21.3	0	37.2	54	-16.8	-	-	147	125	H

* - indicates frequency in CFR47 Pt 15 / IC RSS-Restricted Band

Pk - Peak detector

RMS - RMS detection

VERTICAL RESULT

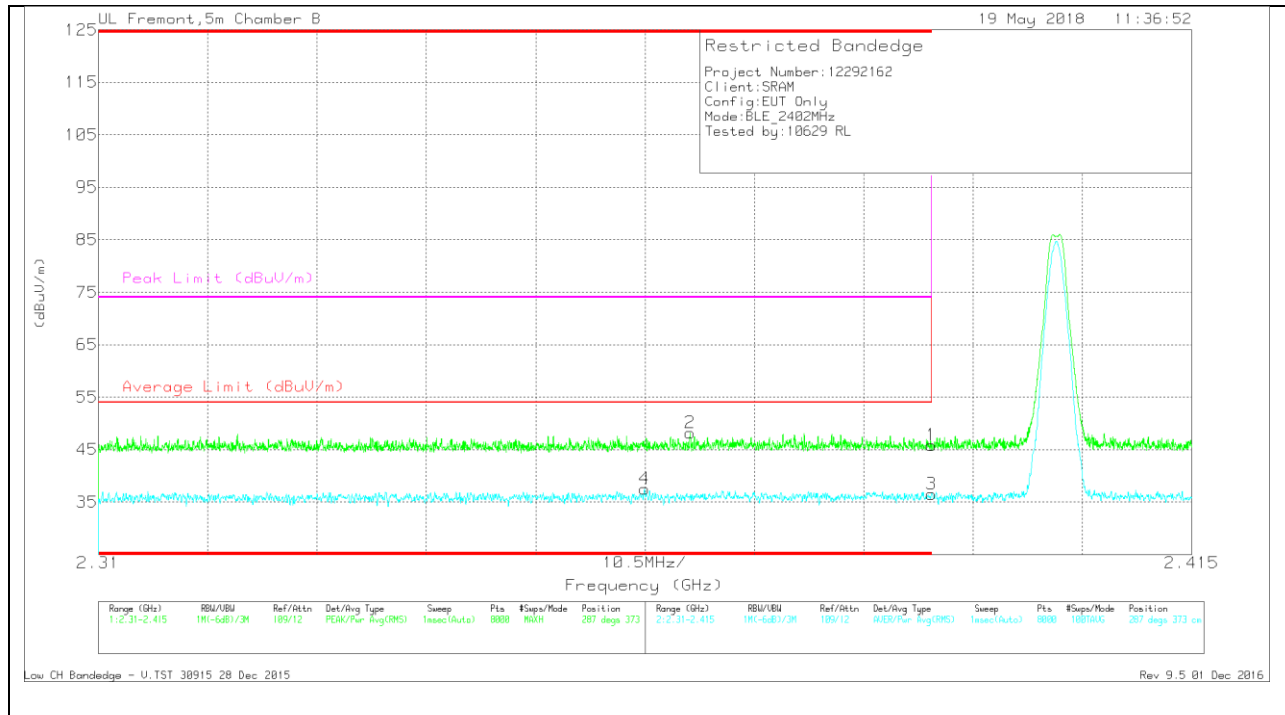

Trace Markers

Marker	Frequency (GHz)	Meter Reading (dBuV)	Det	AF T863 (dB/m)	Amp/Cb/Filtr/Pad (dB)	Corrected Reading (dBuV/m)	Average Limit (dBuV/m)	Margin (dB)	Peak Limit (dBuV/m)	PK Margin (dB)	Azimuth (Degs)	Height (cm)	Polarity
4	* 2.362	27.05	RMS	31.9	-21.5	37.45	54	-16.55	-	-	287	373	V
2	* 2.367	37.72	Pk	31.9	-21.4	48.22	-	-	74	-25.78	287	373	V
1	* 2.39	35.33	Pk	32	-21.5	45.83	-	-	74	-28.17	287	373	V
3	* 2.39	26.03	RMS	32	-21.5	36.53	54	-17.47	-	-	287	373	V

* - indicates frequency in CFR47 Pt 15 / IC RSS-Restricted Band

Pk - Peak detector

RMS - RMS detection

BANDEDGE (HIGH CHANNEL)

HORIZONTAL RESULT

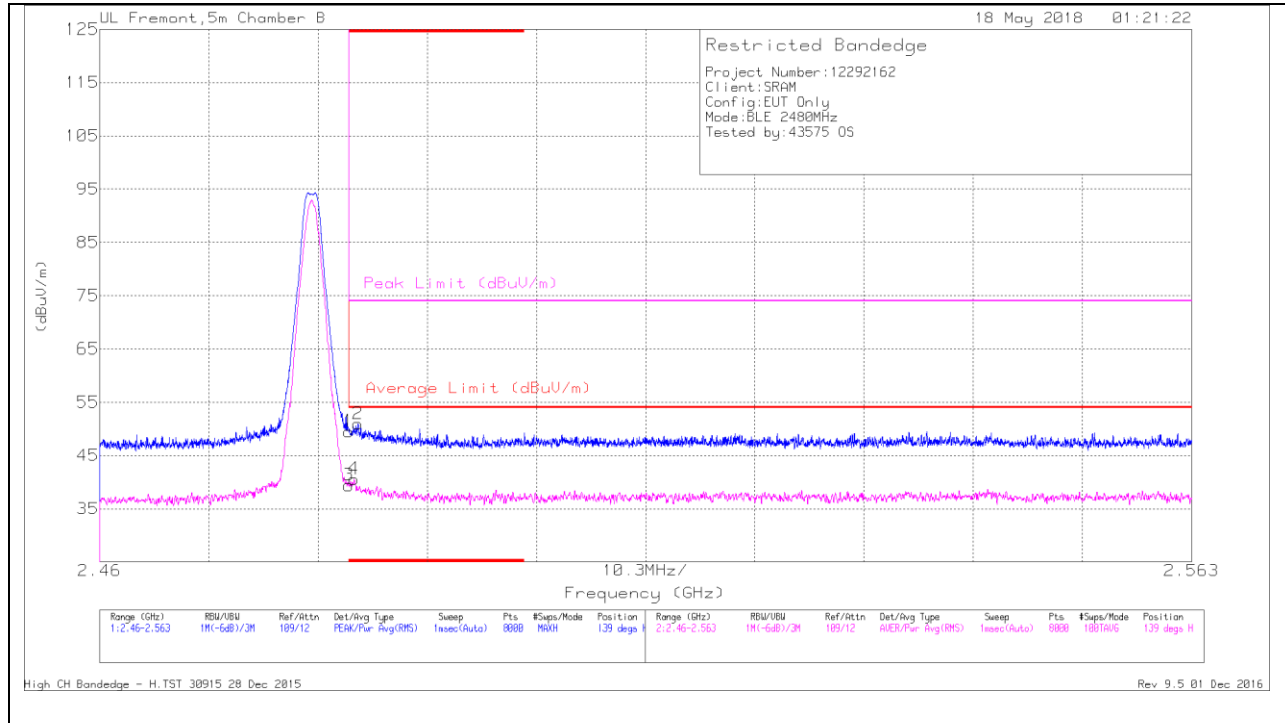

Trace Markers

Marker	Frequency (GHz)	Meter Reading (dBuV)	Det	AF T863 (dB/m)	Amp/Cbl/Filtr/Pad (dB)	DC Corr (dB)	Corrected Reading (dBuV/m)	Average Limit (dBuV/m)	Margin (dB)	Peak Limit (dBuV/m)	PK Margin (dB)	Azimuth (Degs)	Height (cm)	Polarity
1	* 2.484	38.51	Pk	32.5	-21.5	0	49.51	-	-	74	-24.49	139	189	H
2	* 2.484	39.93	Pk	32.5	-21.5	0	50.93	-	-	74	-23.07	139	189	H
3	* 2.484	28.41	RMS	32.5	-21.5	0	39.41	54	-14.59	-	-	139	189	H
4	* 2.484	29.59	RMS	32.5	-21.5	0	40.59	54	-13.41	-	-	139	189	H

* - indicates frequency in CFR47 Pt 15 / IC RSS-Restricted Band

Pk - Peak detector

RMS - RMS detection

VERTICAL RESULT

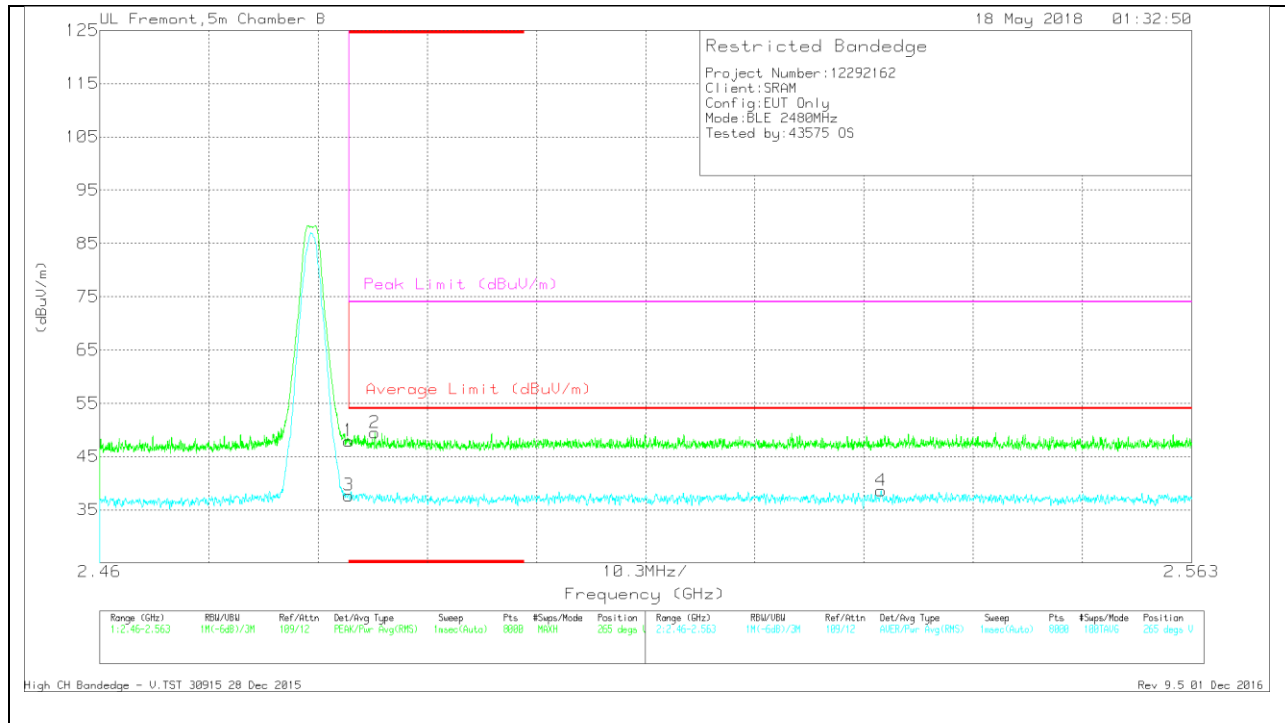

Trace Markers

Marker	Frequency (GHz)	Meter Reading (dBuV)	Det	AF T863 (dB/m)	Amp/Cbl/Filtr/Pad (dB)	DC Corr (dB)	Corrected Reading (dBuV/m)	Average Limit (dBuV/m)	Margin (dB)	Peak Limit (dBuV/m)	PK Margin (dB)	Azimuth (Degs)	Height (cm)	Polarity
1	* 2.484	36.92	Pk	32.5	-21.5	0	47.92	-	-	74	-26.08	265	203	V
3	* 2.484	26.68	RMS	32.5	-21.5	0	37.68	54	-16.32	-	-	265	203	V
2	* 2.486	38.44	Pk	32.5	-21.5	0	49.44	-	-	74	-24.56	265	203	V
4	2.534	27.49	RMS	32.5	-21.4	0	38.59	54	-15.41	-	-	265	203	V

* - indicates frequency in CFR47 Pt 15 / IC RSS-Restricted Band

Pk - Peak detector

RMS - RMS detection

HARMONICS AND SPURIOUS EMISSIONS

LOW CHANNEL RESULTS

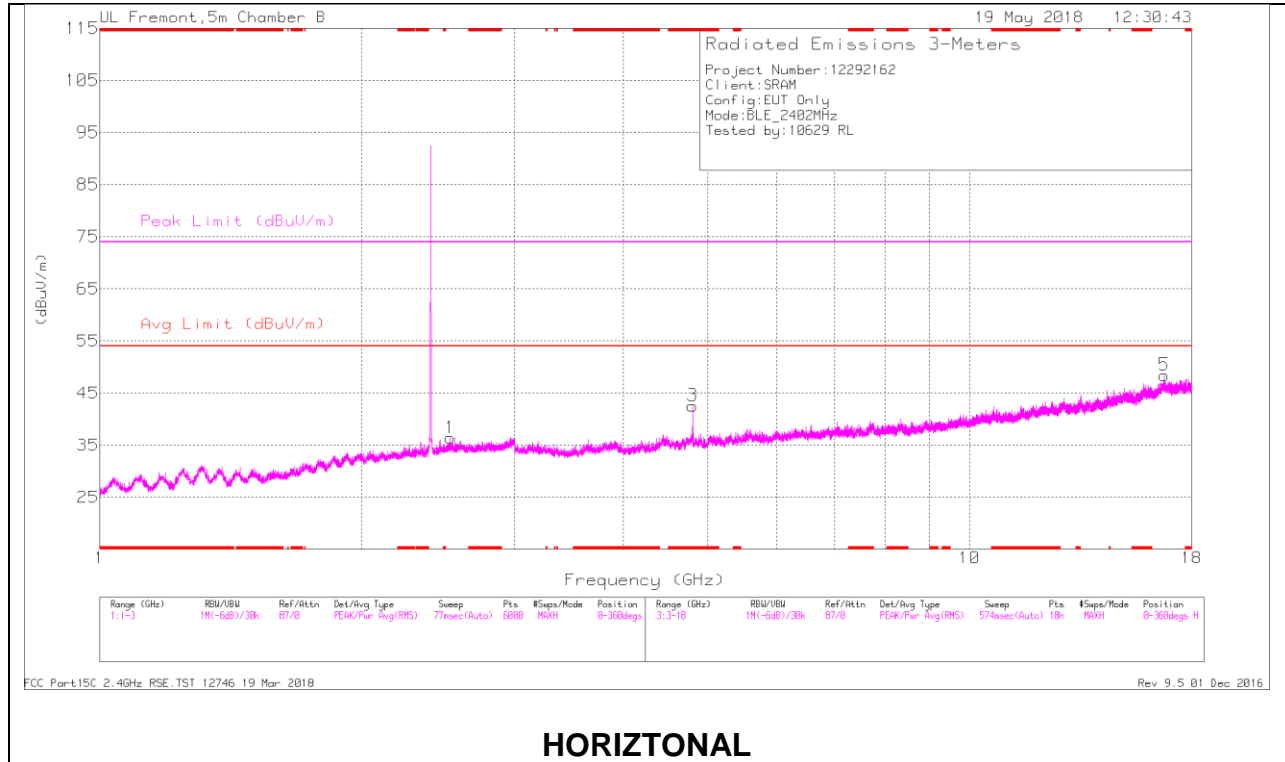

HORIZONTAL

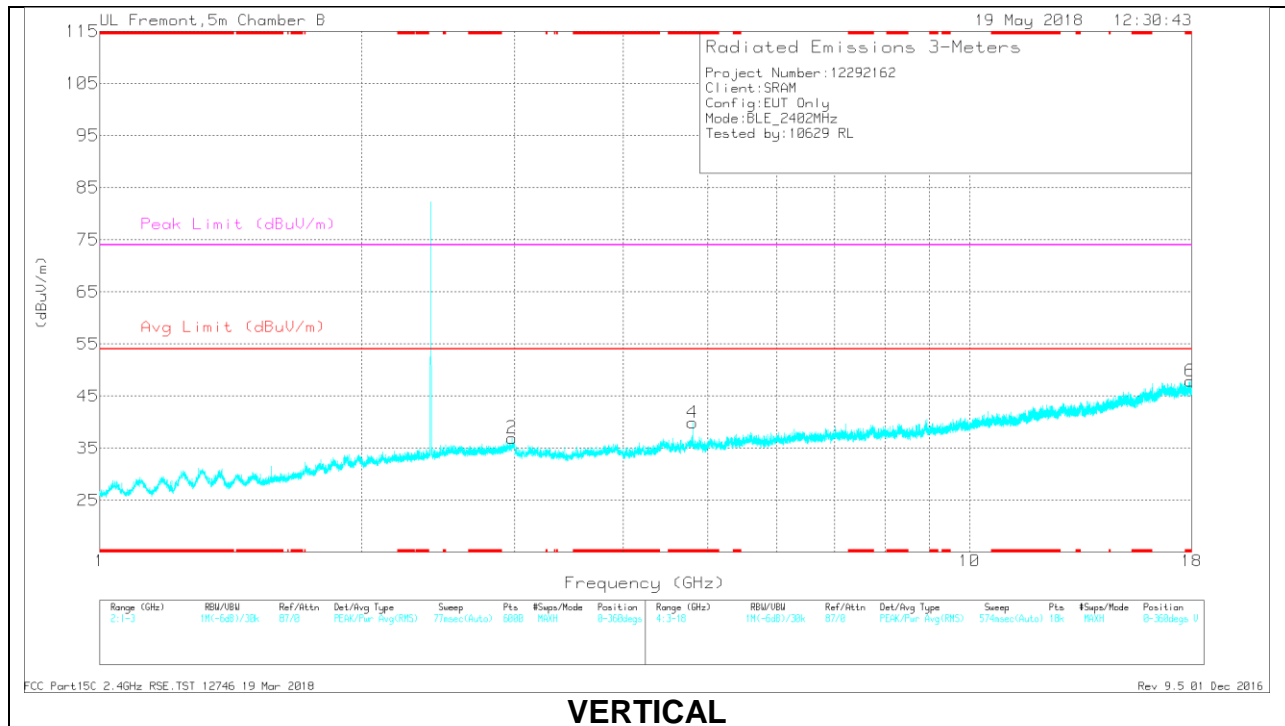

VERTICAL

Radiated Emissions

Marker	Frequency (GHz)	Meter Reading (dBuV)	Det	AF T863 (dB/m)	Amp/Cbl/Filtr/Pad (dB)	DC Corr (dB)	Corrected Reading (dBuV/m)	Avg Limit (dBuV/m)	Margin (dB)	Peak Limit (dBuV/m)	PK Margin (dB)	Azimuth (Degs)	Height (cm)	Polarity
3	* 4.804	44.08	PK2	34.4	-30.2	0	48.28	-	-	74	-25.72	53	106	H
	* 4.804	35.7	MAv1	34.4	-30.1	0	40	54	-14	-	-	53	106	H
4	* 4.804	41.88	PK2	34.4	-30.2	0	46.08	-	-	74	-27.92	194	104	V
	* 4.804	32.59	MAv1	34.4	-30.1	0	36.89	54	-17.11	-	-	194	104	V
6	* 17.939	31.81	PK2	41.6	-20.4	0	53.01	-	-	74	-20.99	241	235	V
	* 17.941	21.2	MAv1	41.6	-20.5	0	42.3	54	-11.7	-	-	241	235	V
1	2.53	25.3	PK	32.5	-21.4	0	36.4	-	-	-	-	0-360	199	H
2	2.981	24.05	PK	32.7	-19.8	0	36.95	-	-	-	-	0-360	102	V
5	16.742	27.53	PK	42.3	-21.4	0	48.43	-	-	-	-	0-360	199	H

* - indicates frequency in CFR47 Pt 15 / IC RSS-Restricted Band

PK2 - KDB558074 Method: Maximum Peak

MAv1 - KDB558074 Option 1 Maximum RMS Average

MID CHANNEL RESULTS

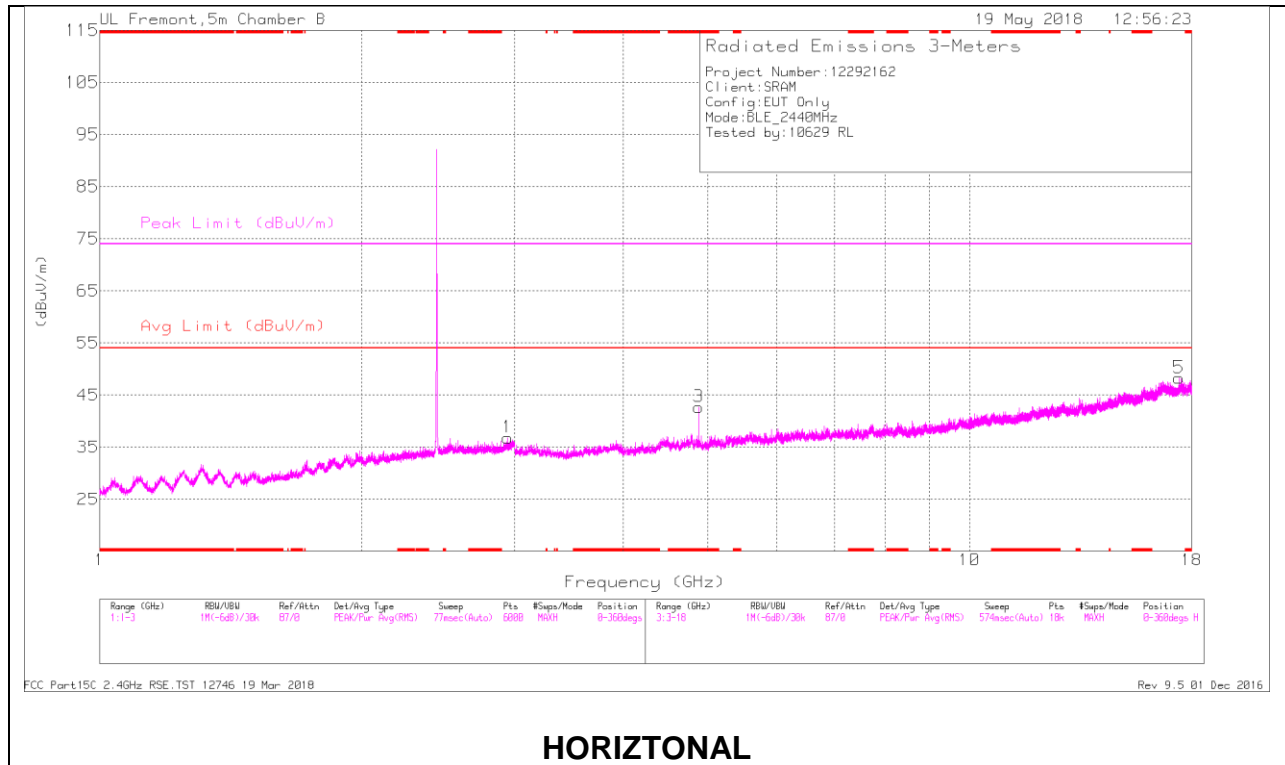

HORIZONTAL

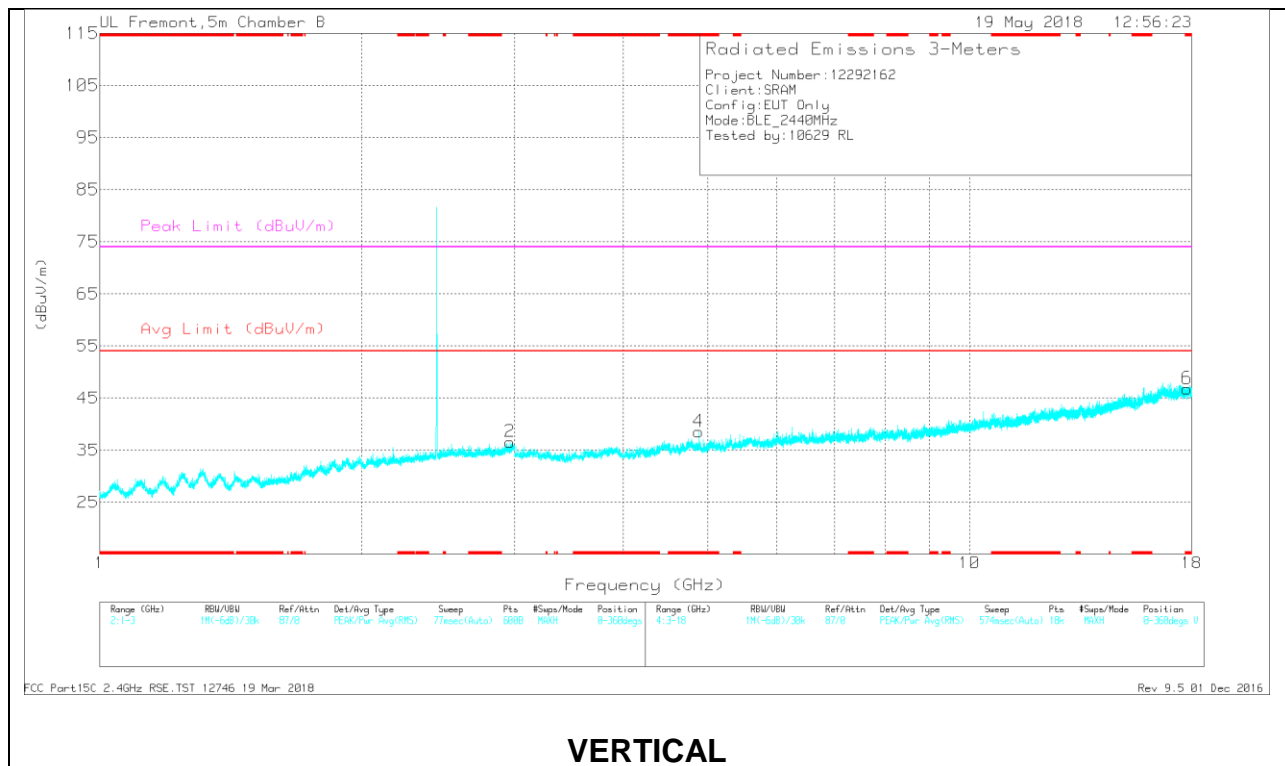

VERTICAL

Radiated Emissions

Marker	Frequency (GHz)	Meter Reading (dBuV)	Det	AF T863 (dB/m)	Amp/Cbl/Filtr/Pad (dB)	DC Corr (dB)	Corrected Reading (dBuV/m)	Avg Limit (dBuV/m)	Margin (dB)	Peak Limit (dBuV/m)	PK Margin (dB)	Azimuth (Degs)	Height (cm)	Polarity
3	* 4.881	44.33	PK2	34.4	-31.4	0	47.33	-	-	74	-26.67	68	138	H
	* 4.88	36.13	MAv1	34.4	-31.4	0	39.13	54	-14.87	-	-	68	138	H
4	* 4.881	41.4	PK2	34.4	-31.4	0	44.4	-	-	74	-29.6	176	197	V
	* 4.88	32.57	MAv1	34.4	-31.4	0	35.57	54	-18.43	-	-	176	197	V
6	* 17.785	31.91	PK2	41.7	-20.9	0	52.71	-	-	74	-21.29	153	230	V
	* 17.785	21.27	MAv1	41.7	-20.9	0	42.07	54	-11.93	-	-	153	230	V
1	2.945	24.34	PK	32.6	-20.1	0	36.84	-	-	-	-	0-360	102	H
2	2.964	23.89	PK	32.7	-20	0	36.59	-	-	-	-	0-360	200	V
5	17.404	27.29	PK	41.7	-20.7	0	48.29	-	-	-	-	0-360	199	H

* - indicates frequency in CFR47 Pt 15 / IC RSS-Restricted Band

PK2 - KDB558074 Method: Maximum Peak

MAv1 - KDB558074 Option 1 Maximum RMS Average

HIGH CHANNEL RESULTS

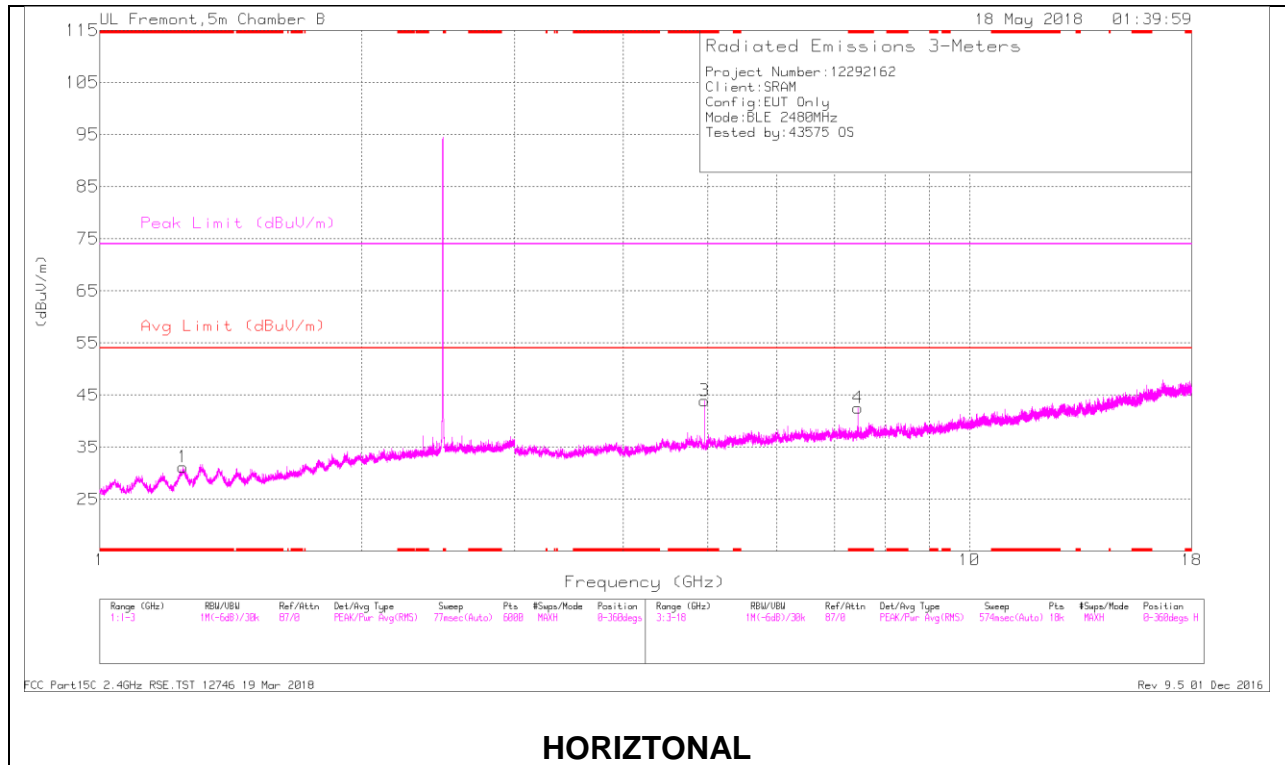

HORIZONTAL

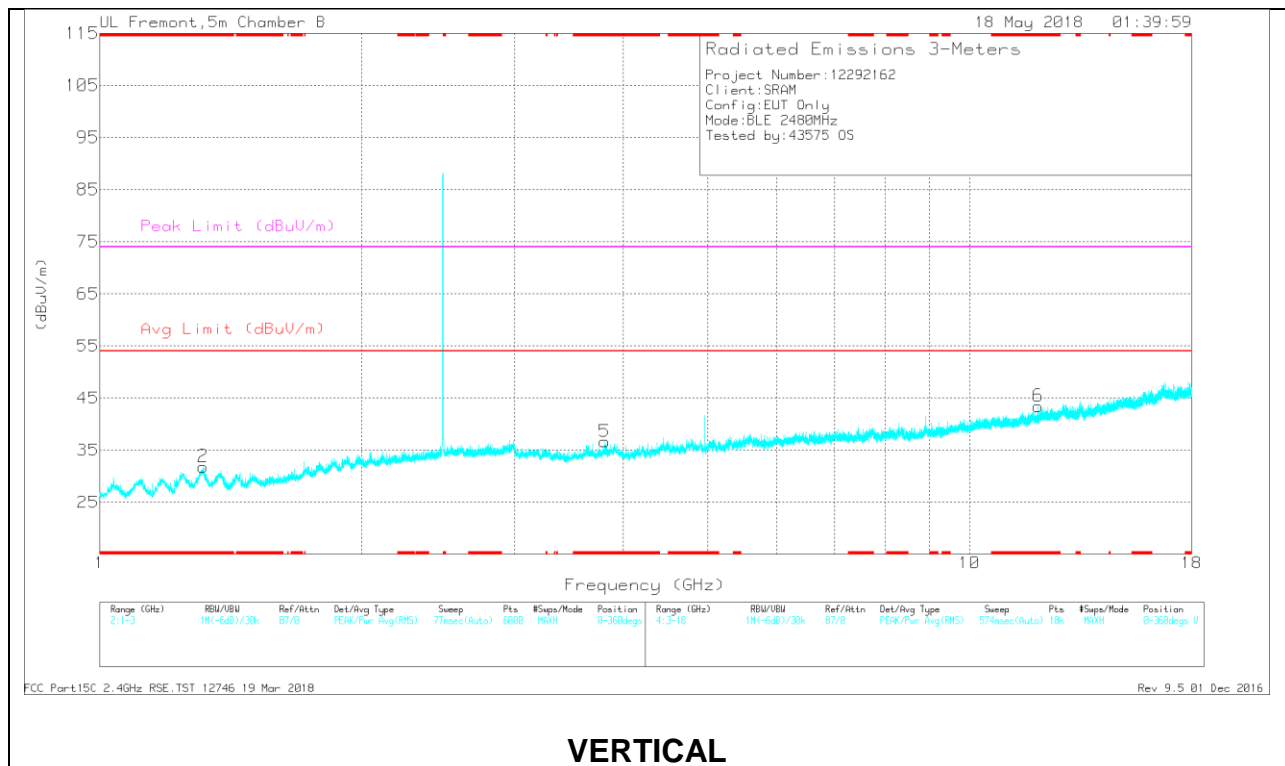

VERTICAL

Radiated Emissions

Marker	Frequency (GHz)	Meter Reading (dBuV)	Det	AF T863 (dB/m)	Amp/Cbl/Filtr/Pad (dB)	DC Corr (dB)	Corrected Reading (dBuV/m)	Avg Limit (dBuV/m)	Margin (dB)	Peak Limit (dBuV/m)	PK Margin (dB)	Azimuth (Degs)	Height (cm)	Polarity
1	* 1.247	31.54	PK2	28.7	-22.5	0	37.74	-	-	74	-36.26	319	178	H
	* 1.245	19.2	MAv1	28.7	-22.6	0	25.3	54	-28.7	-	-	319	178	H
2	* 1.315	30.64	PK2	28.9	-22	0	37.54	-	-	74	-36.46	86	204	V
	* 1.313	18.82	MAv1	28.9	-22	0	25.72	54	-28.28	-	-	86	204	V
3	* 4.961	45.41	PK2	34.4	-30.9	0	48.91	-	-	74	-25.09	169	143	H
	* 4.96	38.06	MAv1	34.4	-30.9	0	41.56	54	-12.44	-	-	169	143	H
4	* 7.439	38.96	PK2	35.9	-27.7	0	47.16	-	-	74	-26.84	310	109	H
	* 7.439	29.17	MAv1	35.9	-27.7	0	37.37	54	-16.63	-	-	310	109	H
5	* 3.805	40.07	PK2	33.5	-31.3	0	42.27	-	-	74	-31.73	347	166	V
	* 3.809	28.4	MAv1	33.5	-31.4	0	30.5	54	-23.5	-	-	347	166	V
6	* 11.991	33.16	PK2	38.8	-24.5	0	47.46	-	-	74	-26.54	219	317	V
	* 11.991	22.15	MAv1	38.8	-24.5	0	36.45	54	-17.55	-	-	219	317	V

* - indicates frequency in CFR47 Pt 15 / IC RSS-Restricted Band

PK2 - KDB558074 Method: Maximum Peak

MAv1 - KDB558074 Option 1 Maximum RMS Average

9.3. WORST CASE BELOW 30MHz

SPURIOUS EMISSIONS BELOW 30 MHz (WORST-CASE CONFIGURATION)

FACE ON AND FACE OFF PLOTS

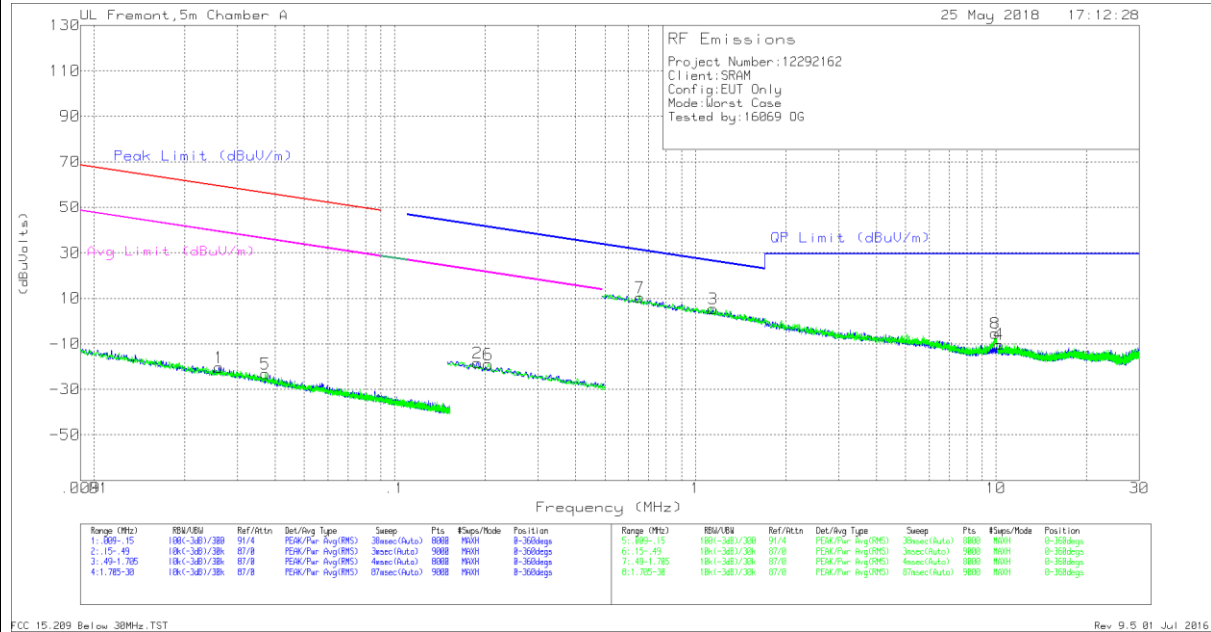

NOTE: KDB 414788 OATS and Chamber Correlation Justification

- Based on FCC 15.31 (f) (2): measurements may be performed at a distance closer than that specified in the regulations; however, an attempt should be made to avoid making measurements in the near field.
- OATs and chamber correlation testing had been performed and chamber measured test result is the worst case test result.

Below 30MHz DATA

Marker	Frequency (MHz)	Meter Reading (dBuV)	Det	Loop Antenna (dB/m)	Cbl (dB)	Dist Corr 300m	Corrected Reading (dBuVolts)	Peak Limit (dBuV/m)	Margin (dB)	Avg Limit (dBuV/m)	Margin (dB)	Peak Limit (dBuV/m)	Margin (dB)	Avg Limit (dBuV/m)	Margin (dB)	Azimuth (Degs)
1	.02605	44.3	Pk	15.2	.1	-80	-20.4	59.27	-79.67	39.27	-59.67	-	-	-	-	0-360
5	.03717	41.66	Pk	15.1	.1	-80	-23.14	56.18	-79.32	36.18	-59.32	-	-	-	-	0-360
2	.18872	47.6	Pk	13.9	.1	-80	-18.4	-	-	-	-	42.1	-60.5	22.1	-40.5	0-360
6	.20454	47.01	Pk	13.9	.1	-80	-18.99	-	-	-	-	41.4	-60.39	21.4	-40.39	0-360

Pk - Peak detector

Marker	Frequency (MHz)	Meter Reading (dBuV)	Det	Loop Antenna (dB/m)	Cbl (dB)	Dist Corr 30m	Corrected Reading (dBuVolts)	QP Limit (dBuV/m)	Margin (dB)	Peak Limit (dBuV/m)	Margin (dB)	Avg Limit (dBuV/m)	Margin (dB)	Azimuth (Degs)
7	.65424	36.25	Pk	14	.1	-40	10.35	31.3	-20.95	-	-	-	-	0-360
3	1.14706	30.91	Pk	14.3	.2	-40	5.41	26.43	-21.02	-	-	-	-	0-360
8	9.94542	19.54	Pk	14.7	.4	-40	-5.36	29.5	-34.86	-	-	-	-	0-360
4	10.23729	14.59	Pk	14.7	.5	-40	-10.21	29.5	-39.71	-	-	-	-	0-360

Pk - Peak detector

9.4. WORST CASE BELOW 1 GHz

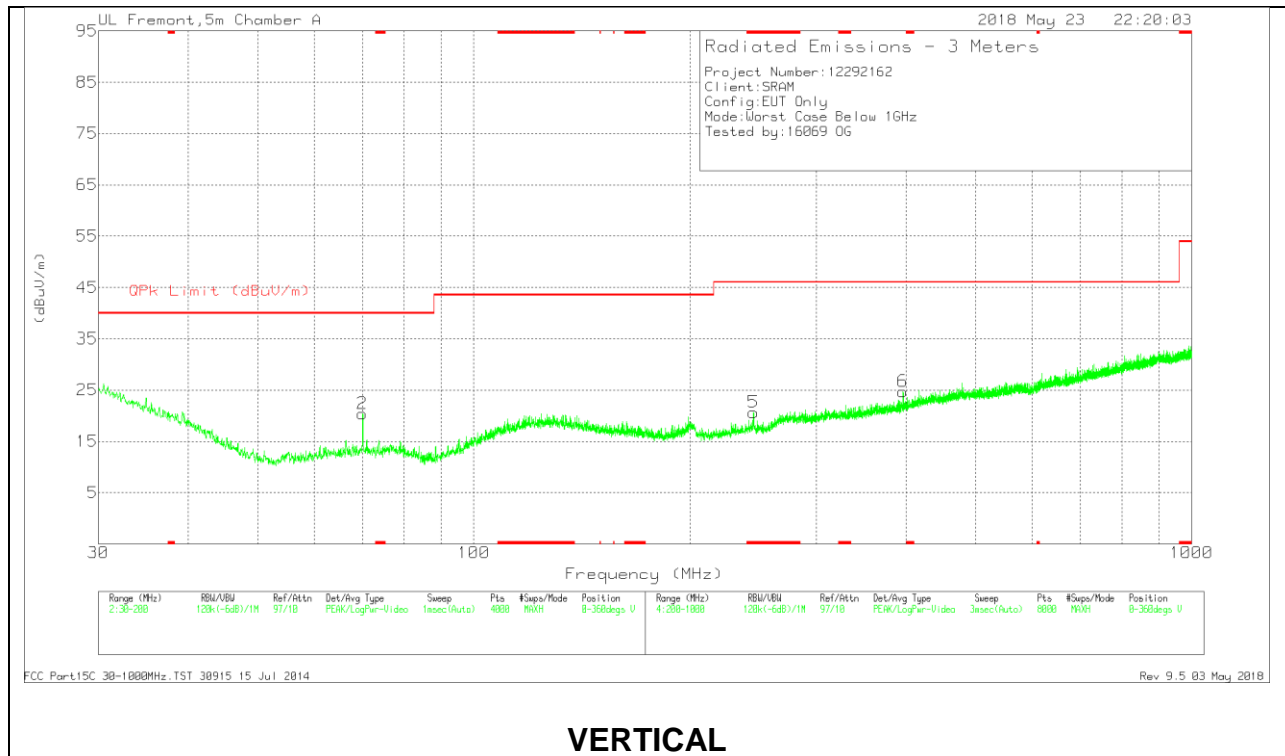
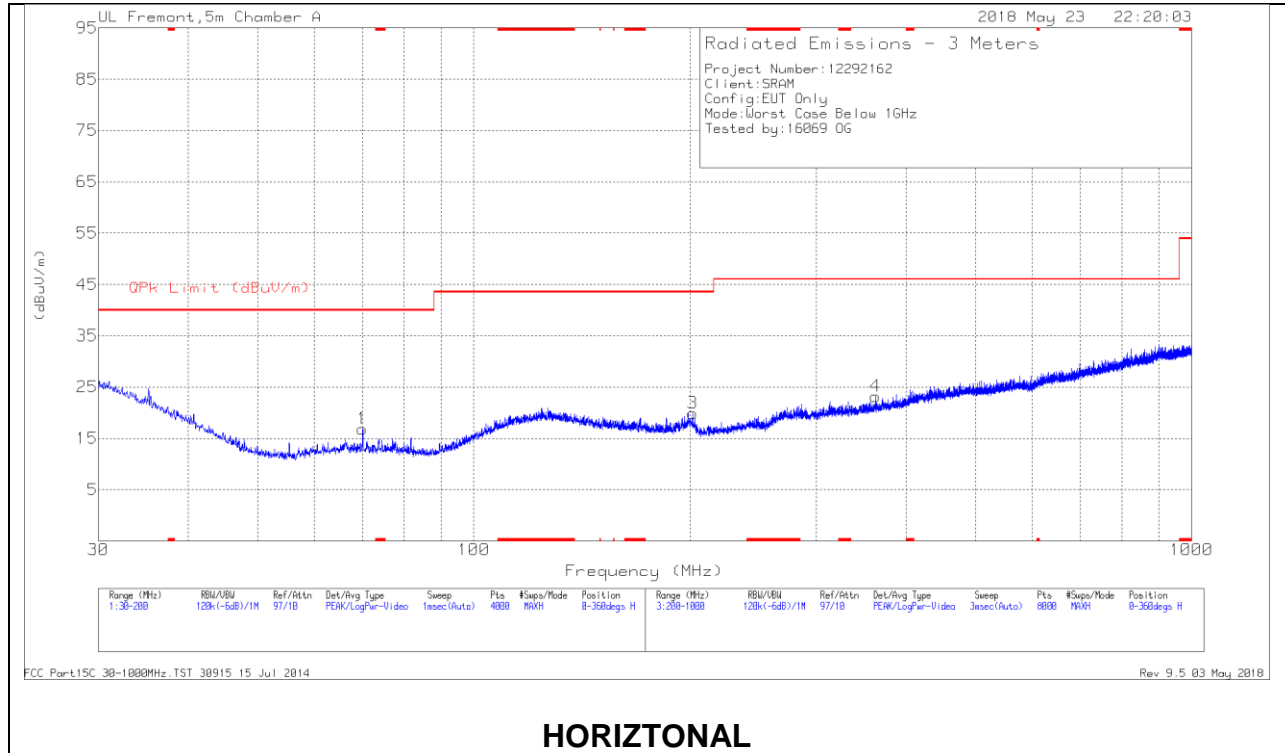

Below 1GHz Data

Marker	Frequency (MHz)	Meter Reading (dBuV)	Det	AFT130 (dB/m)	Amp/Cbl (dB/m)	Corrected Reading (dBuV/m)	QPk Limit (dBuV/m)	Margin (dB)	Azimuth (Degs)	Height (cm)	Polarity
5	* 245.3059	30.09	Pk	15.5	-24.9	20.69	46.02	-25.33	0-360	100	V
1	70.0029	31.45	Pk	12.1	-26.7	16.85	40	-23.15	0-360	100	H
2	70.0029	34.94	Pk	12.1	-26.7	20.34	40	-19.66	0-360	100	V
3	201.7002	28.92	Pk	16.2	-25.2	19.92	43.52	-23.6	0-360	200	H
4	362.9212	29.32	Pk	18.7	-24.8	23.22	46.02	-22.8	0-360	300	H
6	396.3255	30.45	Pk	19.4	-25.1	24.75	46.02	-21.27	0-360	100	V

* - indicates frequency in CFR47 Pt 15 / IC RSS-Restricted Band
 Pk - Peak detector

9.5. WOSRT CASE 18-26 GHz

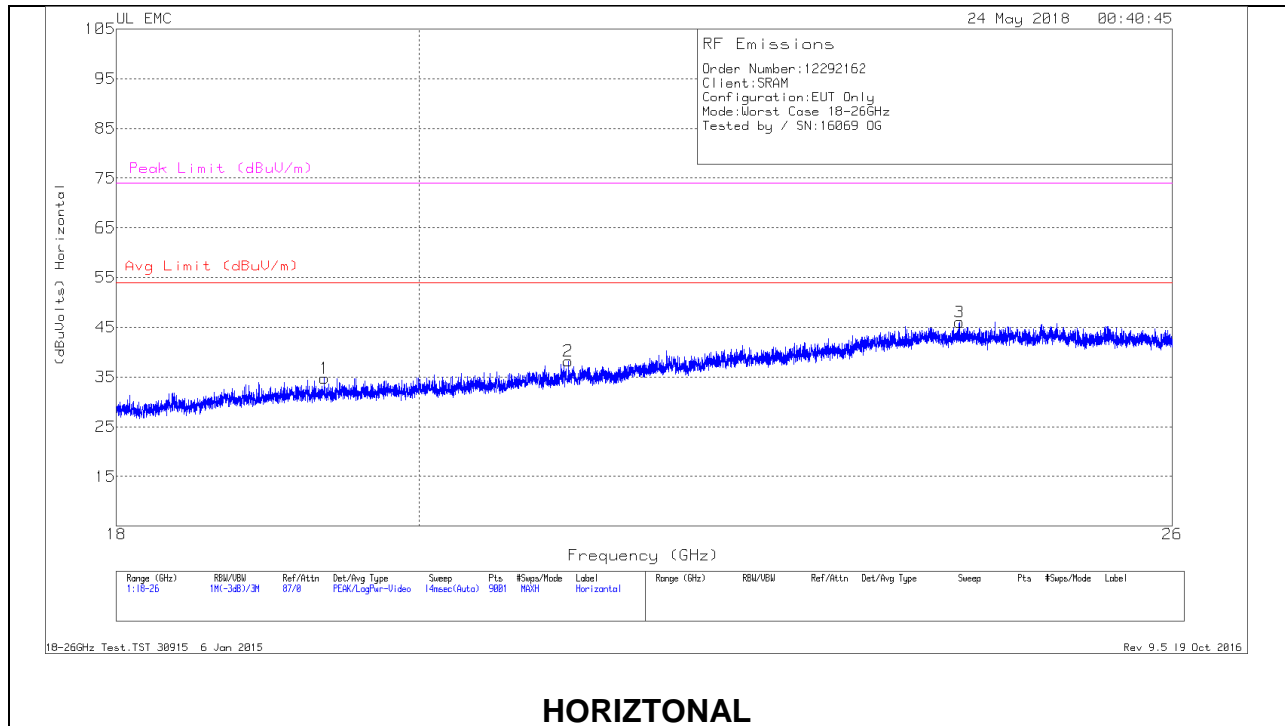

HORIZTONTAL

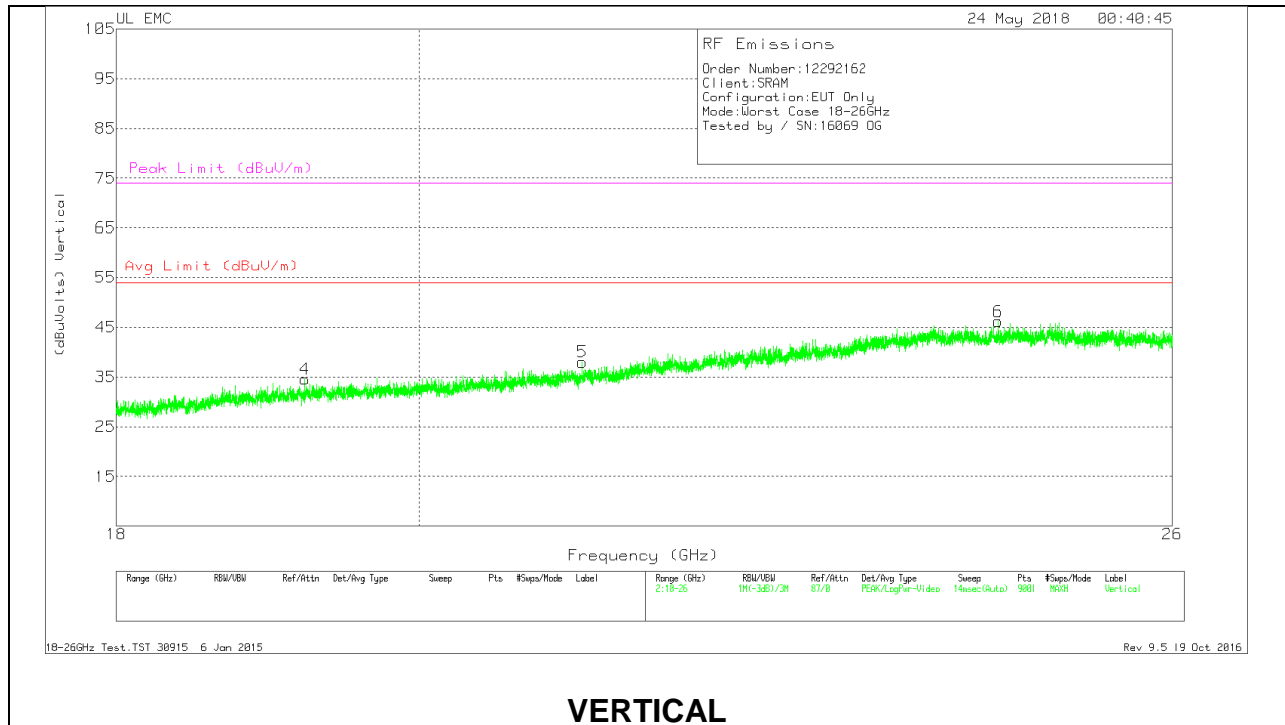

VERTICAL

18 – 26GHz DATA

Marker	Frequency (GHz)	Meter Reading (dBuV)	Det	T449 AF (dB/m)	Amp/Cbl (dB)	Dist Corr (dB)	Corrected Reading (dBuVolts)	Avg Limit (dBuV/m)	Margin (dB)	Peak Limit (dBuV/m)	PK Margin (dB)
1	19.353	36.48	Pk	32.6	-24.8	-9.5	34.78	54	-19.22	74	-39.22
2	21.068	39.79	Pk	33.2	-25.3	-9.5	38.19	54	-15.81	74	-35.81
3	24.142	45.94	Pk	33.9	-24.3	-9.5	46.04	54	-7.96	74	-27.96
4	19.22	36.25	Pk	32.6	-24.8	-9.5	34.55	54	-19.45	74	-39.45
5	21.17	39.51	Pk	33.1	-25.1	-9.5	38.01	54	-15.99	74	-35.99
6	24.469	45.98	Pk	34	-24.3	-9.5	46.18	54	-7.82	74	-27.82

Pk - Peak detector