

# Certification of Compliance

CFR 47 Part 15 Subpart B

Test Report File No. :	08-IST-0357	Date of Issue :	May 30, 2008
Model(s)	DLA-32C7, C32HDGB		
Kind of Product	32" LCD Monitor		
FCC ID	C5FDLA32C7		
Applicant	Daewoo Electronics Corporation.		
Address	543, Dangjung-Dong, Kunpo-City, Kyounggi-DO, Korea		
Manufacturer	Daewoo Electronics Corporation.		
Address	295, Kongdan-dong, Kumi-city, Kyungsangbuk-do, Korea.		

## Test Result

Positive

Negative

Reviewed By

Approved By



S.J. Cho / EMC Group Manager



J.H. Lee / Chief

## Comment (s)

- Investigations requested : Measurement to the relevant clauses of FCC rules and regulations Part 15 Subpart B - Unintentional Radiators, Class B.
- This report issued because the PDP panel is changed.
- The original report number : 07-IST-0365
- The test report with appendix consists of 16 pages.
- The test result only responds to the tested sample.
- It is not allowed to copy this report even partly without the allowance of IST EMC Laboratory.
- This equipment as for has been shown to be capable of continued compliance with the applicable technical standards as indicated in the measurement report and was tested in accordance with the measurement procedures specified in ANSI C63.4 2003.



## TABLE OF CONTENTS

Table of contents			2
Information of test laboratory, Environmental conditions, Power used, Product information			3
Descriptions of test			
Conducted Emission			4
Radiated Emission			5
Equipment Under Test			6
Summary			7
■ Test Conditions and Data - Emissions			
◆ Conducted Emissions	0.15 MHz - 30 MHz	Applicable	
Test Conditions / Data and Plots			8-10
◆ Radiated Emissions	30MHz - 1 GHz	Applicable	
Test Conditions / Data and Plots			11-12
■ Appendix			
A. The Photos of Test Setup			13-14
B. The Photos of Equipment Under Test			15-16

Note:

## INFORMATIONS OF TEST LABORATORY

EMC LABORATORY of IST Co., Ltd. (*FCC Filing Lab.*)

400-19, Singal-Dong, Giheung-Gu, Yongin-Si,

Gyeonggi-Do, 446-599, Korea

TEL : +82 31 326 6700

FAX : +82 31 326 6797

## ENVIRONMENTAL CONDITIONS

Temperature	19 °C
Humidity	45 %
Atmospheric pressure	1016 mbar

## POWER SUPPLY SYSTEM USED

Power supply system	120 Vac, 60 Hz (Refer to the product information)
---------------------	--

## PRODUCT INFORMATION

Power Source	120 V~, 60 Hz
Power Consumption	120 W (Max.)
Screen Size	32"
Aspect Ratio	16:9
Resolution	1366 x 768(WXGA)
Contrast Ratio	3000:1
Pixel Pitch	170.25 x 510.25 um x RGB
TV System	NTSC, ATSC
Dimension (WxHxD)	806 x 626.5x 230 mm
Applied PDP panel	LC320WXN (LG Philips LCD)

- EMC suppression device is not used during the test.
- Please refer to user's manual.

## DESCRIPTIONS OF TEST

### Conducted Emissions:

The measurement were performed over the frequency range of 0.15 MHz to 30 MHz using a 50 Ω/50 uH LISN as the input transducer to a Spectrum Analyzer or a Field Intensity Meter. The measurements were made with the detector set for "Peak" amplitude within a bandwidth of 10 KHz or for "quasi-peak" & "Average" within a bandwidth of 9 KHz.

#### -Procedure of Test

The line-conducted facility is located inside a shielded room No.1. A 1 m X 1.5 m wooden table 80cm height is placed 40 cm away from the vertical wall and 1.5 m away from the other wall of the shielded room. The Hyup-Rip KNW-407 and EMCO 3725/2 LISN are bonded to bottom of the shielded room. The EUT is located on the wooden table with distance more than 80 cm from the LISN and powered from the EMCO LISN .The peripheral equipment is powered from the other LISN. Power to the LISNs are filtered by a noise cut power line filters. All electrical cables are shielded by braided tinned steel tubing with inner φ 1.2 cm. If the EUT is a DC-powered device, power will be derived from the source power supply it normally will be powered from and this supply lines will be connected to the EMCO LISN. All interconnecting cables more than 1m were shortened by non-inductive bundling to a 1m length. Sufficient time for the EUT, support equipment, and test equipment was allowed in order for them to warm up to their normal operating conditions. The RF output of the LISN was connected to the R/S receiver to determine the frequency producing the maximum emission from the EUT. The frequency producing the maximum level was reexamined using Quasi-Peak mode by manual measurement, after scanned by automatic Peak mode for frequency range from 0.15 to 30 MHz. The bandwidth of the receiver was set to 10 kHz. The EUT, peripheral equipment, and interconnecting cables were arranged and manipulated to maximize each EME emission.

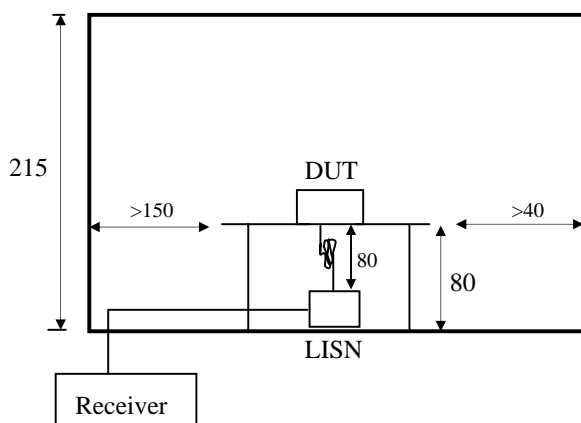

< Side View >

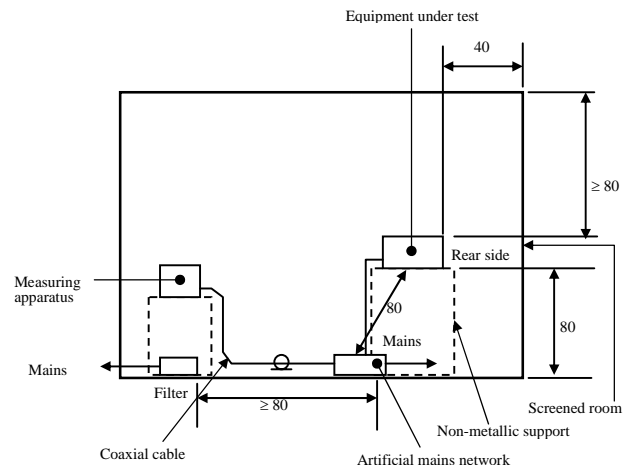

< Concept Drawing >

## DESCRIPTION OF TEST

### Radiated Emissions:

The measurement was performed over the frequency range of 30 MHz to 1 GHz using antenna as the input transducer to a Spectrum analyzer or a Field Intensity Meter. The measurement was made with the detector set for "quasi-peak" within a bandwidth of 120 KHz.

#### -Procedure of Test

Preliminary measurements were made at 3 meter using bi-conical and log-periodic antennas, and spectrum analyzer to determine the frequency producing the max. emission in anechoic chamber. Appropriate precaution was taken to ensure that all emission from the EUT were maximized and investigated. The system configuration, mode of operation, turn-table azimuth and height with respect to the antenna were noted for each frequency found. The spectrum was scanned from 30 MHz to 1000 MHz using S/B bi-log antenna. Above 1GHz, linearly polarized double ridge horn antennas were used. Final measurements were made at open site with 3-meters test distance using S/B bi-log antenna or horn antenna. The OATS have been verified in regular for its normalized site attenuation. The test equipment was placed on a wooden table. Sufficient time for the EUT, peripheral equipment, and test equipment was allowed in order for them to warm up to their normal operating condition. Each frequency found during pre-scan measurements was re-examined by manual. The detector function was set to CISPR quasi-peak mode and the bandwidth of the receiver was set to 120 kHz or 1 MHz depending on the frequency of type of signal. The EUT, peripheral equipment and interconnecting cables were re-configured to the set-up producing the max. emission for the frequency and were placed on top of a 0.8-meter high nonmetallic 1 x 1.5 meter table. The EUT, peripheral equipment, and interconnecting cables were re-arranged and manipulated to maximize each emission. The turntable containing the system was rotated; the antenna height was varied 1 to 4 meters and stopped at the azimuth or height producing the maximum emission. Each emission was maximized by: varying the mode of operation to the EUT and/or peripheral equipment and changing the polarity of the antenna, whichever determined the worst-case emission.

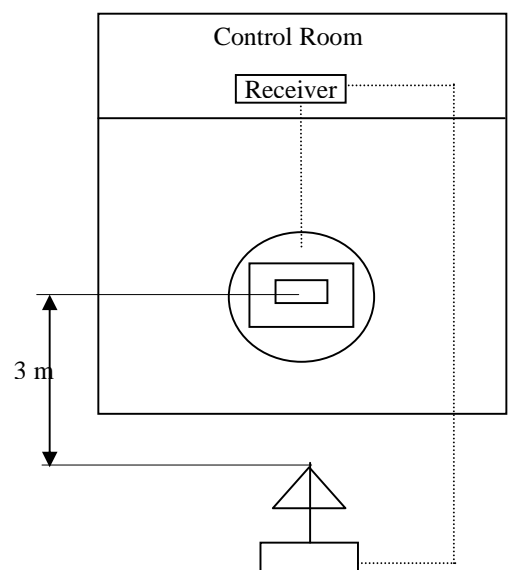
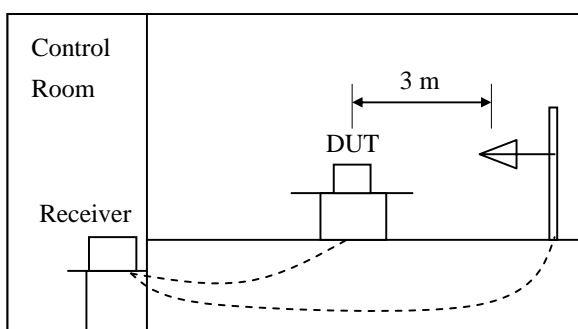

## Equipment Under Test

**EUT Type :**

- Table-Top.  Floor-Standing.  
 Table-Top and Floor-Standing(Combination).

**Operation - mode of the E.U.T. :**

The equipment under test was operated during the measurement under following conditions :

- Standby Mode  
 Operational Condition :  1280 x 1024, 75 Hz

The test results of followings are the representative of worst case emissions for the available resolution can be adjusted.

It is investigated the emission characteristic for RGB mode.

**Configuration of the equipment under test :**

Following peripheral devices and interface cables were connected during the measurement :

Equipment	Type	Brand	Serial No.	FCC Compliance Info.
PC	Dx7200 MT	HP	CNG60809T2	DoC
Keyboard	SK-2885	HP	N/A	DoC
PS/2 Mouse	M-UV96	HP	N/A	DoC
Printer	A0302380	Northern Telecom	2516S60951	DS46XU225C-L
Serial Mouse	M-M28	Logitech	LCA53305547	DZL210365
DVD Player	DVP-NS92V	SONY	2002138	DoC
DVD Player	DRH-8105	Daewoo Electronics	N/A	DoC

**Connecting Interface Cables :**

- Unshielded AC power cable(with one ferrite core) : 1.8 m
- Shielded monitor's signal cable (with two ferrite core) : 1.5 m
- Shielded Printer's signal cable (without ferrite core) : 1.8 m
- PC Audio In cable (without ferrite core) 1.5 m

Note :

## SUMMARY

### Emissions

#### ■ Conducted Emission

The requirements are  MET  Not MET  
Minimum limit margin 7.49 dB at 0.150 MHz  
Maximum limit exceeding

**Remarks : Limits are kept with more 3dB margin.**

**With quasi-peak detect mode and neutral phase.**

Find the test data in following pages 9 to 10.

#### ■ Radiated Emission

The requirements are  MET  Not MET  
Minimum limit margin 3.68 dB at 519.03 MHz  
Maximum limit exceeding

**Remarks : Limits are kept with more 3dB margin.**

**At 1280 x 1024, 75 Hz.**

Find the test data in following page 12.

### Test Date

Begin of testing : March 18, 2008

End of testing : March 20, 2008

Prepared By

Note :

- means the test is applicable,
- is not applicable.



I.Y. Lee / Research Engineer

## TEST CONDITIONS AND DATA

### Conducted Emissions

#### [Applicable]

#### ◆ Test Equipment Used

The test equipment used is calibrated in regular for every year.

<u>Model Name</u>	<u>Manufacturer</u>	<u>Descriptions</u>	<u>Calibration Date</u>	<u>Serial Number</u>
ESCI	Rohde & Schwarz	EMI Test Receiver	June 26, 2007	100373
KNW-407	Hyup-Rip	LISN	Oct. 11, 2007	8-833-10
ESH3-Z2	Rohde & Schwarz	Pulse Limiter	May 21, 2008	357.8810.52

#### ◇ Auxiliary Equipment Used

<u>Model Name</u>	<u>Manufacturer</u>	<u>Descriptions</u>
-------------------	---------------------	---------------------

#### ◇ Accessories including cables

<u>Name</u>	<u>Length</u>	<u>Port and Descriptions</u>
-------------	---------------	------------------------------

#### ◆ Environmental Conditions

Temperature	19 °C
Humidity	18 %
Atmosphere pressure	1016 mbar

◆ Test Program                      See Test configuration page 6.

◆ Test Date                            March 18, 2008

◆ Test Area                             Conducted Room

Note : The equipment used is calibrated in regular for every year.

The test results of followings are the representative of the worst case emissions for resolutions that are available.



**Conducted Emissions**



RBW 9 kHz  
 MT 100 ms  
 PREAMP OFF

Att 10 dB

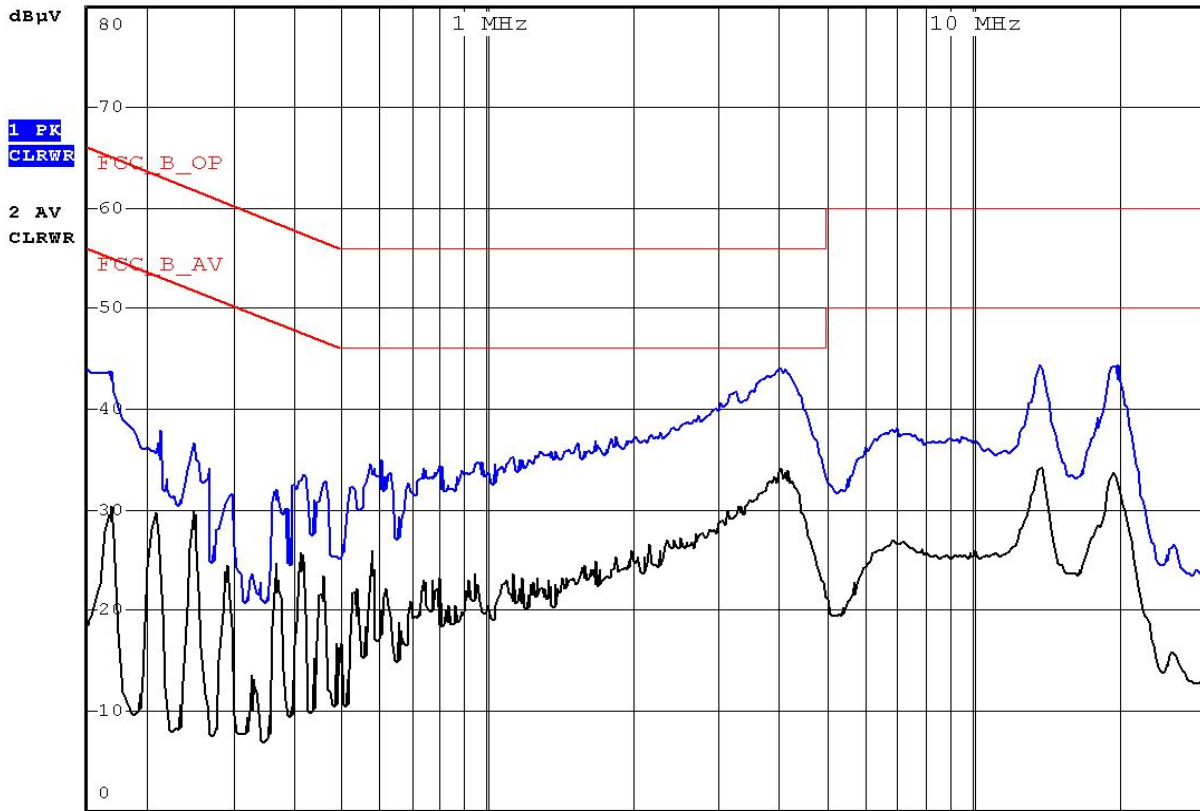

150 kHz 30 MHz

Model Name : DLA-32C7  
 120 Vac 60 Hz Phase : Live

Freq. [MHz]	Measurement [dB µV]		Limit [dB µV]		Insertion Loss [dB]	Cable Loss [dB µV]	Result [dB µV]		Margin [dB]	
	Q-peak	Average	Q-peak	Average			Q-peak	Average	Q-peak	Average
0.150	57.37	40.03	66.00	56.00	0.16	0.80	58.33	40.99	7.67	15.01
0.180	50.59	38.05	64.49	54.49	0.19	0.80	51.58	39.04	12.91	15.45
0.242	40.18	26.24	62.03	52.03	0.21	0.48	40.87	26.93	21.16	25.10
23.872	35.45	28.90	60.00	50.00	1.03	0.41	36.89	30.34	23.11	19.66

Note :

**Conducted Emissions**



RBW 9 kHz  
 MT 100 ms  
 PREAMP OFF

Att 10 dB

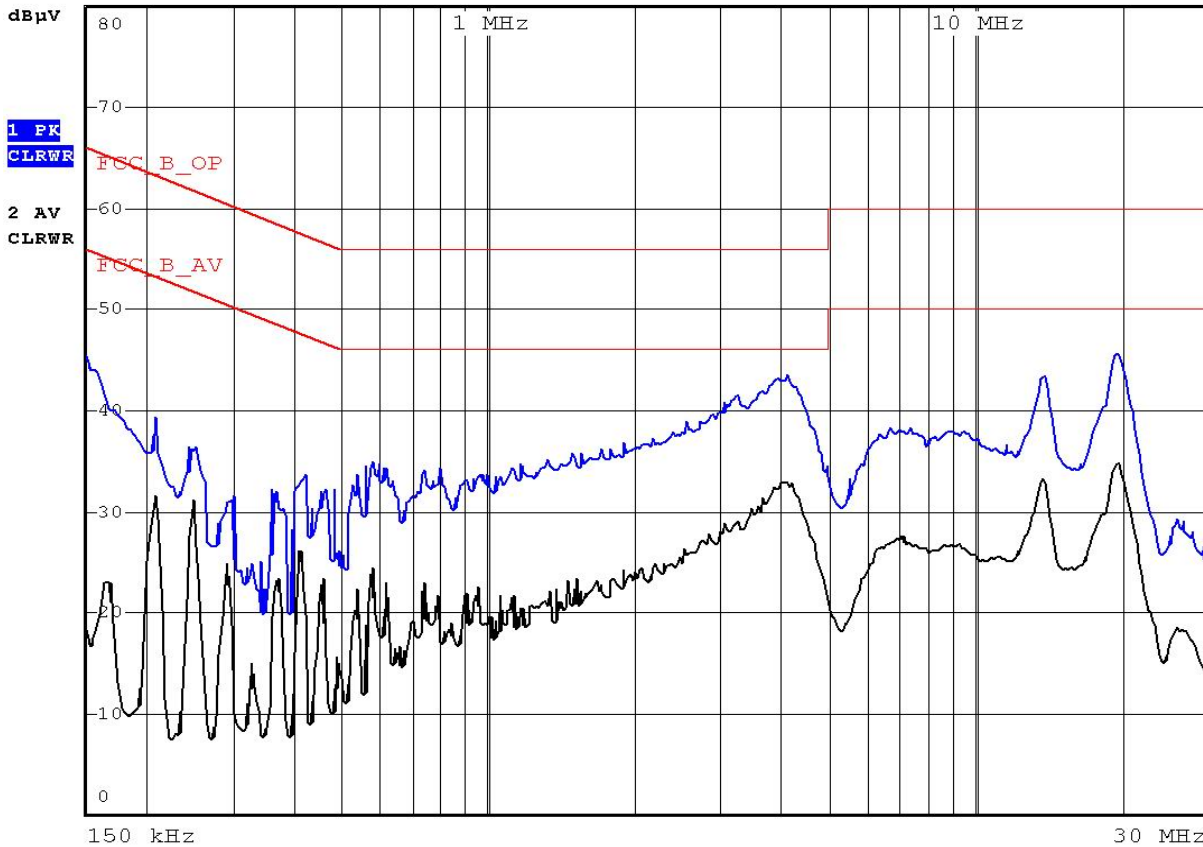

Model Name : DLA-32C7  
 120 Vac 60 Hz Phase : Neutral

Freq. [MHz]	Measurement [dB µV]		Limit [dB µV]		Insertion Loss [dB]	Cable Loss [dB µV]	Result [dB µV]		Margin [dB]	
	Q-peak	Average	Q-peak	Average			Q-peak	Average	Q-peak	Average
0.150	57.55	40.21	66.00	56.00	0.16	0.80	58.51	41.17	7.49	14.83
0.183	50.02	38.19	64.35	54.35	0.16	0.80	50.98	39.15	13.37	15.20
0.240	38.58	23.46	62.10	52.10	0.16	0.48	39.22	24.10	22.88	28.00
24.027	36.16	29.86	60.00	50.00	0.92	0.40	37.48	31.18	22.52	18.82

Note :

## TEST CONDITIONS AND DATA

### Radiated Emissions

#### [Applicable]

#### ◆ Test Equipment Used

**The test equipment used is calibrated in regular for every year.**

<u>Model Name</u>	<u>Manufacturer</u>	<u>Descriptions</u>	<u>Calibration Date</u>	<u>Serial Number</u>
ESCS 30	Rohde & Schwarz	Test Receiver	August 28, 2007	100171
VULB9160	Schwarzbeck	Antenna	August 10, 2007	3048

#### ◇ Auxiliary Equipment Used

<u>Model Name</u>	<u>Manufacturer</u>	<u>Descriptions</u>
-------------------	---------------------	---------------------

#### ◇ Accessories including cables

<u>Name</u>	<u>Length</u>	<u>Port and Descriptions</u>
-------------	---------------	------------------------------

#### ◆ Environmental Conditions

Temperature	13 °C
Humidity	42 %
Atmosphere pressure	1016 mbar

- ◆ Test Program                      See test configuration page 6.
- ◆ Test Date                            March 20, 2008
- ◆ Test Area                            Open Area Test Site #2

*Note : The equipment used is calibrated in regular for every year.*

*The test results of followings are the representative of the worst case emissions for resolutions that are available.*

**Radiated Emissions**

Mode	Freq. [MHz]	Reading [dBuV]	Antenna Factor [dB/m]	Cable Loss [dB]	Polar. [H/V]	Result [dBuV/m]	Limit [dBuV/m]	Margin [dB]
1280x1024, 75Hz	111.17	22.30	10.42	1.36	V	34.08	43.50	9.42
	153.93	24.10	13.15	1.73	V	38.98	43.50	4.52
	194.57	20.00	9.50	2.21	H	31.71	43.50	11.79
	211.12	18.40	9.46	2.25	H	30.11	43.50	13.39
	222.78	19.60	9.90	2.20	V	31.70	46.00	14.30
	245.43	28.70	10.76	2.36	H	41.82	46.00	4.18
	259.31	21.20	11.22	2.41	H	34.83	46.00	11.17
	519.03	21.50	17.35	3.47	H	42.32	46.00	3.68
	615.46	17.60	19.14	3.86	H	40.60	46.00	5.40

*End of Data*

*Note:*

Appendix A. The Photos of Test Setup



Conducted Emissions - Front View

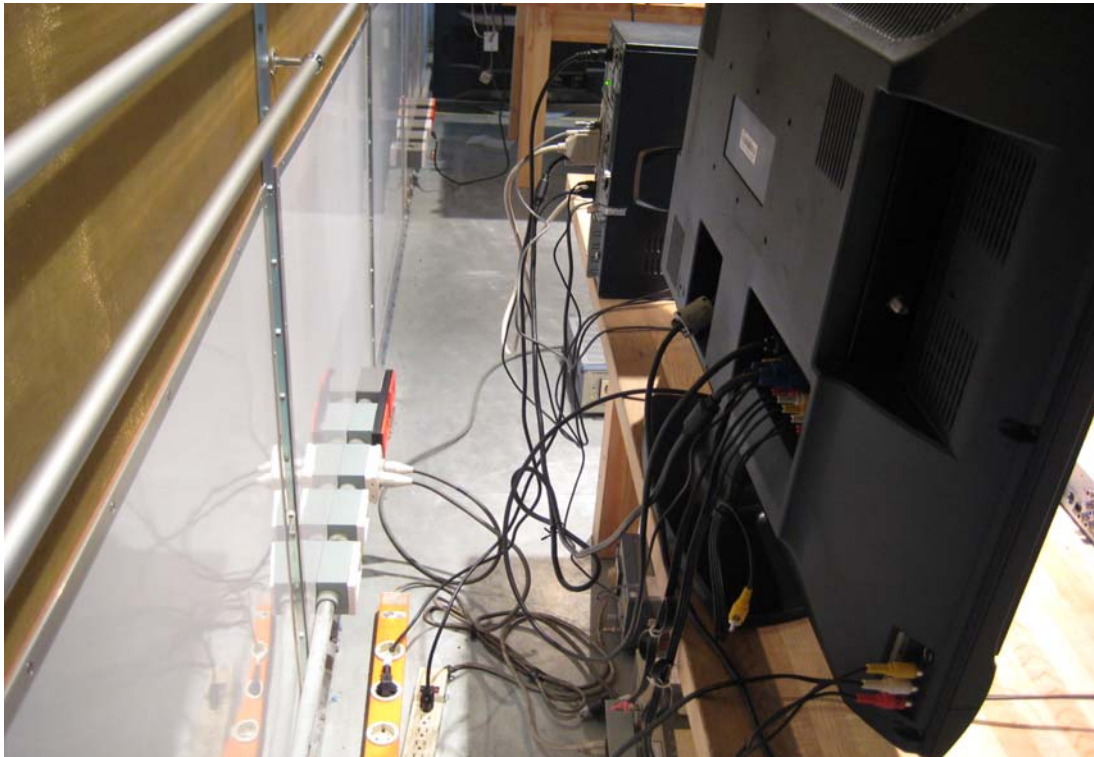

Conducted Emissions - Rear View

Appendix A. The Photos of Test Setup



Radiated Emissions - Front View



Radiated Emissions - Rear View

Appendix B. The Photos of EUT



Front View



Rear View

Appendix B. The Photos of EUT



Left View



Right View