

Certification of Compliance

CFR 47 Part 15 Subpart B

Test Report File No.	08-IST-0104	Date of Issue	February 27, 2008
Model(s)	DAC-300 / DA1S-GN21AA-AN		
Kind of Product	Digital-to-Analog Converter Box		
FCC ID	C5F7NFD101		
Applicant	Daewoo Electronics Corporation.		
Address	543, Dangjung-Dong, Kunpo-City, Kyounggi-DO, Korea		
Manufacturer	Daewoo Electronics Corporation.		
Address	295, Kongdan-dong, Kumi-city, Kyungsangbuk-do, Korea.		

Test Result

Positive

Negative

Reviewed By

Approved By



S.J. Cho / EMC Group Manager

J.H. Lee / Chief

- Investigations requested : Measurement to the relevant clauses of F.C.C rules and regulations Part 15 Subpart B - Unintentional Radiators
- The test report with appendix consists of 29 pages.
- The test result only responds to the tested sample.
- It is not allowed to copy this report even partly without the allowance of IST EMC Laboratory.
- This equipment as for has been shown to be capable of continued compliance with the applicable technical standards as indicated in the measurement report and was tested in accordance with the measurement procedures specified in ANSI C63.4 2003.



TABLE OF CONTENTS

Table of contents	2
Information of test laboratory, Environmental condition, Power used	3
Descriptions of test	4-6
Conducted Emission	4
Radiated Emission	5
Output Signal level measurements	6
Output Terminal Conducted Spurious Emission	6
Transfer Switch Isolation Measurement	6
Summary	7
■ Test Conditions and Data - Emission	
◆ Conducted Emission	0.15 MHz - 30 MHz
Test equipment / Data and Plots	8-10
◆ Radiated Emission	30 MHz - 2 GHz
Test equipment / Data and Plots	11-13
◆ Output Signal level measurements	
Test equipment / Data and Plots	14-17
◆ Output Terminal Conducted Spurious Emission	30 MHz - 1 GHz
Test equipment / Data and Plots	18-20
◆ Transfer Switch Isolation Measurement	30 MHz - 1 GHz
Test equipment / Data and Plots	21-23
Appendix A. The Photos of Test Setup	24-25
B. The Photos of Equipment Under Test	26-29

INFORMATIONS OF TEST LABORATORY

EMC LABORATORY of IST Co., Ltd. (*FCC Filing Lab.*)

400-19, Singal-Dong, Giheung-Gu, Yongin-Si,
Gyeonggi-Do, 446-599, Korea

TEL : +82 31 326 6700 FAX : +82 31 326 6797

ENVIRONMENTAL CONDITIONS

Temperature	6 °C
Humidity	45 %
Atmospheric pressure	1015 mbar

POWER SUPPLY SYSTEM USED

Power supply system	120 Vac, 60 Hz
---------------------	----------------

PRODUCT INFORMATIONS

Power supply system	120 Vac , 60 Hz
Power consumption	In standby : 1.6W / Operating : 8W
Power Adaptor Input	5.0 V ,1.2 A
Television system	Fully ATSC Compliant
Channel Coverage	Terrestrial : 2 ~ 69
ATSC RF input	RF IN(1)
RF Output	3 / 4 Channel
Video Output	480i Composite
Audio Output	Analog Audio (L / R)
Applied Tuner	DTT76850 (THOMSON)

-EMC suppression device is not used during the test.

-Please refer to user's manual.

DESCRIPTIONS OF TEST

Conducted Emissions:

The measurement were performed over the frequency range of 0.15 MHz to 30 MHz using a 50 Ω/50 uH LISN as the input transducer to a Spectrum Analyzer or a Field Intensity Meter. The measurements were made with the detector set for "Peak" amplitude within a bandwidth of 10 KHz or for "quasi-peak" & "Average" within a bandwidth of 9 KHz.

-Procedure of Test

The line-conducted facility is located inside a shielded room No.1. A 1 m X 1.5 m wooden table 80cm height is placed 40 cm away from the vertical wall and 1.5 m away from the other wall of the shielded room. The Hyup-Rip KNW-407 and EMCO 3725/2 LISN are bonded to bottom of the shielded room. The EUT is located on the wooden table with distance more than 80 cm from the LISN and powered from the EMCO LISN .The peripheral equipment is powered from the other LISN. Power to the LISNS are filtered by a noise cut power line filters. All electrical cables are shielded by braided tinned steel tubing with inner ϕ 1.2 cm. If the EUT is a DC-powered device, power will be derived from the source power supply it normally will be powered from and this supply lines will be connected to the EMCO LISN. All interconnecting cables more than 1m were shortened by non-inductive bundling to a 1m length. Sufficient time for the EUT, support equipment, and test equipment was allowed in order for them to warm up to their normal operating conditions. The RF output of the LISN was connected to the R/S receiver to determine the frequency producing the maximum emission from the EUT. The frequency producing the maximum level was reexamined using Quasi-Peak mode by manual measurement, after scanned by automatic Peak mode for frequency range from 0.15 to 30 MHz. The bandwidth of the receiver was set to 10 kHz. The EUT, peripheral equipment, and interconnecting cables were arranged and manipulated to maximize each EME emission.

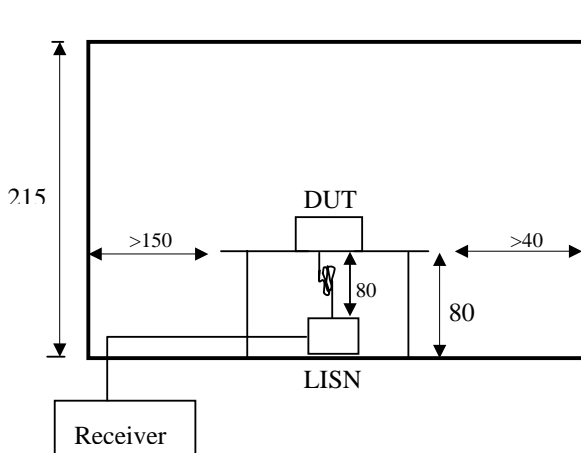

< Side View >

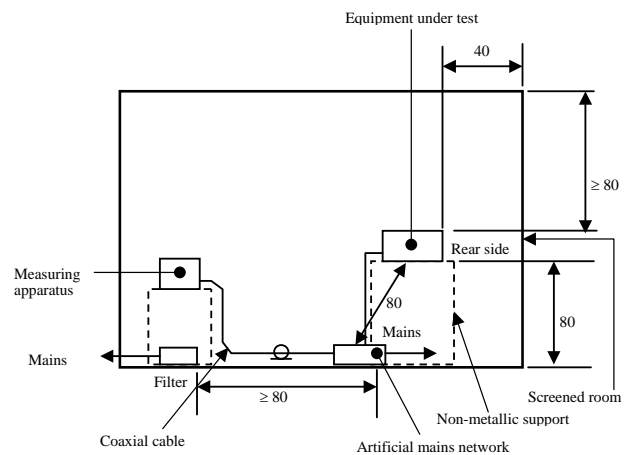

< Concept Drawing >

DESCRIPTION OF TEST

Radiated Emissions:

The measurement was performed over the frequency range of 30 MHz to 1 GHz using antenna as the input transducer to a Spectrum analyzer or a Field Intensity Meter. The measurement was made with the detector set for "quasi-peak" within a bandwidth of 120 KHz.

-Procedure of Test

Preliminary measurements were made at 3 meter using bi-conical and log-periodic antennas, and spectrum analyzer to determine the frequency producing the max. emission in anechoic chamber. Appropriate precaution was taken to ensure that all emission from the EUT were maximized and investigated. The system configuration, mode of operation, turn-table azimuth and height with respect to the antenna were noted for each frequency found. The spectrum was scanned from 30 MHz to 1000 MHz using S/B bi-log antenna. Above 1 GHz, linearly polarized double ridge horn antennas were used. Final measurements were made at open site with 3-meters test distance using S/B bi-log antenna or horn antenna. The OATS have been verified in regular for its normalized site attenuation. The test equipment was placed on a wooden table. Sufficient time for the EUT, peripheral equipment, and test equipment was allowed in order for them to warm up to their normal operating condition. Each frequency found during pre-scan measurements was re-examined by manual. The detector function was set to CISPR quasi-peak mode and the bandwidth of the receiver was set to 120 kHz or 1 MHz depending on the frequency of type of signal. The EUT, peripheral equipment and interconnecting cables were re-configured to the set-up producing the max. emission for the frequency and were placed on top of a 0.8-meter high nonmetallic 1 x 1.5 meter table. The EUT, peripheral equipment, and interconnecting cables were re-arranged and manipulated to maximize each emission. The turntable containing the system was rotated; the antenna height was varied 1 to 4 meters and stopped at the azimuth or height producing the maximum emission. Each emission was maximized by: varying the mode of operation to the EUT and/or peripheral equipment and changing the polarity of the antenna, whichever determined the worst-case emission.

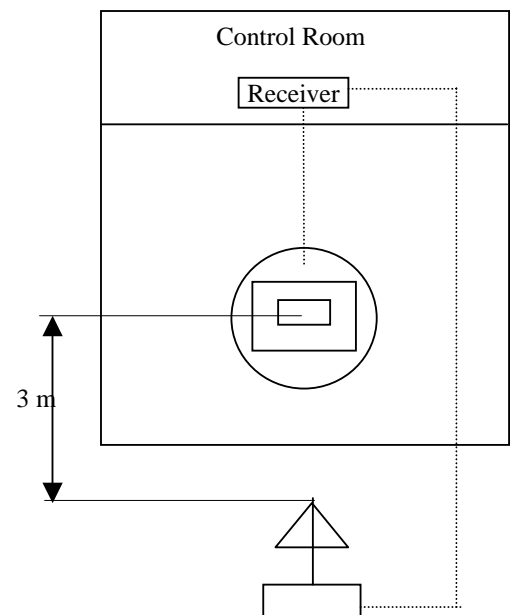
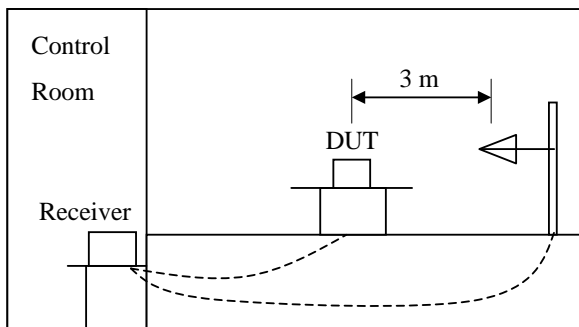

DESCRIPTION OF TEST

Output Signal level measurements :

The RF output of the TV interface device was fed to the TV receiver via coaxial cable. The signal level was measured by direct connection to the spectrum analyzer with 50/75 ohm matching transformer between the spectrum analyzer and the TV interface device. The RF output signal level measured RMS voltage was the highest RF level present at the output terminals during normal use of the device. Measurements were made of the levels of both the visual(61.25 MHz) and aural(71.25 MHz) of TV channel 3 and 4. The voltage corresponding to the peak envelope power of the video modulated signal during maximum amplitude peaks across a resistance(R ohms) matching the rated output impedance of the device, must not exceed 346.4 times the square root of (R)[uV] for all other TV interface device. The voltage corresponding to peak envelope power of the audio modulated signal, if provided by the TV interface device, must not exceed 77.5 times the square root of (R)[uV] for all other TV interface device.(Sec 15.115 (b).(1).(ii))

Output Terminal Conducted Spurious Emission :

The RF output signal was fed to the TV receiver with coaxial cable. The measurements were made by direct connection to the spectrum analyzer and TV interface device with 50/75 ohm matching transformer. The frequency range 30 to 1000 MHz was investigated for significant emission. The maximum RMS voltage of any emission appearing on frequencies removed by than 4.6 MHz below or 7.4 MHz above the video carrier frequency on which the TV interface device is operated must not exceed 10.95 times the square root of (R) [uV](Sec 15.115 (b).(2).(ii)) This represents the 30dB attenuation.

Transfer Switch Isolation Measurement :

The measurements were made of the maximum RMS voltage at the antenna terminals of the switch for all positions of the transfer switch. The maximum voltage corresponds to the peak envelope power of the video signal during maximum amplitude peaks. In either position of the receiver transfer switch, the maximum voltage at the receiving antenna input terminals of the switch when terminated with a resistance (R ohms) matching the rated impedance of the antenna input of the switch, must not exceed 0.346 times the square root of (R) [uV]. (Sec 15.115 (c).(1).(ii))

SUMMARY

■ Conducted Emission

The requirements are
Minimum limit margin
Maximum limit exceeding

● MET ○ Not MET
12.58 dB at 0.15 MHz

Remarks : With live phase and Q-Peak detect mode.

■ Radiated Emission

The requirements are
Minimum limit margin
Maximum limit exceeding

● MET ○ Not MET
3.74 dB at 950.0 MHz

Remarks : Limits are kept with more 3dB margin.

■ Output Signal Level Measurements

The requirements are
Minimum limit margin
Maximum limit exceeding

● MET ○ Not MET

Remarks :

■ Output Terminal Conducted Spurious Emission

The requirements are
Minimum limit margin
Maximum limit exceeding

● MET ○ Not MET

Remarks :

■ Transfer Switch Isolation Measurements

The requirements are
Minimum limit margin
Maximum limit exceeding

● MET ○ Not MET

Remarks :

■ Test Date

Begin of Test: February 19, 2008
End of Test: February 26, 2008

Prepared By



J.H. Lee / EMC Engineer

Note :

- ■ means the test is applicable, □ is not applicable.

TEST CONDITIONS AND DATA

Conducted Emissions

[Applicable]

◆ Test Equipment Used

The test equipment used is calibrated in regular for every year.

<u>Model Name</u>	<u>Manufacturer</u>	<u>Descriptions</u>	<u>Calibration Date</u>	<u>Serial Number</u>
ESCI	Rohde & Schwarz	EMI Test Receiver	June 26, 2007	100373
KNW-407	Hyup-Rip	LISN	October 11, 2007	8-833-10
ESH3-Z2	Rohde & Schwarz	Pulse Limiter	May 21, 2007	357.8810.52

◆ Auxiliary Equipment Used

<u>Model Name</u>	<u>Manufacturer</u>	<u>Descriptions</u>
14C5NT	Daewoo Electronics.	Color TV Receiver
KDC300	Digital core	DVB-T Receiver

◆ Accessories including cables

<u>Name</u>	<u>Length</u>	<u>Port and Descriptions</u>
RCA Cable	1.5 m	Video / Audio output
RF Cable	1.2 m	RF Output
BNC Cable	2.0 m	RF In

◆ Environmental Conditions

Temperature	14 °C
Humidity	40 %
Atmosphere pressure	1012 mbar

- ◆ Test Program RF Receiving Mode
- ◆ Test Area Conducted Room
- ◆ Test Date February 19, 2008

Note :

Conducted Emissions

(Mains Terminal Disturbance Voltages)



RBW 9 kHz
MT 160 ms
PREAMP OFF

Att 10 dB

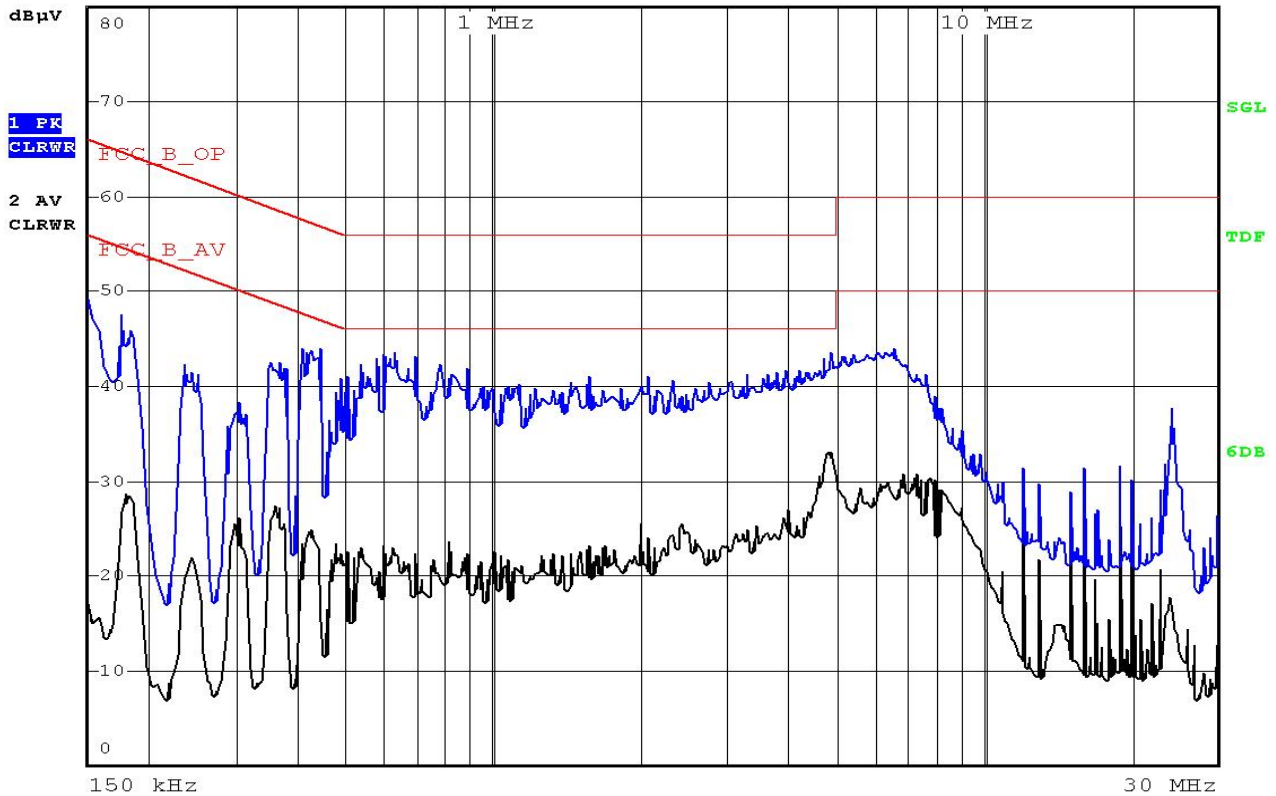

Model Name : DAC-300 120Vac, 60Hz Phase : Live

Freq. [MHz]	Measurement [dB µV]		Limit [dB µV]		Insertion Loss [dB]	Cable Loss [dB µV]	Result [dB µV]		Margin [dB]	
	Q-peak	Average	Q-peak	Average			Q-peak	Average	Q-peak	Average
0.15	52.50	23.00	66.00	56.00	0.12	0.80	53.42	23.92	12.58	32.08
0.18	41.30	27.40	64.72	54.72	0.12	0.80	42.22	28.32	22.50	26.40
0.41	39.90	23.00	57.75	47.75	0.14	0.20	40.24	23.34	17.51	24.41
0.63	40.80	22.60	56.00	46.00	0.15	0.20	41.15	22.95	14.85	23.05
4.89	39.00	29.40	56.00	46.00	0.37	0.32	39.69	30.09	16.31	15.91
6.54	39.20	27.20	60.00	50.00	0.44	0.50	40.14	28.14	19.86	21.86
24.25	23.00	15.50	60.00	50.00	0.74	0.40	24.14	16.64	35.86	33.36

Note :

Conducted Emissions

(Mains Terminal Disturbance Voltages)



REW 9 kHz
MT 160 ms
PREAMP OFF

Att 10 dB

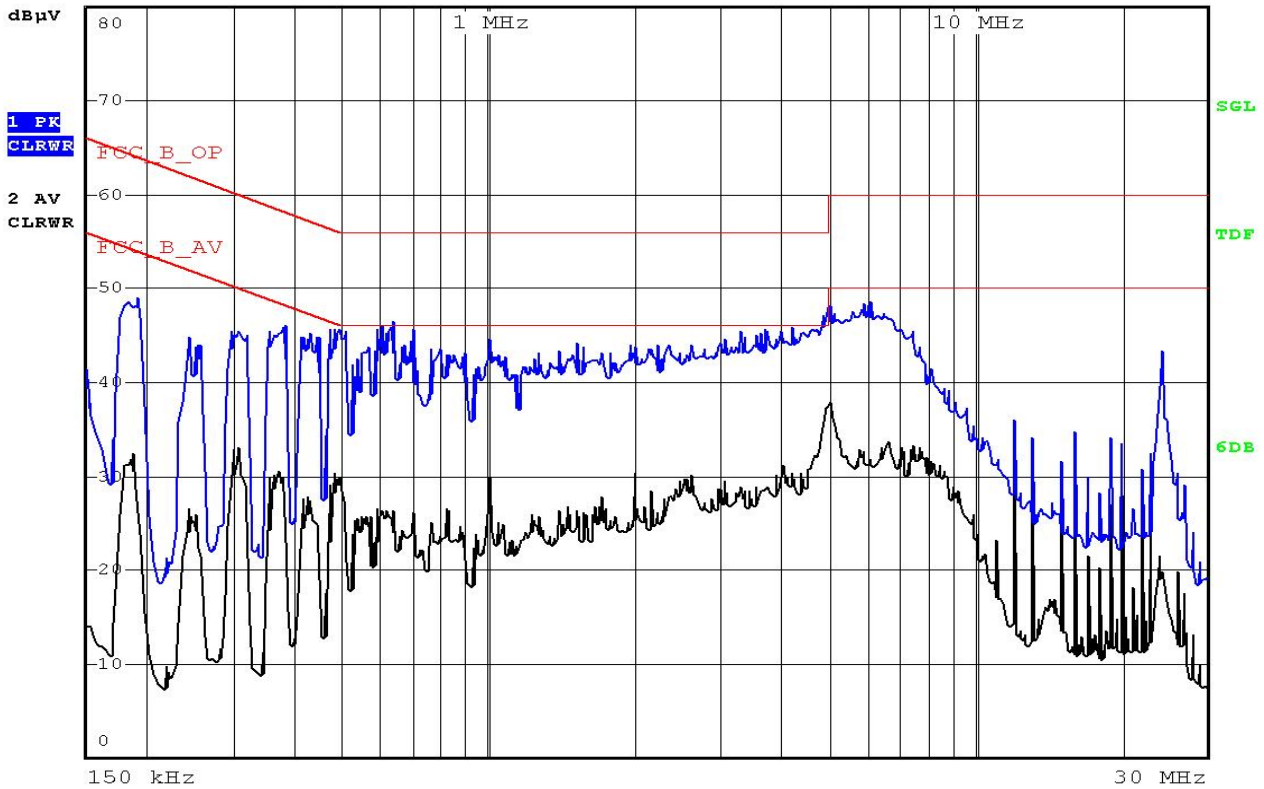

Model Name : DAC-300 120Vac, 60Hz Phase : Neutral

Freq. [MHz]	Measurement [dB µV]		Limit [dB µV]		Insertion Loss [dB]	Cable Loss [dB µV]	Result [dB µV]		Margin [dB]	
	Q-peak	Average	Q-peak	Average			Q-peak	Average	Q-peak	Average
0.18	43.20	31.60	64.39	54.39	0.12	0.80	44.12	32.52	20.27	21.87
0.38	43.30	27.80	58.30	48.30	0.12	0.17	43.59	28.09	14.71	20.21
0.64	40.80	24.60	56.00	46.00	0.12	0.20	41.12	24.92	14.88	21.08
3.31	38.40	27.50	56.00	46.00	0.17	0.60	39.17	28.27	16.83	17.73
5.04	42.40	34.20	60.00	50.00	0.22	0.30	42.92	34.72	17.08	15.28
6.04	41.80	29.40	60.00	50.00	0.27	0.50	42.57	30.17	17.43	19.83
24.25	36.00	19.70	60.00	50.00	0.59	0.40	36.99	20.69	23.01	29.31

Note :

TEST CONDITIONS AND DATA

Radiated Emissions

[Applicable]

◆ Test Equipment Used

The test equipment used is calibrated in regular for every year.

<u>Model Name</u>	<u>Manufacturer</u>	<u>Descriptions</u>	<u>Calibration Date</u>	<u>Serial Number</u>
ESCS 30	Rohde & Schwarz	Test Receiver	Aug. 28, 2007	100171
VULB9160	Schwarzbeck	Antenna	Aug. 10, 2007	3048
3115	EMCO	Horn Antenna	Dec. 26, 2007	90123602
ESCI	Rohde & Schwarz	EMI Test Receiver	May 18, 2007	100374
8449B OPT H02	HP	Pre Amplifier	Oct. 15, 2007	3008A0530

◆ Auxiliary Equipment Used

<u>Model Name</u>	<u>Manufacturer</u>	<u>Descriptions</u>
14C5NT	Daewoo Electronics.	Color TV Receiver
KDC300	Digital core	DVB-T Receiver

◆ Accessories including cables

<u>Name</u>	<u>Length</u>	<u>Port and Descriptions</u>
RCA Cable	1.5 m	Video / Audio output
RF Cable	1.2 m	RF Output
BNC Cable	2.0 m	RF In

◆ Environmental Conditions

Temperature	6 °C
Humidity	45 %
Atmosphere pressure	1015 mbar

- ◆ Test Program RF Receiving Mode
- ◆ Test Area Open Area Test Site (3 m)
- ◆ Test Date February 26, 2008

Note :

Radiated Emissions

Mode	Freq. [MHz]	Reading [dBuV]	Antenna Factor [dB/m]	Cable Loss [dB]	Polar. [H/V]	Result [dBuV/m]	Limit [dBuV/m]	Margin [dB]
DVB-T	38.31	22.00	11.44	0.60	H	34.04	40.00	5.96
	125.00	24.20	11.66	1.52	V	37.38	43.50	6.12
	150.01	24.50	12.95	1.70	V	39.15	43.50	4.35
	175.00	24.00	11.42	1.95	V	37.37	43.50	6.13
	200.00	27.60	9.04	2.30	V	38.94	43.50	4.56
	225.00	27.20	9.99	2.20	H	39.39	46.00	6.61
	250.00	24.80	10.94	2.40	H	38.14	46.00	7.86
	350.00	20.60	13.59	2.80	V	36.99	46.00	9.01
	750.01	14.90	21.44	4.50	H	40.84	46.00	5.16
	800.00	13.10	21.79	4.70	H	39.59	46.00	6.41
	825.00	13.70	22.05	4.75	V	40.50	46.00	5.50
	850.00	14.30	22.31	4.80	V	41.41	46.00	4.59
	875.01	12.40	22.51	4.90	V	39.81	46.00	6.19
	925.00	13.30	23.09	5.05	V	41.44	46.00	4.56
	950.00	13.70	23.46	5.10	V	42.26	46.00	3.74

End of Data

Note :

Radiated Emissions
(Disturbance Radiation)

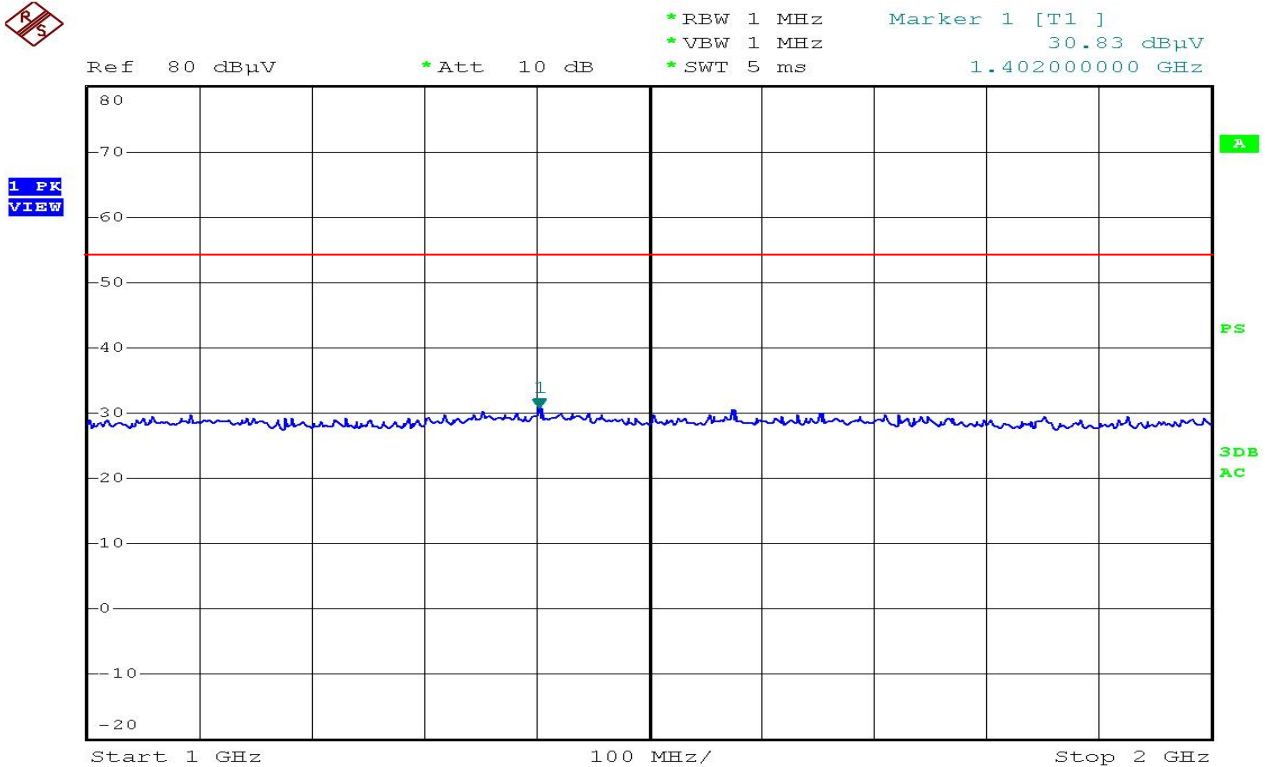

Radiated Emission Test 1GHz - 2GHz

Measured Data from 1GHz to 2GHz

Above 1 GHz, peak detector function mode is used with 22 dB gain of Amplifier.

The following graphs show that all data of full frequencies are met with the limit.

We automatically change our antenna polarity, when measure radiated emission.

The spectrum plot was obtained with peak detect mode and maximum hold mode. It was used for plot the ESCI EMI Test Receiver, EMCO 3115 Horn antenna.(Section 15.35)

The peak value evaluation at the frequency of 1.390 GHz is

$$\begin{aligned}
 & 32.15 \text{ dB(measured)} + 23.1 \text{ dB(antenna factor)} + 6.7 \text{ dB(cable loss)} \\
 & - 22\text{dB(gain of Amp.)} - 20 \text{ dB(corrective factor)} \\
 & = 19.95 \text{ dB(less than average limit 54.0 dB)}
 \end{aligned}$$

The peak value evaluation is less than the average limit, EUT have the margin relative to peak value more than 10 dB for radiated emission for the above 1 GHz.

Note :

TEST CONDITIONS AND DATA

Output Signal Level Measurements

[Applicable]

◆ Test Equipment Used

The test equipment used is calibrated in regular for every year.

<u>Model Name</u>	<u>Manufacturer</u>	<u>Descriptions</u>	<u>Calibration Date</u>	<u>Serial Number</u>
ESCI	Rohde & Schwarz	EMI Test Receiver	May 21, 2007	100374
RAM	Rohde & Schwarz	50/75ohms matching pad	October 11, 2007	836625/033

◆ Auxiliary Equipment Used

<u>Model Name</u>	<u>Manufacturer</u>	<u>Descriptions</u>
14C5NT	Daewoo Electronics.	Color TV Receiver

◆ Accessories including cables

<u>Name</u>	<u>Length</u>	<u>Port and Descriptions</u>
RCA	1.5 m	Video / Audio output
BNC Cable	2.0 m	RF In
RF Cable	1.2 m	RF Output

◆ Environmental Conditions

Temperature	14 °C
Humidity	42 %
Atmosphere pressure	1010 mbar

- ◆ Test Program Receiving Mode
- ◆ Test Area Compact Chamber
- ◆ Test Date February 25, 2008

Note : Limit Calculations

For Video Signal

$$346.4 \times 75^{1/2} = 2999\mu\text{V} = 69.54\text{dBuV} = -37.46 \text{ dBm}$$

For Audio Signal

$$77.5 \times 75^{1/2} = 671.17\mu\text{V} = 56.53\text{dBuV} = -50.46 \text{ dBm}$$

The test were performed with RF receiving as VITS. The VITS signals, 1V and 5V peak-to-peak, were used for channel 3 and channel 4 with alternate. The above test program were employed for each channel.

Output Signal Level Measurements

TV CH.	Freq. (MHz)	Level (dBuV)	Limit (dBuV)	Margin (dB)
3 (Pix)	61.258	45.87	69.54	23.67
3 (Aud)	56.748	30.61	56.53	25.92
4 (Pix)	67.258	45.39	69.54	24.15
4 (Aud)	62.748	30.02	56.53	26.51

End of Data

Note :

Output Signal Level Measurements



Ref 80 dB μ V *Att 0 dB *RBW 100 kHz Marker 1 [T1] 45.87 dB μ V
 *VBW 300 kHz *SWT 20 ms 61.258000000 MHz

1 PK
VIEW

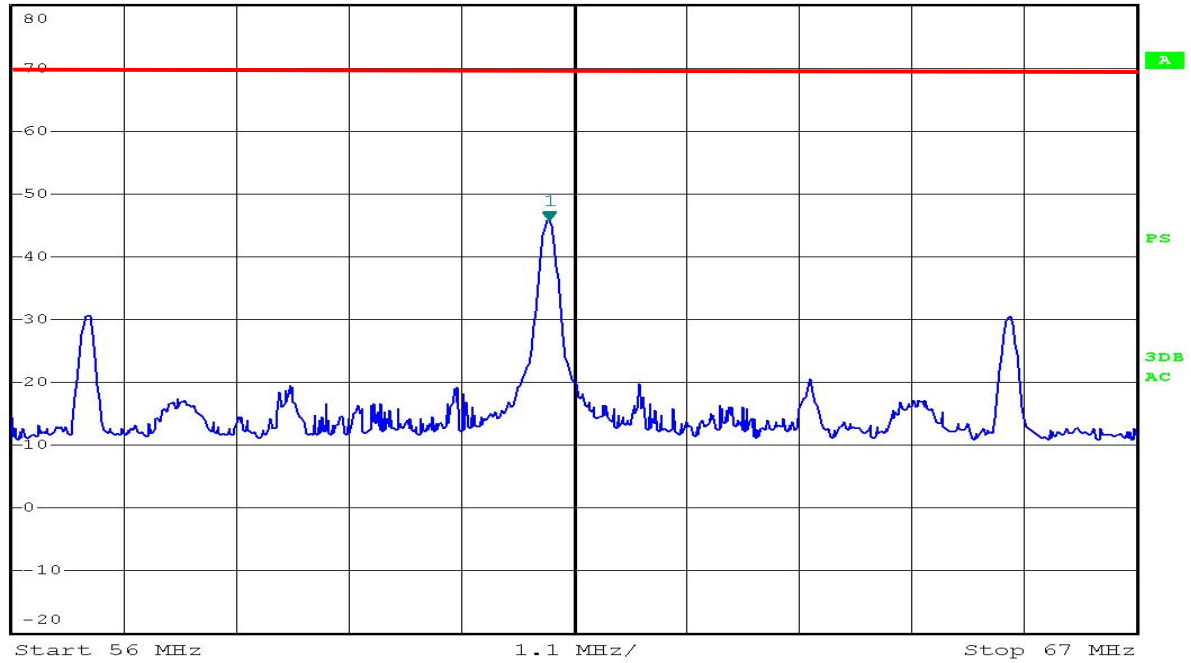

CH3 (Pix)



Ref 80 dB μ V *Att 0 dB *RBW 100 kHz Marker 1 [T1] 30.61 dB μ V
 *VBW 300 kHz *SWT 20 ms 56.748000000 MHz

1 PK
VIEW

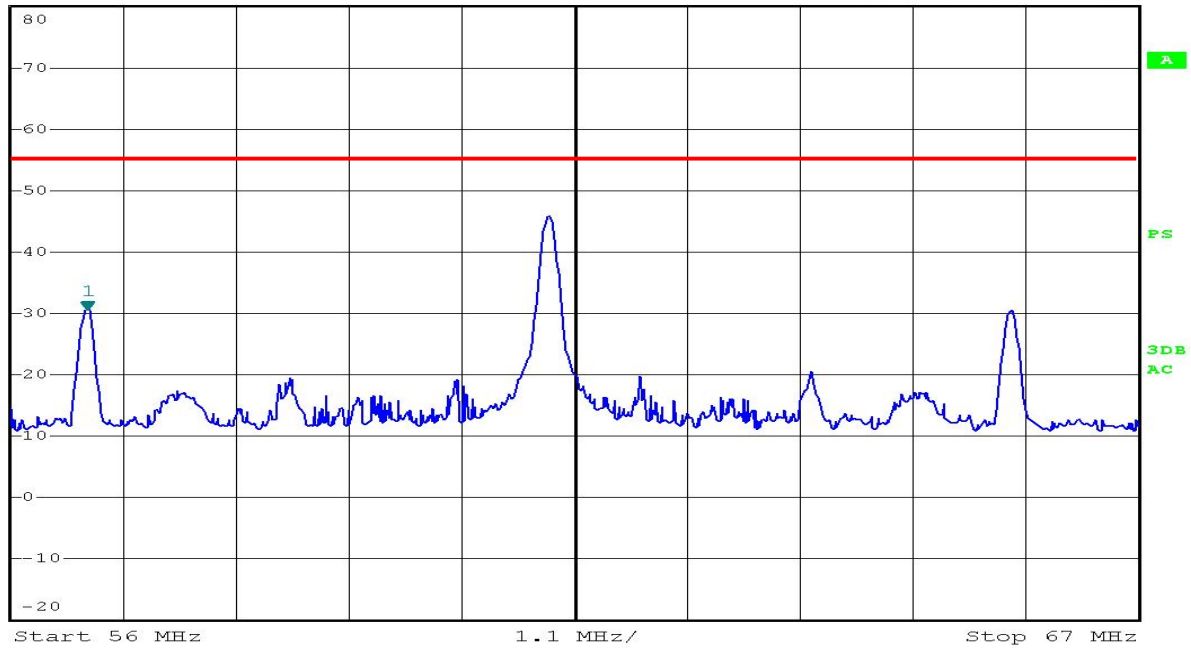

CH3 (Aud)

Output Signal Level Measurements



Ref 80 dB μ V *Att 0 dB
 *RBW 100 kHz Marker 1 [T1]
 *VBW 300 kHz 45.39 dB μ V
 *SWT 20 ms 67.258000000 MHz

1 PK
VIEW

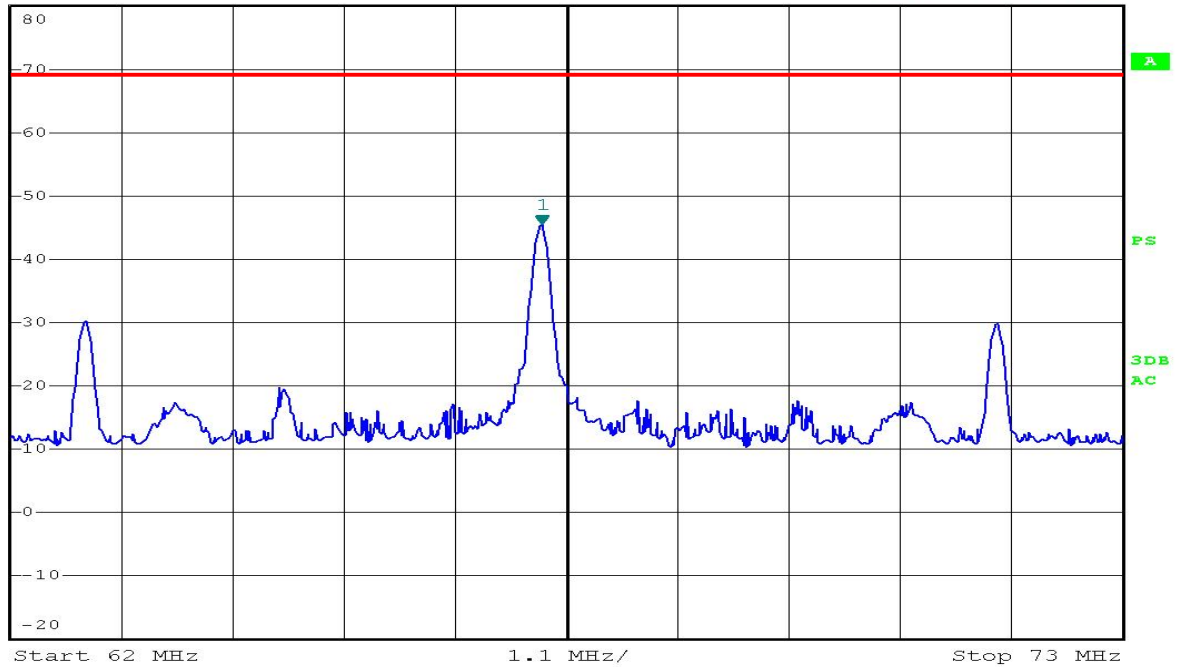

CH4 (Pix)
 Ref 80 dB μ V *Att 0 dB
 *RBW 100 kHz Marker 1 [T1]
 *VBW 300 kHz 30.20 dB μ V
 *SWT 20 ms 62.748000000 MHz

1 PK
VIEW

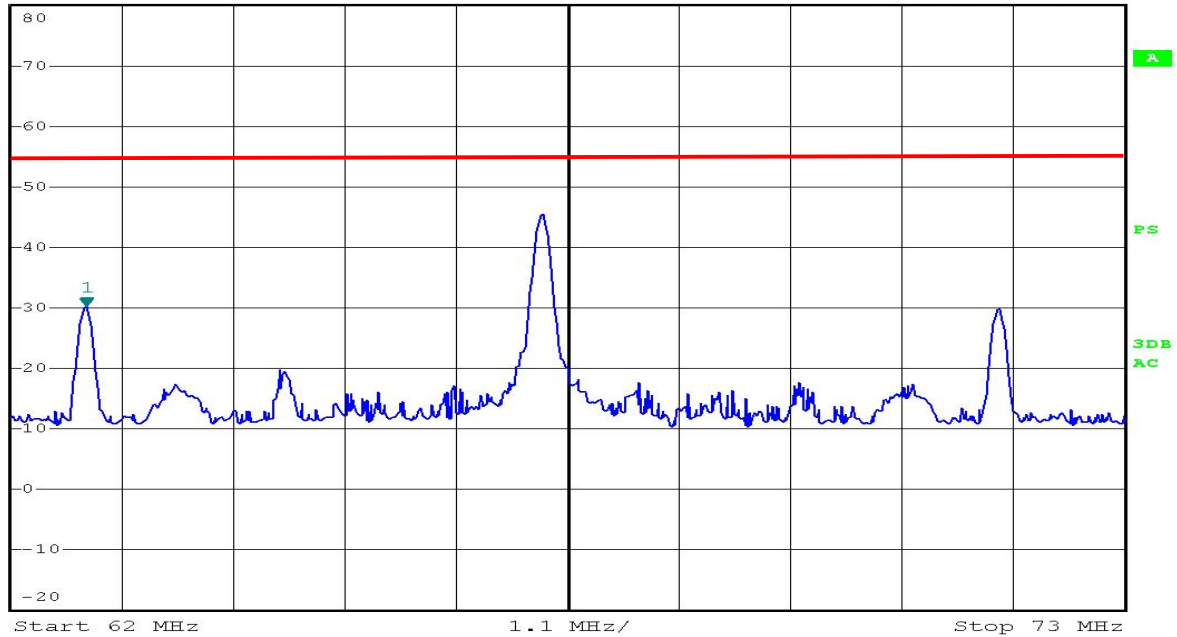

CH4 (Aud)

Output Terminal Conducted Spurious Emission

TV CH	Freq. (MHz)	Level (dBuV)	Limit (dBuV)	Margin (dB)
3	61.258	44.97	69.55	24.58
4	66.860	44.32	69.55	25.23

End of Data

Note :

Output Terminal Conducted Spurious Emission



1 PK
VIEW

Ref 80 dB μ V *Att 0 dB *RBW 100 kHz Marker 1 [T1]
*VSW 300 kHz 44.97 dB μ V
*SWT 290 ms 61.258000000 MHz

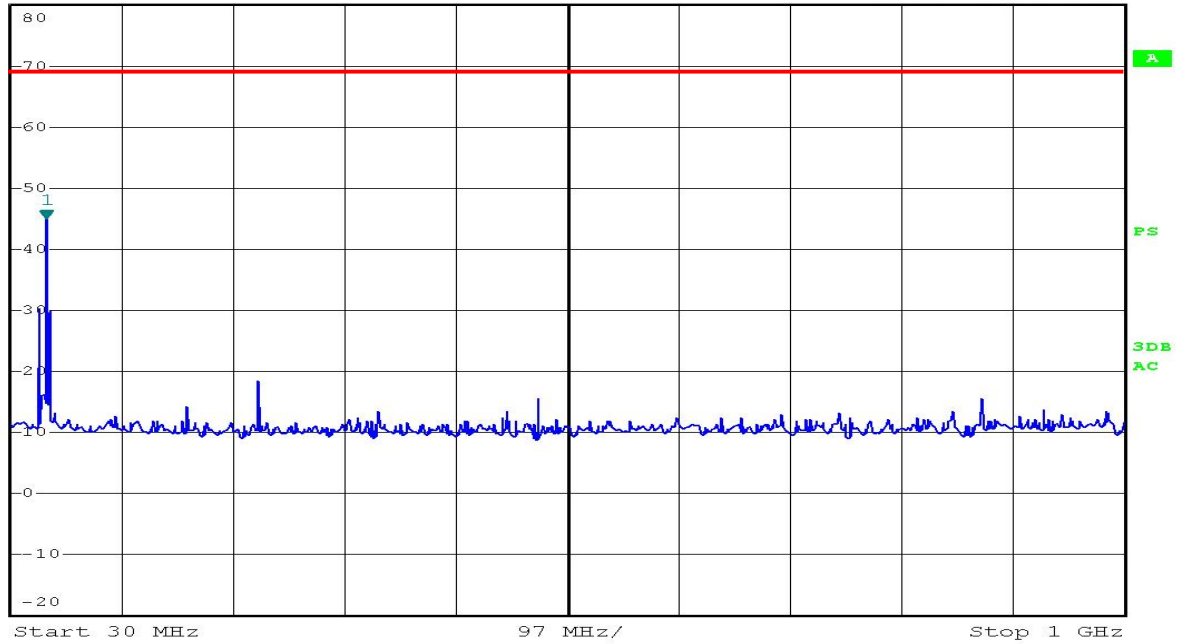

CH3



1 PK
VIEW

Ref 80 dB μ V *Att 0 dB *RBW 100 kHz Marker 1 [T1]
*VSW 300 kHz 44.32 dB μ V
*SWT 290 ms 66.860000000 MHz

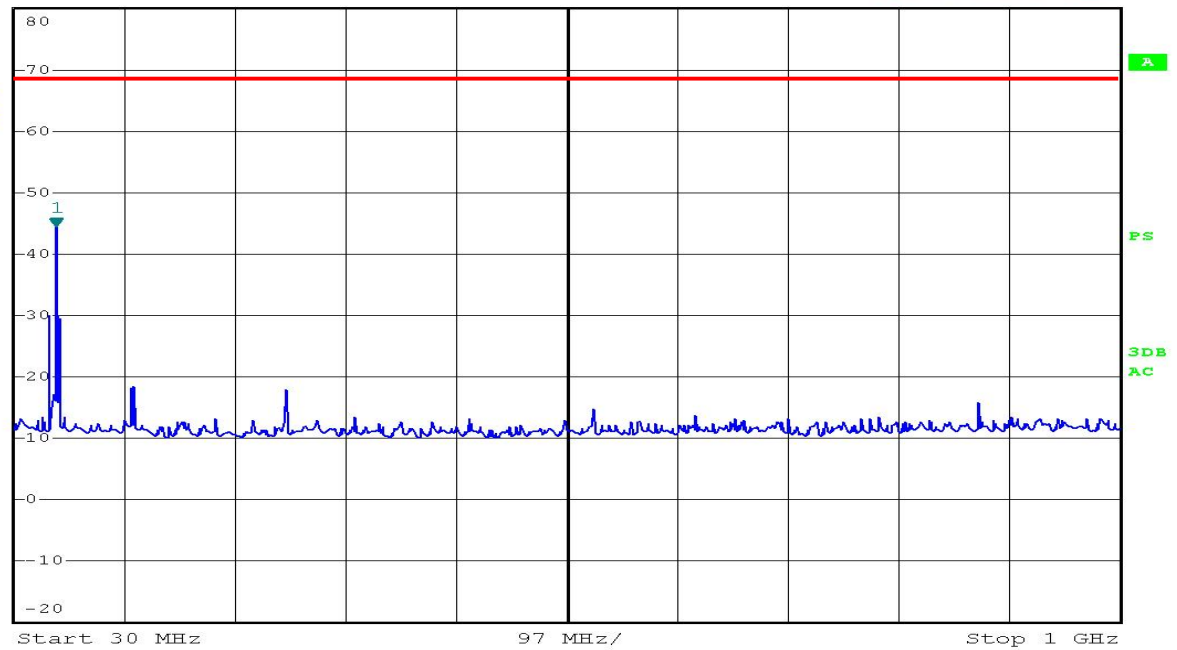

CH4

Transfer Switch Isolation Measurement

TV CH	Freq. (MHz)	Level (dBuV)	Limit (dBuV)	Margin (dB)
3	61.25	5.38	9.53	4.15
4	67.25	5.96	9.53	3.57

End of Data

Note :

Transfer Switch Isolation Measurement

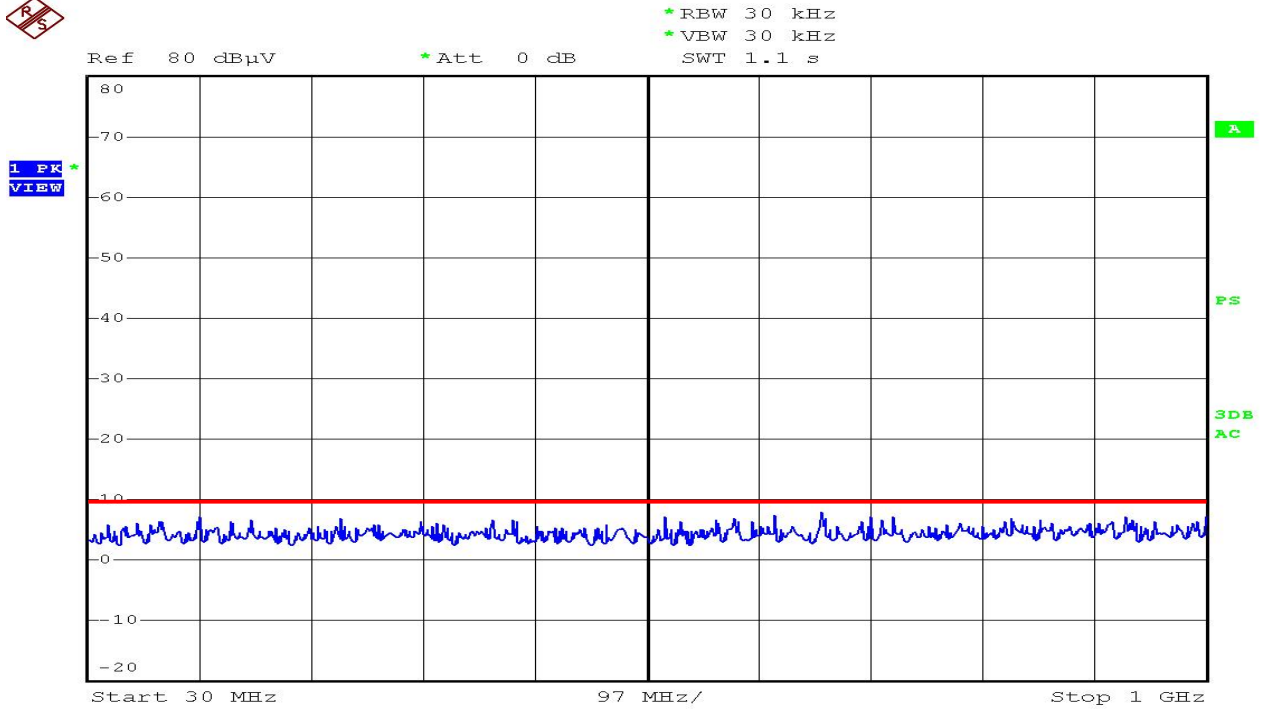

CH3

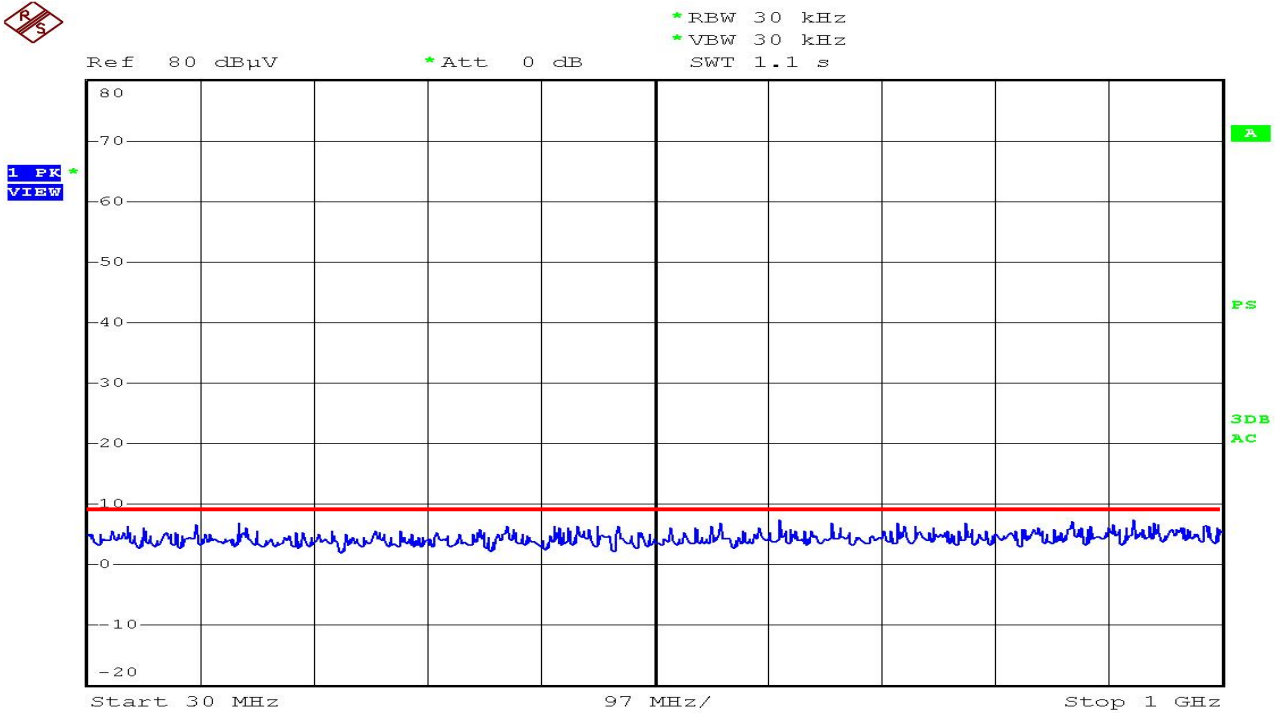

CH4

Appendix A. The Photos of Test Setup



Conducted Emissions - Front View



Conducted Emissions - Rear View

Appendix A. The Photos of Test Setup



Radiated Emissions - Front View

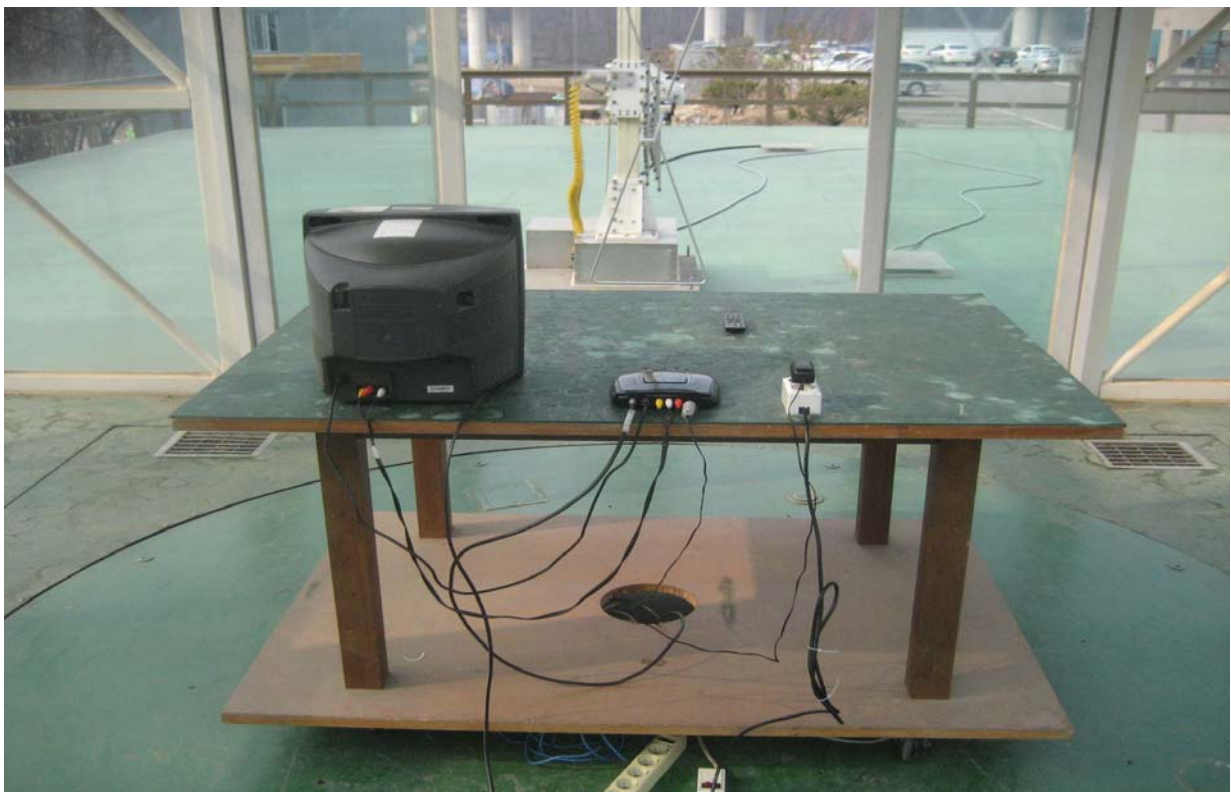

Radiated Emissions - Rear View

Appendix B. The Photos of EUT



Front View



Rear View

Appendix B. The Photos of EUT



Right View



Left View

Appendix B. The Photos of EUT



Adaptor



Adaptor Label

Appendix B. The Photos of EUT



Remote