

USER'S GUIDE

TFT LCD-MONITOR

Model No : L700C



DAEWOO

<http://www.dwe.co.kr>

FEDERAL COMMUNICATIONS COMMISSION RADIO FREQUENCY INTERFERENCE STATEMENT

NOTE : This equipment has been tested and found to comply with the limits for a Class B digital device, pursuant to Part 15 of the FCC Rules. These limits are designed to provide reasonable protection against harmful interference in a residential installation. This equipment generates, uses and can radiate radio frequency energy and, if not installed and used in accordance with the instructions, may cause harmful interference to radio communications. However, there is no guarantee that interference will not occur in a particular installation. If this equipment does cause harmful interference to radio or television reception, which can be determined by turning the equipment off and on, the user is encouraged to try to correct the interference by one or more of the following measures :

- Reorient or relocate the receiving antenna.
- Increase the separation between the equipment and receiver.
- Connect the equipment to an outlet on a circuit different from that to which the receiver is connected.
- Consult the dealer or an experienced radio or TV technician for help.

CAUTION : Any changes or modifications not expressly approved by the party responsible for compliance could void the user's authority to operate the equipment.

CANADIAN NOTICE

This Class B digital apparatus meets all requirements of the Canadian Interference-Causing Equipment Regulations.

AVIS CANADIEN

Cet appareil numérique de la Class B respecte toutes les exigences du Règlement sur le matériel brouilleur du Canada.

WICHTIGE INFORMATIONEN

Bitte lesen Sie alle diese Informationen, bevor Sie das Gerät in Betrieb nehmen! Lesen Sie sich außerdem die Bedienungsanleitung komplett und sorgfältig durch, da nur in diesem Fall eine problemlose Inbetriebnahme erwartet werden kann.

- Achten Sie darauf, daß das Gerät nur in eine 230V Schuko-Steckdose eingesteckt wird.
- Die Steckdose sollte jederzeit frei zugänglich sein um bei einem evtl. auftretenden Notfall das Gerät schnell vom Netz zu trennen.
- Achten Sie desweiteren darauf, daß die Netzanschlußleitung nicht mechanisch beansprucht oder sonstwie beschädigt wird.
- Öffnen Sie das Gerät niemals! Im Inneren befinden sich Teile mit gefährlicher Spannung.
- Bevor Sie das Gerät reinigen, ziehen Sie bitte den Netzstecker aus der Steckdose. Säubern Sie dann das Gerät mit einem feuchten (keinesfalls tropfnassen) Lappen.
- Stellen Sie das Gerät an einem ergonomisch günstigen Ort auf und sorgen Sie dafür, daß der Monitor mit nach ISO 9241 -3, -7, -8 geprüfter Peripherie betrieben wird, da nur unter diesen Umständen ein optimaler ergonomischer Betrieb des Gerätes sichergestellt ist.

Falls Sie dennoch Fragen haben, auf die die Bedienungsanleitung keine hinreichende Antwort geben kann, so kontaktieren Sie bitte den nächsten Fachhändler.

Maschinenlärminformationsverordnung 3. GSGV, 18.01 1991:
Der arbeitsplatzbezogene Schalldruckpegel beträgt 70 dB (A) oder weniger gemäß ISO 7779.



DECLARATION OF CONFORMITY

We, Manufacturer / Importer

DAEWOO ELECTRONICS CO., Ltd
541, 5-Ga, Namdaemoon-Ro, Jung-Gu
Seoul, Korea

declare under our sole responsibility that the product,

TFT LCD monitor
L700C

to which this declaration relates is in conformity with
the following standard(s) or other normative document(s)

Safety : EN60950/1992/A1:1993/A2:1993
A3:1995/A4:1997
EMC : EN 55022/8.1994/A1:1995/A2:1997
EN 55024/1998
EN 61000 -3-2,3/1995

following the provisions of 89/336 EEC-EMC Directive
and the provisions of 73/23 EEC-Low Voltage Directive.

Handed over by : Jong K. Choi, Director.
Display Business Division.

Nov , 2001 Seoul

Signature : _____

J.K.Choi Director.
Display Business Division.
DAEWOO ELECTRONICS CO., LTD.

Emission Characteristics Tested by SEMKO

A sample of this type has been tested and has shown compliance with the guidelines in the swedish document TCO 99.

This product is also designed for IT power system with phase to phase voltage of 230V.

The power cord is used as a main disconnect device. Disconnect the power cord before servicing. The outlet must be installed near the monitor and must be easily accessible.

As an ENERGY STAR® Partner, Daewoo Electronics Co., Ltd. has determined that this product meets the Energy Star® guidelines for energy efficiency.

The appliance is not intended for use by young children or infirm persons without supervision ;
Young children should be supervised to ensure that they do not play with the appliance.

CONTENTS

Introduction	1
Product Features	2
Setup	3
Connecting the 15 Pin Signal Cable and Power Cord	3
Operation & Adjustment	4
Specifications	10
Factory Preset Timings	12
Changing the Stand	13
Troubleshooting	15

Appendix

Description for D-sub Connector

INTRODUCTION

This manual explains how to correctly install, operate and get the best performance from your monitor. Please read this user's guide carefully before installing your monitor, then keep it near your monitor for quick reference.

First, please check that the contents of the box corresponds with the following checklist :

- ◆ TFT LCD monitor
- ◆ Power cord
- ◆ 15 pin signal cable
- ◆ User's guide
- ◆ Warranty card (Optional)

If any item is missing or damaged, please contact your dealer. Please keep the box and packing materials so that you may properly store or transport your monitor.

SETUP

PRODUCT FEATURES

- ◆ The monitor is designed for use in a small work area or for those who need more work space on the desk.
- ◆ The convenient and user-friendly on-screen display allows for easy and accurate adjustments of screen size, position and screen color.
- ◆ The monitor supports a safe working environment in strict compliance with the TCO 99 standard for low emissions .
- ◆ The monitor complies with the VESA Display Data Channel (DDC) specification for Plug and Play compatibility. Advanced microcircuitry makes setup and configuration fast and effortless.
- ◆ The monitor features Advanced Color Controls for fine-tuning to meet your own personal tastes or application requirements. Use the on-screen controls to adjust the color temperature, RGB gain value for the best possible screen color and intensity.
- ◆ Press the menu button and activate the Self-Diagnosis menu to determine whether your monitor is functioning normally, not receiving a signal or is receiving a signal that is out of scanning range.
- ◆ Activate the higher refresh rates of the monitor to stabilize the screen and eliminate the annoying flicker that contributes to eye-strain and headaches.
- ◆ The “borderless” full-screen display capability works under all graphic modes and provides a larger viewing area than conventional monitors, giving you a better picture with more workspace.
- ◆ The monitor supports the optimal display performance with 1280x1024 at 60Hz.

CONNECTING THE 15 PIN SIGNAL CABLE AND POWER CORD

1. Turn off the computer and monitor.
2. Connect the 15 pin signal cable to the output port of the video card in your computer and monitor.
3. Tighten the screws of the 15 pin signal cable.
4. Plug the power cord into the AC receptacle located on the back of the monitor.
5. Plug the other end of the power cord into the AC outlet.

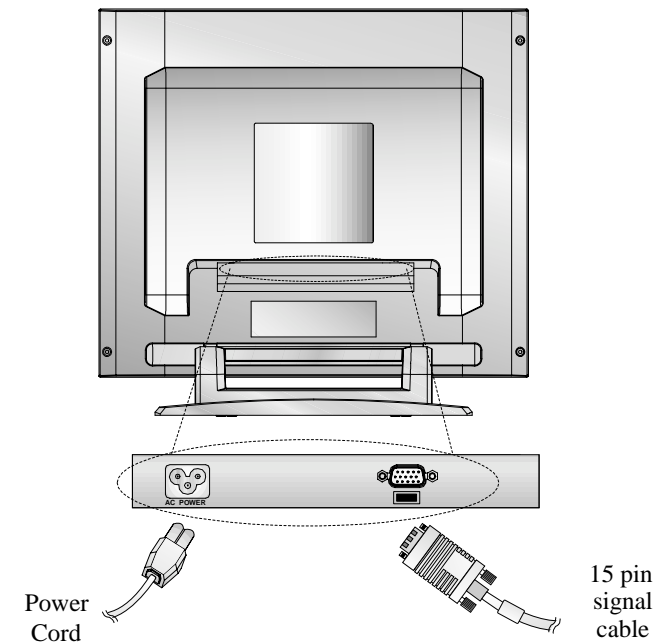

OPERATION & ADJUSTMENT

CONTROL PANEL

1 POWER

switches the monitor on and off.

2 POWER Indicator

shows both normal operation and power management status with power indicator light.

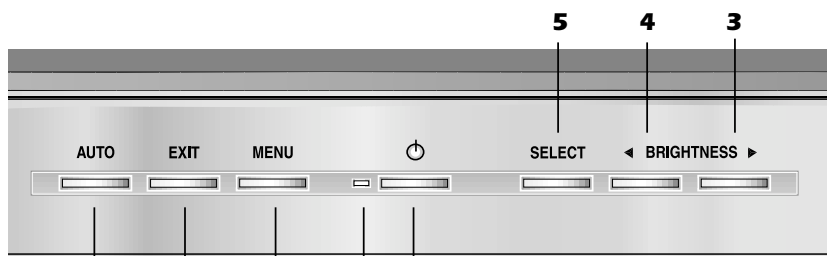

3 ► (*)

moves cursor to the right or low window in the OSD window and increases the value of any selected function.

4 ◀ (*)

moves cursor to the left or high window in the OSD window and decreases value of any selected function.

5 SELECT

moves from top menu to sub menu in the OSD window and opens the function window for the selected icon.

6 MENU

turns the OSD window on.

7 EXIT

turns the OSD (On-Screen Display) window off and moves from sub menu to top menu in the OSD window.

8 AUTO (*)

launches the AUTO TRACKING function directly.

(*) : Hot Key

KEY PROCESS

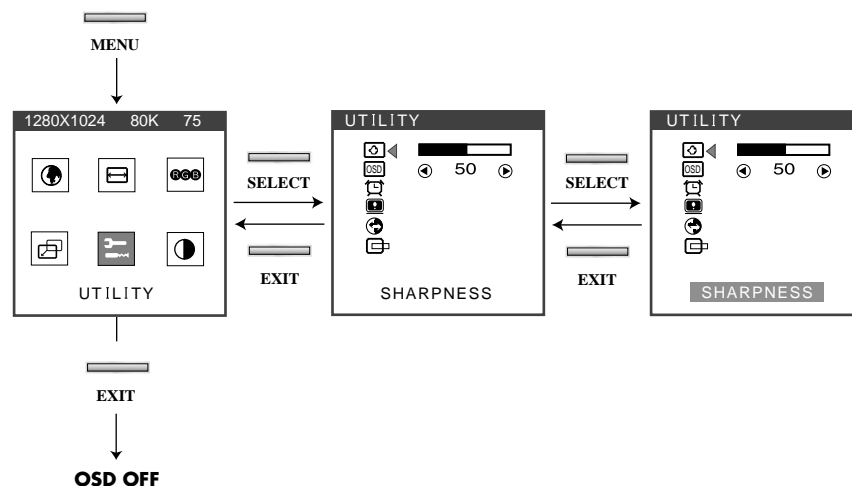

HOT KEY

AUTO



- When there is no OSD, if you press this AUTO button, you can use the best display performance fit for a current mode.

◀ BRIGHTNESS ▶

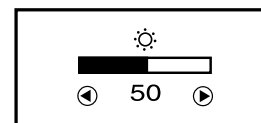





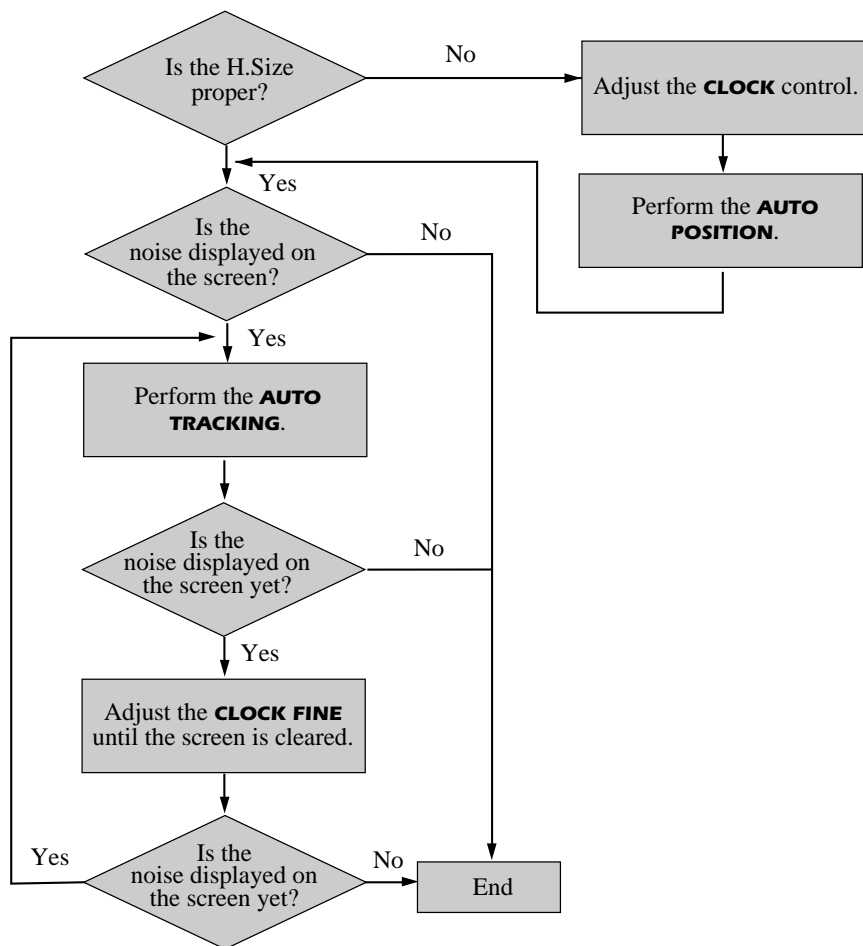











- When there is no OSD, if you press this BRIGHTNESS button, you can adjust the brightness directly.
 - ◀ : decreases brightness
 - ▶ : increases brightness

ADJUSTMENT PROCEDURE



OSD FUNCTIONS

ICON	CONTROL	FUNCTION
	LANGUAGE	Select language for OSD (6 languages).
	CLOCK	Adjust the width (horizontal size) of the screen image.
	CLOCK FINE	Sharpen the focus by aligning the illuminated pixels and adjust until the screen image looks focused, crisp and sharp. Adjusting the CLOCK FINE after the CLOCK adjustment will produce a clear screen.
	AUTO TRACKING	Adjust the horizontal & vertical picture image quality and size.
	COLOR TEMPERATURE	Choose different preset color temperatures or set your own customized color parameters.
	RED CONTROL	Adjust the red color.
	GREEN CONTROL	Adjust the green color.
	BLUE CONTROL	Adjust the blue color.
	H. CENTER & V. CENTER	Adjust the position of the display horizontally (left or right) and vertically (up or down).
	SHARPNESS	Adjust the display image quality (if the screen proceed to scaling up).
	OSD POSITION	Adjust the OSD position horizontally (left or right) and vertically (up or down).

ICON	CONTROL	FUNCTION
	OSD TIME OUT	Adjust the display OSD Menu.
	STATUS	Display horizontal & vertical frequency and polarity.
	RECALL	Reset the screen to the Factory Preset Display Settings.
	AUTO POSITION	Choose automatically the proper horizontal position and vertical position & size of the screen image.
	CONTRAST	Adjust the contrast of image, the difference between light and dark areas on the screen.

SELF DIAGNOSIS

If there is no image, the Self Diagnosis screen will be displayed. Self Diagnosis function checks if the status of the monitor screen is No Signal, Out of range or None support .



No Signal screen is displayed when the D-Sub signal connector is not connected or the status of the monitor is on DPMS mode.



Out of Range screen is displayed when the applied frequency is under or over normal range.

- Normal range
(Non-interlaced mode only)
- H : 30 - 80 KHz
- V : 56 - 77 Hz



None support screen is displayed when the applied frequency is under or over factory preset timings.

SPECIFICATIONS

Panel	Size	17-inch (43.2 cm) diagonal
	Pixel Pitch	0.264 x 0.264 mm
	Viewing Angle	75°(Right/Left)
		70°(up), 70°(down)
	Contrast Ratio	400:1 contrast ratio (typ)
	Brightness	250cd/m ² brightness (typ)
Color Filter	RGB vertical stripe	
Synchronization	Horizontal	30 - 80 KHz
	Vertical	56 - 77 Hz
Video Bandwidth		135 MHz
Max Resolution		1280 x 1024 @75Hz
Colors		8 bit (16.7M Colors)
Display Area		337.9mm x 270.3mm
PC Input Signal	Sync	H/V separate (TTL)
	Video	15 pin mini D-sub(Analog RGB)
		DVI-D(Optional)
AV Input Signal (Option)	Video	CVBS(RCA), S-Video(Mini-DIN)
	Audio	RCA Left+Right Input
		Stereo Mini Jack Input & Output
TV Receiving Signal (Option)	TV Tuner	NTSC, PAL
External Speaker (Option)	Max. Output	6W(Left 3W+Right 3W)
Plug and Play		VESA DDC Compatible
Power Source		100-240 Vac, 50/60 Hz (Free Voltage)
Power Consumption		40 W
Dimension-W x H x D		420 x 398 x 194 mm (with stand)
		420 x 360 x 68 mm (without stand)

Weight-net/gross	6.2/7.6 Kg(13.6/16.7 lbs)
Power Saving	EPA, VESA DPMS, Nutek Compliant
Tilt Range	5° forward, 30° backward
Operating Temperature	10 ~ 40°C /50 ~ 104°F

- The specification can be changed without any prior notice to improve the quality of the product.
- The LCD panel may have some defective pixels (e.g. slightly light or dark) due to a characteristic of the LCD panel. But there is no defect in your LCD product itself.

FACTORY PRESET TIMINGS

VESA MODES				
Mode	Resolution (dots Xlines)	H.Freq(KHz)	V.Freq(Hz)	Remark
VGA	640 X 480 @ 60Hz	31.5	60	Non-interlaced
VGA	640 X 480 @ 72Hz	37.9	72	Non-interlaced
VGA	640 X 480 @ 75Hz	37.5	75	Non-interlaced
SVGA	800 X 600 @ 56Hz	35.2	56	Non-interlaced
SVGA	800 X 600 @ 60Hz	37.9	60	Non-interlaced
SVGA	800 X 600 @ 72Hz	48.1	72	Non-interlaced
SVGA	800 X 600 @ 75Hz	46.9	75	Non-interlaced
XGA	1024 X 768 @ 60Hz	48.4	60	Non-interlaced
XGA	1024 X 768 @ 70Hz	56.5	70	Non-interlaced
XGA	1024 X 768 @ 75Hz	60.0	75	Non-interlaced
SXGA	1280 X 1024 @ 60Hz	64.0	60	Non-interlaced
SXGA	1280 X 1024 @ 75Hz	80.0	75	Non-interlaced
SXGA	1152 X 864 @ 75Hz	67.5	75	Non-interlaced
SXGA	1280 X 960 @ 60Hz	60.0	60	Non-interlaced
IBM MODES				
Mode	Resolution (dots Xlines)	H.Freq(KHz)	V.Freq(Hz)	Remark
EGA	640 X 350 @ 70Hz	31.5	70	Non-interlaced
DOS	720 X 400 @ 70Hz	31.3	70	Non-interlaced
MAC MODES				
Mode	Resolution (dots Xlines)	H.Freq(KHz)	V.Freq(Hz)	Remark
VGA	640 X 480 @ 67Hz	35.0	67	Non-interlaced
SVGA	832 X 624 @ 75Hz	49.7	75	Non-interlaced
SXGA	1152 X 870 @ 75Hz	68.7	75	Non-interlaced
THE OTHERS				
Mode	Resolution (dots Xlines)	H.Freq(KHz)	V.Freq(Hz)	Remark
SXGA	1280 X 1024 @ 70Hz	74.4	70	Non-interlaced

■ The LCD Monitor has only Non-interlaced modes without flicker.

CHANGING THE STAND

REMOVING THE STAND

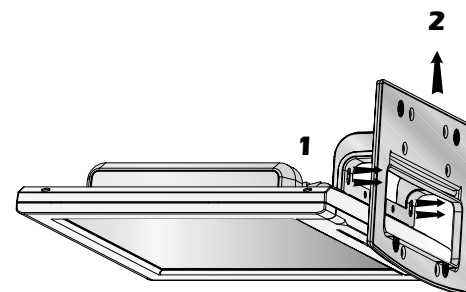

1. Remove 4 screws.
2. Remove the stand

REMOVING THE COVER

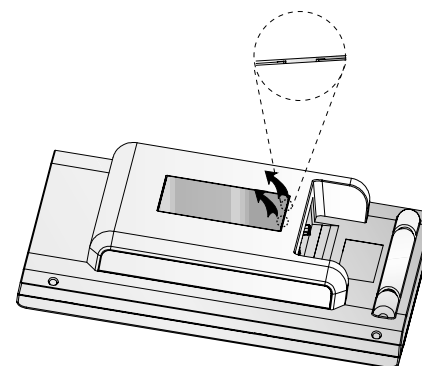

Remove the Cover.

TROUBLESHOOTING

ATTACHING THE MONITOR WITH THE ARM-STAND(OPTION)

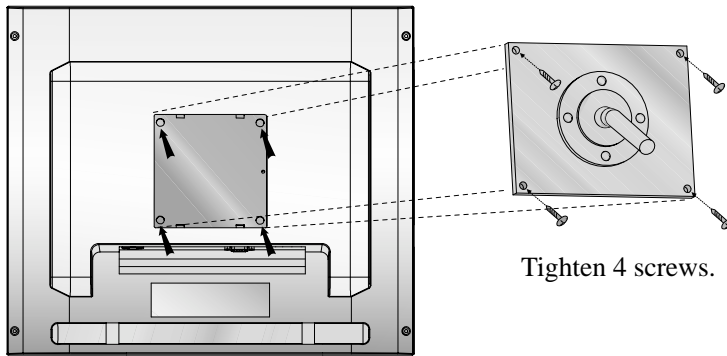

- Use the VESA approved arm-stand.
(100x100 mm hole spacing)

Symptom	Check
Picture is jitterd.	Adjust Clock to set the screen position and adjust Clock fine until a noise isn't displayed.
No picture.	<p>Check if power switch and computer power switch are in the on position.</p> <p style="text-align: center;">↓</p> <p>Check if the signal cable is correctly connected to the video card.</p> <p style="text-align: center;">↓</p> <p>Check if the pins of D subconnector are not bent.</p> <p style="text-align: center;">↓</p> <p>Check if the computer is in the power- saving mode.</p>
POWER LED is not lit.	<p>Check if power switch is in the on position.</p> <p style="text-align: center;">↓</p> <p>Check if the power cord is correctly connected.</p>
Image is unstable.	Check if the signal cable is suitable to the video card.
Image is not centered, too small or too large.	Adjust Clock or H&V Center to get the proper image.
Picture bounces or a wave pattern is present in the picture.	<p>Keep the devices that may cause electrical interference away from the monitor.</p> <p style="text-align: center;">↓</p> <p>See the FCC information at the front cover of the manual.</p>
Picture is blurred.	Adjust Contrast and Brightness.

APPENDIX

DESCRIPTION FOR D-SUB CONNECTOR

Pin	Signal
1	Red
2	Green
3	Blue
4	GND
5	GND
6	GND-Red
7	GND-Green
8	GND-Blue
9	+5Vdc
10	GND-H.Sync
11	GND-V.Sync
12	Bi-directional Data(SDA)
13	Horizontal Sync
14	Vertical Sync(VCLK)
15	Data Clock(SCL)

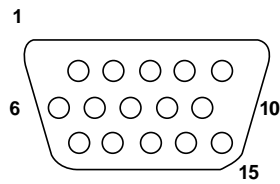

* GND=Ground