

# USER'S GUIDE

COLOR MONITOR

Model No : 432X



**DAEWOO**

## IMPORTANT SAFEGUARDS

1. Read all of these instructions.

2. Save these instructions for later use.



3. Unplug this monitor from the wall outlet before cleaning. Do not use liquid cleaners or aerosol cleaners. Use a damp cloth for cleaning.

4. Do not use attachments not recommended by the monitor manufacturer as they may cause hazards.

5. Do not use this monitor near water for example, near a bathtub, washbowl, kitchen sink, or laundry tub, in a wet basement or near a swimming pool, etc.



6. Do not place this monitor on an unstable cart, stand, or table. The monitor may fall, causing serious injury to a child or adult, and serious damage to the appliance.



7. Slots and openings in the cabinet and the back or bottom are provided for ventilation, and to ensure reliable operation of the monitor and to protect it from overheating, these openings must not be blocked or covered. The openings should never be blocked by placing the monitor on a bed, sofa, rug, or other similar surface. This should never be placed near or over a radiator or heat register. This monitor should not be placed in a built-in installation such as a bookcase unless proper ventilation is provided.



8. This monitor should be operated only from the type of power source indicated on the marking label. If you are not sure of the power supplied to your home, consult your monitor dealer or local power company.



9. This monitor is equipped with a 3-wire grounding type plug, a plug having a third (grounding) pin. This plug will only fit into a grounding type power outlet. This is a safety feature. If you are unable to insert the plug into the outlet, contact your electrician to replace your obsolete outlet. Do not defeat the purpose of the grounding type plug.



10. Do not allow anything to rest on the power cord. Do not locate this monitor where the cord will be abused by persons walking on it.

11. Follow all warnings and instructions marked on the monitor.



12. For added protection for this monitor during a lightning storm, or when it is left unattended and unused for long periods of time, unplug it from the wall outlet. This will prevent damage to the set due to lightning and powerline surges.

13. Do not overload wall outlets and extension cords as this can result in fire or electric shock.

14. Never push objects of any kind into this monitor through cabinet slots, as they may touch dangerous voltage points or short out parts that could result in a fire or electric shock. Never spill liquid of any kind on the monitor.



15. Do not attempt to service this monitor yourself as opening or removing covers may expose you to dangerous voltage or other hazards. Refer all servicing to qualified service personnel.

16. Unplug this monitor from the wall outlet and refer servicing to qualified service personnel under the following conditions:

a. When the power cord or plug is damaged or frayed.

b. If liquid has been spilled into the monitor.

c. If the monitor has been exposed to rain or water.

d. If the monitor does not operate normally by following the operating instructions. Adjust only those controls that are covered by the operating instructions as improper adjustment of other controls may result in damage and will often require extensive work by a qualified technician to restore normal operation.

e. If the monitor has been dropped or the cabinet has been damaged.

f. When the monitor exhibits a distinct change in performance this indicates a need for service.



17. When replacement parts are required be sure the service technician has used replacement parts specified by the manufacturer that have the same characteristics as the original part. Unauthorized substitutions may result in fire, electric shock, or other hazards.

18. Upon completion of any service or repairs to this monitor, ask the service technician to perform routine safety checks to determine that the monitor is in safe operating condition.

## FEDERAL COMMUNICATIONS COMMISSION RADIO FREQUENCY INTERFERENCE STATEMENT

**NOTE :** This equipment has been tested and found to comply with the limits for a Class B digital device, pursuant to Part 15 of the FCC Rules. These limits in a residential installation. This equipment generates, uses and can radiate radio frequency energy and, if not installed and used in accordance with the instructions, may cause harmful interference to radio communications. However, there is no guarantee that interference will not occur in a particular installation. If this equipment does cause harmful interference to radio or television reception, which can be determined by turning the equipment off and on, the user is encouraged to try to correct the interference by one or more of the following measures :

- Reorient or relocate the receiving antenna.
- Increase the separation between the equipment and receiver.
- Connect the equipment to an outlet on a circuit different from that to which the receiver is connected.
- Consult the dealer or an experienced radio, TV technician for help.

## CANADIAN DEPARTMENT OF COMMUNICATIONS COMPLIANCE STATEMENT

This digital apparatus does not exceed the Class A/Class B (whichever is applicable) limits for radio noise emissions from digital apparatus set out in the Radio Interference Regulations of the Canadian Department of Communications.

Avis de conformité aux normes du Ministère des Communications du Canada.

Le présent appareil numérique n'émet pas de bruits radioélectriques dépassant les limites applicables aux appareils numériques de Class A/de Class B (selon le cas) prescrites dans le règlement sur le brouillage radioélectrique édicté par le ministère des communications du Canada.

## WICHTIGE INFORMATIONEN

Bitte lesen Sie alle diese Informationen, bevor Sie das Gerät in Betrieb nehmen! Lesen Sie sich außerdem die Bedienungsanleitung komplett und sorgfältig durch, da nur in diesem Fall eine problemlose Inbetriebnahme erwartet werden kann.

- Achten Sie darauf, daß das Gerät nur in eine 230V Schuko-Steckdose eingesteckt wird.
- Die Steckdose sollte jederzeit frei zugänglich sein um bei einem evtl. auftretenden Notfall das Gerät schnell vom Netz zu trennen.
- Achten Sie desweiteren darauf, daß die Netzanschlußleitung nicht mechanisch beansprucht oder sonstwie beschädigt wird.
- Öffnen Sie das Gerät niemals! Im Inneren befinden sich Teile mit gefährlicher Spannung.
- Bevor Sie das Gerät reinigen, ziehen Sie bitte den Netzstecker aus der Steckdose. Säubern Sie dann das Gerät mit einem feuchten (keinesfalls tropfnassen) Lappen.
- Die in diesem Gerät entstehende Röntgenstrahlung ist ausreichend abgeschirmt (Ortsdosisleistung in 0.1m Abstand weniger als 1.0µ Sv/h). Beschleunigungsspannung maximal 25Kv.
- Stellen Sie das Gerät an einem ergonomisch günstigen Ort auf und sorgen Sie dafür, daß der Monitor mit nach GS-VW-SG7 geprüfter Peripherie betrieben wird, da nur unter diesen Umständen ein optimaler ergonomischer Betrieb des Gerätes sichergestellt ist.

Falls Sie dennoch Fragen haben, auf die die Bedienungsanleitung keine hinreichende Antwort geben kann, so kontaktieren Sie bitte den nächsten Fachhändler.

Maschinenlärminformationsverordnung 3. GSGV, 18.01 1991:  
Der arbeitsplatzbezogene Schalldruckpegel beträgt 70 dB (A) oder weniger gemäß ISO 7779.



## DECLARATION OF CONFORMITY

We, Manufacturer / Importer

DAEWOO ELECTRONICS CO., Ltd  
541, 5-Ga, Namdaemoon-Ro, Jung-Gu  
Seoul, Korea

declare under our sole responsibility that the product,

Color Display monitor  
432X

to which this declaration relates is in conformity with the following standard(s) or other normative document(s)

Safety : EN60950/1992/A1:1993/A2:1993  
A3:1995/A4:1997

EMC : EN 55022/8.1994, EN 50082-1/1992  
EN 60555 Part 2, 3/1987

following the provisions of 89/336 EEC-EMC Directive and the provisions of 73/23 EEC-Low Voltage Directive.

Handed over by : S.Lee, Managing Director.  
Display Business Division

Jan, 1999 Seoul Signature:

A handwritten signature in black ink, appearing to be "S.Lee", written over a horizontal line.

**S.Lee, Managing Director.**  
**Display Business Division.**  
**DAEWOO ELECTRONICS Co., Ltd**

---

---

### **Emission Characteristics Tested by SEMKO**

A sample of this type has been tested and has shown compliance with the guidelines in the Swedish document MPR II.

This product is also designed for IT power system with phase to phase voltage of 230V.

The power cord is used as a main disconnect device. Disconnect the power cord before servicing. The outlet must be installed near the monitor and must be easily accessible.

As an ENERGY STAR Partner, Daewoo Electronics Co., Ltd. has determined that this product meets the Energy Star guidelines for energy efficiency.

The appliance is not intended for use by young children or infirm persons without supervision ;  
Young children should be supervised to ensure that they do not play with the appliance.

---

---

## CONTENTS

<b>Introduction</b> .....	1
Product Features .....	2
<b>Setup</b> .....	3
Installing the Tilt/Swivel Stand .....	3
Connecting the Signal Cable and Power Cord ..	4
Connecting to the Macintosh Computer .....	5
Power Management System .....	6
DDC for Plug & Play .....	6
<b>Operation &amp; Adjustment</b> .....	7
<b>Specifications</b> .....	13
<b>Factory Preset Timings</b> .....	15
<b>Troubleshooting</b> .....	16
<b>Appendix</b>	
Description for D-sub Connector	

---

---

## INTRODUCTION

This manual explains how to correctly install, operate and get the best performance from your monitor. Please read this user's manual carefully before installing your monitor, then keep it near your monitor for quick reference.

First, please check that the contents of the carton box corresponds with the following checklist :

- Color monitor
- Power cord
- User's manual
- Tilt/swivel stand
- Warranty Card (Optional)

If there is any item missing or damaged, please contact your dealer. Please keep the carton box and packing materials so that you may properly store or transport your monitor.

## PRODUCT FEATURES

- The convenient and user-friendly on-screen display allows for easy and accurate adjustments of horizontal and vertical screen size and position, geometry and screen color.
- The monitor supports a safe working environment in strict compliance with the MPR II standard for low emissions (Optional).
- The monitor complies with the VESA Display Data Channel (DDC) specification for “Plug & Play” compatibility. Advanced microcircuitry makes set-up and configuration fast and effortless.
- The monitor features Advanced Color Controls for fine-tuning to meet your own personal tastes or application requirements. Use the on-screen controls to adjust the color temperature, RB gain value for the best possible screen color and intensity.
- Press the menu button and activate the Self-Diagnosis menu to determine whether your monitor is functioning normally, not receiving a signal or is receiving a signal that is out of scanning range.
- Just activate the higher refresh rates of the monitor to stabilize the screen and eliminate the annoying flicker that contributes to eye-strain and headaches.
- The “borderless” full-screen display capability works under all graphic modes and provides a larger viewing area than conventional monitors, giving you a better picture with more workspace.

## SETUP

### INSTALLING THE TILT/SWIVEL STAND

1. Ensure that the power to the monitor is off.
2. Set the monitor face down with the underside facing you. Please be careful so as not to scratch the monitor screen.
3. Align the four hooks on the stand with the guide holes of bottom chassis of the monitor.
4. Insert the hooks into the guide holes.
5. Slide the tilt/swivel stand toward the front of the monitor until the latch locks in position.
6. Turn the monitor and the stand upright.

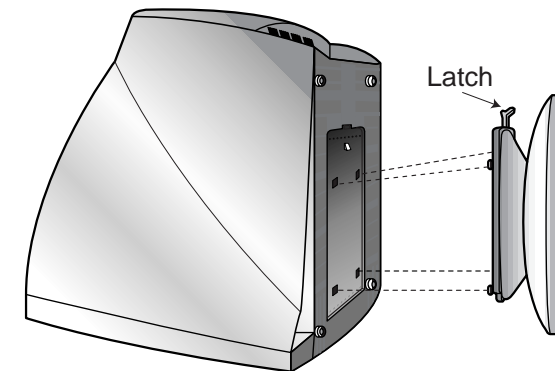

If you want to remove the tilt/swivel stand on the monitor, press the latch and pull the tilt/swivel stand toward the back of the monitor. Lift the stand to separate.

## CONNECTING THE SIGNAL CABLE AND POWER CORD

1. Turn off the computer and monitor.
2. Connect the 15 pin D-sub connector to the output port of the video card in your computer.
3. Tighten the screws of connector.
4. Plug the power cord into the AC receptacle located at the back of the monitor.
5. Plug the other end of the power cord into the AC outlet.

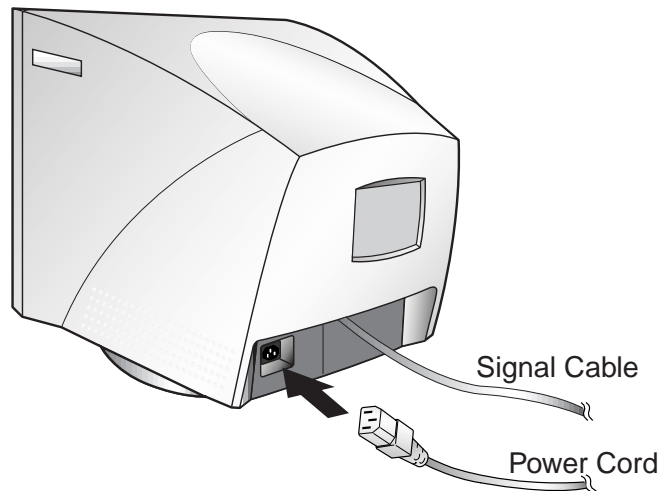

## CONNECTING TO THE MACINTOSH COMPUTER

1. Turn off the computer and monitor.
2. Attach the Macintosh cable adapter to the Macintosh video card.
3. Tighten the screws on the cable adapter.
4. Connect the signal cable provided with your monitor to the other end of the Macintosh cable adapter.
5. Tighten the screws between the Macintosh cable adapter and the signal cable.

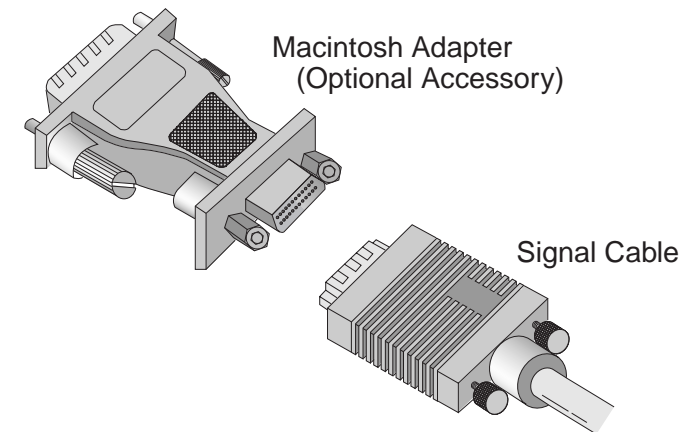

## POWER MANAGEMENT SYSTEM

If you use the monitor with a computer which complies with the power saving program, you can set the monitor to go blank when the system has remained unused for a period of time. To specify the period or to disable this feature, set the system timeout field of the computer's system setup program or use special software for power saving. See the computer user's manual for the details of using the system setup. While the monitor is in power saving mode (blank screen), it consumes less power than normal state; the color of the power LED will indicate the state. To restore the screen image, press any key of your keyboard or move your mouse. If the signal cable is connected loosely or disconnected, the power saving feature will operate.





## DISPLAY DATA CHANNEL (DDC) FOR PLUG & PLAY

If you use the monitor with a computer which complies with DDC1/2B/2Bi/2B+ of VESA, the Host-Video Card automatically configures itself without your intervention in a way that best fits the attached monitor. The Display Data Channel, DDC, allows the monitor to inform the host system about configuration information for optimum use of the monitor. Use of the Video Card utility is not required to match the resolutions and refresh rates of the monitor and video card.

## OPERATION & ADJUSTMENT

### Control Panel



- 
  - Move cursor to the right window from the MENU window
  - Increase the value of any selected FUNCTION
- 
  - Move cursor to the left window from the MENU window
  - Decrease the value of any selected FUNCTION
- 
  - Launch OSD(On-Screen Display) MENU window
- 
  - Move cursor to the high window from the MENU window
- 
  - Move cursor to the low window from the MENU window



### Key Process

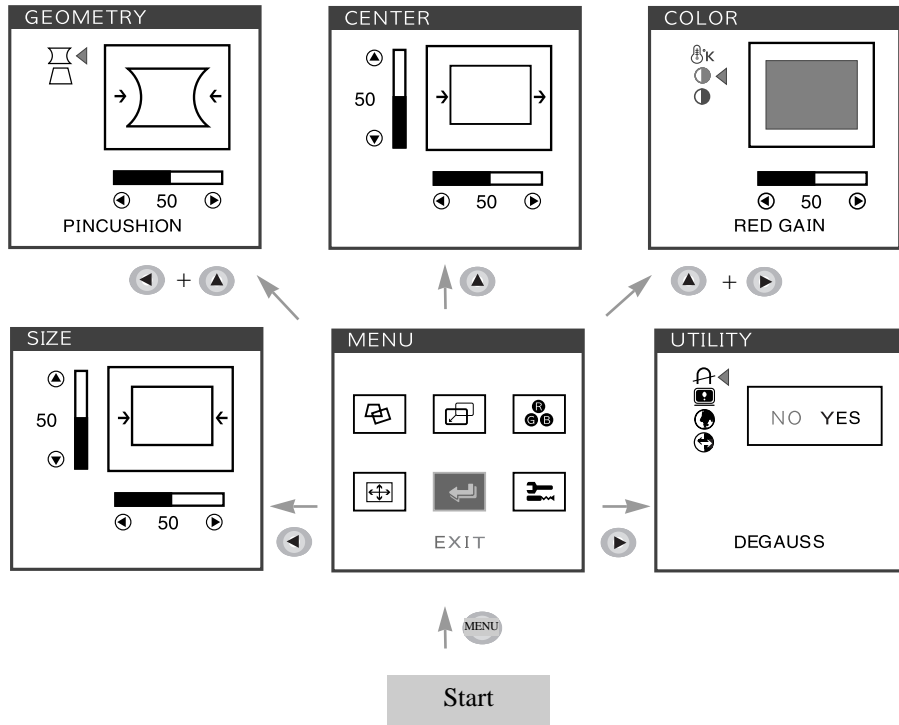

- When you choose the icon  on the OSD window, you can exit the OSD screen.

### Hot Key



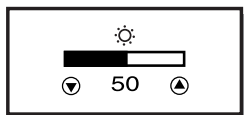



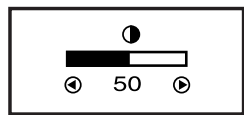







#### BRIGHTNESS



#### CONTRAST





### Geometry Menu Functions

-  **PINCUSHION** Adjust the left and right margins for more convex or more concave margins.
  - Image turns to  by  .
  - Image turns to  by  .
-  **TRAPEZOID** Adjust the trapezoid of the screen by moving the lines inward or outward.
  - Image turns to  by  .
  - Image turns to  by  .
-  **ROTATION** Adjust the rotation when the screen is tilted left or right (Optional).
  - Image turns to  by  .
  - Image turns to  by  .

### Center Menu Functions

-  **H. CENTER & V. CENTER** Adjust the position of the display horizontally(left or right) and vertically (up or down).

### Color Menu Functions

-  **COLOR TEMP** Choose different preset color temperatures or set your own customized color parameters.
-  **RED GAIN** Adjust the red gain.
-  **BLUE GAIN** Adjust the blue gain.

## Size Menu Functions



### H. SIZE & V. SIZE

Adjust the width (horizontal size) and the height (vertical size) of the display.

## Utility Menu Functions



### DEGAUSS

Degauss the display and restore image quality.



### STATUS

Display horizontal & vertical frequency and polarity.



### LANGUAGE

Select language for OSD (5 languages).



### RECALL

Reset the screen to the Factory Preset Display Settings.

## Self Diagnosis

When the monitor doesn't display, if you press any key, Self Diagnosis screen is displayed. Self Diagnosis function checks if the status of the monitor is No Signal or Out of range.

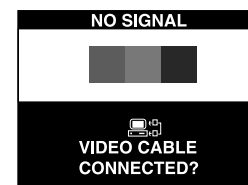

No Signal screen is displayed when the D-Sub signal connector is not connected or the status of the monitor is on DPMS mode.

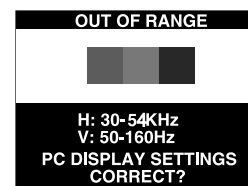

Out of Range screen is displayed when the applied frequency is under or over normal range.

■ Normal range  
H : 30 - 54 KHz  
V : 50 - 160 Hz

## SPECIFICATIONS

### Picture Tube

Type : 14-inch, Flat Square Tube type  
(13.2-inch, viewing area)

Dot Pitch : 0.28 mm

Face Treatment : Anti-reflect / Anti-static(Optional)

### Video

Input Signal : R.G.B. Analog

Pixel Clock (=Rate) : 65 MHz

Input Sync : TTL, separate negative / positive

### Scan Frequency

Horizontal : 30 - 54 KHz (automatic)

Vertical : 50 - 160 Hz (automatic)

### Max. Resolution

1024 dots X 768 lines (at 60 Hz)

### Power Source

Free Voltage (100-240 Vac, 50/60 Hz)

### Display Area

Standard Display Area : 250(H) X 187(V) mm  
9.8(H) X 7.4(V) in

Full Screen Size : 274(H) X 204(V) mm  
10.8(H) X 8.0(V) in

### Power Consumption

Max.70 W

State	Recovery Time	Power LED
On	None	Green
Stand-by Suspend	3 seconds	Green: 1 second Amber : 0.5 second
Off	-	Amber

### Tilt/Swivel Range

Tilt : 5° forward, 10° backward

Swivel : ±45° leftward, rightward

### Dimension(set with stand)

356(W) X 371(H) X 382(D) mm

14.0(W) X 14.6(H) X 15.0(D) in

### Weight(net/gross)

10.8/ 12.8 Kg

23.8/28.2 lbs

### Operating Environment

Temperature : 10 ~ 40°C /50 ~ 104°F

Relative Humidity : 8 ~ 80%

### Storage Environment

Temperature : - 20 ~ 45°C /- 4 ~ 113°F

Relative Humidity : 5 ~ 90%

## FACTORY PRESET TIMINGS

Mode	Resolution (dots X lines)	H.Freq(KHz)	V.Freq(Hz)	Remark
VGA	640 X 480	31.5	60	Non-interlaced
VESA VGA 75	640 X 480	37.5	75	Non-interlaced
VGA	720 X 400	31.5	70	Non-interlaced
VESA 46K	800 X 600	46.9	75	Non-interlaced
VESA SVGA 85	800 X 600	53.7	85	Non-interlaced
VESA 48K	1024 X 768	48.3	60	Non-interlaced

This monitor has stored above-mentioned 6 timings in factory. You can save up to 10 modes in the user memory automatically. Please note that if you save to user memory over ten times, the first mode saved will be replaced with your eleventh mode.

## TROUBLESHOOTING

Symptom	Check
<b>No picture.</b>	Check if POWER SWITCH and COMPUTER POWER SWITCH are in the on position. ↓ Check if the signal cable is correctly connected to the video card. ↓ Check if the pins of D-sub connector are not bent. ↓ Check if the computer is in the power saving mode.
<b>POWER LED is not lit.</b>	Check if POWER SWITCH is in the on position. ↓ Check if the power cord is correctly connected.
<b>Image is unstable.</b>	Check if the signal cable is suitable to the video card.
<b>Image is not centered, too small or too large.</b>	Adjust H & V SIZE or H & V POSITION to get the proper image.
<b>Picture bounces or a wave pattern is present in the picture.</b>	Keep the devices that may cause electrical interference away from the monitor. ↓ See the FCC information at the front cover of the manual.
<b>Color looks blotchy.</b>	Operate DEGAUSS once.
<b>Picture is blurred.</b>	Adjust CONTRAST and BRIGHTNESS. ↓ Operate DEGAUSS once.
<b>Edges of available area on the screen are not straight.</b>	Adjust PINCUSHION/TRAPEZOID.

---

---

# APPENDIX

## DESCRIPTION FOR D-SUB CONNECTOR

Pin	Signal
1	Red
2	Green
3	Blue
4	GND
5	GND
6	GND-Red
7	GND-Green
8	GND-Blue
9	+5Vdc
10	GND-H.Sync
11	GND-V.Sync
12	Bi-directional Data(SDA)
13	Horizontal Sync
14	Vertical Sync(VCLK)
15	Data Clock(SCL)

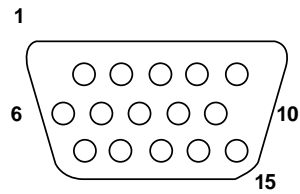

\* GND=Ground