

ABOUT THIS MANUAL

VISION CREATIVE, INC.

서울 종로구 통의동
6번지 이룸빌딩 4층

담 당	방요섭 님		
브 랜 드	DAEWOO	언 어	영어
F. MODEL	KOM-9F0CTX / 9F0CDA		
B. MODEL	KOM-9F0CTX / 9F0CDA		
B U Y E R	영문기본		
COUNTRY			
인 쇄			
MEMO	총 28p 11.08.12-표지, 1p, 2p, 3p, 4p, 5p, 6p _ 신규 7p 11.09.07-1p, 2p, 9p, 23p, 28p(보증서 추가)수정_ 신규 5p 11.09.09-3p, 4p, 5p, 16p, 17p, 19p, 20p, 21p, 23p, 24p, 27p, 28p 수정_ 신규 12p 11.10.13-3p, 9p 수정_ 신규 2p		

연락처

VISION 담당 방문수

TEL: 730-0660 FAX: 730-3788



MICROWAVE OVEN

KOM-9F0CTX / 9F0CDA

OPERATING
INSTRUCTIONS

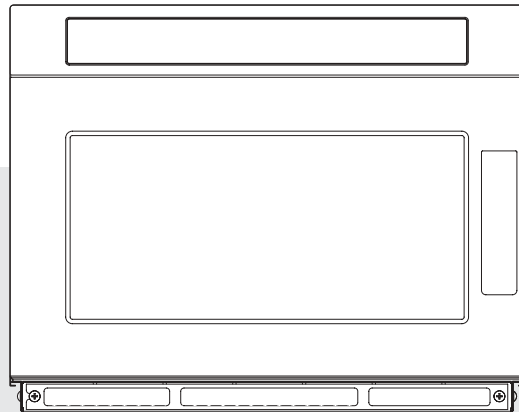

FOR COMMERCIAL USE

Before operating this oven, please read these instructions completely.

PRECAUTIONS TO AVOID POSSIBLE EXPOSURE TO EXCESSIVE MICROWAVE ENERGY

- (a) Do not attempt to operate this oven with the door open since open-door operation can result in harmful exposure to microwave energy. It is important not to defeat or tamper with the safety interlocks.
- (b) Do not place any object between the oven front face and the door or allow soil or cleaner residue to accumulate on sealing surfaces.
- (c) Do not operate the oven if it is damaged. It is particularly important that the oven door close properly and that there is no damage to the: (1) door (bent), (2) hinges and latches (broken or loosened), (3) door seals and sealing surfaces.
- (d) The oven should not be adjusted or repaired by anyone except properly qualified service personnel.

TABLE OF CONTENTS

PRECAUTIONS TO AVOID POSSIBLE EXPOSURE TO EXCESSIVE MICROWAVE ENERGY.....	1
IMPORTANT SAFETY INSTRUCTIONS.....	2
INSTALLATION.....	3
FEDERAL COMMUNICATIONS COMMISSION RADIO FREQUENCY INTERFERENCE STATEMENT ..	5
GROUNDING INSTRUCTIONS	5
SPECIFICATIONS.....	6
FEATURES DIAGRAM.....	7
FEATURES DIAGRAM (continued).....	8
OPERATION PROCEDURE.....	9
CONTROLS.....	10
Manual Cooking.....	10
Preprogrammed Pads.....	11
Double Quantity.....	12
Programming Pads.....	13
Programming Cook Factor.....	14
20 sec.+ pad.....	15
Changing User Options	16
COOKING INSTRUCTIONS.....	17
MICROWAVING PRINCIPLES.....	18
HOW MICROWAVES COOK FOOD	18
CONVERSION CHARTS.....	18
COOKING TECHNIQUES	19
DEFROSTING GUIDE.....	20
DEFROST AND COOKING CHART.....	21
CARE OF YOUR MICROWAVE OVEN.....	23
CLEANING AND MAINTENANCE.....	23
CLEANING THE CEILING COVER	24
CLEANING THE AIR FILTER.....	24
USE YOUR MICROWAVE OVEN SAFELY	25
BEFORE YOU CALL FOR SERVICE	26
QUESTIONS AND ANSWERS.....	26
QUESTIONS AND ANSWERS (continued).....	27
DISPOSAL OF USED ELECTRICAL & ELECTRONIC EQUIPMENT.....	27

IMPORTANT SAFETY INSTRUCTIONS

When using electrical appliances, basic safety precautions should be followed, including the following:

WARNING - To reduce the risk of burns, electric shock, fire, injury to persons or exposure to excessive microwave energy:

1. Read all instructions before using the appliance.
2. Read and follow the specific "PRECAUTIONS TO AVOID POSSIBLE EXPOSURE TO EXCESSIVE MICROWAVE ENERGY" found on page 1.
3. This appliance must be grounded. Connect only to properly grounded outlet. See "GROUNDING INSTRUCTIONS" found on page 5.
4. Install or locate this appliance only in accordance with the provided installation instructions.
5. Some products such as whole eggs and sealed containers - for example, closed glass jars-are able to explode and should not be heated in this oven.
6. Use this appliance only for its intended use as described in this manual. Do not use corrosive chemicals or vapors in this appliance. This type of oven is specifically designed to heat, cook, or dry food. It is not designed for industrial or laboratory use.
7. As with any appliance, close supervision is necessary when used by children.
8. Do not operate this appliance if it has a damaged cord or plug, if it is not working properly, or if it has been damaged or dropped.
9. This appliance should be serviced only by qualified service personnel.
Contact nearest authorized service facility for examination, repair or adjustment.
10. Do not cover or block any openings on the appliance.
11. Do not store this appliance outdoors. Do not use this product near water — for example, near a kitchen sink, in a wet basement, or near a swimming pool, or similar locations.
12. Do not immerse cord or plug in water.
13. Keep cord away from heated surfaces.
14. Do not let cord hang over edge of table or counter.
15. Either:
 - a) When cleaning surfaces of door and oven that comes together on closing the door, use only mild, nonabrasive soaps or detergents applied with a sponge or soft cloth , or
 - b) When separate cleaning instructions are provided, See door surface cleaning instructions on.
16. To reduce the risk of fire in the oven cavity:
 - a) Do not overcook food. Carefully attend appliance when paper, plastic, or other combustible materials are placed inside the oven to facilitate cooking.
 - b) Remove wire twist ties from paper or plastic bags before placing bag in oven.
 - c) If materials inside the oven ignite, keep oven door closed, turn oven off, and disconnect the power cord, or shut off power at the fuse or circuit breaker panel.
 - d) Do not use the cavity for storage purposes. Do not leave paper products, cooking utensils, or food in the cavity when not in use.
17. Do not use this microwave oven to heat corrosive chemicals (for example, sulfides and chlorides). Vapours from such corrosive chemicals may interact with the contact and springs of the safety interlock switches thereby rendering them inoperable.
18. Keep the waveguide cover clean at all times. Wipe the oven interior with a soft damp cloth after each use. If you leave grease or fat anywhere in the cavity it may overheat, smoke or even catch fire when next using the oven.
19. Never heat oil or fat for deep frying as you cannot control the temperature and doing so may lead to overheating and fire.
20. Liquids, such as water, coffee, or tea are able to be overheated beyond the boiling point without appearing to be boiling due to surface tension of the liquid. Visible bubbling or boiling when the container is removed from the microwave oven is not always present. **THIS COULD RESULT IN VERY HOT LIQUIDS SUDDENLY BOILING OVER WHEN A SPOON OR OTHER UTENSIL IS INSERTED INTO THE LIQUID.** To reduce the risk of injury to persons:
 - ① Do not overheat the liquid.
 - ② Stir the liquid both before and halfway through heating it
 - ③ Do not use straight-sided containers with narrow necks.
 - ④ After heating, allow the container to stand in the microwave oven for a short time before removing the container.
 - ⑤ Use extreme care when inserting a spoon or other utensil into the container.

SAVE THESE INSTRUCTIONS

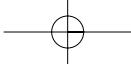
**1 Steady, flat location**

This oven should be set on a steady, flat surface. This oven is designed for counter top use only.

2 Leave space behind and side

All air vents should be kept a clearance. If all vents are covered during operation, the oven may overheat and, eventually, oven failure.

3 Away from radio and TV sets

Poor television reception and radio interference may result if the oven is located close to a TV, Radio antenna and feeder and so on. Position the oven as far from them as possible.

4 Away from heating appliance and water taps

Keep the oven away from hot air, steam or splash when choosing a place to position it, or the insulation might be adversely affected and breakdowns occur.

5 Power supply

This microwave oven requires a power supply of approximately 20 Amperes, 208/230 Volts, 60 Hz and a grounded outlet. (KOM-9FOCTX)

This microwave oven requires a power supply of approximately 20 Amperes, 120 Volts, 60 Hz and a grounded outlet. (KOM-9FOCDA)

A short power cord is provided to reduce the risk of the user becoming entangled in or tripping over a longer cord. Longer cord sets or extension cords are available and may be used if care is exercised in their use. If an extension cord is used, the marked electrical rating of the cord should be at least as great as the electrical rating of the oven.

The Extension cord must be a grounding-type 3-wire cord. The longer cord should be arranged so that it will not drape over the counter top or tabletop where it can be pulled on by children or tripped over unintentionally.

6 Examine the oven after unpacking for any damage such as:

A misaligned door, Broken door, A dent in cavity. If any of the above are visible, DO NOT INSTALL, and notify dealer immediately.

7 Do not operate the oven if it is colder than room temperature.

(This may occur during delivery in cold weather.) Allow the oven to become room temperature before operating.

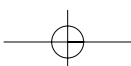
8 Keep free space above the top surface of the oven.

9. When you stack your microwave ovens.

- 1) Place one microwave oven on top of the other one, and remove the plate which are each secured by a single screw to the bottom-right corner at the rear of both microwaves. Secure the above hole of the two microwaves.
- 2) Remove the two screws which are securing at both end of the cabinet of the lower microwave oven.
Remove the two screws which is securing the bottom corner of the upper microwave oven.
- 3) Use the upper and lower plate screw holes to secure the upper and lower microwave ovens with the four screws.
- 4) Ensure the top oven is at a safe and workable height.

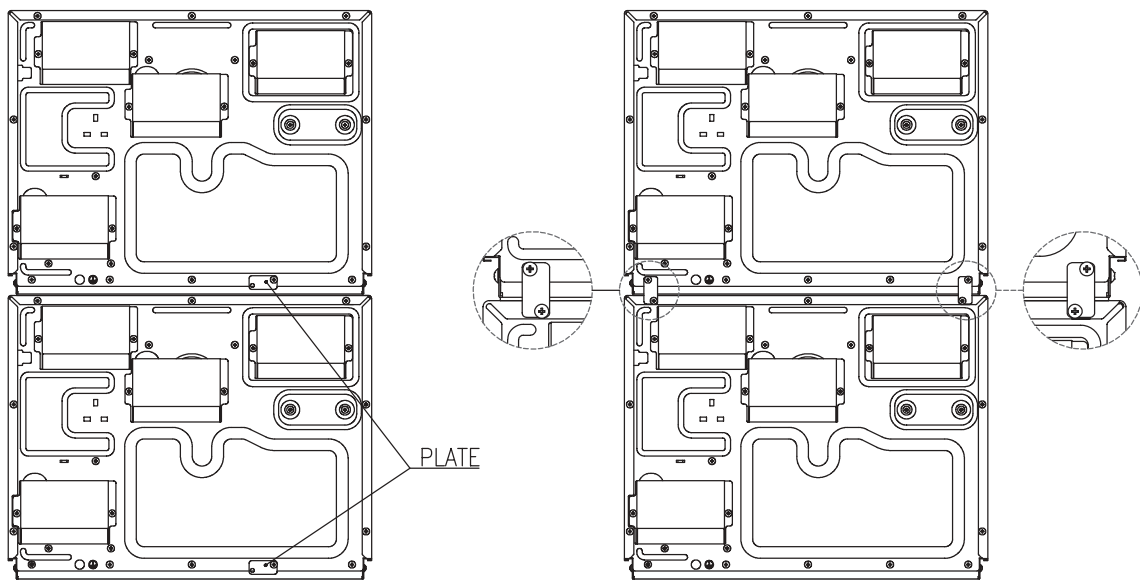

FEDERAL COMMUNICATIONS COMMISSION RADIO FREQUENCY INTERFERENCE STATEMENT

WARNING:

This equipment generates and uses ISM frequency energy and if not installed and used properly, that is in strict accordance with the manufacturer's instructions, may cause interference to radio and television reception.

It has been type-tested and found to comply with limits for an ISM Equipment pursuant to part 18 of FCC Rules, which are designed to provide reasonable protection against such interference in a residential installation.

However, there is no guarantee that interference will not occur in a particular installation.

If this equipment does cause interference to radio or television reception, which can be determined by turning the equipment off and on, the user is encouraged to try to correct the interference by one or more of the followings.

- Reorient the receiving antenna of radio or television.
- Relocate the Microwave oven with respect to the receiver.
- Move the microwave oven away from the receiver.
- Plug the microwave oven into a different outlet so that microwave oven and receiver are on different branch circuits.

THE MANUFACTURER is not responsible for any radio or TV interference caused by UNAUTHORIZED MODIFICATION to this microwave oven. It is the responsibility of the user to correct such interference.

GROUNDING INSTRUCTIONS

This appliance must be grounded. In the event of an electrical short circuit, the grounding plug reduces the risk of electric shock by providing an escape wire for electric current. This appliance is equipped with a cord having a grounding wire with a grounding plug. The plug must be plugged into an outlet that is properly installed and grounded.

WARNING:

Improper use of the grounding can result in a risk of electric shock.

Consult a qualified electrician or serviceman if the grounding instructions are not completely understood, or if doubt exists as to whether the appliance is properly grounded.

- Do not use an extension cord, if the power supply cord is too short, have a qualified electrician or serviceman install a three slot receptacle. This oven should be plugged into a separate 60 hertz circuit with the electrical rating. When a microwave oven is on a circuit with other equipment, an increase in cooking times may be required and fuses can be blown.

WARNING:

Do not cut or remove the third (ground) prong from the power cord under any circumstances.

SPECIFICATIONS

MODEL		KOM-9FOCTX	KOM-9FOCDA
POWER SUPPLY		208/230V, 20A SINGLE PHASE WITH GROUNDING 60Hz, AC	120V, 20A SINGLE PHASE WITH GROUNDING 60Hz, AC
MICROWAVE	POWER CONSUMPTION	3100W	2100W
	OUTPUT POWER	1800W	1200W
	FREQUENCY	2450Mhz	2450Mhz
OUTSIDE DIMENSIONS (W X H X D)		465 X 370 X 595 mm (18.31 X 14.57 X 23.43 in.)	
CAVITY DIMENSIONS (W X H X D)		371 X 198.5 X 372 mm (14.61 X 7.81 X 14.66 in.)	
CAVITY VOLUME		0.9 cu.ft	
NET. WEIGHT		APPROX. 34kg(74.96lbs)	APPROX. 29.5kg(65.04lbs)
TIMER		60 min.	
POWER SELECTIONS		5 LEVELS	

* Specifications are subject to change without notice.

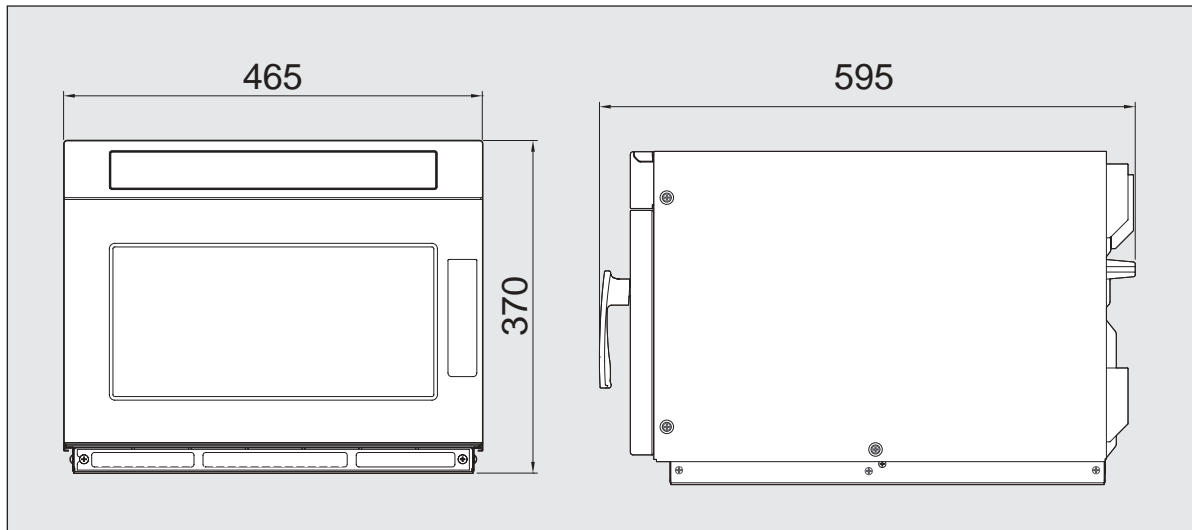

FEATURES DIAGRAM

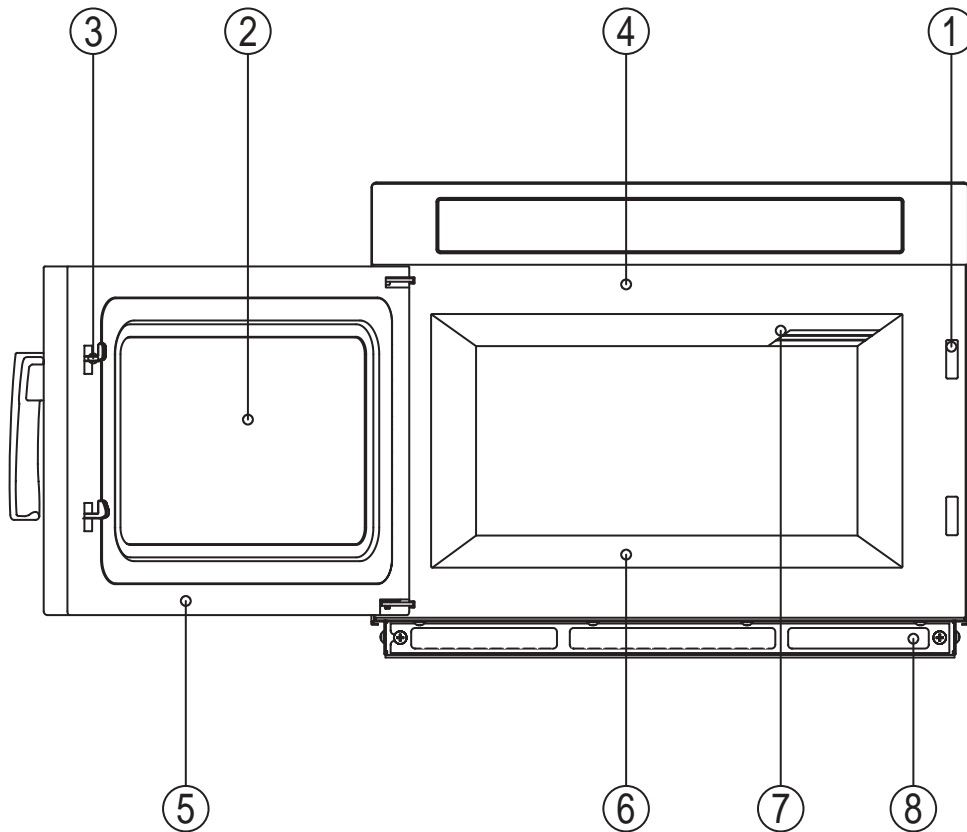

① **Safety Interlock System.**

② **Door Viewing Screen** - Allows viewing of food. The screen is designed so that light can pass through, but not the microwave.

③ **Door Hook** - When door is closed, it will automatically shut off. If the door is opened while the oven is operating, magnetron will immediately stop operating.

④ **Oven Cavity.**

⑤ **Door Seal** - Door seal maintains the microwave energy within the oven cavity and prevents microwave leakage.

⑥ **Plate Tray** - Made of special heat resistant material. Food in a proper receptacle is placed on this plate for cooking.

⑦ **Ceiling Cover** - This is located on top side of the oven.

⑧ **Air Filter**

FEATURES DIAGRAM (continued)

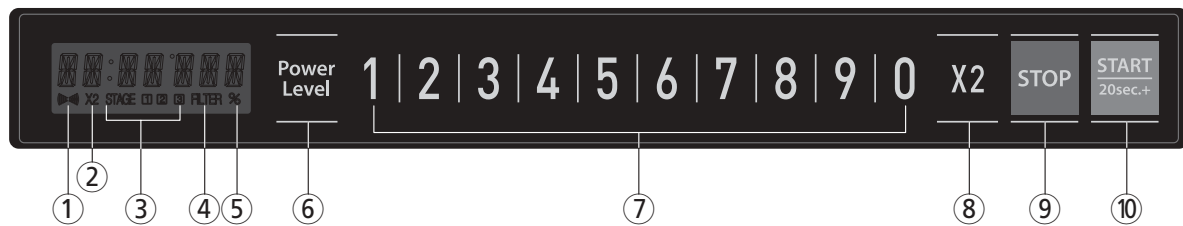

① MICROWAVE indicator

It will turn on when the magnetron output actually is on.

② Double Quantity indicator

It will turn on when DOUBLE QUANTITY pad is pressed.

③ STAGE indicator

It will blink the ongoing stage number of its all cooking stages.

④ CLEAN FILTER indicator

It will turn on during clean filter message displaying.

⑤ POWER LEVEL indicator

It will turn on when POWER LEVEL pad is pressed except full power.

⑥ POWER LEVEL pad

POWER LEVEL pad is used to set a variable power level.

⑦ Number pads

Number pads are used to set the manual cooking time.
It is also used to start preprogrammed cooking cycle.

⑧ DOUBLE QUANTITY pad

X2 pad increases a preprogrammed cooking time by a percentage of the original cooking time.

The user specifies the percentage and it can be changed for individual cooking sequences.

This feature is very useful for cooking multiple servings of foods.

⑨ STOP pad

STOP pad stops a cooking sequence in progress, clears out any remaining time, and also ends programming or user option cycle.

When STOP pad is used to end a programming or option change, the changes are discarded.

⑩ START/ 20sec.+ pad

START pad is used to begin a manual cooking cycle.

It is also used to save any changes to programming sequences or user options. START pad can be used as speedy cooking pad.

In ready mode, 20sec.+ pad allows you to reheat for 20 seconds at full power by pressing it.

By repeatedly touching 20sec.+ pad, you can also extend reheating time to 5 minutes by 20 second increments.

OPERATION PROCEDURE

This section includes useful information about oven operation.

1. Plug power supply cord into a standard 208/230V AC 60Hz power outlet.
 2. After placing the food in a suitable container, open the oven door and put it in the oven.
 3. Shut the door. Make sure that it is firmly closed.
- 1** The oven light is on when the microwave oven is operating or the door is opened.
 - 2** The oven door can be opened at any time during operation by opening the door. The oven will automatically stop working.
 - 3** Each time a pad is touched, a BEEP will sound to acknowledge the touch.
 - 4** The oven automatically cooks at full power unless set to a lower power level.
 - 5** All segments of the display will turn on when the oven of which door is closed is just plugged in at first.
 - 6** When the oven is just plugged in at first or the display is turned off, key pads does not be activated. After oven door is opened and closed once, the oven is ready to work showing "HELLO" in the display.
 - 7** When STOP pad is touched during the oven operation, the oven stops cooking and all information retained.
To erase all information, touch STOP pad once more. If the oven door is opened during the oven operation, all information is retained.
 - 8** If START pad is touched and the oven does not operate, check the area between the door and door seal for obstructions and make sure the door is closed securely.
The oven will not start cooking until the door is completely closed or the program has been reset.

Make sure the oven is properly installed and plugged into the electrical outlet.

WATTAGE OUTPUT CHART

- A power level is selected by touching the POWER LEVEL pad. The chart shows the display, the power level and the percentage of power.

POWER LEVEL pad.	Power Level (Display)	Approximate Percentage of Power
once	HI	100%
twice	70%	70%
3 times	50%	50%
4 times	20%	20%
5 times	00%	0%

NOTE

THE FOOD HAVE TO BE ON AVAILABLE PLATE IN THE OVEN

CONTROLS

Manual Cooking

To cook food manually using a specific entered cook time and power level.



1. Open the door and put food in the oven. Close the door.
 - "HELLO" will show in the display.
2. Press POWER LEVEL pad.
 - If "HI" shows in the display, the power level is adjusted to full power.
 - The % indicator will light if a lower power level is adjusted.
 - You can change a power level to adjust desired setting by pressing POWER LEVEL pad repeatedly.
3. Press number pads for entering the cooking time.
 - You can enter the maximum cooking time up to 60 minutes or 10 minutes.
 - To change maximum cooking time option, see User Options section in this manual.
4. If stage cooking is desired, repeat step 2 and 3.
 - Display changes to cook time and power level for the next stage.
 - Up to three different stages can be programmed.
5. Press START pad.
 - The oven lamp will turn on and heating will start.
 - The first STAGE indicator will start to blink and heating time will count down.

NOTE

Repeat Feature : The user can repeat exactly the same MANUAL COOKING by pressing only START pad, if you use the oven again within keypad activating time. After a MANUAL COOKING is ended, opening and closing the door will make the display show the same cook time and power level setting of the previous MANUAL COOKING. See User Options section in this manual.

NOTE

The cooling fan may automatically run for a while to cool the oven down after working.

Preprogrammed Pads

To cook food using number pads preprogrammed with cooking sequences.

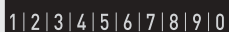

1. Open the door and put food in the oven. Close the door.
 - "HELLO" will show in the display.
2. Press a desired number pad.
 - For single digit entry, press only one number pad.
 - For multiple digit entry, press from one to three pads one by one.
 - To change single or multiple digit entry option, see User Options section in this manual.

NOTE

You can enter the number of a programmed cook from 0 to 9 by pressing only one number pad in single digit entry mode.
You can enter the number of a programmed cook from 0 to 199 by pressing from one to three number pads one by one in multiple digit entry mode.

NOTE

On-the-fly Feature : The user may start another preprogrammed cook while the oven is cooking. While the oven is cooking in On-the-fly Feature mode, pressing number pads will stop the current cooking sequence and then start that preprogrammed cook. See User Options section in this manual.

3. Oven begins to cook.
 - The oven lamp will turn on and heating will start.
 - The first STAGE indicator will start to blink and heating time will count down.

■ Factory Setting

Pad	Cooking time	Power Level
1	10 sec.	100%
2	20 sec.	100%
3	30 sec.	100%
4	45 sec.	100%
5	1 min.	100%
6	1 min. 30 sec.	100%
7	2 min.	100%
8	3 min.	100%
9	4 min.	100%
0	5 min.	100%

NOTE

The cooling fan may automatically run for a while to cool the oven down after working.

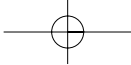

Double Quantity

To increase cooking time when cooking more than one serving.



1. Open the door and put food in the oven. Close the door.
 - "HELLO" will show in the display.
2. Press X2 pad.
 - Amount of time added is a percentage of the original preprogrammed cooking time.
 - The percentage can be changed.
See Programming Cook Factor section in this manual.
3. Press desired preprogrammed pad.
4. Oven begins to cook.
 - The oven lamp will turn on and heating will start.
 - The first STAGE indicator will start to blink and heating time will count down.

NOTE

The cooling fan may automatically run for a while to cool the oven down after working.

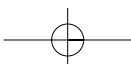

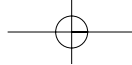

Programming Pads

To change the amount of time or the power level for a preprogrammed pad.

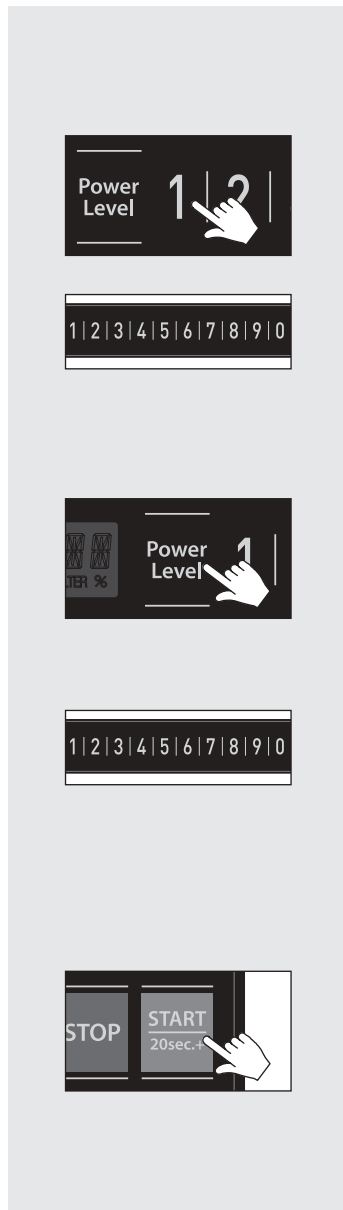

1. Open the door.
 - Display turns off.
2. Press and hold number 1 pad for a while.
 - When the oven enters Programming mode, it will show "PROGRAM" in the display.
3. Press number pads to be programmed.
 - It will show a program number in the display.
 - For single digit entry, press only one number pad.
 - For multiple digit entry, press from one to three pads one by one.
4. Press POWER LEVEL pad to select a desired power level.
 - If "HI" shows in the display, the power level is adjusted to full power.
 - The % indicator will light if a lower power level is adjusted.
 - You can change a power level to adjust desired setting by pressing POWER LEVEL pad repeatedly.
5. Enter desired cooking time by using number pads.
6. If stage cooking is desired, repeat step 4 and 5.
 - Display changes to cook time and power level for the next stage.
 - Up to three different stages can be programmed.
7. Press START pad to save the program changes.
 - To discard changes, press STOP pad.

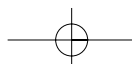

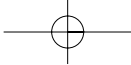

Programming Cook Factor

To change cook factor for a preset pad.



1. Open the door.
 - Display turns off.
2. Press and hold number 1 pad for a while.
 - When the oven enters Programming mode, it will show "PROGRAM" in the display.
3. Press number pads to be programmed.
 - It will show a program number in the display.
 - For single digit entry, press only one number pad.
 - For multiple digit entry, press from one to three pads one by one.
4. Press X2 pad to change a cooking factor.
 - It will show the current cook factor.
 - Factory setting for cook factor is 80%. (CF:80 in the display)
5. Enter desired cook factor by using number pads. (0~9)
 - Number 1 pad for 10% of cook factor through number 0 pad for 100% of cook factor.
6. Press START pad to save the cook factor changes.
 - To discard changes, press STOP pad.

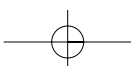

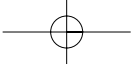

20 sec.+ pad

This function allows you to reheat for 20 seconds at full power by simply touching the 20 sec.+ pad. By repeatedly touching 20 sec.+ pad, you can also extend reheating time to 5 minutes by 20 second increments.

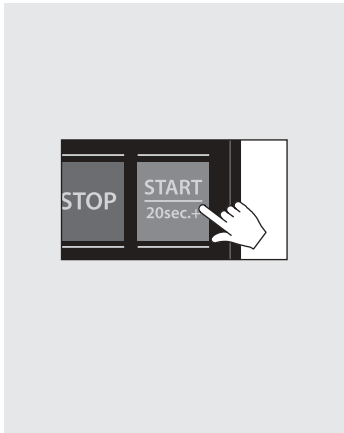

1. Open the door and put food in the oven. Close the door.
 - "HELLO" will show in the display.
2. Press 20 sec.+ pad.
 - When you press 20 sec.+ pad, " :20" shows in the display.
 - The oven will start immediately. It will add 20 seconds to the time counting down each time the pad is pressed.

NOTE

The cooling fan may automatically run for a while to cool the oven down after working.

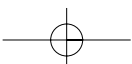
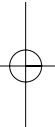
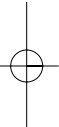

Changing User Options

User Options can be changed to suit individual preferences.

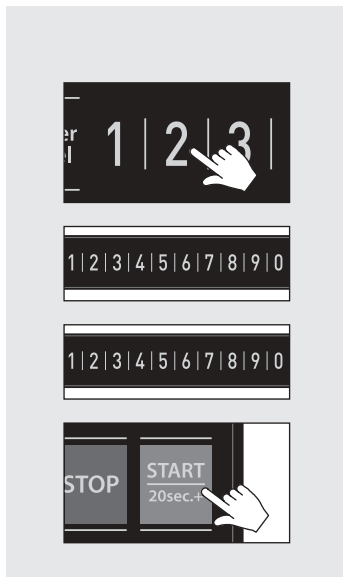

1. Open the door.
 - Display turns off.
2. Press and hold number 2 pad for a while.
 - When the oven enters Option mode, it will show "OP:--" in the display.
3. Press a number pad to be programmed. (0~9)
 - It will show an option number in the display.
4. Press the number pad again to change the option.
 - Each time the number pad is pressed, option will change.
5. Press START pad to save changes.
 - To change additional options, repeat steps 3 and 4.

Pads	Display	User Options (Factory Settings in Bold)
1 Cook Ending Signal	OP:10 OP:11 OP:12 OP:13 OP:14	3 long beeps for 3 seconds 1 short, 1 long beeps for 3 seconds 3 second beep 3 quick beeps for 3 seconds 5 quick beeps for 3 seconds
2 Repeat Feature	OP:20 OP:21	Repeat feature not allowed Repeat feature allowed
3 Key Beep On/Off	OP:30 OP:31	Prevents beep when a pad is pressed. Allows beep when a pad is pressed.
4 Keypad Activating Time	OP:40 OP:41 OP:42 OP:43	Keypad time entry window is 1 minute. Keypad time entry window is 2 minutes. Keypad time entry window is 3 minutes. Keypad time entry window is 4 minutes.
5 On-the-fly Feature	OP:50 OP:51	On-the-fly disabled On-the-fly enabled
6 Reset on Door open	OP:60 OP:61	Opening oven door does not reset oven back to ready. Opening oven door resets the oven back to ready mode.
7 Maximum Cooking Time	OP:70 OP:71	Allows 60 minute maximum cooking time. Allows 10 minute maximum cooking time.
8 Manual Programming	OP:80 OP:81	Manual cooking not allowed. Manual cooking allowed.
9 Multiple Digit Entry	OP:90 OP:91	Single digit entry allows 10 preprogrammed pads. (0~9) Multiple digit entry allows 200 preprogrammed pads. (0~199)
0 Clean Filter Message	OP:00 OP:01 OP:02 OP:03	Oven will not display clean filter message. Oven will display clean filter message every 7 days. Oven will display Clean Filter message every 30 days. Oven will display Clean Filter message every 90 days.

COOKING INSTRUCTIONS

Utensil Guide

Only use utensils that are suitable for use in microwave ovens.

To cook food in the microwave oven, the microwaves must be able to penetrate the food, without being reflected or absorbed by the dish used. Care must therefore be taken choosing the utensil. If the utensil is marked microwave-safe, you do not need to worry. The following table lists various of utensil and indicates whether and how they should be used in a microwave oven.

Utensil	Safe	Comments
Aluminum foil	▲	Can be used in small quantities to protect areas against overcooking. Arcing can occur if the foil is too close to the oven wall or if too much foil is used.
Crust plate	●	Do not preheat for more than 8minutes.
China and earthenware	●	Porcelain, pottery, glazed earthenware and bone china are usually suitable, unless deco-rated with a metal trim.
Disposable polyester cardboard dishes	●	Some frozen foods are packaged in these dishes.
Fast-food packaging • Polystyrene cups containers • Paper bags or newspaper • Recycled paper or metal trims	● × ×	Can be used to warm food. Overheating may cause the polystyrene to melt. May catch fire. May cause arcing.
Glassware • Oven-to-table ware • Fine glassware • Glass jars	● ● ●	Can be used, unless decorated with a metal trim. Can be used to warm foods or liquids. Delicate glass may break or crack if heated suddenly. Must remove the lid. Suitable for warming only.
Metal • Dishes • Freezer bag twist ties	× ×	May cause arcing or fire.
Paper • Plates, cups, napkins and Kitchen paper • Recycled paper	● ×	For short cooking times and warming. Also to absorb excess moisture. May cause arcing.
Plastic • Containers • Cling film • Freezer bags	● ● ▲	Particularly if heat-resistant thermoplastic. Some other plastics may warp or discolour at high temperatures. Do not use Melamine plastic. Can be used to retain moisture. Should not touch the food. Take care when removing the film as hot steam will escape. Only if boilable or oven-proof. Should not be airtight. Prick with a fork, if necessary.
Wax or grease-proof paper	●	Can be used to retain moisture and prevent spattering.

● : Recommended use

▲ : Limited Use

× : Not Recommended

MICROWAVING PRINCIPLES

Microwave energy has been used in this country to cook and reheat food since early experiments with RADAR in World War II. Microwaves are present in the atmosphere all the time, both naturally and manmade sources. Manmade sources include radar, radio, television, telecommunication links and car phones.

HOW MICROWAVES COOK FOOD

Microwave oven is a Group 2 ISM equipment in which radiofrequency energy is intentionally generated and used in the form of electromagnetic radiation for the treatment of material. This oven is a Class B equipment suitable for use in domestic establishments and in establishments directly connected to a low voltage power supply network which supplies buildings used for domestic purposes.

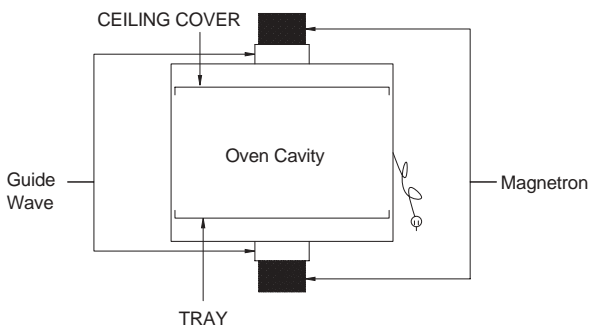

In a microwave oven, electricity is converted into microwave by the MAGNETRON.

► REFLECTION

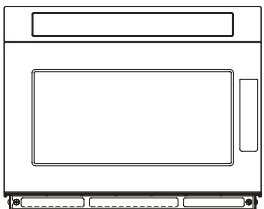

The microwaves bounce off the metal walls and the metal door screen.

► TRANSMISSION

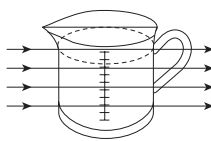

Then they pass through the cooking containers to be absorbed by the water molecules in the food, all foods contain water to a more or lesser extent.

► ABSORPTION

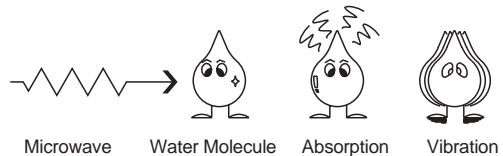

The microwaves cause the water molecules to vibrate which causes FRICTION, i.e. HEAT. This heat then cooks the food. Microwaves are also attracted to fat and sugar particles, and foods high in these will cook more quickly. Microwaves can only penetrate to a depth of 1½ - 2 inches(4-5cm) and as heat spreads through the food by conduction, just as in a traditional oven, the food cooks from the outside inwards.

CONVERSION CHARTS

WEIGHT MEASURES	
15 g	1/2 oz.
25 g	1 oz.
50 g	2 oz.
100 g	4 oz.
175 g	6 oz.
225 g	8 oz.
450 g	1 lb.

VOLUME MEASURES	
30 ml	1 fl.oz.
100 ml	3 fl.oz.
150 ml	5 fl.oz. (1/4 pt)
300 ml	10 fl.oz. (1/2 pt)
600 ml	20 fl.oz. (1pt)

SPOON MEASURES	
1.25 ml	1/4 tsp
2.5 ml	1/2 tsp
5 ml	1 tsp
15 ml	1 tbsp

FLUID MEASUREMENTS		
1 Cup	= 8 fl.oz.	= 240 ml
1 Pint	= 16 fl.oz. (UK 20 fl.oz.)	= 480 ml (UK 560 ml)
1 Quart	= 32 fl.oz. (UK 40 fl.oz.)	= 960 ml (UK 1120 ml)
1 Gallon	= 128 fl.oz. (UK 160 fl.oz.)	= 3840 ml (UK 4500 ml)

COOKING TECHNIQUES

STANDING TIME

Dense foods e.g. meat, jacket potatoes and cakes, require standing time (inside or outside of the oven) after cooking, to allow heat to finish conducting to cook the center completely. Wrap meat joints and jacket potatoes in aluminum foil while standing. Meat joints need approx. 10-15 minutes, jacket potatoes 5 minutes. Other foods such as plated meal, vegetables, fish etc. require 2-5 minutes standing. After defrosting food, standing time should also be allowed. If food is not cooked after standing time, return to the oven and cook for additional time.

MOISTURE CONTENT

Many fresh foods e.g. vegetables and fruit, vary in their moisture content throughout the season, particularly jacket potatoes. For this reason cooking times may have to be adjusted. Dry ingredients e.g. rice, pasta, can dry out during storage so cooking times may differ.

DENSITY

Porous airy foods heat more quickly than dense heavy foods.

CLING FILM

Cling film helps keep the food moist and the trapped steam assists in speeding up cooking times. Pierce before cooking to allow excess steam to escape. Always take care when removing cling film from a dish as the build-up of steam will be very hot.

SHAPE

Even shapes cook evenly. Food cooks better by microwave when in a round container rather than square.

SPACING

Foods cook more quickly and evenly if spaced apart. NEVER pile foods on top of each other.

STARTING TEMPERATURE

The colder the food, the longer it takes to heat up. Food from a fridge takes longer to reheat than food at room temperature.

LIQUIDS

All liquids must be stirred before and during heating. Water especially must be stirred before and during heating, to avoid eruption. Do not heat liquids that have previously been boiled. DO NOT OVERHEAT.

TURNING & STIRRING

Some foods require stirring during cooking. Meat and poultry should be turned after half the cooking time.

ARRANGING

Individual foods e.g. chicken portions or chops, should be placed on a dish so that the thicker parts are towards the outside.

QUANTITY

Small quantities cook faster than large quantities, also small meals will reheat more quickly than large portions.

PIERCING

The skin or membrane on some foods will cause steam to build up during cooking. These foods must be pierced or a strip of skin should be peeled off before cooking to allow the steam to escape. Eggs, potatoes, apples, sausages etc, will all need to be pierced before cooking. DO NOT ATTEMPT TO BOIL EGGS IN THEIR SHELLS.

COVERING

Cover foods with microwave cling film or a lid. Cover fish, vegetables, casseroles, soups. Do not cover cakes, sauces, jacket potatoes or pastry items.

DEFROSTING GUIDE

GENERAL INFORMATION

- ⇨ Put the food on a microwave rack (roasts, bone-in pieces) or in a microwave casserole (small pieces such as cubes or strips) or weigh at home on a kitchen scale. Round number to the nearest tenth of a pound and choose that number with each item pads.
- ⇨ The shape of food items, especially larger ones, will vary affect the way defrost. Always check the status after the standing time. Fish, seafood and poultry should still be somewhat icy in the center the held under cold running water to finish defrosting. If more time is needed, use DEFROST by time to add time in small increments.
- ⇨ Halfway through the defrosting process, a series of beeps will indicate that it is time to change the position of the item being defrosted. The includes turning over or rotating the item, separating defrosted pieces or sections, or shielding.
- ⇨ Shielding means to use a 2-inch strip of aluminum foil to protect thinner or unevenly shaped part from beginning to cook. Microwave energy will not penetrate the foil. Some rules apply to the use of foil:
Do not let the foil pieces touch each other or the sides of the microwave oven.
Be sure that all ends are touched under and lie flat to the food.
Remember to adjust foil when an item is turned over and cover with wax paper.
- ⇨ To prepare food for freezer storage(and later defrosting), wrap tightly in moisture proof packaging. If using freezer plastic bags, be sure to let all the air out to prevent freezer bump on the food. Package so that food is as evenly shaped as possible ease in defrosting.

DEFROST AND COOKING CHART

The times given in the following charts are a guideline only.

Many factors e.g. starting temperature of the food can affect the final heating time required. The cooking and defrosting times must be adjusted when necessary.

All times are tested using foods at starting temperatures as below ;

chills foods ----- approx. +5°C

frozen foods ----- approx. -20°C

Always check for the correct core temperature with a temperature probe to comply with current Government food Hygiene Regulations.

Food	Weight	Power Level /Approx. Time		Instructions
		1800W	1400W	
Minced Beef	500 g	20% / 5 min	20% / 7 min	<ol style="list-style-type: none"> 1. Place on a plate or in flan dish. 2. Turn over 2-3 times during defrosting, removing defrosted mince each time. 3. After defrosting, cover any frozen mince remaining with aluminum foil for 15-20 minutes or until thoroughly defrosted.
Whole chicken	1.36 kg	20% / 25 min	20% / 32 min	<ol style="list-style-type: none"> 1. Place on large plate. 2. Turn over 2-3 times during defrosting. NOTE: If necessary, small pieces of aluminum foil can be used to shield small areas of meat which may become warm during defrosting. 3. After defrosting, wrap in foil and leave to stand for 1-2 hours or until thoroughly defrosted.
Bread Sliced	800g (1¾ lb) loaf	20% / 4-5 mins	20% / 4-6 mins	<ol style="list-style-type: none"> 1. Arrange and separate slices on the dish. 2. Turn over, separate and re-arrange twice during defrosting. Remove defrosted slices each time. 3. After defrosting , cover with foil for 5-10 minutes or until thoroughly defrosted.
Rice (cooked)	450 g	20% / 5-6 mins	20% / 6-8 mins	<ol style="list-style-type: none"> 1. Place in a large bowl. 2. Break up during defrosting, removing defrosted rice each time. 3. After defrosting, cover any frozen rice remaining with foil and leave to stand for 10-15 minutes or until thoroughly defrosted.
Apple Pie	1 portion	20% / 1min 20sec	20% / 1min 50sec	<ol style="list-style-type: none"> 1. Place on plate, uncovered.
Gateau	1 portion	20% / 2 min	20% / 2 min 30sec	<ol style="list-style-type: none"> 1. Place on paper towel, uncovered.
Sausages (uncooked) - thick	450g(1lb)	20% / 6-7 mins	20% / 9-10 mins	<ol style="list-style-type: none"> 1. Place on a large plate, in a single layer if possible.
- thin	450g(1lb)	20% / 4-5 mins	20% / 6-7 mins	<ol style="list-style-type: none"> 2. Turn over 2-3 times during defrosting and separate if necessary. 3. After defrosting, cover with aluminum foil and leave to stand for 15-20 minutes or until thoroughly defrosted.

Food	Weight	Power Level /Approx. Time		Instructions
		1800W	1400W	
Jacket Potatoes	2 potatoes (290g(10oz) / 1ea.)	100% / 5-6 mins	100% / 7-8 mins	1. Pierce each potato in several places. 2. Place on the edge of the plate. 3. Stand for 3-4 minutes before serving.
Broccoli - Fresh:	225g(8oz)	100% / 2 mins	100% / 3 mins	1. Place in a dish, add 30ml (2tbsp) water. 2. Cover with microwave cling film and pierce in 4-5 places. 3. Stir halfway through cooking. 4. Stand for 1-2 minutes before serving.
- Frozen:	225g(8oz)	100% / 3 mins	100% / 4 mins	
Carrots(sliced,baby,whole)				
- Fresh:	225g(8oz)	100% / 2 mins	100% / 4 mins	As above
- Frozen:	225g(8oz)	100% / 3 mins	100% / 4 mins	
Cauliflower - Fresh:	225g(8oz)	100% / 2 mins	100% / 3-4 mins	As above
- Frozen:	225g(8oz)	100% / 3 mins	100% / 4 mins	
Peas - Fresh:	225g(8oz)	100% / 1-2 mins	100% / 2-3 mins	1. Place in a dish, add 30ml (2tbsp) water. 2. Cover with microwave cling film and pierce in 4-5 places. 3. Stir halfway through cooking. 4. Leave to stand for 1-2 minutes before serving.
- Frozen:	225g(8oz)	100% / 2-3 mins	100% / 3-4mins	
Hamburger (chilled)	125g (5oz)	100% / 40 sec	100% / 50 sec	1. Place in a plate, uncovered.
Cheeseburger (Chilled)	175g(6oz)	100% / 40 sec	100% / 50 sec	As above
Tomatoes (room temp.)	400g (14oz)	100% / 2mins 30sec	100% / 3 mins	1. Place in a bowl, cover with cling film, stir halfway through cooking.
Asparagus (room temp.)	350g (12oz)	100% / 1min 40sec	100% / 2min 10sec	As above
Apple Pie	1 portion	100% / 15 sec	100% / 20 sec	1. Place on plate, uncovered.

CARE OF YOUR MICROWAVE OVEN

- 1 Turn the oven off before cleaning.
- 2 Keep the inside of the oven clean. When food spatters or spilled liquids adhere to **oven walls**, wipe with a damp cloth. Mild detergent may be used if the oven gets very dirty. The use of harsh detergent or abrasives is not recommended.
- 3 The outside oven surface should be cleaned with soap and water, rinsed and dried with a soft cloth. To prevent damage to the operating parts inside the oven, water should not be allowed to seep into the ventilation openings.
- 4 If the Control Panel becomes wet, clean with a soft, dry cloth. Do not use harsh detergents or abrasives on Control Panel.
- 5 If steam accumulates inside or around the outside of the oven door, wipe with a soft cloth. This may occur when the microwave oven is operated under high humidity conditions and in no way indicates malfunction of the unit.
- 6 Oven cavity floor should be cleaned regularly to avoid excessive noise. Simply wipe the bottom surface of the oven with mild detergent water or window cleaner and dry.

CLEANING AND MAINTENANCE

Although your oven is provided with safety features, it is important to observe the following:

1. It is important not to defeat or tamper with safety interlocks.
2. Do not place any object between the oven front face and the door or allow residue to accumulate on sealing surfaces. Wipe the sealing area frequently with a mild detergent, rinse and dry. Never use abrasive powders or pads.
3. When opened, the door must not be subjected to strain, for example, a child hanging on an opened door or any load could cause the oven to fall forward to cause injury and also damage to the door. Do not operate the oven if it is damaged, until it has been repaired by a competent service technician. It is particularly important that the oven closes properly and that there is no damage to the:
 - i) Door(bent)
 - ii) Hinges and Hooks(broken or loosened)
 - iii) Door seals and sealing surfaces.
4. The oven should not be adjusted or repaired by anyone except a properly competent service technician.
5. The oven should be cleaned regularly and any food deposits removed;
6. Failure to maintain the oven in a clean condition could lead to deterioration of the surface that could adversely affect the life of the appliance and possibly result in a hazardous situation.

NOTE: The appliance should not be cleaned with a water jet.

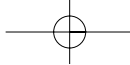

CLEANING THE CEILING COVER

1. Push left side of stopper in center of ceiling cover and separate it from cavity.
2. Hold side stoppers of ceiling cover with both hands and pull down. Then take off the Ceiling Cover out of the oven cavity
3. Wash this Ceiling Cover in soapy water or Food Sanitizer Solution.
4. Be sure to replace the Ceiling Cover before using the oven.

Note Ceiling Cover must be placed securely when you use the oven.
When you remove the Ceiling Cover for the purpose of cleaning, be sure to be extremely careful about the exposed inside components on the top of the oven cavity.
If any of them are deformed, abnormal symptom can happen such as arcing or sparks during operation.
In case of such problem, contact the nearest service center.

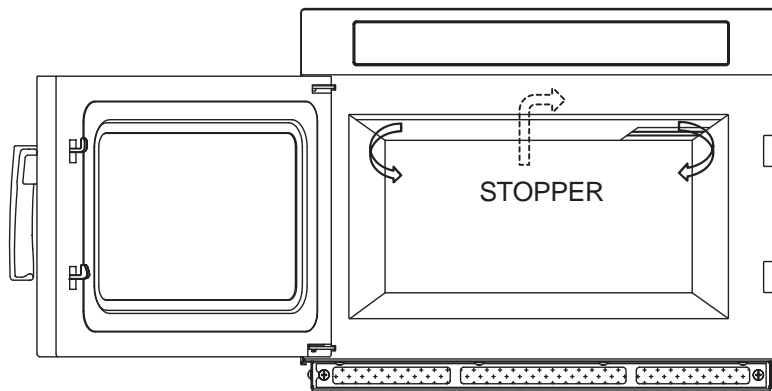

CLEANING THE AIR FILTER

Clean the Air Filter regularly according to the following instructions.

1. Remove the bolt at both ends of Air Filter.
2. Take the Air Filter off carefully.
3. Wash the Air Filter in warm soapy water.
4. Be sure to replace the Air Filter before using the oven.

Note If the Air Filter becomes clogged with debris, this will cause problem on the oven.
If you want to change the air filter clean time, refer to "clean filter message" in page 16.

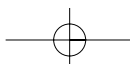
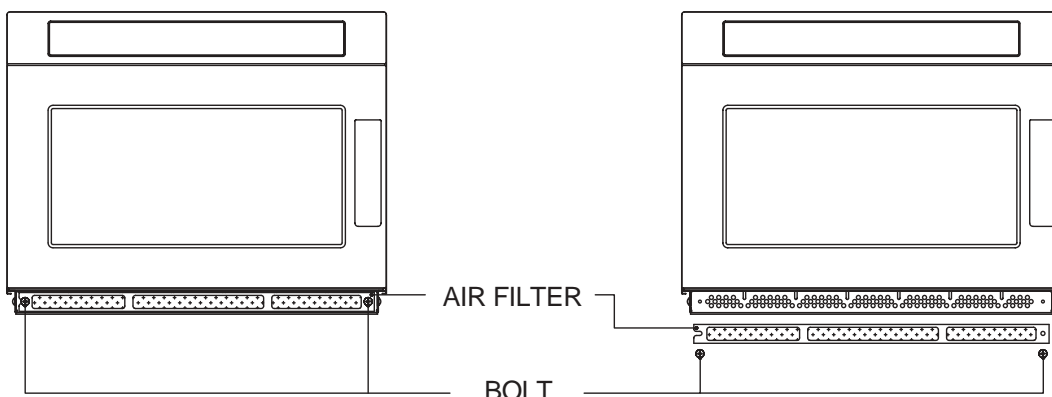

USE YOUR MICROWAVE OVEN SAFELY

General Use

Do not attempt to defeat or tamper with safety interlocks.

Do not place any object between the oven front frame and the door or allow residue to build up on sealing surfaces. Wipe with a mild detergent, rinse and dry. Never use abrasive powders or pads.

Do not subject the oven door to strain or weight such as a child hanging on an open door.

This could cause the oven to fall forward resulting in injury to you and damage to the oven.

Food

Never use your microwave oven for home canning. The oven is not designed for proper home canning. Improperly canned food may spoil and be dangerous to consume.

Always use the minimum recipe cooking time. It is better to undercook rather than overcook foods.

Undercooked foods can be returned to the oven for more cooking. If food is overcooked, nothing can be done.

Heat small quantities of food or foods with low moisture carefully. These can quickly dry out, burn or catch on fire.

Do not heat eggs in the shell. Pressure may build up and eggs can explode.

Potatoes, apples, egg yolks and sausages are examples of food with non-porous skins.

These must be pierced before cooking to prevent bursting.

Do not attempt to deep fat fry in your microwave oven.

Always allow a standing time of at least 20 seconds

Do not operate the oven if door seals or sealing surfaces are damaged; or if door is bent; or if hinges are loose or broken.

Do not operate the oven empty. This will damage the oven.

Do not attempt to dry clothes, newspapers or other materials in the oven. They may catch on fire.

Do not use recycled paper products as they may contain impurities which may cause sparks or fires.

Do not hit or strike the control panel with hard objects. This can damage the oven.

after the oven has been switched off to allow the temperature to even out, stir during heating, if necessary, and ALWAYS stir after heating. To prevent eruptive boiling and possible scalding, you should put a spoon or glass stick into the beverages and stir before, during and after heating.

Do not leave the oven unattended while popping corn.

Do not pop corn in a paper bag unless it is the commercially prepared Microwave Popcorn product. The kernels can overheat and ignite a brown paper bag.

Do not put packaged Microwave Popcorn bags directly on the oven tray. Place the package on a microwave safe glass or ceramic plate to avoid overheating and cracking the oven tray.

Do not exceed the Microwave Popcorn manufacturers suggested popping time.

Longer popping does not yield more popcorn but it can result in scorch, burn of fire. Remember, the Popcorn bag and tray can be too hot to handle.

Remove with caution and use pot holders.

ARCING

*If you see arcing, touch the **STOP** pad and correct the problem.*

Arcing is the microwave term for sparks in the oven.

Arcing is caused by:

- Metal or foil touching the side of the oven.
- Metal, such as twist-ties, poultry pins, or gold rimmed dishes, in the microwave.
- Foil not molded to food (upturned edges act like antennas).
- Recycled paper towels containing small metal pieces being used in the microwave.

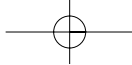

BEFORE YOU CALL FOR SERVICE

Refer to following checklist, you may prevent an unnecessary service call.

- * The oven doesn't work;
 1. Check that the power cord is securely plugged in.
 2. Check that the door firmly closed.
 3. Check that the cooking time is set.
 4. Check for a blown circuit fuse or tripped main circuit breaker in your house.

- * Sparking in the cavity;
 1. Check that utensils are metal containers or dishes with metal trim.
 2. Check that metal skewers touch the interior walls.

If there is still a problem, contact the service station.
A list of these stations is included in the oven.

DO NOT ATTEMPT TO SERVICE THE OVEN YOURSELF!

QUESTIONS AND ANSWERS

- * Q : I accidentally ran my microwave oven without any food in it. Is it damaged?
A : Running the oven empty for a short time will not damage the oven.
However, it is not recommended.

- * Q : Can I open the door when the oven is operating?
A : The door can be opened anytime during the cooking operation. Then microwave energy will be instantly switched off and the time setting will maintain until the door is closed and START is touched.

- * Q : Why do I have moisture in my microwave oven after cooking?
A : The moisture on the side of your microwave oven is normal. It is caused by steam form cooking food heating the cool oven surface.

- * Q : Dose microwave energy pass through the viewing screen in the door?
A : No. The metal screen bounces back the energy to the oven cavity. The holes are made to allow light to pass through. They do not let microwave energy pass through.

- * Q : Why do eggs sometimes pop?
A : When baking or poaching eggs, the yolk may pop due to steam build-up inside the yolk membrane. To prevent this, simply pierce the yolk with a toothpick before cooking. Never cook eggs without piercing their shells.

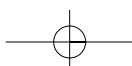

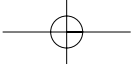

QUESTIONS AND ANSWERS (continued)

* Q : Why is standing time recommended after the cooking operation has been completed?

A : Standing time is very important.

With microwave cooking, the heat is in the food, not in the oven. Many foods build up enough internal heat to allow the cooking process to continue, even after the food is removed from the oven. Standing time for joints of meat, large vegetables and cakes allows the inside to cook completely, without overcooking the outside.

* Q : What does “standing time” mean?

A : “Standing time” means that food should be removed from the oven and covered for additional time to allow it to finish cooking. This frees the oven for other cooking.

* Q : Why does my oven not always cook as fast as the microwave cooking guide says?

A : Check your cooking guide again, to make sure you’ve followed directions exactly ; and to see what might cause variations in cooking time. Cooking guide times and heat settings are suggestions, to help prevent over-cooking... the most common problem in getting used to a microwave oven. Variations in the size, shape and weights and dimensions could require longer cooking time. Use your own judgment along with the cooking guide suggestions to check whether the food has been properly cooked just as you would do with a conventional cooker.

* Q : Will the microwave oven be damaged if it operates while empty?

A : Yes. Never run it empty.

* Q : Can I pop popcorn in my microwave oven? How do I get the best results?

A : Yes. Pop packaged microwave popcorn following manufactures guidelines.

Do not use regular paper bags. Use the “listening test” by stopping the oven as soon as the popping slows to a “pop” every 1 or 2 seconds. Do not repop unpopped kernels. Do not pop popcorn in glass cookware.

DISPOSAL OF USED ELECTRICAL & ELECTRONIC EQUIPMENT



The meaning of the symbol on the product, its accessory or packaging indicates that this product shall not be treated as household waste. Please, dispose of this equipment at your applicable collection point for the recycling of electrical & electronic equipment waste. In the European Union and Other European countries which there are separate collection systems for used electrical and electronic product. By ensuring the correct disposal of this product, you will help prevent potentially hazardous to the environment and to human health, which could otherwise be caused by unsuitable waste handling of this product. The recycling of materials will help conserve natural resources. Please do not therefore dispose of your old electrical and electronic equipment with your household waste. For more detailed information about recycling of this product, please contact your local city office, your household waste disposal service or the shop where you purchased the product.

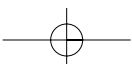

Limited Warranty



DAEWOO ELECTRONICS AMERICA, INC. warrants the following **Microwave** to be free from defective material and workmanship and agrees to remedy any such defect or to furnish a new part (at the Company's option) in exchange for any part of any unit of its manufacture which under normal installation, use and service disclosed such defect, provided the unit is delivered by the owner to store or dealer where purchased or Daewoo authorized service center. To establish and receive warranty service at our store, dealer or our authorized service center, a sales receipt or bill of sales is required for proof of purchase.

This warranty does not extend to any of our electronic products which have been subjected to misuse, neglect, accident, incorrect wiring not our own, improper installation, unauthorized modification or to use in violation of instructions furnished by us, nor units which have been repaired or altered outside of our factory, nor to cases where the serial number thereof has been removed, defaced, or changed.

This warranty is in lieu of all warranties expressed or implied and no representative or person is authorized to assume for us any other liability in connection with the sales of our electronic products.

Over the counter exchange for units that are initially defective. Initial defective is described as when the dealer opens the unit and finds that it is inoperative or an individual customer opening a new unit and finding that it is initially defective. This unit may be returned to the factory by the dealer for exchange. Under no circumstances will an individual customer be permitted to return defective unit directly to factory. Exchange must be directly with the dealer. When this unit is returned to dealer, a copy of the purchase evidence stating the date of purchase is to be put in the individual box for dealer's further control with the factory.

<u>Model</u>	<u>Parts</u>	<u>Labor</u>
KOM-9F0C	1 year	1 year

Note: The warranty service center list is constantly changing with the addition of our current qualified service centers. If there is inadequate or no local service facility subject individual customer will call DAEWOO on the toll free number

1-877-DWESV3(1-877-393-7823) www.e-daewoo.com

to be provided with further information.