

Nemko Korea Co., Ltd.

155, 153 and 159, Osan-ro, Moheyeon-eup, Cheoin-gu, Yongin-si, Gyeonggi-do 16885 Republic of Korea
TEL : + 82 31 330 1700 FAX : + 82 31 322 2332

FCC EVALUATION REPORT FOR CERTIFICATION

Applicant :

Dongbu Daewoo Electronics Corporation
(Cheongcheon-dong), 12, Bupyeongbuk-ro
236 beon-gil, Bupyeong-gu, Incheon,
Korea, Republic of
Attn : Mr. Byung-Seok, Kim

Dates of Issue : August 07, 2018
Test Report No. : NK-18-E-0452
Test Site : Nemko Korea Co., Ltd.
EMC site, Korea

FCC ID

C5F7NF1JMO110N

Trade Mark

DAEWOO, SHARP

Contact Person

Dongbu Daewoo Electronics Corporation
(Cheongcheon-dong), 12, Bupyeongbuk-ro
236 beon-gil, Bupyeong-gu, Incheon, Korea, Republic of
Mr. Byung-Seok, Kim
Telephone No. : + 82 32 510 7919

Applied Standard : FCC Part 18 & Part 2
Classification : Consumer ISM equipment
EUT Type : Microwave Oven

The device bearing the Trade Mark and FCC ID specified above has been shown to comply with the applicable technical standards as indicated in the measurement report and was tested in accordance with the measurement procedures specified in MP-5:1986.

I attest to the accuracy of data and all measurements reported herein were performed by me or were made under my supervision and are correct to the best of my knowledge and belief. I assume full responsibility for the completeness of these measurements and vouch for the qualifications of all persons taking them.

Aug. 07, 2018

Tested By : Taejoo Kim
Engineer

Aug. 07, 2018

Reviewed By : Changsoo Choi
Technical Manager

TABLE OF CONTENTS

SCOPE	3
INTRODUCTION (Site Description)	4
EUT INFORMATION	5
DESCRIPTION OF TESTS (Radiation Hazard)	6
DESCRIPTION OF TESTS (Input Power Measurement)	6
DESCRIPTION OF TESTS (Output Power Measurement)	6
DESCRIPTION OF TESTS (Frequency Measurements)	6
DESCRIPTION OF TESTS (Conducted Emissions)	7
DESCRIPTION OF TESTS (Radiated Emissions)	8
TEST DATA (Radiation Hazard)	9
TEST DATA (Input Power Measurement)	9
TEST DATA (RF Output Power Measurement)	9
TEST DATA (Frequency Measurements)	10
TEST DATA (Conducted Emissions)	12
TEST DATA (Radiated Emissions)	15
PLOT OF EMISSIONS (Frequency Measurements)	22
ACCURACY OF MEASUREMENT	42
LIST OF TEST EQUIPMENT	45
APPENDIX A - SAMPLE LABEL	46
APPENDIX B - PHOTOGRAPHS OF TEST SET-UP	47
APPENDIX C - EUT PHOTOGRAPHS	52
APPENDIX D - SCHEMATIC DIAGRAM	73
APPENDIX E - USER'S MANUAL	74
APPENDIX F - BLOCK DIAGRAM	75

SCOPE

Measurement and determination of electromagnetic emissions (EME) of radio frequency devices including intentional and/or unintentional radiators for compliance with the technical rules and regulations of the Federal Communications Commission under FCC part 18.

Responsible Party : Dongbu Daewoo Electronics Corporation

Contact Person : Mr. Byung-Seok, Kim
Tel No.: + 82 32 510 7919

Manufacturer : Dongbu Daewoo Electronics Corporation
(Cheongcheon-dong), 12, Bupyeongbuk-ro 236 beon-gil,
Bupyeong-gu, Incheon, Korea, Republic of

● FCC ID: C5F7NF1JMO110N

● Model: KOT-1J**

Note ¹⁾ First "*" : The first asterisk "*" can be any alphanumeric character (A-Z or 0-9) to denote enclosure design.

Note ²⁾ Second "*" : The second asterisk "*" can be any alphabet character (A-Z) to denote control type.

SMO1854D*

Note ³⁾ First "*" : The asterisk "*" can be any alphanumeric character (A-Z or 0-9) to denote enclosure design

● Trade Mark: DAEWOO, SHARP

● EUT Type: Microwave Oven

● Applied Standard: FCC Part 18 & Part 2

● Test Procedure(s): MP-5:1986

● Dates of Test: June 27, 2018 to July 25, 2018

● Place of Tests: Nemko Korea Co., Ltd. EMC Site

● Test Report No.: NK-18-E-0452

INTRODUCTION

The measurement procedure described in MP5:1986 for Methods of Measurement of radiated, powerline conducted radio noise, frequency and power output was used in determining emissions emanating from **Dongbu Daewoo Electronics Corporation**
FCC ID : **C5F7NF1JMO110N, Microwave Oven.**

These measurement tests were conducted at **Nemko Korea Co., Ltd. EMC Laboratory.**
The site address is 155, 153 and 159, Osan-ro, Mohyeon-eup, Cheoin-gu, Yongin-si, Gyeonggi-do 16885 Republic of Korea

The area of Nemko Korea Corporation Ltd. EMC Test Site is located in a mountain area at 80 kilometers (48 miles) southeast and Incheon International Airport (Incheon Airport), 30 kilometers (18 miles) south-southeast from central Seoul.

The Nemko Korea Co., Ltd. has been accredited as a Conformity Assessment Body (CAB).



Nemko Korea Co., Ltd.
155, 153 and 159, Osan-ro, Mohyeon-eup, Cheoin-gu, Yongin-si, Gyeonggi-do
16885 Republic of Korea
Tel) + 82 31 330 1700
Fax) + 82 31 322 2332

Fig. 1. The map above shows the Seoul in Korea vicinity area.
The map also shows Nemko Korea Corporation Ltd. EMC Lab and Incheon Airport.

EUT INFORMATION

EUT Information

Intended use	Household
Type of appliance	Counter-top, Built-in Type
Model	KOT-1J**, SMO1854D*
Rated voltage & frequency	a.c. 120 V, 60 Hz Single Phase
Rated power output	1 100 W
Rated power consumption	1 700 W
Magnetron	RM269 (DAEWOO)

Component List

Item	Model	Manufacturer	Serial Number
Magnetron	RM269	DAEWOO	N/A
Thermally Protected L. Air Over	OBB-2805X1	OH SUNG	N/A
Synchronous Motor	49TYD-16A1	YUYAO JING CHENG HIGH & NEW TECHNOLOGY CO., LTD.	N/A
FAN MOTOR	OEM-15DWX1-B07	OH SUNG	N/A
Diode H.V.	CL01-12	GAOXING	N/A
Trans H.V	DWAS11A0-1JA	ELEDEX CO.,LTD.	N/A
H.V. CAPACITOR	2100VAC 0.98uF	BiCai / China	N/A
Noise Filter	DWLF-M30	DAEWOO	N/A
Main Board	M381	DAEWOO	N/A

DESCRIPTION OF TESTS

Radiation Hazard

A 700 ml water load was placed in the center of the oven.

The power setting was set to maximum power.

While the oven was operating, the Microwave Survey Meter probe was moved slowly around the door seams to check for leakage.

Input Power Measurement

A 700 ml water load was placed in the center of the oven and the oven set to maximum power. A 700 ml water load was chosen for its compatibility.

Input power and current were measured using a Power Analyzer.

Manufacturers to determine their input ratings commonly use this procedure.

Output Power Measurement

The Caloric Method was used to determine maximum output power.

The initial temperature of a 1000 ml water load was measured. The water load was placed in the center of the oven. The oven was operated at maximum output power for 47 seconds. Then the temperature of the water re-measured.

Frequency Measurements

Following the above test, after operating the oven long enough to assure that stable operating temperature were obtained, the operating frequency was monitored as the input voltage was varied between 80 percent to 125 percent of the nominal rating.

And the load quantity was reduced by evaporation to approximately 20 % of the original quantity with nominal rating.

DESCRIPTION OF TESTS

Conducted Emissions

The Line conducted emission test facility is located inside a 4 x 7 x 2.5 m shielded enclosure.

It is manufactured by EM engineering. The shielding effectiveness of the shielded room is in accordance with MIL-STD-285 or NSA 65-6.

A 1 m x 1.5 m wooden table 0.8 m height is placed 0.4 m away from the vertical wall and 0.5 m away from the side of wall of the shielded room Rohde & Schwarz (ESH2-Z5) of the 50 ohm / 50 uH Line Impedance Stabilization Network(LISN) are bonded to the shielded room. The EUT is powered from the Rohde & Schwarz (ESH2-Z5) LISN.

Power to the LISN s are filtered by high-current high insertion loss power line filters.

The purpose of filter is to attenuate ambient signal interference and this filter is also bonded to shielded enclosure. All electrical cables are shielded by tinned copper zipper tubing with inner diameter of 1 / 2 ”.

If d.c. power device, power will be derived from the source power supply it normally will be powered from and this supply lines will be connected to the LISNs,

All interconnecting cables more than 1 m were shortened by non-inductive bundling (serpentine fashion) to a 1 m length.

Sufficient time for EUT, support equipment, and test equipment was allowed in order for them to warm up to their normal operating condition. The RF output of the LISN was connected to the spectrum analyzer to determine the frequency producing the maximum EME from the EUT. The spectrum was scanned from 150 kHz to 30 MHz with 20 ms sweep time.

The frequency producing the maximum level was re-examined using the EMI test receiver. (Rohde & Schwarz, ESCI).

The detector functions were set to quasi-peak mode & CISPR average mode.

The bandwidth of receiver was set to 9 kHz. The EUT, support equipment, and interconnecting cables were arranged and manipulated to maximize each EME emission.

Each emission was maximized by; switching power lines; varying the mode of operation or resolution; clock or data exchange speed; scrolling H pattern to the EUT and of support equipment, and powering the monitor from the floor mounted outlet box and computer aux a.c. outlet, if applicable; whichever determined the worst case emission.

Each EME reported was calibrated using the R&S signal generator.

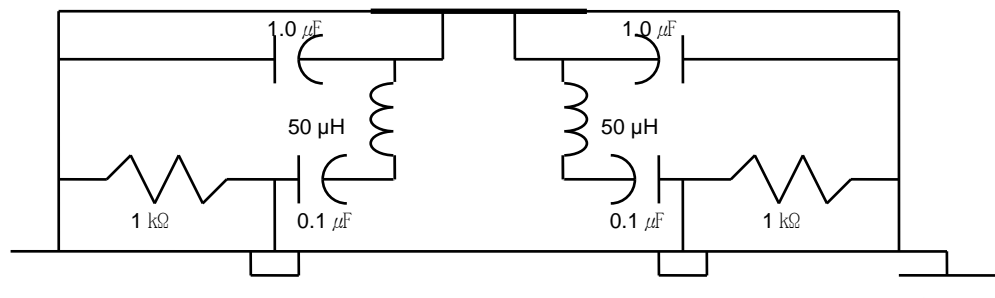

Fig. 2. LISN Schematic Diagram

DESCRIPTION OF TESTS

Radiated Emissions

Measurements were made indoors at 10 m & 3 m using antenna, signal conditioning unit and EMI test receiver to determine the frequency producing the maximum EME.

Appropriate precaution was taken to ensure that all EME from the EUT were maximized and investigated. The Technology configuration, clock speed, mode of operation or video resolution, turntable azimuth with respect to the antenna was noted for each frequency found.

The spectrum was scanned from 0.15 MHz to 30 MHz using Loop Antenna

(ROHDE & SCHWARZ/HFH2-Z2)

and from 30 MHz to 1000 MHz using TRILOG Broadband Test Antenna (Schwarzbeck, VULB 9163).

Above 1 GHz, Double Ridged Broadband Horn antenna (Schwarzbeck, HF907) was used.

Final Measurements were made indoors at 3 m using Loop Antenna

(ROHDE & SCHWARZ/HFH2-Z2) for measurement from 0.15 to 30 MHz with RBW 9 kHz and

made indoor at 10 m using TRILOG Broadband Test Antenna (Schwarzbeck, VULB 9163) for measurement from 30 MHz to 1000 MHz with RBW 100 kHz and made indoors at 3 m using Double Ridged Broadband Horn antenna (Schwarzbeck, HF907) for measurement from 1 GHz to 18 GHz with RBW 1 MHz.

The detector function were set to quasi peak mode and the bandwidth of the receiver were set to 9 kHz, 100 kHz and peak mode 1 MHz depending on the frequency or type of signal.

The Double Ridged Broadband Horn antenna was tuned to the frequency found during preliminary radiated measurements.

The EUT support equipment and interconnecting cables were re-configured to the setup producing the maximum emission for the frequency and were placed on top of a 0.8 m high non-metallic 1.0 X 1.5 meter table.

The EUT, support equipment and interconnecting cables were re-arranged and manipulated to maximize each EME emission.

The EUT is rotated about its vertical axis on the turntable, and the polarization and height of the receiving antenna are varied to obtain the highest field strength on the particular frequency under observation.

Each EME reported was calibrated using the R/S signal generator.

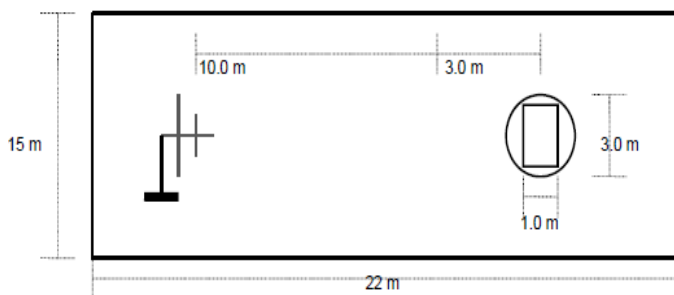

Fig. 3. Dimensions of 10 semi anechoic chamber

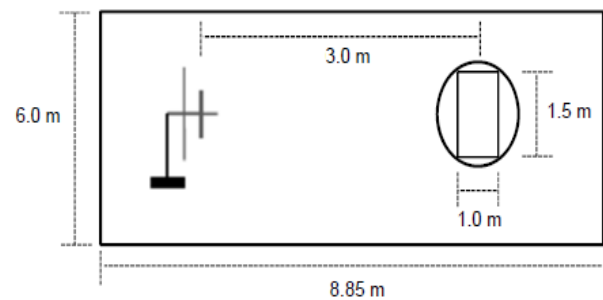

Fig. 4. Dimensions of 3 m full anechoic chamber

TEST DATA

Radiation Hazard

Probe Location	Maximum Leakage [mW/Cm2]	Limit [mW/Cm2]
A, B	0.03	1.00
C	0.02	1.00
All others	0.01	1.00

Input Power Measurement

Operation mode	P rated (W)	P (W)	dP (%)	Required dP (%)
Power Input	1 700	1 661	2.34	+ 15 %

Output Power Measurement

Quantity of Water [ml]	Mass of the container [g]	Ambient temperature [°C]	Initial temperature [°C]	Final temperature [°C]	Heating time [s]	Power output [W]
1 000	400	20.0	10.0	19.8	38	1079

Formula :

$$P = \frac{4.187 \times m_w \times (T_1 - T_0) + 0.55 \times m_c \times (T_1 - T_A)}{t}$$

NOTE :

P is the microwave power output (W)

m_w is the mass of the water (g)

m_c is the mass of the container (g)

T_A is the ambient temperature (°C)

T₀ is the initial temperature of the water (°C)

T₁ is the final temperature of the water (°C)

t is the heating time (s), excluding the magnetron filament heating-up time.



Tested by : Taejoo Kim

TEST DATA

Frequency measurements

► Frequency vs Line Voltage Variation Test

[Room Temperature : 22.0 ± 1.0 °C]

Line Voltage Variation (a.c. V)	*)Pole	Frequency [MHz]	Allowed Tolerance for the ISM Band
96 (80 %)	H	Lower : 2 437.0	Lower : 2 400 MHz Upper : 2 500 MHz
	H	Upper : 2 480.2	
	V	Lower : 2 432.2	
	V	Upper : 2 475.4	
108 (90 %)	H	Lower : 2 443.2	
	H	Upper : 2 477.8	
	V	Lower : 2 436.5	
	V	Upper : 2 475.0	
120 (100 %)	H	Lower : 2 445.6	
	H	Upper : 2 476.9	
	V	Lower : 2 444.7	
	V	Upper : 2 478.8	
132 (110 %)	H	Lower : 2 448.7	
	H	Upper : 2 484.6	
	V	Lower : 2 439.4	
	V	Upper : 2 478.3	
150 (125 %)	H	Lower : 2 435.0	
	H	Upper : 2 475.9	
	V	Lower : 2 427.8	
	V	Upper : 2 477.8	

NOTE :

1. *Pol. H = Horizontal V = Vertical
2. Initial load : 1 000 ml of water in the beaker.
3. Line voltage varied from 80 % to 125 %.
4. ISM Frequency : 2 450 MHz, Tolerance : ± 50 MHz

RESULT : Pass



Tested by : **Taejoo Kim**

TEST DATA

► Frequency vs Load Variation Test

[Room Temperature : 23.0 ± 1.0 °C]

Volume of water (ml)	*)Pole	Frequency [MHz]	Allowed Tolerance for the ISM Band
200	H	Lower : 2 446.1	Lower : 2 400 MHz Upper : 2 500 MHz
	H	Upper : 2 495.6	
	V	Lower : 2 443.7	
	V	Upper : 2 476.4	
400	H	Lower : 2 446.1	
	H	Upper : 2 475.4	
	V	Lower : 2 446.1	
	V	Upper : 2 488.9	
600	H	Lower : 2 446.6	
	H	Upper : 2 483.6	
	V	Lower : 2 446.1	
	V	Upper : 2 479.3	
800	H	Lower : 2 445.1	
	H	Upper : 2 475.4	
	V	Lower : 2 447.5	
	V	Upper : 2 490.3	
1000	H	Lower : 2 445.6	
	H	Upper : 2 476.9	
	V	Lower : 2 444.7	
	V	Upper : 2 478.8	

NOTE :

1. *Pol. H = Horizontal, V = Vertical
2. The water load was varied between 200 ml to 1 000 ml.
3. Frequency was measured by using nominal voltage (a.c. 120 V).
4. ISM Frequency : 2 450 MHz, Tolerance : ± 50 MHz

RESULT : Pass



Tested by : **Taejoo Kim**

TEST DATA

Conducted Emissions

FCC ID : C5F7NF1JMO110N

[Room Temperature : 22.0 ± 1.0 °C]

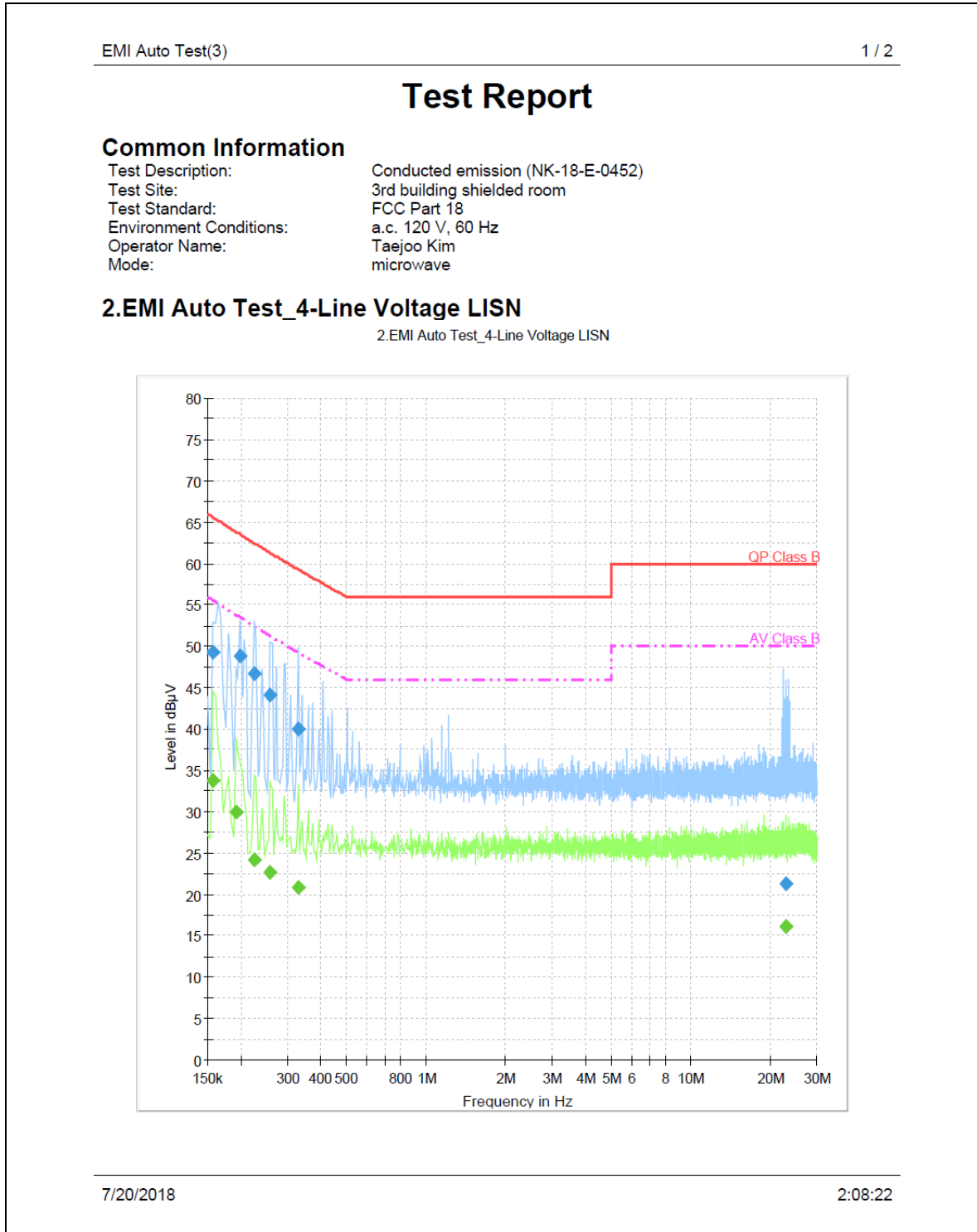

EMI Auto Test(3)

2 / 2

Final Result 1

Frequency (MHz)	QuasiPeak (dB μ V)	Meas. Time (ms)	Bandwidth (kHz)	PE	Line	Corr. (dB)	Margin (dB)	Limit (dB μ V)	Comment
0.157462	49.2	15000.0	9.000	GND	N	10.3	16.4	65.6	
0.198506	48.8	15000.0	9.000	GND	L1	10.3	14.7	63.5	
0.224625	46.7	15000.0	9.000	GND	L1	10.3	15.7	62.5	
0.258206	44.0	15000.0	9.000	GND	L1	10.3	17.3	61.3	
0.329100	40.1	15000.0	9.000	GND	N	10.3	19.2	59.3	
22.944206	21.3	15000.0	9.000	GND	N	10.8	38.7	60.0	

Final Result 2

Frequency (MHz)	CAverage (dB μ V)	Meas. Time (ms)	Bandwidth (kHz)	PE	Line	Corr. (dB)	Margin (dB)	Limit (dB μ V)	Comment
0.157462	33.8	15000.0	9.000	GND	L1	10.3	21.8	55.6	
0.191044	30.0	15000.0	9.000	GND	L1	10.3	23.9	53.8	
0.224625	24.3	15000.0	9.000	GND	L1	10.3	28.2	52.4	
0.258206	22.6	15000.0	9.000	GND	N	10.3	28.6	51.2	
0.329100	20.9	15000.0	9.000	GND	N	10.3	28.4	49.3	
22.910625	16.1	15000.0	9.000	GND	L1	10.8	33.9	50.0	

7/20/2018

2:08:22

NOTES:

- 1. Measurements using quasi-peak mode & average mode.**
- 2. If no frequencies are specified in the tables, no measurement for quasi-peak or average was necessary.**
- 3. Line : L = Line , N = Neutral**
- 4. The limit for consumer device is on the FCC Part section 18.307(b).**

A handwritten signature in blue ink, appearing to be "Taejoo Kim".

Tested by : **Taejoo Kim**

TEST DATA

Radiated Emissions (150 kHz to 30 MHz)

FCC ID : C5F7NF1JMO110N

[Room Temperature : 21.0 ± 1.0 °C]

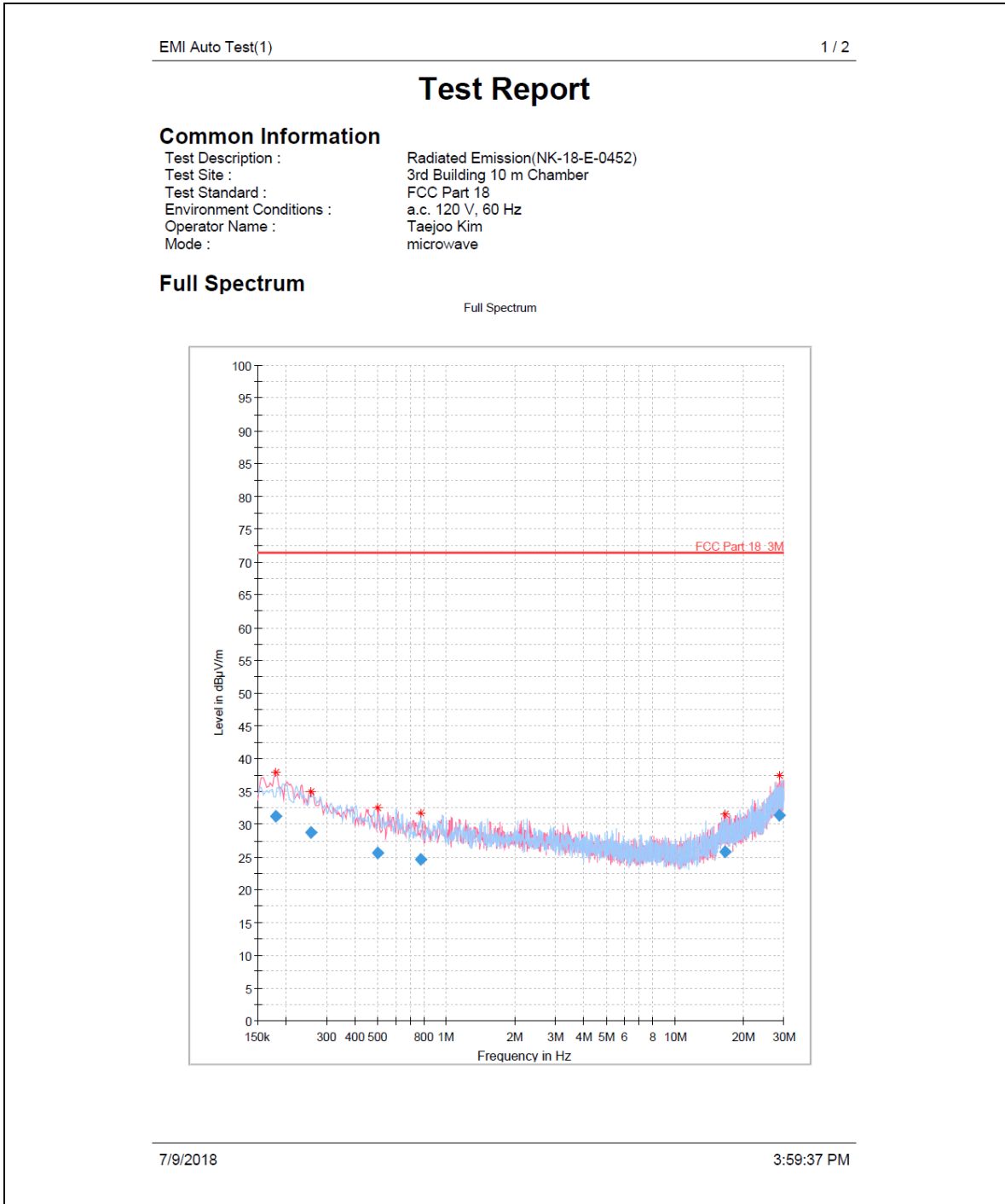

EMI Auto Test(1)

2 / 2

Critical Freqs

Frequency (MHz)	MaxPeak (dBµV/m)	Limit (dBµV/m)	Margin (dB)	Meas. Time (ms)	Bandwidth (kHz)	Pol	Azimuth (deg)	Corr. (dB)
0.179850	37.98	71.40	33.42	---	---	V	270.0	-22.4
0.257460	35.03	71.40	36.37	---	---	H	325.0	-22.6
0.502230	32.58	71.40	38.82	---	---	V	160.0	-22.8
0.773865	31.70	71.40	39.70	---	---	H	272.0	-22.7
16.588395	31.56	71.40	39.84	---	---	V	71.0	-19.9
28.725405	37.48	71.40	33.92	---	---	V	177.0	-13.3

(continuation of the "Critical_Freqs" table from column 15 ...)

Frequency (MHz)	Comment
0.179850	4:04:56 PM - 7/9/2018
0.257460	4:04:56 PM - 7/9/2018
0.502230	4:04:56 PM - 7/9/2018
0.773865	4:04:56 PM - 7/9/2018
16.588395	4:04:56 PM - 7/9/2018
28.725405	4:04:56 PM - 7/9/2018

Final Result

Frequency (MHz)	QuasiPeak (dBµV/m)	Limit (dBµV/m)	Margin (dB)	Meas. Time (ms)	Bandwidth (kHz)	Pol	Azimuth (deg)	Corr. (dB)
0.179850	31.14	71.40	40.26	15000.0	9.000	V	270.0	-22.4
0.257460	28.72	71.40	42.68	15000.0	9.000	H	325.0	-22.6
0.502230	25.64	71.40	45.76	15000.0	9.000	V	160.0	-22.8
0.773865	24.55	71.40	46.85	15000.0	9.000	H	272.0	-22.7
16.588395	25.75	71.40	45.65	15000.0	9.000	V	71.0	-19.9
28.725405	31.34	71.40	40.06	15000.0	9.000	V	177.0	-13.3

(continuation of the "Final_Result" table from column 15 ...)

Frequency (MHz)	Comment
0.179850	4:09:07 PM - 7/9/2018
0.257460	4:06:39 PM - 7/9/2018
0.502230	4:08:10 PM - 7/9/2018
0.773865	4:06:11 PM - 7/9/2018
16.588395	4:07:37 PM - 7/9/2018
28.725405	4:08:34 PM - 7/9/2018

7/9/2018

3:59:37 PM

<Radiated Measurements at 3 meters >

NOTES:

1. *Pol. H = Horizontal V = Vertical
2. **AF + CL + Amp. = Antenna Factor + Cable Loss + Amplifier.
3. Distance Correction factor : $20 * \log (300 / 3) = 40 \text{ dBuV/m}$
4. The limit at 300 meters is $20 * \log (25 * \text{SQRT} (\text{RF Power} / 500))$
5. All other emissions were measured while a 700 $\text{m}\ell$ load was placed in the center of the oven.
6. The limit for consumer device is on the FCC Part section 18.305.



Tested by : **Taejoo Kim**

TEST DATA

Radiated Emissions (30 MHz to 1 GHz)

FCC ID : C5F7NF1JMO110N

[Room Temperature : 22.0 ± 1.0 °C]

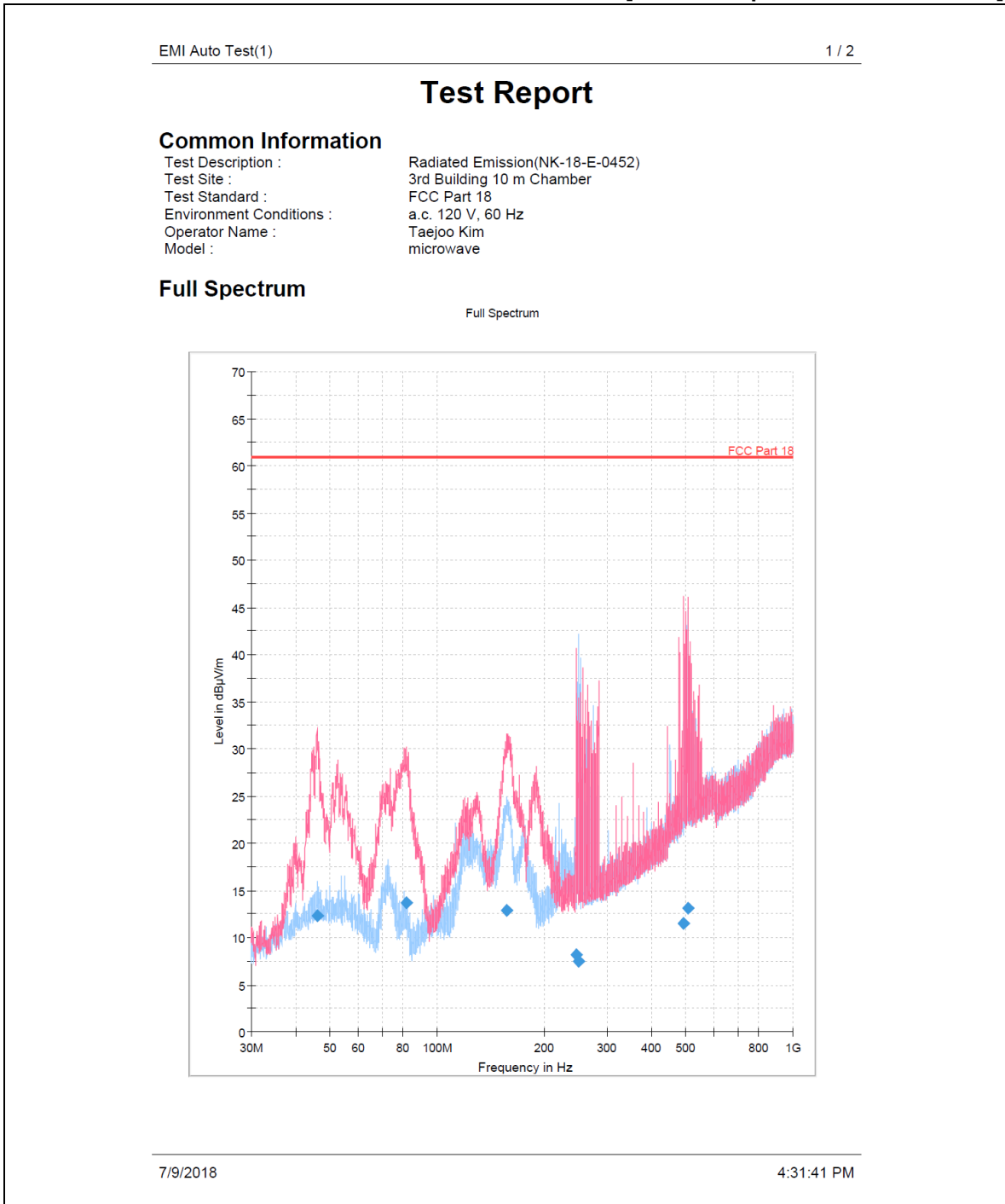

EMI Auto Test(1)

2 / 2

Final Result

Frequency (MHz)	CAverage (dBµV/m)	Limit (dBµV/m)	Margin (dB)	Meas. Time (ms)	Bandwidth (kHz)	Height (cm)	Pol	Azimuth (deg)	Corr. (dB)
46.005000	12.36	60.90	48.54	15000.0	120.000	100.0	V	3.0	-21.3
81.636333	13.64	60.90	47.26	15000.0	120.000	230.0	V	348.0	-26.8
157.328667	12.82	60.90	48.08	15000.0	120.000	130.0	V	344.0	-24.6
246.795000	8.19	60.90	52.71	15000.0	120.000	170.0	V	-5.0	-18.9
249.963667	7.46	60.90	53.44	15000.0	120.000	330.0	H	302.0	-18.7
493.013333	11.45	60.90	49.45	15000.0	120.000	177.0	V	237.0	-10.5
505.429333	13.06	60.90	47.84	15000.0	120.000	230.0	V	73.0	-10.2

(continuation of the "Final_Result" table from column 16 ...)

Frequency (MHz)	Comment
46.005000	
81.636333	
157.328667	
246.795000	
249.963667	
493.013333	
505.429333	

7/9/2018

4:31:41 PM

<Radiated Measurements at 10 meters>

NOTES:

1. *Pol. H = Horizontal V = Vertical
2. **AF + CL + Amp. = Antenna Factor + Cable Loss + Amplifier.
3. Distance Correction factor : $20 * \log (300/10) \doteq 29.5 \text{ dB } \mu\text{N/m}$
4. The limit at 300 meters is $20 * \log (25 * \text{SQRT} (\text{RF Power}/500))$
5. All other emissions were measured while a 700 mℓ load was placed in the center of the oven.
6. The limit for consumer device is on the FCC Part section 18.305.



Tested by : **Taejoo Kim**

TEST DATA

Radiated Emissions (Above 1 GHz)

FCC ID : C5F7NF1JMO110N

[Room Temperature : 21.0 ± 1.0 °C]

Frequency (MHz)	Pol* (H/V)	Antenna Heights (cm)	Turntable Angles (°)	Reading Level (dBμV)	Total Loss** (dB)	Result at 3 m		K	Results at 300 m	Limits at 300 m
						(dBμV/m)	(μV/m)		(μV/m)	(μV/m)
1 939.75	H	200.0	330	73.9	-6.3	67.6	2398.8	0.004	9.6	37.1
2 206.00	V	99.9	43	49.4	-6.0	43.4	147.9	0.005	0.7	37.1
2 764.75	H	200.0	326	80.3	-4.5	75.8	6166.0	0.007	43.2	37.1
4 912.50	H	400.2	264	48.0	-2.1	45.9	197.2	0.01	2.0	37.1
7 978.12	H	99.9	283	74.7	3.2	77.9	7852.4	0.01	78.5	37.1
8 580.00	H	299.9	58	76.5	3.3	79.8	9772.4	0.01	97.7	37.1
9 883.12	V	400.1	118	45.7	4.2	49.9	312.6	0.01	3.1	37.1
14 816.25	H	299.9	316	69.5	10.9	80.4	10471.3	0.01	104.7	37.1

<Radiated Measurements at 3 meters>

NOTES:

- * Pol. H=Horizontal V=Vertical
- ** Total Loss = Antenna Factor + Cables Loss + Amplifier + HPF (High Pass Filter)
- Field Strength (at 300 m) (uV/m) = $K * 10^{[Fieldstrength\ at\ 3\ m\ (dBuV/m) / 20]}$
- The limit at 300 meters is $25 * SQRT (RF\ Power/500)$
- Load for measurement of radiation on second and third harmonic : Two loads, one of 700 ml and the other of 300 ml, of water were used. Each load was tested both with the beaker located in the center of the oven and with it in the corner.
- The test was performed at peak detector mode with average.
- The limit for consumer device is on the FCC Part section 18.305.



Tested by : **Taejoo Kim**

PLOTS OF EMISSIONS

- **Frequency vs Line Voltage Variation Test**

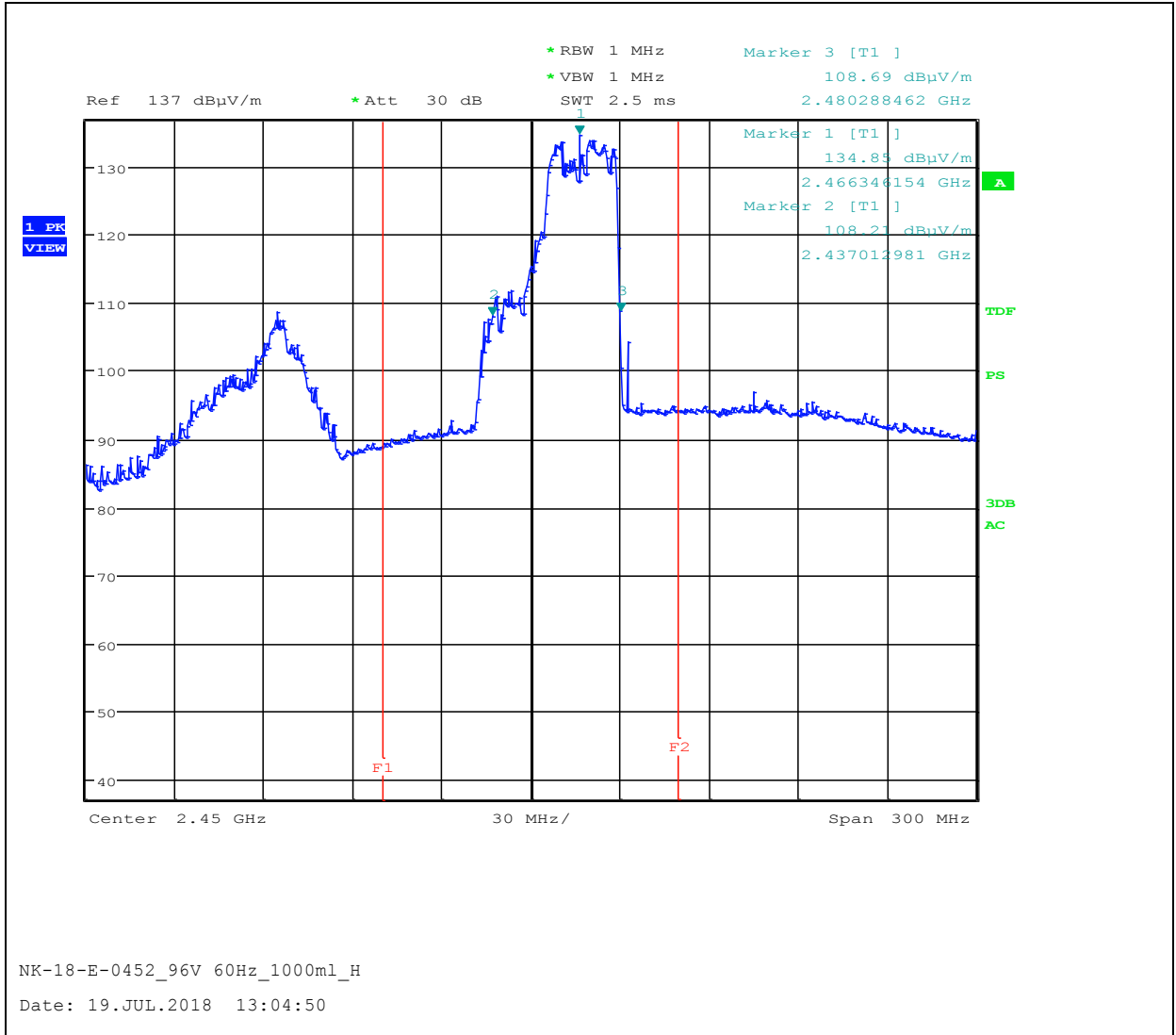

Horizontal (96 V, 1000 ml)

PLOTS OF EMISSIONS

- **Frequency vs Line Voltage Variation Test**

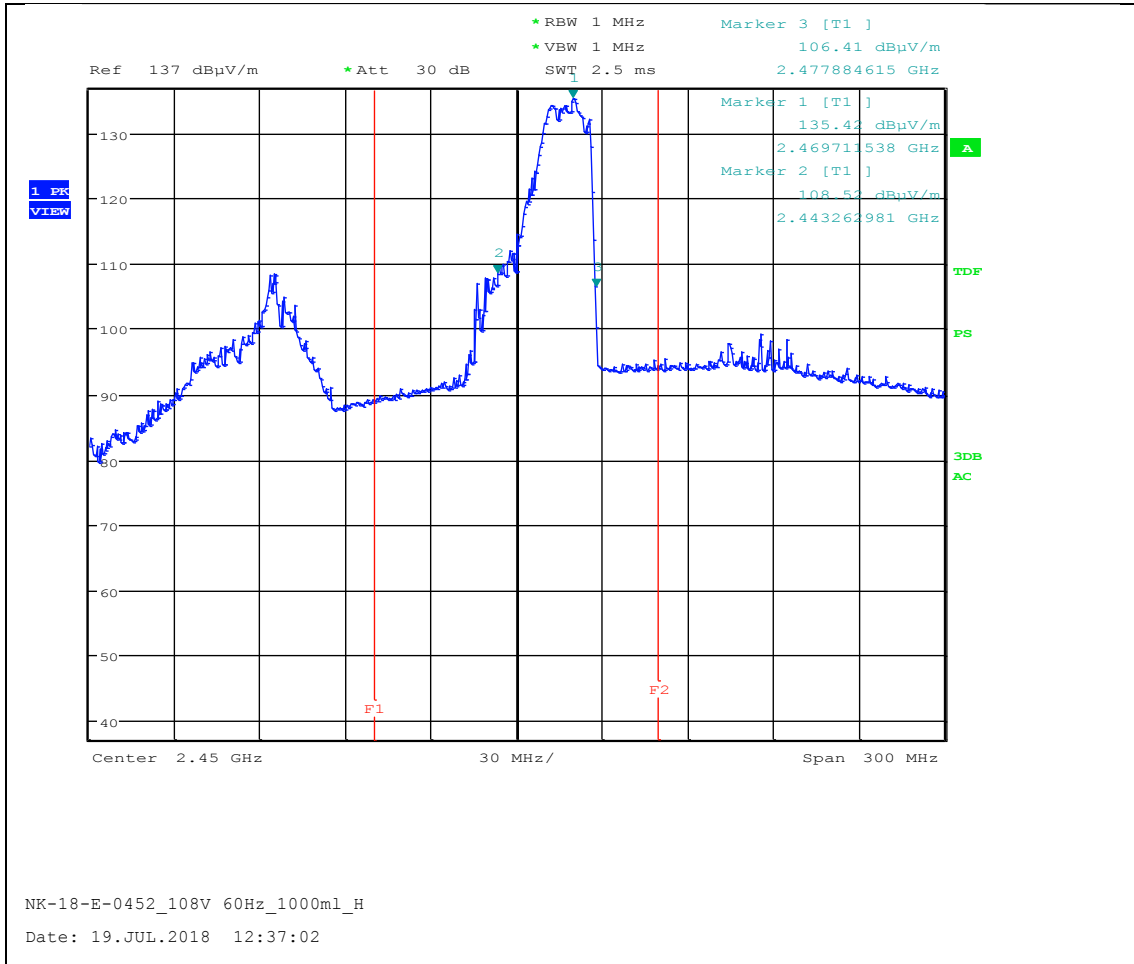

Horizontal (108 V, 1000 ml)

PLOTS OF EMISSIONS

- **Frequency vs Line Voltage Variation Test**

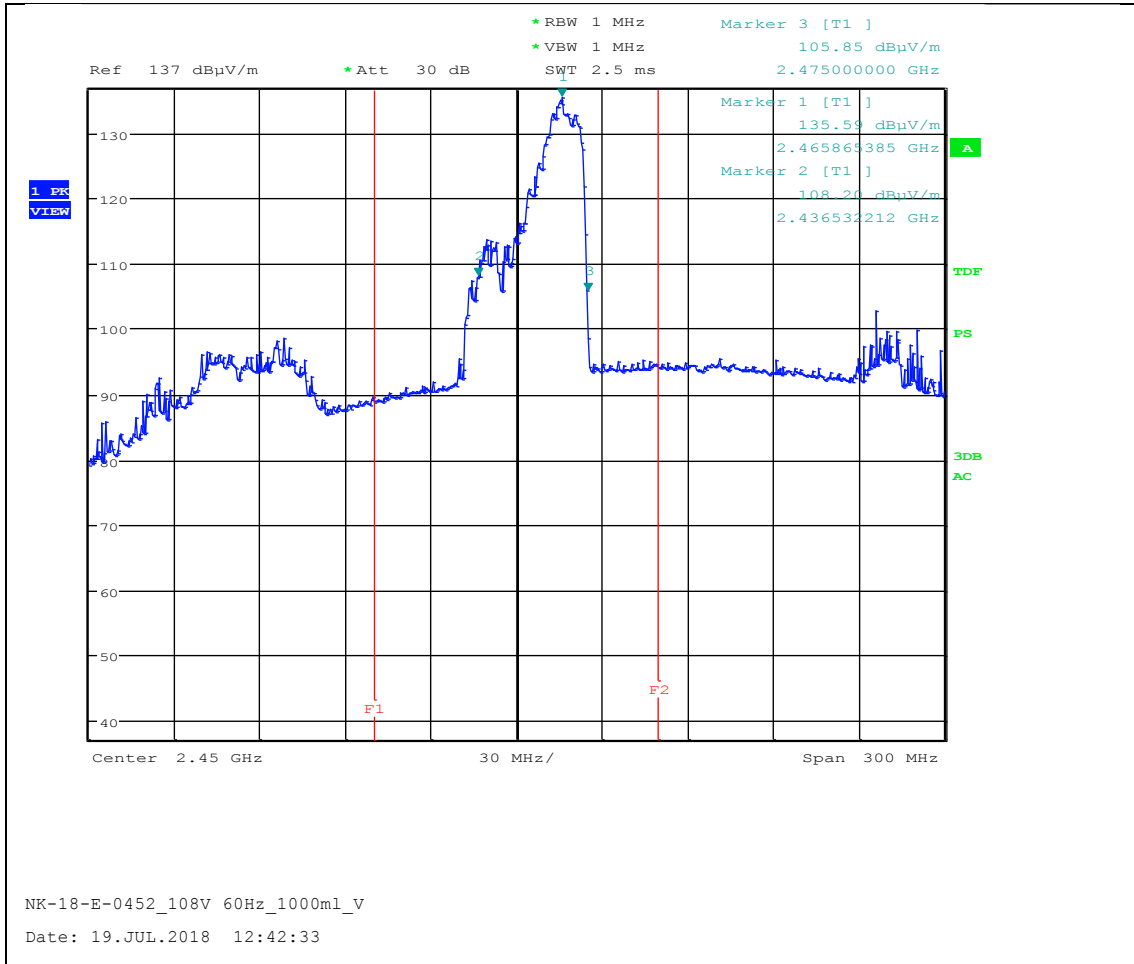

Vertical (108 V, 1000 ml)

PLOTS OF EMISSIONS

- **Frequency vs Line Voltage Variation Test**

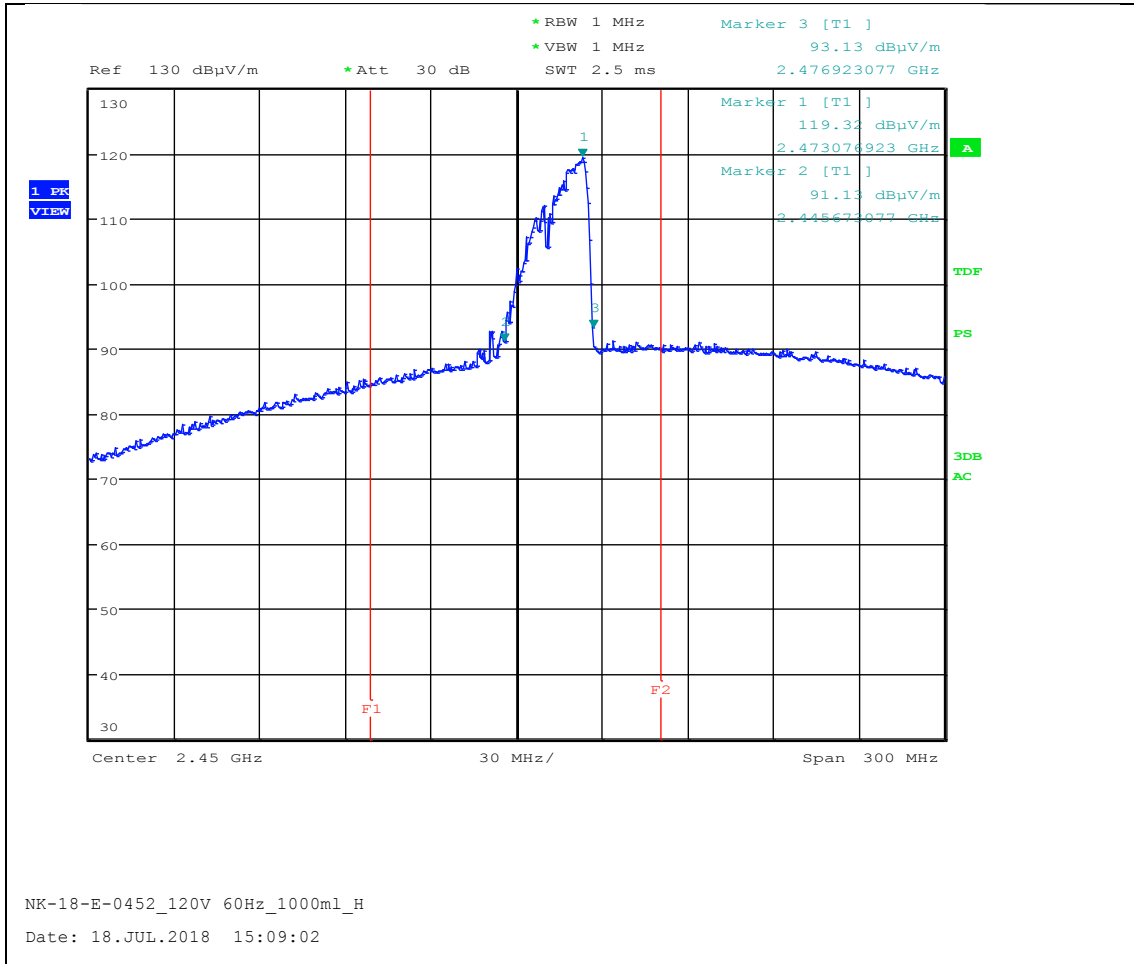

Horizontal (120 V, 1000 ml)

PLOTS OF EMISSIONS

- **Frequency vs Line Voltage Variation Test**

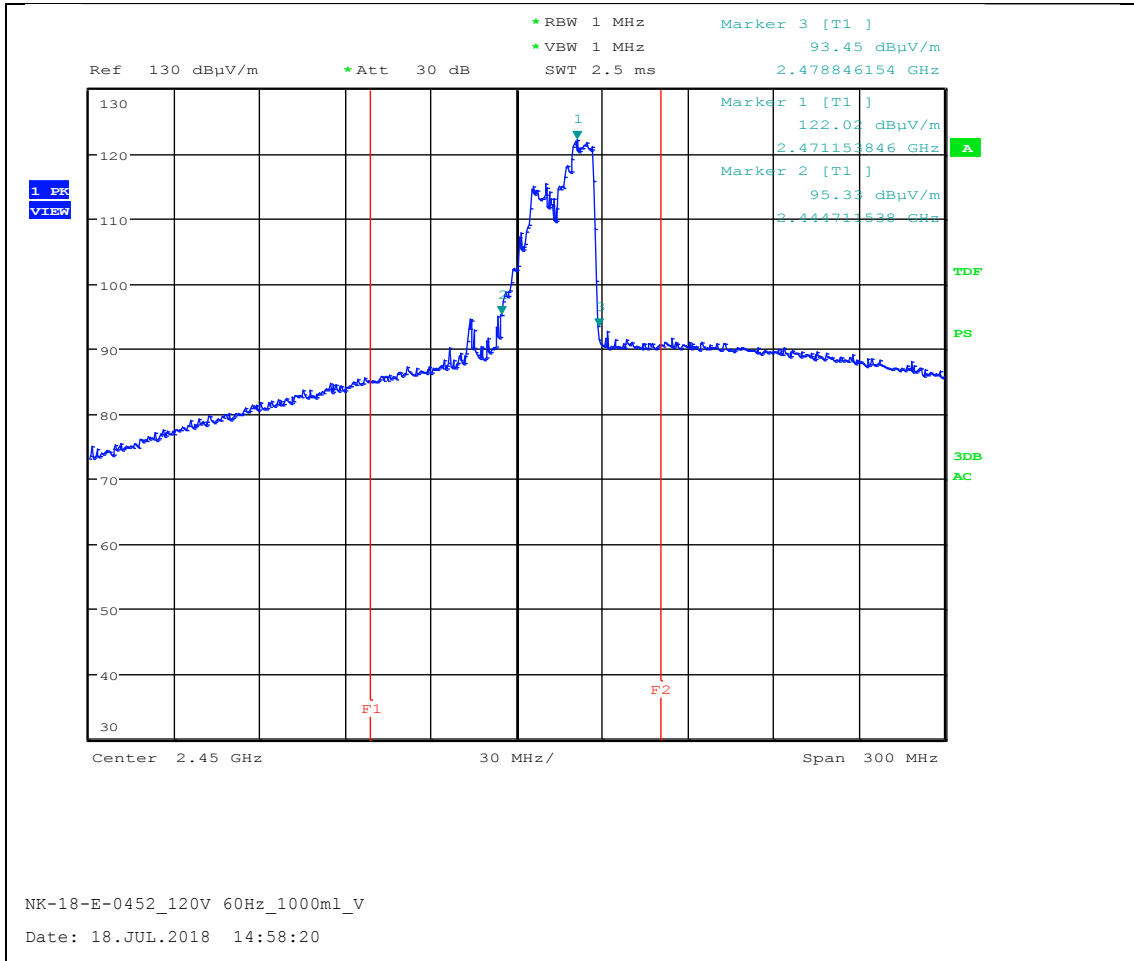

Vertical (120 V, 1000 ml)

PLOTS OF EMISSIONS

- **Frequency vs Line Voltage Variation Test**

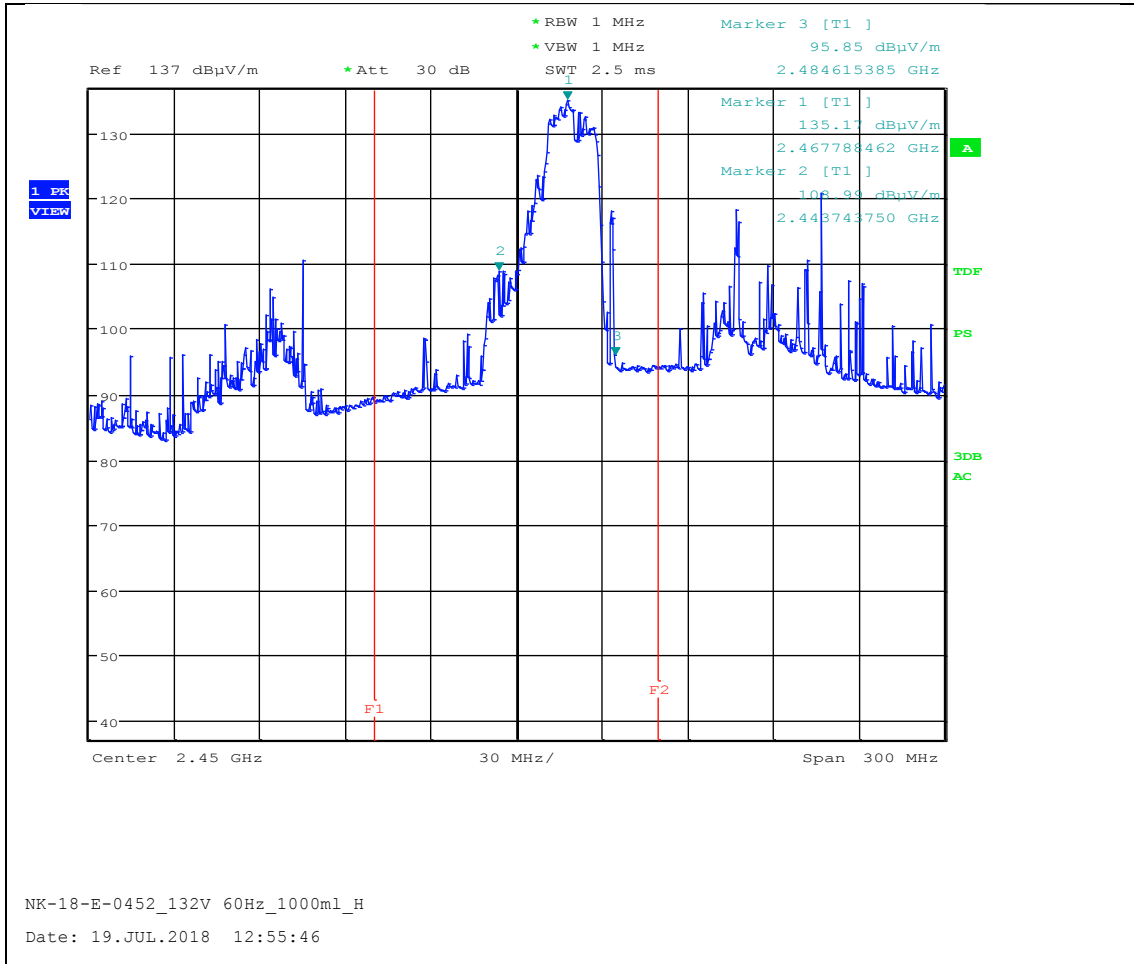

Horizontal (132 V, 1000 ml)

PLOTS OF EMISSIONS

- **Frequency vs Line Voltage Variation Test**

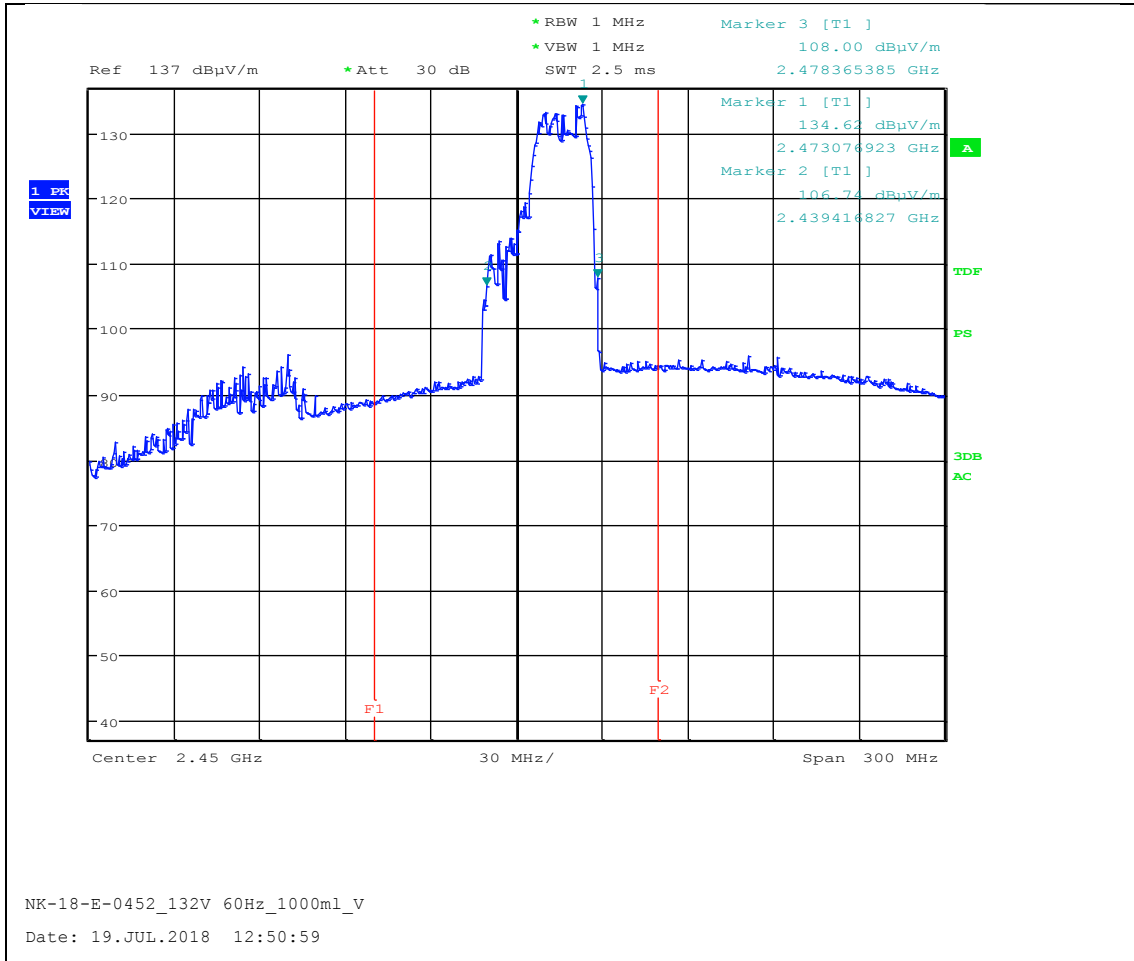

Vertical (132 V, 1000 ml)

PLOTS OF EMISSIONS

- **Frequency vs Line Voltage Variation Test**

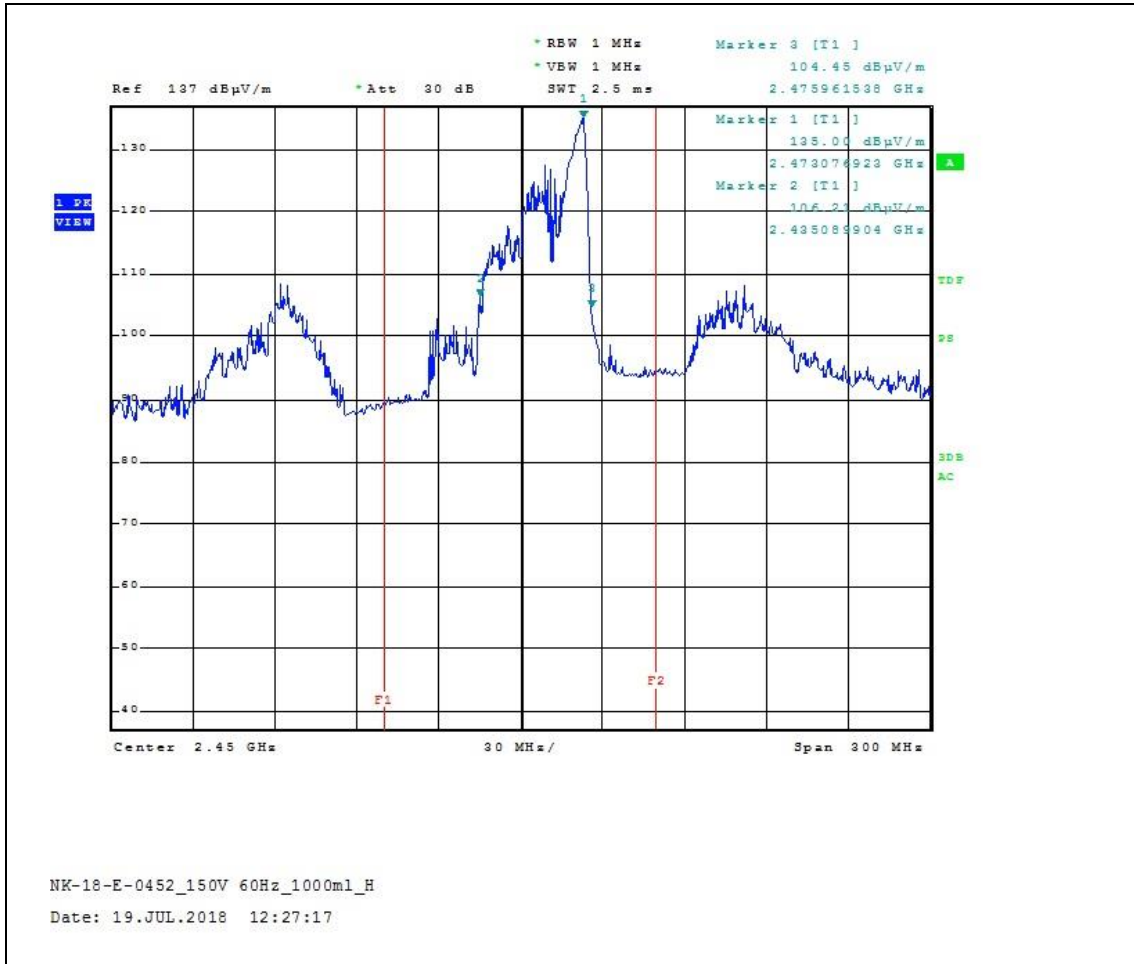

Horizontal (150 V, 1000 mℓ)

PLOTS OF EMISSIONS

- **Frequency vs Line Voltage Variation Test**

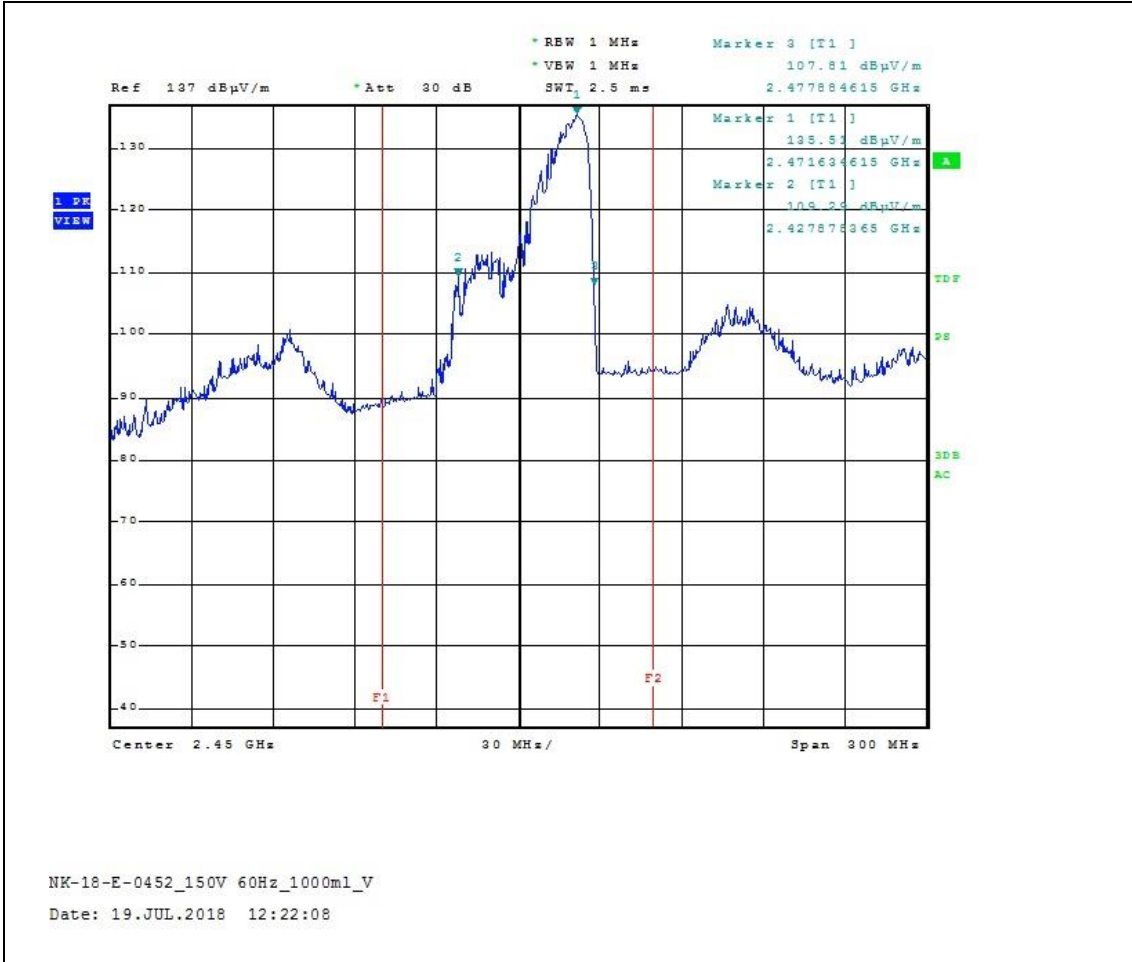

Vertical (150 V, 1000 ml)

PLOTS OF EMISSIONS

- **Frequency vs Load Variation Test**

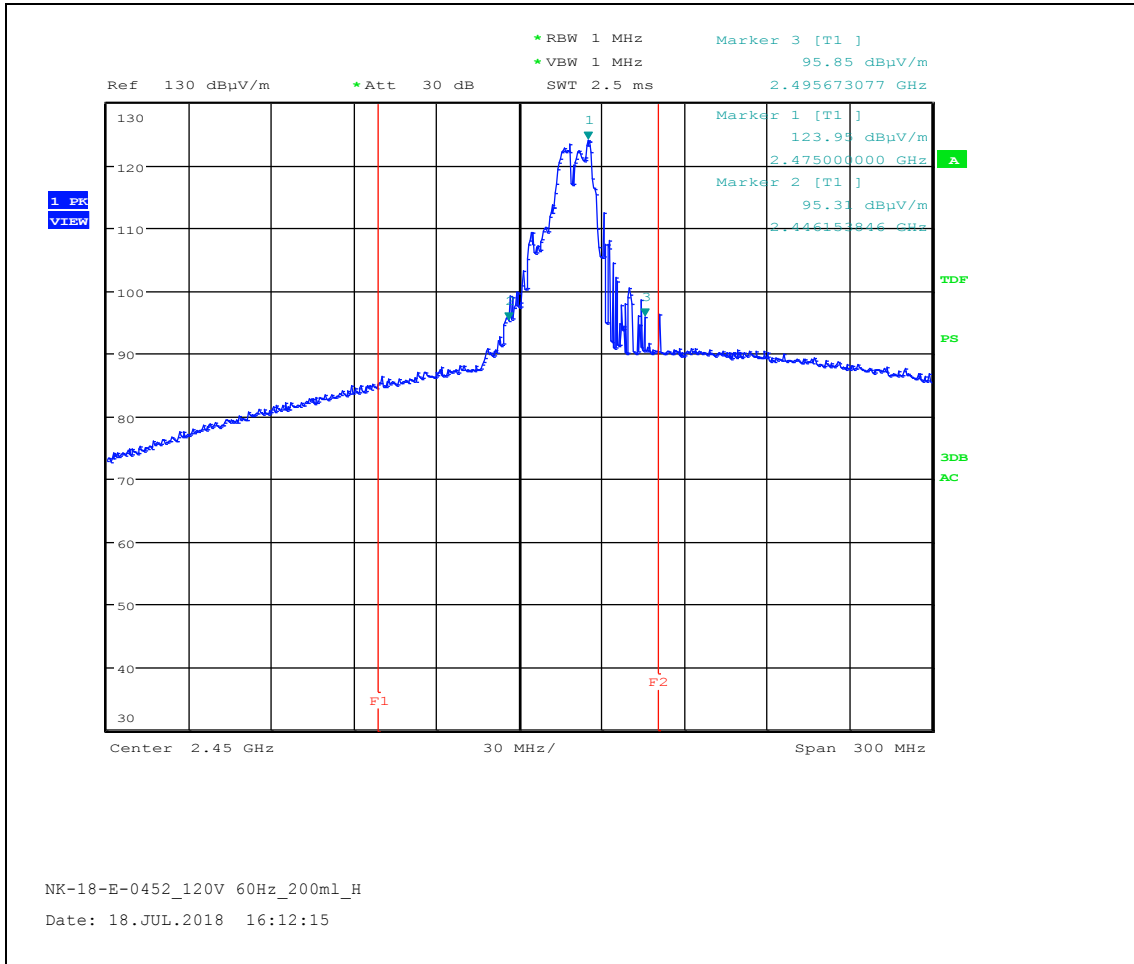

Horizontal (120 V, 200 ml)

PLOTS OF EMISSIONS

- **Frequency vs Load Variation Test**

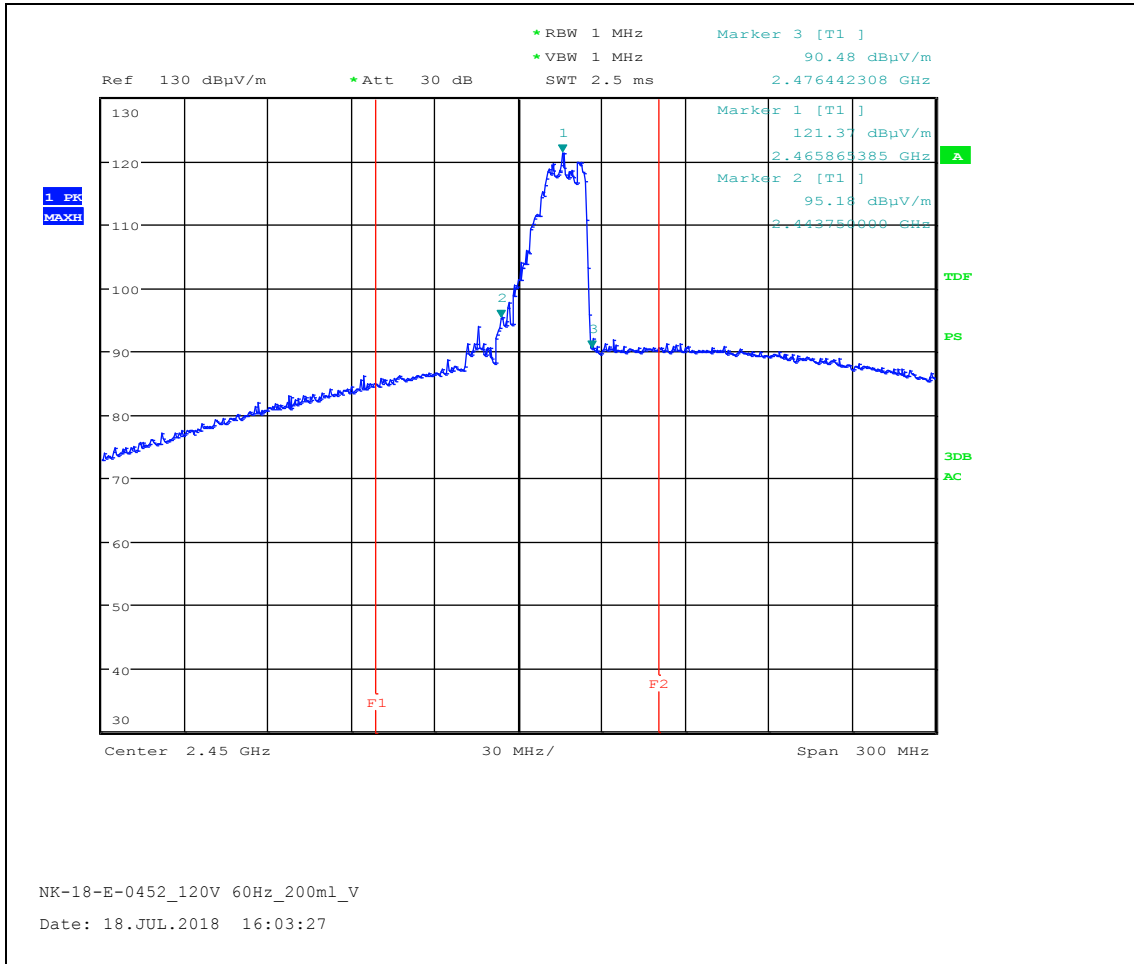

Vertical (120 V, 200 ml)

PLOTS OF EMISSIONS

- **Frequency vs Load Variation Test**

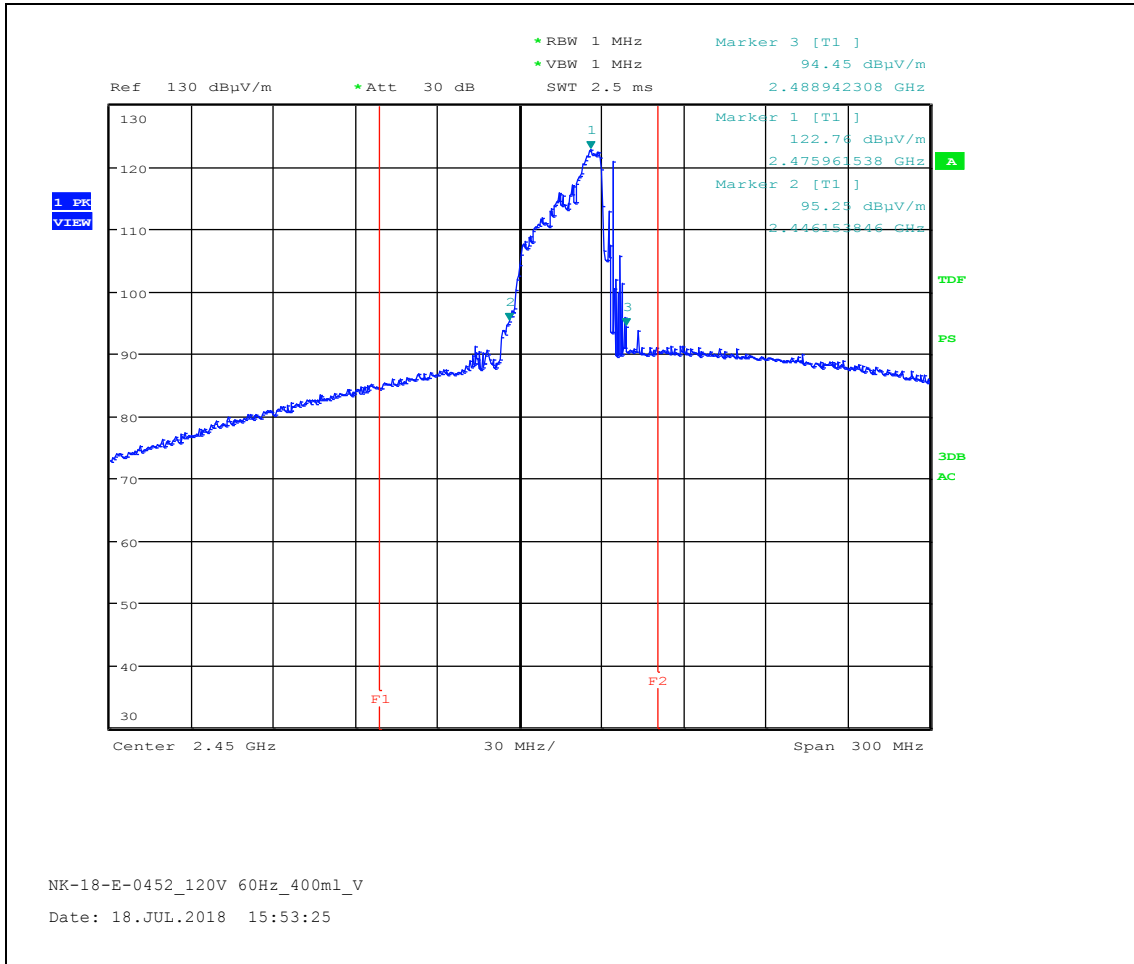

Vertical (120 V, 400 ml)

PLOTS OF EMISSIONS

- **Frequency vs Load Variation Test**

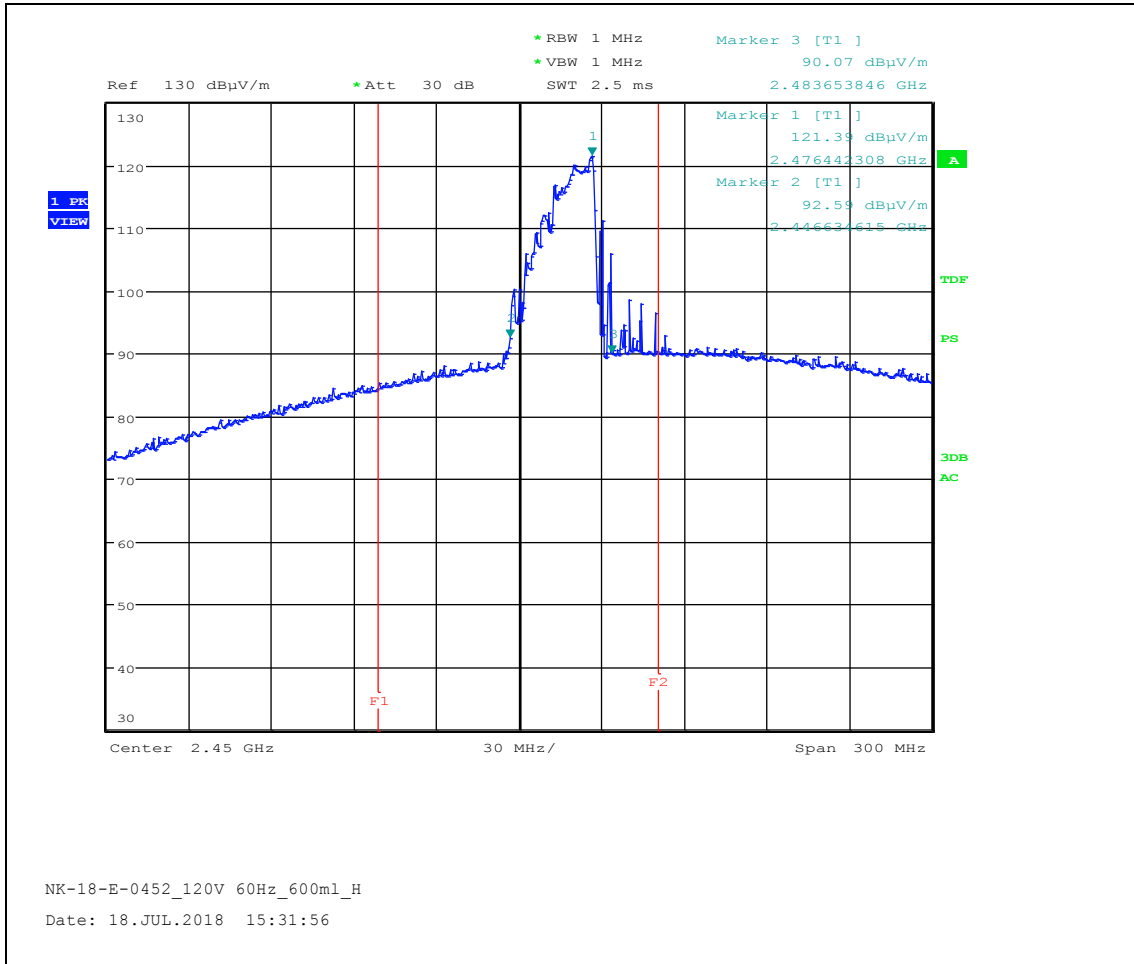

Horizontal (120 V, 600 ml)

PLOTS OF EMISSIONS

- **Frequency vs Load Variation Test**

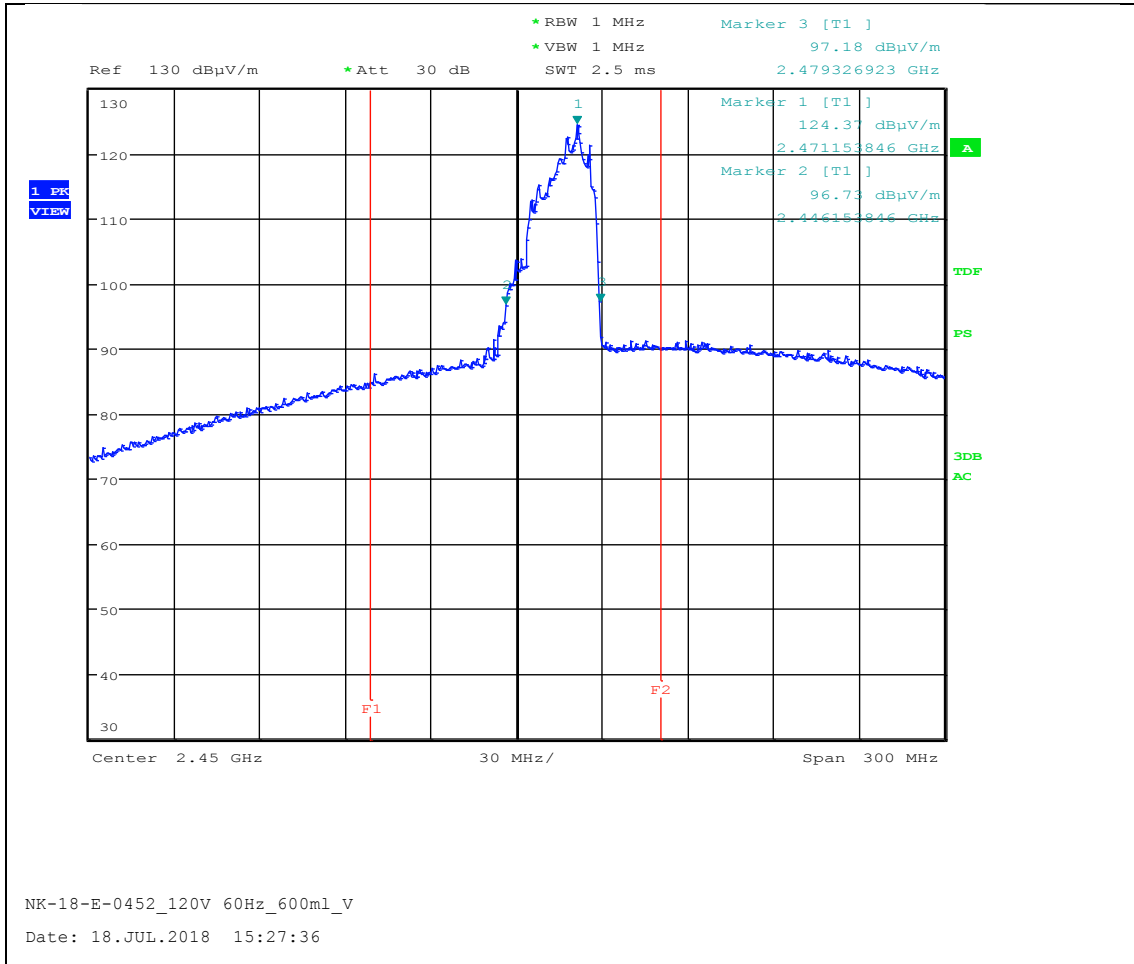

Vertical (120 V, 600 ml)

PLOTS OF EMISSIONS

- **Frequency vs Load Variation Test**

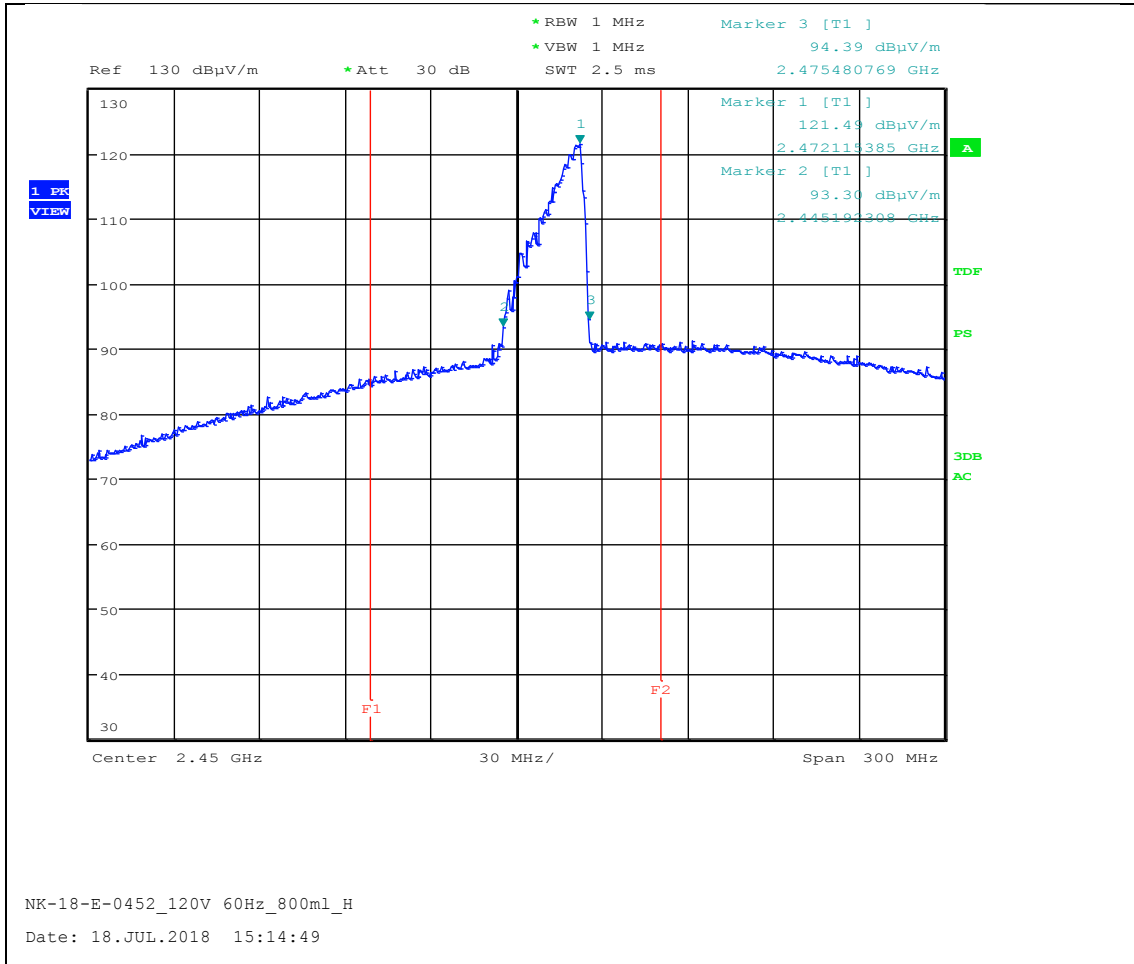

Horizontal (120 V, 800 ml)

PLOTS OF EMISSIONS

- **Frequency vs Load Variation Test**

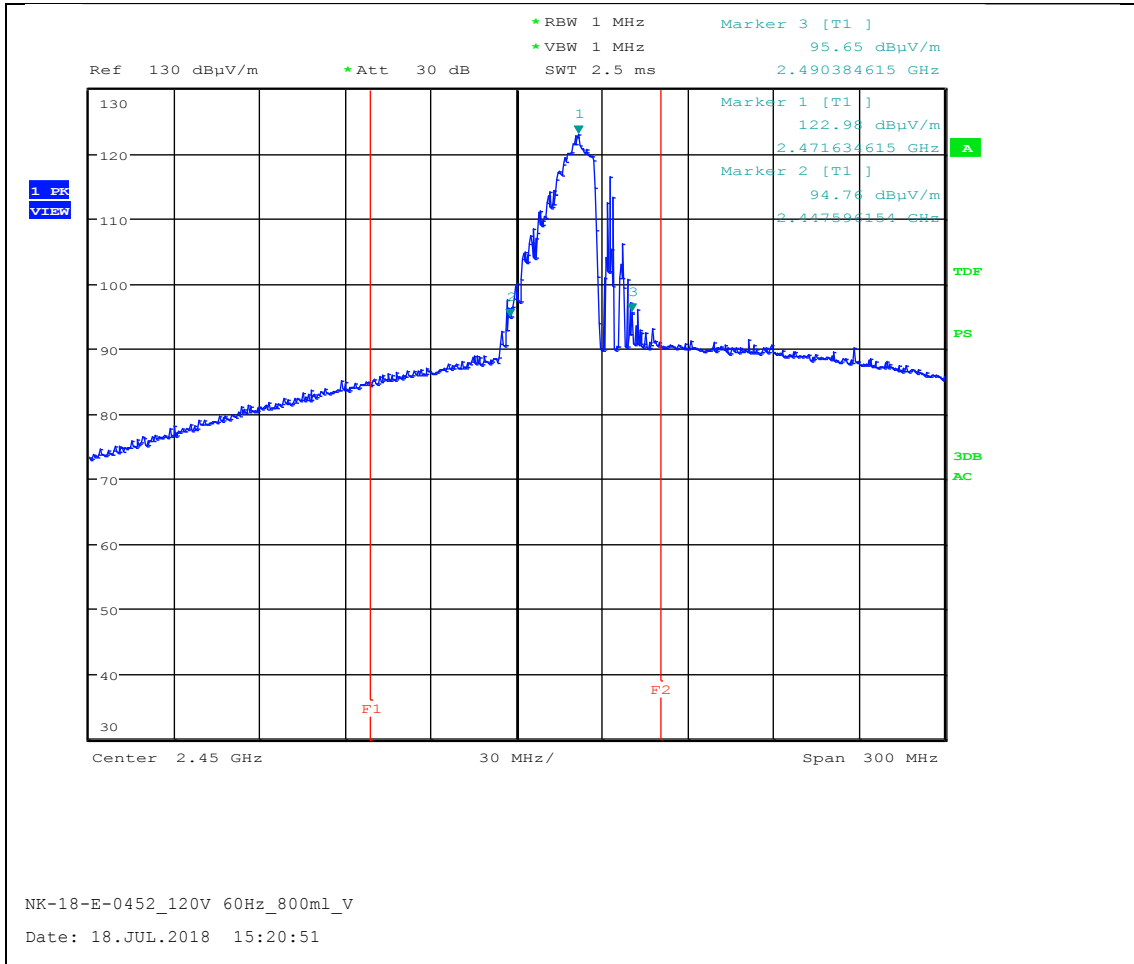

Vertical (120 V, 800 ml)

PLOTS OF EMISSIONS

- **Frequency vs Load Variation Test**

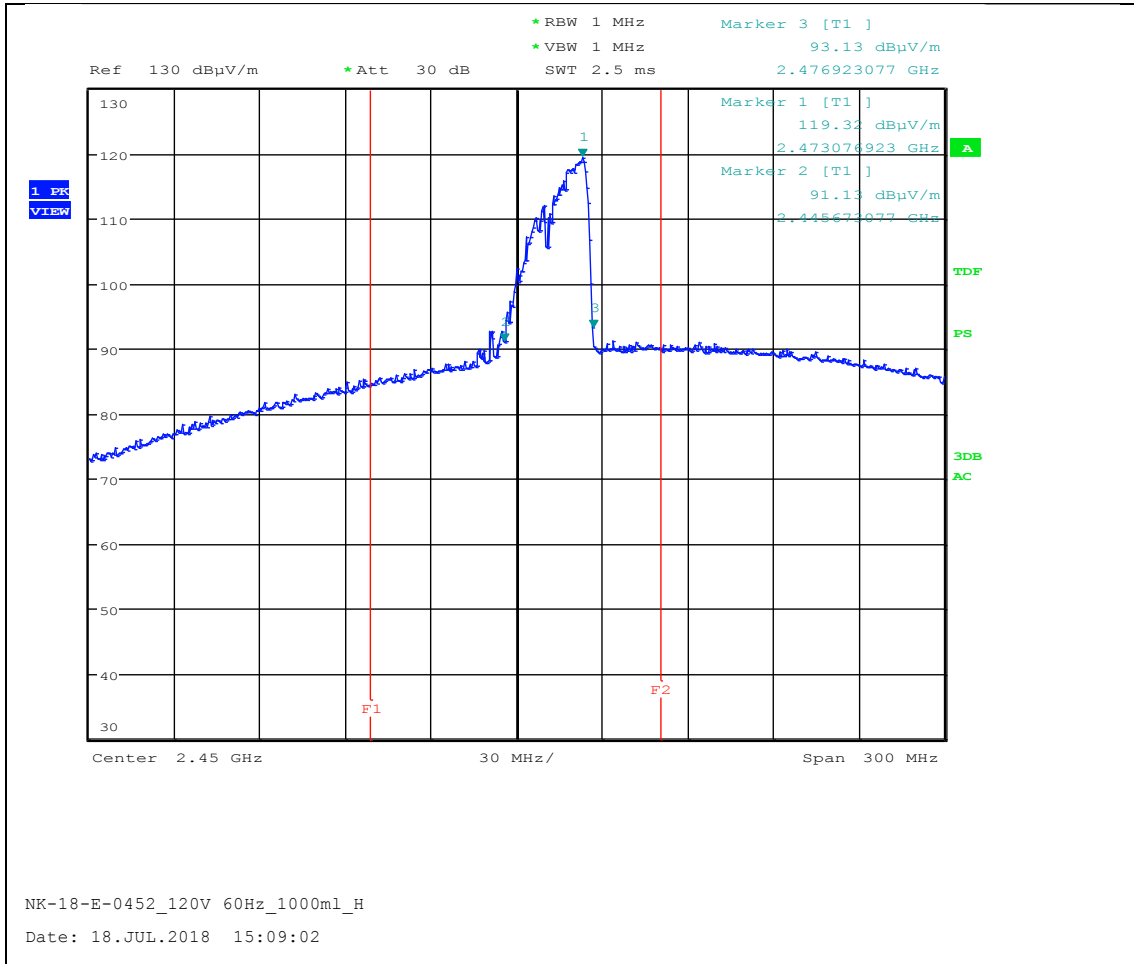

Horizontal (120 V, 1000 ml)

PLOTS OF EMISSIONS

- **Frequency vs Load Variation Test**

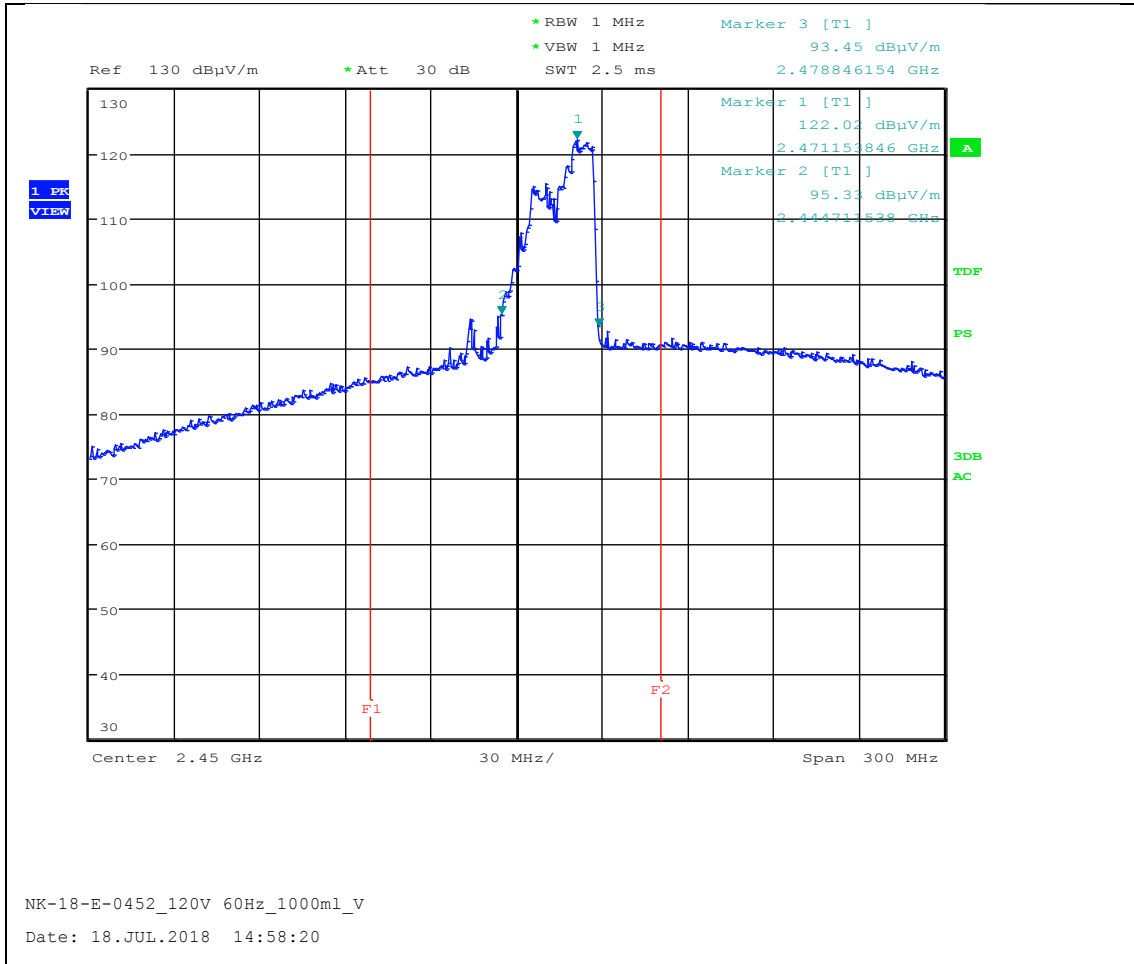

Vertical (120 V, 1000 ml)

ACCURACY OF MEASUREMENT

The Measurement Uncertainties stated were calculated in accordance with the requirements of measurement uncertainty contained in CISPR 16-4-2 with the confidence level of 95 %

1. Conducted Uncertainty Calculation

Source of Uncertainty	X_i	Uncertainty of X_i		Coverage factor k	$u(X_i)$ (dB)	C_i	$C_i u(X_i)$ (dB)
		Value (dB)	Probability Distribution				
Measurement System Repeatability	R_s	0.24	normal 1	1.00	0.24	1	0.24
Receiver reading	R_i	± 0.02	normal 2	2.00	0.01	1	0.01
Attenuation AMN-Receiver	L_c	± 0.10	rectangular	$\sqrt{3}$	0.06	1	0.06
AMN Voltage division factor	L_{AMN}	± 0.09	normal 2	2.00	0.05	1	0.05
Sine wave voltage	dV_{SW}	± 0.17	normal 2	2.00	0.09	1	0.09
Pulse amplitude response	dV_{PA}	± 0.92	normal 2	2.00	0.50	1	0.50
Pulse repetition rate response	dV_{PR}	± 0.35	normal 2	2.00	0.18	1	0.18
Noise floor proximity	dV_{NF}	± 0.00	rectangular	$\sqrt{3}$	0.00	1	0.00
AMN Impedance	d_z	± 2.00	normal 2	2.00	1.00	1	1.00
Mismatch : AMN-Receiver	M	+ 0.80 - 0.89	U-Shaped	$\sqrt{2}$	0.60	1	0.60
Remark	Using 50 Ω / 50 μ H AMN						
Combined Standard Uncertainty	Normal			uc = 1.30 dB			
Expanded Uncertainty U	Normal (k = 2)			U = 2.6 dB (CL is 95 %)			

2. Radiation Uncertainty Calculation (Below 1 GHz)

Source of Uncertainty	X_i	Uncertainty of X_i		Coverage factor k	$u(X_i)$ (dB)	C_i	$C_i u(X_i)$ (dB)
		Value (dB)	Probability Distribution				
Measurement System Repeatability 1)	R_s	0.15	normal 1	1.00	0.15	1	0.15
Receiver reading 2)	R_i	± 0.02	normal 2	2.00	0.01	1	0.01
Sine wave voltage 3)	dV_{sw}	± 0.17	normal 2	2.00	0.09	1	0.09
Pulse amplitude response 4)	dV_{pa}	± 0.92	normal 2	2.00	0.46	1	0.46
Pulse repetition rate response 5)	dV_{pr}	± 0.35	normal 2	2.00	0.18	1	0.18
Noise floor proximity 6)	dV_{nf}	± 0.50	normal 2	2.00	0.25	1	0.25
Antenna Factor Calibration 7)	A_F	± 1.50	rectangular	$\sqrt{3}$	0.87	1	0.87
Cable Loss 8)	C_L	± 1.00	normal 2	2.00	0.50	1	0.50
Antenna Directivity 9)	A_D	± 0.00	rectangular	$\sqrt{3}$	0.00	1	0.00
Antenna Factor Height Dependence 10)	A_H	± 2.00	rectangular	$\sqrt{3}$	1.15	1	1.15
Antenna Phase Centre Variation 11)	A_P	± 0.20	rectangular	$\sqrt{3}$	0.12	1	0.12
Antenna Factor Frequency Interpolation 12)	A_i	± 0.25	rectangular	$\sqrt{3}$	0.14	1	0.14
Site Imperfections 13)	S_i	± 4.00	triangular	$\sqrt{6}$	1.63	1	1.63
Measurement Distance Variation 14)	D_v	± 0.60	rectangular	$\sqrt{3}$	0.35	1	0.35
Antenna Balance 15)	D_{bal}	± 0.90	rectangular	$\sqrt{3}$	0.52	1	0.52
Cross Polarisation 16)	D_{Cross}	± 0.00	rectangular	$\sqrt{3}$	0.00	1	0.00
Mismatch 17)	M	+ 0.98 - 1.11	U-Shaped	$\sqrt{2}$	0.74	1	0.74
EUT Volume Diameter 18)	V_d	0.33	normal 1	1.00	0.33	1	0.11
Combined Standard Uncertainty	Normal			$u_c = 2.53$ dB			
Expanded Uncertainty U	Normal ($k = 2$)			5.1 dB (CL is 95 %)			

3. Radiation Uncertainty Calculation (Above 1 GHz)

Source of Uncertainty	X_i	Uncertainty of X_i		Coverage factor k	$u(X_i)$ (dB)	C_i	$C_i u(X_i)$ (dB)
		Value (dB)	Probability Distribution				
Measurement System Repeatability 1)	R_s	0.25	normal 1	1.00	0.25	1	0.25
Receiver Reading 2)	R_i	± 0.27	normal 2	2	0.14	1	0.14
Attenuation (antenna-receiver) 3)	a_c	± 0.30	normal 2	2	0.15	1	0.15
Preamplifier gain 4)	G_p	± 0.23	normal 2	2	0.12	1	0.12
Receiver Sine Wave 5)	dV_{sw}	± 0.17	normal 2	2	0.08	1	0.08
Instability of preamp gain 6)	dG_p	± 1.2	rectangular	$\sqrt{3}$	0.70	1	0.70
Noise Floor Proximity 7)	dV_{nf}	± 0.70	rectangular	$\sqrt{3}$	0.40	1	0.40
Antenna Factor Calibration 8)	A_F	± 2.0	normal 2	2	1.00	1	1.00
Directivity difference 9)	DF_{dir}	± 1.00	rectangular	$\sqrt{3}$	0.58	1	0.58
Phase Centre location 10)	A_P	± 0.30	rectangular	$\sqrt{3}$	0.17	1	0.17
Antenna Factor Frequency Interpolation 11)	A_i	± 0.30	rectangular	$\sqrt{3}$	0.17	1	0.17
Site Imperfections 12)	S_i	± 3.00	triangular	$\sqrt{6}$	1.22	1	1.22
Effect of setup table material 13)	dA_{NT}	± 1.50	rectangular	$\sqrt{3}$	0.87	1	0.87
Separation distance 14)	d_b	± 0.30	rectangular	$\sqrt{3}$	0.17	1	0.17
Cross Polarization 15)	D_{Cross}	± 0.00	rectangular	$\sqrt{3}$	0.00	1	0.00
Table height 16)	d_h	± 0.00	normal 2	2	0.00	1	0.00
Mismatch (antenna-Preamplifier) 17)	M	+ 1.30 - 1.50	U-Shaped	$\sqrt{2}$	1.00	1	1.00
Mismatch (preamplifier-receiver) 18)	M	+ 1.20 - 1.40	U-Shaped	$\sqrt{2}$	0.92	1	0.92
Combined Standard Uncertainty	Normal			$u_c = 2.51$ dB			
Expanded Uncertainty U	Normal ($k = 2$)			$U = 5.0$ dB (CL is 95 %)			

LIST OF TEST EQUIPMENT

No.	Instrument	Manufacturer	Model	Serial No.	Due to Calibration	Calibration Interval
1	LOOP ANTENNA	ROHDE & SCHWARZ	HFH2-Z2	100279	Feb. 13 2019	2 years
2	Microwave survey meter	ETS Lindgren	1501	00033549	Feb. 20 2019	2 year
3	EMI Test Receiver	ROHDE & SCHWARZ	ESCI	101041	Apr. 03 2019	1 year
4	Software	ROHDE & SCHWARZ	EMC32	Version 8.53.0	-	-
5	ARTIFICIAL MAINS NETWORK	ROHDE & SCHWARZ	ESH2-Z5	100273	Apr. 03 2019	1 year
6	EMI TEST RECEIVER	ROHDE & SCHWARZ	ESW8	100994	Apr. 03 2019	1 year
7	ATTENUATOR	FAIRVIEW	SA3N5W-10	N/A	Apr. 04 2019	1 year
8	EMI Test Receiver	ROHDE & SCHWARZ	ESU 40	100202	May. 24 2019	1 year
9	Software	ROHDE & SCHWARZ	EMC32	Version 10.10.01	-	-
10	TRILOG Broadband Test Antenna	SCHWARZBECK	VULB 9163	9163-01027	Jan. 31 2020	2 year
11	ATTENUATOR	FAIRVIEW	SA3N5W-06	N/A	Jan. 09 2019	1 year
12	Controller	innco systems GmbH	CO2000-G	CO2000/562/23890210/L	N/A	N/A
13	Open Switch and Control Unit	ROHDE & SCHWARZ	OSP-120	100015	N/A	N/A
14	Antenna Mast (Left)	innco systems GmbH	MA4000-EP	N/A	N/A	N/A
15	Turn Table	innco systems GmbH	DT3000-3T	N/A	N/A	N/A
16	Signal Conditioning Unit	ROHDE & SCHWARZ	SCU 01	10030	Apr. 03 2019	1 year
17	Signal Conditioning Unit	Rohde & Schwarz	SCU 18	10065	Apr. 02 2019	1 year
18	DOUBLE RIDGED HORN ANTENNA	SCHWARZBECK	HF907	102585	Jan.18 2019	2 year
19	SWITCH AND POWER DETECTOR UNIT	ROHDE & SCHWARZ	OSP-120	101766	N/A	N/A
20	TILT ANTENNA MAST	innco systems GmbH	MA4640-XP-EP	N/A	N/A	N/A
21	CONTROLLER	innco systems GmbH	CO3000	CO3000/937/38330516/L	N/A	N/A
22	Turntable	innco systems GmbH	DT2000-2t	N/A	N/A	N/A
23	WiFi Filter Bank	ROHDE & SCHWARZ	U082	N/A	N/A	N/A
24	Band Reject	wainwright Instruments GmbH	RCJV8-2350-2400-2500-2550-40SS	2	N/A	N/A

APPENDIX A – SAMPLE LABEL

Labeling Requirements

The sample label shown shall be *permanently affixed* at a conspicuous location on the device and be readily visible to the user at the time of purchase.

SHARP. MODEL NO.: SMO1854DS POWER INPUT 120V 60Hz AC ONLY, 1.7 KW POWER OUTPUT 1100W, 2450MHZ SINGLE PHASE WITH GROUNDING. SERIAL NO.: MANUFACTURED:	HOUSEHOLD MICROWAVE OVEN	FCC ID: C5F7NF1JMO110N MADE IN CHINA
		 DHHS CODE: H7NF DISTRIBUTED BY: SHARP ELECTRONICS CORPORATION 100 Paragon Drive, Suite #100 Montvale, NJ 07645

HOUSEHOLD MICROWAVE OVEN / HOGAR MICROONDAS		MODEL/MODELO: KOT-1J0U
INPUT / INPUT : 1700W OUTPUT / SALIDA : 1100W 120V AC 60Hz	WINIADAEWO Electronics America, Inc. 65 Challenger Rd, Suite 360, Ridgefield Park, NJ 07660 USA	
SERIAL NO. / NUMERO DE ORDEN:		FCC ID : C5F7NF1JMO110N
PRODCUTION DATE / FECHA DE FABRICACIÓN :		DHHS CODE NO : H7NF
PLACE OF MANUFACTURE / LUGAR DE FABRICACIÓN: TIANJIN, CHINA		

● **FCC ID Location of EUT**

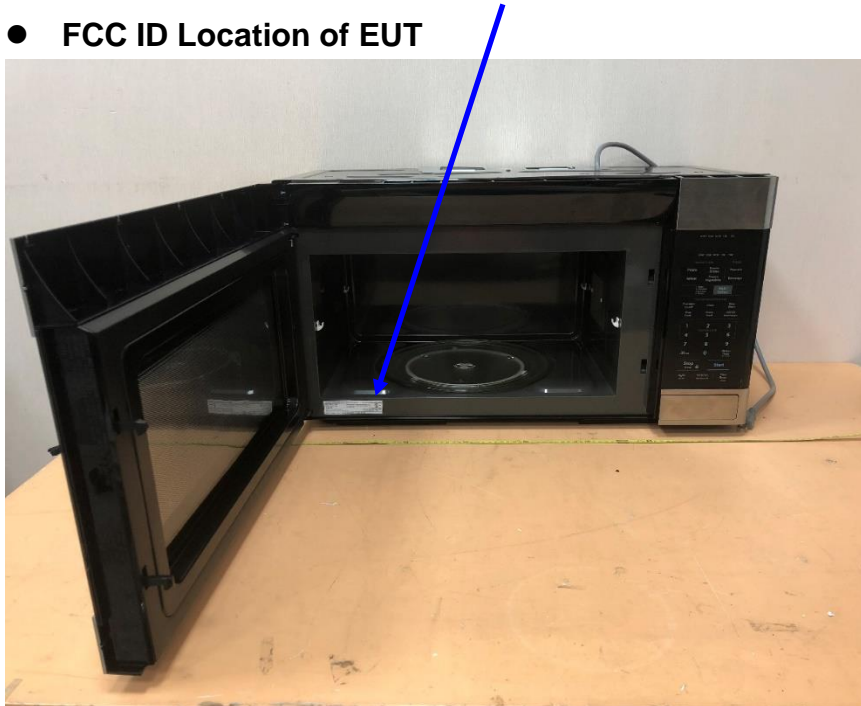

APPENDIX B – PHOTOGRAPHS OF TEST SET-UP

The **Conducted Test Picture** and **Radiated Test Picture** and show the worst-case configuration and cable placement.

- **Radiation hazard Test Picture**



- **Frequency measurement Test Picture**

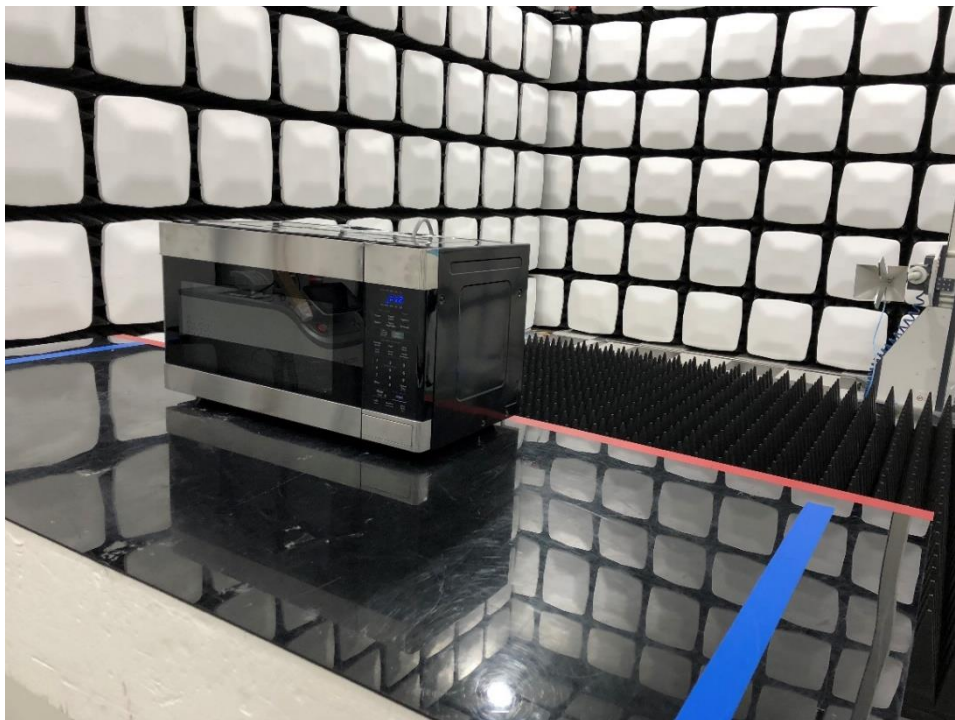

● **Conducted Test Picture (Front)**



● **Conducted Test Picture (Side)**



● Radiated Test Picture : 0.15 MHz ~ 30 MHz (Front)

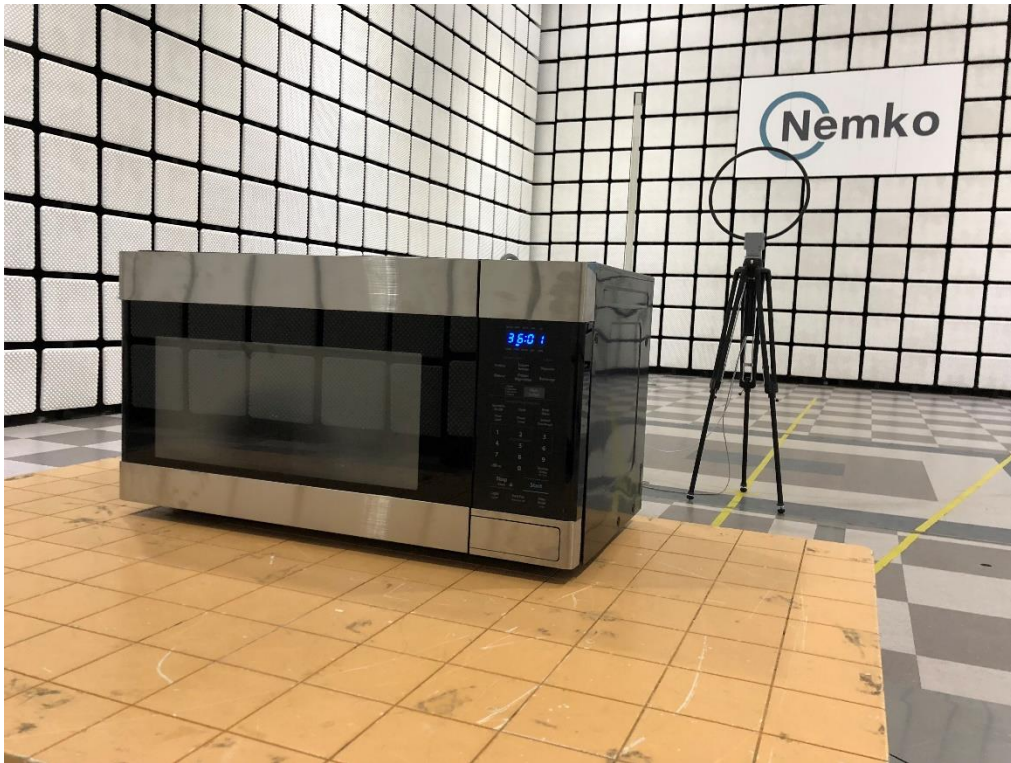

● Radiated Test Picture : 0.15 MHz ~ 30 MHz (Rear)



● Radiated Test Picture : 30 MHz ~ 1 GHz (Front)



● Radiated Test Picture : 30 MHz ~ 1 GHz (Rear)



● Radiated Test Picture : 1 GHz ~ 18 GHz (Front)

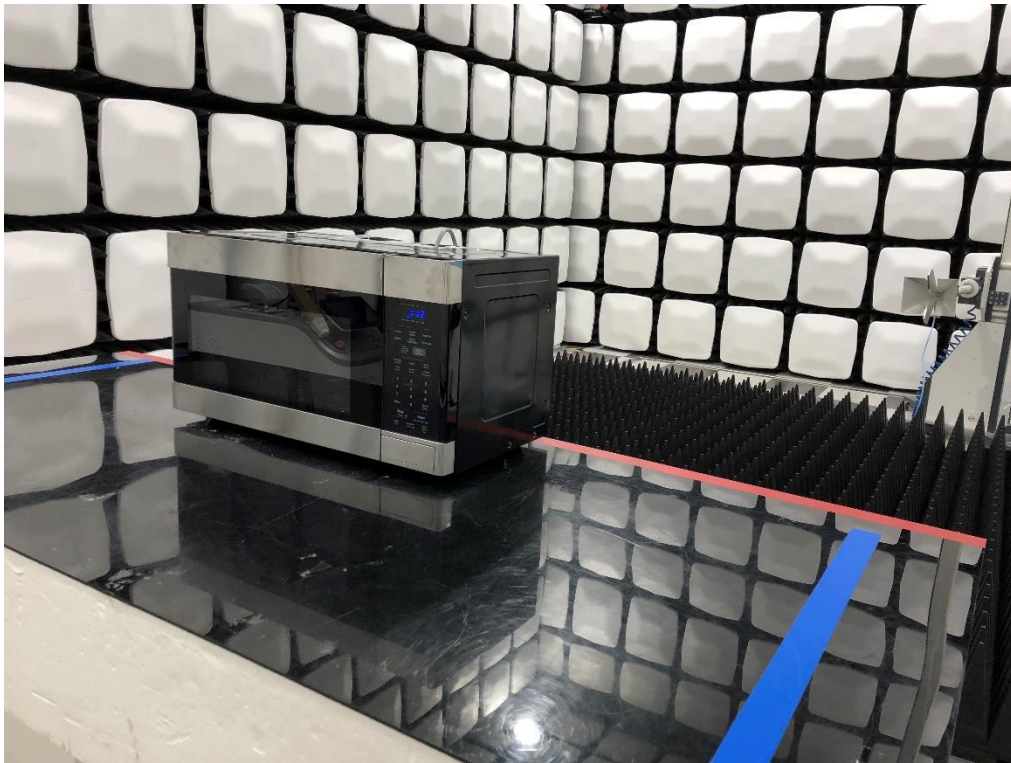

● Radiated Test Picture : 1 GHz ~ 18 GHz (Rear)

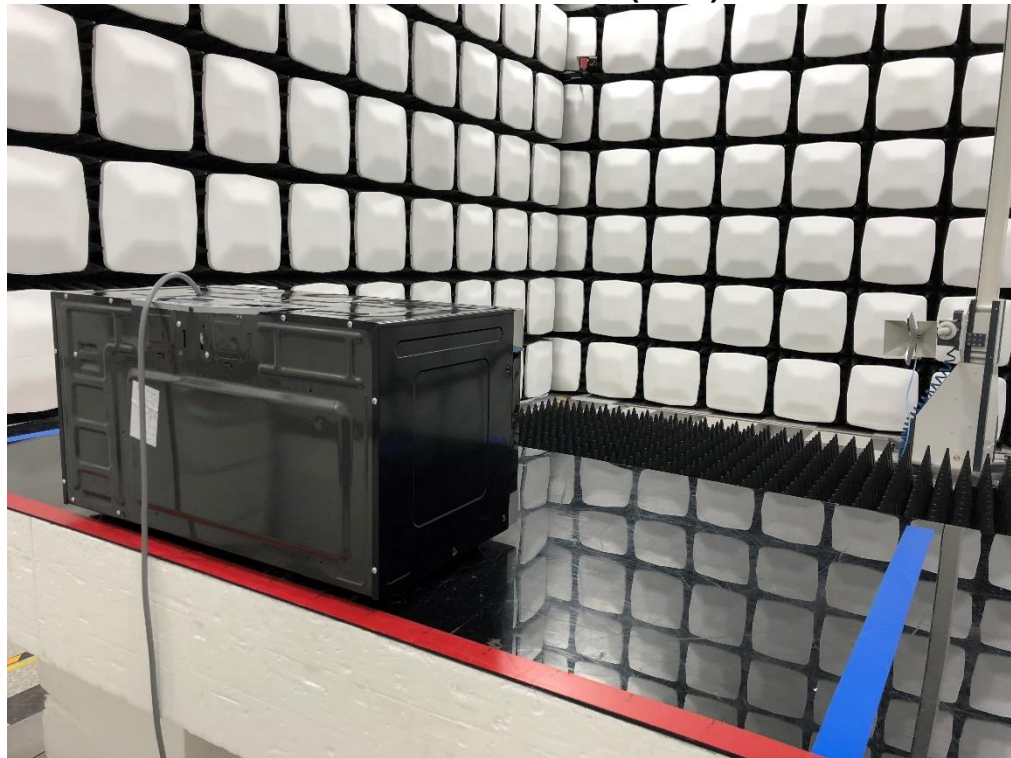

APPENDIX C – EUT PHOTOGRAPHS

► **Front View of EUT**



► Rear View of EUT



► Inside View of EUT

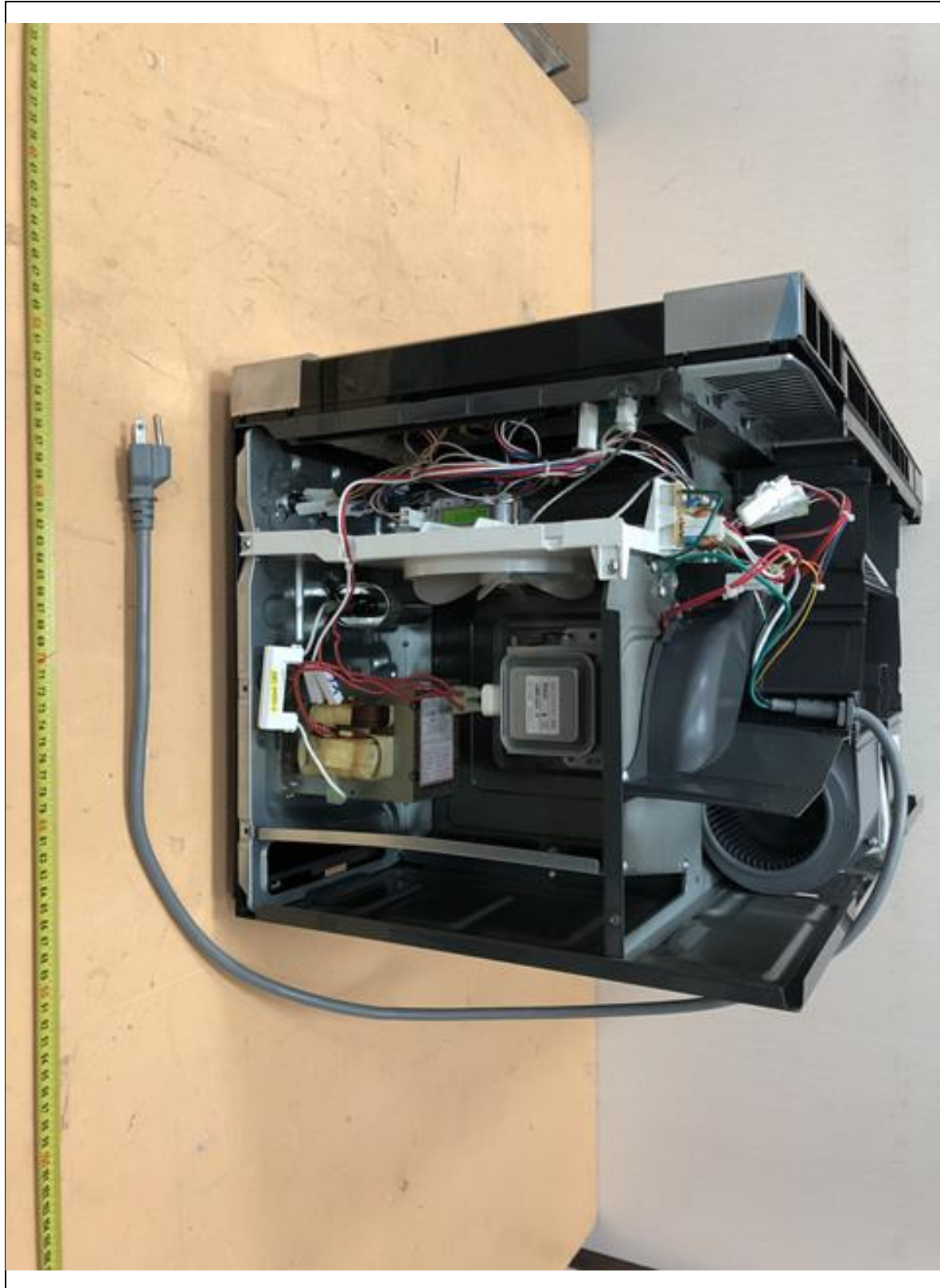

► Front View of Magnetron



► Rear View of Magnetron

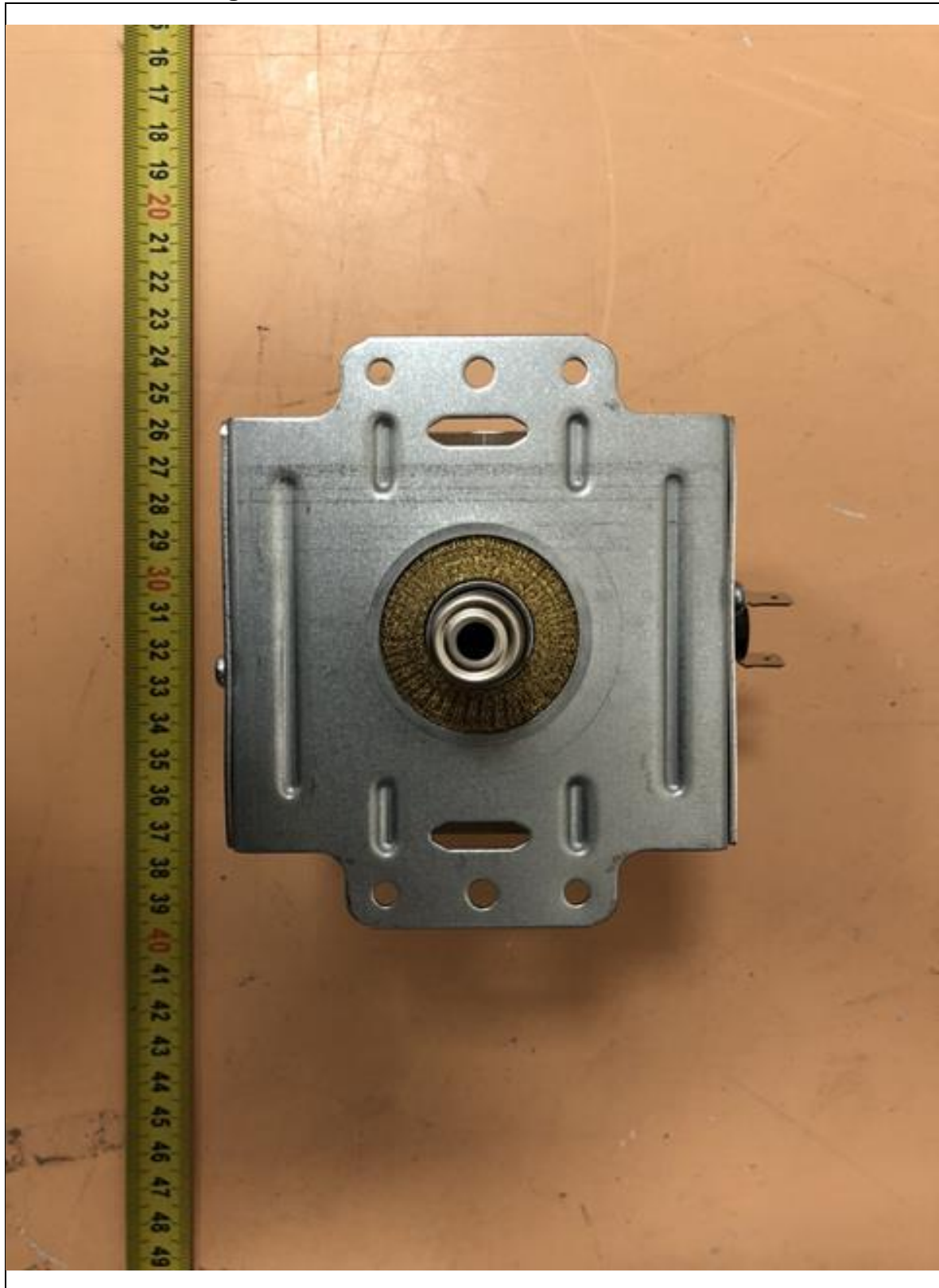

► Front View of Thermally Protected L. Air Over



► Rear View of Thermally Protected L. Air Over



► Front View of Synchronous Motor



► Rear View of Synchronous Motor



► Front View of FAN MOTOR



▶ Rear View of FAN MOTOR



► Front View of Diode H.V.



▶ Rear View of Diode H.V.



► Front View of Trans H.V



► Rear View of Trans H.V



► Front View of H.V. CAPACITOR



▶ Rear View of H.V. CAPACITOR



► Front View of Noise Filter

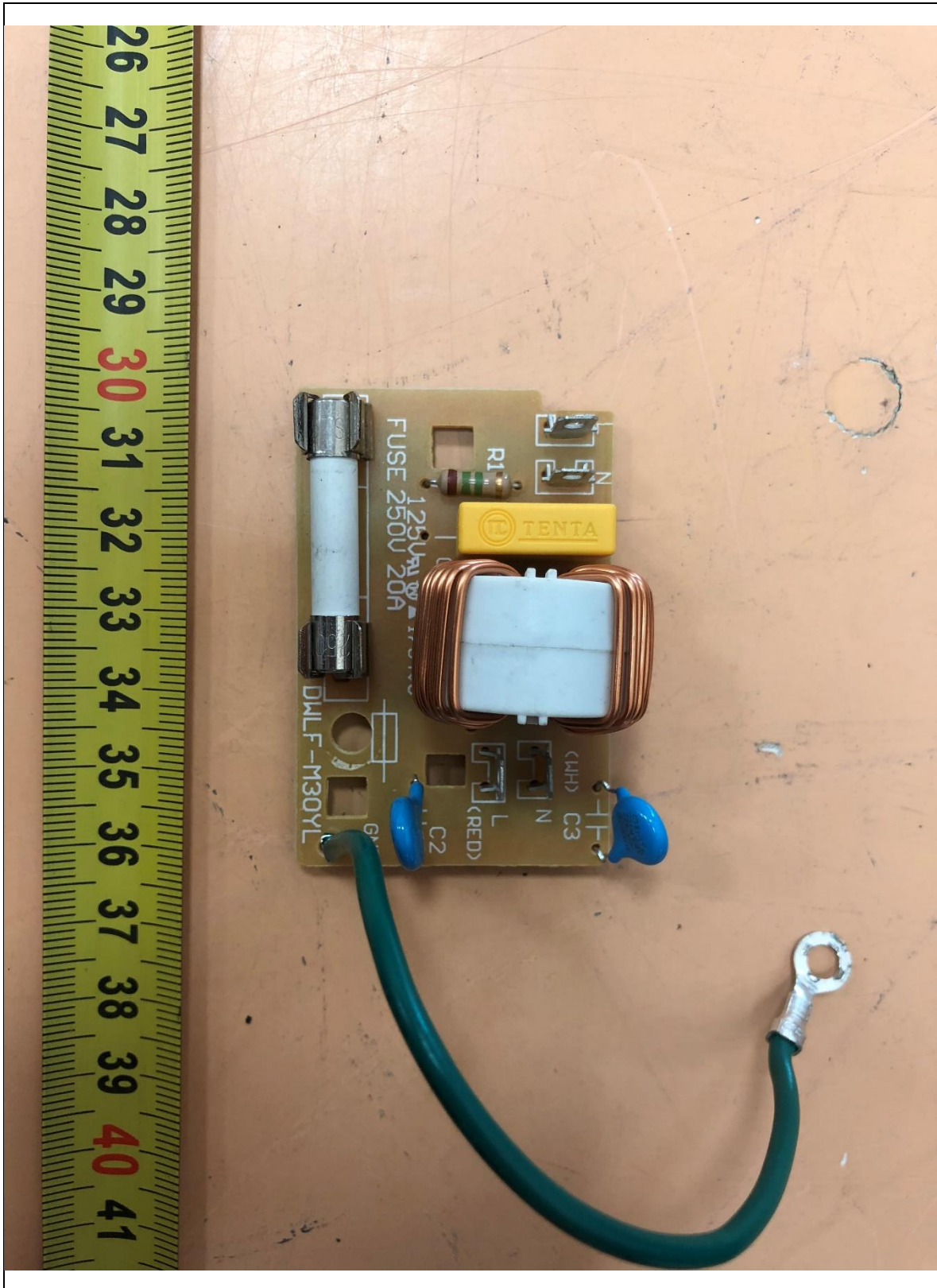

▶ Rear View of Noise Filter

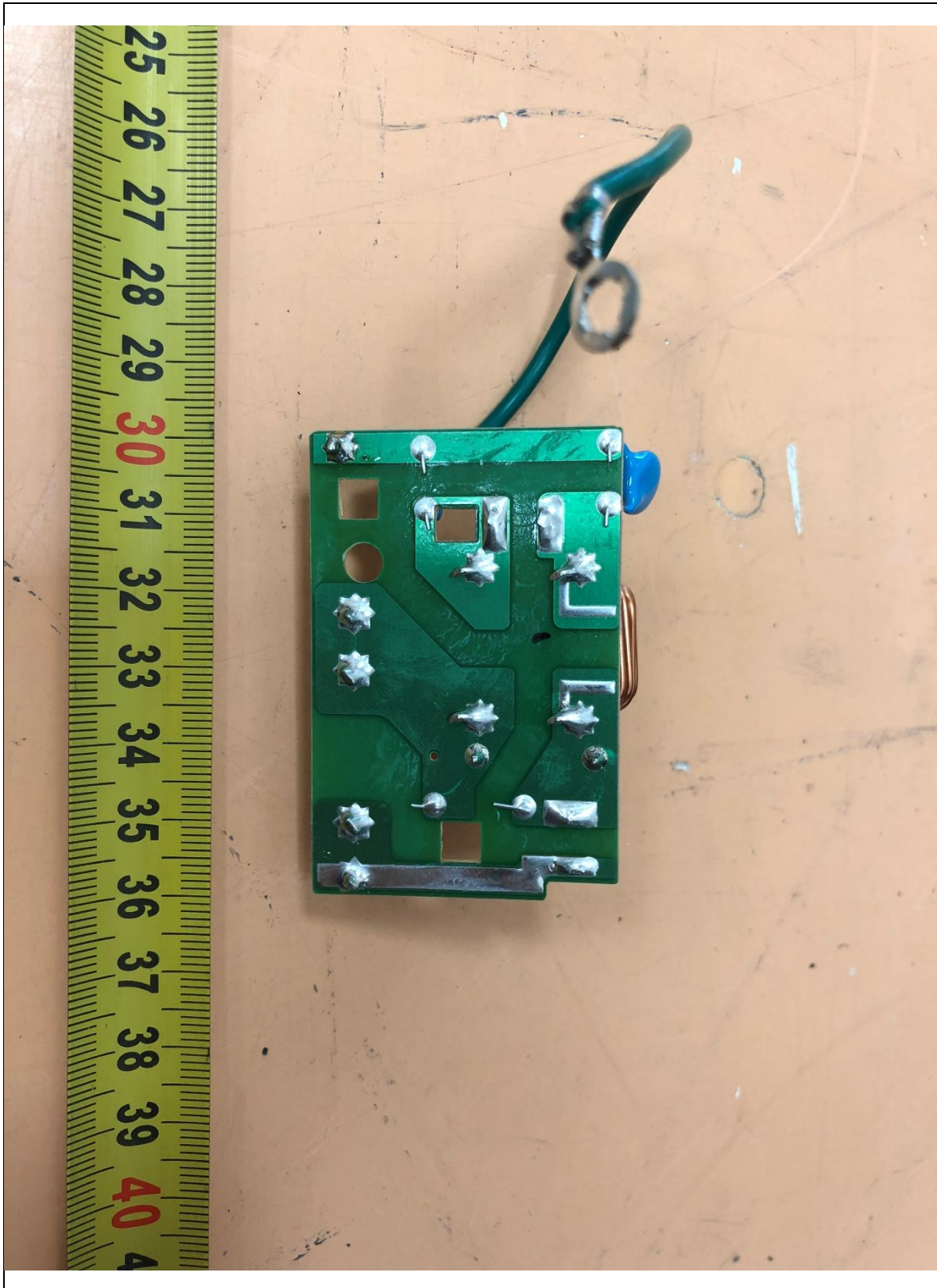

► Rear View of Main Board



APPENDIX D – SCHEMATIC DIAGRAM

APPENDIX E – USER'S MANUAL

APPENDIX F – BLOCK DIAGRAM
