

**DAEWOO**

# MICROWAVE OVEN

**KOR-1A1G**

OPERATING  
INSTRUCTIONS

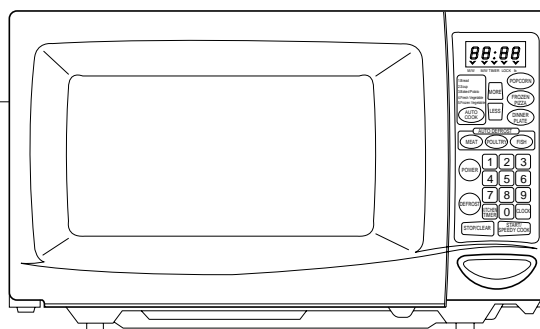

Before operating this oven, please read these instructions completely.

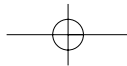

## PRECAUTIONS TO AVOID POSSIBLE EXPOSURE TO EXCESSIVE MICROWAVE ENERGY

- (a) Do not attempt to operate this oven with the door open since open-door operation can result in harmful exposure to microwave energy. It is important not to defeat or tamper with the safety interlocks.
- (b) Do not place any object between the oven front face and the door or allow soil or cleaner residue to accumulate on sealing surfaces.
- (c) Do not operate the oven if it is damaged.  
It is particularly important that the oven door close properly and that there is no damage to the: (1) door (bent), (2) hinges and latches (broken or loosened), (3) door seals and sealing surfaces.
- (d) The oven should not be adjusted or repaired by anyone except properly qualified service personnel.

## TABLE OF CONTENTS

PRECAUTIONS .....	1
IMPORTANT SAFETY INSTRUCTIONS .....	2
FEDERAL COMMUNICATIONS COMMISSION RADIO FREQUENCY INTERFERENCE STATEMENT (U.S.A ONLY) .....	3
GROUNDING INSTRUCTIONS .....	3
INSTALLATION .....	4
SPECIFICATIONS .....	5
FEATURES DIAGRAM .....	6
OPERATION PROCEDURE .....	8
CONTROLS .....	9
SETTING THE CLOCK .....	9
TIME DEFROSTING .....	9
WEIGHT DEFROSTING .....	10
COOKING IN ONE STAGE .....	11
COOKING IN TWO STAGES .....	11
KITCHEN TIMER MODE .....	12
SPEEDY COOK .....	13
ONE TOUCH COOKING .....	13
AUTO COOK .....	14
LESS, MORE .....	15
CHILD SAFETY LOCK .....	15
TO STOP THE OVEN WHILE THE OVEN IS OPERATING .....	15
UTENSIL TEST .....	16
MICROWAVE UTENSILS .....	16
CARE OF YOUR MICROWAVE OVEN .....	17
USE YOUR MICROWAVE OVEN SAFELY .....	18
BEFORE YOU CALL FOR SERVICE .....	19
QUESTIONS AND ANSWERS .....	19

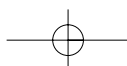

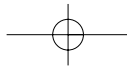

## IMPORTANT SAFETY INSTRUCTIONS

When using electrical appliances, basic safety precautions should be followed, including the following:

**WARNING-**To reduce the risk of burns, electric shock, fire, injury to persons or exposure to excessive microwave energy:

1. Read all instructions before using the appliance.
2. Read and follow the specific "PRECAUTIONS TO AVOID POSSIBLE EXPOSURE TO EXCESSIVE MICROWAVE ENERGY" found on page 1.
3. This appliance must be grounded. Connect only to properly grounded outlet. See "GROUNDING INSTRUCTIONS" found on page 3.
4. Install or locate this appliance only in accordance with the provided installation instructions.
5. Some products such as whole eggs and sealed containers - for example, closed glass jars-may explode and should not be heated in this oven.
6. Use this appliance only for its intended use as described in this manual. Do not use corrosive chemicals or vapors in this appliance. This type of oven is specifically designed to heat, cook, or dry food. It is not designed for industrial or laboratory use.
7. As with any appliance, close supervision is necessary when used by children.
8. Do not operate this appliance if it has a damaged cord or plug, if it is not working properly, or if it has been damaged or dropped.
9. This appliance should be serviced only by qualified service personnel. Contact nearest authorized service facility for examination, repair or adjustment.
10. Do not cover or block any openings on the appliance.
11. Do not store this appliance outdoors. Do not use this product near water — for example, near a kitchen sink, in a wet basement, or near a swimming pool, and the like.
12. Do not immerse cord or plug in water.
13. Keep cord away from heated surfaces.
14. Do not let cord hang over edge of table or counter.
15. Either:
  - a) When cleaning surfaces of door and oven that comes together on closing the door, use only mild, non-abrasive soaps or detergents applied with a sponge or soft cloth , or
  - b) When separate cleaning instructions are provided, See door surface cleaning instructions on (page 17).
16. To reduce the risk of fire in the oven cavity:
  - a) Do not overcook food. Carefully attend appliance if paper, plastic, or other combustible materials are placed inside the oven to facilitate cooking.
  - b) Remove wire twist-ties from paper or plastic bags before placing bag in oven.
  - c) If materials inside the oven should ignite, keep oven door closed, turn oven off, and disconnect the power cord, or shut off power at the fuse or circuit breaker panel.
  - d) Do not use the cavity for storage purposes. Do not leave paper products, cooking utensils, or food in the cavity when not in use.
17. Do not use this microwave oven to heat corrosive chemicals (for example, sulfides and chlorides). Vapours from such corrosive chemicals may interact with the contact and springs of the safety interlock switches thereby rendering them inoperable.
18. Keep the waveguide cover clean at all times. Wipe the oven interior with a soft damp cloth after each use. If you leave grease or fat anywhere in the cavity it may overheat, smoke or even catch fire when next using the oven.
19. Never heat oil or fat for deep frying as you cannot control the temperature and doing so may lead to overheating and fire.
20. This device is to be serviced only by properly qualified service personnel. Consult the service manual for proper service procedures to assure continued compliance with the federal performance standard for microwave ovens and for precautions to be taken to avoid possible exposure to excessive microwave energy.

**SAVE THESE INSTRUCTIONS**

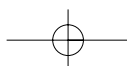

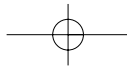

## FEDERAL COMMUNICATIONS COMMISSION RADIO FREQUENCY INTERFERENCE STATEMENT (U.S.A ONLY)

### **WARNING:**

This equipment generates and uses ISM frequency energy and if not installed and used properly, that is in strict accordance with the manufacturer's instructions, may cause interference to radio and television reception.

It has been type-tested and found to comply with limits for an ISM equipment pursuant to part 18 of FCC rules, which are designed to provide reasonable protection against such interference in a residential installation.

However, there is no guarantee that interference will not occur in a particular installation.

If this equipment does cause interference to radio or television reception, which can be determined by turning the equipment off and on, the user is encouraged to try correct the interference by one or more of the followings.

- Reorient the receiving antenna of radio or television.
- Relocate the microwave oven with respect to the receiver.
- Move the microwave oven away from the receiver.
- Plug the microwave oven into a different outlet so that microwave oven and receiver are on different branch circuits.

THE MANUFACTURER is not responsible for any radio or TV interference caused by UNAUTHORIZED MODIFICATION to this microwave oven. It is the responsibility of the user to correct such interference.

## GROUNDING INSTRUCTIONS

This appliance must be grounded. In the event of an electrical short circuit, grounding plug reduces the risk of electric shock by providing an escape wire for electric current. This appliance is equipped with a cord having a grounding wire with a grounding plug. The plug must be plugged into an outlet that is properly installed and grounded.

**WARNING:** Improper use of the grounding can in a risk of electric shock.

Consult a qualified electrician or serviceman if the grounding instructions are not completely understood, or if doubt exists as to whether the appliance is properly grounded, and either:

- (1) If it is necessary to use an extension cord, use only a 3-wire extension cord that has a 3-blade grounding plug, and a 3-slot receptacle that will accept the plug on the appliance. The marked rating of the extension cord shall be equal to or greater than the electrical rating of the appliance, or
- (2) Do not use an extension cord, if the power supply cord is too short, have a qualified electrician or serviceman install an outlet near the appliance.

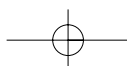

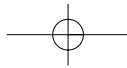

## INSTALLATION

### 1 Examine the oven after unpacking.

check for damage such as a misaligned door, broken door or dent in the cavity. If any damage is visible, DO NOT INSTALL, and notify your dealer immediately.

### 2 Level, flat location.

Install the microwave oven on a level, flat surface.

### 3 Ventilation

Do not block air vents. If they are blocked during operation, the oven may overheat and eventually cause a failure. For proper ventilation, allow 3 inches of space between oven top, sides, rear and adjacent surfaces.

### 4 Away from radio and TV sets

Poor television reception and radio interference may result if the oven is located close to a TV, radio, antenna, feeder, etc. Place the oven as far from them as possible.

### 5 Away from heating appliances and water taps

Keep the oven away from heat, steam or splashing liquids. These things can adversely affect oven wiring and contacts.

### 6 Power supply

This microwave oven requires a power supply of approximately 15 Amperes, 120 Volts, 60 Hz and a grounded outlet. A short power cord is provided to reduce the risk of the user becoming entangled in or tripping over a longer cord. Longer cord sets or extension cords are available and may be used if care is exercised.

If an extension cord is used, the marked electrical rating of the cord should be at least as great as the electrical rating of the oven.

The extension cord must be a grounding-type 3-wire cord. The longer cord should be arranged so it does not drape over the table top or counter where children can pull on it or trip over it.

### 7 The minimum height of free space necessary above the top surface of the oven is 100mm.

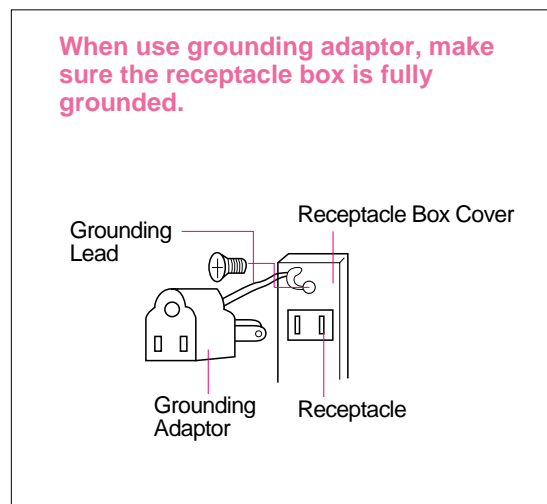
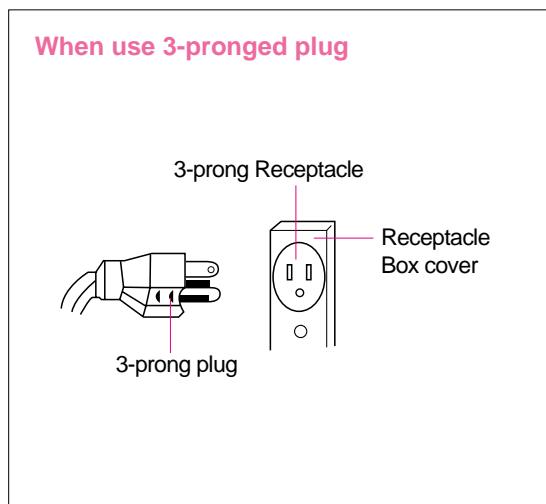

"THE CANADIAN ELECTRICAL CODE DOES NOT ALLOW THE USE OF THE GROUNDING ADAPTOR"

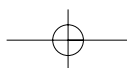

# SPECIFICATIONS

MODEL		KOR-1A1G	
POWER SUPPLY		120V AC 60 Hz SINGLE PHASE WITH GROUNDING	
MICROWAVE	POWER CONSUMPTION	1400 W	
	OUTPUT POWER	1000 W	
	FREQUENCY	2450 MHz	
OUTSIDE DIMENSIONS (W X H X D)		539 x 300 x 406 mm (21.2 x 11.8 x 16.0 in.)	
CAVITY DIMENSIONS (W X H X D)		354 x 228 x 373 mm (13.9 x 9.0 x 14.7 in.)	
NET WEIGHT		15.5KG (34.2 lbs.)	16.0KG (35.3 lbs.)
TIMER		99 min. 99 sec.	

\* Specifications are subject to change without notice.

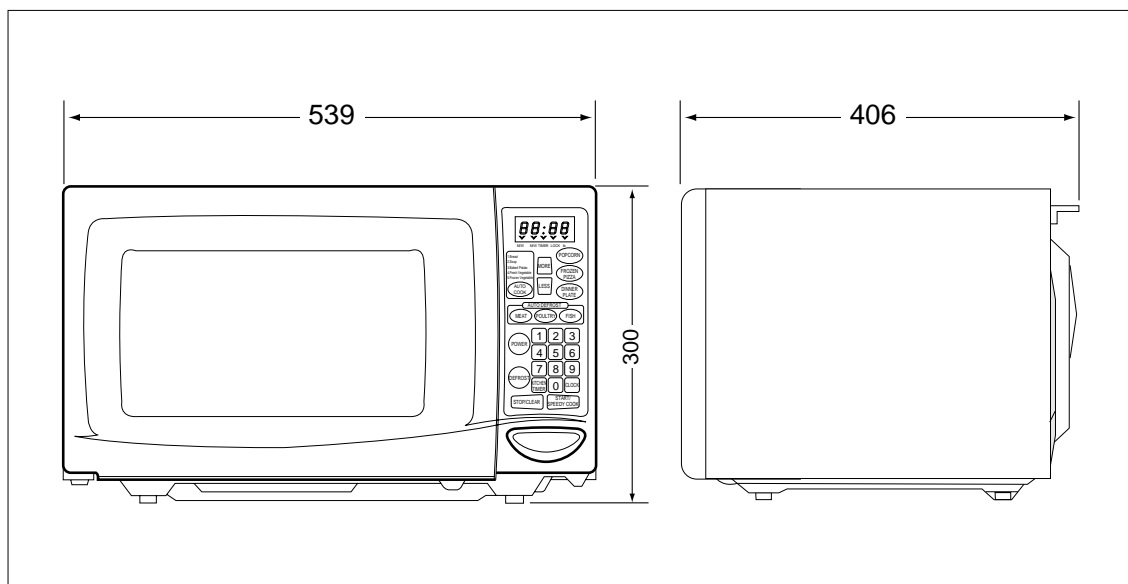

## FEATURES DIAGRAM

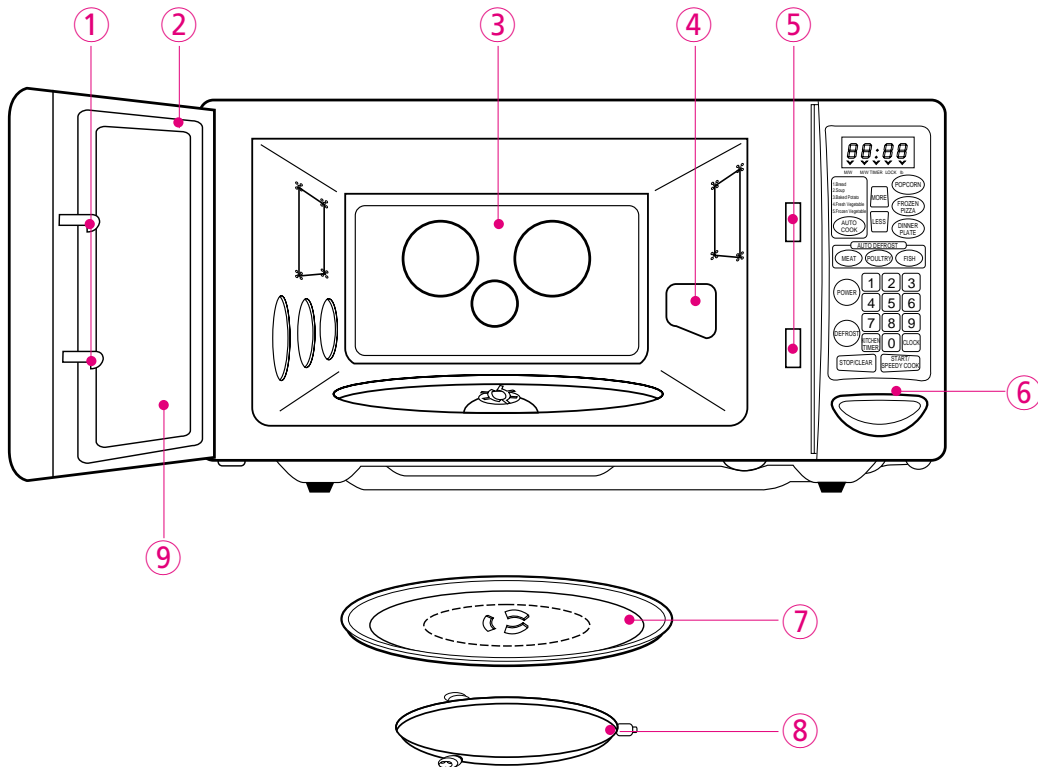

1. **Door latch** - When the door is closed it will automatically lock shut. If the door is opened while the oven is operating, the magnetron will automatically shut off.
2. **Door seal** - The door seal maintains the microwave within the oven cavity and prevents microwave leakage.
3. **Oven cavity**
4. **Spatter shield** - Protects the microwave outlet from splashes of cooking foods.
5. **Safety interlock system** - Prevents the oven from operating while the door is opened.
6. **Door release button** - Pushing this button stops oven operation and opens the door.
7. **Glass cooking tray** - Made of special heat resistant glass. The tray must always be in proper position before operating. Do not cook food directly on the tray.
8. **Roller guide** - Supports the glass cooking tray.
9. **Door screen** - Allows viewing of food. The screen is designed so that light can pass through, but not the microwaves.

## FEATURES DIAGRAM (continued)

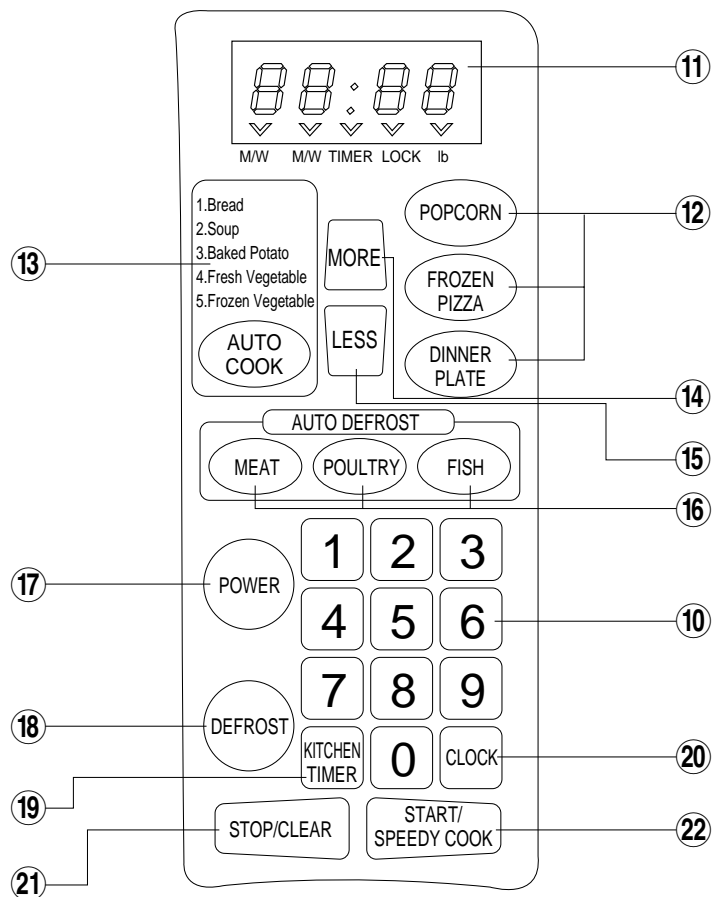

**10. Time set pad** - Used to set the cooking time and the present time.

**11. Display** - Cooking time, power level, indicators and present time are displayed.

**12. One touch** - Used to cook or reheat specific quantities of food.

**13. Auto cook** - Used to cook or reheat.

**14. More** - Used to add time to cooking.

**15. Less** - Used to remove time from cooking.

**16. Auto Defrost** - Used to defrost foods.(for weight)

**17. Power** - Used to set power level.

**18. Defrost** - Used to defrost foods.(for time)

**19. Kitchen Timer** - Used as a minute timer, delay cooking, hold setting after cooking.

**20. Clock** - Used to set clock.

**21. Stop/Clear** - Used to stop the oven operation or to delete the cooking data.

**22. Start /Speedy cook**- Used to start the oven and also used to set a reheat time.



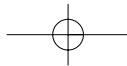

## OPERATION PROCEDURE

This section includes useful information about oven operation.

1. Plug power supply cord into a standard 3- pronged 15 Amp, 120V AC 60Hz power outlet.
2. After placing the food in a suitable container, open the oven door and put it on the glass tray.  
The glass tray and roller guide must always be in place during cooking.
3. Shut the door. Make sure that it is firmly closed.

- 1 The oven light is on when the microwave oven is operating or the door is opened.
- 2 The oven door can be opened at any time during operation by touching the door release button on the control panel. The oven will automatically shut off.
- 3 Each time a pad is touched, a BEEP will sound to acknowledge the touch.
- 4 The oven automatically cooks on full power unless set to a lower power level.
- 5 The display will show ":0" when the oven is plugged in.
- 6 Time clock returns to the present time when the cooking time ends.
- 7 When the STOP/CLEAR pad is touched during the oven operation, the oven stops cooking and all information retained.  
To erase all information (except the present time), touch the STOP/CLEAR pad once more. If the oven door is opened during the oven operation, all information is retained.
- 8 If the START pad is touched and the oven does not operate, check the area between the door and door seal for obstructions and make sure the door is closed securely.  
The oven will not start cooking until the door is completely closed or the program has been reset.

Make sure the oven is properly installed and plugged into the electrical outlet.

### WATTAGE OUTPUT CHART

- The power-level is set by pressing the POWER pad. The chart shows the display, the power level and the percentage of power.

Touch POWER pad	Power Level (Display)	Approximate Percentage of Power
once	P-HI	100%
twice	P-90	90%
3 times	P-80	80%
4 times	P-70	70%
5 times	P-60	60%
6 times	P-50	50%
7 times	P-40	40%
8 times	P-30	30%
9 times	P-20	20%
10 times	P-10	10%
11 times	P-00	0%

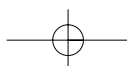

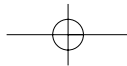

# CONTROLS

## SETTING THE CLOCK

When the oven is first plugged in, the display will flash ":0" and a tone will sound. If the AC power ever goes off, the display shows ":0" when the power comes back on.



1. Touch CLOCK pad.  
This is a 12 hour clock system.
2. Touch CLOCK pad once more.  
This is a 24 hour clock system.

**NOTE:** This oven has multiple clock system. If you want 12 hour clock system, omit this step.

3. Enter the correct time of day by touching the numbers in sequence.
4. Touch CLOCK pad.



The display stops blinking, and the colon start blinking. If you selected 12 hour clock system, this digital clock allows you to set from 1:00 to 12:59. If you selected 24 hour clock system, this digital clock allows you to set from 0:00 to 23:59.

**NOTE:** If you attempt to enter an incorrect time, the time will not be set and a error signal tone will sound. Touch the CLOCK pad and re-enter the time.

## TIME DEFROSTING

When TIME DEFROST is selected, the automatic cycle divides the defrosting time into periods of alternating defrost and stand times by cycling on and off.



1. Touch DEFROST pad.

The DEFROST indicator lights and " : 0" is displayed.

2. Touch number pads for the desired defrosting time.

The display will show the numbers you pressed in the order you touched.

3. Touch START pad.

**NOTE:** Your oven can be programmed for 99 minutes 99 seconds.(99:99)

When you touch START pad, the DEFROST indicator starts blinking to show the oven is in the DEFROST mode. The display counts down the time to show you how much defrosting time is left in the DEFROST mode. The oven beeps during the defrosting cycle to signal that the food needs to be turned or rearranged. When the defrosting time ends, you will hear 3 beeps.

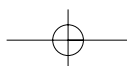

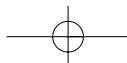

## WEIGHT DEFROSTING

WEIGHT DEFROSTING lets you easily defrost food by eliminating guesswork in determining defrosting time. Follow the steps below for easy defrosting.

- |             |                                      |  |
|-------------|--------------------------------------|--|
| <b>MEAT</b> | 1. Touch MEAT pad.                   | The DEFROST & lb indicator light and "1.0" is displayed. |
|             | 2. Select desired defrosting weight. | The display will show what you touched.                  |
|             | 3. Touch START pad.                  | MEAT DEFROSTING begins.                                  |

- |                |                                      |  |
|----------------|--------------------------------------|--|
| <b>POULTRY</b> | 1. Touch POULTRY pad.                | The DEFROST & lb indicator light and "1.5" is displayed. |
|                | 2. Select desired defrosting weight. | The display will show what you touched.                  |
|                | 3. Touch START pad.                  | POULTRY DEFROSTING begins.                               |

- |             |                                      |  |
|-------------|--------------------------------------|--|
| <b>FISH</b> | 1. Touch FISH pad.                   | The DEFROST & lb indicator light and "0.5" is displayed. |
|             | 2. Select desired defrosting weight. | The display will show what you touched.                  |
|             | 3. Touch START pad.                  | FISH DEFROSTING begins.                                  |

### \* WEIGHT DEFROST CHART

Touch pad	MEAT	POULTRY	FISH
once	1.0 lb	1.5 lb	0.5 lb
twice	1.5 lb	2.0 lb	1.0 lb
3 times	2.0 lb	2.5 lb	1.5 lb
4 times	2.5 lb	3.0 lb	2.0 lb

The defrosting time is automatically determined by the weight selected. The lb indicator goes off and the DEFROST indicator blinks and the defrosting time counts down in the display window. The oven beeps during the defrosting cycle to signal that the food needs to be turned or rearranged. When the defrosting time ends, you will hear 3 beeps.

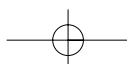

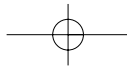

## COOKING IN ONE STAGE

**POWER**

X6

1. Touch POWER pad.  
(Select desired power level.)

The M/W indicator lights.  
The display will show what you touched.  
This example shows power level 5.

2. Touch the number pads for the cooking time.

**NOTE:** If steps 1 and 2 are omitted, the oven will cook at full power.

3. Touch START pad.

The display will show the numbers you pressed in the order you touched.

**NOTE:** Your oven can be programmed for 99 minutes 99 seconds.(99:99)

When you touch START pad, the M/W indicator starts blinking to show the oven is cooking. The display counts down the time to show how much cooking time is left. When the cooking time ends, you will hear 3 beeps.

**NOTE:** Using lower power levels increases the cooking time which is recommended for foods such as cheese, milk and slow cooking of meats.

## COOKING IN TWO STAGES

All recipes require frozen foods to be defrosted fully before cooking. This oven can be programmed to automatically defrost foods before cooking.

**DEFROST**

1. Touch DEFROST pad.

The DEFROST indicator lights and “ : 0” is displayed and the lb indicator starts blinking.

2. Touch number pads for the defrosting time you want.

The display will show the numbers you pressed in the order you touched.

**POWER**

X6

3. Touch POWER pad.  
(Select desired power level.)

The M/W indicator lights and “ P-HI” is The display will show what you touched. This example shows power level 5.

4. Touch number pads for desired cooking time.

5. Touch START pad.

The display will show the number you

When you touch START pad, the DEFROST and M/W indicators come on to confirm the power levels selected. The DEFROST indicator starts blinking to show you that the oven is in DEFROST mode. The display counts down the time remaining in DEFROST mode. When the oven beeps, turn over, break apart and/or redistribute the food. At the end of DEFROST mode, the oven will beep and start M/W cook. The DEFROST indicator goes off and the M/W indicator starts blinking. The display counts down the time remaining in M/W cook. When M/W cook ends, you will hear 3 beeps.

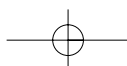

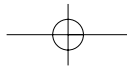



## KITCHEN TIMER MODE

Timer operates as a minute timer, can be set to delay cooking and used as a hold setting after cooking. However delay cooking can not be programmed for defrost. Timer operates without microwave energy.

### HOW TO USE AS A MINUTE TIMER

- |   |   |  |
|---|---|--|
|  | 1. Touch KITCHEN TIMER pad.                         | The KITCHEN TIMER indicator lights and “ : 0 ” is displayed.   |
|   | 2. Press the amount of time you want to count down. | The display will show the numbers you pressed in the order you touched.  |
|   | 3. Touch START pad.                                 | The display counts down the time remaining in KITCHEN TIMER mode. When KITCHEN TIMER mode ends, you will hear 3 beeps. |

### HOW TO USE TO DELAY THE START OF COOKING

- |   |  |   |
|---|--|---|
|  | 1. Touch KITCHEN TIMER pad.  | The KITCHEN TIMER indicator lights and “ : 0 ” is displayed.                    |
|   | 2. Press the amount of time you want to delay time.                        | The display will show the numbers you pressed in the order you touched.         |
|   | 3. Program the desired power level and cooking time for food to be cooked. | The kitchen timer will begin counting down to zero and cooking will then begin. |
|   | 4. Touch START pad.  |   |

### HOW TO USE TO SET A HOLDING TIME

- |   |  |   |
|---|--|---|
|  | 1. Program the desired defrosting time.                | The KITCHEN TIMER indicator lights and “ : 0 ” is displayed.            |
|   | 2. Touch KITCHEN TIMER pad.                            | The display will show the numbers you pressed in the order you touched. |
|   | 3. Press the amount of time you want the oven to hold. | Defrosting will start. After defrosting, stand time will count down.    |
|   | 4. Touch START pad.                                    |   |

**NOTE:** Your oven can be programmed for 99 minutes 99 seconds. (99:99)

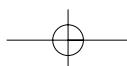

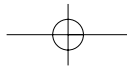

## SPEEDY COOK

SPEEDY COOK allows you to reheat for 30 seconds at 100% (full power) by simply touching the SPEEDY COOK pad.

By repeatedly touching the SPEEDY COOK pad, you can also extend reheating time to 5 minutes by 30 second increments.

**SPEEDY  
COOK**

1. Touch SPEEDY COOK pad.

When you touch SPEEDY COOK, ":30" is displayed.

After 1.5 seconds, the oven starts reheating.

## ONE TOUCH COOKING

One touch cook allows you to cook or reheat many of your favorite foods by touching just one pad. To increase quantity, touch chosen pad until number in display is same as desired quantity to cook. (except for POPCORN)

**POPCORN**

1. Remove plastic wrap. Follow manufacture's directions for placement and care in opening.
2. Touch POPCORN pad once for a 3.5 oz bag .

When you touch POPCORN pad once, "3.5" is displayed.

After the 1.5 seconds, the display shows the cooking time and the oven starts cooking.

- NOTE:**
1. Use prepackaged room-temperature microwave popcorn.
  2. Place bag in oven according to manufacturer's directions.
  3. Pop only one bag at a time.
  4. After popping, open bag carefully; popcorn and steam are extremely hot.
  5. Do not reheat unpopped kernels or reuse bag.
  6. Do not leave oven unattended while popping popcorn.

**CAUTION :** If prepackaged popcorn is of a different weight than the recommended weight, do not use the popcorn pad. Follow the manufacturer instruction.

**FROZEN  
PIZZA**

1. Follow package directions for preparation model.
2. Touch FROZEN PIZZA pad once for a 7 oz pizza or twice for a 14 oz pizza.

When you touch FROZEN PIZZA pad once, "7" is displayed.

After 1.5 seconds, the display shows the cooking time and the oven starts cooking.

**\* FROZEN PIZZA \***

- 7 oz : Touch FROZEN PIZZA once.
- 14 oz : Touch FROZEN PIZZA twice within 1.5 seconds.

- NOTE:**
1. Use only one frozen pizza at a time.
  2. Use only frozen pizza made for microwave ovens.
  3. If the cheese of frozen pizza does not melt sufficiently, cook a few seconds longer.
  4. Some brands of frozen pizza may required more or less cooking time.

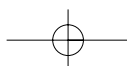

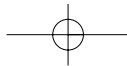

## ONE TOUCH COOKING (CONTINUED)

### DINNER PLATE

1. Put foods in the microwave plate. Cover with vented plastic wrap.
2. Touch DINNER PLATE pad once for an 12 oz dinner plate or twice for 15 oz of dinner plate.

When you touch DINNER PLATE pad once, "12" is displayed. After 1.5 seconds, the display shows the cooking time and the oven starts cooking.

#### \* DINNER PLATE \*

- 12 oz : Touch DINNER PLATE once.
- 15 oz : Touch DINNER PLATE twice within 1.5 seconds.

## AUTO COOK

Auto cook allows you to cook or reheat many of your favorite foods by repeatedly touching auto cook pad.

### AUTO COOK

1. Touch AUTO COOK pad.

When you touch AUTO COOK pad once, "AC-1" is displayed. By repeatedly touching this pad, you can select other food category as shown in the chart below.

CATEGORY	FOOD	WEIGHT	TOUCH PAD	DIRECTIONS
AC-1	BREAD	4slices	Touch AUTO COOK once	Place bread on a microwave dish.
AC-2	SOUP	12 oz	Touch AUTO COOK twice	Pour soup into microwave bowl or mug. Stir before serving.
AC-3	BAKED POTATO	3potatoes (7-8 oz. each)	Touch AUTO COOK three times	Wash and pierce potatoes with a fork. Place them on turntable.
AC-4	FRESH VEGETABLE	7 oz	Touch AUTO COOK four times	Trim and wash the mixed vegetables. Place them in the round dish. Add to 2 Tbsp. water.
AC-5	FROZEN VEGETABLE	7 oz. package	Touch AUTO COOK five times	Place the vegetables in the round dish. Add to 2Tbsp. water.

### START

2. Touch START pad.

When you touch START pad, the display changed into cooking time of quantity and the oven starts cooking.

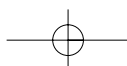

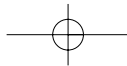

## LESS, MORE

---

To alter one touch cooking or cooking time whilst oven is in operation, use LESS or MORE. (except for defrosting) Press LESS/MORE to decrease/increase the one touch cooking time in multiples of 10 seconds.

The overall one touch cooking time can be increased to a maximum of 99 minutes 50 seconds.

Press LESS/MORE to decrease/increase the cooking time in multiples of 1 minute.

The overall cooking time can be increased to a maximum of 99 minutes.

---

## CHILD SAFETY LOCK

---

The safety lock prevents unwanted oven operation such as by small children.

To set, press and hold STOP/CLEAR for 3 seconds, LOCK indicator lights.

To cancel, press and hold STOP/CLEAR for 3 seconds, LOCK indicator goes off.

---

## TO STOP THE OVEN WHILE THE OVEN IS OPERATING

---

1. Press STOP/CLEAR pad.
  - You can restart the oven by touching START pad.
  - Touch STOP/CLEAR once more to erase all instructions.
  - You must enter in new instructions.
2. Open the door.
  - You can restart the oven by closing the door and touching START.

**NOTE:** Oven stops operating when door is opened.

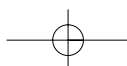



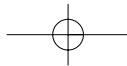

<b>UTENSIL TEST</b>	Dishes that do not absorb microwave energy are best for microwave cooking. Lock on the label to verify that particular cups, glasses, plates are indeed suitable, especially paper goods. If you are not sure, try this utensil test to check. <ul style="list-style-type: none"><li>• Put the empty utensil in the microwave oven.</li><li>• Put one cup of water in a glass measure next to the empty utensil.</li><li>• Heat on HI for 1 minute.</li><li>• After 1 minute the water should be warm but the utensil should not. If the utensil is warm, it is not suitable for microwave cooking.</li></ul>
---------------------	---

## MICROWAVE UTENSILS

### *Glass, Ceramic and China*

Ovenproof glass or ceramic baking dishes are the most used microwave utensils. Many of these items are readily available in most homes : glass measure, custard cups, mixing bowls, covered casseroles, pie plates and round or square cake dishes. Ovenproof dinner ware is usually safe to use in the microwave.

Do not heat or cook in glass jars or bottles.

Do not use dishes with silver, gold, platinum or other metal trim. Arcing may occur and /or the dish may break.

Do not use delicate or stemmed glassware. Although the glass may be transparent to microwave energy, heat from the food may cause the glassware to crack.

### *Plastics*

Plastic dishes, cups, mugs and bowls may be used in the oven for short periods of time. None of these should be used in the oven for prolonged periods because distortion and melting may occur. Check manufacturer's recommendations concerning microwave safety.

Plastic wrap can be used to cover dishes in most recipes if the dish is deep enough to avoid plastic wrap touching the food. Always vent the wrap by folding back one corner to allow excess steam to escape.

Plastic cooking bags should be slit before cooking so excess steam can escape. Do not use wire twist ties to close the bag. Wire twist ties can cause arcing which can damage the oven.

### *Paper*

Paper cups, wax paper, napkins, paper towels, and plates may be used for short cooking. Prolonged time in the oven can cause paper to burn. Do not use recycled paper products, such as brown paper bags. They contain impurities which may cause arcing and damage the oven.

### *Metal*

Metal utensils should not be used in the oven. Metal reflects microwave energy so foods will not cook evenly.

Metal can cause arcing and damage the oven.

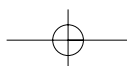

## CARE OF YOUR MICROWAVE OVEN

- 1 Turn the oven off before cleaning.
- 2 Keep the inside of the oven clean. When food spatters or spilled liquids adhere to oven walls, wipe with a damp cloth. Mild detergent may be used if the oven gets very dirty. The use of harsh detergent or abrasives is not recommended.
- 3 The outside oven surface should be cleaned with soap and water, rinsed and dried with a soft cloth. To prevent damage to the operating parts inside the oven, water should not be allowed to seep into the ventilation openings.
- 4 If the Control Panel becomes wet, clean with a soft, dry cloth. Do not use harsh detergents or abrasives on Control Panel.
- 5 If steam accumulates inside or around the outside of the oven door, wipe with a soft cloth. This may occur when the microwave oven is operated under high humidity conditions and in no way indicates malfunction of the unit.
- 6 It is occasionally necessary to remove the glass tray for cleaning. Wash the tray in warm sudsy water or in a dishwasher.
- 7 The roller guide and oven cavity floor should be cleaned regularly to avoid excessive noise. Simply wipe the bottom surface of the oven with mild detergent water or window cleaner and dry. The roller guide may be washed in mild sudsy water.

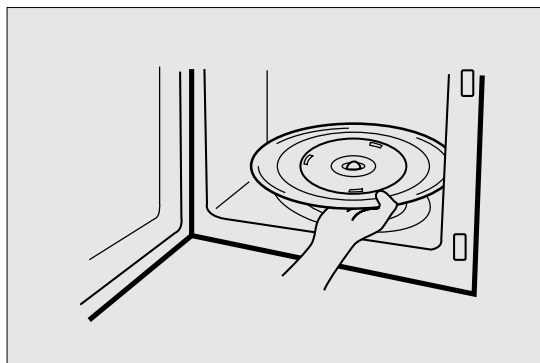

### ROLLER GUIDE

- 1 The ROLLER GUIDE and oven floor should be cleaned frequently to prevent excessive noise.
- 2 The ROLLER GUIDE MUST ALWAYS be used for cooking together with the Glass Tray.

### GLASS TRAY

- 1 DO NOT operate the oven without the Glass Tray in place.
- 2 DO NOT use any other Glass Tray with this oven.
- 3 If Glass Tray is hot, ALLOW TO COOL before cleaning or placing it in water.
- 4 DO NOT cook directly on the Glass Tray.

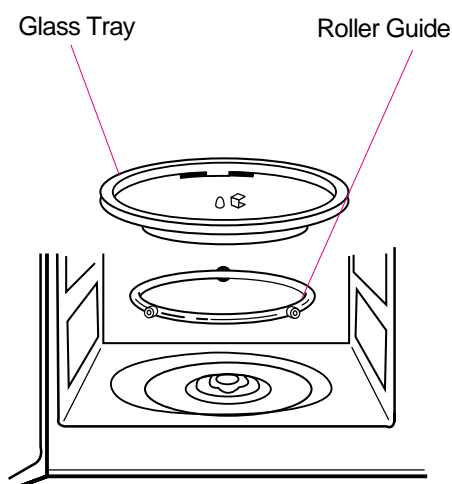

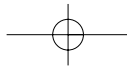

# USE YOUR MICROWAVE OVEN SAFELY

## GENERAL USE

Do not attempt to defeat or tamper with safety interlocks.

Do not place any object between the oven front frame and the door or allow residue to build up on sealing surfaces. Wipe with a mild detergent, rinse and dry. Never use abrasive powders or pads.

Do not subject the oven door strain or weight such as a child hanging on an open door. This could cause the oven to fall forward resulting in injury to you and damage to the oven.

Do not operate the oven if door seals or sealing surfaces are damaged; or if door is bent; or if hinges are loose or broken.

Do not operate the oven empty. This will damage the oven.

Do not attempt to dry clothes, newspapers or other materials in the oven. They may catch on fire.

Do not use recycled paper products as they may contain impurities which may cause sparks or fires.

Do not hit or strike the control panel with hard objects. This can damage the oven.

## FOOD

Never use your microwave oven for home canning. The oven is not designed for proper home canning. Improperly canned food may spoil and be dangerous to consume.

Always use the minimum recipe cooking time. It is better to undercook rather than over cook foods. Undercooked foods can be returned to the oven for more cooking. If food is overcooked, nothing can be done.

Heat small quantities of food or foods with low moisture carefully. These can quickly dry out, burn or catch on fire.

Do not heat eggs in the shell. Pressure may build up and eggs can explode.

Potatoes, apples, egg yolks and sausages are examples of food with non-porous skins. These must be pierced before cooking to prevent bursting.

Do not attempt to deep fat fry in your microwave oven.

Always stir liquids before heating. Heated liquids can erupt, if not mixed with air.

Do not leave the oven unattended while popping corn.

Do not pop popcorn in a paper bag unless it is the commercially prepared Microwave Popcorn product. The kernels can overheat and ignite a brown paper bag.

Do not put packaged Microwave Popcorn bags directly on the oven tray. Place the package on a microwave safe glass or ceramic plate to avoid overheating and cracking the oven tray.

Do not exceed the Microwave Popcorn manufacturers' suggested popping time. Longer popping does not yield more popcorn but it can result in scorch burn or fire. Remember, the popcorn bag and tray can be too hot to handle. Remove with caution and use pot holders.

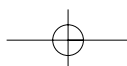

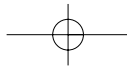

## BEFORE YOU CALL FOR SERVICE

Refer to following checklist, you may prevent an unnecessary service call.

- \* The oven doesn't work;
  1. Check that the power cord is securely plugged in.
  2. Check that the door is firmly closed.
  3. Check that the cooking time is set.
  4. Check for a blown circuit fuse or tripped main circuit breaker in your house.
- \* Sparking in the cavity;
  1. Check utensils. Metal containers or dishes with metal trim should not be used.
  2. Check that metal skewers or foil does not touch the interior walls.

If there is still a problem, contact the service station.  
A list of these stations is included in the oven.

**DO NOT ATTEMPT TO SERVICE THE OVEN YOURSELF!**

## QUESTIONS AND ANSWERS

- \* **Q** : I accidentally ran my microwave oven without any food in it. Is it damaged?  
**A** : Running the oven empty for a short time will not damage the oven.  
However, it is not recommended.
- \* **Q** : Can the oven be used with the glass tray or roller guide removed?  
**A** : No. Both the glass tray and roller guide must always be used in the oven before cooking.
- \* **Q** : Can I open the door when the oven is operating?  
**A** : The door can be opened anytime during the cooking operation. Then microwave energy will be instantly switched off and the time setting will maintain until the door is closed and START is touched.
- \* **Q** : Why do I have moisture in my microwave oven after cooking?  
**A** : The moisture on the side of your microwave oven is normal. It is caused by steam from cooking food hitting the cool oven surface.
- \* **Q** : Does microwave energy pass through the viewing screen in the door?  
**A** : No. The metal screen bounces back the energy to the oven cavity. The holes are made to allow light to pass through. They do not let microwave energy pass through.

