



SAR EVALUATION REPORT

Applicant Name:
Microsoft Corporation
One Microsoft Way
Redmond, WA 98052 USA

Date of Testing:
02/07/2024 - 04/05/2024
Test Site/Location:
Element Washington DC LLC,
Columbia, MD, USA
Document Serial No.:
1M2311170118-01.C3K(R1)

FCC ID: C3K2085

APPLICANT: MICROSOFT CORPORATION

DUT Type: Portable Computing Device
Application Type: Certification
FCC Rule Part(s): CFR §2.1093
Model(s): 2085

Equipment Class	Band & Mode	Tx Frequency	SAR		
			1g Laptop (W/kg)	1g Tablet (W/kg)	
DTS	2.4 GHz WIFI	2412 - 2472 MHz	<0.1	0.71	
NII	5 GHz WIFI	U-NII-1: 5180 - 5240 MHz U-NII-2A: 5260 - 5320 MHz U-NII-2C: 5500 - 5720 MHz U-NII-3: 5745 - 5825 MHz U-NII-4: 5845 - 5885 MHz	<0.1	0.67	
6CD	6 GHz WIFI	U-NII-5: 5935 - 6415 MHz U-NII-6: 6435 - 6515 MHz U-NII-7: 6535 - 6855 MHz U-NII-8: 6875 - 7115 MHz	<0.1	0.62	
DSS	2.4 GHz Bluetooth	2402 - 2480 MHz	<0.1	0.79	
DXX	NFC	13.56 MHz	<0.1	<0.1	
Simultaneous SAR per KDB 690783 D01v01r03:			<0.1	1.59	
Equipment Class	Band & Mode	Tx Frequency	APD (W/m ²)		Reported PD (W/m ²)
			Laptop	Tablet	
6CD	6 GHz WIFI	U-NII-5: 5935 - 6415 MHz U-NII-6: 6435 - 6515 MHz U-NII-7: 6535 - 6875 MHz U-NII-8: 6895 - 7115 MHz	2.32	4.83	7.01

Note: This revised test report supersedes and replaces the previously issued test report on the same subject device for the same type of testing as indicated. Please discard or destroy the previously issued test report(s) and dispose of it accordingly.

This wireless portable device has been shown to be capable of compliance for localized specific absorption rate (SAR) for uncontrolled environment/general population exposure limits specified in ANSI/IEEE C95.1-1992 and has been tested in accordance with the measurement procedures specified in Section 1.9 of this report; for North American frequency bands only.

I attest to the accuracy of data. All measurements reported herein were performed by me or were made under my supervision and are correct to the best of my knowledge and belief. I assume full responsibility for the completeness of these measurements and vouch for the qualifications of all persons taking them. Test results reported herein relate only to the item(s) tested.

EAR-Controlled Data: This document contains technical data whose export and reexport/ retransfer may be subject to control by the U.S. Department of Commerce under the Export Administration Act and the Export Administration Regulations. The Department of Commerce's prior written approval may be required for the export or re-export/retransfer of such technical data to any foreign person, foreign entity or foreign organization whether in the United States or abroad.

RJ Ortanez
Executive Vice President



The SAR Tick is an initiative of the Mobile & Wireless Forum (MWF). While a product may be considered eligible, use of the SAR Tick logo requires an agreement with the MWF. Further details can be obtained by emailing: sartick@mwfai.info.

FCC ID: C3K2085	SAR EVALUATION REPORT	Approved by: Technical Manager
Document S/N: 1M2311170118-01.C3K(R1)	DUT Type: Portable Computing Device	Page 1 of 58

T A B L E O F C O N T E N T S

1	DEVICE UNDER TEST	3
2	INTRODUCTION	16
3	DOSIMETRIC ASSESSMENT	17
4	TEST CONFIGURATION POSITIONS.....	18
5	RF EXPOSURE LIMITS	19
6	FCC MEASUREMENT PROCEDURES.....	21
7	RF CONDUCTED POWERS.....	24
8	SYSTEM VERIFICATION.....	35
9	SAR DATA SUMMARY	41
10	SAR MEASUREMENT VARIABILITY	51
11	EQUIPMENT LIST.....	52
12	MEASUREMENT UNCERTAINTIES.....	53
13	CONCLUSION.....	56
14	REFERENCES	57
APPENDIX A: SAR TEST PLOTS		
APPENDIX B: SAR DIPOLE VERIFICATION PLOTS		
APPENDIX C: PROBE AND DIPOLE CALIBRATION CERTIFICATES		
APPENDIX D: SAR TISSUE SPECIFICATIONS		
APPENDIX E: MULTI-TX AND ANTENNA SAR CONSIDERATIONS		
APPENDIX F: POWER REDUCTION VERIFICATION		
APPENDIX G: SAR SYSTEM VALIDATION		
APPENDIX H: IEEE 802.11ax/be RU SAR EXCLUSION		
APPENDIX I: DUT ANTENNA DIAGRAM AND SAR TEST SETUP PHOTOGRAPHS		

FCC ID: C3K2085	SAR EVALUATION REPORT	Approved by: Technical Manager
Document S/N: 1M2311170118-01.C3K(R1)	DUT Type: Portable Computing Device	Page 2 of 58

1 DEVICE UNDER TEST

1.1 Device Overview

Band & Mode	Operating Modes	Tx Frequency
2.4 GHz WIFI	Data	2412 - 2472 MHz
5 GHz WIFI	Data	U-NII-1: 5180 - 5240 MHz U-NII-2A: 5260 - 5320 MHz U-NII-2C: 5500 - 5720 MHz U-NII-3: 5745 - 5825 MHz
6 GHz WIFI	Data	U-NII-5: 5935 - 6415 MHz U-NII-6: 6435 - 6515 MHz U-NII-7: 6535 - 6855 MHz U-NII-8: 6875 - 7115 MHz
2.4 GHz Bluetooth	Data	2402 - 2480 MHz
NFC	Data	13.56 MHz

FCC ID: C3K2085	SAR EVALUATION REPORT	Approved by: Technical Manager
Document S/N: 1M2311170118-01.C3K(R1)	DUT Type: Portable Computing Device	Page 3 of 58

REV 22.0
03/30/2022

1.2 Time-Averaging Algorithm for RF Exposure Compliance

This Device is enabled with the Qualcomm® FastConnect TAS feature for WLAN technologies. This feature performs time averaging algorithm in real time to control and manage transmitting power and ensure the time-averaged RF exposure is in compliance with FCC requirements all the time. Refer to Compliance Summary document for detailed description of Qualcomm® FastConnect TAS feature (report SN could be found in Section 1.11 – Bibliography).

Note that Bluetooth and NFC operations are not enabled with TAS.

The FastConnect TAS algorithm maintains the time-averaged transmit power, in turn, time-averaged RF exposure of SAR_design_target, below the predefined time-averaged power limit (i.e., P_{limit} for WLAN), for each characterized technology and band (see RF Exposure Part 0 Test Report, report SN can be found in Section 1.11 - Bibliography).

FastConnect TAS allows the device to transmit at higher power instantaneously, as high as P_{max} , when needed, but enforces power limiting to maintain time-averaged transmit power to P_{limit} . Below table shows Final P_{limit} settings and maximum tune up output power P_{max} configured for this EUT for various transmit conditions (Device State Index DSI for FastConnect.)

Exposure Scenario			Maximum Tune-Up Output Power*	Laptop or Tablet	Tablet
Averaging Volume				1g	1g
Spacing				0 mm, 25 mm	0 mm
DSI				0	1
Technology/Band	Antenna	Antenna Group	Pmax		
2.4 GHz WIFI	R	AG0	20.0	33.1	18.00
2.4 GHz WIFI	L	AG1	20.0	31.6	16.50
5 GHz WIFI	R	AG0	19.5	24.5	15.50
5 GHz WIFI	L	AG1	19.5	25.3	17.75
6 GHz WIFI	R	AG0	19.0	26.1	14.25
6 GHz WIFI	L	AG1	19.0	27.1	13.75

MIMO is not included in SAR CHAR due to the two antennas being in separate Antenna Groups.

*Maximum tune up output power P_{max} is used to configure EUT during RF tune up procedure. The maximum allowed output power is equal to maximum Tune up output power + 1dB device design uncertainty.

The maximum time-averaged output power (dBm) for any WLAN technology, band, and DSI = minimum of " P_{limit} EFS" and "Maximum tune up output power P_{max} " + 1dB device uncertainty. SAR values in this report were scaled to this maximum time-averaged output power to determine compliance per KDB Publication 447498 D01v01.

The purpose of this report (Part 1 test) is to demonstrate that the EUT meets FCC SAR limits when transmitting in static transmission scenario at maximum allowable time-averaged power levels.

Measurement Condition: All conducted power and SAR measurements in this report (Part 1 test) were performed by setting Reserve margin (FastConnect BDF entry) when applicable to 0dB.

FCC ID: C3K2085	SAR EVALUATION REPORT	Approved by: Technical Manager
Document S/N: 1M2311170118-01.C3K(R1)	DUT Type: Portable Computing Device	Page 4 of 58

1.3 Power Reduction for SAR

This device used an independent fixed level power reduction mechanism for BT when the device is used in tablet configuration and motion is sensed. Detailed descriptions of the power reduction mechanism are included in the operational description.

1.4 Nominal and Maximum Output Power Specifications

This device operates using the following maximum and nominal output power specifications. SAR values were scaled to the maximum allowed power to determine compliance per KDB Publication 447498 D01v01.

Note: Targets for 802.11ax/be RU operations can be found in 802.11ax/be RU SAR Exclusion Appendix.

1.4.1 2.4 GHz SISO/MIMO WLAN Output Powers

The below table is applicable in the following conditions:

- Pmax, DSI=0 (No Motion and/or Laptop)

Band	IEEE 802.11 Modulated Output Power (in dBm)																							
	SISO / SISO in MIMO												SISO / SISO in MIMO											
	Antenna R						Antenna L						Antenna R						Antenna L					
Maximum / Nominal Power	b		g		n		ac		ax (SU)		be (SU)		b		g		n		ac		ax (SU)		be (SU)	
	Max	Nom.	Max	Nom.	Max	Nom.	Max	Nom.	Max	Nom.	Max	Nom.	Max	Nom.	Max	Nom.	Max	Nom.	Max	Nom.	Max	Nom.	Max	Nom.
2.4 GHz WLAN 20 MHz BW	21.0	20.0	19.0	18.0	18.0	17.0	18.0	17.0	18.0	17.0	18.0	17.0	21.0	20.0	19.0	18.0	18.0	17.0	18.0	17.0	18.0	17.0	18.0	17.0
	ch. 1: 17.5	16.5	ch. 1: 14.0	13.0	ch. 1: 12.5	11.5	ch. 1: 12.5	11.5	ch. 1: 12.5	11.5	ch. 1: 12.5	11.5	ch. 1: 17.5	16.5	ch. 1: 14.0	13.0	ch. 1: 12.5	11.5	ch. 1: 12.5	11.5	ch. 1: 12.5	11.5	ch. 1: 12.5	11.5
	ch. 2: 18.0	17.0	ch. 2: 15.5	14.5	ch. 2: 14.5	13.5	ch. 2: 14.5	13.5	ch. 2: 14.5	13.5	ch. 2: 14.5	13.5	ch. 2: 15.5	14.5	ch. 2: 14.5	13.5	ch. 2: 14.5	13.5	ch. 2: 14.5	13.5	ch. 2: 14.5	13.5	ch. 2: 14.5	13.5
	ch. 3: 17.0	16.0	ch. 3: 17.0	16.0	ch. 3: 17.0	16.0	ch. 3: 17.0	16.0	ch. 3: 17.0	16.0	ch. 3: 17.0	16.0	ch. 3: 17.0	16.0	ch. 3: 17.0	16.0	ch. 3: 17.0	16.0	ch. 3: 17.0	16.0	ch. 3: 17.0	16.0	ch. 3: 17.0	16.0
	ch. 10: 17.0	16.0	ch. 10: 17.0	16.0	ch. 10: 17.0	16.0	ch. 10: 17.0	16.0	ch. 10: 17.0	16.0	ch. 10: 17.0	16.0	ch. 10: 17.0	16.0	ch. 10: 17.0	16.0	ch. 10: 17.0	16.0	ch. 10: 17.0	16.0	ch. 10: 17.0	16.0	ch. 10: 17.0	16.0
	ch. 11: 18.0	17.0	ch. 11: 16.5	15.5	ch. 11: 14.5	13.5	ch. 11: 14.5	13.5	ch. 11: 14.5	13.5	ch. 11: 14.5	13.5	ch. 11: 18.0	17.0	ch. 11: 16.5	15.5	ch. 11: 14.5	13.5	ch. 11: 14.5	13.5	ch. 11: 14.5	13.5	ch. 11: 14.5	13.5
	ch. 12: 17.0	16.0	ch. 12: 12.0	11.0	ch. 12: 12.5	11.5	ch. 12: 12.5	11.5	ch. 12: 12.5	11.5	ch. 12: 12.5	11.5	ch. 12: 12.0	11.0	ch. 12: 12.5	11.5	ch. 12: 12.5	11.5	ch. 12: 12.5	11.5	ch. 12: 12.5	11.5	ch. 12: 12.5	11.5
	ch. 13: 15.0	14.0	ch. 13: -4.5	-5.0	ch. 13: -5.0	-6.0	ch. 13: -5.0	-6.0	ch. 13: -5.0	-6.0	ch. 13: -5.0	-6.0	ch. 13: 15.0	14.0	ch. 13: -4.5	-5.5	ch. 13: -5.0	-6.0	ch. 13: -5.0	-6.0	ch. 13: -5.0	-6.0	ch. 13: -5.0	-6.0

The below table is applicable in the following conditions:

- DSI=1 (Motion and Tablet)

Band	IEEE 802.11 Modulated Output Power (in dBm)																							
	SISO / SISO in MIMO												SISO / SISO in MIMO											
	Antenna R						Antenna L						Antenna R						Antenna L					
Maximum / Nominal Power	b		g		n		ac		ax (SU)		be (SU)		b		g		n		ac		ax (SU)		be (SU)	
	Max	Nom.	Max	Nom.	Max	Nom.	Max	Nom.	Max	Nom.	Max	Nom.	Max	Nom.	Max	Nom.	Max	Nom.	Max	Nom.	Max	Nom.	Max	Nom.
2.4 GHz WLAN 20 MHz BW	19.0	18.0	19.0	18.0	18.0	17.0	18.0	17.0	18.0	17.0	18.0	17.0	17.5	16.5	17.5	16.5	17.5	16.5	17.5	16.5	17.5	16.5	17.5	16.5
	ch. 1: 17.5	16.5	ch. 1: 14.0	13.0	ch. 1: 12.5	11.5	ch. 1: 12.5	11.5	ch. 1: 12.5	11.5	ch. 1: 12.5	11.5	ch. 1: 14.0	13.0	ch. 1: 12.5	11.5	ch. 1: 12.5	11.5	ch. 1: 12.5	11.5	ch. 1: 12.5	11.5	ch. 1: 12.5	11.5
	ch. 2: 18.0	17.0	ch. 2: 15.5	14.5	ch. 2: 14.5	13.5	ch. 2: 14.5	13.5	ch. 2: 14.5	13.5	ch. 2: 14.5	13.5	ch. 2: 15.5	14.5	ch. 2: 14.5	13.5	ch. 2: 14.5	13.5	ch. 2: 14.5	13.5	ch. 2: 14.5	13.5	ch. 2: 14.5	13.5
	ch. 3: 17.0	16.0	ch. 3: 17.0	16.0	ch. 3: 17.0	16.0	ch. 3: 17.0	16.0	ch. 3: 17.0	16.0	ch. 3: 17.0	16.0	ch. 3: 17.0	16.0	ch. 3: 17.0	16.0	ch. 3: 17.0	16.0	ch. 3: 17.0	16.0	ch. 3: 17.0	16.0	ch. 3: 17.0	16.0
	ch. 10: 17.0	16.0	ch. 10: 17.0	16.0	ch. 10: 17.0	16.0	ch. 10: 17.0	16.0	ch. 10: 17.0	16.0	ch. 10: 17.0	16.0	ch. 10: 17.0	16.0	ch. 10: 17.0	16.0	ch. 10: 17.0	16.0	ch. 10: 17.0	16.0	ch. 10: 17.0	16.0	ch. 10: 17.0	16.0
	ch. 11: 18.0	17.0	ch. 11: 16.5	15.5	ch. 11: 14.5	13.5	ch. 11: 14.5	13.5	ch. 11: 14.5	13.5	ch. 11: 14.5	13.5	ch. 11: 16.5	15.5	ch. 11: 14.5	13.5	ch. 11: 14.5	13.5	ch. 11: 14.5	13.5	ch. 11: 14.5	13.5	ch. 11: 14.5	13.5
	ch. 12: 17.0	16.0	ch. 12: 12.0	11.0	ch. 12: 12.5	11.5	ch. 12: 12.5	11.5	ch. 12: 12.5	11.5	ch. 12: 12.5	11.5	ch. 12: 17.0	16.0	ch. 12: 12.5	11.5	ch. 12: 12.5	11.5	ch. 12: 12.5	11.5	ch. 12: 12.5	11.5	ch. 12: 12.5	11.5
	ch. 13: 15.0	14.0	ch. 13: -4.0	-5.0	ch. 13: -5.0	-6.0	ch. 13: -5.0	-6.0	ch. 13: -5.0	-6.0	ch. 13: -5.0	-6.0	ch. 13: 15.0	14.0	ch. 13: -4.5	-5.5	ch. 13: -5.0	-6.0	ch. 13: -5.0	-6.0	ch. 13: -5.0	-6.0	ch. 13: -5.0	-6.0

FCC ID: C3K2085	SAR EVALUATION REPORT	Approved by: Technical Manager
Document S/N: 1M2311170118-01.C3K(R1)	DUT Type: Portable Computing Device	Page 5 of 58

IEEE 802.11 Modulated Output Power (in dBm)																		
Band	SISO / SISO in MIMO									SISO / SISO in MIMO								
	Antenna R									Antenna L								
	n		ac		ax (SU)		be (SU)		n		ac		ax (SU)		be (SU)			
Maximum / Nominal Power	Max	Nom.	Max	Nom.	Max	Nom.	Max	Nom.	Max	Nom.	Max	Nom.	Max	Nom.	Max	Nom.		
2.4 GHz WLAN 40 MHz BW	ch. 3:	11.0	10.0	ch. 3:	11.0	10.0	ch. 3:	11.0	10.0	ch. 3:	11.0	10.0	ch. 3:	11.0	10.0	ch. 3:	11.0	10.0
	ch. 4:	12.5	11.5	ch. 4:	12.5	11.5	ch. 4:	12.5	11.5	ch. 4:	12.5	11.5	ch. 4:	12.5	11.5	ch. 4:	12.5	11.5
	ch. 5:	14.0	13.0	ch. 5:	14.0	13.0	ch. 5:	14.0	13.0	ch. 5:	14.0	13.0	ch. 5:	14.0	13.0	ch. 5:	14.0	13.0
	ch. 6:	15.0	14.0	ch. 6:	15.0	14.0	ch. 6:	15.0	14.0	ch. 6:	15.0	14.0	ch. 6:	15.0	14.0	ch. 6:	15.0	14.0
	ch. 7:	12.0	11.0	ch. 7:	12.0	11.0	ch. 7:	12.0	11.0	ch. 7:	12.0	11.0	ch. 7:	12.0	11.0	ch. 7:	12.0	11.0
	ch. 8:	11.5	10.5	ch. 8:	11.5	10.5	ch. 8:	11.5	10.5	ch. 8:	11.5	10.5	ch. 8:	11.5	10.5	ch. 8:	11.5	10.5
	ch. 9:	11.5	10.5	ch. 9:	11.5	10.5	ch. 9:	11.5	10.5	ch. 9:	11.5	10.5	ch. 9:	11.5	10.5	ch. 9:	11.5	10.5
	ch. 10:	11.0	10.0	ch. 10:	11.0	10.0	ch. 10:	11.0	10.0	ch. 10:	11.0	10.0	ch. 10:	11.0	10.0	ch. 10:	11.0	10.0
	ch. 11:	-2.5	-3.5	ch. 11:	-2.5	-3.5	ch. 11:	-2.5	-3.5	ch. 11:	-2.5	-3.5	ch. 11:	-2.5	-3.5	ch. 11:	-2.5	-3.5

FCC ID: C3K2085	SAR EVALUATION REPORT	Approved by: Technical Manager
Document S/N: 1M2311170118-01.C3K(R1)	DUT Type: Portable Computing Device	Page 6 of 58

1.4.2 5 GHz SISO/MIMO WLAN Output Power

The below table is applicable in the following conditions:

- Pmax, DSI=0 (No Motion and/or Laptop)

Mode	Band	IEEE 802.11 Modulated Output Power (in dBm)																			
		SISO / SISO In MIMO										SISO / SISO In MIMO									
		Antenna R					Antenna L					Antenna R					Antenna L				
Maximum / Nominal Power		a		n		ac		ax (SU)		be (SU)		a		n		ac		ax (SU)		be (SU)	
		Max	Nom.	Max	Nom.	Max	Nom.	Max	Nom.	Max	Nom.	Max	Nom.	Max	Nom.	Max	Nom.	Max	Nom.	Max	Nom.
5 GHz WIFI (20MHz BW)	UNII-1	19.00	18.00	19.00	18.00	19.00	18.00	19.00	18.00	19.00	18.00	19.00	18.00	19.00	18.00	19.00	18.00	19.00	18.00	19.00	18.00
	UNII-2A	18.50	17.50	18.00	17.00	18.00	17.00	18.00	17.00	18.00	17.00	18.50	17.50	18.00	17.00	18.00	17.00	18.00	17.00	18.00	17.00
	UNII-2C	18.00	17.00	18.00	17.00	18.00	17.00	18.00	17.00	18.00	17.00	18.00	17.00	18.00	17.00	18.00	17.00	18.00	17.00	18.00	17.00
	UNII-3	20.50	19.50	20.50	19.50	20.50	19.50	20.50	19.50	20.50	19.50	20.50	19.50	20.50	19.50	20.50	19.50	20.50	19.50	20.50	19.50
	UNII-4	15.00	14.00	15.00	14.00	15.00	14.00	15.00	14.00	15.00	14.00	15.00	14.00	15.00	14.00	15.00	14.00	15.00	14.00	15.00	14.00
	UNII-1/2A	15.00	14.00	15.00	14.00	15.00	14.00	15.00	14.00	15.00	14.00	15.00	14.00	15.00	14.00	15.00	14.00	15.00	14.00	15.00	14.00
5 GHz WIFI (40MHz BW)	UNII-1			15.00	14.00	15.00	14.00	15.00	14.00	15.00	14.00			15.00	14.00	15.00	14.00	15.00	14.00	15.00	14.00
	UNII-2A			15.00	14.00	15.00	14.00	15.00	14.00	15.00	14.00			15.00	14.00	15.00	14.00	15.00	14.00	15.00	14.00
	UNII-2C			15.00	14.00	15.00	14.00	15.00	14.00	15.00	14.00			15.00	14.00	15.00	14.00	15.00	14.00	15.00	14.00
	UNII-3			18.00	17.00	18.00	17.00	18.00	17.00	18.00	17.00			18.00	17.00	18.00	17.00	18.00	17.00	18.00	17.00
	UNII-4			18.00	17.00	18.00	17.00	18.00	17.00	18.00	17.00			18.00	17.00	18.00	17.00	18.00	17.00	18.00	17.00
5 GHz WIFI (80MHz BW)	UNII-1					14.50	13.50	14.50	13.50	14.50	13.50					14.50	13.50	14.50	13.50	14.50	13.50
	UNII-2A					14.50	13.50	14.50	13.50	14.50	13.50					14.50	13.50	14.50	13.50	14.50	13.50
	UNII-2C					18.00	17.00	18.00	17.00	18.00	17.00					18.00	17.00	18.00	17.00	18.00	17.00
	UNII-3					13.50	12.50	13.50	12.50	13.50	12.50					13.50	12.50	13.50	12.50	13.50	12.50
	UNII-4					13.50	12.50	13.50	12.50	13.50	12.50					13.50	12.50	13.50	12.50	13.50	12.50
5 GHz WIFI (160MHz BW)	UNII-1/2A					14.50	13.50	14.50	13.50	14.50	13.50					14.50	13.50	14.50	13.50	14.50	13.50
	UNII-2C					13.50	12.50	13.50	12.50	13.50	12.50					13.50	12.50	13.50	12.50	13.50	12.50
	UNII-3/4					13.50	12.50	13.50	12.50	13.50	12.50					13.50	12.50	13.50	12.50	13.50	12.50

The below table is applicable in the following conditions:

- DSI=1 (Motion and Tablet)

Mode	Band	IEEE 802.11 Modulated Output Power (in dBm)																			
		SISO / SISO In MIMO										SISO / SISO In MIMO									
		Antenna R					Antenna L					Antenna R					Antenna L				
Maximum / Nominal Power		a		n		ac		ax (SU)		be (SU)		a		n		ac		ax (SU)		be (SU)	
		Max	Nom.	Max	Nom.	Max	Nom.	Max	Nom.	Max	Nom.	Max	Nom.	Max	Nom.	Max	Nom.	Max	Nom.	Max	Nom.
5 GHz WIFI (20MHz BW)	UNII-1	16.50	15.50	16.50	15.50	16.50	15.50	16.50	15.50	16.50	15.50	18.75	17.75	18.75	17.75	18.75	17.75	18.75	17.75	18.75	17.75
	UNII-2A	16.50	15.50	16.50	15.50	16.50	15.50	16.50	15.50	16.50	15.50	18.50	17.50	18.00	17.00	18.00	17.00	18.00	17.00	18.00	17.00
	UNII-2C	15.75	14.75	15.75	14.75	15.75	14.75	15.75	14.75	15.75	14.75	18.00	17.00	17.50	16.50	17.50	16.50	17.50	16.50	17.50	16.50
	UNII-3	15.50	14.50	15.50	14.50	15.50	14.50	15.50	14.50	15.50	14.50	17.50	16.50	17.50	16.50	17.50	16.50	17.50	16.50	17.50	16.50
	UNII-4	15.00	14.00	15.00	14.00	15.00	14.00	15.00	14.00	15.00	14.00	15.00	14.00	15.00	14.00	15.00	14.00	15.00	14.00	15.00	14.00
	UNII-1/2A	15.00	14.00	15.00	14.00	15.00	14.00	15.00	14.00	15.00	14.00	15.00	14.00	15.00	14.00	15.00	14.00	15.00	14.00	15.00	14.00
5 GHz WIFI (40MHz BW)	UNII-1			15.00	14.00	15.00	14.00	15.00	14.00	15.00	14.00			15.00	14.00	15.00	14.00	15.00	14.00	15.00	14.00
	UNII-2A			15.00	14.00	15.00	14.00	15.00	14.00	15.00	14.00			15.00	14.00	15.00	14.00	15.00	14.00	15.00	14.00
	UNII-2C			15.00	14.00	15.00	14.00	15.00	14.00	15.00	14.00			15.00	14.00	15.00	14.00	15.00	14.00	15.00	14.00
	UNII-3			15.50	14.50	15.50	14.50	15.50	14.50	15.50	14.50			17.50	16.50	17.50	16.50	17.50	16.50	17.50	16.50
	UNII-4			15.50	14.50	15.50	14.50	15.50	14.50	15.50	14.50			17.50	16.50	17.50	16.50	17.50	16.50	17.50	16.50
5 GHz WIFI (80MHz BW)	UNII-1					14.50	13.50	14.50	13.50	14.50	13.50					14.50	13.50	14.50	13.50	14.50	13.50
	UNII-2A					14.50	13.50	14.50	13.50	14.50	13.50					14.50	13.50	14.50	13.50	14.50	13.50
	UNII-2C					15.75	14.75	15.75	14.75	15.75	14.75					18.00	17.00	18.00	17.00	18.00	17.00
	UNII-3					13.50	12.50	13.50	12.50	13.50	12.50					13.50	12.50	13.50	12.50	13.50	12.50
	UNII-4					13.50	12.50	13.50	12.50	13.50	12.50					13.50	12.50	13.50	12.50	13.50	12.50
5 GHz WIFI (160MHz BW)	UNII-1/2A					14.50	13.50	14.50	13.50	14.50	13.50					14.50	13.50	14.50	13.50	14.50	13.50
	UNII-2C					13.50	12.50	13.50	12.50	13.50	12.50					13.50	12.50	13.50	12.50	13.50	12.50
	UNII-3/4					13.50	12.50	13.50	12.50	13.50	12.50					13.50	12.50	13.50	12.50	13.50	12.50

FCC ID: C3K2085	SAR EVALUATION REPORT	Approved by: Technical Manager
Document S/N: 1M2311170118-01.C3K(R1)	DUT Type: Portable Computing Device	Page 7 of 58

1.4.3 6 GHz SISO/MIMO WLAN SP Output Power

The below table is applicable in the following conditions:

- Pmax, DSI=0 (No Motion and/or Laptop)

Mode	Band	IEEE 802.11 Modulated Output Power (in dBm)											
		SISO / SISO In MIMO Antenna R						SISO / SISO In MIMO Antenna L					
		a		ax (SU)		be (SU)		a		ax (SU)		be (SU)	
Maximum / Nominal Power		Max	Nom.	Max	Nom.	Max	Nom.	Max	Nom.	Max	Nom.	Max	Nom.
6 GHz WIFI (20MHz BW) - SP	UNII-5	18.5	17.5	19.0	18.0	19.0	18.0	18.5	17.5	19.0	18.0	19.0	18.0
	UNII-7	18.5	17.5	19.0	18.0	19.0	18.0	18.5	17.5	19.0	18.0	19.0	18.0
6 GHz WIFI (40MHz BW) - SP	UNII-5			20.0	19.0	20.0	19.0			20.0	19.0	20.0	19.0
	UNII-7			ch. 3: 18.0 ch. 91: 18.0	17.0 17.0	ch. 3: 18.0 ch. 91: 18.0	17.0 17.0			ch. 3: 18.0 ch. 91: 18.0	17.0 17.0	ch. 3: 18.0 ch. 91: 18.0	17.0 17.0
6 GHz WIFI (80MHz BW) - SP	UNII-5			18.0	17.0	18.0	17.0			18.0	17.0	18.0	17.0
	UNII-7			20.0	19.0	20.0	19.0			20.0	19.0	20.0	19.0
6 GHz WIFI (160MHz BW) - SP	UNII-5			18.0	17.0	18.0	17.0			18.0	17.0	18.0	17.0
	UNII-7			19.0	18.0	19.0	18.0			19.0	18.0	19.0	18.0
6 GHz WIFI (320MHz BW) - SP	UNII-5					18.0	17.0					18.0	17.0

The below table is applicable in the following conditions:

- DSI=1 (Motion and Tablet)

Mode	Band	IEEE 802.11 Modulated Output Power (in dBm)											
		SISO / SISO In MIMO Antenna R						SISO / SISO In MIMO Antenna L					
		a		ax (SU)		be (SU)		a		ax (SU)		be (SU)	
Maximum / Nominal Power		Max	Nom.	Max	Nom.	Max	Nom.	Max	Nom.	Max	Nom.	Max	Nom.
6 GHz WIFI (20MHz BW) - SP	UNII-5	14.25	13.25	14.25	13.25	14.25	13.25	14.00	13.00	14.00	13.00	14.00	13.00
	UNII-7	15.25	14.25	15.25	14.25	15.25	14.25	14.75	13.75	14.75	13.75	14.75	13.75
6 GHz WIFI (40MHz BW) - SP	UNII-5			14.25	13.25	14.25	13.25			14.00	13.00	14.00	13.00
	UNII-7			15.25	14.25	15.25	14.25			14.75	13.75	14.75	13.75
6 GHz WIFI (80MHz BW) - SP	UNII-5			14.25	13.25	14.25	13.25			14.00	13.00	14.00	13.00
	UNII-7			15.25	14.25	15.25	14.25			14.75	13.75	14.75	13.75
6 GHz WIFI (160MHz BW) - SP	UNII-5			14.25	13.25	14.25	13.25			14.00	13.00	14.00	13.00
	UNII-7			15.25	14.25	15.25	14.25			14.75	13.75	14.75	13.75
6 GHz WIFI (320MHz BW) - SP	UNII-5					14.25	13.25					14.00	13.00

FCC ID: C3K2085	SAR EVALUATION REPORT	Approved by: Technical Manager
Document S/N: 1M2311170118-01.C3K(R1)	DUT Type: Portable Computing Device	Page 8 of 58

1.4.4 6 GHz SISO/MIMO WLAN LPI Output Power

The below table is applicable in the following conditions:

- Pmax, DSI=0 (No Motion and/or Laptop), DSI=1 (Motion and Tablet)

		IEEE 802.11 Modulated Output Power (in dBm)											
Mode	Band	SISO / SISO In MIMO						SISO / SISO In MIMO					
		Antenna R						Antenna L					
		a		ax (SU)		be (SU)		a		ax (SU)		be (SU)	
Maximum / Nominal Power		Max	Nom.	Max	Nom.	Max	Nom.	Max	Nom.	Max	Nom.	Max	Nom.
6 GHz WIFI (20MHz BW) - LPI	UNII-5	0.0	-1.0	0.5	-0.5	0.5	-0.5	0.0	-1.0	0.5	-0.5	0.5	-0.5
	UNII-6	0.0	-1.0	0.5	-0.5	0.5	-0.5	0.0	-1.0	0.5	-0.5	0.5	-0.5
	UNII-7	0.0	-1.0	0.5	-0.5	0.5	-0.5	0.0	-1.0	0.5	-0.5	0.5	-0.5
	UNII-8	0.0	-1.0	0.5	-0.5	0.5	-0.5	0.0	-1.0	0.5	-0.5	0.5	-0.5
6 GHz WIFI (40MHz BW) - LPI	UNII-5			4.0	3.0	4.0	3.0			4.0	3.0	4.0	3.0
	UNII-6			4.0	3.0	4.0	3.0			4.0	3.0	4.0	3.0
	UNII-7			4.0	3.0	4.0	3.0			4.0	3.0	4.0	3.0
	UNII-8			4.0	3.0	4.0	3.0			4.0	3.0	4.0	3.0
6 GHz WIFI (80MHz BW) - LPI	UNII-5			6.5	5.5	6.5	5.5			6.5	5.5	6.5	5.5
	UNII-6			6.5	5.5	6.5	5.5			6.5	5.5	6.5	5.5
	UNII-7			6.5	5.5	6.5	5.5			6.5	5.5	6.5	5.5
	UNII-8			6.5	5.5	6.5	5.5			6.5	5.5	6.5	5.5
6 GHz WIFI (160MHz BW) - LPI	UNII-5			8.5	7.5	8.5	7.5			8.5	7.5	8.5	7.5
	UNII-6			8.5	7.5	8.5	7.5			8.5	7.5	8.5	7.5
	UNII-7			8.5	7.5	8.5	7.5			8.5	7.5	8.5	7.5
	UNII-8			8.5	7.5	8.5	7.5			8.5	7.5	8.5	7.5
6 GHz WIFI (320MHz BW) - LPI	UNII-5					10.5	9.5					10.5	9.5
	UNII-6					10.5	9.5					10.5	9.5
	UNII-7					10.5	9.5					10.5	9.5
	UNII-8					10.5	9.5					10.5	9.5

FCC ID: C3K2085	SAR EVALUATION REPORT	Approved by: Technical Manager
Document S/N: 1M2311170118-01.C3K(R1)	DUT Type: Portable Computing Device	Page 9 of 58

1.4.5 2.4 GHz Maximum Bluetooth Output Power

Mode	Data Rate	Modulated Output Power (in dBm)					
		Single Antenna				Each Chain in Beam Forming Mode	
		Antenna R		Antenna L		Beam Forming	
Maximum / Nominal Power		Max	Nom.	Max	Nom.	Max	Nom.
Bluetooth	1Mbps	21.0	19.0	21.0	19.0	18.0	16.0
Bluetooth EDR	2Mbps	18.0	16.0	18.0	16.0	15.0	13.0
Bluetooth EDR	3Mbps	18.0	16.0	18.0	16.0	15.0	13.0
Bluetooth LE	1Mbps	21.0	19.0	21.0	19.0	18.0	16.0
Bluetooth LE	2Mbps	21.0	19.0	21.0	19.0	18.0	16.0
Bluetooth LE	125kbps	14.0	12.0	14.0	12.0	N/A	N/A
Bluetooth LE	500kbps	14.0	12.0	14.0	12.0	N/A	N/A

1.4.6 2.4 GHz Reduced Bluetooth Output Power

The below table is applicable in the following conditions:

- Tablet Mode with motion sensor active

Mode	Data Rate	Modulated Output Power (in dBm)					
		Single Antenna				Each Chain in Beam Forming Mode	
		Antenna R		Antenna L		Beam Forming	
Maximum / Nominal Power		Max	Nom.	Max	Nom.	Max	Nom.
Bluetooth	1Mbps	20.00	18.00	18.25	16.25	18.0	16.0
Bluetooth EDR	2Mbps	18.00	16.00	18.00	16.00	15.0	13.0
Bluetooth EDR	3Mbps	18.00	16.00	18.00	16.00	15.0	13.0
Bluetooth LE	1Mbps	20.00	18.00	18.25	16.25	18.0	16.0
Bluetooth LE	2Mbps	20.00	18.00	18.25	16.25	18.0	16.0
Bluetooth LE	125kbps	14.00	12.00	14.00	12.00	N/A	N/A
Bluetooth LE	500kbps	14.00	12.00	14.00	12.00	N/A	N/A

FCC ID: C3K2085	SAR EVALUATION REPORT	Approved by: Technical Manager
Document S/N: 1M2311170118-01.C3K(R1)	DUT Type: Portable Computing Device	Page 10 of 58

The below table is applicable in the following conditions:

- Tablet Mode with motion sensor active and WLAN active

Mode	Data Rate	Modulated Output Power (in dBm)					
		Single Antenna				Each Chain in Beam Forming Mode	
		Antenna R		Antenna L		Beam Forming	
Maximum / Nominal Power		Max	Nom.	Max	Nom.	Max	Nom.
Bluetooth	1Mbps	14.75	12.75	13.00	11.00	13.0	11.0
Bluetooth EDR	2Mbps	14.75	12.75	13.00	11.00	13.0	11.0
Bluetooth EDR	3Mbps	14.75	12.75	13.00	11.00	13.0	11.0
Bluetooth LE	1Mbps	14.75	12.75	13.00	11.00	13.0	11.0
Bluetooth LE	2Mbps	14.75	12.75	13.00	11.00	13.0	11.0
Bluetooth LE	125kbps	14.00	12.00	13.00	11.00	N/A	N/A
Bluetooth LE	500kbps	14.00	12.00	13.00	11.00	N/A	N/A

FCC ID: C3K2085	SAR EVALUATION REPORT	Approved by: Technical Manager
Document S/N: 1M2311170118-01.C3K(R1)	DUT Type: Portable Computing Device	Page 11 of 58

1.5 DUT Antenna Locations

The overall dimensions of this device is > 200 mm. A diagram showing the location of the device antennas can be found in the DUT Antenna Diagram and SAR Test Setup Photographs Appendix. Exact dimensions and separation distances are shown in the Technical Descriptions in the FCC filings.

**Table 1-1
Device Edges/Sides for SAR Testing Laptop Mode**

Antenna	Back	Front	Top	Bottom	Right	Left
R	No	No	No	Yes	No	No
L	No	No	No	Yes	No	No

**Table 1-2
Device Edges/Sides for SAR Testing Tablet Mode**

Antenna	Back	Front	Top	Bottom	Right	Left
R	Yes	No	Yes	Yes	Yes	No
L	Yes	No	Yes	Yes	No	Yes

Note: Note: Per FCC KDB Publication 616217 D04v01r01, particular edges were not required to be evaluated for SAR based on the SAR exclusion threshold in KDB 447498 D04v01. Additional edges may have been evaluated for simultaneous transmission analysis.

1.6 Near Field Communications (NFC) Antenna

This DUT has NFC operations. The NFC antenna is integrated into the device for this model. Therefore, all SAR tests were performed with the device which already incorporates the NFC antenna. A diagram showing the location of the NFC antenna can be found in the DUT Antenna Diagram and SAR Test Setup Photographs Appendix.

FCC ID: C3K2085	SAR EVALUATION REPORT	Approved by: Technical Manager
Document S/N: 1M2311170118-01.C3K(R1)	DUT Type: Portable Computing Device	Page 12 of 58

1.7 Simultaneous Transmission Capabilities

According to FCC KDB Publication 447498 D01v01, transmitters are considered to be operating simultaneously when there is overlapping transmission, with the exception of transmissions during network hand-offs with maximum hand-off duration less than 30 seconds.

This device contains multiple transmitters that may operate simultaneously, and therefore requires a simultaneous transmission analysis according to FCC KDB Publication 447498 D01v01 4.3.2 procedures.

**Table 1-3
Simultaneous Transmission Scenarios**

No.	Capable Transmit Configuration	Laptop	Tablet
1	2.4 GHz WLAN MIMO	Yes	Yes
2	5 GHz WLAN MIMO	Yes	Yes
3	6 GHz WLAN MIMO	Yes	Yes
4	2.4 GHz Bluetooth Beam Forming	Yes	Yes
5	2.4 GHz WLAN Ant R + 2.4 GHz Bluetooth Ant L	Yes	Yes
6	2.4 GHz Bluetooth Ant R + 2.4 GHz WLAN Ant L	Yes	Yes
7	5 GHz WLAN Ant R + 2.4 GHz Bluetooth Ant L	Yes	Yes
8	6 GHz WLAN Ant R + 2.4 GHz Bluetooth Ant L	Yes	Yes
9	2.4 GHz Bluetooth Ant R + 5 GHz WLAN Ant L	Yes	Yes
10	2.4 GHz Bluetooth Ant R + 6 GHz WLAN Ant L	Yes	Yes
11	5 GHz WLAN MIMO + 2.4 GHz Bluetooth Ant R	Yes	Yes
12	6 GHz WLAN MIMO + 2.4 GHz Bluetooth Ant R	Yes	Yes
13	5 GHz WLAN MIMO + 2.4 GHz Bluetooth Ant L	Yes	Yes
14	6 GHz WLAN MIMO + 2.4 GHz Bluetooth Ant L	Yes	Yes
15	2.4 GHz WLAN MIMO + 5 GHz WLAN MIMO	Yes	Yes
16	2.4 GHz WLAN MIMO + 6 GHz WLAN MIMO	Yes	Yes
17	5 GHz WLAN MIMO + 2.4 GHz WLAN Ant R	Yes	Yes
18	6 GHz WLAN MIMO + 2.4 GHz WLAN Ant R	Yes	Yes
19	5 GHz WLAN MIMO + 2.4 GHz WLAN Ant L	Yes	Yes
20	6 GHz WLAN MIMO + 2.4 GHz WLAN Ant L	Yes	Yes
21	2.4 GHz Bluetooth Ant R + 2.4 GHz WLAN Ant L + 5 GHz WLAN Ant L	Yes	Yes
22	2.4 GHz Bluetooth Ant R + 2.4 GHz WLAN Ant L + 6 GHz WLAN Ant L	Yes	Yes
23	2.4 GHz WLAN Ant R + 5 GHz WLAN Ant R + 2.4 GHz Bluetooth Ant L	Yes	Yes
24	2.4 GHz WLAN Ant R + 6 GHz WLAN Ant R + 2.4 GHz Bluetooth Ant L	Yes	Yes
25	5 GHz WLAN MIMO + 2.4 GHz Bluetooth Ant R + 2.4 GHz WLAN Ant L	Yes	Yes
26	6 GHz WLAN MIMO + 2.4 GHz Bluetooth Ant R + 2.4 GHz WLAN Ant L	Yes	Yes
27	5 GHz WLAN MIMO + 2.4 GHz WLAN Ant R + 2.4 GHz Bluetooth Ant L	Yes	Yes
28	6 GHz WLAN MIMO + 2.4 GHz WLAN Ant R + 2.4 GHz Bluetooth Ant L	Yes	Yes
29	2.4 GHz WLAN Ant R + 5 GHz WLAN Ant L	Yes	Yes
30	2.4 GHz WLAN Ant R + 6 GHz WLAN Ant L	Yes	Yes
31	5 GHz WLAN Ant R + 2.4 GHz WLAN Ant L	Yes	Yes
32	6 GHz WLAN Ant R + 2.4 GHz WLAN Ant L	Yes	Yes
33	5 GHz WLAN Ant L + 2.4 GHz Bluetooth Ant L	Yes	Yes
34	6 GHz WLAN Ant L + 2.4 GHz Bluetooth Ant L	Yes	Yes
35	5 GHz WLAN Ant R + 2.4 GHz Bluetooth Ant R	Yes	Yes
36	6 GHz WLAN Ant R + 2.4 GHz Bluetooth Ant R	Yes	Yes
37	2.4 GHz WLAN MIMO + 5 GHz WLAN Ant R	Yes	Yes
38	2.4 GHz WLAN MIMO + 6 GHz WLAN Ant R	Yes	Yes
39	2.4 GHz WLAN MIMO + 5 GHz WLAN Ant L	Yes	Yes
40	2.4 GHz WLAN MIMO + 6 GHz WLAN Ant L	Yes	Yes
41	2.4 GHz WLAN Ant L + 5 GHz WLAN Ant L	Yes	Yes
42	2.4 GHz WLAN Ant L + 6 GHz WLAN Ant L	Yes	Yes
43	2.4 GHz WLAN Ant R + 5 GHz WLAN Ant R	Yes	Yes
44	2.4 GHz WLAN Ant R + 6 GHz WLAN Ant R	Yes	Yes
45	5 GHz WLAN MIMO + 2.4 GHz Bluetooth Beam Forming	Yes	Yes
46	6 GHz WLAN MIMO + 2.4 GHz Bluetooth Beam Forming	Yes	Yes

- 2.4 GHz WLAN Antenna R and 2.4 GHz Bluetooth Ant R share the same antenna path and cannot transmit simultaneously.
- 2.4 GHz WLAN Antenna L and 2.4 GHz Bluetooth Ant L share the same antenna path and cannot transmit simultaneously.
- 5 GHz WLAN and 6 GHz WLAN share the same antenna path and cannot transmit simultaneously.
- This device supports 2x2 MIMO Tx for WLAN 802.11a/g/n/ac/ax/be. 802.11a/g/n/ac/ax/be supports CDD and STBC and 802.11n/ac/ax/be additionally supports SDM.
- This device supports Bluetooth Tethering.

FCC ID: C3K2085	SAR EVALUATION REPORT	Approved by: Technical Manager
Document S/N: 1M2311170118-01.C3K(R1)	DUT Type: Portable Computing Device	Page 13 of 58

1.8 Miscellaneous SAR Test Considerations

This device supports IEEE 802.11ac with the following features:

- a) Up to 160 MHz Bandwidth only
- b) No aggregate channel configurations
- c) 2 Tx antenna output
- d) 256 QAM is supported
- e) TDWR and Band gap channels are supported

This device supports IEEE 802.11ax/be with the following features:

- a) Up to 320 MHz Bandwidth only for 6 GHz
- b) Up to 160 MHz Bandwidth only for 5 GHz
- c) Up to 40 MHz Bandwidth only for 2.4 GHz
- d) 2 Tx antenna output
- e) Up to 1024 QAM is supported
- f) TDWR and Band gap channels are supported for 5/6 GHz
- g) MU-MIMO UL Operations are not supported

This device supports channel 1-13 for 2.4 GHz WLAN. However, because channel 12/13 targets are not higher than that of channels 1-11, channels 1, 6, and 11 were considered for SAR testing per FCC KDB 248227 D01V02r02.

Per FCC guidance, SAR was performed using 6.5 GHz SAR probe calibration factors. FCC KDB 648474 and FCC KDB 248227 were followed for test positions, distances, and modes. Per TCB workshop October 2020 notes, 5 channels were tested. Absorbed power density (APD) using a 4cm² averaging area is reported based on SAR measurements. Incident power density is evaluated at 2mm ensuring that the resolution is sufficient such that integrated power density (iPD) between d=2mm and d= λ /5mm is \geq -1dB per equipment manufacturer guidance. Power density results are scaled up for uncertainty above 30%.

Per FCC Guidance, 802.11ax/be RU was considered a higher order 802.11 mode when compared to a/b/g/n/ac to apply KDB Publication 248227 D01v02r02 for OFDM mode selection. Therefore, SAR tests were not required for 802.11ax/be RU based on the maximum allowed output powers of OFDM modes and the reported SAR values. Per FCC Guidance, maximum conducted powers were performed for each RU size to demonstrate that the output powers would not be higher than the other OFDM 802.11 modes. Please see Measurement Report SN 1M2204040049-02.C3K for 802.11ax/be RU output powers.

When U-NII-1 and U-NII-2A bands have the same maximum output power and the highest reported SAR for U-NII-2A is less than 1.2 W/kg, SAR is not required for U-NII-1 band according to FCC KDB Publication 248227 D01v02r02.

FCC ID: C3K2085	SAR EVALUATION REPORT	Approved by: Technical Manager
Document S/N: 1M2311170118-01.C3K(R1)	DUT Type: Portable Computing Device	Page 14 of 58

REV 22.0
03/30/2022

1.9 Guidance Applied

- IEEE 1528-2013
- FCC KDB Publication 248227 D01v02r02 (SAR Considerations for 802.11 Devices)
- FCC KDB Publication 447498 D04v01 (Interim General SAR Guidance)
- FCC KDB Publication 865664 D01v01r04, D02v01r02 (SAR Measurements up to 6 GHz)
- FCC KDB Publication 616217 D04v01r02 (Tablet/Laptop)
- FCC KDB 648474 D04 (Accessories)
- April 2019 TCB Workshop Notes (IEEE 802.11ax)
- IEC/IEEE 63195-1:2022
- IEC 62479:2010
- November 2017, October 2018, April 2019, November 2019, October 2020 TCB Workshop Notes (IEEE 802.11ax)
- SPEAG DASY6 System Handbook
- SPEAG DASY6 Application Note (Interim Procedures for Devices Operating at 6-10 GHz) (Nov 2021)

1.10 Device Serial Numbers

Several samples with identical hardware were used to support SAR testing. The manufacturer has confirmed that the device(s) tested have the same physical, mechanical and thermal characteristics and are within operational tolerances expected for production units. The serial numbers used for each test are indicated alongside the results in Section 9.

1.11 Bibliography

Report Type	Report Serial Number
RF Exposure Part 0 Test Report	1M2311170118-21.C3K
RF Exposure Part 2 Test Report	1M2311170118-22.C3K
RF Exposure Compliance Summary Report	1M2311170118-02.C3K

FCC ID: C3K2085	SAR EVALUATION REPORT	Approved by: Technical Manager
Document S/N: 1M2311170118-01.C3K(R1)	DUT Type: Portable Computing Device	Page 15 of 58

REV 22.0
03/30/2022

2 INTRODUCTION

The FCC and Innovation, Science, and Economic Development Canada have adopted the guidelines for evaluating the environmental effects of radio frequency (RF) radiation in ET Docket 93-62 on Aug. 6, 1996 and Health Canada Safety Code 6 to protect the public and workers from the potential hazards of RF emissions due to FCC-regulated portable devices. [1]

The safety limits used for the environmental evaluation measurements are based on the criteria published by the American National Standards Institute (ANSI) for localized specific absorption rate (SAR) in IEEE/ANSI C95.1-1992 Standard for Safety Levels with Respect to Human Exposure to Radio Frequency Electromagnetic Fields, 3 kHz to 300 GHz [3] and Health Canada RF Exposure Guidelines Safety Code 6 [22]. The measurement procedure described in IEEE/ANSI C95.3-2002 Recommended Practice for the Measurement of Potentially Hazardous Electromagnetic Fields - RF and Microwave [4] is used for guidance in measuring the Specific Absorption Rate (SAR) due to the RF radiation exposure from the Equipment Under Test (EUT). These criteria for SAR evaluation are similar to those recommended by the International Committee for Non-Ionizing Radiation Protection (ICNIRP) in Biological Effects and Exposure Criteria for Radiofrequency Electromagnetic Fields,” Report No. Vol 74. SAR is a measure of the rate of energy absorption due to exposure to an RF transmitting source. SAR values have been related to threshold levels for potential biological hazards.

2.1 SAR Definition

Specific Absorption Rate is defined as the time derivative (rate) of the incremental energy (dU) absorbed by (dissipated in) an incremental mass (dm) contained in a volume element (dV) of a given density (ρ). It is also defined as the rate of RF energy absorption per unit mass at a point in an absorbing body (see Equation 2-1).

Equation 2-1
SAR Mathematical Equation

$$SAR = \frac{d}{dt} \left(\frac{dU}{dm} \right) = \frac{d}{dt} \left(\frac{dU}{\rho dv} \right)$$

SAR is expressed in units of Watts per Kilogram (W/kg).

$$SAR = \frac{\sigma \cdot E^2}{\rho}$$

where:

- σ = conductivity of the tissue-simulating material (S/m)
- ρ = mass density of the tissue-simulating material (kg/m³)
- E = Total RMS electric field strength (V/m)

NOTE: The primary factors that control rate of energy absorption were found to be the wavelength of the incident field in relation to the dimensions and geometry of the irradiated organism, the orientation of the organism in relation to the polarity of field vectors, the presence of reflecting surfaces, and whether conductive contact is made by the organism with a ground plane.[6]

FCC ID: C3K2085	SAR EVALUATION REPORT	Approved by: Technical Manager
Document S/N: 1M2311170118-01.C3K(R1)	DUT Type: Portable Computing Device	Page 16 of 58

REV 22.0
03/30/2022

3 DOSIMETRIC ASSESSMENT

3.1 Measurement Procedure

The evaluation was performed using the following procedure compliant to FCC KDB Publication 865664 D01v01r04 and IEEE 1528-2013:

1. The SAR distribution at the exposed side of the head or body was measured at a distance no greater than 5.0 mm from the inner surface of the shell. The area covered the entire dimension of the device-head and body interface and the horizontal grid resolution was determined per FCC KDB Publication 865664 D01v01r04 (See Table 3-1) and IEEE 1528-2013.
2. The point SAR measurement was taken at the maximum SAR region determined from Step 1 to enable the monitoring of SAR fluctuations/drifts during the 1g/10g cube evaluation. SAR at this fixed point was measured and used as a reference value.
3. Based on the area scan data, the peak of the region with maximum SAR was determined by spline interpolation. Around this point, a volume was assessed according to the measurement resolution and volume size requirements of FCC KDB Publication 865664 D01v01r04 (See Table 3-1) and IEEE 1528-2013. On the basis of this data set, the spatial peak SAR value was evaluated with the following procedure (see references or the DASy manual online for more details):
 - a. SAR values at the inner surface of the phantom are extrapolated from the measured values along the line away from the surface with spacing no greater than that in Table 3-1. The extrapolation was based on a least-squares algorithm. A polynomial of the fourth order was calculated through the points in the z-axis (normal to the phantom shell).
 - b. After the maximum interpolated values were calculated between the points in the cube, the SAR was averaged over the spatial volume (1g or 10g) using a 3D-Spline interpolation algorithm. The 3D-spline is composed of three one-dimensional splines with the “Not a knot” condition (in x, y, and z directions). The volume was then integrated with the trapezoidal algorithm. One thousand points (10 x 10 x 10) were obtained through interpolation, in order to calculate the averaged SAR.
 - c. All neighboring volumes were evaluated until no neighboring volume with a higher average value was found.
4. The SAR reference value, at the same location as step 2, was re-measured after the zoom scan was complete to calculate the SAR drift. If the drift deviated by more than 5%, the SAR test and drift measurements were repeated.

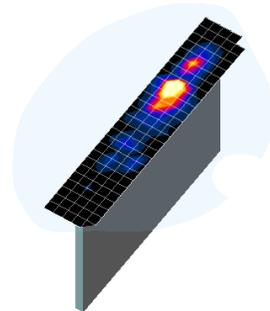

Figure 3-1
Sample SAR Area Scan

Table 3-1
Area and Zoom Scan Resolutions per FCC KDB Publication 865664 D01v01r04*

Frequency	Maximum Area Scan Resolution (mm) ($\Delta x_{\text{area}}, \Delta y_{\text{area}}$)	Maximum Zoom Scan Resolution (mm) ($\Delta x_{\text{zoom}}, \Delta y_{\text{zoom}}$)	Maximum Zoom Scan Spatial Resolution (mm)			Minimum Zoom Scan Volume (mm) (x, y, z)
			Uniform Grid	Graded Grid		
			$\Delta z_{\text{zoom}}(n)$	$\Delta z_{\text{zoom}}(1)^*$	$\Delta z_{\text{zoom}}(n>1)^*$	
≤ 2 GHz	≤ 15	≤ 8	≤ 5	≤ 4	≤ 1.5* $\Delta z_{\text{zoom}}(n-1)$	≥ 30
2-3 GHz	≤ 12	≤ 5	≤ 5	≤ 4	≤ 1.5* $\Delta z_{\text{zoom}}(n-1)$	≥ 30
3-4 GHz	≤ 12	≤ 5	≤ 4	≤ 3	≤ 1.5* $\Delta z_{\text{zoom}}(n-1)$	≥ 28
4-5 GHz	≤ 10	≤ 4	≤ 3	≤ 2.5	≤ 1.5* $\Delta z_{\text{zoom}}(n-1)$	≥ 25
5-6 GHz	≤ 10	≤ 4	≤ 2	≤ 2	≤ 1.5* $\Delta z_{\text{zoom}}(n-1)$	≥ 22

*Also compliant to IEEE 1528-2013 Table 6

FCC ID: C3K2085	SAR EVALUATION REPORT	Approved by: Technical Manager
Document S/N: 1M2311170118-01.C3K(R1)	DUT Type: Portable Computing Device	Page 17 of 58

REV 22.0
03/30/2022

4 TEST CONFIGURATION POSITIONS

4.1 Device Holder

The device holder is made out of low-loss POM material having the following dielectric parameters: relative permittivity $\epsilon = 3$ and loss tangent $\delta = 0.02$.

4.2 SAR Testing for Tablet per KDB Publication 616217 D04v01r02

Per FCC KDB Publication 616217 D04v01r02, the back surface and edges of the tablet should be tested for SAR compliance with the tablet touching the phantom. The SAR Exclusion Threshold in KDB 447498 D01v01 can be applied to determine SAR test exclusion for adjacent edge configurations. The closest distance from the antenna to an adjacent tablet edge is used to determine if SAR testing is required for the adjacent edges, with the adjacent edge positioned against the phantom and the edge containing the antenna positioned perpendicular to the phantom.

FCC ID: C3K2085	SAR EVALUATION REPORT	Approved by: Technical Manager
Document S/N: 1M2311170118-01.C3K(R1)	DUT Type: Portable Computing Device	Page 18 of 58

REV 22.0
03/30/2022

5 RF EXPOSURE LIMITS

5.1 Uncontrolled Environment

UNCONTROLLED ENVIRONMENTS are defined as locations where there is the exposure of individuals who have no knowledge or control of their exposure. The general population/uncontrolled exposure limits are applicable to situations in which the general public may be exposed or in which persons who are exposed as a consequence of their employment may not be made fully aware of the potential for exposure or cannot exercise control over their exposure. Members of the general public would come under this category when exposure is not employment-related; for example, in the case of a wireless transmitter that exposes persons in its vicinity.

5.2 Controlled Environment

CONTROLLED ENVIRONMENTS are defined as locations where there is exposure that may be incurred by persons who are aware of the potential for exposure, (i.e. as a result of employment or occupation). In general, occupational/controlled exposure limits are applicable to situations in which persons are exposed as a consequence of their employment, who have been made fully aware of the potential for exposure and can exercise control over their exposure. This exposure category is also applicable when the exposure is of a transient nature due to incidental passage through a location where the exposure levels may be higher than the general population/uncontrolled limits, but the exposed person is fully aware of the potential for exposure and can exercise control over his or her exposure by leaving the area or by some other appropriate means.

5.3 RF Exposure Limits for Frequencies Below 6 GHz

Table 5-1
SAR Human Exposure Specified in ANSI/IEEE C95.1-1992 and Health Canada Safety Code 6

HUMAN EXPOSURE LIMITS		
	UNCONTROLLED ENVIRONMENT <i>General Population</i> (W/kg) or (mW/g)	CONTROLLED ENVIRONMENT <i>Occupational</i> (W/kg) or (mW/g)
Peak Spatial Average SAR Head	1.6	8.0
Whole Body SAR	0.08	0.4
Peak Spatial Average SAR Hands, Feet, Ankle, Wrists, etc.	4.0	20

1. The Spatial Peak value of the SAR averaged over any 1 gram of tissue (defined as a tissue volume in the shape of a cube) and over the appropriate averaging time.
2. The Spatial Average value of the SAR averaged over the whole body.
3. The Spatial Peak value of the SAR averaged over any 10 grams of tissue (defined as a tissue volume in the shape of a cube) and over the appropriate averaging time.

FCC ID: C3K2085	SAR EVALUATION REPORT	Approved by: Technical Manager
Document S/N: 1M2311170118-01.C3K(R1)	DUT Type: Portable Computing Device	Page 19 of 58

REV 22.0
03/30/2022

5.4 RF Exposure Limits for Frequencies Above 6 GHz

Per §1.1310 (d)(3), the MPE limits are applied for frequencies above 6 GHz. Power Density is expressed in units of W/m² or mW/cm².

Peak Spatially Averaged Power Density was evaluated over a circular area of 4 cm² per interim FCC Guidance for near-field power density evaluations per October 2018 TCB Workshop notes.

**Table 5-2
Human Exposure Limits Specified in FCC 47 CFR §1.1310**

Human Exposure to Radiofrequency (RF) Radiation Limits		
Frequency Range [MHz]	Power Density [mW/cm²]	Average Time [Minutes]
(A) Limits For Occupational / Controlled Environments		
1,500 – 100,000	5.0	6
(B) Limits For General Population / Uncontrolled Environments		
1,500 – 100,000	1.0	30

Note: 1.0 mW/cm² is 10 W/m²

FCC ID: C3K2085	SAR EVALUATION REPORT	Approved by: Technical Manager
Document S/N: 1M2311170118-01.C3K(R1)	DUT Type: Portable Computing Device	Page 20 of 58

REV 22.0
03/30/2022

6 FCC MEASUREMENT PROCEDURES

Power measurements for licensed transmitters are performed using a base station simulator under digital average power.

6.1 Measured and Reported SAR

Per FCC KDB Publication 447498 D01v01, when SAR is not measured at the maximum power level allowed for production units, the results must be scaled to the maximum tune-up tolerance limit according to the power applied to the individual channels tested to determine compliance. For simultaneous transmission, the measured aggregate SAR must be scaled according to the sum of the differences between the maximum tune-up tolerance and actual power used to test each transmitter. When SAR is measured at or scaled to the maximum tune-up tolerance limit, the results are referred to as *reported* SAR. The highest *reported* SAR results are identified on the grant of equipment authorization according to procedures in KDB 690783 D01v01r03.

6.2 SAR Testing with 802.11 Transmitters

The normal network operating configurations of 802.11 transmitters are not suitable for SAR measurements. Unpredictable fluctuations in network traffic and antenna diversity conditions can introduce undesirable variations in SAR results. The SAR for these devices should be measured using chipset based test mode software to ensure the results are consistent and reliable. See KDB Publication 248227 D01v02r02 for more details.

6.2.1 General Device Setup

Chipset based test mode software is hardware dependent and generally varies among manufacturers. The device operating parameters established in test mode for SAR measurements must be identical to those programmed in production units, including output power levels, amplifier gain settings and other RF performance tuning parameters.

A periodic duty factor is required for current generation SAR systems to measure SAR. When 802.11 frame gaps are accounted for in the transmission, a maximum transmission duty factor of 92 - 96% is typically achievable in most test mode configurations. A minimum transmission duty factor of 85% is required to avoid certain hardware and device implementation issues related to wide range SAR scaling. The reported SAR is scaled to 100% transmission duty factor to determine compliance at the maximum tune-up tolerance limit.

6.2.2 U-NII-1 and U-NII-2A

For devices that operate in both U-NII-1 and U-NII-2A bands, when the same maximum output power is specified for both bands, SAR measurement using OFDM SAR test procedures is not required for U-NII-1 unless the highest reported SAR for U-NII-2A is > 1.2 W/kg. When different maximum output powers are specified for the bands, SAR measurement for the U-NII band with the lower maximum output power is not required unless the highest reported SAR for the U-NII band with the higher maximum output power, adjusted by the ratio of lower to higher specified maximum output power for the two bands, is > 1.2 W/kg. When 10g SAR measurement is considered, a factor of 2.5 is applied to the thresholds above.

6.2.3 U-NII-2C and U-NII-3

The frequency range covered by U-NII-2C and U-NII-3 is 380 MHz (5.47 – 5.85 GHz), which requires a minimum of at least two SAR probe calibration frequency points to support SAR measurements. When Terminal Doppler Weather Radar (TDWR) restriction applies, the channels at 5.60 – 5.65 GHz in U-NII-2C band must be disabled with acceptable mechanisms and documented in the equipment certification. Unless band gap channels are permanently disabled, SAR must be considered for these channels. Each band is tested independently according to the normally required OFDM SAR measurement and probe calibration frequency points requirements.

FCC ID: C3K2085	SAR EVALUATION REPORT	Approved by: Technical Manager
Document S/N: 1M2311170118-01.C3K(R1)	DUT Type: Portable Computing Device	Page 21 of 58

REV 22.0
03/30/2022

6.2.4 Initial Test Position Procedure

For exposure conditions with multiple test positions, such as handset operating next to the ear, devices with hotspot mode or UMPC mini-tablet, procedures for initial test position can be applied. Using the transmission mode determined by the DSSS procedure or initial test configuration, area scans are measured for all positions in an exposure condition. The test position with the highest extrapolated (peak) SAR is used as the initial test position. When reported SAR for the initial test position is ≤ 0.4 W/kg, no additional testing for the remaining test positions is required. Otherwise, SAR is evaluated at the subsequent highest peak SAR positions until the reported SAR result is ≤ 0.8 W/kg or all test positions are measured. When 10g SAR measurement is considered, a factor of 2.5 is applied to the thresholds above.

6.2.5 2.4 GHz SAR Test Requirements

SAR is measured for 2.4 GHz 802.11b DSSS using either the fixed test position or, when applicable, the initial test position procedure. SAR test reduction is determined according to the following:

- 1) When the reported SAR of the highest measured maximum output power channel for the exposure configuration is ≤ 0.8 W/kg, no further SAR testing is required for 802.11b DSSS in that exposure configuration.
- 2) When the reported SAR is > 0.8 W/kg, SAR is required for that position using the next highest measured output power channel. When any reported SAR is > 1.2 W/kg, SAR is required for the third channel; i.e., all channels require testing.

2.4 GHz 802.11 g/n/ax OFDM are additionally evaluated for SAR if the highest reported SAR for 802.11b, adjusted by the ratio of the OFDM to DSSS specified maximum output power, is > 1.2 W/kg. When SAR is required for OFDM modes in 2.4 GHz band, the Initial Test Configuration Procedures should be followed. When 10g SAR measurement is considered, a factor of 2.5 is applied to the thresholds above.

6.2.6 OFDM Transmission Mode and SAR Test Channel Selection

When the same maximum output power was specified for multiple OFDM transmission mode configurations in a frequency band or aggregated band, SAR is measured using the configuration with the largest channel bandwidth, lowest order modulation and lowest data rate. When the maximum output power of a channel is the same for equivalent OFDM configurations; for example, 802.11a, 802.11n and 802.11ac or 802.11g and 802.11n with the same channel bandwidth, modulation and data rate etc., the lower order 802.11 mode i.e., 802.11a, then 802.11n and 802.11ac or 802.11g then 802.11n, is used for SAR measurement. Per April 2019 TCB Workshop guidance, 802.11ax was considered the highest order 802.11 mode. When the maximum output power are the same for multiple test channels, either according to the default or additional power measurement requirements, SAR is measured using the channel closest to the middle of the frequency band or aggregated band. When there are multiple channels with the same maximum output power, SAR is measured using the higher number channel.

6.2.7 Initial Test Configuration Procedure

For OFDM, an initial test configuration is determined for each frequency band and aggregated band, according to the transmission mode with the highest maximum output power specified for SAR measurements. When the same maximum output power is specified for multiple OFDM transmission mode configurations in a frequency band or aggregated band, SAR is measured using the configuration(s) with the largest channel bandwidth, lowest order modulation, lowest data rate and lowest order IEEE 802.11 mode. The channel of the transmission mode with the highest average RF output conducted power will be the initial test configuration.

FCC ID: C3K2085	SAR EVALUATION REPORT	Approved by: Technical Manager
Document S/N: 1M2311170118-01.C3K(R1)	DUT Type: Portable Computing Device	Page 22 of 58

REV 22.0
03/30/2022

When the reported SAR is ≤ 0.8 W/kg, no additional measurements on other test channels are required. Otherwise, SAR is evaluated using the subsequent highest average RF output channel until the reported SAR result is ≤ 1.2 W/kg or all channels are measured. When there are multiple untested channels having the same subsequent highest average RF output power, the channel with higher frequency from the lowest 802.11 mode is considered for SAR measurements (See Section 6.2.6). When 10g SAR measurement is considered, a factor of 2.5 is applied to the thresholds above.

6.2.8 Subsequent Test Configuration Procedures

For OFDM configurations in each frequency band and aggregated band, SAR is evaluated for initial test configuration using the fixed test position or the initial test position procedure. When the highest reported SAR (for the initial test configuration), adjusted by the ratio of the specified maximum output power of the subsequent test configuration to initial test configuration, is ≤ 1.2 W/kg, no additional SAR tests for the subsequent test configurations are required. When 10g SAR measurement is considered, a factor of 2.5 is applied to the thresholds above.

6.2.9 MIMO SAR considerations

Per KDB Publication 248227 D01v02r02, the simultaneous SAR provisions in KDB Publication 447498 D01v01 should be applied to determine simultaneous transmission SAR test exclusion for WIFI MIMO. If the sum of 1g single transmission chain SAR measurements is <1.6 W/kg, no additional SAR measurements for MIMO are required. Alternatively, SAR for MIMO can be measured with all antennas transmitting simultaneously at the specified maximum output power of MIMO operation. When 10g SAR measurement is considered, a factor of 2.5 is applied to the thresholds above.

FCC ID: C3K2085	SAR EVALUATION REPORT	Approved by: Technical Manager
Document S/N: 1M2311170118-01.C3K(R1)	DUT Type: Portable Computing Device	Page 23 of 58

REV 22.0
03/30/2022

7 RF CONDUCTED POWERS

7.1 WLAN Conducted Powers

Table 7-1
2.4 GHz WLAN Measured P_{Max} Average Power for DSI = 0 (No Motion and/or Laptop) – Antenna R

2.4GHz WIFI (20MHz 802.11b SISO ANT R)				2.4GHz WIFI (20MHz 802.11g SISO ANT R)				2.4GHz WIFI (20MHz 802.11n SISO ANT R)			
Freq. [MHz]	Channel	Detector	Conducted Power [dBm]	Freq. [MHz]	Channel	Detector	Conducted Power [dBm]	Freq. [MHz]	Channel	Detector	Conducted Power [dBm]
2412	1	Average	17.39	2412	1	Average	12.83	2412	1	Average	11.32
2417	2		17.03	2417	2		14.48	2417	2		13.46
2422	3		20.08	2422	3		15.97	2422	3		16.02
2437	6		20.01	2427	4		17.90	2427	4		16.97
2457	10		20.05	2437	6		17.90	2437	6		16.94
2462	11		17.01	2457	10		18.00	2457	10		17.09
					2462		11	15.31	2462		11
								2462	11		13.22
2.4GHz WIFI (20MHz 802.11ac SISO ANT R)				2.4GHz WIFI (20MHz 802.11ax SISO ANT R)				2.4GHz WIFI (20MHz 802.11be SISO ANT R)			
Freq. [MHz]	Channel	Detector	Conducted Power [dBm]	Freq. [MHz]	Channel	Detector	Conducted Power [dBm]	Freq. [MHz]	Channel	Detector	Conducted Power [dBm]
2412	1	Average	11.39	2412	1	Average	11.57	2412	1	Average	11.57
2417	2		13.43	2417	2		13.63	2417	2		13.65
2422	3		16.07	2422	3		16.18	2422	3		16.18
2427	4		16.87	2427	4		17.02	2427	4		17.04
2437	6		16.89	2437	6		17.07	2437	6		17.09
2452	9		17.05	2452	9		17.22	2452	9		17.24
2457	10		16.02	2457	10		16.18	2457	10		16.13
2462	11	13.31	2462	11	13.35	2462	11	13.36			

Table 7-2
2.4 GHz WLAN Measured P_{Limit} Average Power for DSI = 1 (Motion and Tablet) – Antenna R

2.4GHz WIFI (20MHz 802.11b SISO ANT R)				2.4GHz WIFI (20MHz 802.11g SISO ANT R)				2.4GHz WIFI (20MHz 802.11n SISO ANT R)			
Freq. [MHz]	Channel	Detector	Conducted Power [dBm]	Freq. [MHz]	Channel	Detector	Conducted Power [dBm]	Freq. [MHz]	Channel	Detector	Conducted Power [dBm]
2412	1	Average	17.39	2412	1	Average	12.83	2412	1	Average	11.32
2417	2		17.03	2417	2		14.48	2417	2		13.46
2422	3		18.95	2422	3		15.97	2422	3		16.02
2437	6		18.98	2427	4		17.90	2427	4		16.97
2457	10		18.85	2437	6		17.90	2437	6		16.94
2462	11		17.01	2457	10		18.00	2457	10		17.09
					2462		11	15.31	2462		11
								2462	11		13.22
2.4GHz WIFI (20MHz 802.11ac SISO ANT R)				2.4GHz WIFI (20MHz 802.11ax SISO ANT R)				2.4GHz WIFI (20MHz 802.11be SISO ANT R)			
Freq. [MHz]	Channel	Detector	Conducted Power [dBm]	Freq. [MHz]	Channel	Detector	Conducted Power [dBm]	Freq. [MHz]	Channel	Detector	Conducted Power [dBm]
2412	1	Average	11.39	2412	1	Average	11.57	2412	1	Average	11.57
2417	2		13.43	2417	2		13.63	2417	2		13.65
2422	3		16.07	2422	3		16.18	2422	3		16.18
2427	4		16.87	2427	4		17.02	2427	4		17.04
2437	6		16.89	2437	6		17.07	2437	6		17.09
2452	9		17.05	2452	9		17.22	2452	9		17.24
2457	10		16.02	2457	10		16.18	2457	10		16.13
2462	11	13.31	2462	11	13.35	2462	11	13.36			

FCC ID: C3K2085	SAR EVALUATION REPORT	Approved by: Technical Manager
Document S/N: 1M2311170118-01.C3K(R1)	DUT Type: Portable Computing Device	Page 24 of 58

Table 7-3
2.4 GHz WLAN Measured P_{Max} Average Power for DSI = 0 (No Motion and/or Laptop) – Antenna L

2.4GHz WIFI (20MHz 802.11b SISO ANT L)				2.4GHz WIFI (20MHz 802.11g SISO ANT L)				2.4GHz WIFI (20MHz 802.11n SISO ANT L)				
Freq. [MHz]	Channel	Detector	Conducted Power [dBm]	Freq. [MHz]	Channel	Detector	Conducted Power [dBm]	Freq. [MHz]	Channel	Detector	Conducted Power [dBm]	
2412	1	Average	17.12	2412	1	Average	13.13	2412	1	Average	11.66	
2417	2		17.18	2417	2		14.66	2417	2		13.67	
2422	3		20.04	2422	3		16.29	2422	3		16.32	
2437	6		19.95	2427	4		18.01	2427	4		16.98	
2457	10		19.84	2437	6		18.08	2437	6		17.02	
2462	11		17.24	2457	10		17.79	2452	9		16.70	
					2462		11	15.62	2457		10	16.08
								2462	11		13.52	
2.4GHz WIFI (20MHz 802.11ac SISO ANT L)				2.4GHz WIFI (20MHz 802.11ax SISO ANT L)				2.4GHz WIFI (20MHz 802.11be SISO ANT L)				
Freq. [MHz]	Channel	Detector	Conducted Power [dBm]	Freq. [MHz]	Channel	Detector	Conducted Power [dBm]	Freq. [MHz]	Channel		Detector	Conducted Power [dBm]
2412	1	Average	11.67	2412	1	Average	11.77	2412	1		Average	11.79
2417	2		13.66	2417	2		13.78	2417	2	13.76		
2422	3		16.36	2422	3		15.91	2422	3	15.91		
2427	4		17.06	2427	4		17.09	2427	4	17.09		
2437	6		17.01	2437	6		17.22	2437	6	17.22		
2452	9		16.73	2452	9		16.82	2452	9	16.80		
2457	10		16.08	2457	10		16.16	2457	10	16.14		
2462	11		13.54	2462	11		13.63	2462	11	13.62		

Table 7-4
2.4 GHz WLAN Measured P_{Limit} Average Power for DSI = 1 (Motion and Tablet) – Antenna L

2.4GHz WIFI (20MHz 802.11b SISO ANT L)				2.4GHz WIFI (20MHz 802.11g SISO ANT L)				2.4GHz WIFI (20MHz 802.11n SISO ANT L)				
Freq. [MHz]	Channel	Detector	Conducted Power [dBm]	Freq. [MHz]	Channel	Detector	Conducted Power [dBm]	Freq. [MHz]	Channel	Detector	Conducted Power [dBm]	
2412	1	Average	17.12	2412	1	Average	13.13	2412	1	Average	11.66	
2437	6		17.41	2417	2		14.66	2417	2		13.67	
2462	11		17.40	2422	3		16.29	2422	3		16.32	
				2427	4		16.88	2427	4		16.30	
				2437	6		16.82	2437	6		16.21	
				2457	10		16.70	2452	9		16.22	
				2462	11		15.62	2457	10		16.08	
						2462	11	13.52				
2.4GHz WIFI (20MHz 802.11ac SISO ANT L)				2.4GHz WIFI (20MHz 802.11ax SISO ANT L)				2.4GHz WIFI (20MHz 802.11be SISO ANT L)				
Freq. [MHz]	Channel	Detector	Conducted Power [dBm]	Freq. [MHz]	Channel	Detector	Conducted Power [dBm]	Freq. [MHz]	Channel		Detector	Conducted Power [dBm]
2412	1	Average	11.67	2412	1	Average	11.77	2412	1		Average	11.79
2417	2		13.66	2417	2		13.78	2417	2	13.76		
2422	3		16.36	2422	3		15.91	2422	3	15.91		
2427	4		16.32	2427	4		16.38	2427	4	16.39		
2437	6		16.20	2437	6		16.32	2437	6	16.33		
2452	9		16.23	2452	9		16.28	2452	9	16.29		
2457	10		16.08	2457	10		16.16	2457	10	16.14		
2462	11		13.54	2462	11		13.63	2462	11	13.62		

FCC ID: C3K2085	SAR EVALUATION REPORT	Approved by: Technical Manager
Document S/N: 1M2311170118-01.C3K(R1)	DUT Type: Portable Computing Device	Page 25 of 58

Table 7-5

5 GHz WLAN Measured P_{Max} Average Power for DSI = 0 (No Motion and/or Laptop) – Antenna R

5GHz WIFI (20MHz 802.11a SISO ANT R)				5GHz WIFI (20MHz 802.11n SISO ANT R)				5GHz WIFI (20MHz 802.11ac SISO ANT R)			
Band	Freq. [MHz]	Channel	Avg. Conducted Power [dBm]	Band	Freq. [MHz]	Channel	Avg. Conducted Power [dBm]	Band	Freq. [MHz]	Channel	Avg. Conducted Power [dBm]
UNII-1	5180	36	17.85	UNII-1	5180	36	17.80	UNII-1	5180	36	17.92
	5200	40	17.89		5200	40	17.48		5200	40	17.38
	5220	44	17.88		5220	44	17.42		5220	44	17.34
	5240	48	17.88		5240	48	17.37		5240	48	17.39
UNII-2A	5260	52	17.40	UNII-2A	5260	52	16.82	UNII-2A	5260	52	16.75
	5280	56	17.29		5280	56	16.75		5280	56	16.79
	5300	60	17.35		5300	60	16.89		5300	60	16.83
	5320	64	13.60		5320	64	13.62		5320	64	13.61
UNII-3	5745	149	14.04	UNII-3	5745	149	14.10	UNII-3	5745	149	14.03
	5785	157	19.65		5785	157	19.79		5785	157	19.65
	5825	165	19.50		5825	165	19.59		5825	165	19.64

5GHz WIFI (20MHz 802.11ax SISO ANT R)				5GHz WIFI (20MHz 802.11be SISO ANT R)			
Band	Freq. [MHz]	Channel	Avg. Conducted Power [dBm]	Band	Freq. [MHz]	Channel	Avg. Conducted Power [dBm]
UNII-1	5180	36	17.87	UNII-1	5180	36	17.88
	5200	40	17.45		5200	40	17.46
	5220	44	17.30		5220	44	17.29
	5240	48	17.26		5240	48	17.38
UNII-2A	5260	52	16.74	UNII-2A	5260	52	16.73
	5280	56	16.75		5280	56	16.75
	5300	60	16.83		5300	60	16.80
	5320	64	13.57		5320	64	13.56
UNII-3	5745	149	14.00	UNII-3	5745	149	14.00
	5785	157	19.53		5785	157	19.57
	5825	165	19.59		5825	165	19.55

5GHz WIFI (40MHz 802.11n SISO ANT R)				5GHz WIFI (40MHz 802.11ac SISO ANT R)				5GHz WIFI (40MHz 802.11ax SISO ANT R)				5GHz WIFI (40MHz 802.11be SISO ANT R)			
Band	Freq. [MHz]	Channel	Avg. Conducted Power [dBm]	Band	Freq. [MHz]	Channel	Avg. Conducted Power [dBm]	Band	Freq. [MHz]	Channel	Avg. Conducted Power [dBm]	Band	Freq. [MHz]	Channel	Avg. Conducted Power [dBm]
UNII-4	5835	167	16.89	UNII-4	5835	167	16.77	UNII-4	5835	167	16.83	UNII-4	5835	167	16.78
	5875	175	16.89		5875	175	16.91		5875	175	16.94		5875	175	16.92

5GHz WIFI (80MHz 802.11ac SISO ANT R)				5GHz WIFI (80MHz 802.11ax SISO ANT R)				5GHz WIFI (80MHz 802.11be SISO ANT R)			
Band	Freq. [MHz]	Channel	Avg. Conducted Power [dBm]	Band	Freq. [MHz]	Channel	Avg. Conducted Power [dBm]	Band	Freq. [MHz]	Channel	Avg. Conducted Power [dBm]
UNII-2C	5530	106	11.85	UNII-2C	5530	106	11.92	UNII-2C	5530	106	11.90
	5610	122	11.83		5610	122	11.88		5610	122	11.93
	5690	138	16.78		5690	138	16.82		5690	138	16.98

FCC ID: C3K2085	SAR EVALUATION REPORT	Approved by: Technical Manager
Document S/N: 1M2311170118-01.C3K(R1)	DUT Type: Portable Computing Device	Page 26 of 58

Table 7-6

5 GHz WLAN Measured P_{Limit} Average Power for DSI = 1 (Motion and Tablet) – Antenna R

5GHz WIFI (20MHz 802.11a SISO ANT R)				5GHz WIFI (20MHz 802.11n SISO ANT R)				5GHz WIFI (20MHz 802.11ac SISO ANT R)			
Band	Freq. [MHz]	Channel	Avg. Conducted Power [dBm]	Band	Freq. [MHz]	Channel	Avg. Conducted Power [dBm]	Band	Freq. [MHz]	Channel	Avg. Conducted Power [dBm]
UNII-1	5180	36	15.37	UNII-1	5180	36	15.43	UNII-1	5180	36	15.46
	5200	40	15.32		5200	40	15.65		5200	40	15.42
	5220	44	15.27		5220	44	15.47		5220	44	15.48
	5240	48	15.45		5240	48	15.51		5240	48	15.51
UNII-2A	5260	52	15.19	UNII-2A	5260	52	15.44	UNII-2A	5260	52	15.77
	5280	56	15.17		5280	56	15.47		5280	56	15.47
	5300	60	15.13		5300	60	15.40		5300	60	15.38
	5320	64	13.60		5320	64	13.62		5320	64	13.61

5GHz WIFI (20MHz 802.11ax SISO ANT R)				5GHz WIFI (20MHz 802.11be SISO ANT R)			
Band	Freq. [MHz]	Channel	Avg. Conducted Power [dBm]	Band	Freq. [MHz]	Channel	Avg. Conducted Power [dBm]
UNII-1	5180	36	15.46	UNII-1	5180	36	15.42
	5200	40	15.43		5200	40	15.40
	5220	44	15.47		5220	44	15.46
	5240	48	15.49		5240	48	15.50
UNII-2A	5260	52	15.46	UNII-2A	5260	52	15.48
	5280	56	15.45		5280	56	15.45
	5300	60	15.38		5300	60	15.38
	5320	64	13.57		5320	64	13.56

5GHz WIFI (40MHz 802.11n SISO ANT R)				5GHz WIFI (40MHz 802.11ac SISO ANT R)				5GHz WIFI (40MHz 802.11ax SISO ANT R)				5GHz WIFI (40MHz 802.11be SISO ANT R)			
Band	Freq. [MHz]	Channel	Avg. Conducted Power [dBm]	Band	Freq. [MHz]	Channel	Avg. Conducted Power [dBm]	Band	Freq. [MHz]	Channel	Avg. Conducted Power [dBm]	Band	Freq. [MHz]	Channel	Avg. Conducted Power [dBm]
UNII-3	5755	151	14.61	UNII-3	5755	151	14.47	UNII-3	5755	151	14.47	UNII-3	5755	151	14.47
	5795	159	14.60		5795	159	14.30		5795	159	14.16		5795	159	14.31
UNII-4	5835	167	14.63	UNII-4	5835	167	14.40	UNII-4	5835	167	14.38	UNII-4	5835	167	14.39
	5875	175	14.86		5875	175	14.54		5875	175	14.54		5875	175	14.56

5GHz WIFI (80MHz 802.11ac SISO ANT R)				5GHz WIFI (80MHz 802.11ax SISO ANT R)				5GHz WIFI (80MHz 802.11be SISO ANT R)			
Band	Freq. [MHz]	Channel	Avg. Conducted Power [dBm]	Band	Freq. [MHz]	Channel	Avg. Conducted Power [dBm]	Band	Freq. [MHz]	Channel	Avg. Conducted Power [dBm]
UNII-2C	5530	106	11.85	UNII-2C	5530	106	11.92	UNII-2C	5530	106	11.90
	5610	122	11.83		5610	122	11.88		5610	122	11.93
	5690	138	14.86		5690	138	14.93		5690	138	14.91

FCC ID: C3K2085	SAR EVALUATION REPORT	Approved by: Technical Manager
Document S/N: 1M2311170118-01.C3K(R1)	DUT Type: Portable Computing Device	Page 27 of 58

Table 7-7

5 GHz WLAN Measured P_{Max} Average Power for DSI = 0 (No Motion and/or Laptop) – Antenna L

5GHz WIFI (20MHz 802.11a SISO ANT L)				5GHz WIFI (20MHz 802.11n SISO ANT L)				5GHz WIFI (20MHz 802.11ac SISO ANT L)			
Band	Freq. [MHz]	Channel	Avg. Conducted Power [dBm]	Band	Freq. [MHz]	Channel	Avg. Conducted Power [dBm]	Band	Freq. [MHz]	Channel	Avg. Conducted Power [dBm]
UNII-1	5180	36	17.98	UNII-1	5180	36	18.03	UNII-1	5180	36	17.94
	5200	40	17.90		5200	40	17.41		5200	40	17.49
	5220	44	17.80		5220	44	17.38		5220	44	17.39
	5240	48	17.81		5240	48	17.38		5240	48	17.41
UNII-2A	5260	52	18.13	UNII-2A	5260	52	17.17	UNII-2A	5260	52	16.86
	5280	56	17.99		5280	56	17.14		5280	56	16.91
	5300	60	17.93		5300	60	17.22		5300	60	16.87
	5320	64	13.94		5320	64	13.88		5320	64	13.88
UNII-3	5745	149	14.29	UNII-3	5745	149	14.22	UNII-3	5745	149	14.22
	5785	157	19.67		5785	157	19.56		5785	157	19.64
	5825	165	19.58		5825	165	19.58		5825	165	19.56

5GHz WIFI (20MHz 802.11ax SISO ANT L)				5GHz WIFI (20MHz 802.11be SISO ANT L)			
Band	Freq. [MHz]	Channel	Avg. Conducted Power [dBm]	Band	Freq. [MHz]	Channel	Avg. Conducted Power [dBm]
UNII-1	5180	36	17.83	UNII-1	5180	36	17.88
	5200	40	17.42		5200	40	17.45
	5220	44	17.24		5220	44	17.32
	5240	48	17.25		5240	48	17.26
UNII-2A	5260	52	17.07	UNII-2A	5260	52	17.14
	5280	56	17.11		5280	56	17.12
	5300	60	17.10		5300	60	17.06
	5320	64	13.81		5320	64	13.85
UNII-3	5745	149	14.14	UNII-3	5745	149	14.17
	5785	157	19.62		5785	157	19.64
	5825	165	19.56		5825	165	19.58

5GHz WIFI (40MHz 802.11n SISO ANT L)				5GHz WIFI (40MHz 802.11ac SISO ANT L)				5GHz WIFI (40MHz 802.11ax SISO ANT L)				5GHz WIFI (20MHz 802.11be SISO ANT L)			
Band	Freq. [MHz]	Channel	Avg. Conducted Power [dBm]	Band	Freq. [MHz]	Channel	Avg. Conducted Power [dBm]	Band	Freq. [MHz]	Channel	Avg. Conducted Power [dBm]	Band	Freq. [MHz]	Channel	Avg. Conducted Power [dBm]
UNII-4	5835	167	17.66	UNII-4	5835	167	17.46	UNII-4	5835	167	17.43	UNII-4	5835	167	17.46
	5875	175	17.68		5875	175	17.48		5875	175	17.44		5875	175	17.51

5GHz WIFI (80MHz 802.11ac SISO ANT2)				5GHz WIFI (80MHz 802.11ax SISO ANT L)				5GHz WIFI (80MHz 802.11be SISO ANT L)			
Band	Freq. [MHz]	Channel	Avg. Conducted Power [dBm]	Band	Freq. [MHz]	Channel	Avg. Conducted Power [dBm]	Band	Freq. [MHz]	Channel	Avg. Conducted Power [dBm]
UNII-2C	5530	106	12.27	UNII-2C	5530	106	12.31	UNII-2C	5530	106	12.32
	5610	122	12.38		5610	122	12.50		5610	122	12.49
	5690	138	17.49		5690	138	17.25		5690	138	17.26

FCC ID: C3K2085	SAR EVALUATION REPORT	Approved by: Technical Manager
Document S/N: 1M2311170118-01.C3K(R1)	DUT Type: Portable Computing Device	Page 28 of 58

Table 7-8

5 GHz WLAN Measured P_{Limit} Average Power for DSI = 1 (Motion and Tablet) – Antenna L

5GHz WIFI (20MHz 802.11a SISO ANT L)				5GHz WIFI (20MHz 802.11n SISO ANT L)				5GHz WIFI (20MHz 802.11ac SISO ANT L)			
Band	Freq. [MHz]	Channel	Avg. Conducted Power [dBm]	Band	Freq. [MHz]	Channel	Avg. Conducted Power [dBm]	Band	Freq. [MHz]	Channel	Avg. Conducted Power [dBm]
UNII-1	5180	36	17.98	UNII-1	5180	36	17.86	UNII-1	5180	36	17.76
	5200	40	17.90		5200	40	17.73		5200	40	17.76
	5220	44	17.80		5220	44	17.56		5220	44	17.59
	5240	48	17.81		5240	48	17.59		5240	48	17.75
UNII-2A	5260	52	18.13	UNII-2A	5260	52	17.17	UNII-2A	5260	52	17.16
	5280	56	17.99		5280	56	17.14		5280	56	17.21
	5300	60	17.93		5300	60	17.22		5300	60	17.17
	5320	64	13.94		5320	64	13.88		5320	64	13.88

5GHz WIFI (20MHz 802.11ax SISO ANT L)				5GHz WIFI (20MHz 802.11be SISO ANT L)			
Band	Freq. [MHz]	Channel	Avg. Conducted Power [dBm]	Band	Freq. [MHz]	Channel	Avg. Conducted Power [dBm]
UNII-1	5180	36	17.77	UNII-1	5180	36	17.82
	5200	40	17.76		5200	40	17.68
	5220	44	17.58		5220	44	17.57
	5240	48	17.63		5240	48	17.63
UNII-2A	5260	52	17.07	UNII-2A	5260	52	17.14
	5280	56	17.11		5280	56	17.12
	5300	60	17.10		5300	60	17.06
	5320	64	13.81		5320	64	13.85

5GHz WIFI (40MHz 802.11n SISO ANT L)				5GHz WIFI (40MHz 802.11ac SISO ANT L)				5GHz WIFI (40MHz 802.11ax SISO ANT L)				5GHz WIFI (20MHz 802.11be SISO ANT L)			
Band	Freq. [MHz]	Channel	Avg. Conducted Power [dBm]	Band	Freq. [MHz]	Channel	Avg. Conducted Power [dBm]	Band	Freq. [MHz]	Channel	Avg. Conducted Power [dBm]	Band	Freq. [MHz]	Channel	Avg. Conducted Power [dBm]
UNII-3	5755	151	16.34	UNII-3	5755	151	16.39	UNII-3	5755	151	16.44	UNII-3	5755	151	16.38
	5795	159	17.18		5795	159	16.39		5795	159	16.42		5795	159	16.37
UNII-4	5835	167	17.39	UNII-4	5835	167	16.56	UNII-4	5835	167	16.55	UNII-4	5835	167	16.54
	5875	175	17.42		5875	175	16.56		5875	175	16.61		5875	175	16.63

5GHz WIFI (80MHz 802.11ac SISO ANT L)				5GHz WIFI (80MHz 802.11ax SISO ANT L)				5GHz WIFI (80MHz 802.11be SISO ANT L)			
Band	Freq. [MHz]	Channel	Avg. Conducted Power [dBm]	Band	Freq. [MHz]	Channel	Avg. Conducted Power [dBm]	Band	Freq. [MHz]	Channel	Avg. Conducted Power [dBm]
UNII-2C	5530	106	12.27	UNII-2C	5530	106	12.31	UNII-2C	5530	106	12.32
	5610	122	12.38		5610	122	12.50		5610	122	12.49
	5690	138	17.31		5690	138	17.25		5690	138	17.26

FCC ID: C3K2085	SAR EVALUATION REPORT	Approved by: Technical Manager
Document S/N: 1M2311170118-01.C3K(R1)	DUT Type: Portable Computing Device	Page 29 of 58

Table 7-9

6 GHz WLAN Measured P_{Max} Average Power for DSI = 0 (No Motion and/or Laptop) – Antenna R

6GHz WIFI (40MHz 802.11ax SISO ANT R)				6GHz WIFI (40MHz 802.11be SISO ANT R)			
Band	Freq. [MHz]	Channel	Avg. Conducted Power [dBm]	Band	Freq. [MHz]	Channel	Avg. Conducted Power [dBm]
UNII-5	5965	3	16.76	UNII-5	5965	3	16.62
	6005	11	19.13		6005	11	19.14
	6285	67	18.81		6285	67	18.82
6GHz WIFI (80MHz 802.11ax SISO ANT R)				6GHz WIFI (80MHz 802.11be SISO ANT R)			
Band	Freq. [MHz]	Channel	Avg. Conducted Power [dBm]	Band	Freq. [MHz]	Channel	Avg. Conducted Power [dBm]
UNII-7	6705	151	18.39	UNII-7	6705	151	18.46
6GHz WIFI (320MHz 802.11be SISO ANT R)							
Band	Freq. [MHz]	Channel	Avg. Conducted Power [dBm]				
UNII-6	6425	95	9.53				
UNII-8	6905	191	9.58				

Table 7-10

6 GHz WLAN Measured P_{Limit} Average Power for DSI = 1 (Motion and Tablet) – Antenna R

6GHz WIFI (80MHz 802.11be SISO ANT R)				6GHz WIFI (80MHz 802.11ax SISO ANT R)			
Band	Freq. [MHz]	Channel	Avg. Conducted Power [dBm]	Band	Freq. [MHz]	Channel	Avg. Conducted Power [dBm]
UNII-5	5985	7	13.59	UNII-5	5985	7	13.35
	6305	71	13.36		6305	71	13.31
UNII-7	6705	151	14.17	UNII-7	6705	151	14.44
6GHz WIFI (320MHz 802.11be SISO ANT R)							
Band	Freq. [MHz]	Channel	Avg. Conducted Power [dBm]				
UNII-6	6425	95	9.53				
UNII-8	6905	191	9.58				

FCC ID: C3K2085	SAR EVALUATION REPORT	Approved by: Technical Manager
Document S/N: 1M2311170118-01.C3K(R1)	DUT Type: Portable Computing Device	Page 30 of 58

Table 7-11

6 GHz WLAN Measured P_{Max} Average Power for DSI = 0 (No Motion and/or Laptop) – Antenna L

6GHz WIFI (40MHz 802.11ax SISO ANT L)				6GHz WIFI (40MHz 802.11be SISO ANT L)			
Band	Freq. [MHz]	Channel	Avg. Conducted Power [dBm]	Band	Freq. [MHz]	Channel	Avg. Conducted Power [dBm]
UNII-5	5965	3	16.38	UNII-5	5965	3	16.39
	6005	11	19.00		6005	11	19.05
	6285	67	18.92		6285	67	18.83
6GHz WIFI (80MHz 802.11ax SISO ANT L)				6GHz WIFI (80MHz 802.11be SISO ANT L)			
Band	Freq. [MHz]	Channel	Avg. Conducted Power [dBm]	Band	Freq. [MHz]	Channel	Avg. Conducted Power [dBm]
UNII-7	6705	151	18.78	UNII-7	6705	151	18.77
6GHz WIFI (320MHz 802.11be SISO ANT L)							
Band	Freq. [MHz]	Channel	Avg. Conducted Power [dBm]				
UNII-6	6425	95	9.57				
UNII-8	6905	191	9.52				

Table 7-12

6 GHz WLAN Measured P_{Limit} Average Power for DSI = 1 (Motion and Tablet) – Antenna L

6GHz WIFI (80MHz 802.11ax SISO ANT L)				6GHz WIFI (80MHz 802.11be SISO ANT L)			
Band	Freq. [MHz]	Channel	Avg. Conducted Power [dBm]	Band	Freq. [MHz]	Channel	Avg. Conducted Power [dBm]
UNII-5	5985	7	13.21	UNII-5	5985	7	13.21
	6305	71	13.15		6305	71	13.07
UNII-7	6705	151	13.69	UNII-7	6705	151	13.84
6GHz WIFI (320MHz 802.11be SISO ANT L)							
Band	Freq. [MHz]	Channel	Avg. Conducted Power [dBm]				
UNII-6	6425	95	9.57				
UNII-8	6905	191	9.52				

Justification for test configurations for WLAN per KDB Publication 248227 D01v02r02:

- Power measurements were performed for the transmission mode configuration with the highest maximum output power specified for production units.
- For transmission modes with the same maximum output power specification, powers were measured for the largest channel bandwidth, lowest order modulation and lowest data rate.
- For transmission modes with identical maximum specified output power, channel bandwidth, modulation and data rates, power measurements were required for all identical configurations.
- For each transmission mode configuration, powers were measured for the highest and lowest channels; and at the mid-band channel(s) when there were at least 3 channels supported. For configurations with multiple mid-band channels, due to an even number of channels, both channels were measured.

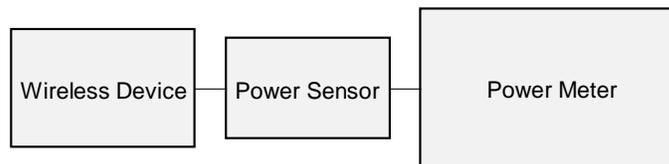

**Figure 7-1
Power Measurement Setup**

FCC ID: C3K2085	SAR EVALUATION REPORT	Approved by: Technical Manager
Document S/N: 1M2311170118-01.C3K(R1)	DUT Type: Portable Computing Device	Page 31 of 58

7.2 Bluetooth Conducted Powers

Table 7-13
Bluetooth Maximum Average RF Power– Antenna R

Frequency [MHz]	Channel No.	Avg Conducted Power	
		[dBm]	[mW]
2402	0	19.69	93.111
2441	39	20.13	103.039
2480	78	19.64	92.045

Table 7-14
Bluetooth Reduced Average RF Power in Tablet – Antenna R

Frequency [MHz]	Channel No.	Avg Conducted Power	
		[dBm]	[mW]
2402	0	17.76	59.704
2441	39	18.01	63.241
2480	78	17.45	55.590

Table 7-15
Bluetooth Reduced Average RF Power during conditions with 2.4/5/6 GHz WLAN – Antenna R

Frequency [MHz]	Channel No.	Avg Conducted Power	
		[dBm]	[mW]
2402	0	13.95	24.831
2441	39	13.97	24.946
2480	78	13.38	21.777

Table 7-16
Bluetooth Maximum Average RF Power– Antenna L

Frequency [MHz]	Channel No.	Avg Conducted Power	
		[dBm]	[mW]
2402	0	20.26	106.170
2441	39	20.94	124.165
2480	78	20.51	112.460

Table 7-17
Bluetooth Reduced Average RF Power in Tablet – Antenna L

Frequency [MHz]	Channel No.	Avg Conducted Power	
		[dBm]	[mW]
2402	0	18.24	66.681
2441	39	18.25	66.834
2480	78	17.42	55.208

Table 7-18
Bluetooth Reduced Average RF Power with 2.4/5/6 GHz WLAN – Antenna L

Frequency [MHz]	Channel No.	Avg Conducted Power	
		[dBm]	[mW]
2402	0	12.97	19.815
2441	39	12.99	19.907
2480	78	12.53	17.906

FCC ID: C3K2085	SAR EVALUATION REPORT	Approved by: Technical Manager
Document S/N: 1M2311170118-01.C3K(R1)	DUT Type: Portable Computing Device	Page 32 of 58

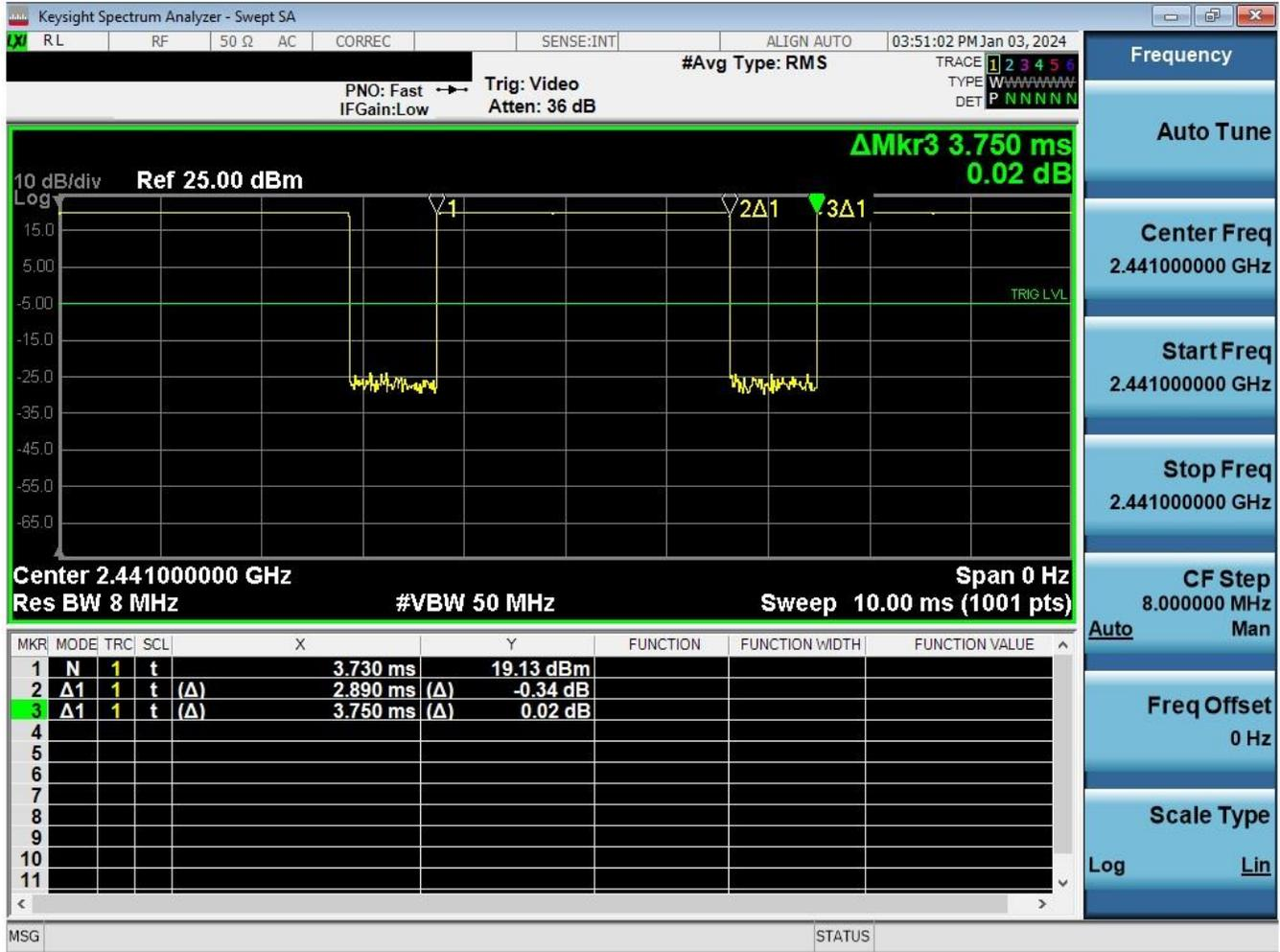

Figure 7-2
Bluetooth Antenna 1 Transmission Plot

Equation 7-1
Bluetooth Antenna 1 Duty Cycle Calculation

$$Duty\ Cycle = \frac{Pulse\ Width}{Period} * 100\% = \frac{2.89ms}{3.75ms} * 100\% = 77.1\%$$

FCC ID: C3K2085	SAR EVALUATION REPORT	Approved by: Technical Manager
Document S/N: 1M2311170118-01.C3K(R1)	DUT Type: Portable Computing Device	Page 33 of 58

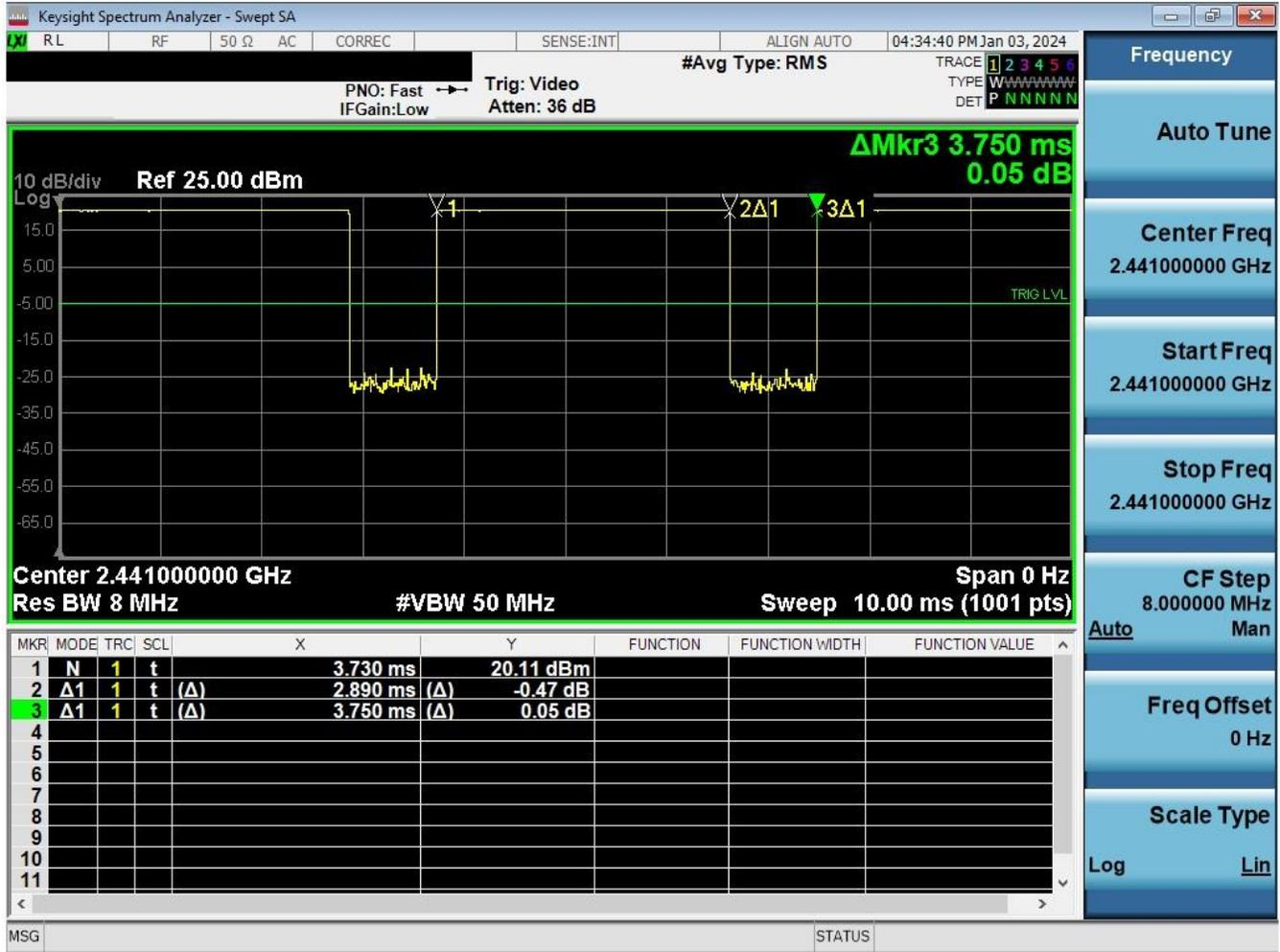

Figure 7-3
Bluetooth Antenna 2 Transmission Plot

Equation 7-2
Bluetooth Antenna 2 Duty Cycle Calculation

$$Duty\ Cycle = \frac{Pulse\ Width}{Period} * 100\% = \frac{2.89ms}{3.75ms} * 100\% = 77.1\%$$

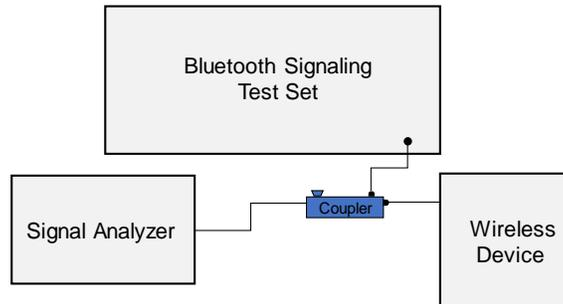

Figure 7-4
Power Measurement Setup

FCC ID: C3K2085	SAR EVALUATION REPORT	Approved by: Technical Manager
Document S/N: 1M2311170118-01.C3K(R1)	DUT Type: Portable Computing Device	Page 34 of 58

8 SYSTEM VERIFICATION

8.1 Tissue Verification

**Table 8-1
Measured Head Tissue Properties**

Calibrated for Tests Performed on:	Tissue Type	Tissue Temp During Calibration (°C)	Measured Frequency (MHz)	Measured Conductivity, σ (S/m)	Measured Dielectric Constant, ϵ	TARGET Conductivity, σ (S/m)	TARGET Dielectric Constant, ϵ	% dev σ	% dev ϵ
03/11/2024	30 Head	20.2	12	0.733	52.513	0.750	55.000	-2.27%	-4.52%
			13	0.733	52.735	0.750	55.000	-2.27%	-4.12%
			14	0.733	52.891	0.750	55.000	-2.27%	-3.83%
02/19/2024	2450 Head	19.0	2300	1.741	41.202	1.670	39.500	4.25%	4.31%
			2310	1.750	41.188	1.679	39.480	4.23%	4.33%
			2320	1.758	41.176	1.687	39.460	4.21%	4.35%
			2400	1.824	41.031	1.756	39.289	3.87%	4.43%
			2450	1.867	40.945	1.800	39.200	3.72%	4.45%
			2480	1.891	40.885	1.833	39.162	3.16%	4.40%
			2500	1.908	40.847	1.855	39.136	2.86%	4.37%
			2510	1.917	40.828	1.866	39.123	2.73%	4.36%
			2535	1.939	40.780	1.893	39.092	2.43%	4.32%
			2550	1.953	40.750	1.909	39.073	2.30%	4.29%
			2560	1.962	40.730	1.920	39.060	2.19%	4.28%
			2600	1.997	40.664	1.964	39.009	1.68%	4.24%
			2650	2.040	40.553	2.018	38.945	1.09%	4.13%
			2680	2.068	40.501	2.051	38.907	0.83%	4.10%
			2700	2.085	40.476	2.073	38.882	0.58%	4.10%
03/07/2024	2450 Head	21.7	2300	1.681	39.173	1.670	39.500	0.66%	-0.83%
			2310	1.688	39.161	1.679	39.480	0.54%	-0.81%
			2320	1.695	39.152	1.687	39.460	0.47%	-0.78%
			2400	1.754	39.050	1.756	39.289	-0.11%	-0.61%
			2450	1.794	38.992	1.800	39.200	-0.33%	-0.53%
			2480	1.817	38.940	1.833	39.162	-0.87%	-0.57%
			2500	1.832	38.909	1.855	39.136	-1.24%	-0.58%
			2510	1.840	38.894	1.866	39.123	-1.39%	-0.59%
			2535	1.861	38.854	1.893	39.092	-1.69%	-0.61%
			2550	1.874	38.830	1.909	39.073	-1.83%	-0.62%
			2560	1.883	38.809	1.920	39.060	-1.93%	-0.64%
			2600	1.915	38.748	1.964	39.009	-2.49%	-0.67%
			2650	1.955	38.650	2.018	38.945	-3.12%	-0.76%
			2680	1.980	38.601	2.051	38.907	-3.46%	-0.79%
			2700	1.995	38.580	2.073	38.882	-3.76%	-0.78%
03/08/2024	2450 Head	19.2	2300	1.669	39.851	1.670	39.500	-0.06%	0.89%
			2310	1.678	39.833	1.679	39.480	-0.06%	0.89%
			2320	1.686	39.819	1.687	39.460	-0.06%	0.91%
			2400	1.745	39.705	1.756	39.289	-0.63%	1.06%
			2450	1.790	39.620	1.800	39.200	-0.56%	1.07%
			2480	1.813	39.567	1.833	39.162	-1.09%	1.03%
			2500	1.826	39.544	1.855	39.136	-1.56%	1.04%
			2510	1.834	39.529	1.866	39.123	-1.71%	1.04%
			2535	1.857	39.486	1.893	39.092	-1.90%	1.01%
			2550	1.873	39.455	1.909	39.073	-1.89%	0.98%
			2560	1.883	39.432	1.920	39.060	-1.93%	0.95%
			2600	1.914	39.382	1.964	39.009	-2.55%	0.96%
			2650	1.955	39.283	2.018	38.945	-3.12%	0.87%
			2680	1.985	39.224	2.051	38.907	-3.22%	0.81%
			2700	2.002	39.214	2.073	38.882	-3.42%	0.85%
04/05/2024	2450 Head	24.5	2300	1.691	40.015	1.670	39.500	1.26%	1.30%
			2310	1.703	39.980	1.679	39.480	1.43%	1.27%
			2320	1.714	39.945	1.687	39.460	1.60%	1.23%
			2400	1.803	39.616	1.756	39.289	2.68%	0.83%
			2450	1.860	39.429	1.800	39.200	3.33%	0.58%
			2480	1.894	39.308	1.833	39.162	3.33%	0.37%
			2500	1.917	39.229	1.855	39.136	3.34%	0.24%
			2510	1.929	39.191	1.866	39.123	3.38%	0.17%
			2535	1.959	39.093	1.893	39.092	3.49%	0.00%
			2550	1.977	39.036	1.909	39.073	3.56%	-0.09%
			2560	1.989	38.995	1.920	39.060	3.59%	-0.17%
			2600	2.036	38.835	1.964	39.009	3.67%	-0.45%
			2650	2.094	38.623	2.018	38.945	3.77%	-0.83%
			2680	2.132	38.503	2.051	38.907	3.95%	-1.04%
			2700	2.155	38.434	2.073	38.882	3.96%	-1.15%

FCC ID: C3K2085	SAR EVALUATION REPORT	Approved by: Technical Manager
Document S/N: 1M2311170118-01.C3K(R1)	DUT Type: Portable Computing Device	Page 35 of 58

**Table 8-2
Measured Head Tissue Properties**

Calibrated for Tests Performed on:	Tissue Type	Tissue Temp During Calibration (°C)	Measured Frequency (MHz)	Measured Conductivity, σ (S/m)	Measured Dielectric Constant, ϵ	TARGET Conductivity, σ (S/m)	TARGET Dielectric Constant, ϵ	% dev σ	% dev ϵ
02/25/2024	5200-5800 Head	21.2	5180	4.545	36.326	4.635	36.009	-1.94%	0.88%
			5190	4.553	36.313	4.645	35.998	-1.98%	0.88%
			5200	4.561	36.305	4.655	35.986	-2.02%	0.89%
			5210	4.569	36.289	4.666	35.975	-2.08%	0.87%
			5220	4.580	36.270	4.676	35.963	-2.05%	0.85%
			5240	4.600	36.224	4.696	35.940	-2.04%	0.79%
			5250	4.610	36.208	4.706	35.929	-2.04%	0.78%
			5260	4.621	36.189	4.717	35.917	-2.04%	0.76%
			5270	4.635	36.157	4.727	35.906	-1.95%	0.70%
			5280	4.647	36.132	4.737	35.894	-1.90%	0.66%
			5290	4.656	36.120	4.748	35.883	-1.94%	0.66%
			5300	4.665	36.120	4.758	35.871	-1.95%	0.69%
			5310	4.675	36.110	4.768	35.860	-1.95%	0.70%
			5320	4.686	36.091	4.778	35.849	-1.93%	0.68%
			5500	4.880	35.752	4.963	35.643	-1.67%	0.31%
			5510	4.886	35.730	4.973	35.632	-1.75%	0.28%
			5520	4.897	35.699	4.983	35.620	-1.73%	0.22%
			5530	4.911	35.671	4.994	35.609	-1.66%	0.17%
			5540	4.925	35.650	5.004	35.597	-1.58%	0.15%
			5550	4.940	35.622	5.014	35.586	-1.48%	0.10%
			5560	4.956	35.601	5.024	35.574	-1.35%	0.08%
			5580	4.981	35.597	5.045	35.551	-1.27%	0.13%
			5600	4.997	35.568	5.065	35.529	-1.34%	0.11%
			5610	5.005	35.552	5.076	35.518	-1.40%	0.10%
			5620	5.014	35.523	5.086	35.506	-1.42%	0.05%
			5640	5.049	35.467	5.106	35.483	-1.12%	-0.05%
			5660	5.078	35.466	5.127	35.460	-0.96%	0.02%
			5670	5.085	35.465	5.137	35.449	-1.01%	0.05%
			5680	5.097	35.458	5.147	35.437	-0.97%	0.06%
			5690	5.105	35.445	5.158	35.426	-1.03%	0.05%
			5700	5.115	35.419	5.168	35.414	-1.03%	0.01%
			5710	5.127	35.381	5.178	35.403	-0.98%	-0.06%
			5720	5.137	35.351	5.188	35.391	-0.98%	-0.11%
			5745	5.170	35.343	5.214	35.363	-0.84%	-0.06%
5750	5.180	35.337	5.219	35.357	-0.75%	-0.06%			
5755	5.187	35.333	5.224	35.351	-0.71%	-0.05%			
5765	5.196	35.306	5.234	35.340	-0.73%	-0.10%			
5775	5.205	35.294	5.245	35.329	-0.76%	-0.10%			
5785	5.214	35.291	5.255	35.317	-0.78%	-0.07%			
5795	5.228	35.277	5.265	35.305	-0.70%	-0.08%			
5805	5.241	35.250	5.275	35.294	-0.64%	-0.12%			
5825	5.265	35.211	5.296	35.271	-0.59%	-0.17%			
5835	5.276	35.197	5.305	35.230	-0.55%	-0.09%			
5845	5.286	35.186	5.315	35.210	-0.55%	-0.07%			
5850	5.291	35.176	5.320	35.200	-0.55%	-0.07%			
5855	5.295	35.171	5.325	35.197	-0.56%	-0.07%			
5875	5.320	35.155	5.347	35.183	-0.50%	-0.08%			
5885	5.328	35.144	5.357	35.177	-0.54%	-0.09%			
5905	5.340	35.085	5.379	35.163	-0.73%	-0.22%			

FCC ID: C3K2085	SAR EVALUATION REPORT	Approved by: Technical Manager
Document S/N: 1M2311170118-01.C3K(R1)	DUT Type: Portable Computing Device	Page 36 of 58

**Table 8-3
Measured Head Tissue Properties**

Calibrated for Tests Performed on:	Tissue Type	Tissue Temp During Calibration (°C)	Measured Frequency (MHz)	Measured Conductivity, σ (S/m)	Measured Dielectric Constant, ϵ	TARGET Conductivity, σ (S/m)	TARGET Dielectric Constant, ϵ	% dev σ	% dev ϵ
03/15/2024	5200-5800 Head	22.8	5180	4.533	35.792	4.635	36.009	-2.20%	-0.60%
			5190	4.541	35.770	4.645	35.998	-2.24%	-0.63%
			5200	4.553	35.766	4.655	35.986	-2.19%	-0.61%
			5210	4.566	35.750	4.666	35.975	-2.14%	-0.63%
			5220	4.577	35.729	4.676	35.963	-2.12%	-0.65%
			5240	4.599	35.679	4.696	35.940	-2.07%	-0.73%
			5250	4.611	35.670	4.706	35.929	-2.02%	-0.72%
			5260	4.622	35.656	4.717	35.917	-2.01%	-0.73%
			5270	4.631	35.635	4.727	35.906	-2.03%	-0.75%
			5280	4.643	35.610	4.737	35.894	-1.98%	-0.79%
			5290	4.657	35.589	4.748	35.883	-1.92%	-0.82%
			5300	4.669	35.577	4.758	35.871	-1.87%	-0.82%
			5310	4.680	35.560	4.768	35.860	-1.85%	-0.84%
			5320	4.688	35.541	4.778	35.849	-1.88%	-0.86%
			5500	4.884	35.205	4.963	35.643	-1.59%	-1.23%
			5510	4.899	35.204	4.973	35.632	-1.49%	-1.20%
			5520	4.909	35.189	4.983	35.620	-1.49%	-1.21%
			5530	4.916	35.163	4.994	35.609	-1.56%	-1.25%
			5540	4.928	35.130	5.004	35.597	-1.52%	-1.31%
			5550	4.945	35.115	5.014	35.586	-1.38%	-1.32%
			5560	4.962	35.106	5.024	35.574	-1.23%	-1.32%
			5580	4.978	35.059	5.045	35.551	-1.33%	-1.38%
			5600	5.007	35.031	5.065	35.529	-1.15%	-1.40%
			5610	5.016	35.022	5.076	35.518	-1.18%	-1.40%
			5620	5.025	35.007	5.086	35.506	-1.20%	-1.41%
			5640	5.055	34.957	5.106	35.483	-1.00%	-1.48%
			5660	5.073	34.915	5.127	35.460	-1.05%	-1.54%
			5670	5.085	34.911	5.137	35.449	-1.01%	-1.52%
			5680	5.099	34.901	5.147	35.437	-0.93%	-1.51%
			5690	5.112	34.879	5.158	35.426	-0.89%	-1.54%
			5700	5.124	34.851	5.168	35.414	-0.85%	-1.59%
			5710	5.138	34.833	5.178	35.403	-0.77%	-1.61%
			5720	5.157	34.815	5.188	35.391	-0.60%	-1.63%
			5745	5.175	34.773	5.214	35.363	-0.75%	-1.67%
			5750	5.179	34.768	5.219	35.357	-0.77%	-1.67%
			5755	5.183	34.757	5.224	35.351	-0.78%	-1.68%
			5765	5.197	34.735	5.234	35.340	-0.71%	-1.71%
			5775	5.209	34.718	5.245	35.329	-0.69%	-1.73%
			5785	5.220	34.702	5.255	35.317	-0.67%	-1.74%
			5795	5.235	34.685	5.265	35.305	-0.57%	-1.76%
5800	5.241	34.679	5.270	35.300	-0.55%	-1.76%			
5800	5.241	34.679	5.270	35.300	-0.55%	-1.76%			
5805	5.248	34.671	5.275	35.294	-0.51%	-1.77%			
5825	5.275	34.641	5.296	35.271	-0.40%	-1.79%			
5835	5.285	34.612	5.305	35.230	-0.38%	-1.75%			
5845	5.293	34.599	5.315	35.210	-0.41%	-1.74%			
5850	5.296	34.592	5.320	35.200	-0.45%	-1.73%			
5855	5.302	34.591	5.325	35.197	-0.43%	-1.72%			
5865	5.313	34.577	5.336	35.190	-0.43%	-1.74%			
5865	5.313	34.577	5.336	35.190	-0.43%	-1.74%			
5865	5.313	34.577	5.336	35.190	-0.43%	-1.74%			
5875	5.328	34.569	5.347	35.183	-0.36%	-1.75%			
5885	5.340	34.543	5.357	35.177	-0.32%	-1.80%			
5905	5.358	34.507	5.379	35.163	-0.39%	-1.87%			

FCC ID: C3K2085	SAR EVALUATION REPORT	Approved by: Technical Manager
Document S/N: 1M2311170118-01.C3K(R1)	DUT Type: Portable Computing Device	Page 37 of 58

**Table 8-4
Measured Head Tissue Properties**

Calibrated for Tests Performed on:	Tissue Type	Tissue Temp During Calibration (°C)	Measured Frequency (MHz)	Measured Conductivity, σ (S/m)	Measured Dielectric Constant, ϵ	TARGET Conductivity, σ (S/m)	TARGET Dielectric Constant, ϵ	% dev σ	% dev ϵ
02/12/2024	6000 Head	19.1	6000	5.393	35.886	5.480	35.100	-1.59%	2.24%
			6025	5.426	35.831	5.510	35.070	-1.52%	2.17%
			6065	5.473	35.719	5.557	35.022	-1.51%	1.99%
			6075	5.491	35.695	5.569	35.010	-1.40%	1.96%
			6085	5.510	35.679	5.580	34.998	-1.25%	1.95%
			6185	5.648	35.550	5.698	34.878	-0.88%	1.93%
			6275	5.761	35.355	5.805	34.770	-0.76%	1.68%
			6285	5.771	35.341	5.816	34.758	-0.77%	1.68%
			6305	5.789	35.294	5.840	34.734	-0.87%	1.61%
			6345	5.853	35.197	5.887	34.686	-0.58%	1.47%
			6475	6.003	35.028	6.041	34.530	-0.63%	1.44%
			6485	6.008	35.010	6.052	34.518	-0.73%	1.43%
			6500	6.026	34.959	6.070	34.500	-0.72%	1.33%
			6505	6.035	34.937	6.076	34.494	-0.67%	1.28%
			6545	6.113	34.878	6.122	34.446	-0.15%	1.25%
			6665	6.231	34.676	6.265	34.302	-0.54%	1.09%
			6675	6.238	34.637	6.273	34.290	-0.56%	1.01%
			6685	6.251	34.606	6.285	34.278	-0.54%	0.96%
			6715	6.304	34.577	6.319	34.242	-0.24%	0.98%
			6785	6.385	34.410	6.400	34.158	-0.23%	0.74%
			6825	6.431	34.381	6.447	34.110	-0.25%	0.79%
			6985	6.628	34.050	6.633	33.918	-0.08%	0.39%
			6995	6.639	34.039	6.644	33.906	-0.08%	0.39%
			7000	6.645	34.040	6.650	33.900	-0.08%	0.41%
			7005	6.649	34.037	6.656	33.894	-0.11%	0.42%
			7025	6.669	33.976	6.680	33.870	-0.16%	0.31%
			7500	7.303	33.169	7.240	33.300	0.87%	-0.39%
			02/19/2024	6000 Head	21.2	6000	5.678	36.147	5.480
6025	5.684	36.073				5.510	35.070	3.16%	2.86%
6065	5.741	35.929				5.557	35.022	3.31%	2.59%
6075	5.761	35.898				5.569	35.010	3.45%	2.54%
6085	5.779	35.881				5.580	34.998	3.57%	2.52%
6185	5.917	35.746				5.698	34.878	3.84%	2.49%
6275	6.033	35.569				5.805	34.770	3.93%	2.30%
6285	6.045	35.563				5.816	34.758	3.94%	2.32%
6305	6.053	35.515				5.840	34.734	3.65%	2.25%
6345	6.109	35.398				5.887	34.686	3.77%	2.05%
6475	6.257	35.238				6.041	34.530	3.58%	2.05%
6485	6.261	35.215				6.052	34.518	3.45%	2.02%
6500	6.280	35.150				6.070	34.500	3.46%	1.88%
6505	6.290	35.122				6.076	34.494	3.52%	1.82%
6545	6.381	35.042				6.122	34.446	4.23%	1.73%
6665	6.496	34.900				6.265	34.302	3.69%	1.74%
6675	6.502	34.859				6.273	34.290	3.65%	1.66%
6685	6.513	34.816				6.285	34.278	3.63%	1.57%
6715	6.572	34.778				6.319	34.242	4.00%	1.57%
6785	6.642	34.617				6.400	34.158	3.78%	1.34%
6825	6.696	34.614				6.447	34.110	3.86%	1.48%
6985	6.891	34.210				6.633	33.918	3.89%	0.86%
6995	6.906	34.204				6.644	33.906	3.94%	0.88%
7000	6.906	34.205				6.650	33.900	3.85%	0.90%
7005	6.907	34.202				6.656	33.894	3.77%	0.91%
7025	6.911	34.152				6.680	33.870	3.46%	0.83%
7500	7.561	33.296				7.240	33.300	4.43%	-0.01%

The above measured tissue parameters were used in the DASY software. The DASY software was used to perform interpolation to determine the dielectric parameters at the SAR test device frequencies (per KDB Publication 865664 D01v01r04 and IEEE 1528-2013 6.6.1.2. The tissue parameters listed in the SAR test plots may slightly differ from the table above due to significant digit rounding in the software.

FCC ID: C3K2085	SAR EVALUATION REPORT	Approved by: Technical Manager
Document S/N: 1M2311170118-01.C3K(R1)	DUT Type: Portable Computing Device	Page 38 of 58

8.2 Test System Verification

Prior to SAR assessment, the system is verified to $\pm 10\%$ of the SAR measurement on the reference dipole at the time of calibration by the calibration facility. Full system validation status and result summary can be found in the SAR System Validation Appendix.

**Table 8-5
System Verification Results**

System Verification TARGET & MEASURED																	
SAR System	Tissue Frequency (MHz)	Tissue Type	Date	Amb. Temp. (C)	Liquid Temp. (C)	Input Power (W)	Source SN	Probe SN	DAE	Measured SAR 1g (W/kg)	1W Target SAR 1g (W/kg)	1W Normalized SAR 1g (W/kg)	Deviation 1g (%)	Measured SAR 10g (W/kg)	1W Target SAR 10g (W/kg)	1W Normalized SAR 10g (W/kg)	Deviation 10g (%)
G	13	HEAD	03/11/2024	19.8	19.0	1.00	1002	7713	1530	0.530	0.523	0.530	1.34%	0.326	0.327	0.326	-0.31%
O	2450	HEAD	02/19/2024	20.2	19.0	0.10	981	7803	1533	5.120	53.900	51.200	-5.01%	2.390	25.400	23.900	-5.91%
M	2450	HEAD	03/07/2024	20.6	20.6	0.10	719	7551	1323	5.640	55.000	56.400	2.55%	2.650	25.700	26.500	3.11%
L	2450	HEAD	03/08/2024	19.7	19.7	0.10	719	7409	1334	5.470	55.000	54.700	-0.55%	2.560	25.700	25.600	-0.39%
L	2450	HEAD	04/05/2024	21.1	22.6	0.10	719	7409	1334	5.440	55.000	54.400	-1.09%	2.470	25.700	24.700	-3.89%
G	5250	HEAD	02/25/2024	21.2	21.2	0.05	1191	7713	1530	3.660	78.900	73.200	-7.22%	1.040	22.700	20.800	-8.37%
O	5250	HEAD	03/15/2024	23.9	22.8	0.05	1057	7803	1533	3.640	79.400	72.800	-8.31%	1.050	22.700	21.000	-7.49%
G	5600	HEAD	02/25/2024	21.2	21.2	0.05	1191	7713	1530	4.060	83.000	81.200	-2.17%	1.130	23.900	22.600	-5.44%
O	5600	HEAD	03/15/2024	23.9	22.8	0.05	1057	7803	1533	4.070	82.800	81.400	-1.69%	1.160	23.600	23.200	-1.69%
G	5750	HEAD	02/25/2024	21.2	21.2	0.05	1191	7713	1530	3.800	78.900	76.000	-3.68%	1.080	22.400	21.600	-3.57%
O	5750	HEAD	03/15/2024	23.9	22.8	0.05	1057	7803	1533	3.830	79.800	76.600	-4.01%	1.090	22.700	21.800	-3.96%
G	5850	HEAD	02/25/2024	21.2	21.2	0.05	1191	7713	1530	3.790	78.800	75.800	-3.81%	1.060	22.500	21.200	-5.78%
O	5850	HEAD	03/15/2024	23.9	22.8	0.05	1057	7803	1533	3.980	81.500	79.600	-2.33%	1.130	23.000	22.600	-1.74%
H	6500	HEAD	02/12/2024	23.3	20.9	0.03	1018	7718	1368	7.500	293.000	300.000	2.39%	1.380	53.900	55.200	2.41%
R	6500	HEAD	02/19/2024	19.6	19.4	0.03	1020	7410	1638	7.550	292.000	302.000	3.42%	1.420	53.900	56.800	5.38%

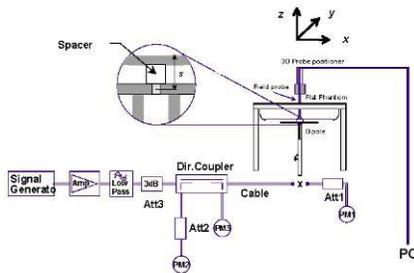

Figure 8-1

System Verification Setup Diagram



Figure 8-2

System Verification Setup Photo

FCC ID: C3K2085	SAR EVALUATION REPORT	Approved by: Technical Manager
Document S/N: 1M2311170118-01.C3K(R1)	DUT Type: Portable Computing Device	Page 39 of 58

8.3 Power Density Test System Verification

The system was verified to be within ± 0.66 dB of the power density targets on the calibration certificate according to the test system specification in the user's manual and calibration facility recommendation. The 0.66 dB deviation threshold represents the expanded uncertainty for system performance checks using SPEAG's mmWave verification sources. The same spatial resolution and measurement region used in the source calibration was applied during the system check.

The measured power density distribution of verification source was also confirmed through visual inspection to have no noticeable differences, both spatially (shape) and numerically (level) from the distribution provided by the manufacturer, per November 2017 TCBC Workshop Notes.

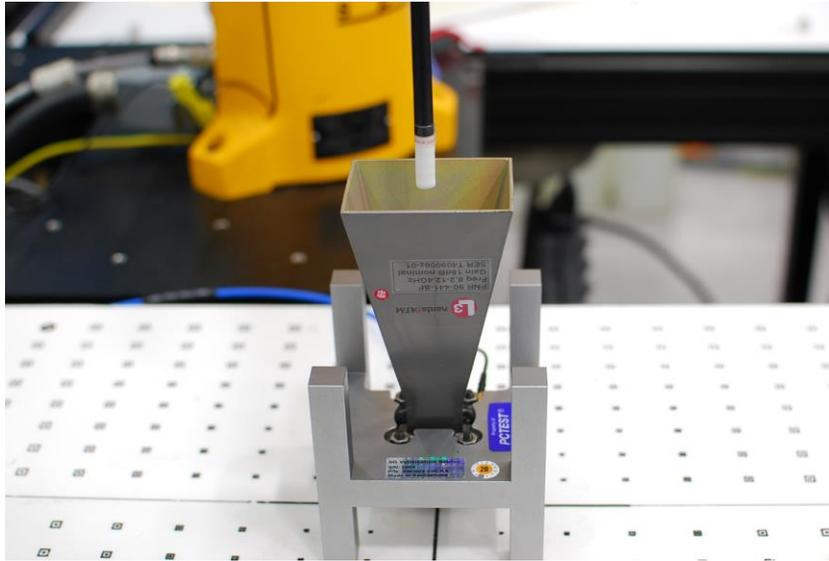

**Figure 8-3
System Verification Setup Photo**

**Table 8-6
10 GHz Verifications**

System Verification											
System	Frequency (GHz)	Date	Source S/N	Probe S/N	Prad (mW)	Normal psPD (W/m ² over 4 cm ²)		Deviation (dB)	Total psPD (W/m ² over 4 cm ²)		Deviation (dB)
						Measured	Target		Measured	Target	
Q	10	03/04/2024	1004	9622	93.3	57.80	55.80	0.15	58.00	56.10	0.14
Q	10	04/02/2024	1002	9622	93.3	53.90	54.60	-0.06	54.10	54.90	-0.06

Note: A **10 mm distance spacing** was used from the reference horn antenna aperture to the probe element.

FCC ID: C3K2085	SAR EVALUATION REPORT	Approved by: Technical Manager
Document S/N: 1M2311170118-01.C3K(R1)	DUT Type: Portable Computing Device	Page 40 of 58

9 SAR DATA SUMMARY

9.1 DTS SISO Standalone SAR Data

Table 9-1
DTS SISO Antenna R Laptop and Tablet - No Motion

Exposure	Band / Mode	Bandwidth [MHz]	Service / Modulation	Ant.	Configuration	Serial Number	Duty Cycle [%]	Power Drift [dB]	Frequency [MHz]	Channel #	Data Rate [Mbps]	Max Allowed Power [dBm]	Conducted Power [dBm]	Test Position	Spacing [mm]	Measured 1g SAR [W/kg]	Power Scaling Factor	Duty Cycle Scaling Factor	Reported 1g SAR [W/kg]	Exposure Ratio (1g SAR)	Plot #	Plimit [dBm]	Overall Plimit [dBm]
Body	2.4 GHz WiFi / IEEE 802.11b	22	DSSS	R	Tablet	1P4X2	98.08	0.09	2422.00	3	1	21.0	20.08	Back	25	0.002	1.236	1.020	0.003	0.002			46.9
Body	2.4 GHz WiFi / IEEE 802.11b	22	DSSS	R	Tablet	1P4X2	98.08	-0.05	2422.00	3	1	21.0	20.08	Top	25	0.048	1.236	1.020	0.061	0.038			33.1
Body	2.4 GHz WiFi / IEEE 802.11b	22	DSSS	R	Laptop	1P4X2	98.08	0.02	2422.00	3	1	21.0	20.08	Bottom	0	0.003	1.236	1.020	0.004	0.003			45.2
Body	2.4 GHz WiFi / IEEE 802.11b	22	DSSS	R	Tablet	1P4X2	98.08	0.07	2422.00	3	1	21.0	20.08	Right	25	0.004	1.236	1.020	0.005	0.003			43.9
Body	2.4 GHz WiFi / IEEE 802.11b	22	DSSS	R	Tablet	1P4X2	98.08	0.04	2422.00	3	1	21.0	20.08	Left	25	0.000	1.236	1.020	0.000	0.000			59.9
ANSI/IEEE C95.1 1992 - SAFETY LIMIT																Body							
Spatial Peak																1.6 W/kg (mW/g)							
Uncontrolled Exposure/General Population																averaged over 1 gram							

Table 9-2
DTS SISO Antenna L Laptop and Tablet - No Motion

Exposure	Band / Mode	Bandwidth [MHz]	Service / Modulation	Ant.	Configuration	Serial Number	Duty Cycle [%]	Power Drift [dB]	Frequency [MHz]	Channel #	Data Rate [Mbps]	Max Allowed Power [dBm]	Conducted Power [dBm]	Test Position	Spacing [mm]	Measured 1g SAR [W/kg]	Power Scaling Factor	Duty Cycle Scaling Factor	Reported 1g SAR [W/kg]	Exposure Ratio (1g SAR)	Plot #	Plimit [dBm]	Overall Plimit [dBm]
Body	2.4 GHz WiFi / IEEE 802.11b	22	DSSS	L	Tablet	1P4X2	98.08	-0.13	2422.00	3	1	21.0	20.04	Top	25	0.067	1.247	1.020	0.085	0.053	A1		31.6
Body	2.4 GHz WiFi / IEEE 802.11b	22	DSSS	L	Laptop	1P4X2	98.08	0.01	2422.00	3	1	21.0	20.04	Bottom	0	0.000	1.247	1.020	0.000	0.000			59.9
Body	2.4 GHz WiFi / IEEE 802.11b	22	DSSS	L	Tablet	1P4X2	98.08	0.06	2422.00	3	1	21.0	20.04	Right	25	0.000	1.247	1.020	0.000	0.000			59.9
Body	2.4 GHz WiFi / IEEE 802.11b	22	DSSS	L	Tablet	1P4X2	98.08	0.09	2422.00	3	1	21.0	20.04	Left	25	0.008	1.247	1.020	0.010	0.006			40.4
ANSI/IEEE C95.1 1992 - SAFETY LIMIT																Body							
Spatial Peak																1.6 W/kg (mW/g)							
Uncontrolled Exposure/General Population																averaged over 1 gram							

Table 9-3
DTS SISO Antenna R Tablet - Motion

Exposure	Band / Mode	Bandwidth [MHz]	Service / Modulation	Ant.	Accessory	Serial Number	Duty Cycle [%]	Power Drift [dB]	Frequency [MHz]	Channel #	Data Rate [Mbps]	Max Allowed Power [dBm]	Conducted Power [dBm]	Test Position	Spacing [mm]	Measured 1g SAR [W/kg]	Power Scaling Factor	Duty Cycle Scaling Factor	Reported 1g SAR [W/kg]	Exposure Ratio (1g SAR)	Plot #	Plimit [dBm]	Overall Plimit [dBm]
Body	2.4 GHz WiFi / IEEE 802.11b	22	DSSS	R	N/A	IP4F2	98.08	-0.01	2437.00	6	1	19.0	18.98	Back	0	0.051	1.005	1.020	0.052	0.033			21.8
Body	2.4 GHz WiFi / IEEE 802.11b	22	DSSS	R	N/A	IP4F2	98.08	0.02	2437.00	6	1	19.0	18.98	Top	0	0.591	1.005	1.020	0.606	0.379			21.1
Body	2.4 GHz WiFi / IEEE 802.11b	22	DSSS	R	Keyboard	IP4F2	98.08	0.01	2437.00	6	1	19.0	18.98	Top	0	0.639	1.005	1.020	0.655	0.409			20.8
Body	2.4 GHz WiFi / IEEE 802.11b	22	DSSS	R	N/A	IP4F2	98.08	0.07	2437.00	6	1	19.0	18.98	Bottom	0	0.003	1.005	1.020	0.003	0.002			44.1
Body	2.4 GHz WiFi / IEEE 802.11b	22	DSSS	R	N/A	IP4F2	98.08	-0.07	2437.00	6	1	19.0	18.98	Right	0	0.011	1.005	1.020	0.011	0.007			38.4
Body	2.4 GHz WiFi / IEEE 802.11b	22	DSSS	R	N/A	IP4F2	98.08	0.19	2437.00	6	1	19.0	18.98	Left	0	0.007	1.005	1.020	0.007	0.004			40.4
ANSI/IEEE C95.1 1992 - SAFETY LIMIT																Body							
Spatial Peak																1.6 W/kg (mW/g)							
Uncontrolled Exposure/General Population																averaged over 1 gram							

Table 9-4
DTS SISO Antenna L Tablet - Motion

Exposure	Band / Mode	Bandwidth [MHz]	Service / Modulation	Ant.	Accessory	Serial Number	Duty Cycle [%]	Power Drift [dB]	Frequency [MHz]	Channel #	Data Rate [Mbps]	Max Allowed Power [dBm]	Conducted Power [dBm]	Test Position	Spacing [mm]	Measured 1g SAR [W/kg]	Power Scaling Factor	Duty Cycle Scaling Factor	Reported 1g SAR [W/kg]	Exposure Ratio (1g SAR)	Plot #	Plimit [dBm]	Overall Plimit [dBm]
Body	2.4 GHz WiFi / IEEE 802.11b	22	DSSS	L	N/A	IP4F2	98.08	-0.02	2437.00	6	1	17.5	17.41	Back	0	0.084	1.021	1.020	0.087	0.054			28.0
Body	2.4 GHz WiFi / IEEE 802.11b	22	DSSS	L	N/A	IP4F2	98.08	-0.01	2437.00	6	1	17.5	17.41	Top	0	0.637	1.021	1.020	0.663	0.414			19.2
Body	2.4 GHz WiFi / IEEE 802.11b	22	DSSS	L	Keyboard	IP4F2	98.08	0.06	2437.00	6	1	17.5	17.41	Top	0	0.679	1.021	1.020	0.702	0.442	A2		19.0
Body	2.4 GHz WiFi / IEEE 802.11b	22	DSSS	L	N/A	IP4F2	98.08	0.06	2437.00	6	1	17.5	17.41	Bottom	0	0.002	1.021	1.020	0.002	0.001			44.3
Body	2.4 GHz WiFi / IEEE 802.11b	22	DSSS	L	N/A	IP4F2	98.08	0.02	2437.00	6	1	17.5	17.41	Right	0	0.003	1.021	1.020	0.003	0.002			42.5
Body	2.4 GHz WiFi / IEEE 802.11b	22	DSSS	L	N/A	IP4F2	98.08	-0.20	2437.00	6	1	17.5	17.41	Left	0	0.010	1.021	1.020	0.010	0.006			37.3
ANSI/IEEE C95.1 1992 - SAFETY LIMIT																Body							
Spatial Peak																1.6 W/kg (mW/g)							
Uncontrolled Exposure/General Population																averaged over 1 gram							

FCC ID: C3K2085	SAR EVALUATION REPORT		Approved by: Technical Manager
Document S/N: 1M2311170118-01.C3K(R1)	DUT Type: Portable Computing Device		Page 41 of 58

9.2 NII SISO Standalone SAR Data

Table 9-5
NII SISO Antenna R Laptop and Tablet - No Motion

Exposure	Band / Mode	Bandwidth [MHz]	Service / Modulation	Ant.	Configuration	Serial Number	Duty Cycle [%]	Power Drift [dB]	Frequency [MHz]	Channel #	U-NII band	Data Rate [Mbps]	Max Allowed Power [dBm]	Conducted Power [dBm]	Test Position	Spacing [mm]	Measured 1g SAR [W/kg]	Power Scaling Factor	Duty Cycle Scaling Factor	Reported 1g SAR [W/kg]	Exposure Ratio [g SAR]	Plot #	Plimit [dBm]	Overall Plimit [dBm]
Body	5 GHz WiFi / IEEE 802.11a	20	OFDM	R	Tablet	1P4W2	99.10	0.09	5200.00	40	U-NII-1	6	19.0	17.89	Back	25	0.007	1.291	1.009	0.009	0.006		39.3	34.4
Body	5 GHz WiFi / IEEE 802.11ac	80	OFDM	R	Tablet	1P4W2	99.12	0.03	5690.00	138	U-NII-2C	29.3	18.0	16.78	Back	25	0.017	1.324	1.009	0.023	0.014		34.4	34.4
Body	5 GHz WiFi / IEEE 802.11n	20	OFDM	R	Tablet	1P4W2	99.10	0.04	5785.00	157	U-NII-3	6	20.5	19.65	Back	25	0.015	1.216	1.009	0.018	0.011		37.8	37.8
Body	5 GHz WiFi / IEEE 802.11n	40	OFDM	R	Tablet	1P4W2	99.63	0.01	5835.00	167	U-NII-4	13.5	18.0	16.89	Back	25	0.004	1.291	1.004	0.005	0.003		40.8	40.8
Body	5 GHz WiFi / IEEE 802.11a	20	OFDM	R	Tablet	1P4W2	99.10	-0.04	5200.00	40	U-NII-1	6	19.0	17.89	Top	25	0.061	1.291	1.009	0.079	0.049		29.9	29.9
Body	5 GHz WiFi / IEEE 802.11ac	80	OFDM	R	Tablet	1P4W2	99.12	-0.15	5690.00	138	U-NII-2C	29.3	18.0	16.78	Top	25	0.167	1.324	1.009	0.233	0.139		24.5	24.5
Body	5 GHz WiFi / IEEE 802.11a	20	OFDM	R	Tablet	1P4W2	99.10	0.03	5785.00	157	U-NII-3	6	20.5	19.65	Top	25	0.158	1.216	1.009	0.194	0.121		27.6	27.6
Body	5 GHz WiFi / IEEE 802.11n	40	OFDM	R	Tablet	1P4W2	99.63	0.05	5835.00	167	U-NII-4	13.5	18.0	16.89	Top	25	0.077	1.291	1.004	0.100	0.063		28.0	28.0
Body	5 GHz WiFi / IEEE 802.11a	20	OFDM	R	Laptop	1P4W2	99.10	0.09	5200.00	40	U-NII-1	6	19.0	17.89	Bottom	0	0.000	1.291	1.009	0.000	0.000		57.8	57.8
Body	5 GHz WiFi / IEEE 802.11ac	80	OFDM	R	Laptop	1P4W2	99.12	0.04	5690.00	138	U-NII-2C	29.3	18.0	16.78	Bottom	0	0.000	1.324	1.009	0.000	0.000		56.7	56.7
Body	5 GHz WiFi / IEEE 802.11n	20	OFDM	R	Laptop	1P4W2	99.10	0.01	5785.00	157	U-NII-3	6.5	20.5	19.65	Bottom	0	0.005	1.216	1.009	0.006	0.004		42.6	42.6
Body	5 GHz WiFi / IEEE 802.11n	40	OFDM	R	Laptop	1P4W2	99.63	0.05	5835.00	167	U-NII-4	13.5	18.0	16.89	Bottom	0	0.000	1.291	1.004	0.000	0.000		56.8	56.8
Body	5 GHz WiFi / IEEE 802.11a	20	OFDM	R	Tablet	1P4W2	99.10	0.09	5200.00	40	U-NII-1	6	19.0	17.89	Right	25	0.001	1.291	1.009	0.001	0.001		47.8	47.8
Body	5 GHz WiFi / IEEE 802.11ac	80	OFDM	R	Tablet	1P4W2	99.12	0.06	5690.00	138	U-NII-2C	29.3	18.0	16.78	Right	25	0.000	1.324	1.009	0.000	0.000		56.7	56.7
Body	5 GHz WiFi / IEEE 802.11n	20	OFDM	R	Tablet	1P4W2	99.10	0.04	5785.00	157	U-NII-3	6	20.5	19.65	Right	25	0.000	1.216	1.009	0.000	0.000		59.6	59.6
Body	5 GHz WiFi / IEEE 802.11n	40	OFDM	R	Tablet	1P4W2	99.63	0.03	5835.00	167	U-NII-4	13.5	18.0	16.89	Right	25	0.000	1.291	1.004	0.000	0.000		56.8	56.8
Body	5 GHz WiFi / IEEE 802.11a	20	OFDM	R	Tablet	1P4W2	99.10	0.01	5200.00	40	U-NII-1	6	19.0	17.89	Left	25	0.000	1.291	1.009	0.000	0.000		57.8	57.8
Body	5 GHz WiFi / IEEE 802.11ac	80	OFDM	R	Tablet	1P4W2	99.12	0.05	5690.00	138	U-NII-2C	29.3	18.0	16.78	Left	25	0.000	1.324	1.009	0.000	0.000		56.7	56.7
Body	5 GHz WiFi / IEEE 802.11n	20	OFDM	R	Tablet	1P4W2	99.10	0.01	5785.00	157	U-NII-3	6.5	20.5	19.65	Left	25	0.000	1.216	1.009	0.000	0.000		59.6	59.6
Body	5 GHz WiFi / IEEE 802.11n	40	OFDM	R	Tablet	1P4W2	99.63	0.01	5835.00	167	U-NII-4	13.5	18.0	16.89	Left	25	0.000	1.291	1.004	0.000	0.000		56.8	56.8
ANSI/IEEE C95.1 1992 - SAFETY LIMIT																								
Spatial Peak																								
Uncontrolled Exposure/General Population																								
																		Body 1.6 W/kg (mW/g) averaged over 1 gram						

Table 9-6
NII SISO Antenna L Laptop and Tablet - No Motion

Exposure	Band / Mode	Bandwidth [MHz]	Service / Modulation	Ant.	Configuration	Serial Number	Duty Cycle [%]	Power Drift [dB]	Frequency [MHz]	Channel #	U-NII band	Data Rate [Mbps]	Max Allowed Power [dBm]	Conducted Power [dBm]	Test Position	Spacing [mm]	Measured 1g SAR [W/kg]	Power Scaling Factor	Duty Cycle Scaling Factor	Reported 1g SAR [W/kg]	Exposure Ratio [g SAR]	Plot #	Plimit [dBm]	Overall Plimit [dBm]
Body	5 GHz WiFi / IEEE 802.11a	20	OFDM	L	Tablet	1P4W2	99.05	0.01	5200.00	40	U-NII-1	6	19.0	17.96	Back	25	0.020	1.271	1.010	0.026	0.016		34.9	34.9
Body	5 GHz WiFi / IEEE 802.11ac	80	OFDM	L	Tablet	1P4W2	99.19	0.04	5690.00	138	U-NII-2C	29.3	18.0	17.49	Back	25	0.045	1.325	1.008	0.051	0.032		30.9	30.9
Body	5 GHz WiFi / IEEE 802.11n	20	OFDM	L	Tablet	1P4W2	99.05	0.01	5785.00	157	U-NII-3	6.5	20.5	19.67	Back	25	0.047	1.211	1.010	0.057	0.036		32.9	32.9
Body	5 GHz WiFi / IEEE 802.11n	40	OFDM	L	Tablet	1P4W2	99.65	0.05	5875.00	175	U-NII-4	13.5	18.0	17.68	Back	25	0.044	1.076	1.004	0.048	0.030		31.2	31.2
Body	5 GHz WiFi / IEEE 802.11a	20	OFDM	L	Tablet	1P5U2	99.05	-0.17	5200.00	40	U-NII-1	6	19.0	17.96	Top	25	0.087	1.271	1.010	0.112	0.070		28.5	28.5
Body	5 GHz WiFi / IEEE 802.11ac	80	OFDM	L	Tablet	1P5U2	99.19	-0.05	5690.00	138	U-NII-2C	29.3	18.0	17.49	Top	25	0.163	1.325	1.008	0.185	0.116		25.3	25.3
Body	5 GHz WiFi / IEEE 802.11n	20	OFDM	L	Tablet	1P5U2	99.05	0.08	5785.00	157	U-NII-3	6.5	20.5	19.67	Top	25	0.207	1.211	1.010	0.253	0.158	A3	26.1	26.1
Body	5 GHz WiFi / IEEE 802.11n	40	OFDM	L	Tablet	1P5U2	99.65	0.09	5875.00	175	U-NII-4	13.5	18.0	17.68	Top	25	0.141	1.076	1.004	0.152	0.095		26.4	26.4
Body	5 GHz WiFi / IEEE 802.11a	20	OFDM	L	Laptop	1P5U2	99.05	0.01	5200.00	40	U-NII-1	6	19.0	17.96	Bottom	0	0.000	1.271	1.010	0.000	0.000		57.9	57.9
Body	5 GHz WiFi / IEEE 802.11ac	80	OFDM	L	Laptop	1P5U2	99.19	0.04	5690.00	138	U-NII-2C	29.3	18.0	17.49	Bottom	0	0.000	1.325	1.008	0.000	0.000		57.4	57.4
Body	5 GHz WiFi / IEEE 802.11n	20	OFDM	L	Laptop	1P4W2	99.05	0.05	5785.00	157	U-NII-3	6.5	20.5	19.67	Bottom	0	0.000	1.211	1.010	0.000	0.000		59.6	59.6
Body	5 GHz WiFi / IEEE 802.11n	40	OFDM	L	Laptop	1P4W2	99.65	0.08	5875.00	175	U-NII-4	13.5	18.0	17.68	Bottom	0	0.009	1.076	1.004	0.010	0.006		38.1	38.1
Body	5 GHz WiFi / IEEE 802.11a	20	OFDM	L	Tablet	1P4W2	99.05	0.01	5260.00	52	U-NII-1	6	18.5	17.43	Right	25	0.000	1.279	1.010	0.000	0.000		57.3	57.3
Body	5 GHz WiFi / IEEE 802.11ac	80	OFDM	L	Tablet	1P4W2	99.19	0.04	5690.00	138	U-NII-2C	29.3	18.0	17.49	Right	25	0.000	1.325	1.008	0.000	0.000		57.4	57.4
Body	5 GHz WiFi / IEEE 802.11n	20	OFDM	L	Tablet	1P4W2	99.05	0.04	5785.00	157	U-NII-3	6.5	20.5	19.67	Right	25	0.000	1.211	1.010	0.000	0.000		59.6	59.6
Body	5 GHz WiFi / IEEE 802.11n	40	OFDM	L	Tablet	1P4W2	99.65	0.02	5875.00	175	U-NII-4	13.5	18.0	17.68	Right	25	0.000	1.076	1.004	0.000	0.000		57.6	57.6
Body	5 GHz WiFi / IEEE 802.11a	20	OFDM	L	Tablet	1P4W2	99.05	0.04	5260.00	52	U-NII-1	6	18.5	17.43	Left	25	0.000	1.279	1.010	0.000	0.000		57.3	57.3
Body	5 GHz WiFi / IEEE 802.11ac	80	OFDM	L	Tablet	1P4W2	99.19	0.08	5690.00	138	U-NII-2C	29.3	18.0	17.49	Left	25	0.000	1.325	1.008	0.000	0.000		57.4	57.4
Body	5 GHz WiFi / IEEE 802.11n	20	OFDM	L	Tablet	1P4W2	99.05	0.06	5785.00	157	U-NII-3	6.5	20.5	19.67	Left	25	0.000	1.211	1.010	0.000	0.000		59.6	59.6
Body	5 GHz WiFi / IEEE 802.11n	40	OFDM	L	Tablet	1P4W2	99.65	0.02	5875.00	175	U-NII-4	13.5	18.0	17.68	Left	25	0.000	1.076	1.004	0.000	0.000		57.6	57.6
ANSI/IEEE C95.1 1992 - SAFETY LIMIT																								
Spatial Peak																								
Uncontrolled Exposure/General Population																								
																		Body 1.6 W/kg (mW/g) averaged over 1 gram						

Table 9-7
NII SISO Antenna R Tablet - Motion

Exposure	Band / Mode	Bandwidth [MHz]	Service / Modulation	Ant.	Accessory	Serial Number	Duty Cycle [%]	Power Drift [dB]	Frequency [MHz]	Channel #	U-NII band	Data Rate [Mbps]	Max Allowed Power [dBm]	Conducted Power [dBm]	Test Position	Spacing [mm]	Measured 1g SAR [W/kg]	Power Scaling Factor	Duty Cycle Scaling Factor	Reported 1g SAR [W/kg]	Exposure Ratio [g SAR]	Plot #	Plimit [dBm]	Overall Plimit [dBm]
Body	5 GHz WiFi / IEEE 802.11a	20	OFDM	R	N/A	1P4F2	99.10	0.03	5260.00	52	U-NII-2A	6	16.50	15.19	Back	0	0.029	1.352	1.009	0.040	0.025		30.5	30.5
Body	5 GHz WiFi / IEEE 802.11ac	80	OFDM	R	N/A	1P4F2	99.12	0.05	5690.00	138	U-NII-2C	29.3	15.75	14.86	Back	0	0.033	1.227	1.009	0.041	0.026		29.6	29.6
Body	5 GHz WiFi / IEEE 802.11n	40	OFDM	R	N/A	1P4F2	99.63	0.02	5755.00	151	U-NII-3	13.5	15.50	14.61	Back	0	0.035	1.227	1.004	0.043	0.027		29.1	29.1
Body	5 GHz WiFi / IEEE 802.11n	40	OFDM	R	N/A	1P4F2	99.63	0.06	5875.00	175	U-NII-4	13.5	15.50	14.86	Back	0	0.042	1.159	1.004	0.049	0.031		28.6	28.6
Body	5 GHz WiFi / IEEE 802.11a	20	OFDM	R	N/A	1P4F2	99.10	-0.15	5260.00	52	U-NII-2A	6	16.50	15.19	Top	0	0.260	1.352	1.009	0.355	0.222		21.0	21.0
Body	5 GHz WiFi / IEEE 802.11ac	80	OFDM	R	N/A	1P4F2	99.12	0.07	5690.00	138	U-NII-2C	29.3	15.75	14.86	Top	0	0.388	1.227	1.009	0.480	0.300		18.9	18.9
Body	5 GHz WiFi / IEEE 802.11n	40	OFDM	R	N/A	1P4F2	99.63	0.07	5755.00	151	U-NII-3	13.5	15.50	14.61	Top	0	0.462	1.227	1.004	0.569	0.356		17.9	17.9
Body	5 GHz WiFi / IEEE 802.11n	40	OFDM	R	Keyboard	1P5U2	99.63	0.06	5755.00	151	U-NII-3	13.5	15.50	14.61	Top	0	0.452	1.227	1.004	0.557	0.348		18.0	18.0
Body	5 GHz WiFi / IEEE 802.11a	20	OFDM	R	N/A	1P4F2	99.63	0.03	5875.00															

**Table 9-8
NII SISO Antenna L Tablet - Motion**

Exposure	Band / Mode	Bandwidth [MHz]	Service / Modulation	Ant.	Accessory	Serial Number	Duty Cycle [%]	Power Drift [dB]	Frequency [MHz]	Channel #	U-NII band	Data Rate [Mbps]	Max Allowed Power [dBm]	Conducted Power [dBm]	Test Position	Spacing [mm]	Measured 1g SAR [W/kg]	Power Scaling Factor	Duty Cycle Scaling Factor	Reported 1g SAR [W/kg]	Exposure Ratio (1g SAR)	Plot #	Plimt [dBm]	Overall Plimt [dBm]
Body	5 GHz WiFi / IEEE 802.11a	20	OFDM	L	N/A	1P4F2	99.05	-0.16	5180.00	36	U-NII-1	6	18.75	17.98	Back	0	0.108	1.194	1.010	0.130	0.081		27.6	
Body	5 GHz WiFi / IEEE 802.11ac	80	OFDM	L	N/A	1P4F2	99.19	0.06	5690.00	138	U-NII-2C	29.3	18.00	17.49	Back	0	0.141	1.125	1.008	0.160	0.100		25.9	
Body	5 GHz WiFi / IEEE 802.11n	40	OFDM	L	N/A	1P4F2	99.65	-0.14	5795.00	159	U-NII-3	13.5	17.50	17.18	Back	0	0.151	1.076	1.004	0.163	0.102		25.3	
Body	5 GHz WiFi / IEEE 802.11n	40	OFDM	L	N/A	1P4F2	99.65	-0.09	5875.00	175	U-NII-4	13.5	17.50	17.42	Back	0	0.200	1.019	1.004	0.206	0.129		28.3	
Body	5 GHz WiFi / IEEE 802.11a	20	OFDM	L	N/A	1P4F2	99.05	-0.13	5180.00	36	U-NII-1	6	18.75	17.98	Top	0	0.552	1.194	1.010	0.656	0.416	A4	20.5	
Body	5 GHz WiFi / IEEE 802.11a	20	OFDM	L	Keyboard	1P4X2	99.05	0.06	5180.00	36	U-NII-1	6	18.75	17.98	Top	0	0.414	1.194	1.010	0.499	0.312		21.7	
Body	5 GHz WiFi / IEEE 802.11ac	80	OFDM	L	N/A	1P4X2	99.19	0.08	5690.00	138	U-NII-2C	29.3	18.00	17.49	Top	0	0.519	1.125	1.008	0.589	0.368		20.3	
Body	5 GHz WiFi / IEEE 802.11n	40	OFDM	L	N/A	1P4X2	99.65	0.01	5795.00	159	U-NII-3	13.5	17.50	17.18	Top	0	0.464	1.076	1.004	0.436	0.273		21.1	
Body	5 GHz WiFi / IEEE 802.11n	40	OFDM	L	N/A	1P4X2	99.65	-0.04	5875.00	175	U-NII-4	13.5	17.50	17.42	Top	0	0.450	1.019	1.004	0.460	0.288		20.8	
Body	5 GHz WiFi / IEEE 802.11a	20	OFDM	L	N/A	1P4F2	99.05	0.01	5180.00	36	U-NII-1	6	18.75	17.98	Bottom	0	0.000	1.194	1.010	0.000	0.000		57.9	
Body	5 GHz WiFi / IEEE 802.11ac	80	OFDM	L	N/A	1P4F2	99.19	0.01	5690.00	138	U-NII-2C	29.3	18.00	17.49	Bottom	0	0.006	1.125	1.008	0.007	0.004		59.6	
Body	5 GHz WiFi / IEEE 802.11n	40	OFDM	L	N/A	1P4F2	99.65	0.05	5795.00	159	U-NII-3	13.5	17.50	17.18	Bottom	0	0.000	1.076	1.004	0.000	0.000		57.1	
Body	5 GHz WiFi / IEEE 802.11n	40	OFDM	L	N/A	1P4F2	99.65	0.08	5875.00	175	U-NII-4	13.5	17.50	17.42	Bottom	0	0.000	1.019	1.004	0.000	0.000		57.4	
Body	5 GHz WiFi / IEEE 802.11a	20	OFDM	L	N/A	1P4F2	99.05	0.01	5180.00	36	U-NII-1	6	18.75	17.98	Right	0	0.000	1.194	1.010	0.000	0.000		57.9	
Body	5 GHz WiFi / IEEE 802.11ac	80	OFDM	L	N/A	1P4F2	99.19	0.08	5690.00	138	U-NII-2C	29.3	18.00	17.49	Right	0	0.000	1.125	1.008	0.000	0.000		57.4	
Body	5 GHz WiFi / IEEE 802.11n	40	OFDM	L	N/A	1P4F2	99.65	0.01	5795.00	159	U-NII-3	13.5	17.50	17.18	Right	0	0.000	1.076	1.004	0.000	0.000		57.1	
Body	5 GHz WiFi / IEEE 802.11n	40	OFDM	L	N/A	1P4F2	99.65	0.04	5875.00	175	U-NII-4	13.5	17.50	17.42	Right	0	0.000	1.019	1.004	0.000	0.000		57.4	
Body	5 GHz WiFi / IEEE 802.11ac	80	OFDM	L	N/A	1P4F2	99.19	0.07	5690.00	138	U-NII-2C	29.3	18.00	17.49	Left	0	0.009	1.125	1.008	0.010	0.006		37.9	
Body	5 GHz WiFi / IEEE 802.11n	40	OFDM	L	N/A	1P4F2	99.65	0.08	5795.00	159	U-NII-3	13.5	17.50	17.18	Left	0	0.010	1.076	1.004	0.011	0.007		37.1	
Body	5 GHz WiFi / IEEE 802.11n	40	OFDM	L	N/A	1P4F2	99.65	0.04	5875.00	175	U-NII-4	13.5	17.50	17.42	Left	0	0.021	1.019	1.004	0.021	0.013		34.1	
ANSI/IEEE CS91.1 1991 - SAFETY LIMIT Spatial Peak																	Body		1.6 W/kg (mW/g) averaged over 1 gram					
Uncontrolled Exposure/General Population																								

9.3 6CD SISO Standalone SAR & APD Data

**Table 9-9
6CD SISO Antenna R Laptop and Tablet - No Motion SAR**

Exposure	Band / Mode	Bandwidth [MHz]	Service / Modulation	Ant.	Configuration	Serial Number	Duty Cycle [%]	Power Drift [dB]	Frequency [MHz]	Channel #	Data Rate	Max Allowed Power [dBm]	Conducted Power [dBm]	Test Position	Spacing [mm]	Measured 1g SAR [W/kg]	Power Scaling Factor	Duty Cycle Scaling Factor	Reported 1g SAR [W/kg]	Exposure Ratio (1g SAR)	Plot #	Plimt [dBm]	Overall Plimt [dBm]
Body	6 GHz WiFi / IEEE 802.11ax	40	OFDM	R	Tablet	1P4X2	99.34	0.05	6005.00	11	MCSS0	20.0	19.13	Back	25	0.016	1.222	1.007	0.020	0.013		37.0	
Body	6 GHz WiFi / IEEE 802.11ax	40	OFDM	R	Tablet	9V9X2	99.34	0.01	6285.00	67	MCSS0	20.0	18.81	Back	25	0.013	1.315	1.004	0.030	0.019		35.1	
Body	6 GHz WiFi / IEEE 802.11ax	40	OFDM	R	Tablet	1P4X2	99.34	-0.05	6005.00	11	MCSS0	20.0	19.13	Top	25	0.167	1.222	1.007	0.206	0.129		26.8	
Body	6 GHz WiFi / IEEE 802.11ax	40	OFDM	R	Tablet	1P4G2	99.34	0.03	6285.00	67	MCSS0	20.0	18.81	Top	25	0.139	1.315	1.007	0.184	0.115		27.3	
Body	6 GHz WiFi / IEEE 802.11be	320	OFDM	R	Tablet	9V9X2	99.48	0.01	6425.00	95	MCSS0	10.5	9.53	Top	25	0.002	1.250	1.005	0.003	0.002		36.4	
Body	6 GHz WiFi / IEEE 802.11ax	40	OFDM	R	Tablet	1P4G2	99.38	0.02	6705.00	151	MCSS0	20.0	18.39	Top	25	0.167	1.449	1.006	0.243	0.152	A5	26.1	
Body	6 GHz WiFi / IEEE 802.11be	320	OFDM	R	Tablet	9V9X2	99.48	0.01	6905.00	191	MCSS0	10.5	9.58	Top	25	0.004	1.236	1.005	0.005	0.003		33.5	
Body	6 GHz WiFi / IEEE 802.11ax	40	OFDM	R	Laptop	1P4X2	99.34	0.07	6005.00	11	MCSS0	20.0	19.13	Bottom	0	0.020	1.222	1.007	0.025	0.016		36.0	
Body	6 GHz WiFi / IEEE 802.11ax	40	OFDM	R	Laptop	1P4G2	99.34	0.02	6285.00	67	MCSS0	20.0	18.81	Bottom	0	0.002	1.315	1.007	0.003	0.002		45.7	
Body	6 GHz WiFi / IEEE 802.11ax	40	OFDM	R	Tablet	1P4X2	99.34	0.03	6005.00	11	MCSS0	20.0	19.13	Right	25	0.017	1.222	1.007	0.021	0.013		36.7	
Body	6 GHz WiFi / IEEE 802.11ax	40	OFDM	R	Tablet	9V9X2	99.34	0.01	6285.00	67	MCSS0	20.0	18.81	Right	25	0.031	1.315	1.007	0.041	0.026		33.8	
Body	6 GHz WiFi / IEEE 802.11ax	40	OFDM	R	Tablet	1P4X2	99.34	0.05	6005.00	11	MCSS0	20.0	19.13	Left	25	0.002	1.222	1.007	0.002	0.001		46.0	
Body	6 GHz WiFi / IEEE 802.11ax	40	OFDM	R	Tablet	9V9X2	99.34	0.09	6285.00	67	MCSS0	20.0	18.81	Left	25	0.004	1.315	1.007	0.005	0.003		42.7	
ANSI/IEEE CS91.1 1991 - SAFETY LIMIT Spatial Peak																	Body		1.6 W/kg (mW/g) averaged over 1 gram				
Uncontrolled Exposure/General Population																							

**Table 9-10
6CD SISO Antenna R Laptop and Tablet - No Motion APD**

Exposure	Band / Mode	Bandwidth [MHz]	Service / Modulation	Ant.	Configuration	Serial Number	Duty Cycle [%]	Power Drift [dB]	Frequency [MHz]	Channel #	Data Rate	Max Allowed Power [dBm]	Conducted Power [dBm]	Test Position	Spacing [mm]	Measured APD [W/m ² (dcm ²)]	Power Scaling Factor	Duty Cycle Scaling Factor	Reported APD [W/m ² (dcm ²)]	APD Exposure Ratio	Plot #
Body	6 GHz WiFi / IEEE 802.11ax	40	OFDM	R	Tablet	1P4X2	99.34	0.05	6005.00	11	MCSS0	20.0	19.13	Back	25	0.112	1.222	1.007	0.138	0.007	
Body	6 GHz WiFi / IEEE 802.11ax	40	OFDM	R	Tablet	9V9X2	99.34	0.01	6285.00	67	MCSS0	20.0	18.81	Back	25	0.201	1.315	1.007	0.266	0.013	
Body	6 GHz WiFi / IEEE 802.11ax	40	OFDM	R	Tablet	1P4X2	99.34	-0.05	6005.00	11	MCSS0	20.0	19.13	Top	25	1.620	1.222	1.007	1.993	0.100	
Body	6 GHz WiFi / IEEE 802.11ax	40	OFDM	R	Tablet	1P4G2	99.34	0.03	6285.00	67	MCSS0	20.0	18.81	Top	25	1.340	1.315	1.007	1.774	0.089	
Body	6 GHz WiFi / IEEE 802.11be	320	OFDM	R	Tablet	9V9X2	99.48	0.01	6425.00	95	MCSS0	10.5	9.53	Top	25	0.018	1.250	1.005	0.023	0.001	
Body	6 GHz WiFi / IEEE 802.11ax	40	OFDM	R	Tablet	1P4G2	99.38	0.02	6705.00	151	MCSS0	20.0	18.39	Top	25	1.590	1.449	1.006	2.318	0.116	AS
Body	6 GHz WiFi / IEEE 802.11be	320	OFDM	R	Tablet	9V9X2	99.48	0.01	6905.00	191	MCSS0	10.5	9.58	Top	25	0.055	1.236	1.005	0.068	0.003	
Body	6 GHz WiFi / IEEE 802.11ax	40	OFDM	R	Laptop	1P4X2	99.34	0.07	6005.00	11	MCSS0	20.0	19.13	Bottom	0	0.108	1.222	1.007	0.133	0.007	
Body	6 GHz WiFi / IEEE 802.11ax	40	OFDM	R	Laptop	1P4G2	99.34	0.02	6285.00	67	MCSS0	20.0	18.81	Bottom	0	0.013	1.315	1.007	0.017	0.001	
Body	6 GHz WiFi / IEEE 802.11ax	40	OFDM	R	Tablet	1P4X2	99.34	0.03	6005.00	11	MCSS0	20.0	19.13	Right	25	0.156	1.222	1.007	0.192	0.010	
Body	6 GHz WiFi / IEEE 802.11ax	40	OFDM	R	Tablet	9V9X2	99.34	0.01	6285.00	67	MCSS0	20.0	18.81	Right	25	0.262	1.315	1.007	0.347	0.017	
Body	6 GHz WiFi / IEEE 802.11ax	40	OFDM	R	Tablet	1P4X2	99.34	0.05	6005.00	11	MCSS0	20.0	19.13	Left	25	0.002	1.222	1.007	0.002	0.000	
Body	6 GHz WiFi / IEEE 802.11ax	40	OFDM	R	Tablet	9V9X2	99.34	0.09	6285.00	67	MCSS0	20.0	18.81	Left	25	0.053	1.315	1.007	0.070	0.004	

**Table 9-11
6CD SISO Antenna L Laptop and Tablet - No Motion SAR**

Exposure	Band / Mode	Bandwidth [MHz]	Service / Modulation	Ant.	Configuration	Serial Number	Duty Cycle [%]	Power Drift [dB]	Frequency [MHz]	Channel #	Data Rate	Max Allowed Power [dBm]	Conducted Power [dBm]	Test Position	Spacing [mm]	Measured 1g SAR [W/kg]	Power Scaling Factor	Duty Cycle Scaling Factor	Reported 1g SAR [W/kg]	Exposure Ratio (1g SAR)	Plot #	Plimt [dBm]	Overall Plimt [dBm]
Body	6 GHz WiFi / IEEE 802.11ax	40	OFDM	L	Tablet	1P4X2	99.57	0.01	6005.00	11	MCSS0	20.0	19.00	Back	25	0.046	1.259	1.004	0.058	0.036		32.3	
Body	6 GHz WiFi / IEEE 802.11ax	40	OFDM	L	Tablet	1P4X2	99.57	0.14	6005.00	11	MCSS0	20.0	19.00	Top	25	0.151	1.259	1.004	0.191	0.119		27.1	
Body	6 GHz WiFi / IEEE 802.11ax	40	OFDM	L	Tablet	1P4G2	99.57	0.03	6285.00	67	MCSS0	20.0	18.92	Top	25	0.105	1.282	1.004	0.135	0.084		28.6	
Body	6 GHz WiFi / IEEE 802.11be	320	OFDM	L	Tablet	9V9X2	99.32	0.01	6425.00	95	MCSS0	10.5	9.57	Top	25	0.003	1.239	1.007	0.004	0.003		34.7	
Body	6 GHz WiFi / IEEE 802.11ax	40	OFDM	L	Tablet	1P4X2	99.57	0.04	6005.00	11	MCSS0	20.0	18.78	Top	25	0.095	1.324	1.006	0.127	0.079</			

Table 9-12
6CD SISO Antenna L Laptop and Tablet – No Motion APD

Exposure	Band / Mode	Bandwidth [MHz]	Service / Modulation	Ant.	Configuration	Serial Number	Duty Cycle [%]	Power Drift [dB]	Frequency [MHz]	Channel #	Data Rate	Max Allowed Power [dBm]	Conducted Power [dBm]	Test Position	Spacing [mm]	Measured APD [W/m ² (4cm ²)]	Power Scaling Factor	Duty Cycle Scaling Factor	Reported APD [W/m ² (4cm ²)]	APD Exposure Ratio	Plot #
Body	6 GHz WiFi / IEEE 802.11ax	40	OFDM	L	Tablet	1P4X2	99.57	0.01	6005.00	11	MCSSO	20.0	19.00	Back	25	0.439	1.259	1.004	0.555	0.028	
Body	6 GHz WiFi / IEEE 802.11ax	40	OFDM	L	Tablet	1P4X2	99.57	0.14	6005.00	11	MCSSO	20.0	19.00	Top	25	1.420	1.259	1.004	1.795	0.090	
Body	6 GHz WiFi / IEEE 802.11ax	40	OFDM	L	Tablet	1P4G2	99.57	0.03	6285.00	67	MCSSO	20.0	18.92	Top	25	0.968	1.282	1.004	1.246	0.062	
Body	6 GHz WiFi / IEEE 802.11be	320	OFDM	L	Tablet	9V9X2	99.32	0.04	6425.00	95	MCSSO	10.5	9.57	Top	25	0.025	1.239	1.007	0.031	0.002	
Body	6 GHz WiFi / IEEE 802.11ax	80	OFDM	L	Tablet	9V9X2	99.4	0.04	6705.00	151	MCSSO	20.0	18.78	Top	25	0.869	1.324	1.006	1.157	0.058	
Body	6 GHz WiFi / IEEE 802.11be	320	OFDM	L	Tablet	9V9X2	99.32	0.05	6905.00	191	MCSSO	10.5	9.52	Top	25	0.022	1.253	1.007	0.028	0.001	
Body	6 GHz WiFi / IEEE 802.11ax	40	OFDM	L	Laptop	1P4X2	99.57	0.01	6005.00	11	MCSSO	20.0	19.00	Bottom	0	0.014	1.259	1.004	0.018	0.001	
Body	6 GHz WiFi / IEEE 802.11ax	40	OFDM	L	Laptop	1P4G2	99.57	0.01	6285.00	67	MCSSO	20.0	18.92	Bottom	0	0.014	1.282	1.004	0.018	0.001	
Body	6 GHz WiFi / IEEE 802.11ax	40	OFDM	L	Tablet	1P4X2	99.57	0.03	6005.00	11	MCSSO	20.0	19.00	Right	25	0.017	1.259	1.004	0.021	0.001	
Body	6 GHz WiFi / IEEE 802.11ax	40	OFDM	L	Tablet	9V9X2	99.57	-0.17	6285.00	67	MCSSO	20.0	18.92	Right	25	0.025	1.282	1.004	0.032	0.002	
Body	6 GHz WiFi / IEEE 802.11ax	40	OFDM	L	Tablet	1P4X2	99.57	0.06	6005.00	11	MCSSO	20.0	19.00	Left	25	0.186	1.259	1.004	0.235	0.012	
Body	6 GHz WiFi / IEEE 802.11ax	40	OFDM	L	Tablet	9V9X2	99.57	0.06	6285.00	67	MCSSO	20.0	18.92	Left	25	0.294	1.282	1.004	0.378	0.019	

Table 9-13
6CD SISO Antenna R Tablet - Motion SAR

Exposure	Band / Mode	Bandwidth [MHz]	Service / Modulation	Ant.	Accessory	Serial Number	Duty Cycle [%]	Power Drift [dB]	Frequency [MHz]	Channel #	Data Rate	Max Allowed Power [dBm]	Conducted Power [dBm]	Test Position	Spacing [mm]	Measured 1g SAR [W/kg]	Power Scaling Factor	Duty Cycle Scaling Factor	Reported 1g SAR [W/kg]	Exposure Ratio [g SAR]	Plot #	Plimt [dBm]	Overall Plimt [dBm]						
Body	6 GHz WiFi / IEEE 802.11ax	80	OFDM	R	N/A	9V9X2	99.38	0.09	5985.00	7	MCSSO	14.25	13.35	Back	0	0.045	1.230	1.006	0.056	0.035		26.7							
Body	6 GHz WiFi / IEEE 802.11ax	80	OFDM	R	N/A	1P4X2	99.38	0.05	6705.00	151	MCSSO	15.25	14.44	Back	0	0.018	1.205	1.006	0.022	0.014		31.8							
Body	6 GHz WiFi / IEEE 802.11ax	80	OFDM	R	N/A	1P5U2	99.38	-0.04	5985.00	7	MCSSO	14.25	13.35	Top	0	0.457	1.230	1.006	0.565	0.353		16.7							
Body	6 GHz WiFi / IEEE 802.11ax	80	OFDM	R	N/A	1P5U2	99.38	0.04	6305.00	71	MCSSO	14.25	13.31	Top	0	0.446	1.242	1.006	0.557	0.348		16.7							
Body	6 GHz WiFi / IEEE 802.11be	320	OFDM	R	N/A	1P4X2	99.48	-0.18	6425.00	95	MCSSO	10.50	9.53	Top	0	0.125	1.250	1.005	0.157	0.098		18.5							
Body	6 GHz WiFi / IEEE 802.11ax	80	OFDM	R	N/A	1P5U2	99.38	-0.01	6705.00	151	MCSSO	15.25	14.44	Top	0	0.515	1.205	1.006	0.624	0.390	A6	17.2							
Body	6 GHz WiFi / IEEE 802.11ax	80	OFDM	R	Keyboard	1P4X2	99.38	-0.03	6705.00	151	MCSSO	15.25	14.44	Top	0	0.449	1.205	1.006	0.544	0.340		17.8							
Body	6 GHz WiFi / IEEE 802.11be	320	OFDM	R	N/A	1P4X2	99.48	0.04	6905.00	191	MCSSO	10.50	9.58	Top	0	0.086	1.236	1.005	0.107	0.067		20.2							
Body	6 GHz WiFi / IEEE 802.11ax	80	OFDM	R	N/A	9V9X2	99.38	0.02	5985.00	7	MCSSO	14.25	13.35	Bottom	0	0.000	1.230	1.006	0.000	0.000		53.3							
Body	6 GHz WiFi / IEEE 802.11ax	80	OFDM	R	N/A	1P4X2	99.38	0.05	6705.00	151	MCSSO	15.25	14.44	Bottom	0	0.002	1.205	1.006	0.002	0.001		41.4							
Body	6 GHz WiFi / IEEE 802.11ax	80	OFDM	R	N/A	9V9X2	99.38	0.01	5985.00	7	MCSSO	14.25	13.35	Right	0	0.000	1.230	1.006	0.000	0.000		53.3							
Body	6 GHz WiFi / IEEE 802.11ax	80	OFDM	R	N/A	1P4X2	99.38	0.08	6705.00	151	MCSSO	15.25	14.44	Right	0	0.015	1.205	1.006	0.018	0.011		32.6							
Body	6 GHz WiFi / IEEE 802.11ax	80	OFDM	R	N/A	9V9X2	99.38	0.01	5985.00	7	MCSSO	14.25	13.35	Left	0	0.000	1.230	1.006	0.000	0.000		53.3							
Body	6 GHz WiFi / IEEE 802.11ax	80	OFDM	R	N/A	1P4X2	99.38	0.03	6705.00	151	MCSSO	15.25	14.44	Left	0	0.003	1.205	1.006	0.004	0.003		39.6							
ANSI/IEEE C95.1 1992 - SAFETY LIMIT																Body													
Spatial Peak																1.6 W/kg (mW/g)													
Uncontrolled Exposure/General Population																averaged over 1 gram													

Table 9-14
6CD SISO Antenna R Tablet - Motion APD

Exposure	Band / Mode	Bandwidth [MHz]	Service / Modulation	Ant.	Housing Type	Serial Number	Duty Cycle [%]	Power Drift [dB]	Frequency [MHz]	Channel #	Data Rate	Max Allowed Power [dBm]	Conducted Power [dBm]	Test Position	Spacing [mm]	Measured APD [W/m ² (4cm ²)]	Power Scaling Factor	Duty Cycle Scaling Factor	Reported APD [W/m ² (4cm ²)]	APD Exposure Ratio	Plot #
Body	6 GHz WiFi / IEEE 802.11ax	80	OFDM	R	N/A	9V9X2	99.38	0.09	5985.00	7	MCSSO	14.25	13.35	Back	0	0.253	1.230	1.006	0.313	0.016	
Body	6 GHz WiFi / IEEE 802.11ax	80	OFDM	R	N/A	1P4X2	99.38	0.05	6705.00	151	MCSSO	15.25	14.44	Back	0	0.167	1.205	1.006	0.202	0.010	
Body	6 GHz WiFi / IEEE 802.11ax	80	OFDM	R	N/A	1P5U2	99.38	-0.04	5985.00	7	MCSSO	14.25	13.35	Top	0	3.290	1.230	1.006	4.071	0.204	
Body	6 GHz WiFi / IEEE 802.11ax	80	OFDM	R	N/A	1P5U2	99.38	0.04	6305.00	71	MCSSO	14.25	13.31	Top	0	3.350	1.242	1.006	4.186	0.209	
Body	6 GHz WiFi / IEEE 802.11be	320	OFDM	R	N/A	1P4X2	99.48	-0.18	6425.00	95	MCSSO	10.50	9.53	Top	0	0.996	1.250	1.005	1.251	0.063	
Body	6 GHz WiFi / IEEE 802.11ax	80	OFDM	R	N/A	1P5U2	99.38	-0.01	6705.00	151	MCSSO	15.25	14.44	Top	0	3.980	1.205	1.006	4.825	0.241	A6
Body	6 GHz WiFi / IEEE 802.11be	320	OFDM	R	Keyboard	1P4X2	99.38	-0.03	6705.00	151	MCSSO	15.25	14.44	Top	0	3.550	1.205	1.006	4.303	0.215	
Body	6 GHz WiFi / IEEE 802.11ax	80	OFDM	R	N/A	1P4X2	99.48	0.04	6905.00	191	MCSSO	10.50	9.58	Top	0	0.642	1.236	1.005	0.797	0.040	
Body	6 GHz WiFi / IEEE 802.11ax	80	OFDM	R	N/A	9V9X2	99.38	0.02	5985.00	7	MCSSO	14.25	13.35	Bottom	0	0.000	1.230	1.006	0.000	0.000	
Body	6 GHz WiFi / IEEE 802.11ax	80	OFDM	R	N/A	1P4X2	99.38	0.05	6705.00	151	MCSSO	15.25	14.44	Bottom	0	0.019	1.205	1.006	0.023	0.001	
Body	6 GHz WiFi / IEEE 802.11ax	80	OFDM	R	N/A	9V9X2	99.38	0.05	5985.00	7	MCSSO	14.25	13.35	Right	0	0.000	1.230	1.006	0.000	0.000	
Body	6 GHz WiFi / IEEE 802.11ax	80	OFDM	R	N/A	1P4X2	99.38	0.08	6705.00	151	MCSSO	15.25	14.44	Right	0	0.081	1.205	1.006	0.098	0.005	
Body	6 GHz WiFi / IEEE 802.11ax	80	OFDM	R	N/A	9V9X2	99.38	0.01	5985.00	7	MCSSO	14.25	13.35	Left	0	0.000	1.230	1.006	0.000	0.000	
Body	6 GHz WiFi / IEEE 802.11ax	80	OFDM	R	N/A	1P4X2	99.38	0.03	6705.00	151	MCSSO	15.25	14.44	Left	0	0.031	1.205	1.006	0.038	0.002	

Table 9-15
6CD SISO Antenna L Tablet - Motion SAR

Exposure	Band / Mode	Bandwidth [MHz]	Service / Modulation	Ant.	Accessory	Serial Number	Duty Cycle [%]	Power Drift [dB]	Frequency [MHz]	Channel #	Data Rate	Max Allowed Power [dBm]	Conducted Power [dBm]	Test Position	Spacing [mm]	Measured 1g SAR [W/kg]	Power Scaling Factor	Duty Cycle Scaling Factor	Reported 1g SAR [W/kg]	Exposure Ratio [g SAR]	Plot #	Plimt [dBm]	Overall Plimt [dBm]
Body	6 GHz WiFi / IEEE 802.11ax	80	OFDM	L	N/A	1P4X2	99.40	-0.05	5985.00	7	MCSSO	14.00	13.21	Back	0	0.067	1.199	1.006	0.081	0.051		24.9	
Body	6 GHz WiFi / IEEE 802.11ax	80	OFDM	L	N/A	1P4X2	99.40	0.03	6705.00	151	MCSSO	14.75	13.69	Back	0	0.048	1.276	1.006	0.062	0.039		26.8	
Body	6 GHz WiFi / IEEE 802.11ax	80	OFDM	L	N/A	1P5U2	99.40	0.14	5985.00	7	MCSSO	14.00	13.21	Top	0	0.292	1.199	1.006	0.352	0.220		18.5	
Body	6 GHz WiFi / IEEE 802.11ax	80	OFDM	L	Keyboard	1P4X2	99.40	-0.12	5985.00	7	MCSSO	14.00	13.21	Top	0	0.227	1.199	1.006	0.274	0.171		19.6	
Body	6 GHz WiFi / IEEE 802.11ax	80	OFDM	L	N/A	1P5U2	99.40	0.04	6305.00	71	MCSSO	14.00	13.15	Top	0	0.216	1.216	1.006	0.264	0.165		19.7	
Body	6 GHz WiFi / IEEE 802.11be	320	OFDM	L	N/A	1P4X2	99.32	0.01	6425.00	95	MCSSO	10.50	9.57	Top	0	0.122	1.239	1.007	0.152	0.095		18.6	
Body	6 GHz WiFi / IEEE 802.11ax	80	OFDM	L	N/A	1P5U2	99.40	0.16	6705.00	151	MCSSO	14.75	13.69	Top	0	0.216	1.276	1.006	0.277	0.173		20.3	
Body	6 GHz WiFi / IEEE 802.11be	320	OFDM	L	N/A	1P4X2	99.32	0.07	6905.00	191	MCSSO	10.50	9.52	Top	0	0.061	1.253	1.007	0.077	0.048		21.6	
Body	6 GHz WiFi / IEEE 802.11ax	80	OFDM	L	N/A	9V9X2	99.40	0.07	5985.00	7	MCSSO	14.00	13.21	Bottom	0	0.000	1.199	1.006	0.000	0.000		53.1	
Body	6 GHz WiFi / IEEE 802.11ax	80	OFDM	L	N/A	1P4X2	99.40	0.03	6705.00	151	MCSSO	14.75	13.69	Bottom	0	0.002	1.276	1.006	0.003	0.002		40.6	
Body	6 GHz WiFi / IEEE 802.11ax	80	OFDM	L	N/A	9V9X2	99.40	0.02	5985.00	7	MCSSO	14.00	13.21	Right	0	0.000	1.199	1.006	0.000	0.000		53.1	
Body	6 GHz WiFi / IEEE 802.11ax	80	OFDM	L	N/A	1P4X2	99.40	0.07	6705.00	151	MCSSO	14.75	13.69	Right	0	0.005	1.276	1.006	0.006	0.004		36.6	
Body	6 GHz WiFi / IEEE 802.11ax	80	OFDM	L	N/A	9V9X2</																	

Table 9-16
6CD SISO Antenna L Tablet - Motion APD

Exposure	Band / Mode	Bandwidth [MHz]	Service / Modulation	Ant.	Housing Type	Serial Number	Duty Cycle [%]	Power Drift [dB]	Frequency [MHz]	Channel #	Data Rate	Max Allowed Power [dBm]	Conducted Power [dBm]	Test Position	Spacing [mm]	Measured APD [W/m ² (4cm ²)	Power Scaling Factor	Duty Cycle Scaling Factor	Reported APD [W/m ² (4cm ²)	APD Exposure Ratio	Plot #
Body	6 GHz WiFi / IEEE 802.11ax	80	OFDM	L	N/A	1P4X2	99.4	-0.05	5985.00	7	MCS0	14.00	13.21	Back	0	0.413	1.199	1.006	0.498	0.025	
Body	6 GHz WiFi / IEEE 802.11ax	80	OFDM	L	N/A	1P4X2	99.4	0.03	6705.00	151	MCS0	14.75	13.69	Back	0	0.353	1.276	1.006	0.453	0.023	
Body	6 GHz WiFi / IEEE 802.11ax	80	OFDM	L	N/A	1P5U2	99.4	0.14	5985.00	7	MCS0	14.00	13.21	Top	0	2.390	1.199	1.006	2.883	0.144	
Body	6 GHz WiFi / IEEE 802.11ax	80	OFDM	L	Keyboard	1P4X2	99.4	-0.12	5985.00	7	MCS0	14.00	13.21	Top	0	1.780	1.199	1.006	2.147	0.107	
Body	6 GHz WiFi / IEEE 802.11ax	80	OFDM	L	N/A	1P5U2	99.4	0.04	6305.00	71	MCS0	14.00	13.15	Top	0	1.660	1.216	1.006	2.031	0.102	
Body	6 GHz WiFi / IEEE 802.11be	320	OFDM	L	N/A	1P4X2	99.32	0.01	6425.00	95	MCS0	10.50	9.57	Top	0	0.911	1.239	1.007	1.137	0.057	
Body	6 GHz WiFi / IEEE 802.11ax	80	OFDM	L	N/A	1P5U2	99.4	0.16	6705.00	151	MCS0	14.75	13.69	Top	0	1.720	1.276	1.006	2.208	0.110	
Body	6 GHz WiFi / IEEE 802.11be	320	OFDM	L	N/A	1P4X2	99.32	0.07	6905.00	191	MCS0	10.50	9.52	Top	0	0.504	1.253	1.007	0.636	0.032	
Body	6 GHz WiFi / IEEE 802.11ax	80	OFDM	L	N/A	9V9X2	99.4	0.07	5985.00	7	MCS0	14.00	13.21	Bottom	0	0.000	1.199	1.006	0.000	0.000	
Body	6 GHz WiFi / IEEE 802.11ax	80	OFDM	L	N/A	1P4X2	99.4	0.03	6705.00	151	MCS0	14.75	13.69	Bottom	0	0.020	1.276	1.006	0.026	0.001	
Body	6 GHz WiFi / IEEE 802.11ax	80	OFDM	L	N/A	9V9X2	99.4	0.02	5985.00	7	MCS0	14.00	13.21	Right	0	0.000	1.199	1.006	0.000	0.000	
Body	6 GHz WiFi / IEEE 802.11ax	80	OFDM	L	N/A	1P4X2	99.4	0.07	6705.00	151	MCS0	14.75	13.69	Right	0	0.043	1.276	1.006	0.055	0.003	
Body	6 GHz WiFi / IEEE 802.11ax	80	OFDM	L	N/A	9V9X2	99.4	0.01	5985.00	7	MCS0	14.00	13.21	Left	0	0.148	1.199	1.006	0.179	0.009	
Body	6 GHz WiFi / IEEE 802.11ax	80	OFDM	L	N/A	1P4X2	99.4	0.07	6705.00	151	MCS0	14.75	13.69	Left	0	0.116	1.276	1.006	0.149	0.007	

9.4 DSS SISO Standalone SAR Data

Table 9-17
DSS SISO Antenna R Laptop and Tablet - No Motion

Exposure	Band / Mode	Service / Modulation	Ant.	Configuration	Serial Number	Duty Cycle [%]	Power Drift [dB]	Frequency [MHz]	Channel #	Data Rate [Mbps]	Max Allowed Power [dBm]	Conducted Power [dBm]	Test Position	Spacing [mm]	Measured 1g SAR [W/kg]	Power Scaling Factor	Duty Cycle Scaling Factor	Reported 1g SAR [W/kg]	Exposure Ratio (1g SAR)	Plot #
Body	2.4 GHz Bluetooth	FHSS	R	Tablet	1P4G2	77.10	0.08	2441.00	39	1	21.0	20.13	Back	25	0.002	1.222	1.025	0.003	0.002	
Body	2.4 GHz Bluetooth	FHSS	R	Tablet	1P4G2	77.10	0.04	2441.00	39	1	21.0	20.13	Top	25	0.013	1.222	1.025	0.016	0.010	
Body	2.4 GHz Bluetooth	FHSS	R	Laptop	1P4G2	77.10	0.03	2441.00	39	1	21.0	20.13	Bottom	0	0.000	1.222	1.025	0.000	0.000	
Body	2.4 GHz Bluetooth	FHSS	R	Tablet	1P4G2	77.10	0.09	2441.00	39	1	21.0	20.13	Right	25	0.000	1.222	1.025	0.000	0.000	
Body	2.4 GHz Bluetooth	FHSS	R	Tablet	1P4G2	77.10	0.08	2441.00	39	1	21.0	20.13	Left	25	0.000	1.222	1.025	0.000	0.000	
ANSI/IEEE C95.1 1992 - SAFETY LIMIT Spatial Peak Uncontrolled Exposure/General Population															Body 1.6 W/kg (mW/g) averaged over 1 gram					

Table 9-18
DSS SISO Antenna L Laptop and Tablet - No Motion

Exposure	Band / Mode	Service / Modulation	Ant.	Configuration	Serial Number	Duty Cycle [%]	Power Drift [dB]	Frequency [MHz]	Channel #	Data Rate [Mbps]	Max Allowed Power [dBm]	Conducted Power [dBm]	Test Position	Spacing [mm]	Measured 1g SAR [W/kg]	Power Scaling Factor	Duty Cycle Scaling Factor	Reported 1g SAR [W/kg]	Exposure Ratio (1g SAR)	Plot #
Body	2.4 GHz Bluetooth	FHSS	L	Tablet	1P4G2	77.10	0.07	2441.00	39	1	21.0	20.94	Back	25	0.004	1.014	1.025	0.004	0.003	
Body	2.4 GHz Bluetooth	FHSS	L	Tablet	1P4G2	77.10	0.12	2441.00	39	1	21.0	20.94	Top	25	0.027	1.014	1.025	0.028	0.018	A7
Body	2.4 GHz Bluetooth	FHSS	L	Laptop	1P4G2	77.10	0.09	2441.00	39	1	21.0	20.94	Bottom	0	0.000	1.014	1.025	0.000	0.000	
Body	2.4 GHz Bluetooth	FHSS	L	Tablet	1P4G2	77.10	0.01	2441.00	39	1	21.0	20.94	Right	25	0.000	1.014	1.025	0.000	0.000	
Body	2.4 GHz Bluetooth	FHSS	L	Tablet	1P4G2	77.10	0.08	2441.00	39	1	21.0	20.94	Left	25	0.001	1.014	1.025	0.001	0.001	
ANSI/IEEE C95.1 1992 - SAFETY LIMIT Spatial Peak Uncontrolled Exposure/General Population															Body 1.6 W/kg (mW/g) averaged over 1 gram					

Table 9-19
DSS SISO Antenna R Tablet - Motion

Exposure	Band / Mode	Service / Modulation	Ant.	Accessory	Serial Number	Duty Cycle [%]	Power Drift [dB]	Frequency [MHz]	Channel #	Data Rate [Mbps]	Max Allowed Power [dBm]	Conducted Power [dBm]	Test Position	Spacing [mm]	Measured 1g SAR [W/kg]	Power Scaling Factor	Duty Cycle Scaling Factor	Reported 1g SAR [W/kg]	Exposure Ratio (1g SAR)	Plot #
Body	2.4 GHz Bluetooth	FHSS	R	N/A	1P4X2	77.10	0.04	2441.00	39	1	20.0	18.01	Back	0	0.050	1.581	1.025	0.081	0.051	
Body	2.4 GHz Bluetooth	FHSS	R	N/A	1P4X2	77.10	-0.01	2441.00	39	1	20.0	18.01	Top	0	0.439	1.581	1.025	0.711	0.444	
Body	2.4 GHz Bluetooth	FHSS	R	Keyboard	1P4G2	77.10	-0.01	2441.00	39	1	20.0	18.01	Top	0	0.432	1.581	1.025	0.700	0.438	
Body	2.4 GHz Bluetooth	FHSS	R	N/A	1P4G2	77.10	0.01	2441.00	39	1	20.0	18.01	Bottom	0	0.002	1.581	1.025	0.003	0.002	
Body	2.4 GHz Bluetooth	FHSS	R	N/A	1P4X2	77.10	0.01	2441.00	39	1	20.0	18.01	Right	0	0.006	1.581	1.025	0.010	0.006	
Body	2.4 GHz Bluetooth	FHSS	R	N/A	1P4G2	77.10	0.02	2441.00	39	1	20.0	18.01	Left	0	0.000	1.581	1.025	0.000	0.000	
ANSI/IEEE C95.1 1992 - SAFETY LIMIT Spatial Peak Uncontrolled Exposure/General Population															Body 1.6 W/kg (mW/g) averaged over 1 gram					

FCC ID: C3K2085	SAR EVALUATION REPORT	Approved by: Technical Manager
Document S/N: 1M2311170118-01.C3K(R1)	DUT Type: Portable Computing Device	Page 45 of 58

Table 9-20
DSS SISO Antenna R Tablet - Motion during conditions with 2.4/5/6 GHz WLAN

Exposure	Band / Mode	Service / Modulation	Ant.	Serial Number	Duty Cycle [%]	Power Drift [dB]	Frequency [MHz]	Channel #	Data Rate [Mbps]	Max Allowed Power [dBm]	Conducted Power [dBm]	Test Position	Spacing [mm]	Measured 1g SAR [W/kg]	Power Scaling Factor	Duty Cycle Scaling Factor	Reported 1g SAR [W/kg]	Exposure Ratio (1g SAR)	Plot #
Body	2.4 GHz Bluetooth	FHSS	R	IP4G2	77.10	-0.06	2441.00	39	1	14.75	13.97	Back	0	0.008	1.197	1.025	0.010	0.006	
Body	2.4 GHz Bluetooth	FHSS	R	1PSU2	77.10	-0.05	2441.00	39	1	14.75	13.97	Top	0	0.090	1.197	1.025	0.110	0.069	
Body	2.4 GHz Bluetooth	FHSS	R	IP4G2	77.10	0.02	2441.00	39	1	14.75	13.97	Bottom	0	0.000	1.197	1.025	0.000	0.000	
Body	2.4 GHz Bluetooth	FHSS	R	IP4G2	77.10	0.02	2441.00	39	1	14.75	13.97	Right	0	0.000	1.197	1.025	0.000	0.000	
Body	2.4 GHz Bluetooth	FHSS	R	IP4G2	77.10	0.01	2441.00	39	1	14.75	13.97	Left	0	0.000	1.197	1.025	0.000	0.000	
ANSI/IEEE C95.1 1992 - SAFETY LIMIT Spatial Peak Uncontrolled Exposure/General Population												Body 1.6 W/kg (mW/g) averaged over 1 gram							

Table 9-21
DSS SISO Antenna L Tablet - Motion

Exposure	Band / Mode	Service / Modulation	Ant.	Accessory	Serial Number	Duty Cycle [%]	Power Drift [dB]	Frequency [MHz]	Channel #	Data Rate [Mbps]	Max Allowed Power [dBm]	Conducted Power [dBm]	Test Position	Spacing [mm]	Measured 1g SAR [W/kg]	Power Scaling Factor	Duty Cycle Scaling Factor	Reported 1g SAR [W/kg]	Exposure Ratio (1g SAR)	Plot #
Body	2.4 GHz Bluetooth	FHSS	L	N/A	1P4X2	77.10	0.04	2441.00	39	1	18.25	18.25	Back	0	0.137	1.000	1.025	0.140	0.088	
Body	2.4 GHz Bluetooth	FHSS	L	N/A	9V9X2	77.10	0.00	2441.00	39	1	18.25	18.25	Top	0	0.622	1.000	1.025	0.638	0.399	
Body	2.4 GHz Bluetooth	FHSS	L	Keyboard	9V9X2	77.10	0.00	2441.00	39	1	18.25	18.25	Top	0	0.766	1.000	1.025	0.785	0.491	A8
Body	2.4 GHz Bluetooth	FHSS	L	N/A	IP4G2	77.10	0.09	2441.00	39	1	18.25	18.25	Bottom	0	0.004	1.000	1.025	0.004	0.003	
Body	2.4 GHz Bluetooth	FHSS	L	N/A	IP4G2	77.10	0.01	2441.00	39	1	18.25	18.25	Right	0	0.004	1.000	1.025	0.004	0.003	
Body	2.4 GHz Bluetooth	FHSS	L	N/A	IP4G2	77.10	0.03	2441.00	39	1	18.25	18.25	Left	0	0.020	1.000	1.025	0.021	0.013	
ANSI/IEEE C95.1 1992 - SAFETY LIMIT Spatial Peak Uncontrolled Exposure/General Population												Body 1.6 W/kg (mW/g) averaged over 1 gram								

Table 9-22
DSS SISO Antenna L Tablet - Motion during conditions with 2.4/5/6 GHz WLAN

Exposure	Band / Mode	Service / Modulation	Ant.	Serial Number	Duty Cycle [%]	Power Drift [dB]	Frequency [MHz]	Channel #	Data Rate [Mbps]	Max Allowed Power [dBm]	Conducted Power [dBm]	Test Position	Spacing [mm]	Measured 1g SAR [W/kg]	Power Scaling Factor	Duty Cycle Scaling Factor	Reported 1g SAR [W/kg]	Exposure Ratio (1g SAR)	Plot #
Body	2.4 GHz Bluetooth	FHSS	L	IP4G2	77.10	0.00	2441.00	39	1	13.0	12.99	Back	0	0.016	1.002	1.025	0.016	0.010	
Body	2.4 GHz Bluetooth	FHSS	L	1PSU2	77.10	0.03	2441.00	39	1	13.0	12.99	Top	0	0.117	1.002	1.025	0.120	0.075	
Body	2.4 GHz Bluetooth	FHSS	L	IP4G2	77.10	0.05	2441.00	39	1	13.0	12.99	Bottom	0	0.000	1.002	1.025	0.000	0.000	
Body	2.4 GHz Bluetooth	FHSS	L	IP4G2	77.10	0.06	2441.00	39	1	13.0	12.99	Right	0	0.000	1.002	1.025	0.000	0.000	
Body	2.4 GHz Bluetooth	FHSS	L	IP4G2	77.10	0.05	2441.00	39	1	13.0	12.99	Left	0	0.001	1.002	1.025	0.001	0.001	
ANSI/IEEE C95.1 1992 - SAFETY LIMIT Spatial Peak Uncontrolled Exposure/General Population												Body 1.6 W/kg (mW/g) averaged over 1 gram							

9.5 NFC Standalone SAR Data

Table 9-23
NFC Body

Exposure	Band / Mode	Signal Type	Ant.	Serial Number	Power Drift [dB]	Frequency [MHz]	Test Position	Spacing [mm]	Measured 1g SAR [W/kg]	Exposure Ratio (1g SAR)	Plot #
Body	NFC	B	NFC	1P4G2	0.01	13.60	Back	0	0.000	0.000	A9
Body	NFC	B	NFC	1P4G2	0.04	13.60	Top	0	0.000	0.000	
Body	NFC	B	NFC	1P4G2	0.01	13.60	Bottom	0	0.000	0.000	
Body	NFC	B	NFC	1P4G2	0.07	13.60	Right	0	0.000	0.000	
Body	NFC	B	NFC	1P4G2	0.08	13.60	Left	0	0.000	0.000	
ANSI/IEEE C95.1 1992 - SAFETY LIMIT Spatial Peak Uncontrolled Exposure/General Population									Body 1.6 W/kg (mW/g) averaged over 1 gram		

FCC ID: C3K2085	SAR EVALUATION REPORT	Approved by: Technical Manager
Document S/N: 1M2311170118-01.C3K(R1)	DUT Type: Portable Computing Device	Page 46 of 58

9.6 SAR Test Notes

General Notes:

1. The test data reported are the worst-case SAR values according to test procedures specified in IEEE 1528-2013, FCC KDB Publication 447498 D04v01, and FCC KDB Publication 616217 D04v01r02.
2. Batteries are fully charged at the beginning of the SAR measurements.
3. Liquid tissue depth was at least 15.0 cm for all frequencies.
4. The manufacturer has confirmed that the device(s) tested have the same physical, mechanical and thermal characteristics and are within operational tolerances expected for production units.
5. SAR results were scaled to the maximum allowed power to demonstrate compliance per FCC KDB Publication 447498 D04v01.
6. Per FCC KDB Publication 865664 D01v01r04, variability SAR tests were not required since measured SAR results for all frequency bands were less than 0.8 W/kg.
7. This device uses Qualcomm FastConnect TAS for WLAN operations to control and manage transmitting power in real time to ensure RF Exposure compliance. Per FCC Guidance, compliance for was assessed at the minimum of the time averaged power and the maximum output power for each band/mode/exposure condition (DSI).
8. Per October 2020 TCB Workshop notes, absorbed power density (APD) using a 4cm² averaging area is reported based on SAR measurements.
9. FCC KDB Publication 616217 D04v01r02 Section 4.3, SAR tests are required for the back surface and edges of the tablet with the tablet touching the phantom. The SAR Exclusion Threshold in FCC KDB 447498 D04v01 was applied to determine SAR test exclusion for adjacent edge configurations.
10. Per FCC KDB 616217 D04, SAR is evaluated for the bottom surface of a keyboard when it is attached to the DUT in laptop configuration.
11. Per FCC Guidance, SAR tests are required for the back surface and edges of the tablet with the tablet 25mm away from the phantom when the motion sensor is not active. The SAR Exclusion Threshold in FCC KDB 447498 D04v01 was applied to determine SAR test exclusion for adjacent edge configurations.
12. Per FCC KDB 648474 D04, highest reported SAR tablet configuration for a transmission band on an antenna was additionally evaluated with keyboard accessory attached and folded back at 360°
13. The orange highlights throughout the report represent the highest scaled SAR per Equipment Class.
14. The device is sold with either an OLED or LCD display type. Testing was performed with both display types.

WLAN Notes:

1. Justification for test configurations for WLAN per KDB Publication 248227 D01v02r02 for 2.4 GHz WIFI single transmission chain operations, the highest measured maximum output power channel for DSSS was selected for SAR measurement. SAR for OFDM modes (2.4 GHz 802.11g/n/ax) was not required due to the maximum allowed powers and the highest reported DSSS SAR. See Section 6.2.5 for more information.
2. Justification for test configurations for WLAN per KDB Publication 248227 D01v02r02 for 5 GHz WIFI operations, the initial test configuration was selected according to the transmission mode with the highest maximum allowed powers. Other transmission modes were not investigated since the highest reported SAR for initial test configuration adjusted by the ratio of maximum output powers is less than 1.2 W/kg for 1g evaluations. See Section 6.2.6 for more information.
3. Per KDB Publication 248227 D01v02r02, SAR for MIMO was evaluated by following the simultaneous SAR provisions from KDB Publication 447498 D01v01 by either evaluating the sum of the 1g SAR values of each antenna transmitting independently or making a SAR measurement with both antennas transmitting simultaneously. Please see the Multi-Tx and Antenna SAR Considerations Appendix for complete analysis.
4. When the maximum reported 1g averaged SAR is ≤ 0.8 W/kg, SAR testing on additional channels was not required. Otherwise, SAR for the next highest output power channel was required until the reported SAR result was ≤ 1.20 W/kg for 1g evaluations or all test channels were measured.
5. The device was configured to transmit continuously at the required data rate, channel bandwidth and signal modulation, using the highest transmission duty factor supported by the test mode tools. The reported SAR was scaled to the 100% transmission duty factor to determine compliance. Procedures used to measure the duty factor are identical to that in the associated EMC test reports.

FCC ID: C3K2085	SAR EVALUATION REPORT	Approved by: Technical Manager
Document S/N: 1M231170118-01.C3K(R1)	DUT Type: Portable Computing Device	Page 47 of 58

REV 22.0
03/30/2022



6. Per FCC guidance, SAR was performed using 6.5 GHz SAR probe calibration factors. Per October 2020 TCB Workshop notes, 5 channels were tested.

Bluetooth Notes

1. Bluetooth SAR was measured with the device connected to a call box with hopping disabled with DH5 operation and Tx Tests test mode type. Per October 2016 TCB Workshop Notes, the reported SAR was scaled to the 79% transmission duty factor to determine compliance. See Section 9 for the time domain plot and calculation for the duty factor of the device.

FCC ID: C3K2085	SAR EVALUATION REPORT	Approved by: Technical Manager
Document S/N: 1M2311170118-01.C3K(R1)	DUT Type: Portable Computing Device	Page 48 of 58

REV 22.0
03/30/2022

10 POWER DENSITY DATA SUMMARY

10.1 6 GHz WIFI Power Density Results

**Table 10-1
6CD Laptop and Tablet – No Motion Power Density**

MEASUREMENT RESULTS																							
Frequency (MHz)	Channel	Mode	Service	Bandwidth (MHz)	Maximum Allowed Power (Ant 1) (dBm)	Conducted Power (Ant 1) (dBm)	Power Drift (dB)	Spacing (mm)	Antenna Config.	Configuration	DUT Serial Number	Data Rate (Mbps)	Side	Duty Cycle (%)	Grid Step (A)	Scaling Factor for Measurement Uncertainty per IEC 62479	Scaling Factor (Power)	Scaling Factor (Duty Cycle)	Normal psPD (W/m ²)	Scaled Normal psPD (W/m ²)	Total psPD (W/m ²)	Scaled Total psPD (W/m ²)	Plot #
6005.00	11	802.11ax	OFDM	40	20.00	19.13	-0.18	25	R	Tablet	1P4G2	MCS0	Back	99.34	0.125	1.554	1.222	1.007	0.650	1.243	0.650	1.262	
6005.00	11	802.11ax	OFDM	40	20.00	19.13	-0.17	2	R	Laptop	1P4G2	MCS0	Bottom	99.34	0.125	1.554	1.222	1.007	0.201	0.384	0.211	0.403	
6005.00	11	802.11ax	OFDM	40	20.00	19.13	-0.15	25	R	Tablet	1P4X2	MCS0	Top	99.34	0.125	1.554	1.222	1.007	1.990	3.805	2.980	3.978	
6285.00	67	802.11ax	OFDM	40	20.00	18.81	-0.18	25	R	Tablet	1P4G2	MCS0	Top	99.34	0.125	1.554	1.315	1.007	1.160	2.387	1.220	2.511	
6425.00	95	802.11be	OFDM	320	10.50	9.53	0.13	25	R	Tablet	1P4G2	MCS0	Top	99.48	0.125	1.554	1.250	1.005	0.100	0.195	0.132	0.258	
6705.00	151	802.11ax	OFDM	80	20.00	18.39	-0.18	25	R	Tablet	1P4G2	MCS0	Top	99.38	0.125	1.554	1.449	1.006	1.320	2.950	1.470	3.330	
6905.00	191	802.11be	OFDM	320	10.50	9.58	-0.14	25	R	Tablet	1P4G2	MCS0	Top	99.48	0.125	1.554	1.236	1.005	0.073	0.141	0.102	0.197	
6005.00	11	802.11ax	OFDM	40	20.00	19.00	0.14	25	L	Tablet	1P4G1	MCS0	Back	99.57	0.125	1.554	1.259	1.004	0.274	0.538	0.315	0.619	
6005.00	11	802.11ax	OFDM	40	20.00	19.00	-0.13	2	L	Laptop	1P4G2	MCS0	Bottom	99.57	0.125	1.554	1.259	1.004	0.351	0.689	0.354	0.695	
6005.00	11	802.11ax	OFDM	40	20.00	19.00	0.17	25	L	Tablet	1P4X2	MCS0	Top	99.57	0.125	1.554	1.259	1.004	3.330	6.541	3.570	7.013	A10
6285.00	67	802.11ax	OFDM	40	20.00	18.92	0.17	25	L	Tablet	1P4G2	MCS0	Top	99.57	0.125	1.554	1.282	1.004	1.700	3.400	1.820	3.640	
6425.00	95	802.11be	OFDM	320	10.50	9.57	-0.12	25	L	Tablet	1P4G2	MCS0	Top	99.32	0.125	1.554	1.239	1.007	0.258	0.500	0.290	0.562	
6705.00	151	802.11ax	OFDM	80	20.00	18.78	-0.14	25	L	Tablet	1P4G2	MCS0	Top	99.40	0.125	1.554	1.324	1.006	1.480	3.063	1.540	3.188	
6905.00	191	802.11be	OFDM	320	10.50	9.52	0.12	25	L	Tablet	1P4G2	MCS0	Top	99.32	0.125	1.554	1.253	1.007	0.321	0.629	0.329	0.645	
47 CFR §1.1310 - SAFETY LIMIT Spatial Average Uncontrolled Exposure / General Population												Power Density 10 W/m ² averaged over 4 cm ²											

FCC ID: C3K2085	SAR EVALUATION REPORT	Approved by: Technical Manager
Document S/N: 1M2311170118-01.C3K(R1)	DUT Type: Portable Computing Device	Page 49 of 58

**Table 10-2
6CD Tablet - Motion Power Density**

MEASUREMENT RESULTS																								
Frequency (MHz)	Channel	Mode	Service	Bandwidth (MHz)	Maximum Allowed Power (Art 1) (dBm)	Conducted Power (Art 1) (dBm)	Power DnB (dB)	Spacing (mm)	Antenna Config.	Accessory	DUT Serial Number	Data Rate (Mbps)	Side	Duty Cycle (%)	Grid Step (λ)	iPD (W/m²)	Scaling Factor for Measurement Uncertainty per IEC 62479	Scaling Factor (Power)	Scaling Factor (Duty Cycle)	Normal psPD (W/m²)	Scaled Normal psPD (W/m²)	Total psPD (W/m²)	Scaled Total psPD (W/m²)	Plot #
6705.00	151	802.11ax	OFDM	80	15.25	14.44	-0.18	2	R	N/A	IP4S2	MCS0	Back	99.38	0.125	-	1.554	1.205	1.006	0.200	0.377	0.251	0.473	
5985.00	7	802.11ax	OFDM	80	14.25	13.35	0.10	2	R	N/A	IP4S2	MCS0	Top	99.38	0.125	1.060	1.554	1.230	1.006	1.420	2.731	1.800	3.461	
6305.00	71	802.11ax	OFDM	80	14.25	13.31	0.10	2	R	N/A	IP4S2	MCS0	Top	99.38	0.125	-	1.554	1.242	1.006	1.080	2.097	1.350	2.621	
6425.00	95	802.11be	OFDM	320	10.50	9.53	0.19	2	R	N/A	IP4S2	MCS0	Top	99.48	0.125	-	1.554	1.250	1.005	0.624	1.218	0.704	1.374	
6705.00	151	802.11ax	OFDM	80	15.25	14.44	-0.13	2	R	N/A	IP4S2	MCS0	Top	99.38	0.125	-	1.554	1.205	1.006	1.100	2.072	1.570	2.958	
6905.00	191	802.11be	OFDM	320	10.50	9.58	0.15	2	R	N/A	IP4S2	MCS0	Top	99.48	0.125	-	1.554	1.236	1.005	0.366	0.707	0.463	0.894	
5985.00	7	802.11ax	OFDM	80	14.25	13.35	-0.15	10.01	R	N/A	IP4S2	MCS0	Top	99.38	0.125	0.174	1.554	1.230	1.006	0.275	0.529	0.306	0.588	
5985.00	7	802.11ax	OFDM	80	14.25	13.35	0.11	2	R	Keyboard	IP4S2	MCS0	Top	99.38	0.125	-	1.554	1.230	1.006	1.520	2.923	1.620	3.115	
6075.00	151	802.11ax	OFDM	80	14.75	13.69	0.12	2	L	N/A	IP4S2	MCS0	Back	99.40	0.125	-	1.554	1.276	1.006	0.716	1.428	0.821	1.638	
5985.00	7	802.11ax	OFDM	80	14.00	13.21	0.17	2	L	N/A	IP4S2	MCS0	Top	99.40	0.125	-	1.554	1.199	1.006	1.790	3.355	2.040	3.824	
6305.00	71	802.11ax	OFDM	80	14.00	13.15	0.17	2	L	N/A	IP4S2	MCS0	Top	99.40	0.125	-	1.554	1.216	1.006	0.852	1.620	1.040	1.977	
6425.00	95	802.11be	OFDM	320	10.50	9.57	0.14	2	L	N/A	IP4S2	MCS0	Top	99.32	0.125	-	1.554	1.239	1.007	0.398	0.772	0.435	0.843	
6705.00	151	802.11ax	OFDM	80	14.75	13.69	-0.08	2	L	N/A	IP4S2	MCS0	Top	99.40	0.125	2.460	1.554	1.276	1.006	2.750	5.486	3.020	6.024	A11
6905.00	191	802.11be	OFDM	320	10.50	9.52	0.14	2	L	N/A	IP4S2	MCS0	Top	99.32	0.125	-	1.554	1.253	1.007	0.546	1.071	0.674	1.322	
6075.00	151	802.11ax	OFDM	80	14.75	13.69	-0.17	8.94	L	N/A	IP4S2	MCS0	Top	99.40	0.125	0.389	1.554	1.276	1.006	0.184	0.367	0.190	0.379	
6075.00	151	802.11ax	OFDM	80	14.75	13.69	0.15	2	L	Keyboard	IP4S2	MCS0	Top	99.40	0.125	-	1.554	1.276	1.006	1.790	3.571	2.150	4.289	
47 CFR §1.1310 - SAFETY LIMIT Spatial Average Uncontrolled Exposure / General Population												Power Density 10 W/m² averaged over 4 cm²												

Power Density General Notes

1. The manufacturer has confirmed that the devices tested have the same physical, mechanical and thermal characteristics and are within operational tolerances expected for production units.
2. Batteries are fully charged at the beginning of the measurements. The DUT was connected to a wall charger for some measurements due to the test duration. It was confirmed that the charger plugged into this DUT did not impact the near-field PD test results.
3. Power density was calculated by repeated E-field measurements on two measurement planes separated by λ/4.
4. The device was configured to transmit continuously at the required data rate, channel bandwidth and signal modulation, using the highest transmission duty factor supported by the test mode tools.
5. Per FCC guidance and equipment manufacturer guidance, power density results were scaled according to IEC 62479:2010 for the portion of the measurement uncertainty > 30%. Total expanded uncertainty of 2.68 dB (85.4%) was used to determine the psPD measurement scaling factor.
6. Per equipment manufacturer guidance, power density was measured at d=2mm and d=λ/5mm using the same grid size and grid step size for some frequencies and surfaces. The integrated Power Density (iPD) was calculated based on these measurements. Since iPD ratio between the two distances is ≥ -1dB, the grid step was sufficient for determining compliance at d=2mm.
7. PTP-PR algorithm was used during psPD measurement and calculations.
8. PD results were scaled to the maximum allowed power to demonstrate compliance per FCC KDB Publication 447498 D04.

FCC ID: C3K2085	SAR EVALUATION REPORT	Approved by: Technical Manager
Document S/N: 1M2311170118-01.C3K(R1)	DUT Type: Portable Computing Device	Page 50 of 58

11 SAR MEASUREMENT VARIABILITY

11.1 Measurement Variability

Per FCC KDB Publication 865664 D01v01r04, all measured 1 g SAR values were <0.8 W/kg Therefore, no SAR measurement variability analysis was required.

11.2 Measurement Uncertainty

The measured SAR was <1.5 W/kg for 1g for all frequency bands. Therefore, per KDB Publication 865664 D01v01r04, the extended measurement uncertainty analysis per IEEE 1528-2013 was not required.

FCC ID: C3K2085	SAR EVALUATION REPORT	Approved by: Technical Manager
Document S/N: 1M2311170118-01.C3K(R1)	DUT Type: Portable Computing Device	Page 51 of 58

REV 22.0
03/30/2022

12 EQUIPMENT LIST

Manufacturer	Model	Description	Cal Date	Cal Interval	Cal Due	Serial Number
Agilent	E4404B	Spectrum Analyzer	N/A	N/A	N/A	MY45113242
Agilent	E4438C	ESG Vector Signal Generator	11/14/2023	Annual	11/14/2024	MY45093852
Agilent	E4438C	ESG Vector Signal Generator	11/15/2023	Annual	11/15/2024	MY45092078
Agilent	N5182A	MXG Vector Signal Generator	10/12/2023	Annual	10/12/2024	MY47400015
Agilent	N5182A	MXG Vector Signal Generator	7/4/2023	Annual	7/4/2024	MY48180366
Agilent	8753ES	S-Parameter Vector Network Analyzer	1/10/2024	Annual	1/10/2025	MY40001472
Agilent	E5515C	Wireless Communications Test Set	CBT	N/A	CBT	US41140256
Agilent	E5515C	Wireless Communications Test Set	1/10/2024	Annual	1/10/2025	MY50262130
Agilent	N4010A	Wireless Connectivity Test Set	N/A	N/A	N/A	GB46170464
Amplifier Research	15S1G6	Amplifier	CBT	N/A	CBT	433973
Amplifier Research	15S1G6	Amplifier	CBT	N/A	CBT	433974
Amplifier Research	150A100C	Amplifier	CBT	N/A	CBT	350132
Anritsu	ML2496A	Power Meter	6/15/2023	Annual	6/15/2024	1138001
Anritsu	ML2496A	Power Meter	4/4/2023	Annual	4/4/2024	1840005
Anritsu	MA2411B	Pulse Power Sensor	8/22/2023	Annual	8/22/2024	1726262
Anritsu	MA2411B	Pulse Power Sensor	11/8/2023	Annual	11/8/2024	1027293
Anritsu	MA24106A	USB Power Sensor	6/15/2023	Annual	6/15/2024	1827530
Anritsu	MA24106A	USB Power Sensor	12/4/2023	Annual	12/4/2024	1520501
Control Company	4052	Long Stem Thermometer	10/16/2023	Biennial	10/16/2025	230703247
Control Company	4052	Long Stem Thermometer	10/16/2023	Biennial	10/16/2025	230702935
Control Company	4052	Long Stem Thermometer	2/17/2023	Biennial	2/17/2025	230111049
Control Company	4040	Therm./ Clock/ Humidity Monitor	1/15/2024	Annual	1/15/2025	160574418
Mitutoyo	500-196-30	CD-6° ASX 6inch Digital Caliper	2/16/2022	Triennial	2/16/2025	A20238413
Keysight Technologies	N6705B	DC Power Analyzer	5/5/2021	Triennial	5/5/2024	MY53004059
Keysight Technologies	N9020A	MXA Signal Analyzer	4/6/2023	Annual	4/6/2024	MY48010233
Agilent	N9020A	MXA Signal Analyzer	4/26/2022	Biennial	4/26/2024	MY56470202
MCL	BW-N6W5+	6dB Attenuator	CBT	N/A	CBT	1139
Mini-Circuits	VLf-6000+	Low Pass Filter DC to 6000 MHz	CBT	N/A	CBT	N/A
Mini-Circuits	VLf-6000+	Low Pass Filter DC to 6000 MHz	7/5/2023	Annual	7/5/2024	31634
Mini-Circuits	BW-N20W5+	DC to 18 GHz Precision Fixed 20 dB Attenuator	CBT	N/A	CBT	N/A
Mini-Circuits	NLP-2950+	Low Pass Filter DC to 2700 MHz	CBT	N/A	CBT	N/A
Mini-Circuits	BW-N20W5	Power Attenuator	CBT	N/A	CBT	1226
Mini-Circuits	ZUDC10-83-S+	Directional Coupler	CBT	N/A	CBT	2050
Narda	4772-3	Attenuator (3dB)	CBT	N/A	CBT	9406
Narda	BW-S3W2	Attenuator (3dB)	CBT	N/A	CBT	120
Seekonk	NC-100	Torque Wrench	CBT	N/A	CBT	22217
Seekonk	NC-100	Torque Wrench	CBT	N/A	CBT	1262
SPEAG	DAK-3.5	Dielectric Assessment Kit	11/13/2023	Annual	11/13/2024	1277
SPEAG	DAKS-3.5	Portable Dielectric Assessment Kit	8/14/2023	Annual	8/14/2024	1041
SPEAG	MAIA	Modulation and Audio Interference Analyzer	N/A	N/A	N/A	1237
SPEAG	MAIA	Modulation and Audio Interference Analyzer	N/A	N/A	N/A	1331
SPEAG	MAIA	Modulation and Audio Interference Analyzer	N/A	N/A	N/A	1390
SPEAG	DAK-12	Dielectric Assessment Kit (4MHz - 3GHz)	11/13/2023	Annual	11/13/2024	1121
SPEAG	CLA-13	Confined Loop Antenna	9/12/2023	Annual	9/12/2024	1002
SPEAG	D2450V2	2450 MHz SAR Dipole	8/18/2021	Triennial	8/18/2024	719
SPEAG	D2450V2	2450 MHz SAR Dipole	11/25/2021	Triennial	11/25/2024	981
SPEAG	D5GHzV2	5 GHz SAR Dipole	2/21/2024	Annual	2/21/2025	1057
SPEAG	D5GHzV2	5 GHz SAR Dipole	1/17/2024	Annual	1/17/2025	1191
SPEAG	D6.5GHzV2	6.5 GHz SAR Dipole	1/10/2024	Annual	1/10/2025	1018
SPEAG	D6.5GHzV2	6.5 GHz SAR Dipole	1/10/2024	Annual	1/10/2025	1020
SPEAG	5G Verification Source 10GHz	10GHz System Verification Antenna	8/11/2023	Annual	8/11/2024	1004
SPEAG	5G Verification Source 10GHz	10GHz System Verification Antenna	3/5/2024	Annual	3/5/2025	1002
SPEAG	DAE4	Dasy Data Acquisition Electronics	6/15/2023	Annual	6/15/2024	1334
SPEAG	DAE4	Dasy Data Acquisition Electronics	1/16/2024	Annual	1/16/2025	1530
SPEAG	DAE4	Dasy Data Acquisition Electronics	4/14/2023	Annual	4/14/2024	1368
SPEAG	DAE4	Dasy Data Acquisition Electronics	1/9/2024	Annual	1/9/2025	1533
SPEAG	DAE4	Dasy Data Acquisition Electronics	11/15/2023	Annual	11/15/2024	1323
SPEAG	DAE4ip	Dasy Data Acquisition Electronics	10/18/2023	Annual	10/18/2024	1638
SPEAG	EX3DV4	SAR Probe	1/17/2024	Annual	1/17/2025	7713
SPEAG	EX3DV4	SAR Probe	11/14/2023	Annual	11/14/2024	7551
SPEAG	EX3DV4	SAR Probe	7/7/2023	Annual	7/7/2024	7410
SPEAG	EX3DV4	SAR Probe	4/18/2023	Annual	4/18/2024	7718
SPEAG	EX3DV4	SAR Probe	1/11/2024	Annual	1/11/2025	7803
SPEAG	EX3DV4	SAR Probe	6/15/2023	Annual	6/15/2024	7409
SPEAG	EUMmWV4	EUMmWV4 Probe	2/2/2024	Annual	2/2/2025	9622

Note: 1) All equipment was used solely within its respective calibration period. 2) CBT (Calibrated Before Testing). Prior to testing, the measurement paths containing a cable, amplifier, attenuator, coupler or filter were connected to a calibrated source (i.e. a signal generator) to determine the losses of the measurement path. The power meter offset was then adjusted to compensate for the measurement system losses. This level offset is stored within the power meter before measurements are made. This calibration verification procedure applies to the system verification and output power measurements. The calibrated reading is then taken directly from the power meter after compensation of the losses for all final power measurements.

FCC ID: C3K2085	SAR EVALUATION REPORT	Approved by: Technical Manager
Document S/N: 1M2311170118-01.C3K(R1)	DUT Type: Portable Computing Device	Page 52 of 58

13 MEASUREMENT UNCERTAINTIES

Applicable for SAR measurements < 6GHz:

a	b	c	d	e = f(d,k)	f	g	h = c x f/e	i = c x g/e	k
Uncertainty Component	IEEE 1528 Sec.	Tol. (± %)	Prob. Dist.	Div.	c _i 1gm	c _i 10 gms	1gm u _i (± %)	10gms u _i (± %)	v _i
Measurement System									
Probe Calibration	E.2.1	7	N	1	1	1	7.0	7.0	∞
Axial Isotropy	E.2.2	0.25	N	1	0.7	0.7	0.2	0.2	∞
Hemishperical Isotropy	E.2.2	1.3	N	1	0.7	0.7	0.9	0.9	∞
Boundary Effect	E.2.3	2	R	1.73	1	1	1.2	1.2	∞
Linearity	E.2.4	0.3	N	1	1	1	0.3	0.3	∞
System Detection Limits	E.2.4	0.25	R	1.73	1	1	0.1	0.1	∞
Modulation Response	E.2.5	4.8	R	1.73	1	1	2.8	2.8	∞
Readout Electronics	E.2.6	0.3	N	1	1	1	0.3	0.3	∞
Response Time	E.2.7	0.8	R	1.73	1	1	0.5	0.5	∞
Integration Time	E.2.8	2.6	R	1.73	1	1	1.5	1.5	∞
RF Ambient Conditions - Noise	E.6.1	3	R	1.73	1	1	1.7	1.7	∞
RF Ambient Conditions - Reflections	E.6.1	3	R	1.73	1	1	1.7	1.7	∞
Probe Positioner Mechanical Tolerance	E.6.2	0.8	R	1.73	1	1	0.5	0.5	∞
Probe Positioning w/ respect to Phantom	E.6.3	6.7	R	1.73	1	1	3.9	3.9	∞
Extrapolation, Interpolation & Integration algorithms for Max. SAR Evaluation	E.5	4	R	1.73	1	1	2.3	2.3	∞
Test Sample Related									
Test Sample Positioning	E.4.2	3.12	N	1	1	1	3.1	3.1	35
Device Holder Uncertainty	E.4.1	1.67	N	1	1	1	1.7	1.7	5
Output Power Variation - SAR drift measurement	E.2.9	5	R	1.73	1	1	2.9	2.9	∞
SAR Scaling	E.6.5	0	R	1.73	1	1	0.0	0.0	∞
Phantom & Tissue Parameters									
Phantom Uncertainty (Shape & Thickness tolerances)	E.3.1	7.6	R	1.73	1.0	1.0	4.4	4.4	∞
Liquid Conductivity - measurement uncertainty	E.3.3	4.3	N	1	0.78	0.71	3.3	3.0	76
Liquid Permittivity - measurement uncertainty	E.3.3	4.2	N	1	0.23	0.26	1.0	1.1	75
Liquid Conductivity - Temperature Uncertainty	E.3.4	3.4	R	1.73	0.78	0.71	1.5	1.4	∞
Liquid Permittivity - Temperature Uncertainty	E.3.4	0.6	R	1.73	0.23	0.26	0.1	0.1	∞
Liquid Conductivity - deviation from target values	E.3.2	5.0	R	1.73	0.64	0.43	1.8	1.2	∞
Liquid Permittivity - deviation from target values	E.3.2	5.0	R	1.73	0.60	0.49	1.7	1.4	∞
Comblned Standard Uncertainty (k=1)	RSS						12.2	12.0	191
Expanded Uncertainty (95% CONFIDENCE LEVEL)	k=2						24.4	24.0	

The above measurement uncertainties are according to IEEE Std. 1528-2013

FCC ID: C3K2085	SAR EVALUATION REPORT	Approved by: Technical Manager
Document S/N: 1M2311170118-01.C3K(R1)	DUT Type: Portable Computing Device	Page 53 of 58

REV 22.0
03/30/2022

Applicable for SAR measurements > 6GHz:

a	b	c	d	e = f(d,k)	f	g	h = c x f/e	i = c x g/e	k
Uncertainty Component	IEEE 1528 Sec.	Tol. (± %)	Prob. Dist.	Div.	c _i 1gm	c _i 10 gms	1gm u _i (± %)	10gms u _i (± %)	v _i
Measurement System									
Probe Calibration	E.2.1	9.3	N	1	1	1	9.3	9.3	∞
Axial Isotropy	E.2.2	0.25	N	1	0.7	0.7	0.2	0.2	∞
Hemishperical Isotropy	E.2.2	1.3	N	1	0.7	0.7	0.9	0.9	∞
Boundary Effect	E.2.3	2	R	1.73	1	1	1.2	1.2	∞
Linearity	E.2.4	0.3	N	1	1	1	0.3	0.3	∞
System Detection Limits	E.2.4	0.25	R	1.73	1	1	0.1	0.1	∞
Modulation Response	E.2.5	4.8	R	1.73	1	1	2.8	2.8	∞
Readout Electronics	E.2.6	0.3	N	1	1	1	0.3	0.3	∞
Response Time	E.2.7	0.8	R	1.73	1	1	0.5	0.5	∞
Integration Time	E.2.8	2.6	R	1.73	1	1	1.5	1.5	∞
RF Ambient Conditions - Noise	E.6.1	3	R	1.73	1	1	1.7	1.7	∞
RF Ambient Conditions - Reflections	E.6.1	3	R	1.73	1	1	1.7	1.7	∞
Probe Positioner Mechanical Tolerance	E.6.2	0.8	R	1.73	1	1	0.5	0.5	∞
Probe Positioning w/ respect to Phantom	E.6.3	6.7	R	1.73	1	1	3.9	3.9	∞
Extrapolation, Interpolation & Integration algorithms for Max. SAR Evaluation	E.5	4	R	1.73	1	1	2.3	2.3	∞
Test Sample Related									
Test Sample Positioning	E.4.2	3.12	N	1	1	1	3.1	3.1	35
Device Holder Uncertainty	E.4.1	1.67	N	1	1	1	1.7	1.7	5
Output Power Variation - SAR drift measurement	E.2.9	5	R	1.73	1	1	2.9	2.9	∞
SAR Scaling	E.6.5	0	R	1.73	1	1	0.0	0.0	∞
Phantom & Tissue Parameters									
Phantom Uncertainty (Shape & Thickness tolerances)	E.3.1	7.6	R	1.73	1.0	1.0	4.4	4.4	∞
Liquid Conductivity - measurement uncertainty	E.3.3	4.3	N	1	0.78	0.71	3.3	3.0	76
Liquid Permittivity - measurement uncertainty	E.3.3	4.2	N	1	0.23	0.26	1.0	1.1	75
Liquid Conductivity - Temperature Uncertainty	E.3.4	3.4	R	1.73	0.78	0.71	1.5	1.4	∞
Liquid Permittivity - Temperature Unceritainty	E.3.4	0.6	R	1.73	0.23	0.26	0.1	0.1	∞
Liquid Conductivity - deviation from target values	E.3.2	5.0	R	1.73	0.64	0.43	1.8	1.2	∞
Liquid Permittivity - deviation from target values	E.3.2	5.0	R	1.73	0.60	0.49	1.7	1.4	∞
Combined Standard Uncertainty (k=1)	RSS						13.8	13.6	191
Expanded Uncertainty (95% CONFIDENCE LEVEL)	k=2						27.6	27.1	

The above measurement uncertainties are according to IEEE Std. 1528-2013

FCC ID: C3K2085	SAR EVALUATION REPORT	Approved by: Technical Manager
Document S/N: 1M2311170118-01.C3K(R1)	DUT Type: Portable Computing Device	Page 54 of 58

Applicable for Power Density Measurements:

a	b	c	d	e	f = c x f/e	g
Uncertainty Component	Unc. (± dB)	Prob. Dist.	Div.	c _i	u _i (± dB)	v _i
Measurement System						
Calibration	0.49	N	1	1	0.49	∞
Probe Correction	0.00	R	1.73	1	0.00	∞
Frequency Response	0.20	R	1.73	1	0.12	∞
Sensor Cross Coupling	0.00	R	1.73	1	0.00	∞
Isotropy	0.50	R	1.73	1	0.29	∞
Linearity	0.20	R	1.73	1	0.12	∞
Probe Scattering	0.00	R	1.73	1	0.00	∞
Probe Positioning offset	0.30	R	1.73	1	0.17	∞
Probe Positioning Repeatability	0.04	R	1.73	1	0.02	∞
Sensor Mechanical Offset	0.00	R	1.73	1	0.00	∞
Probe Spatial Resolution	0.00	R	1.73	1	0.00	∞
Field Impedance Dependence	0.00	R	1.73	1	0.00	∞
Amplitude and Phase Drift	0.00	R	1.73	1	0.00	∞
Amplitude and Phase Noise	0.04	R	1.73	1	0.02	∞
Measurement Area Truncation	0.00	R	1.73	1	0.00	∞
Data Acquisition	0.03	N	1	1	0.03	∞
Sampling	0.00	R	1.73	1	0.00	∞
Field Reconstruction	2.00	R	1.73	1	1.15	∞
Forward Transformation	0.00	R	1.73	1	0.00	∞
Power Density Scaling	0.00	R	1.73	1	0.00	∞
Spatial Averaging	0.10	R	1.73	1	0.06	∞
System Detection Limit	0.04	R	1.73	1	0.02	∞
Test Sample Related						
Probe Coupling with DUT	0.00	R	1.73	1	0.00	∞
Modulation Response	0.40	R	1.73	1	0.23	∞
Integration Time	0.00	R	1.73	1	0.00	∞
Response Time	0.00	R	1.73	1	0.00	∞
Device Holder Influence	0.10	R	1.73	1	0.06	∞
DUT alignment	0.00	R	1.73	1	0.00	∞
RF Ambient Conditions	0.04	R	1.73	1	0.02	∞
Ambient Reflections	0.04	R	1.73	1	0.02	∞
Immunity/Secondary Reception	0.00	R	1.73	1	0.00	∞
Drift of DUT	0.21	R	1.73	1	0.12	∞
Combined Standard Uncertainty (k=1)		RSS			1.34	∞
Expanded Uncertainty (95% CONFIDENCE LEVEL)		k=2			2.68	

FCC ID: C3K2085	SAR EVALUATION REPORT	Approved by: Technical Manager
Document S/N: 1M2311170118-01.C3K(R1)	DUT Type: Portable Computing Device	Page 55 of 58

14 CONCLUSION

14.1 Measurement Conclusion

The SAR evaluation indicates that the EUT complies with the RF radiation exposure limits of the FCC and Innovation, Science, and Economic Development Canada, with respect to all parameters subject to this test. These measurements were taken to simulate the RF effects of RF exposure under worst-case conditions. Precise laboratory measures were taken to assure repeatability of the tests. The results and statements relate only to the item(s) tested.

Please note that the absorption and distribution of electromagnetic energy in the body are very complex phenomena that depend on the mass, shape, and size of the body, the orientation of the body with respect to the field vectors, and the electrical properties of both the body and the environment. Other variables that may play a substantial role in possible biological effects are those that characterize the environment (e.g. ambient temperature, air velocity, relative humidity, and body insulation) and those that characterize the individual (e.g. age, gender, activity level, debilitation, or disease). Because various factors may interact with one another to vary the specific biological outcome of an exposure to electromagnetic fields, any protection guide should consider maximal amplification of biological effects as a result of field-body interactions, environmental conditions, and physiological variables. [3]

FCC ID: C3K2085	SAR EVALUATION REPORT	Approved by: Technical Manager
Document S/N: 1M2311170118-01.C3K(R1)	DUT Type: Portable Computing Device	Page 56 of 58

REV 22.0
03/30/2022

15 REFERENCES

- [1] Federal Communications Commission, ET Docket 93-62, Guidelines for Evaluating the Environmental Effects of Radiofrequency Radiation, Aug. 1996.
- [2] ANSI/IEEE C95.1-2005, American National Standard safety levels with respect to human exposure to radio frequency electromagnetic fields, 3kHz to 300GHz, New York: IEEE, 2006.
- [3] ANSI/IEEE C95.1-1992, American National Standard safety levels with respect to human exposure to radio frequency electromagnetic fields, 3kHz to 300GHz, New York: IEEE, Sept. 1992.
- [4] ANSI/IEEE C95.3-2002, IEEE Recommended Practice for the Measurement of Potentially Hazardous Electromagnetic Fields - RF and Microwave, New York: IEEE, December 2002.
- [5] IEEE Standards Coordinating Committee 39 –Standards Coordinating Committee 34 – IEEE Std. 1528-2013, IEEE Recommended Practice for Determining the Peak Spatial-Average Specific Absorption Rate (SAR) in the Human Head from Wireless Communications Devices: Measurement Techniques.
- [6] NCRP, National Council on Radiation Protection and Measurements, Biological Effects and Exposure Criteria for RadioFrequency Electromagnetic Fields, NCRP Report No. 86, 1986. Reprinted Feb. 1995.
- [7] T. Schmid, O. Egger, N. Kuster, Automated E-field scanning system for dosimetric assessments, IEEE Transaction on Microwave Theory and Techniques, vol. 44, Jan. 1996, pp. 105-113.
- [8] K. Pokovic, T. Schmid, N. Kuster, Robust setup for precise calibration of E-field probes in tissue simulating liquids at mobile communications frequencies, ICECOM97, Oct. 1997, pp. 1 -124.
- [9] K. Pokovic, T. Schmid, and N. Kuster, E-field Probe with improved isotropy in brain simulating liquids, Proceedings of the ELMAR, Zadar, Croatia, June 23-25, 1996, pp. 172-175.
- [10] Schmid & Partner Engineering AG, Application Note: Data Storage and Evaluation, June 1998, p2.
- [11] V. Hombach, K. Meier, M. Burkhardt, E. Kuhn, N. Kuster, The Dependence of EM Energy Absorption upon Human Modeling at 900 MHz, IEEE Transaction on Microwave Theory and Techniques, vol. 44 no. 10, Oct. 1996, pp. 1865-1873.
- [12] N. Kuster and Q. Balzano, Energy absorption mechanism by biological bodies in the near field of dipole antennas above 300MHz, IEEE Transaction on Vehicular Technology, vol. 41, no. 1, Feb. 1992, pp. 17-23.
- [13] G. Hartsgrrove, A. Kraszewski, A. Surowiec, Simulated Biological Materials for Electromagnetic Radiation Absorption Studies, University of Ottawa, Bioelectromagnetics, Canada: 1987, pp. 29-36.
- [14] Q. Balzano, O. Garay, T. Manning Jr., Electromagnetic Energy Exposure of Simulated Users of Portable Cellular Telephones, IEEE Transactions on Vehicular Technology, vol. 44, no.3, Aug. 1995.
- [15] W. Gander, Computermathematik, Birkhaeuser, Basel, 1992.
- [16] W.H. Press, S.A. Teukolsky, W.T. Vetterling, and B.P. Flannery, Numerical Recipes in C, The Art of Scientific Computing, Second edition, Cambridge University Press, 1992.
- [17] N. Kuster, R. Kastle, T. Schmid, Dosimetric evaluation of mobile communications equipment with known precision, IEEE Transaction on Communications, vol. E80-B, no. 5, May 1997, pp. 645-652.
- [18] CENELEC CLC/SC111B, European Prestandard (prENV 50166-2), Human Exposure to Electromagnetic Fields High-frequency: 10kHz-300GHz, Jan. 1995.
- [19] Prof. Dr. Niels Kuster, ETH, Eidgenössische Technische Hochschule Zürich, Dosimetric Evaluation of the Cellular Phone.

FCC ID: C3K2085	SAR EVALUATION REPORT	Approved by: Technical Manager
Document S/N: 1M2311170118-01.C3K(R1)	DUT Type: Portable Computing Device	Page 57 of 58

REV 22.0
03/30/2022

- [20] IEC 62209-1, Measurement procedure for the assessment of specific absorption rate of human exposure to radio frequency fields from hand-held and body-mounted wireless communication devices - Part 1: Devices used next to the ear (Frequency range of 300 MHz to 6 GHz), July 2016.
- [21] Innovation, Science, Economic Development Canada RSS-102 Radio Frequency Exposure Compliance of Radiocommunication Apparatus (All Frequency Bands) Issue 5, March 2015.
- [22] Health Canada Safety Code 6 Limits of Human Exposure to Radio Frequency Electromagnetic Fields in the Frequency Range from 3 kHz – 300 GHz, 2015
- [23] FCC SAR Test Procedures for 2G-3G Devices, Mobile Hotspot and UMPC Devices KDB Publications 941225, D01-D07
- [24] SAR Measurement Guidance for IEEE 802.11 Transmitters, KDB Publication 248227 D01
- [25] FCC SAR Considerations for Handsets with Multiple Transmitters and Antennas, KDB Publications 648474 D03-D04
- [26] FCC SAR Evaluation Considerations for Laptop, Notebook, Netbook and Tablet Computers, FCC KDB Publication 616217 D04
- [27] FCC SAR Measurement and Reporting Requirements for 100MHz – 6 GHz, KDB Publications 865664 D01-D02
- [28] FCC General RF Exposure Guidance and SAR Procedures for Dongles, KDB Publication 447498, D01-D02
- [29] Anexo à Resolução No. 533, de 10 de Setembro de 2009.
- [30] IEC 62209-2, Human exposure to radio frequency fields from hand-held and body-mounted wireless communication devices - Human models, instrumentation, and procedures - Part 2: Procedure to determine the specific absorption rate (SAR) for wireless communication devices used in close proximity to the human body (frequency range of 30 MHz to 6 GHz), Mar. 2010.

FCC ID: C3K2085	SAR EVALUATION REPORT	Approved by: Technical Manager
Document S/N: 1M2311170118-01.C3K(R1)	DUT Type: Portable Computing Device	Page 58 of 58

REV 22.0
03/30/2022