



**Part 2: Qualcomm FastConnect WIFI TAS Time Varying Validation**

*For*  
**Portable Computing Device with WLAN and Bluetooth**

**FCC ID: C3K2036**  
**Model Name: 2036**

**Report Number: R14932101-S13**  
**Issue Date: 4/24/2024**

*Prepared for*  
**MICROSOFT CORP**  
**1 MICROSOFT WAY**  
**REDMOND, WA 98052-8300, U.S.**

*Prepared by*  
**UL LLC**  
**12 LABORATORY DR**  
**RTP, NC 27709, U.S.A.**  
**TEL: (919) 549-1400**

**Revision History**



Rev.	Date	Revisions	Revised By
V1	4/22/2024	Initial Issue	--
V2	4/24/2024	Updated tables in §5.7. Updated data in §6 and 7.	Richard Jankovics

## Table of Contents

<b>1.</b>	<b>Attestation of Test Results</b> .....	<b>5</b>
<b>2.</b>	<b>Facilities and Accreditation</b> .....	<b>6</b>
<b>3.</b>	<b>Introduction</b> .....	<b>7</b>
3.1.	Supported WLAN operations.....	7
3.2.	Configurable parameters.....	7
<b>4.</b>	<b>Compliance Assessment Methodology</b> .....	<b>9</b>
4.1.	Validation Strategy.....	9
4.1.1.	Time-Varying Test Sequence .....	9
4.1.2.	Change in antenna (applicable when the software supports SISO diversity operation).....	10
4.1.3.	Change in device state (DSI) (applicable when the device supports multiple DSI).....	10
4.1.4.	Change in WLAN band.....	10
4.1.5.	Simultaneous Transmission .....	10
4.2.	Conducted power measurement .....	11
4.3.	RF exposure measurement.....	12
<b>5.</b>	<b>EUT and Test Setup Information</b> .....	<b>13</b>
5.1.	Device Under Test (DUT) Information .....	13
5.1.1.	DUT Description.....	13
5.1.2.	Wireless Technologies .....	14
5.2.	DUT FastConnect WIFI TAS Configured Parameters .....	14
5.3.	Test Equipment .....	15
5.4.	Validation test setup.....	16
5.4.1.	Conductive test setup.....	16
5.4.2.	Point SAR test setup .....	18
5.5.	Conducted Power Measurement.....	19
5.5.1.	Test selection criteria.....	19
5.5.2.	Test selection for Time-Varying Test Sequence .....	19
5.5.3.	Test selection for Change in Antenna .....	19
5.5.4.	Test selection for Change in device state index (DSI).....	20
5.5.5.	Test selection for Change in WLAN band.....	20
5.5.6.	Test selection for Simultaneous Transmission.....	20
5.5.7.	Test Procedure .....	21
5.6.	pointSAR measurement test sequence .....	25
5.6.1.	Test selection criteria.....	25
5.6.2.	Test procedure.....	25
5.7.	DUT worst case 1gSAR and test mode selection.....	26
<b>6.</b>	<b>FCC Validation Test Result</b> .....	<b>28</b>
6.1.	Time-Varying Test Sequence.....	28
6.1.1.	Test parameters – 1 <sup>st</sup> Band.....	28
6.1.2.	Test plots and result – 1 <sup>st</sup> Band.....	28
6.1.3.	Test parameters – 2 <sup>nd</sup> Band .....	29
6.1.4.	Test plots and result – 2 <sup>nd</sup> Band .....	29
6.2.	Change in antenna.....	30
6.2.1.	Test parameters.....	30
6.2.2.	Test plots and result .....	30

- 6.3. Change in WLAN band .....31
  - 6.3.1. Test parameters.....31
  - 6.3.2. Test plots and result .....31
- 6.4. Simultaneous Transmissions .....32
  - 6.4.1. Test parameters.....32
  - 6.4.2. Test plots and result .....32
- 7. pointSAR Test.....33**
  - 7.1. Time-Varying Test Sequence.....33
    - 7.1.1. Test parameters – 1st Band.....33
    - 7.1.2. Test plots and result – 1<sup>st</sup> Band.....33
    - 7.1.3. Test parameters – 2<sup>nd</sup> Band .....34
    - 7.1.4. Test plots and result – 2<sup>nd</sup> Band .....34
- 8. Conclusions.....35**
- Appendices .....36**
  - A DASYS8 System Validation .....36
    - A.1 SAR System Verification and Validation .....36
  - B DUT TAS BDF configuration .....37
  - C DASYS8 System Verification Plots.....39
  - D SPEAG Certificates of cDASY6 SAR Probe, DAE, Dipole .....39
  - E Test Setup Photos .....39

# 1. Attestation of Test Results

Applicant Name	MICROSOFT CORP		
FCC ID	C3K2036		
Model Name	2036		
Reference SAR Report	R14932101-S3 and R14932101-S4		
Exposure Category	SAR Limits (W/Kg)		PD Limits (W/m <sup>2</sup> )
	Peak Spatial Average (1-g of tissue)	Extremities (hands, wrists, ankles, etc.) (10-g of tissue)	
General Population (Uncontrolled Exposure)	1.6	4	10
Date Tested	4/1/2024 to 4/18/2024		
<p>UL LLC tested the above equipment in accordance with the requirements set forth in the above standards. The test results show that the equipment tested is capable of demonstrating compliance with the requirements as documented in this report.</p> <p>This report contains data provided by the customer which can impact the validity of results. UL LLC is only responsible for the validity of results after the integration of the data provided by the customer.</p> <p>The results documented in this report apply only to the tested sample, under the conditions and modes of operation as described herein. It is the manufacturer's responsibility to assure that additional production units of this model are manufactured with identical electrical and mechanical components. All samples tested were in good operating condition throughout the entire test program. Measurement Uncertainties are published for informational purposes only and were not taken into account unless noted otherwise.</p> <p>This document may not be altered or revised in any way unless done so by UL LLC and all revisions are duly noted in the revisions section. Any alteration of this document not carried out by UL LLC will constitute fraud and shall nullify the document. This report must not be used by the client to claim product certification, approval, or endorsement by A2LA, NIST, or any agency of the U.S. Government, or any agency of the U.S. government.</p>			
Approved & Released By:	Prepared By:		
			
Dave Weaver Senior Staff Engineer UL LLC	Richard Jankovics Staff Engineer UL LLC		

## 2. Facilities and Accreditation

UL LLC is accredited by A2LA, cert. # 0751.06 for all testing performed within the scope of this report. Testing was performed at the locations noted below.

The test sites and measurement facilities used to collect data are located at 2800 Perimeter Park Dr, Morrisville, NC, USA.

- SAR Lab 2A
- SAR Lab 2B

	Address	ISED CABID	ISED Company Number	FCC Registration
<input type="checkbox"/>	Building: 12 Laboratory Dr RTP, NC 27709, U.S.A	US0067	2180C	825374
<input checked="" type="checkbox"/>	Building: 2800 Perimeter Park Dr. Suite B Morrisville, NC 27560, U.S.A	US0067	27265	825374

### 3. Introduction

The equipment under test (EUT) contains Qualcomm FastConnect WLAN adapter supporting 2GHz, 5GHz, and 6GHz WLAN. In general, regulatory RF exposure limits are defined with respect to time-averaged RF exposure. Qualcomm FastConnect WIFI TAS algorithm performs transmit power control to ensure at all times the wireless device is in compliance with the configured limit of RF exposure averaged over a defined time window denoted as TSAR for SAR and PD

Note: For FCC, Wi-Fi 6E operates in the 6GHz ~ 7GHz band. The Interim RF Exposure Test Procedures for U-NII 6-7GHz Portable Devices also requires RF exposure assessment with SAR and incident PD (total) using mmW near-field probe and total-field/power-density reconstruction method. TAS validation performed in this report was done with SAR procedures consistent with Qualcomm's FastConnect documentation.

The FastConnect WIFI TAS supports maximum time-averaging windows (denoted as TSAR) as defined by the FCC that a 30 second time-averaging window is used by FastConnect WIFI TAS for WLAN operation in 2.4GHz, 5GHz, and 6GHz WLAN bands.

FastConnect WIFI TAS manages the instantaneous transmit power to maintain the time-averaged power and associated RF exposure is below the regulatory compliance limit.

- If the time-averaged transmit power approaches the SAR compliance power, then the instantaneous transmit power is limited to ensure the time-averaged transmit power does not exceed the SAR compliance power in any TSAR time window (i.e., the time-averaged RF exposure complies with the FCC or ICNIRP RF exposure limit in any time window).
- The wireless device can instantaneously transmit at high transmit powers for a short time durations before limiting the power to maintain time-averaged SAR compliance.

#### 3.1. Supported WLAN operations

- IEEE 802.11 - Operation in 2GHz, 5GHz, and 6GHz U-NII frequencies.
- SISO - Operation using a single antenna. The transmit chain may switch during operation. While using a single antenna, a design may support transmitting WLAN packets in 2GHz, 5GHz, or 6GHz channels.

Note: SISO operation depends on implementation in software. SISO mode may not be supported when software enables cyclic delay diversity (CDD). In this case WLAN always transmits in MIMO mode.

- MIMO - Operation using two antennas with one or more spatial streams.
- Dual band simultaneous (DBS) and/or High Band simultaneous (HBS) - Packets are transmitted in separate frequencies at the same time. A device may operate in DBS using MIMO or SISO.

Note: DBS operation support depends on implementation in software.

#### 3.2. Configurable parameters

This section defines the key parameters required for FastConnect WIFI TAS Validation. The following inputs are key parameters required for functionality of the FastConnect WIFI TAS feature.

Note: The OEM must configure these parameters in the board data file (BDF).

- Time-Averaged Exposure Mode (FCC) or Peak exposure mode, configurable for a given region/country: When enabled in Peak Exposure mode, FastConnect WIFI TAS limits instantaneous Tx power not to exceed  $P_{lim}$  in both simultaneous and single antenna case.
- $P_{lim}$  per WLAN band/ant/DSI/regulatory limit (FCC or ICNIRP limit). Either FCC or ICNIRP limits can be chosen for a given region/country.
- Antenna group (AG) table: Optional feature to group transmit antennas such that the antennas in each group have RF exposure that is mutually exclusive (either have sum of SAR less than regulatory limit or meet SPLSR criteria) with antennas belonging to a different group.
- Reserve margin (in dB).

Dynamic inputs:

- Country of operation (location-based awareness).
- Device state index (DSI).

Non-configurable parameters (fixed entries):

- $P_{max}$  values per each WLAN operating state.

### **$P_{lim}$**

$P_{lim}$  (in dBm) is the power corresponding to the  $RFexp_{target}$  for FastConnect WLAN. In other words,  $P_{lim}$  is the maximum time-average transmit power setting for FastConnect WIFI TAS, at which this radio configuration (i.e., antenna, band and DSI state) reaches the  $RFexp_{target}$ . The Fast Connect WIFI TAS algorithm uses  $P_{lim}$  to and the real time transmit power to ensure the real time-averaged SAR is below the  $RFexp_{target}$  in real time and thus ensure device RF Exposure compliance.

### **$P_{max}$**

$P_{max}$  for FastConnect WLAN represents the maximum WLAN transmit power from other power setting in board data file. The Pmax value could be identified by compare the target power (Rate- to-Power) and compliance transmit (CTL) and other power limit.

$$P_{max} = \min \{CTL, \text{Regdomain}, TPE/TPC, \text{Rate-to-Power}\}$$

### **Reserve margin**

FastConnect WIFI TAS allows minimum reserve power  $P_{reserve}$  ( $= P_{lim} - \text{reserve margin}$ ) for WLAN radio to transmit, which can be used to maintain the link. The reserve margin is a global parameter, meaning it applies to all the radio configurations. When the reserve margin is set to zero dB, the FastConnect WIFI TAS effectively allows minimum transmit power  $P_{reserve} = P_{lim}$  at all times, in other words, the EUT transmits continuously at  $P_{lim}$ .

The value is chosen by the OEM and stored in the board data file (BDF). It is in 0.1 dB increments. A single value is applied to all bands and modes.



## 4. Compliance Assessment Methodology

To demonstrate the compliance of FastConnect WIFI TAS. Three parts of assessment should be completed, and Static SAR compliance test report and Time Varying Validation test report should be created for certification approval:

- Qualcomm\_FastConnect\_WIFI\_TAS\_Characterization – OEM must perform SAR/PD characterization at the device level to determine Plim for RF exposure test.
- Qualcomm\_FastConnect\_WIFI\_TAS\_Static\_SAR\_Compliance – OEM must perform Static SAR testing for all supported WLAN band/antenna/DSI. The maximum time average Tx power levels are determined from the SAR characterization and test in static transmission (e.g., FTM mode) to validate and demonstrate RF exposure meets the design target.
- Qualcomm\_FastConnect\_WIFI\_TAS\_Time\_Varying\_Validation – Test with pre-defined test sequence for each validation scenario to demonstrate RF Exposure compliance is achieved by FastConnect WIFI TAS. Qualcomm releases a test tool that can be used for the validation scenarios and also provides installation and test guides to OEMs manufactures. OEM manufactures should determine the appropriate test mode/channel and complete the TAS Time Varying Validation Report and submit in FCC and ISED certification submissions.

### 4.1. Validation Strategy

The following scenarios cover validation tests to prove FastConnect WIFI TAS accounts for the history of transmission power accuracy at all times including before, during, and after transition in each scenario.

Since RF exposure is proportional to the Tx power for a SAR wireless device, time-averaging algorithm validation can be effectively performed through conducted power measurements. Also, to have high confidence in validation, but also be practical, the strategy for the Time-Varying Test Sequence includes both conducted power measurement and RF exposure measurement.

In addition, since FastConnect WIFI TAS feature operates at the same averaged algorithm to all WLAN bands (2.4GHz, 5GHz, and 6GHz), 2.4 GHz and 5.8 GHz are selected to demonstrate FastConnect WIFI TAS functions correctly in this validation test report. The test selection criteria is described in Section 5.5.1.

#### 4.1.1. Time-Varying Test Sequence

This test proves the FastConnect WIFI TAS accounts for Tx power variations in time accurately.

- Two bands to be selected for this test as possible and one antenna/DSI from each band should be selected and tested to prove the FastConnect WIFI TAS feature accounts for Tx power variations in time accurately using the conducted power measurement approach. This test sequence is also used for pointSAR measurement to demonstrate FastConnect WIFI TAS feature in radiated test setup.

In addition, this test is performed to capture the maximum time-averaged results in at least two time-averaging windows duration.

#### **4.1.2. Change in antenna (applicable when the software supports SISO diversity operation)**

This test is to prove that FastConnect functions correctly during transitions in Plim (at different antennas) within the same WLAN band and same Antenna Group. If device supports SISO and transmission diversity between an Antenna to another antenna, then this test is applicable. If WLAN MIMO CDD is implemented, then device is always under MIMO transmission, in this case, this test is NOT applicable.

- One band/DSI and two antenna ports should be selected for conducted power measurement.

#### **4.1.3. Change in device state (DSI) (applicable when the device supports multiple DSI)**

This is to prove that FastConnect WIFI TAS performs power enforcements to maintain compliance during transitions in the device state.

- One antenna/band and two DSIs should be selected for conducted measurement.

#### **4.1.4. Change in WLAN band**

This is to prove that the FastConnect WIFI TAS functions correctly during transitions in radios and bands.

- One antenna/DSI and two bands should be selected for conducted power measurement.

#### **4.1.5. Simultaneous Transmission**

This is to prove that the FastConnect WIFI TAS functions in transition from 1st standalone WLAN radio to simultaneous WLAN radios and back to 2nd standalone WLAN radio.

- Select two bands per simultaneous transmissions feature implemented to FastConnect WIFI TAS device for this test. One antenna/DSI and two bands should be selected for conducted power measurement.

## 4.2. Conducted power measurement

This section provides general procedures to perform conducted power measurement under dynamic transmission scenarios and apply to all test scenarios described in section 4.1.

1. Measure conducted power.
2. Convert it into RF exposure and divide by respective limits to get normalized exposure use equation as described in this section.
3. Perform time-averaging over predefined time windows.
4. Demonstrate that the total normalized time-averaged RF exposure is <1 for all transmission scenarios.

- For frequency below 6GHz or if regulator requires SAR for WLAN 6GHz band.

$$1g \text{ or } 10g \text{ SAR}(t) = \frac{\text{conducted Tx power}(t)}{\text{conducted Tx power } P_{lim}} * 1g \text{ or } 10g \text{ SAR } P_{lim} \text{ (1a)}$$

$$\frac{\frac{1}{T_{SAR}} \int_{t-T_{SAR}}^t 1g \text{ or } 10g \text{ SAR}(t) dt}{FCC \text{ SAR limit}} \leq 1 \frac{W}{kg} \text{ (1b)}$$

- For frequency greater than 6GHz if regulator requires APD. (Applicable for ISED)

$$4 \text{ cm}^2 \text{ PD}(t) = \frac{\text{Conducted Tx power}(t)}{\text{Conducted Tx power } P_{lim}} * 4 \text{ cm}^2 \text{ PD } P_{lim} \text{ (1c)}$$

$$\frac{\frac{1}{T_{PD}} \int_{t-T_{PD}}^t 4 \text{ cm}^2 \text{ PD}(t) dt}{APD 4 \text{ cm}^2 \text{ PD limit}} \leq 1 \frac{W}{kg} \text{ (1d)}$$

where, *conducted Tx power(t)*, *conducted Tx power P<sub>lim</sub>* and *1g or 10gSAR P<sub>lim</sub>* correspond to the measured instantaneous conducted Tx power and conducted Tx power at *P<sub>lim</sub>* of DUT, and *1g or 10gSAR P<sub>lim</sub>* values at *P<sub>lim</sub>* for the worst-case radio configuration within the tested band/Antenna/DSI. Similarly, *4cm<sup>2</sup> PD\_ P<sub>lim</sub>* correspond to the APD values at *P<sub>lim</sub>* for the worst-case radio configuration within the tested band (greater than 6GHz)/Antenna/DSI.

The equations (1a) & (1b) are applicable if SAR is required by regulator to address RF exposure for the band greater than 6GHz.

Note: The ratio circled in red square is obtained from the measurement on the radio configuration is selected for validation test while the *1g or 10gSAR P<sub>lim</sub>* and *4cm<sup>2</sup> PD P<sub>lim</sub>* must be from the SAR value in the worst-case radio configuration within the tested band/Antenna/DSI in static SAR report and scale to the *conducted Tx power P<sub>lim</sub>* level is measured from DUT used in validation test.

### 4.3. RF exposure measurement

This section provides the general procedure to demonstrate the FastConnect WIFI TAS comply SAR limit in radiated test setup. Through pointSAR measurement for only test scenario Time-Varying Test Sequence (section 4.1.1) to add confidence in the FastConnect WIFI TAS feature validation, while avoiding the complexity in SAR measurement.

1. Choose worst case EUT orientation of SAR measurement per according to Static SAR test report and perform pointSAR measurement use cDASY6
2. Measure instantaneous SAR versus time and demonstrate total normalized time-averaged RF exposure is <1.0 at all times.

- For frequency below 6GHz or if regulator requires SAR for WLAN 6GHz band.

$$1g \text{ or } 10g \text{ SAR}(t) = \frac{\text{pointSAR}(t)}{\text{pointSAR } P_{lim}} * 1g \text{ or } 10g \text{ SAR } P_{lim} \text{ (2a)}$$

$$\frac{\frac{1}{T_{SAR}} \int_{t-T_{SAR}}^t 1g \text{ or } 10g \text{ SAR}(t) dt}{FCC \text{ SAR limit}} \leq 1 \frac{W}{kg} \text{ (2b)}$$

- For frequency greater than 6GHz if regulator requires APD. (Applicable for ISED)

$$4 \text{ cm}^2 \text{ PD}(t) = \frac{\text{pointSAR}(t)}{\text{pointSAR } P_{lim}} * 4 \text{ cm}^2 \text{ PD } P_{lim} \text{ (2c)}$$

$$\frac{\frac{1}{T_{SAR}} \int_{t-T_{SAR}}^t 4 \text{ cm}^2 \text{ PD}(t) dt}{APD 4 \text{ cm}^2 \text{ PD limit}} \leq 1 \frac{W}{kg} \text{ (2d)}$$

where,  $\text{pointSAR}(t)$ ,  $\text{pointSAR } P_{lim}$ , and  $1g \text{ or } 10g \text{ SAR } P_{lim}$  correspond to the measured instantaneous point SAR and point SAR at  $P_{lim}$  of DUT, and  $1g \text{ or } 10g \text{ SAR}$  values at  $P_{lim}$  for the worst-case radio configuration within the tested band/Antenna/DSI. Similarly,  $4 \text{ cm}^2 \text{ PD } P_{lim}$  is the APD values at  $P_{lim}$  for the worst-case radio configuration within the tested band (greater than 6GHz)/Antenna/DSI.

The equations (2a) & (2b) are applicable if SAR is required by regulator to address RF exposure for the band greater than 6GHz.

Note: The ratio circled in red square is obtained from the measurement on the radio configuration is selected for validation test while the  $1g \text{ or } 10g \text{ SAR } P_{lim}$  and  $4 \text{ cm}^2 \text{ PD } P_{lim}$  must be from the SAR value in the worst-case radio configuration within the tested band/Antenna/DSI in static SAR report and scale to the *conducted Tx power*  $P_{lim}$  level is measured from DUT used in validation test.

## 5. EUT and Test Setup Information

### 5.1. Device Under Test (DUT) Information

#### 5.1.1. DUT Description

Device Dimension	Refer to R14932101-S3 and R14932101-S4 Appendix A for device description and dimensions.							
Battery Options	The rechargeable battery is not user accessible.							
Wi-Fi Direct	Wi-Fi Direct enabled devices transfer data directly between each other <input checked="" type="checkbox"/> Wi-Fi Direct (Wi-Fi 2.4 GHz) <input checked="" type="checkbox"/> Wi-Fi Direct (Wi-Fi 5 GHz)							
Test sample information	<table border="1"> <thead> <tr> <th>S/N</th> <th>Notes</th> </tr> </thead> <tbody> <tr> <td>0F3BV3923383HH</td> <td>2.4GHz/6GHz Conducted/Radiated</td> </tr> <tr> <td>0F3BV4923383HH</td> <td>5GHz/BT Conducted/Radiated</td> </tr> </tbody> </table>	S/N	Notes	0F3BV3923383HH	2.4GHz/6GHz Conducted/Radiated	0F3BV4923383HH	5GHz/BT Conducted/Radiated	
S/N	Notes							
0F3BV3923383HH	2.4GHz/6GHz Conducted/Radiated							
0F3BV4923383HH	5GHz/BT Conducted/Radiated							
Hardware Version	EV3							
Software Version	1.0.3808.9500							

### 5.1.2. Wireless Technologies

Wireless technologies	Frequency bands	Operating mode	TX Frequencies
Wi-Fi	2.4 GHz	802.11b 802.11g 802.11n (HT20) 802.11n (HT40) 802.11ax (HE20) 802.11ax (HE40) 802.11be (EHT20) 802.11be (EHT40)	2400 MHz – 2483.5 MHz
	5 GHz	802.11a 802.11n (HT20) 802.11n (HT40) 802.11ac (VHT80) 802.11ac (VHT160) 802.11ax (HE20) 802.11ax (HE40) 802.11ax (HE80) 802.11ax (HE160) 802.11be (EHT20) 802.11be (EHT40) 802.11be (EHT80) 802.11be (EHT160)	U-NII 1: 5150 MHz – 5250 MHz U-NII 2a: 5250 MHz – 5350 MHz U-NII 2c: 5470 MHz – 5725 MHz U-NII 3: 5725 MHz – 5850 MHz U-NII 4: 5850 MHz – 5925 MHz (US only)
	Does this device support bands 5.60 ~ 5.65 GHz? <input checked="" type="checkbox"/> Yes <input type="checkbox"/> No		
	Does this device support Band gap channel(s)? <input checked="" type="checkbox"/> Yes <input type="checkbox"/> No		
	6GHz	802.11a 802.11ax (HE20) 802.11ax (HE40) 802.11ax (HE80) 802.11ax (HE160) 802.11be (EHT20) 802.11be (EHT40) 802.11be (EHT80) 802.11be (EHT160) 802.11be (EHT320)	U-NII 5: 5925 MHz – 6425 MHz U-NII 6: 6425 MHz – 6525 MHz U-NII 7: 6525 MHz – 6875 MHz U-NII 8: 6875 MHz – 7125 MHz
Bluetooth	2.4 GHz	BR, EDR, and LE	2400 MHz – 2483.5 MHz

### 5.2. DUT FastConnect WIFI TAS Configured Parameters

The DUT has FastConnect WIFI TAS parameters configured in Board Data File for test in Appendix B of this test report.

### 5.3. Test Equipment

The measuring equipment used to perform the tests documented in this report has been calibrated in accordance with the manufacturers' recommendations, and is traceable to recognized national standards.

#### Dielectric Property Measurements

Name of Equipment	Manufacturer	Type/Model	Serial No.	Cal. Due Date
Network Analyzer	Keysight	E5063A	MY54100681	8/4/2024
Dielectric Probe	SPEAG	DAKS-3.5	1051	10/25/2024
Shorting Block	SPEAG	DAK-3.5 Short	SM DAK 200 DA	10/25/2024
Thermometer	Fisher Scientific	15-078-181	1817705017	3/30/2025

#### System Check

Name of Equipment	Manufacturer	Type/Model	Serial No.	Cal. Due Date
RF Power Source	Speag	PowerSource1	4278	6/13/2024

#### Lab Equipment

Name of Equipment	Manufacturer	Type/Model	Serial No.	Cal. Due Date
E-Field Probe	SPEAG	EX3DV4	7709	11/30/2024
E-Field Probe	SPEAG	EX3DV4	7711	3/15/2025
Data Acquisition Electronics	SPEAG	DAE4	1715	2/12/2025
Data Acquisition Electronics	SPEAG	DAE4	1716	3/13/2025
System Validation Dipole	SPEAG	D2450V2	963	10/20/2024
System Validation Dipole	SPEAG	D5GHzV2	1213	10/17/2024
Environmental Indicator	Control Company	06-662-4	240072452	1/24/2026

#### Other

Name of Equipment	Manufacturer	Type/Model	Serial No.	Cal. Due Date
3-Path Diode Power Sensor	Rohde & Schwarz	NRP8S	112236	6/2/2024
3-Path Diode Power Sensor	Rohde & Schwarz	NRP8S	112237	6/2/2024
Base Station Simulator	R & S	CMW 500	170194	6/6/2024

### 5.4. Validation test setup

#### 5.4.1. Conductive test setup

This section provides the setup diagram that is performed in this test report. Depends on the test mode selection. The test setup instruction and setup diagrams are provided in Qualcomm® FastConnect™ User Guide (80-39282-2) Qualcomm document.

#### SISO (Time-Varying Test Sequence, Change in DSI) – Validation test setup

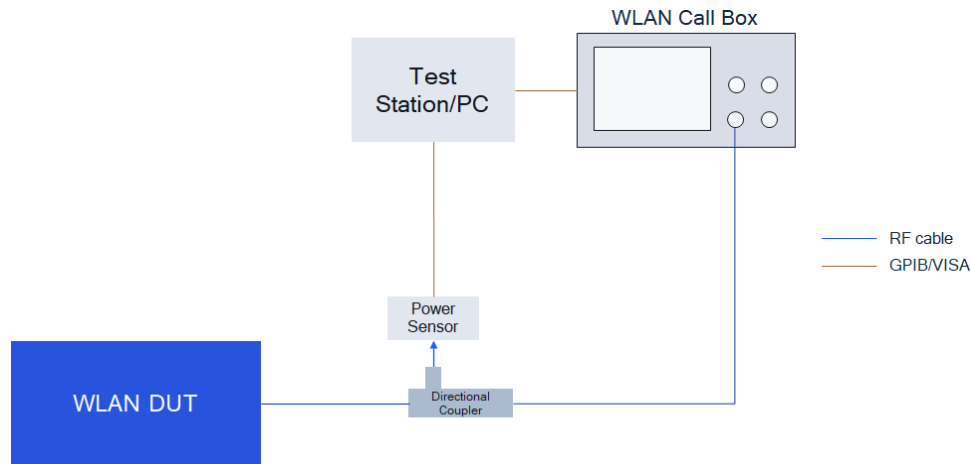

#### SISO (Change in Antenna) – Validation test setup

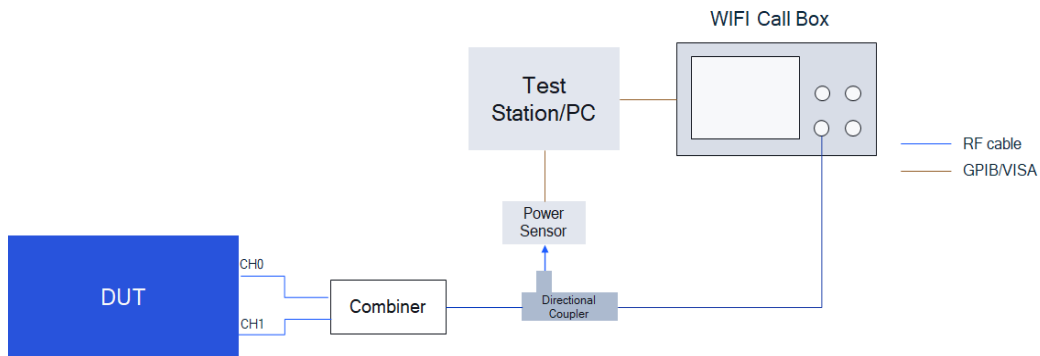



**MIMO (Change in WLAN band) – Validation test setup**

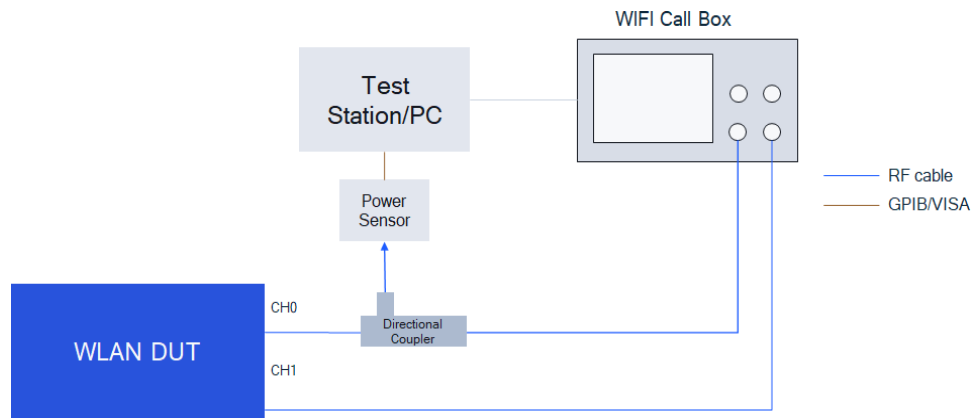

**SISO (Simultaneous Transmission) – Validation test setup**

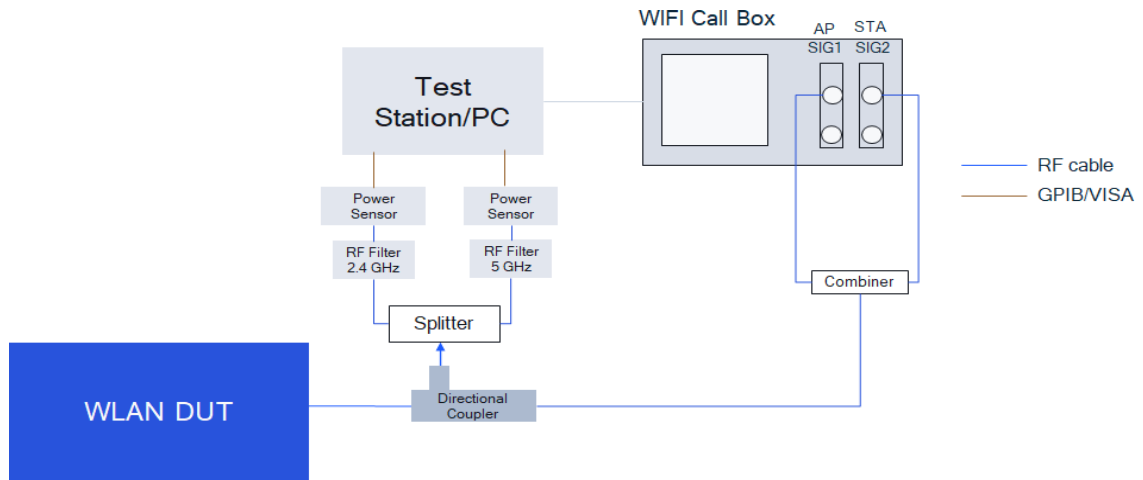

### 5.4.2. Point SAR test setup

To provide higher confidence in the validation test, the FastConnect WIFI TAS Validation test plan includes radiated measurements.

In this test, the measurement setup is similar to the normal SAR measurements:

- The EUT is positioned against the flat section of the SAM Twin phantom and wirelessly connected with the callbox.
- The EUT is placed in worst-case position as determined from the static SAR test report.

The same test script from Time-Varying Test Sequence is also used here for SAR measurements.

### DASY8 System Measurement Setup

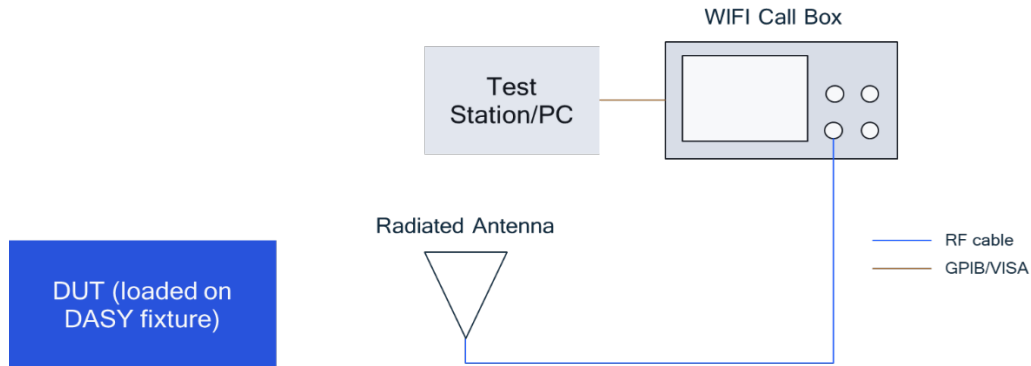

## 5.5. Conducted Power Measurement

### 5.5.1. Test selection criteria

The conducted power measurement method is used for all validation test scenarios. These tests demonstrate the power enforcement by FastConnect WIFI TAS where  $P_{lim}$  could vary before and after transition.

### 5.5.2. Test selection for Time-Varying Test Sequence

Select one representative test channel from all the available radio configurations (band/ant(s)/DSI) that has  $P_{max} > P_{lim} + \text{device uncertainty}$ .

- If  $P_{max} < P_{lim} + \text{device uncertainty}$  for all radio configurations, then select radio configuration with largest ( $P_{max}$  dBm –  $P_{lim}$  dBm) value.
- If  $P_{max} > P_{lim} + \text{device uncertainty}$  for more than one radio configuration. Then, order of preference is given by:
  - If multiple radio configurations (band/ant(s)/DSI) meet this criteria, then SISO is preferred over MIMO due to simplified test setup.
  - After determining SISO vs. MIMO configuration, then select the configuration that has largest ( $P_{max}$  dBm –  $P_{lim}$  dBm) dB delta.
- Test to be performed at two bands for Time-Varying Test sequence test. If only one band within a configuration has  $P_{max} > P_{lim}$  and  $P_{lim} > P_{max}$  in all other configurations, then only one band needs to be tested.
- Test is not required if  $P_{lim} > P_{max}$  for all radio configurations.

NOTE: The same selection criteria are applicable for both conducted & radiated tests.

### 5.5.3. Test selection for Change in Antenna

This test scenario does not apply if SISO mode diversity is not supported. (e.g., CDD is enabled and always use MIMO). The criteria to select test configuration for Change in Antenna measurement is:

- The antennas selected for this test should be in the same antenna group.
- Whenever possible and supported by the EUT, first select antenna switch configuration within the same band/DSI (i.e., same band and DSI combination), and having different  $P_{lim}$ , and having both  $P_{max} > P_{lim} + \text{device uncertainty}$  where possible. Otherwise, select at least one antenna having  $P_{max} > P_{lim} + \text{device uncertainty}$ .
  - If multiple radio configurations (band/DSI) meet  $P_{max} > P_{lim} + \text{device uncertainty}$ , then select the configuration that has largest ( $P_{max}$  dBm –  $P_{lim}$  dBm) dB delta.
  - If  $P_{max} < P_{lim} + \text{device uncertainty}$  for all radio configurations, then select radio configuration with largest ( $P_{max}$  dBm –  $P_{lim}$  dBm) value.
- If the EUT does not support antenna switch within the same band, but has multiple transmitting antennas to support different frequency bands, then antenna switch test should be performed in combination with Change in WLAN band test scenario.
- Test for Change in Antenna is not required if all  $P_{lim} > P_{max}$  for all radio configurations.

#### 5.5.4. Test selection for Change in device state index (DSI)

This test scenario does not apply if multiple DSIs is not supported in the device. The criteria to select test configuration for Change in DSI measurement is:

- Select a band/antenna having the  $P_{max} > P_{lim} + \text{device uncertainty}$  within any DSI, and for the same band/antenna(s) having a different  $P_{lim}$  in any other DSI. Both the selected DSIs should have  $P_{max} > P_{lim} + \text{device uncertainty}$  where possible. Otherwise, select at least one DSI having  $P_{max} > P_{lim} + \text{device uncertainty}$ .
- If  $P_{max} < P_{lim} + \text{device uncertainty}$  for all band/antenna(s), then select radio configuration with largest ( $P_{max}$  dBm –  $P_{lim}$  dBm) value.
- If  $P_{max} > P_{lim} + \text{device uncertainty}$  for more than one radio configuration, then order of preference is given by:
  - If multiple radio configurations (band/ant(s)/DSI) meet this criteria and if device support SISO. Then SISO is preferred over MIMO due to simplified test setup.
  - After determining SISO vs. MIMO configuration, then select the configuration that has largest ( $P_{max}$  dBm –  $P_{lim}$  dBm) dB delta.
- Test for Change in DSI is not required if all  $P_{lim} > P_{max}$  for all radio configurations.

#### 5.5.5. Test selection for Change in WLAN band

The criteria to select test configuration for Change in WLAN band measurement is:

- First select both bands in a DSI having  $P_{max} > P_{lim} + \text{device uncertainty}$  where possible. Otherwise, select at least one band having  $P_{max} > P_{lim} + \text{device uncertainty}$ .
- If  $P_{max} < P_{lim} + \text{device uncertainty}$  for all radio configurations, then select radio configuration with largest ( $P_{max}$  dBm –  $P_{lim}$  dBm) value.
- If  $P_{max} > P_{lim} + \text{device uncertainty}$  for more than one radio configuration. Then, order of preference is given by:
  - If multiple radio configurations (band/ant(s)/DSI) meet this criteria and if device support SISO. Then SISO is preferred over MIMO due to simplified test setup.
  - After determining SISO vs. MIMO configuration, then select the configuration that has largest ( $P_{max}$  dBm –  $P_{lim}$  dBm) dB delta.
- The antennas corresponding to the selected bands should be in the same antenna group.
- Test for Change in WLAN band is not required if all  $P_{lim} > P_{max}$  for all radio configurations.

#### 5.5.6. Test selection for Simultaneous Transmission

This test scenario does not apply if simultaneous transmission within WLAN bands is not supported in the device. The criteria to select test configuration for Simultaneous Transmission measurement is:

- The bands must be selected from supported Simultaneous Transmission configuration. (e.g., WLAN DBS and/or HBS)
- First select both bands in a DSI having  $P_{max} > P_{lim} + \text{device uncertainty}$  where possible. Otherwise, select at least one band having  $P_{max} > P_{lim} + \text{device uncertainty}$ .
- If  $P_{max} < P_{lim} + \text{device uncertainty}$  for all radio configurations, then select radio configuration with largest ( $P_{max}$  dBm –  $P_{lim}$  dBm) value.
- If  $P_{max} > P_{lim} + \text{device uncertainty}$  for more than one radio configuration. Then, order of preference is given by:
  - If multiple radio configurations (band/ant(s)/DSI) meet this criteria and if device support SISO. Then SISO is preferred over MIMO due to simplified test setup.
  - After determining SISO vs. MIMO configuration, then select the

configuration that has largest ( $P_{max}$  dBm –  $P_{lim}$  dBm) dB delta.

- The antennas corresponding to the selected bands should be in the same antenna group.
- Even if a device has  $P_{lim} > P_{max}$  for all radio configurations, then “Simultaneous Transmission” test scenario should still be performed for validation of FastConnect WIFI TAS device.

Note: For all above test selection. Pmax = min (CTL, Regdomain, TPE/TPC, Rate-to- Power) of the selected channel//rate/band. Since FastConnect WIFI TAS supports the same Plim for all modulations in same antenna/band/DSI, the selection of test modulation/channel chooses the highest Pmax modulation.

### 5.5.7. Test Procedure

1. Measure  $P_{lim}$  for modes at validation antenna ports, bands and/or DSIs with **FastConnect WIFI TAS Peak Exposure Mode** enabled with callbox to establish the chosen mode for test. Denote this measured power value as *Conducted\_Tx\_power\_P<sub>lim</sub>*.

NOTE: The measurement of Peak Exposure Mode should be performed with 70% or higher WLAN duty cycle (for example, using iPerf to generate UL traffic).

2. Set EUT to the intended **FastConnect WIFI TAS mode**.
3. Establish radio link with the callbox in the selected band.

NOTE: For the purpose of collecting repeatable time averaged power data, it is recommended to include a section of 30s at the beginning of every test with the device WLAN connection disconnected or turned off or transmitting at a very low duty cycle.

4. Request EUT to transmit in following **Transition sequence**:
  - a. **Time-Varying Test Sequence** – Request EUT to transmit maximum power for at least 30s with 100% duty cycle and 50% duty cycle for 60s to determine time-averaged 1gSAR versus time.

Time duration (seconds)	Duty Cycle (%)
30	100%
60	50%

1. **Change in antenna** – EUT operates at Antenna 1 (e.g., Main antenna port) and requests to transmit at maximum power for at least 60s. Then switch to operation on Antenna 2 (e.g., Aux antenna port), followed by at least 120s of observation.
2. **Change in device state (DSI)** – EUT operates at DSI 1 and requests to transmit at maximum power for at least 60s. Then switch to operation on DSI 2, followed by at least 120s of observation (observation period includes transition time).
3. **Change in WLAN band** – EUT operates at Band 1 and requests to transmit at maximum power for at least 60s. Then it switches to Band 2 using the same antenna port and observes another 120s (observation period includes transition time).
4. **Simultaneous Transmissions**: First establish WLAN connection with the callbox in radio2 configuration and request radio2 configuration to transmit at maximum duty cycle for at least 120s to test predominantly radio2 SAR exposure scenario. Then add radio1 configuration to the existing radio2 configuration call, and request both radio1 and radio2 to transmit at maximum duty cycle to test radio1 and radio2 SAR exposure scenario for at least 120s. Then drop (or request low duty

cycle) for radio2 configuration to test predominantly radio1 SAR exposure scenario for another at least 120s. Record the conducted Tx powers for both radio1 and radio2 configurations for the entire duration of this test.

Note: radio1 and radio2 should operate at different band.

5. Measure and record Tx power versus time.

- a. Once the measurement is done, extract instantaneous Tx power versus time, and convert the conducted Tx power into 1g\_or\_10g SAR value, see Eq. (1a), using Step 1 result.
- b. Then perform 30s moving average to determine time-averaged 1g\_or\_10gSAR versus time as illustrated below.

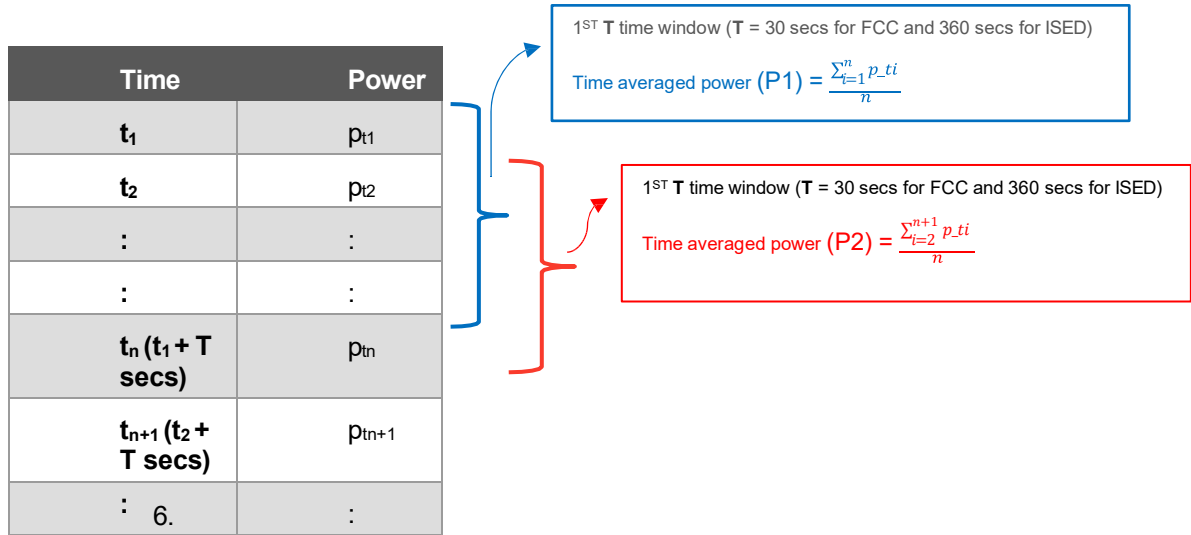

The following normalization is used to convert 1g\_or\_10gSAR exposure using Equation (1a) and (1c) in section 4.2 to validate the continuity of RF exposure limits during the transition. The procedures from step 1 and step 2 in this section should be completed for each configuration under test and use below equations to validate the RF exposure during the transition. if tested with both radio configurations below 6GHz:

$$1g\_or\_10gSAR_1(t) = \frac{Conducted\_Tx\_power\_1(t)}{Conducted\_Tx\_power\_Plim\_1} * 1g\_or\_10gSAR\_Plim\_1 \quad (4a)$$

$$1g\_or\_10gSAR_2(t) = \frac{Conducted\_Tx\_power\_2(t)}{Conducted\_Tx\_power\_Plim\_2} * 1g\_or\_10gSAR\_Plim\_2 \quad (4b)$$

$$\frac{\frac{1}{TSAR} \left[ \int_{t-TSAR}^{t1} 1g\_or\_10gSAR_1(t) dt + \int_{t-TSAR}^t 1g\_or\_10gSAR_2(t) dt \right]}{FCC \text{ or ICNIRP SAR limit}} \leq 1 \quad (4c)$$

where, conducted\_Tx\_power\_1(t), conducted\_Tx\_power\_Plim\_1, and 1g\_or\_10gSAR\_Plim\_1 correspond to the instantaneous Tx power, conducted Tx power at P<sub>lim\_1</sub> of DUT, and compliance 1g\_or\_10gSAR values of Antenna 1 (or Band 1 or DS1) at P<sub>lim\_1</sub>;

$conducted\_Tx\_power\_2(t)$ ,  $conducted\_Tx\_power\_Plim\_2$ , and  $1g\_or\_10gSAR\_Plim\_2$  correspond to the instantaneous Tx power, conducted Tx power at  $P_{lim\_2}$  of DUT, and compliance  $1g\_or\_10gSAR$  values of Antenna 2 (or Band 2 or DSI2) at  $P_{lim\_2}$ .

Transition from the Antenna 1 (or Band 1 or DSI1) to the Antenna 2 (or Band 2 or DSI2) happens at time-instant ' $t_1$ '.

- if tested with radio configuration: 2.4/5GHz WLAN assessed using SAR + 6GHz WLAN band assessed using APD (e.g., applicable for ISED):

$$1g\_or\_10gSAR_1(t) = \frac{Conducted\_Tx\_power\_1(t)}{Conducted\_Tx\_power\_Plim\_1} * 1g\_or\_10gSAR\_Plim\_1 \quad (5a)$$

$$4cm^2 PD_2(t) = \frac{Conducted\_Tx\_power\_2(t)}{Conducted\_Tx\_power\_Plim\_2} * 4cm^2 PD\_Plim\_2 \quad (5b)$$

$$\frac{\frac{1}{TSAR} \int_{t-TSAR}^{t_1} 1g\_or\_10gSAR(t) dt}{ICNIRP SAR limit} + \frac{\frac{1}{TSAR} \int_{t-TSAR}^t 4cm^2 PD(t) dt}{APD 4cm^2 PD limit} \leq 1 \quad (5c)$$

where,  $conducted\_Tx\_power\_1(t)$ ,  $conducted\_Tx\_power\_Plim\_1$  and  $1g\_or\_10gSAR\_Plim\_1$  correspond to the measured instantaneous conducted Tx power and conducted Tx power at  $P_{lim\_1}$  of DUT, and  $1g\_or\_10gSAR$  values at  $P_{lim\_1}$  for the worst-case radio configuration within the tested 2.4/5GHz WLAN band;

$conducted\_Tx\_power\_2(t)$ ,  $conducted\_Tx\_power\_Plim\_2$ , and  $4cm^2 PD\_Plim\_2$  correspond to the instantaneous Tx power, conducted Tx power at  $P_{lim\_2}$  of DUT, and  $4cm^2 PD$  values (APD) of at  $P_{lim\_2}$  for the worst-case radio configuration within the tested 6GHz WLAN band.

Transition from the Band1 to the Band2 happens at time-instant ' $t_1$ '.

- if tested with both radio configurations greater than 6GHz bands that are assessed using APD (e.g., applicable for ISED):

$$4cm^2 PD_1(t) = \frac{Conducted\_Tx\_power\_1(t)}{Conducted\_Tx\_power\_Plim\_1} * 4cm^2 PD\_Plim\_1 \quad (6a)$$

$$4cm^2 PD_2(t) = \frac{Conducted\_Tx\_power\_2(t)}{Conducted\_Tx\_power\_Plim\_2} * 4cm^2 PD\_Plim\_2 \quad (6b)$$

$$\frac{\frac{1}{SAR} \left[ \int_{t-TSAR}^{t_1} 4cm^2 PD_1(t) dt + \int_{t-TSAR}^t 4cm^2 PD_2(t) dt \right]}{APD 4cm^2 PD limit} \leq 1 \quad (6c)$$

where,  $conducted\_Tx\_power\_1(t)$ ,  $conducted\_Tx\_power\_Plim\_1$ , and  $4cm^2 PD\_Plim\_1$  correspond to the instantaneous Tx power, conducted Tx power at  $P_{lim\_1}$  of DUT, and compliance  $4cm^2 PD$  values (APD) of Band 1 (or Antenna 1) at  $P_{lim\_1}$ ;

$conducted\_Tx\_power\_2(t)$ ,  $conducted\_Tx\_power\_Plim\_2$ , and  $4cm^2 PD\_Plim\_2$  correspond to the instantaneous Tx power, conducted Tx power at  $P_{lim\_2}$  of DUT, and compliance  $4cm^2 PD$  values (APD) of Antenna Band 2 (or Antenna 2) at  $P_{lim\_2}$ .

Transition from the Band 1 (or Antenna 1) to the Band 2 (or Antenna 2) happens at time- instant ' $t_1$ '.

6. Make one plot containing:
  - a. Computed time-averaged  $1g\_or\_10gSAR$  (and/or  $4cm^2 PD$ ) versus time from above procedure.
  - b. Corresponding regulatory  $1g\_or\_10gSAR$  (and/or  $4cm^2 PD$ ) limit.

The validation criteria is, at all times, the combined time-averaged  $1g\_or\_10gSAR$  (and/or  $4cm^2 PD$ ) versus time shall not exceed the regulatory  $1g\_or\_10gSAR$  (and/or  $4cm^2 PD$ ) limit.



## 5.6. pointSAR measurement test sequence

### 5.6.1. Test selection criteria

The pointSAR test is performed only with **Time-Varying Test Sequence** to provide high confidence in the algorithm validation. The radio configuration for this test is selected by following the selection criteria described in Section 5.5.1.

### 5.6.2. Test procedure

1. For a given radio configuration:
  - a. Enable WLAN connection with callbox in **FastConnect WIFI TAS Peak Exposure Mode** and enable high duty cycle Tx while performing the following steps.
  - b. Perform the area scan.
  - c. Conduct pointSAR measurement at peak location of the area scan for 120s. This pointSAR value,  $pointSAR_{Plim}$  corresponds to pointSAR at the measured  $P_{lim}$ .

**NOTE:** The measurement of Peak Exposure Mode should be performed with 70% or higher WLAN duty cycle (for example, using iPerf to generate UL traffic).

2. Set EUT to intended FastConnect Time-Averaged Exposure Mode with callbox to establish the same chosen radio configuration (mode/channel) for test.
  - a. Perform Time-averaged point SAR measurements at the same peak location as Peak Exposure Point SAR measurement for 120s. Note this includes initial 30s with WLAN with very low duty cycle (or WLAN is disconnected) and 90s of high duty cycle (WLAN has to be connected with high uplink traffic).
  - b. Once the measurement is done, extract instantaneous pointSAR versus time data,  $pointSAR(t)$
  - c. Convert it into instantaneous 1gSAR versus time by using Equations (2a) and (2c)

$$1g\_or\_10gSAR(t) = \frac{pointSAR(t)}{pointSAR_{Plim}} * 1g\_or\_10gSAR_{Plim} \quad (2a)$$

$$4cm^2 PD(t) = \frac{pointSAR(t)}{pointSAR_{Plim}} * 4cm^2 PD_{Plim} \quad (2c)$$

where,  $pointSAR_{Plim}$  corresponds to the value determined in Step 1, and  $pointSAR(t)$  corresponds to instantaneous pointSAR determined in Step 2 in this section.

- d. Then perform 30s moving average to determine time-averaged 1gSAR versus time.
3. Make one plot containing:
  - a. Computed time-averaged  $1g\_or\_10gSAR$  (or  $4cm^2 PD$ ) versus time determined from Step 2.
  - b. Regulatory  $1g\_or\_10gSAR$  (or  $4cm^2 PD$ ) limit.

The validation criteria for pointSAR measurement is, at all times, the time averaged  $1g\_or\_10gSAR$  (or  $4cm^2 PD$ ) versus time shall not exceed the regulatory  $1g\_or\_10gSAR$  (or  $4cm^2 PD$ ) limit.

## 5.7. DUT worst case 1gSAR and test mode selection

The  $P_{lim}$  is configured in FastConnect WIFI TAS BDF per according to the Static SAR test and used for validation in this test report.

Based on UL reports R14932101-S3 and R14932101-S4, the worst case 1gSAR of each radio configuration is extracted from Static SAR report and listed below, and bottom is the worst-case position.

### $P_{lim}$ and Worst case 1gSAR

Chain	Band	Modulation	Channel	$P_{max}$	$P_{lim}$	Measured 1g SAR (W/Kg)
0	2.4 GHz	802.11b 1 Mbps	6	22.50	18.75	0.464
	UNII-1 / 2A	802.11ac VHT160 MCS0	50	13.00	12.75	0.856
	UNII-2C	802.11ac VHT160 MCS0	114	14.00	11.75	0.842
	UNII-3 / 4	802.11ac VHT160 MCS0	163	13.50	13.50	0.913
		802.11a 6Mbps	157	20.00	11.75	0.639
	UNII-5	802.11be EHT320 MCS0	31	15.00	9.50	0.401
	UNII-5 / 6	802.11be EHT320 MCS0	95	9.50	9.50	0.309
UNII-7 / 8	802.11be EHT320 MCS0	191	9.50	9.50	0.218	
1	2.4 GHz	802.11b 1 Mbps	6	22.50	19.25	0.976
	UNII-1 / 2A	802.11ac VHT160 MCS0	50	13.00	12.50	1.050
	UNII-2C	802.11ac VHT160 MCS0	114	14.00	12.00	0.754
	UNII-3 / 4	802.11ac VHT160 MCS0	163	13.50	13.50	1.030
		802.11a 6Mbps	157	20.00	12.00	0.773
	UNII-5 / 6	802.11be EHT320 MCS0	95	9.50	9.50	0.452
	UNII-7 / 8	802.11be EHT320 MCS0	159	9.50	9.50	0.519
802.11be EHT320 MCS0		191	9.50	9.50	0.340	

#### Notes:

1. Reports R14932101-S3 and R14932101-S4 apply to two display variants of the same EUT model. The worst-case 1gSAR values are represented above. TAS validation not impacted by the display variant and testing performed on one representative model (Display 2).
2. Worst-case 1gSAR configuration for 5 GHz UNII does not correspond to worst-case  $P_{max} - P_{lim}$ ; worst-case  $P_{max} - P_{lim}$  configuration included for reference values used in TAS validation.

In this test report, the radio configurations selected for FastConnect Time-Varying Validation measurements are provided in the following table. The conducted power is measured at the DUT for this validation test under **FastConnect WIFI TAS Peak Exposure Mode** enabled, as per procedure required in step 1 in Section 5.5.7.

**Radio configurations selected for FastConnect Time-Varying Validation measurements in this test report.**

Band	Chain	Modulation	P <sub>max</sub>	P <sub>lim</sub>	<i>conducted T<sub>x</sub> power - P<sub>lim</sub></i> (dBm)	<i>1g_or_10gSAR - P<sub>lim</sub></i> (W/Kg)	Time Varying Test Sequence	Change in Antenna	Change in DSI	Change in WLAN Band	Simultaneous Transmissions
2.4GHz	0	11b/ 1Mbps	22.50	18.75	18.067	0.464	Conducted and pointSAR measurement		N/A	Conducted measurement	Conducted measurement
UNII-3	0	802.11a/ 6Mbps	20.00	11.75	10.122	0.639	Conducted and pointSAR measurement	Conducted measurement	N/A	Conducted measurement	Conducted measurement
	1	802.11a/ 6Mbps	20.00	12.00	10.578	0.773		Conducted measurement	N/A		

## 6. FCC Validation Test Result

### 6.1. Time-Varying Test Sequence

#### 6.1.1. Test parameters – 1<sup>st</sup> Band

Tech/Band/Ant	Parameters	Values
11b 1Mbps / 2.4GHz / Chain 0	$P_{max}$	22.5
	Reserve margin (dB)	1
	Meas. Cond. $P_{lim}$ (dBm)	18.067
	Meas. SAR @ $P_{lim}$ (W/kg)	0.464

#### 6.1.2. Test plots and result – 1<sup>st</sup> Band

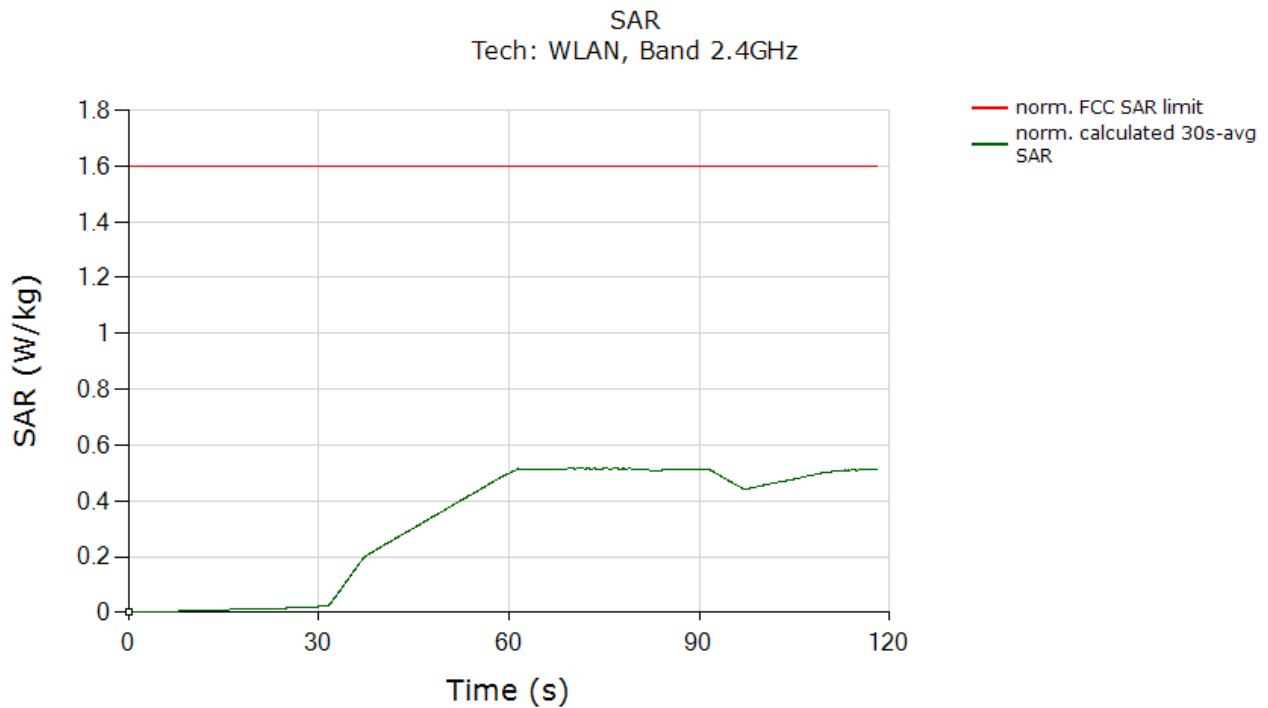

	W/Kg
FCC exposure limit	1.6
Max time-averaged SAR (green curve)	0.515
Validated	

### 6.1.3. Test parameters – 2<sup>nd</sup> Band

Tech/Band/Ant/DSI	Parameters	Values
802.11a 6Mbps / UNII-3 / Chain 0	$P_{max}$	20
	Reserve margin (dB)	1
	Meas. Cond. $P_{lim}$ (dBm)	10.122
	Meas. SAR @ $P_{lim}$ (W/kg)	0.639

### 6.1.4. Test plots and result – 2<sup>nd</sup> Band

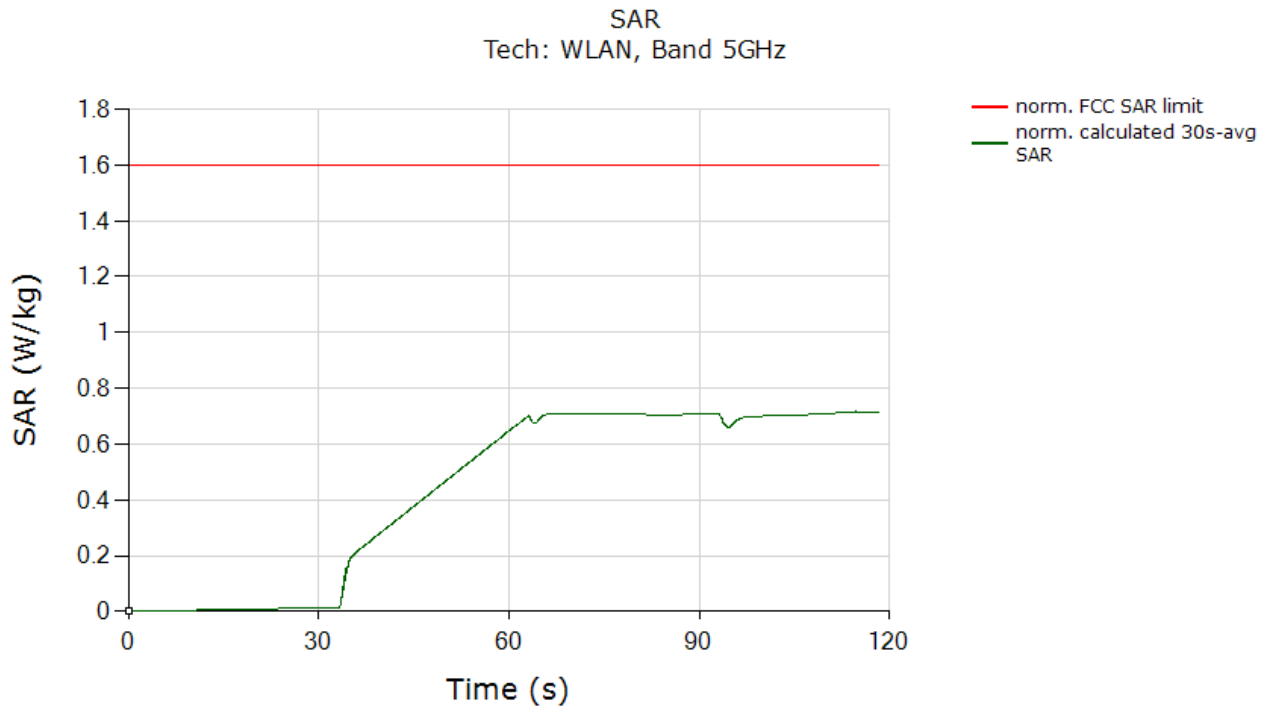

	W/Kg
FCC exposure limit	1.6
Max time-averaged SAR (green curve)	0.716
Validated	

## 6.2. Change in antenna

### 6.2.1. Test parameters

Tech/Band/Ant/DSI	Parameters	Values
802.11a 6Mbps / UNII-3 / Chain 0	$P_{max}$	20
	Reserve margin (dB)	1
	Meas. Cond. $P_{lim}$ (dBm)	10.122
	Meas. SAR @ $P_{lim}$ (W/kg)	0.639
Switch time (sec)		111.6
802.11a 6Mbps / UNII-3 / Chain 1	$P_{max}$	20
	Reserve margin (dB)	1
	Meas. Cond. $P_{lim}$ (dBm)	10.578
	Meas. SAR @ $P_{lim}$ (W/kg)	0.773

### 6.2.2. Test plots and result

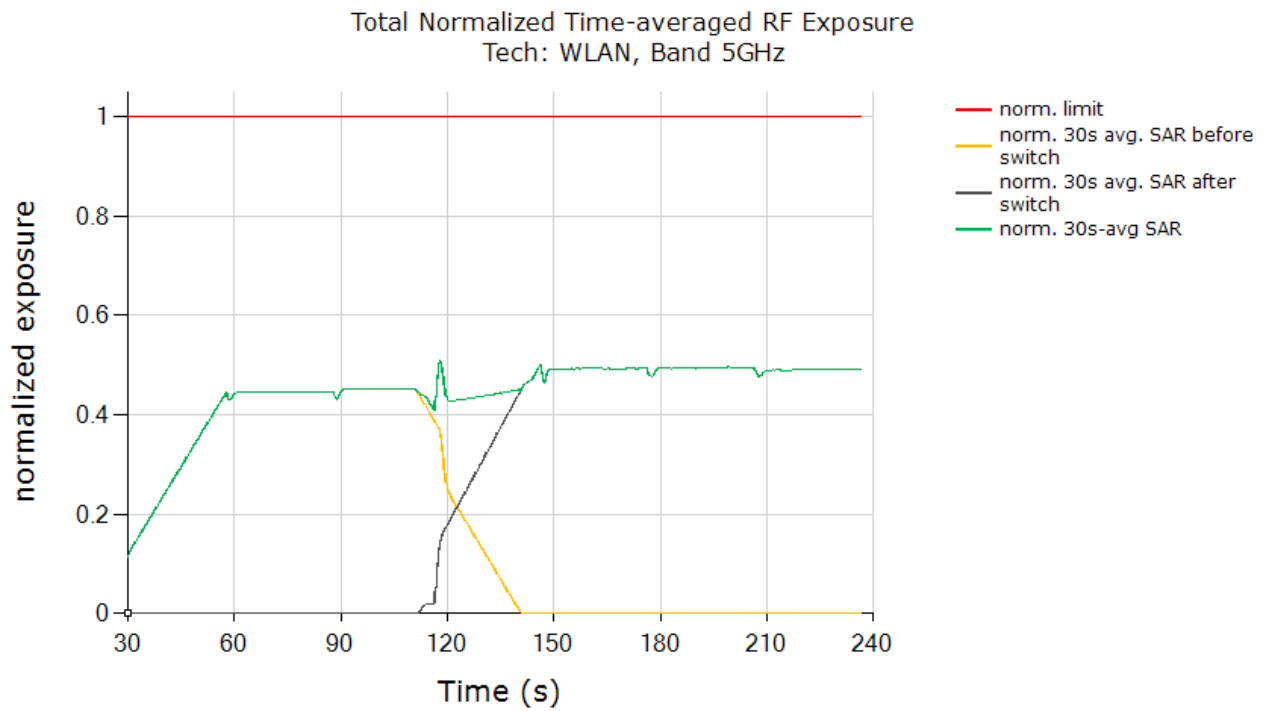

	Norm. exposure value
FCC normalized total exposure limit	1.0
Max total normalized time-averaged SAR (green curve)	0.510
<b>Validated</b>	

### 6.3. Change in WLAN band

#### 6.3.1. Test parameters

Tech/Band/Ant/DSI	Parameters	Values
802.11a 6Mbps / UNII-3 / Chain 0	$P_{max}$	20
	Reserve margin (dB)	1
	Meas. Cond. $P_{lim}$ (dBm)	10.122
	Meas. SAR @ $P_{lim}$ (W/kg)	0.639
Switch time (sec)		110.3
11b 1Mbps / 2.4GHz / Chain 0	$P_{max}$	22.5
	Reserve margin (dB)	1
	Meas. Cond. $P_{lim}$ (dBm)	18.067
	Meas. SAR @ $P_{lim}$ (W/kg)	0.464

#### 6.3.2. Test plots and result

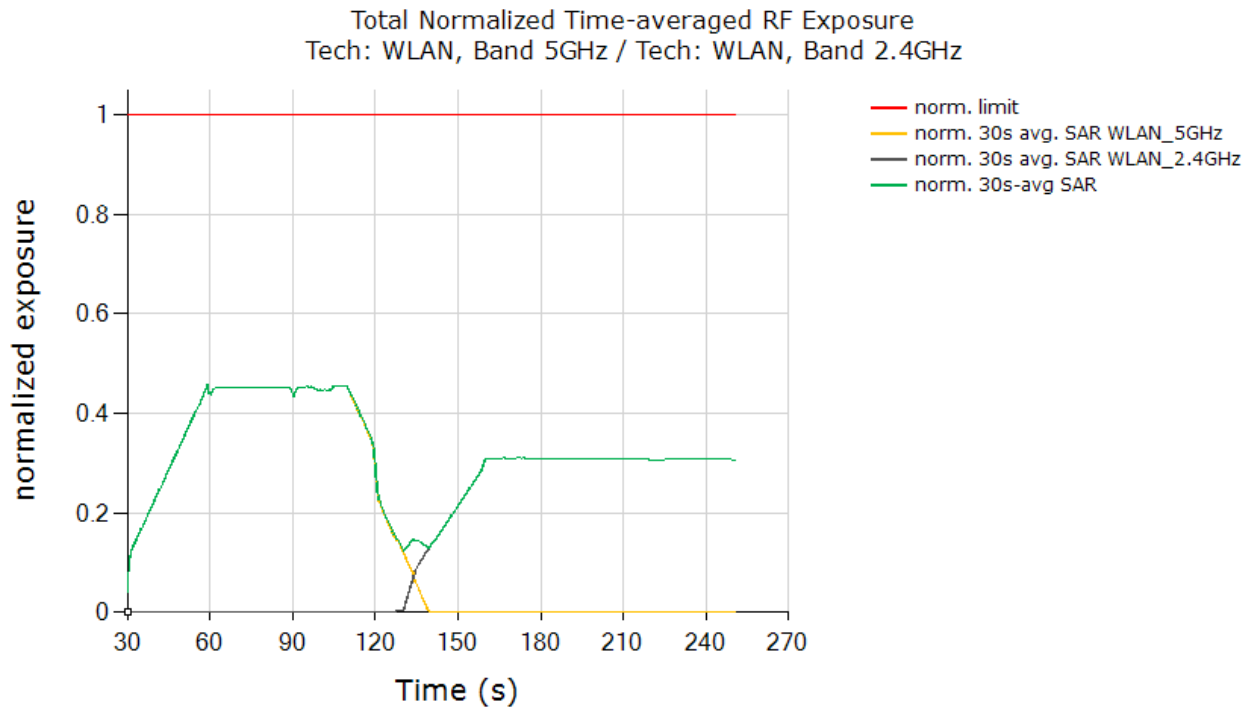

	Norm. exposure value
FCC normalized total exposure limit	1.0
Max total normalized time-averaged SAR (green curve)	0.458
Validated	

### 6.4. Simultaneous Transmissions

#### 6.4.1. Test parameters

Tech/Band/Ant/DSI	Parameters	Values
802.11a 6Mbps / UNII-3 / Chain 0	P <sub>max</sub>	20.0
	Reserve margin (dB)	1
	Meas. Cond. P <sub>lim</sub> (dBm)	10.122
	Meas. SAR @ P <sub>lim</sub> (W/kg)	0.639
11b 1Mbps / 2.4GHz / Chain 0	P <sub>max</sub>	22.5
	Reserve margin (dB)	1
	Meas. Cond. P <sub>lim</sub> (dBm)	18.067
	Meas. SAR @ P <sub>lim</sub> (W/kg)	0.464

#### 6.4.2. Test plots and result

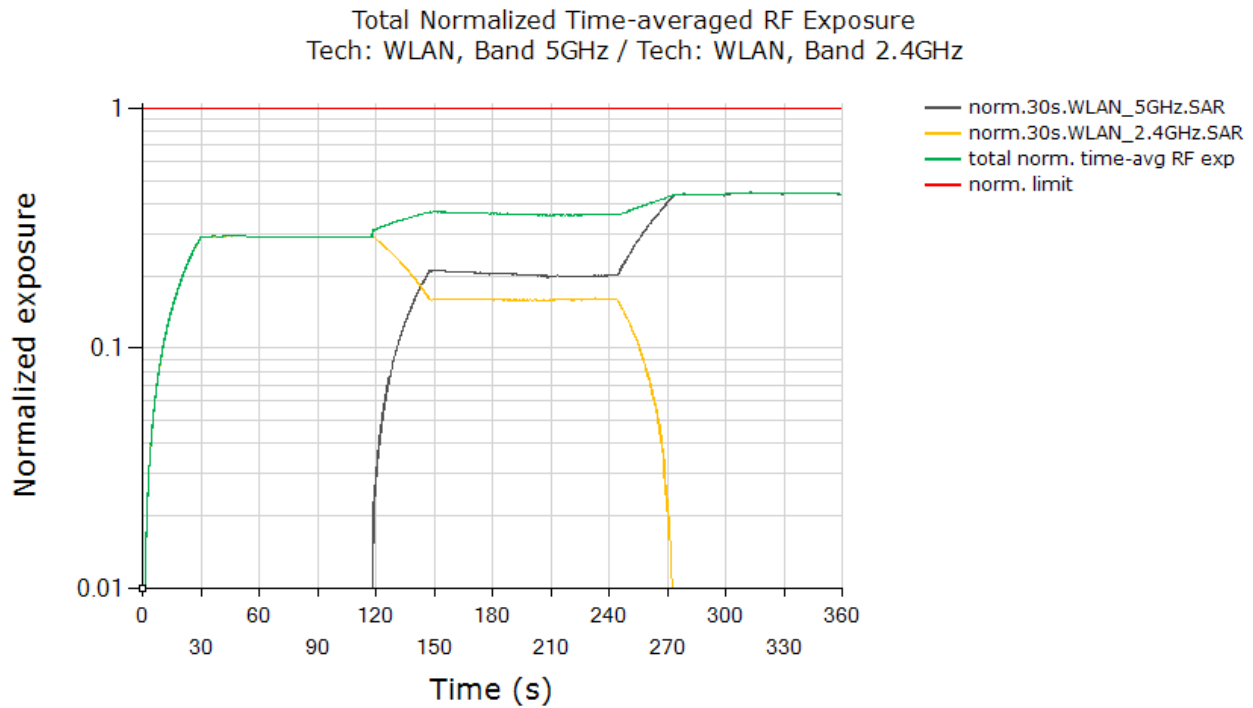

	Norm. exposure value
FCC normalized total exposure limit	1.0
Max total normalized time-averaged SAR (green curve)	0.446
<b>Validated</b>	



## 7. pointSAR Test

### 7.1. Time-Varying Test Sequence

#### 7.1.1. Test parameters – 1st Band

Tech/Band/Ant/DSI	Parameters	Values
11b 1Mbps / 2.4GHz / Chain 0	Test Position	Bottom
	Meas. SAR @ P <sub>lim</sub> (W/kg)	0.464

#### 7.1.2. Test plots and result – 1<sup>st</sup> Band

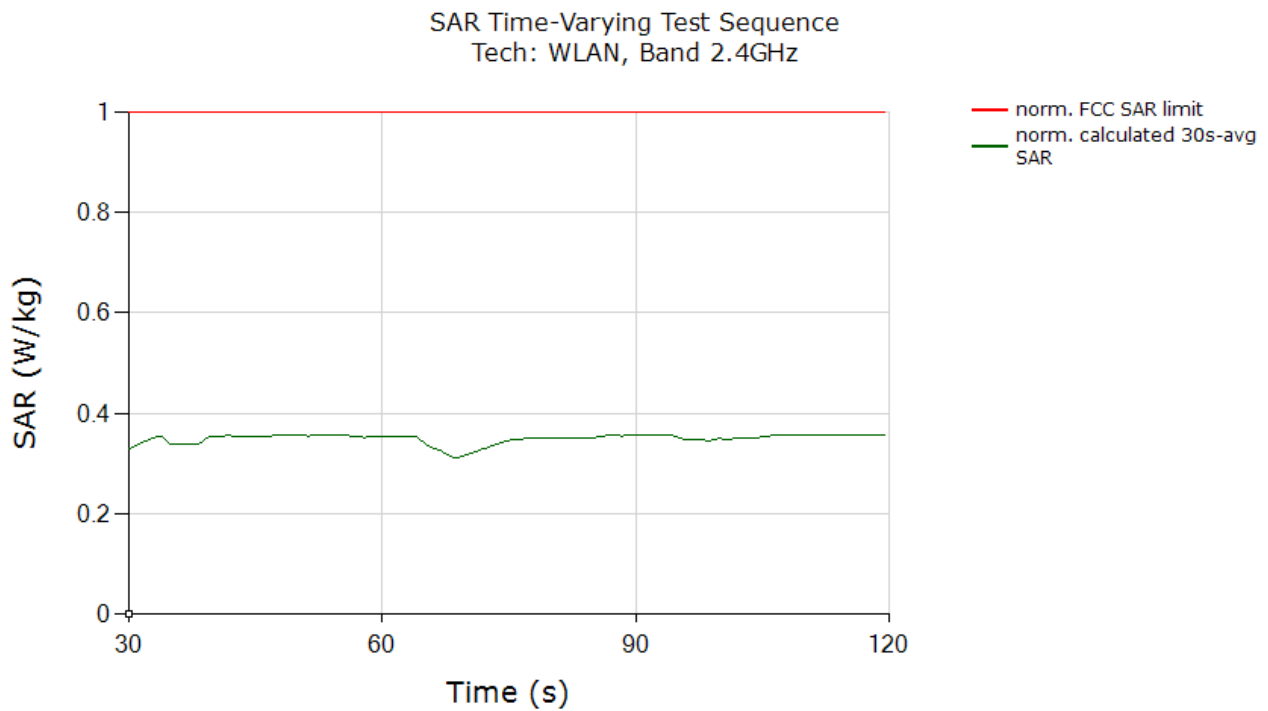

	Norm. exposure value
FCC exposure limit	1.0
Max time-averaged SAR (green curve)	0.358
<b>Validated</b>	

**7.1.3. Test parameters – 2<sup>nd</sup> Band**

Tech/Band/Ant/DSI	Parameters	Values
802.11a 6Mbps / UNII-3 / Chain 0	Test Position	Bottom
	Meas. SAR @ P <sub>lim</sub> (W/kg)	0.639

**7.1.4. Test plots and result – 2<sup>nd</sup> Band**

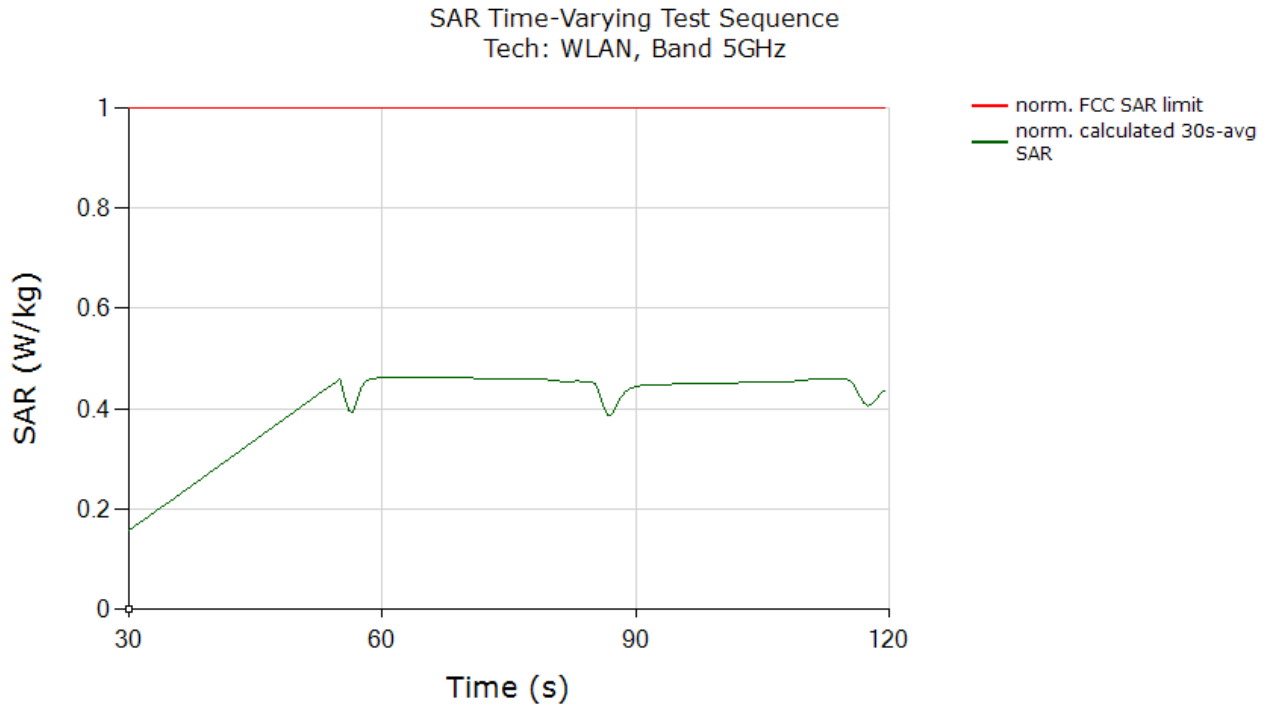

	Norm. exposure value
FCC exposure limit	1.0
Max time-averaged SAR (green curve)	0.463
<b>Validated</b>	

## 8. Conclusions

Qualcomm Smart Transmit feature employed herein has been validated through the conducted/radiated power measurement (as demonstrated in §6), as well as SAR measurement (as demonstrated in §7).

As demonstrated in this report, the power limiting enforcement is effective and the total normalized time-averaged RF exposure does not exceed 1.0 for all the transmission scenarios as described in §5. Therefore, the EUT complies with FCC RF exposure requirements.

## Appendices

### A DASYS8 System Validation

#### A.1 SAR System Verification and Validation

The system verification was performed using a dipole antenna against the flat section of the SAM phantom. Table A-1 shows the verification test results and the relevant plots are provided in Appendix C. The measured SAR values for the frequency bands of interest were within  $\pm 10\%$  of the corresponding target SAR levels.

**Table A-1: System validation results**

SAR Lab	Date	Tissue Type	Dipole Type_Serial #	Dipole Cal. Due Data	Dipole Power (dBm)	Measured Results for 1g SAR				Measured Results for 10g SAR				Plot No.
						Zoom Scan	Normalize to 1 W	Target (Ref. Value)	Delta $\pm 10\%$	Zoom Scan	Normalize to 1 W	Target (Ref. Value)	Delta $\pm 10\%$	
2A	4/2/2024	Head	D2450V2 SN: 963	10/20/2024	17.00	2.570	51.28	53.30	-3.79	1.200	23.94	25.10	-4.61	1
2A	4/17/2024	Head	D2450V2 SN: 963	10/20/2024	17.00	2.510	50.08	53.30	-6.04	1.170	23.34	25.10	-6.99	2
2B	4/16/2024	Head	D5GHzV2 SN: 1213 (5.75 GHz)	10/17/2024	17.00	3.720	74.22	80.30	-7.57	1.060	21.15	23.00	-8.04	3

Broad-band solution HBBL600-10000V6 was used for tissue-simulating liquid. Table A-2 list the tissue dielectric properties.<sup>1</sup>

**Table A-2: Tissue dielectric properties at the time of testing**

SAR Lab	Date	Band (MHz)	Tissue Type	Frequency (MHz)	Relative Permittivity ( $\epsilon_r$ )			Conductivity ( $\sigma$ )		
					Measured	Target	Delta (%)	Measured	Target	Delta (%)
2A	2024-04-02	2450	Head	2450	40.3	39.2	2.88	1.88	1.80	4.22
				2400	40.4	39.3	2.88	1.84	1.75	4.93
				2480	40.3	39.2	2.85	1.90	1.83	3.80
2A	2024-04-17	2450	Head	2450	40.9	39.2	4.26	1.85	1.80	2.72
				2400	41.0	39.3	4.21	1.81	1.75	3.56
				2480	40.8	39.2	4.28	1.88	1.83	2.32
2B	2024-04-16	5750	Head	5750	35.0	35.4	-0.91	5.15	5.21	-1.24
				5700	35.1	35.4	-0.79	5.08	5.16	-1.52
				5850	34.9	35.3	-1.22	5.26	5.32	-1.09

Appendix D provides the calibration certificates for SAR measurement equipment used in this report.

<sup>1</sup> The deviation should be controlled within  $\pm 5\%$ . If the deviation is between  $\pm 5\%$  to  $\pm 10\%$ , the correction will be made in the corresponding SAR result to compensate the additional deviation.

## B DUT TAS BDF configuration

To validate FastConnect WIFI TAS device in dynamic transmission scenario, the FastConnect WIFI TAS parameters are configured in the BDF for the DUT in this TAS validation test. OEMs need to confirm with Qualcomm Customer Engineering (CE) for the appropriate FastConnect WIFI TAS Board Data File configuration guide is applicable for the device.

Note: The Board Data file is configured in binary file in SW and all the FastConnect WIFI TAS configurable parameters cannot be accessed by the end-user.

### **$P_{lim}$ values stored in the board data file (BDF)**

FastConnect WIFI TAS supports separate  $P_{lim}$  values for the following:

- Same  $P_{lim}$  value for SISO and MIMO
- Only a single DSI

The WLAN BDF is populated by the device manufacturer with the  $P_{lim}$  format reference listed in the following table. Data for each row are determined through SAR characterization and Static SAR testing.

### **$P_{lim}$ values to be configured.**

<b><math>P_{lim}</math> values</b>
2GHz (Chain0) Power Limit Value
2GHz (Chain1) Power Limit Value
5GHz (Chain0) Power Limit Value
5GHz (Chain1) Power Limit Value
6GHz (Chain0) Power Limit Value
6GHz (Chain1) Power Limit Value

#### Notes:

1.  $P_{lim}$  values are in 0.25 dB increments.
2. BDF optionally may be configured with different  $P_{lim}$  values across a range of WLAN frequencies within each band.
3. The  $P_{lim}$  values entered in BDF reflect device uncertainty.
4. Reserve margin = 1 dB

**P<sub>lim</sub> and Reserve Margin**

This section provides P<sub>lim</sub> and reserve margin configuration information for the time varying validation test DUT used in this test report base on reference data provided in SAR characterization and Static SAR test report.

- P<sub>lim</sub> setting: The validated P<sub>lim</sub> value from SAR characterization and static SAR test result are populated into FastConnect BDF. Each P<sub>lim</sub> represents the worst-case technologies of the given antenna/mode/band/DSI. In this test report, P<sub>lim</sub> are configured for RF exposure limit = FCC limit and used by both USA and Canada in FastConnect WIFI TAS BDF for FastConnect validation test.
- Reserve margin: The reserve margin is configured to 1dB which value is configurable by OEM. Inhere, Reserve margin is set to 1dB in.

**P<sub>lim</sub> and Reserve Margin for DUT**

Tx Chain	Antenna	P <sub>lim</sub> Setting	Reserve Margin
2GHz (Chain0)	Left	18.75	1
2GHz (Chain1)	Right	19.25	
5GHz (Chain0)	Left	11.75	
5GHz (Chain1)	Right	12.00	
6GHz (Chain0)	Left	9.50	
6GHz (Chain1)	Right	9.50	

**Antenna Group**

Antenna Group: In this test report. Antennas are grouped to 2 AG to demonstrate FastConnect WIFI TAS manages transmit power in real time under for all test scenarios in FastConnect WIFI TAS validation test.

**Table B-4 Antenna Group**

Tx Chain	Antenna Group
2GHz (Chain0)	0
2GHz (Chain1)	1
5GHz (Chain0)	0
5GHz (Chain1)	1
6GHz (Chain0)	0
6GHz (Chain1)	1

- C DASY8 System Verification Plots**
- D SPEAG Certificates of cDASY6 SAR Probe, DAE, Dipole**
- E Test Setup Photos**

**End of Report**