

**ELECTROMAGNETIC EMISSIONS
COMPLIANCE REPORT**

Applicant: Microsoft Corporation
One Microsoft Way, Redmond, WA 98052-6399 USA

Product Name: Portable Computing Device

Brand Name: Microsoft

Model No.: 2022

Report Number: ER/2021/80081

FCC ID C3K2022

IC: 3048A-2022

Issue Date: November 12, 2021

Date of Test: August 24, 2021 ~ October 13, 2021

Date of EUT Received: August 24, 2021

Jet Lu

Approved By _____**Jet Lu****We hereby certify that:**

The above equipment was tested by SGS Taiwan Ltd. Central RF Lab The test data, data evaluation, test procedures, and equipment configurations shown in this report were made in accordance with the procedures given in ANSI C63.26-2015 and the energy emitted by the sample EUT comply with FCC rule part 2, 22H & 24E and ISSED RSS-Gen, 132, 133.

The results of this report relate only to the sample identified in this report.

Unless otherwise stated the results shown in this test report refer only to the sample(s) tested and such sample(s) are retained for 90 days only.
除非另有說明，此報告結果僅對測試之樣品負責，同時此樣品僅保留90天。本報告未經本公司書面許可，不可部份複製。

This document is issued by the Company subject to its General Conditions of Service printed overleaf, available on request or accessible at <http://www.sgs.com.tw/Terms-and-Conditions> and for electronic format documents, subject to Terms and Conditions for Electronic Documents at <http://www.sgs.com.tw/Terms-and-Conditions>. Attention is drawn to the limitation of liability, indemnification and jurisdiction issues defined therein. Any holder of this document is advised that information contained hereon reflects the Company's findings at the time of its intervention only and within the limits of Client's instructions, if any. The Company's sole responsibility is to its Client and this document does not exonerate parties to a transaction from exercising all their rights and obligations under the transaction documents. This document cannot be reproduced except in full, without prior written approval of the Company. Any unauthorized alteration, forgery or falsification of the content or appearance of this document is unlawful and offenders may be prosecuted to the fullest extent of the law.

Revision History

Report Number	Revision	Description	Issue Date	Revised By
ER/2021/80081	00	Original.	November 12, 2021	Karen Huang

Unless otherwise stated the results shown in this test report refer only to the sample(s) tested and such sample(s) are retained for 90 days only.

除非另有說明，此報告結果僅對測試之樣品負責，同時此樣品僅保留90天。本報告未經本公司書面許可，不可部份複製。

This document is issued by the Company subject to its General Conditions of Service printed overleaf, available on request or accessible at <http://www.sgs.com.tw/Terms-and-Conditions> and for electronic format documents, subject to Terms and Conditions for Electronic Documents at <http://www.sgs.com.tw/Terms-and-Conditions>. Attention is drawn to the limitation of liability, indemnification and jurisdiction issues defined therein. Any holder of this document is advised that information contained hereon reflects the Company's findings at the time of its intervention only and within the limits of Client's instructions, if any. The Company's sole responsibility is to its Client and this document does not exonerate parties to a transaction from exercising all their rights and obligations under the transaction documents. This document cannot be reproduced except in full, without prior written approval of the Company. Any unauthorized alteration, forgery or falsification of the content or appearance of this document is unlawful and offenders may be prosecuted to the fullest extent of the law.

Contents

1	GENERAL PRODUCT INFORMATION	4
2	SYSTEM TEST CONFIGURATION	8
3	SUMMARY OF TEST RESULTS	11
4	DESCRIPTION OF TEST MODES	12
5	MEASUREMENT UNCERTAINTY	14
6	MAXMUM OUTPUT POWER	15
7	OCCUPIED BANDWIDTH MEASUREMENT	21
8	OUT OF BAND EMISSION AT ANTENNA TERMINALS	26
9	FIELD STRENGTH OF SPURIOUS RADIATION MEASUREMENT.....	36
10	FREQUENCY STABILITY MEASUREMENT	52
11	PEAK TO AVERAGE RATIO	56

Unless otherwise stated the results shown in this test report refer only to the sample(s) tested and such sample(s) are retained for 90 days only.

除非另有說明，此報告結果僅對測試之樣品負責，同時此樣品僅保留90天。本報告未經本公司書面許可，不可部份複製。

This document is issued by the Company subject to its General Conditions of Service printed overleaf, available on request or accessible at <http://www.sgs.com.tw/Terms-and-Conditions> and for electronic format documents, subject to Terms and Conditions for Electronic Documents at <http://www.sgs.com.tw/Terms-and-Conditions>. Attention is drawn to the limitation of liability, indemnification and jurisdiction issues defined therein. Any holder of this document is advised that information contained hereon reflects the Company's findings at the time of its intervention only and within the limits of Client's instructions, if any. The Company's sole responsibility is to its Client and this document does not exonerate parties to a transaction from exercising all their rights and obligations under the transaction documents. This document cannot be reproduced except in full, without prior written approval of the Company. Any unauthorized alteration, forgery or falsification of the content or appearance of this document is unlawful and offenders may be prosecuted to the fullest extent of the law.

1 GENERAL PRODUCT INFORMATION

1.1 Product Description

Product Name:	Portable Computing Device	
Brand Name:	Microsoft	
Model No.:	2022	
Normal Test Version:	10.0.22000.1	
IMEI:	004403150387399	
Power Supply:	7.66 Vdc from Rechargeable Li-polymer Battery or 15Vdc from AC/DC Adapter	
	Battery:	Model No.: DYNU01, Supplier: DYNAPACK
	Adapter:	Model No.: 1735, Supplier: Lite On

Note:

This report is for host model 2022 which contains the module FCC ID: C3K1956 and IC: 3048A-1956.

1.2 Operation Frequency Range

Operating Frequency (MHz)		
WCDMA / HSPA Band II	1852.4	- 1907.6
WCDMA / HSPA Band V	826.4	- 846.6

Unless otherwise stated the results shown in this test report refer only to the sample(s) tested and such sample(s) are retained for 90 days only.

除非另有說明，此報告結果僅對測試之樣品負責，同時此樣品僅保留90天。本報告未經本公司書面許可，不可部份複製。

This document is issued by the Company subject to its General Conditions of Service printed overleaf, available on request or accessible at <http://www.sgs.com.tw/Terms-and-Conditions> and for electronic format documents, subject to Terms and Conditions for Electronic Documents at <http://www.sgs.com.tw/Terms-and-Conditions>. Attention is drawn to the limitation of liability, indemnification and jurisdiction issues defined therein. Any holder of this document is advised that information contained hereon reflects the Company's findings at the time of its intervention only and within the limits of Client's instructions, if any. The Company's sole responsibility is to its Client and this document does not exonerate parties to a transaction from exercising all their rights and obligations under the transaction documents. This document cannot be reproduced except in full, without prior written approval of the Company. Any unauthorized alteration, forgery or falsification of the content or appearance of this document is unlawful and offenders may be prosecuted to the fullest extent of the law.

1.3 Antenna Designation

Antenna Type	Main / Aux
Monopole	Main
Note: Transmission in frequencies in this test report are only available by the above antenna(s).	

Modulation	Frequency (MHz)	Peak Antenna Gain (dBi)
		Main
WCDMA / HSPA Band II	1852.4 - 1907.6	0.7
WCDMA / HSPA Band V	826.4 - 846.6	-2.5

Note: Antenna information is provided by the applicant.

1.4 Type of Emission & Max ERP/EIRP Power Measurement Result:

	ERP / EIRP (dBm)		W	99%	Type of Emission
WCDMA Band II	24.64	EIRP	0.291	4.1263	4M13F9W
HSDPA Band II	23.96	EIRP	0.249	4.1177	4M12F9W
HSUPA Band II	23.78	EIRP	0.239	4.1152	4M12F9W
WCDMA Band V	19.07	ERP	0.081	4.1268	4M13F9W
HSDPA Band V	18.07	ERP	0.064	4.1241	4M12F9W
HSUPA Band V	18.07	ERP	0.064	4.1229	4M12F9W

Unless otherwise stated the results shown in this test report refer only to the sample(s) tested and such sample(s) are retained for 90 days only.

除非另有說明，此報告結果僅對測試之樣品負責，同時此樣品僅保留90天。本報告未經本公司書面許可，不可部份複製。

This document is issued by the Company subject to its General Conditions of Service printed overleaf, available on request or accessible at <http://www.sgs.com.tw/Terms-and-Conditions> and for electronic format documents, subject to Terms and Conditions for Electronic Documents at <http://www.sgs.com.tw/Terms-and-Conditions>. Attention is drawn to the limitation of liability, indemnification and jurisdiction issues defined therein. Any holder of this document is advised that information contained hereon reflects the Company's findings at the time of its intervention only and within the limits of Client's instructions, if any. The Company's sole responsibility is to its Client and this document does not exonerate parties to a transaction from exercising all their rights and obligations under the transaction documents. This document cannot be reproduced except in full, without prior written approval of the Company. Any unauthorized alteration, forgery or falsification of the content or appearance of this document is unlawful and offenders may be prosecuted to the fullest extent of the law.

1.5 Test Methodology of Applied Standards

FCC 47 CFR Part 2, 22H, 24E

ISED RSS-132 Issue 3 Jan. 2013

ISED RSS-133 Issue 6, Amendment 1 Jan. 18, 2018

ANSI C63.26-2015

KDB971168 D01 Power Meas license Digital System v03r01

KDB941225 D01 SAR test for 3G devices v03r01 (SAR Measurement Procedures for 3G Devices, WCDMA / HSPA) was used for EUT and Base station setting.

KDB412172 D01 Determining ERP and EIRP v01r01

TS 151 010-1 is used to set, and measure the output power.

1.6 Test Facility

Laboratory	Test Site Address	Test Site Name	FCC Designation number	IC CAB identifier
SGS Taiwan Ltd. Central RF Lab. (TAF code 3702)	No.134, Wu Kung Road, New Taipei Industrial Park, Wuku District, New Taipei City, Taiwan.	SAC 1	TW0027	TW3702
		SAC 3		
		Conduction 1		
		Conducted 1		
		Conducted 2		
		Conducted 3		
		Conducted 4		
		Conducted 5		
	Conducted 6			
	No.2, Keji 1st Rd., Guishan District, Taoyuan City, Taiwan 333	Conduction C	TW0028	
		SAC C		
		SAC D		
		SAC G		
		Conducted A		
		Conducted B		
		Conducted C		
		Conducted D		
		Conducted E		
		Conducted F		
Conducted G				

Note: Test site name is remarked on the equipment list in each section of this report as an indication where measurements occurred in specific test site and address.

1.7 Special Accessories

No special accessories were used during testing.

1.8 Equipment Modifications

There was no modifications incorporated into the EUT.

Unless otherwise stated the results shown in this test report refer only to the sample(s) tested and such sample(s) are retained for 90 days only.

除非另有說明，此報告結果僅對測試之樣品負責，同時此樣品僅保留90天。本報告未經本公司書面許可，不可部份複製。

This document is issued by the Company subject to its General Conditions of Service printed overleaf, available on request or accessible at <http://www.sgs.com.tw/Terms-and-Conditions> and for electronic format documents, subject to Terms and Conditions for Electronic Documents at <http://www.sgs.com.tw/Terms-and-Conditions>. Attention is drawn to the limitation of liability, indemnification and jurisdiction issues defined therein. Any holder of this document is advised that information contained hereon reflects the Company's findings at the time of its intervention only and within the limits of Client's instructions, if any. The Company's sole responsibility is to its Client and this document does not exonerate parties to a transaction from exercising all their rights and obligations under the transaction documents. This document cannot be reproduced except in full, without prior written approval of the Company. Any unauthorized alteration, forgery or falsification of the content or appearance of this document is unlawful and offenders may be prosecuted to the fullest extent of the law.

1.9 Radiated Emission Test Sites For Measurements From 9 kHz To 30 MHz

Radiated emission below 30MHz is measured in a 9m*9m*6m semi-anechoic chamber, the measurements correspond to those obtained at an open-field test site.

There is a comparison data of both open-field test site and semi-Anechoic chamber, and the result came out very similar.

Unless otherwise stated the results shown in this test report refer only to the sample(s) tested and such sample(s) are retained for 90 days only.

除非另有說明，此報告結果僅對測試之樣品負責，同時此樣品僅保留90天。本報告未經本公司書面許可，不可部份複製。

This document is issued by the Company subject to its General Conditions of Service printed overleaf, available on request or accessible at <http://www.sgs.com.tw/Terms-and-Conditions> and for electronic format documents, subject to Terms and Conditions for Electronic Documents at <http://www.sgs.com.tw/Terms-and-Conditions>. Attention is drawn to the limitation of liability, indemnification and jurisdiction issues defined therein. Any holder of this document is advised that information contained hereon reflects the Company's findings at the time of its intervention only and within the limits of Client's instructions, if any. The Company's sole responsibility is to its Client and this document does not exonerate parties to a transaction from exercising all their rights and obligations under the transaction documents. This document cannot be reproduced except in full, without prior written approval of the Company. Any unauthorized alteration, forgery or falsification of the content or appearance of this document is unlawful and offenders may be prosecuted to the fullest extent of the law.

2 SYSTEM TEST CONFIGURATION

2.1 EUT Configuration

The EUT configuration for testing is installed on RF field strength measurement to meet the Commissions requirement and operating in a manner which intends to maximize its emission characteristics in a continuous normal application.

2.2 EUT Exercise

The EUT (Transmitter) was operated in the continuous transmission mode employed with the simulator of the Base Station that fixates at test default channels to fix the Tx frequency which was for the purpose of the measurements.

2.3 Test Procedure

2.3.1 Conducted Measurement at Antenna Port

The EUT is placed on a table which is 0.8 m above ground plane. A low loss of RF cable was used to connect the antenna port of EUT to measurement equipment.

2.3.2 Radiated Emissions (ERP/EIRP)

The EUT is placed on a turn table, for emission measurements below 1 GHz is 0.8 m above ground plane, for emission measurements above 1 GHz, the table height shall be 1.5 m. The turn table shall rotate 360 degrees to determine the position of maximum emission level. EUT is set 3m away from the receiving antenna which varied from 1m to 4m to find out the highest emission. And also, each emission was to be maximized by changing the polarization of receiving antenna both Horizontal and Vertical. In order to find out the max. emission, the relative positions of this hand-held transmitter (EUT) was rotated through three orthogonal axes and measurement procedures for electric field radiated emissions above 1 GHz the EUT measurement is to be made “while keeping the antenna in the ‘cone of radiation’ from that area and pointed at the area both in azimuth and elevation, with polarization oriented for maximum response.” is still within the 3dB illumination BW of the measurement antenna.

2.4 Measurement Results Explanation Example

For all conducted test items:

The offset level is set in the spectrum analyzer to compensate the RF cable loss and attenuation factor between EUT conducted port and spectrum analyzer. With the offset compensation, the spectrum analyzer reading level is exactly EUT RF output level.

Note:

The spectrum analyzer offset is derived from RF cable loss and attenuator factor. Following shows an offset computation in physical test.

	RF cable loss (dB)	Attenuation factor(dB)	offset(dB)
Low Band (Below 1GHz)	4.3	10	14.3
Middle Band (1 GHz-2GHz)	4.55	10	14.55

Unless otherwise stated the results shown in this test report refer only to the sample(s) tested and such sample(s) are retained for 90 days only.

除非另有說明，此報告結果僅對測試之樣品負責，同時此樣品僅保留90天。本報告未經本公司書面許可，不可部份複製。

This document is issued by the Company subject to its General Conditions of Service printed overleaf, available on request or accessible at <http://www.sgs.com.tw/Terms-and-Conditions> and for electronic format documents, subject to Terms and Conditions for Electronic Documents at <http://www.sgs.com.tw/Terms-and-Conditions>. Attention is drawn to the limitation of liability, indemnification and jurisdiction issues defined therein. Any holder of this document is advised that information contained hereon reflects the Company's findings at the time of its intervention only and within the limits of Client's instructions, if any. The Company's sole responsibility is to its Client and this document does not exonerate parties to a transaction from exercising all their rights and obligations under the transaction documents. This document cannot be reproduced except in full, without prior written approval of the Company. Any unauthorized alteration, forgery or falsification of the content or appearance of this document is unlawful and offenders may be prosecuted to the fullest extent of the law.

2.5 Final Amplifier Voltage and Current Information:

Test mode	DC voltage (V)	DC current (mA)
WCDMA B2	7.66	343
HSUPA B2	7.66	368
HSDPA B2	7.66	392
WCDMA B5	7.66	357
HSUPA B5	7.66	332
HSDPA B5	7.66	386

Unless otherwise stated the results shown in this test report refer only to the sample(s) tested and such sample(s) are retained for 90 days only.

除非另有說明，此報告結果僅對測試之樣品負責，同時此樣品僅保留90天。本報告未經本公司書面許可，不可部份複製。

This document is issued by the Company subject to its General Conditions of Service printed overleaf, available on request or accessible at <http://www.sgs.com.tw/Terms-and-Conditions> and for electronic format documents, subject to Terms and Conditions for Electronic Documents at <http://www.sgs.com.tw/Terms-and-Conditions>. Attention is drawn to the limitation of liability, indemnification and jurisdiction issues defined therein. Any holder of this document is advised that information contained hereon reflects the Company's findings at the time of its intervention only and within the limits of Client's instructions, if any. The Company's sole responsibility is to its Client and this document does not exonerate parties to a transaction from exercising all their rights and obligations under the transaction documents. This document cannot be reproduced except in full, without prior written approval of the Company. Any unauthorized alteration, forgery or falsification of the content or appearance of this document is unlawful and offenders may be prosecuted to the fullest extent of the law.

2.6 Test Configuration

2.6.1 Conducted Emission at the Antenna Port

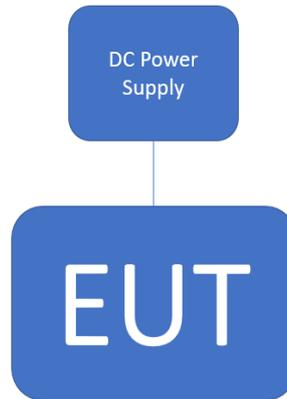

2.6.2 Radiated Emission

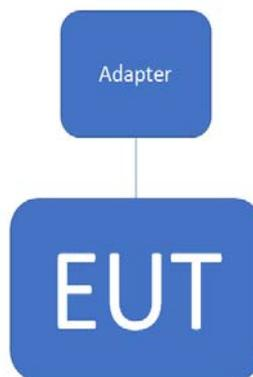

2.6.3 Equipment used for test

EQUIPMENT TYPE	MFR	MODEL NUMBER	SERIAL NUMBER	LAST CAL.	CAL DUE.
Radio Communication Analyser	Anritsu	MT8815B	6200711454	04/07/2021	04/06/2022
Attenuator	Mini-Circuit	BW-S10W2+	4	12/16/2020	12/15/2021
DC Power Supply	Agilent	E3640A	MY40005907	10/29/2020	10/28/2021
EQUIPMENT TYPE	MFR	MODEL NUMBER	SERIAL NUMBER	LAST CAL.	CAL DUE.
Adapter	Microsoft	1735	NA	N/A	N/A

Unless otherwise stated the results shown in this test report refer only to the sample(s) tested and such sample(s) are retained for 90 days only.

除非另有說明，此報告結果僅對測試之樣品負責，同時此樣品僅保留90天。本報告未經本公司書面許可，不可部份複製。

This document is issued by the Company subject to its General Conditions of Service printed overleaf, available on request or accessible at <http://www.sgs.com.tw/Terms-and-Conditions> and for electronic format documents, subject to Terms and Conditions for Electronic Documents at <http://www.sgs.com.tw/Terms-and-Conditions>. Attention is drawn to the limitation of liability, indemnification and jurisdiction issues defined therein. Any holder of this document is advised that information contained hereon reflects the Company's findings at the time of its intervention only and within the limits of Client's instructions, if any. The Company's sole responsibility is to its Client and this document does not exonerate parties to a transaction from exercising all their rights and obligations under the transaction documents. This document cannot be reproduced except in full, without prior written approval of the Company. Any unauthorized alteration, forgery or falsification of the content or appearance of this document is unlawful and offenders may be prosecuted to the fullest extent of the law.

3 SUMMARY OF TEST RESULTS

FCC Rules	IC Rules	Description Of Test	Result
§2.1046(a)	RSS-GEN §6.12	RF Power Output	Compliant
§22.913(a)(5) §24.232(c)	RSS-132 §5.4 RSS-133 §6.4	ERP/ EIRP measurement	Compliant
§2.1049(h)	RSS-GEN §6.7	99% & 26dB Occupied Bandwidth	Compliant
§2.1051 §22.917(a) §24.238(a)	RSS-GEN §6.13 RSS-132 §5.5 RSS-133 §6.5	Out of Band Emissions at Antenna Terminals and Band Edge / Emission mask requirements	Compliant
§2.1053 §22.917(a) §24.238(a)	RSS-GEN §6.13 RSS-132 §5.5 RSS-133 §6.5	Field Strength of Spurious Radiation	Compliant
§24.232(d)	RSS-132 §5.4 RSS-133 §6.4	Peak to Average Ratio	Compliant
§2.1055(a)(1) §22.355 §24.235	RSS-132 §5.3 RSS-133 §6.3	Frequency Stability	Compliant

Unless otherwise stated the results shown in this test report refer only to the sample(s) tested and such sample(s) are retained for 90 days only.

除非另有說明，此報告結果僅對測試之樣品負責，同時此樣品僅保留90天。本報告未經本公司書面許可，不可部份複製。

This document is issued by the Company subject to its General Conditions of Service printed overleaf, available on request or accessible at <http://www.sgs.com.tw/Terms-and-Conditions> and for electronic format documents, subject to Terms and Conditions for Electronic Documents at <http://www.sgs.com.tw/Terms-and-Conditions>. Attention is drawn to the limitation of liability, indemnification and jurisdiction issues defined therein. Any holder of this document is advised that information contained hereon reflects the Company's findings at the time of its intervention only and within the limits of Client's instructions, if any. The Company's sole responsibility is to its Client and this document does not exonerate parties to a transaction from exercising all their rights and obligations under the transaction documents. This document cannot be reproduced except in full, without prior written approval of the Company. Any unauthorized alteration, forgery or falsification of the content or appearance of this document is unlawful and offenders may be prosecuted to the fullest extent of the law.

4 DESCRIPTION OF TEST MODES

4.1 The Worst Test Modes and Channel Details

1. The EUT has been tested under operating condition.
2. Pre-Scan has been conducted to determine the worst-case mode from all possible combinations between available modulations, data rates, X(E1)Y(E2)Z(H) axis and antenna ports. The worst case was found as listed below. Following channel(s) was (were) selected for the final test as listed below:

BAND	H Plane	E1 Plane	E2 Plane
WCDMA/HSPA Band II	V		
WCDMA/HSPA Band V	V		

Unless otherwise stated the results shown in this test report refer only to the sample(s) tested and such sample(s) are retained for 90 days only.

除非另有說明，此報告結果僅對測試之樣品負責，同時此樣品僅保留90天。本報告未經本公司書面許可，不可部份複製。

This document is issued by the Company subject to its General Conditions of Service printed overleaf, available on request or accessible at <http://www.sgs.com.tw/Terms-and-Conditions> and for electronic format documents, subject to Terms and Conditions for Electronic Documents at <http://www.sgs.com.tw/Terms-and-Conditions>. Attention is drawn to the limitation of liability, indemnification and jurisdiction issues defined therein. Any holder of this document is advised that information contained hereon reflects the Company's findings at the time of its intervention only and within the limits of Client's instructions, if any. The Company's sole responsibility is to its Client and this document does not exonerate parties to a transaction from exercising all their rights and obligations under the transaction documents. This document cannot be reproduced except in full, without prior written approval of the Company. Any unauthorized alteration, forgery or falsification of the content or appearance of this document is unlawful and offenders may be prosecuted to the fullest extent of the law.

4.2 Measurement Configuration

Test Items	WCDMA / HSPA Bands	Test Channel		
		L	M	H
ERP	Band V	v	v	v
EIRP	Bnad II	v	v	v
FREQUENCY STABILITY	Bnad II	-	v	-
	Band V	-	v	-
OCCUPIED BANDWIDTH	Bnad II	v	v	v
	Band V	v	v	v
PEAK TO AVERAGE RATIO	Bnad II	v	v	v
	Band V	v	v	v
BAND EDGE	Bnad II	v	-	v
	Band V	v	-	v
CONDCUETED EMISSION	Bnad II	v	v	v
	Band V	v	v	v
RADIATED EMISSION	Bnad II	v	v	v
	Band V	v	v	v

Unless otherwise stated the results shown in this test report refer only to the sample(s) tested and such sample(s) are retained for 90 days only.

除非另有說明，此報告結果僅對測試之樣品負責，同時此樣品僅保留90天。本報告未經本公司書面許可，不可部份複製。

This document is issued by the Company subject to its General Conditions of Service printed overleaf, available on request or accessible at <http://www.sgs.com.tw/Terms-and-Conditions> and for electronic format documents, subject to Terms and Conditions for Electronic Documents at <http://www.sgs.com.tw/Terms-and-Conditions>. Attention is drawn to the limitation of liability, indemnification and jurisdiction issues defined therein. Any holder of this document is advised that information contained hereon reflects the Company's findings at the time of its intervention only and within the limits of Client's instructions, if any. The Company's sole responsibility is to its Client and this document does not exonerate parties to a transaction from exercising all their rights and obligations under the transaction documents. This document cannot be reproduced except in full, without prior written approval of the Company. Any unauthorized alteration, forgery or falsification of the content or appearance of this document is unlawful and offenders may be prosecuted to the fullest extent of the law.

5 MEASUREMENT UNCERTAINTY

Test Items	Uncertainty
RF Power Output	+/- 1 dB
ERP/ EIRP measurement	+/- 3 dB
	+/- 3 dB
Emission Bandwidth	+/- 1.53 Hz
Out of Band Emissions at Antenna Terminals and Band Edge	+/- 1.69 dB
Peak to Average Ratio	+/- 1 dB
Frequency Stability vs. Temperature	+/- 1.53 Hz
Frequency Stability vs. Voltage	+/- 1.53 Hz
Temperature	+/- 0.4 °C
Humidity	+/- 3.5 %
DC / AC Power Source	+/- 1 %

Radiated Spurious Emission Measurement Uncertainty		
Polarization	+/- 2.64 dB	9kHz~30MHz
Polarization: Vertical	+/- 4.93 dB	30MHz - 1000MHz
	+/- 4.81 dB	1GHz - 18GHz
	+/- 4.52 dB	18GHz - 40GHz
	+/- 4.45 dB	30MHz - 1000MHz
Polarization: Horizontal	+/- 4.81 dB	1GHz - 18GHz
	+/- 4.52 dB	18GHz - 40GHz
	+/- 4.52 dB	18GHz - 40GHz

This uncertainty represents an expanded uncertainty expressed at approximately the 95% confidence level using a coverage factor of k=2.

Unless otherwise stated the results shown in this test report refer only to the sample(s) tested and such sample(s) are retained for 90 days only.

除非另有說明，此報告結果僅對測試之樣品負責，同時此樣品僅保留90天。本報告未經本公司書面許可，不可部份複製。

This document is issued by the Company subject to its General Conditions of Service printed overleaf, available on request or accessible at <http://www.sgs.com.tw/Terms-and-Conditions> and for electronic format documents, subject to Terms and Conditions for Electronic Documents at <http://www.sgs.com.tw/Terms-and-Conditions>. Attention is drawn to the limitation of liability, indemnification and jurisdiction issues defined therein. Any holder of this document is advised that information contained hereon reflects the Company's findings at the time of its intervention only and within the limits of Client's instructions, if any. The Company's sole responsibility is to its Client and this document does not exonerate parties to a transaction from exercising all their rights and obligations under the transaction documents. This document cannot be reproduced except in full, without prior written approval of the Company. Any unauthorized alteration, forgery or falsification of the content or appearance of this document is unlawful and offenders may be prosecuted to the fullest extent of the law.

6 MAXMUM OUTPUT POWER

6.1 Standard Applicable

A base station simulator was used to establish communication with the EUT. Its parameters were set to transmit the maximum power on the EUT. The measured power in the radio frequency on the transmitter output terminals.

According to FCC §2.1046

FCC 22.913(a)

(5) mobile transmitters and auxiliary test transmitters must not exceed 7 watts.

FCC 24.232(c)

Mobile and portable stations are limited to 2 W EIRP.

RSS-132 §5.4

The equivalent isotropically radiated power (e.i.r.p.) for mobile equipment in operating in the Bands 824-849 and 869-894MHz shall not exceed 11.5 watts.

RSS-133 §6.4

The equivalent isotropically radiated power (e.i.r.p.) for transmitters shall not exceed the limits given in SRSP-510.

According to section 5.1.2 of SRSP-510, Mobile stations and hand-held portables are limited to 2 watts maximum e.i.r.p. The equipment shall employ means to limit the power to the minimum necessary for successful communication.

Unless otherwise stated the results shown in this test report refer only to the sample(s) tested and such sample(s) are retained for 90 days only.

除非另有說明，此報告結果僅對測試之樣品負責，同時此樣品僅保留90天。本報告未經本公司書面許可，不可部份複製。

This document is issued by the Company subject to its General Conditions of Service printed overleaf, available on request or accessible at <http://www.sgs.com.tw/Terms-and-Conditions> and for electronic format documents, subject to Terms and Conditions for Electronic Documents at <http://www.sgs.com.tw/Terms-and-Conditions>. Attention is drawn to the limitation of liability, indemnification and jurisdiction issues defined therein. Any holder of this document is advised that information contained hereon reflects the Company's findings at the time of its intervention only and within the limits of Client's instructions, if any. The Company's sole responsibility is to its Client and this document does not exonerate parties to a transaction from exercising all their rights and obligations under the transaction documents. This document cannot be reproduced except in full, without prior written approval of the Company. Any unauthorized alteration, forgery or falsification of the content or appearance of this document is unlawful and offenders may be prosecuted to the fullest extent of the law.

6.2 Test Set-up

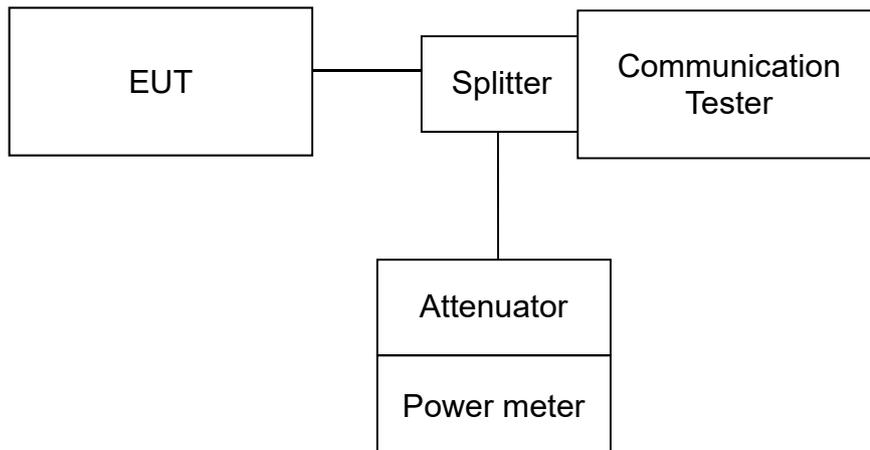

Note: Measurement setup for testing on Antenna connector

6.3 Output Power Measurement Applicable Guidance

The transmitter output was connected to a calibrated attenuator, the other end of which was connected to a power meter.

Transmitter output was read off the power meter in dBm.

The power output at the transmitter antenna port was determined by adding the value of the attenuator to the power meter reading.

The Procedure of KDB941225 (SAR Measurement Procedures for 3G devices, (WCDMA/HSPA) was used for EUT and RMC 12.2kps is used for Base station setting.

KDB 971168 D01 Power Meas License Digital System as the supplemental test methodology to adjust the proper setting obtaining the measurement results.

Conducted average power is obtained from the simulator telecommunication test set.

Unless otherwise stated the results shown in this test report refer only to the sample(s) tested and such sample(s) are retained for 90 days only.

除非另有說明，此報告結果僅對測試之樣品負責，同時此樣品僅保留90天。本報告未經本公司書面許可，不可部份複製。

This document is issued by the Company subject to its General Conditions of Service printed overleaf, available on request or accessible at <http://www.sgs.com.tw/Terms-and-Conditions> and for electronic format documents, subject to Terms and Conditions for Electronic Documents at <http://www.sgs.com.tw/Terms-and-Conditions>. Attention is drawn to the limitation of liability, indemnification and jurisdiction issues defined therein. Any holder of this document is advised that information contained hereon reflects the Company's findings at the time of its intervention only and within the limits of Client's instructions, if any. The Company's sole responsibility is to its Client and this document does not exonerate parties to a transaction from exercising all their rights and obligations under the transaction documents. This document cannot be reproduced except in full, without prior written approval of the Company. Any unauthorized alteration, forgery or falsification of the content or appearance of this document is unlawful and offenders may be prosecuted to the fullest extent of the law.

6.4 Determining ERP and/or EIRP from conducted RF output power measurements

According to KDB 412172 D01 Power Approach,

$$EIRP = P_T + G_T - L_C,$$

$$ERP = EIRP - 2.15,$$

Where:

ERP or EIRP = effective radiated power or equivalent isotropically radiated power (expressed in the same units as P_T , typically dBW, dBm, or power spectral density (PSD)²), relative to either a dipole antenna (ERP) or an isotropic antenna (EIRP);

P_T = transmitter output power, expressed in dBW, dBm, or PSD;

G_T = gain of the transmitting antenna, in dBd (ERP) or dBi (EIRP);

L_C = signal attenuation in the connecting cable between the transmitter and antenna, in dB.

6.5 Measurement Equipment Used

Conducted Emission Test Site: Conducted 4					
EQUIPMENT TYPE	MFR	MODEL NUMBER	SERIAL NUMBER	LAST CAL.	CAL DUE.
Radio Communication Analyser	Anritsu	MT8815B	6200711454	04/07/2021	04/06/2022
Attenuator	Mini-Circuit	BW-S10W2+	4	12/16/2020	12/15/2021
DC Power Supply	Agilent	E3640A	MY40005907	10/29/2020	10/28/2021

Unless otherwise stated the results shown in this test report refer only to the sample(s) tested and such sample(s) are retained for 90 days only.

除非另有說明，此報告結果僅對測試之樣品負責，同時此樣品僅保留90天。本報告未經本公司書面許可，不可部份複製。

This document is issued by the Company subject to its General Conditions of Service printed overleaf, available on request or accessible at <http://www.sgs.com.tw/Terms-and-Conditions> and for electronic format documents, subject to Terms and Conditions for Electronic Documents at <http://www.sgs.com.tw/Terms-and-Conditions>. Attention is drawn to the limitation of liability, indemnification and jurisdiction issues defined therein. Any holder of this document is advised that information contained hereon reflects the Company's findings at the time of its intervention only and within the limits of Client's instructions, if any. The Company's sole responsibility is to its Client and this document does not exonerate parties to a transaction from exercising all their rights and obligations under the transaction documents. This document cannot be reproduced except in full, without prior written approval of the Company. Any unauthorized alteration, forgery or falsification of the content or appearance of this document is unlawful and offenders may be prosecuted to the fullest extent of the law.

6.6 WCDMA & HSPA Measurement Results:

The following tests were completed according to the test requirements outlined in section 5.2 of the 3GPP TS34.121-1 specification. The EUT supports power Class 3, which has a nominal maximum output power of 24 dBm. RMC 12.2kps is used for this testing.

WCDMA/HSUPA/HSDPA Band II Result:

EUT Mode	Freq. (MHz)	CH	Conducted Avg. Power (dBm)	Antenna Gain (dBi)	ERP (dBm)	EIRP (dBm)	Limit (dBm)	Margin (dB)
WCDMA	1852.4	9262	23.75	0.70	22.30	24.45	33.00	-8.55
	1880.0	9400	23.75	0.70	22.30	24.45	33.00	-8.55
	1907.6	9538	23.94	0.70	22.49	24.64	33.00	-8.36
HSDPA	1852.4	9262	23.17	0.70	21.72	23.87	33.00	-9.13
	1880.0	9400	23.21	0.70	21.76	23.91	33.00	-9.09
	1907.6	9538	23.26	0.70	21.81	23.96	33.00	-9.04
HSUPA	1852.4	9262	22.96	0.70	21.51	23.66	33.00	-9.34
	1880.0	9400	23.02	0.70	21.57	23.72	33.00	-9.28
	1907.6	9538	23.08	0.70	21.63	23.78	33.00	-9.22

WCDMA/HSUPA/HSDPA Band V Result:

EUT Mode	Freq. (MHz)	CH	Conducted Avg. Power (dBm)	Antenna Gain (dBi)	ERP (dBm)	EIRP (dBm)	Limit (dBm)	Margin (dB)
WCDMA	826.4	4132	23.67	-2.50	19.02	21.17	38.50	-17.33
	836.6	4183	23.63	-2.50	18.98	21.13	38.50	-17.37
	846.6	4233	23.72	-2.50	19.07	21.22	38.50	-17.28
HSDPA	826.4	4132	22.71	-2.50	18.06	20.21	38.50	-18.29
	836.6	4183	22.69	-2.50	18.04	20.19	38.50	-18.31
	846.6	4233	22.72	-2.50	18.07	20.22	38.50	-18.28
HSUPA	826.4	4132	22.72	-2.50	18.07	20.22	38.50	-18.28
	836.6	4183	22.64	-2.50	17.99	20.14	38.50	-18.36
	846.6	4233	22.65	-2.50	18.00	20.15	38.50	-18.35

Unless otherwise stated the results shown in this test report refer only to the sample(s) tested and such sample(s) are retained for 90 days only.

除非另有說明，此報告結果僅對測試之樣品負責，同時此樣品僅保留90天。本報告未經本公司書面許可，不可部份複製。

This document is issued by the Company subject to its General Conditions of Service printed overleaf, available on request or accessible at <http://www.sgs.com.tw/Terms-and-Conditions> and for electronic format documents, subject to Terms and Conditions for Electronic Documents at <http://www.sgs.com.tw/Terms-and-Conditions>. Attention is drawn to the limitation of liability, indemnification and jurisdiction issues defined therein. Any holder of this document is advised that information contained herein reflects the Company's findings at the time of its intervention only and within the limits of Client's instructions, if any. The Company's sole responsibility is to its Client and this document does not exonerate parties to a transaction from exercising all their rights and obligations under the transaction documents. This document cannot be reproduced except in full, without prior written approval of the Company. Any unauthorized alteration, forgery or falsification of the content or appearance of this document is unlawful and offenders may be prosecuted to the fullest extent of the law.

6.6.1 HSPA (HSDPA & HSUPA) Release 6:

The following 4 Sub-Tests were completed according to the test requirements outlined in section 5.2A of the 3GPP TS34.121-1 specification. All TX RMS power requirements for Power Class 3 were met according to table 5.2AA.5 and 5.2B.5 All UE channels and power ratio's are set according to table C10.1.4 & C11.1.3 in the 3GPP TS34.121-1. RMC 12.2kps is used for this testing.

6.6.2 HSDPA SUB-TEST Setting

Table C.10.1.4: β values for transmitter characteristics tests with HS-DPCCH(FOR HSDPA)

Sub-test	β_c	β_d	β_d (SF)	β_c/β_d	β_{HS} (Note 1, Note 2)	CM (dB) (Note 3)	MPR (dB) (Note 3)	RMC (Kbps)
1	2/15	15/15	64	2/15	4/15	0.0	0.0	12.2
2	12/15 (Note 4)	15/15 (Note 4)	64	12/15 (Note 4)	24/15	1.0	0.0	12.2
3	15/15	8/15	64	15/8	30/15	1.5	0.5	12.2
4	15/15	4/15	64	15/4	30/15	1.5	0.5	12.2

Note: The recommended HSDPA MPRs are implemented as per following sub-tests.

Mode	Sub test	Avg. Power (dBm)		
		Channel		
		9262.00	9400.00	9538.00
HSDPA II	1	23.17	23.21	23.26
	2	23.15	23.15	23.17
	3	22.62	22.68	22.70
	4	22.61	22.87	22.75

Mode	Sub test	Avg. Power (dBm)		
		Channel		
		4132.00	4183.00	4233.00
HSDPA V	1	22.71	22.69	22.72
	2	22.67	22.61	22.62
	3	22.21	22.12	22.19
	4	22.15	22.19	22.29

Unless otherwise stated the results shown in this test report refer only to the sample(s) tested and such sample(s) are retained for 90 days only.

除非另有說明，此報告結果僅對測試之樣品負責，同時此樣品僅保留90天。本報告未經本公司書面許可，不可部份複製。
This document is issued by the Company subject to its General Conditions of Service printed overleaf, available on request or accessible at <http://www.sgs.com.tw/Terms-and-Conditions> and for electronic format documents, subject to Terms and Conditions for Electronic Documents at <http://www.sgs.com.tw/Terms-and-Conditions>. Attention is drawn to the limitation of liability, indemnification and jurisdiction issues defined therein. Any holder of this document is advised that information contained hereon reflects the Company's findings at the time of its intervention only and within the limits of Client's instructions, if any. The Company's sole responsibility is to its Client and this document does not exonerate parties to a transaction from exercising all their rights and obligations under the transaction documents. This document cannot be reproduced except in full, without prior written approval of the Company. Any unauthorized alteration, forgery or falsification of the content or appearance of this document is unlawful and offenders may be prosecuted to the fullest extent of the law.

6.6.3 HSPA SUB-TEST Setting

Table C.11.1.3: β values for transmitter characteristics tests with HS-DPCCH and E-DCH(FOR HSUPA)

Sub-test	β_c	β_d	β_d (SF)	β_c/β_d	β_{HS}	β_{ec}	β_{ed}	β_{ed} (SF)	β_{ed} (Code s)	CM (dB)	MPR (dB)	AG Index	E-TFCI	RMC (Kbps)
1	11/15 (Note 3)	15/15 (Note 3)	64	11/15 (Note 3)	22/15	209/225	1309/225	4	1	1.0	0.0	20	75	12.2
2	6/15	15/15	64	6/15	12/15	12/15	94/75	4	1	3.0	2.0	12	67	12.2
3	15/15	9/15	64	15/9	30/15	30/15	β_{ed1} : 47/15 β_{ed2} : 47/15	4 4	2	2.0	1.0	15	92	12.2
4	2/15	15/15	64	2/15	4/15	2/15	56/75	4	1	3.0	2.0	17	71	12.2
5	15/15 (Note 4)	15/15 (Note 4)	64	15/15 (Note 4)	30/15	24/15	134/15	4	1	1.0	0.0	21	81	12.2

Note: The recommended HSUPA MPRs are implemented as per following sub-tests.

Mode	Sub test	Avg. Power (dBm)		
		Channel		
		9262.00	9400.00	9538.00
HSUPA II	1	22.96	23.02	23.08
	2	22.56	22.62	22.62
	3	23.07	23.07	23.10
	4	23.03	23.10	23.11
	5	23.01	23.09	23.06

Mode	Sub test	Avg. Power (dBm)		
		Channel		
		4132.00	4183.00	4233.00
HSUPA V	1	22.72	22.64	22.65
	2	22.25	22.22	22.24
	3	22.71	22.66	22.71
	4	22.76	22.74	22.73
	5	22.69	22.65	22.65

6.6.4 WCDMA/HSDPA/HSUPA band II, V

The EUT output power was controlled by simulator and enter max rated power 24dBm. The EUT is going to be set to max output power to 24dBm then record the read. The min. power was measures by a function key “minimum power” then record the read. It is -52.3dBm. The power variation can be 0.1dB step by setting.

Unless otherwise stated the results shown in this test report refer only to the sample(s) tested and such sample(s) are retained for 90 days only.

除非另有說明，此報告結果僅對測試之樣品負責，同時此樣品僅保留90天。本報告未經本公司書面許可，不可部份複製。

This document is issued by the Company subject to its General Conditions of Service printed overleaf, available on request or accessible at <http://www.sgs.com.tw/Terms-and-Conditions> and for electronic format documents, subject to Terms and Conditions for Electronic Documents at <http://www.sgs.com.tw/Terms-and-Conditions>. Attention is drawn to the limitation of liability, indemnification and jurisdiction issues defined therein. Any holder of this document is advised that information contained hereon reflects the Company's findings at the time of its intervention only and within the limits of Client's instructions, if any. The Company's sole responsibility is to its Client and this document does not exonerate parties to a transaction from exercising all their rights and obligations under the transaction documents. This document cannot be reproduced except in full, without prior written approval of the Company. Any unauthorized alteration, forgery or falsification of the content or appearance of this document is unlawful and offenders may be prosecuted to the fullest extent of the law.

7 OCCUPIED BANDWIDTH MEASUREMENT

7.1 Standard Applicable

The occupied bandwidth is the frequency bandwidth such that, below its lower and above its upper frequency limits, the mean powers radiated are each equal to 0.5 percent of the total mean power.

7.2 Test Set-up

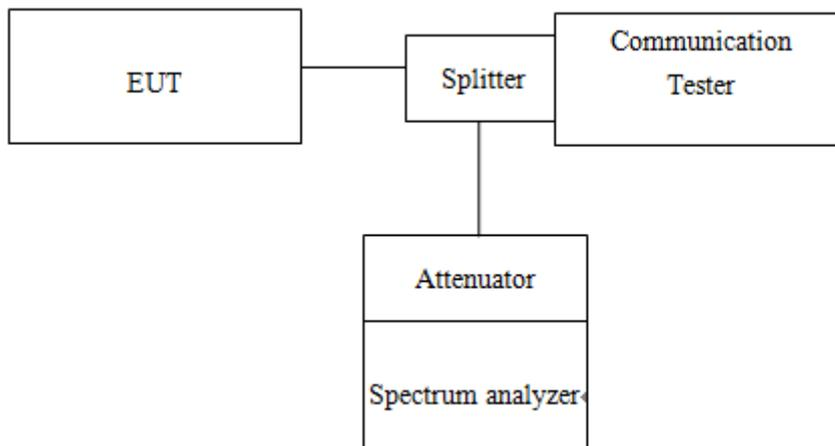

7.3 Measurement Procedure

99% & 26dB Bandwidth with detector peak

The EUT's output RF connector was connected with a short cable to the spectrum analyzer, RBW was set to about 1% of emission BW, VBW= 3 times RBW, -26dBc display line was placed on the screen (or 26dB bandwidth), the occupied bandwidth is the delta frequency between the two points where the display line intersects the signal trace. Then set RBW to 99% bandwidth, RBW= 1%, VBW= 3 * RBW, with span > 2 * Signal BW, set % Power = 99%.

99% Bandwidth with detector sample

The EUT's output RF connector was connected with a short cable to the spectrum analyzer, RBW was set to about 1% ~ 5% of emission BW, VBW= 3 times RBW. Set RBW= 1% ~ 5%, VBW= 3 * RBW, with span > 2 * Signal BW, set % Power = 99%.

Unless otherwise stated the results shown in this test report refer only to the sample(s) tested and such sample(s) are retained for 90 days only.

除非另有說明，此報告結果僅對測試之樣品負責，同時此樣品僅保留90天。本報告未經本公司書面許可，不可部份複製。

This document is issued by the Company subject to its General Conditions of Service printed overleaf, available on request or accessible at <http://www.sgs.com.tw/Terms-and-Conditions> and for electronic format documents, subject to Terms and Conditions for Electronic Documents at <http://www.sgs.com.tw/Terms-and-Conditions>. Attention is drawn to the limitation of liability, indemnification and jurisdiction issues defined therein. Any holder of this document is advised that information contained hereon reflects the Company's findings at the time of its intervention only and within the limits of Client's instructions, if any. The Company's sole responsibility is to its Client and this document does not exonerate parties to a transaction from exercising all their rights and obligations under the transaction documents. This document cannot be reproduced except in full, without prior written approval of the Company. Any unauthorized alteration, forgery or falsification of the content or appearance of this document is unlawful and offenders may be prosecuted to the fullest extent of the law.

7.4 Measurement Equipment Used

Conducted Emission Test Site: Conducted 4					
EQUIPMENT TYPE	MFR	MODEL NUMBER	SERIAL NUMBER	LAST CAL.	CAL DUE.
PXA Spectrum Analyzer	Agilent	N9030A	MY53120760	04/27/2021	04/26/2022
Radio Communication Analyzer	Anritsu	MT8815B	6200711454	04/07/2021	04/06/2022
Test Software	WORLD-PALLAS TECH. CO., LTD.	Dr.E	Ver. 3.0	N.C.R	N.C.R
Temperature Chamber	Giant Force	GTH-150-40-CP-AR	MAA0512-018	05/19/2021	05/18/2022
Attenuator	Mini-Circuit	BW-S10W2+	4	12/16/2020	12/15/2021
DC Block	Mini-Circuits	BLK-18-S+	1	12/16/2020	12/15/2021
Power Divider	RF-LAM-BAD	RFLT2W1G18G	11-JSPF412-017	12/16/2020	12/15/2021
DC Power Supply	Agilent	E3640A	MY40005907	10/29/2020	10/28/2021

7.5 Measurement Result

Freq. (MHz)	CH	99% BW (MHz)			26 dB BW (MHz)		
		WCDMA II	HSDPA II	HSUPA II	WCDMA II	HSDPA II	HSUPA II
1852.40	9262	4.11780	4.11360	4.11140	4.695	4.667	4.667
1880.00	9400	4.10950	4.11770	4.11520	4.694	4.681	4.666
1907.60	9538	4.12630	4.10940	4.10960	4.686	4.656	4.671

Freq. (MHz)	CH	99% BW (MHz)			26 dB BW (MHz)		
		WCDMA V	HSDPA V	HSUPA V	WCDMA V	HSDPA V	HSUPA V
826.40	4132	4.12680	4.12410	4.12290	4.681	4.683	4.688
836.60	4183	4.11800	4.11540	4.11280	4.691	4.670	4.660
846.60	4233	4.11750	4.10400	4.11560	4.663	4.677	4.652

Unless otherwise stated the results shown in this test report refer only to the sample(s) tested and such sample(s) are retained for 90 days only.

除非另有說明，此報告結果僅對測試之樣品負責，同時此樣品僅保留90天。本報告未經本公司書面許可，不可部份複製。

This document is issued by the Company subject to its General Conditions of Service printed overleaf, available on request or accessible at <http://www.sgs.com.tw/Terms-and-Conditions> and for electronic format documents, subject to Terms and Conditions for Electronic Documents at <http://www.sgs.com.tw/Terms-and-Conditions>. Attention is drawn to the limitation of liability, indemnification and jurisdiction issues defined therein. Any holder of this document is advised that information contained hereon reflects the Company's findings at the time of its intervention only and within the limits of Client's instructions, if any. The Company's sole responsibility is to its Client and this document does not exonerate parties to a transaction from exercising all their rights and obligations under the transaction documents. This document cannot be reproduced except in full, without prior written approval of the Company. Any unauthorized alteration, forgery or falsification of the content or appearance of this document is unlawful and offenders may be prosecuted to the fullest extent of the law.

WCDMA_B2_HighCH9538-1907.6

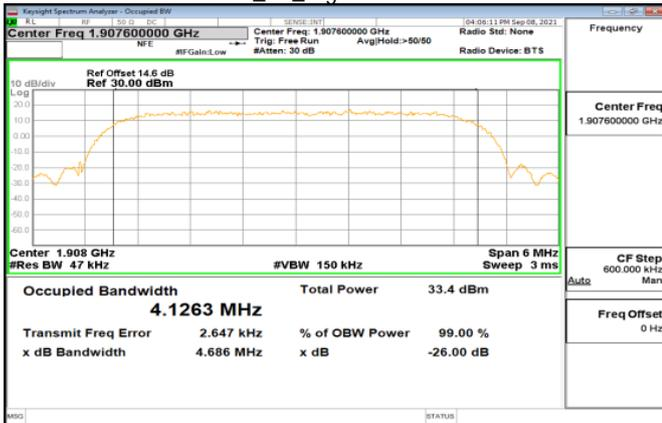

HSDPA_B2_HighCH9538-1907.6

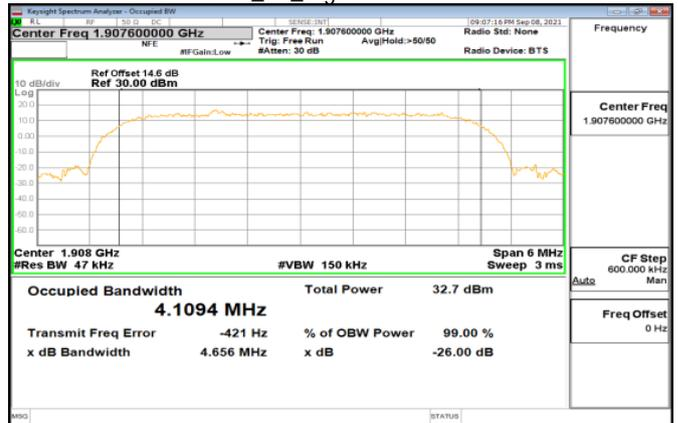

WCDMA_B2_LowCH9262-1852.4

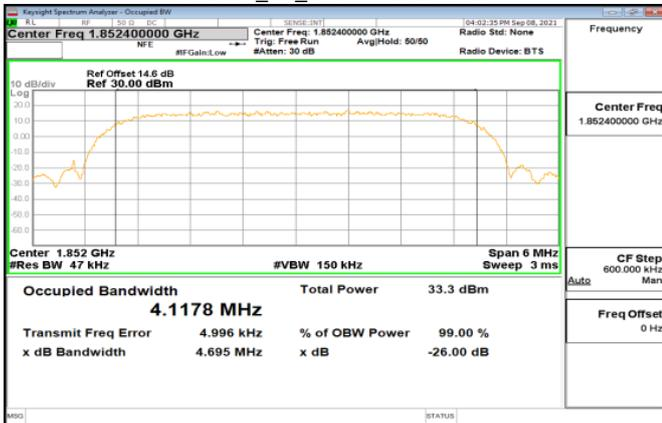

HSDPA_B2_LowCH9262-1852.4

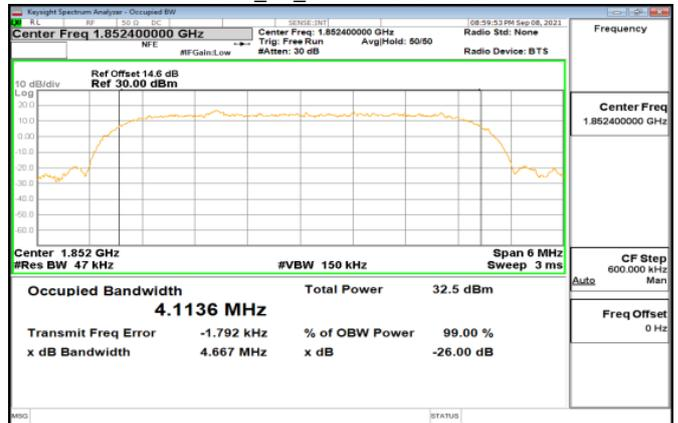

WCDMA_B2_MidCH9400-1880

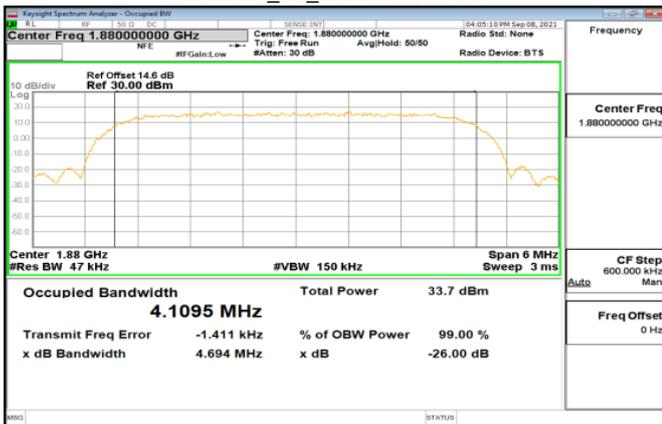

HSDPA_B2_MidCH9400-1880

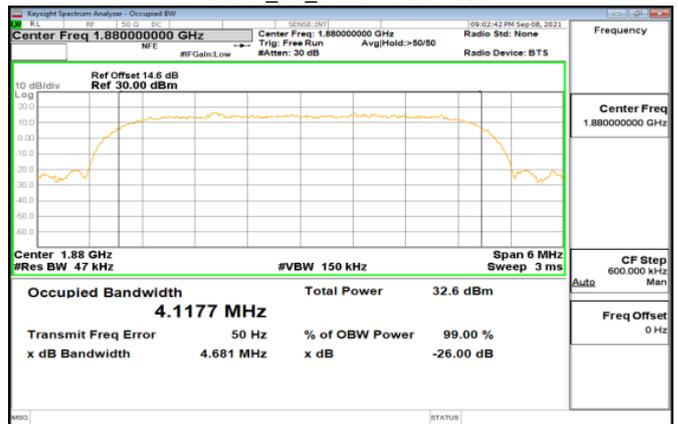

Unless otherwise stated the results shown in this test report refer only to the sample(s) tested and such sample(s) are retained for 90 days only.

除非另有說明，此報告結果僅對測試之樣品負責，同時此樣品僅保留90天。本報告未經本公司書面許可，不可部份複製。

This document is issued by the Company subject to its General Conditions of Service printed overleaf, available on request or accessible at <http://www.sgs.com.tw/Terms-and-Conditions> and for electronic format documents, subject to Terms and Conditions for Electronic Documents at <http://www.sgs.com.tw/Terms-and-Conditions>. Attention is drawn to the limitation of liability, indemnification and jurisdiction issues defined therein. Any holder of this document is advised that information contained herein reflects the Company's findings at the time of its intervention only and within the limits of Client's instructions, if any. The Company's sole responsibility is to its Client and this document does not exonerate parties to a transaction from exercising all their rights and obligations under the transaction documents. This document cannot be reproduced except in full, without prior written approval of the Company. Any unauthorized alteration, forgery or falsification of the content or appearance of this document is unlawful and offenders may be prosecuted to the fullest extent of the law.

HSUPA_B2_HighCH9538-1907.6

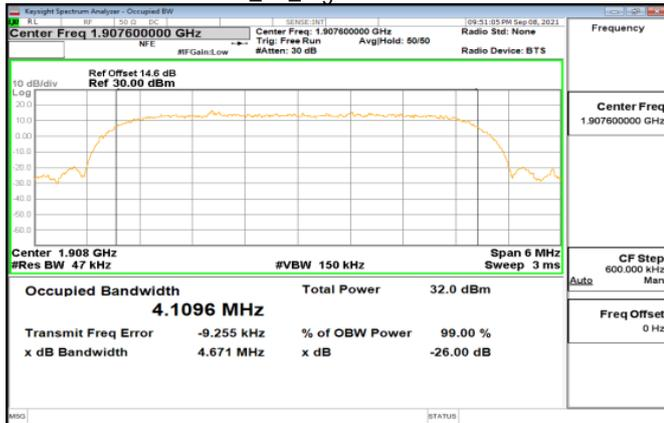

WCDMA_B5_HighCH4233-846.6

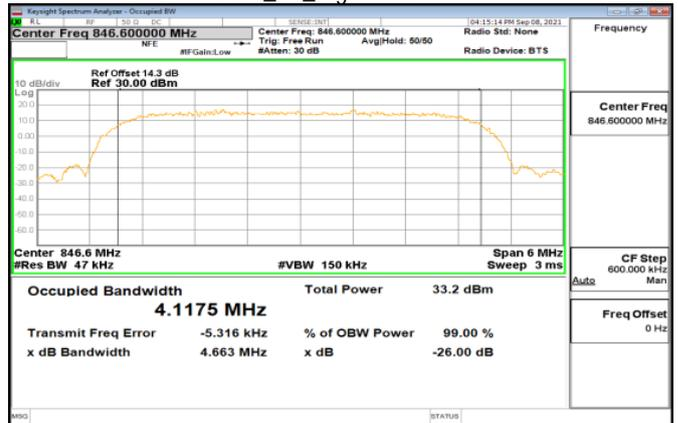

HSUPA_B2_LowCH9262-1852.4

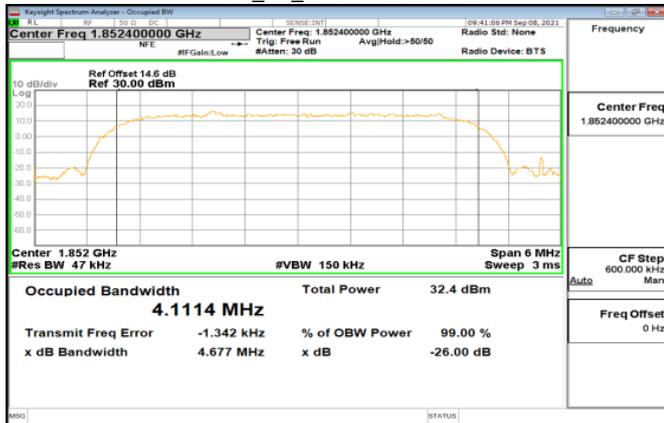

WCDMA_B5_LowCH4132-826.4

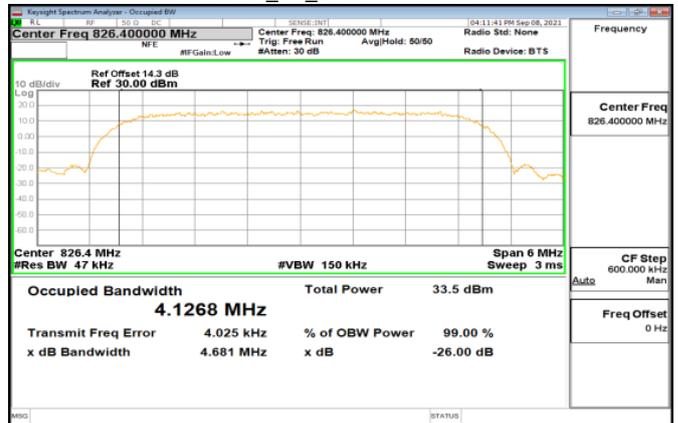

HSUPA_B2_MidCH9400-1880

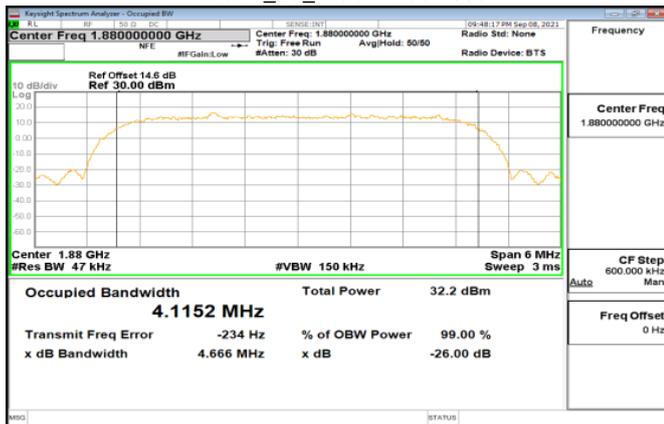

WCDMA_B5_MidCH4183-836.6

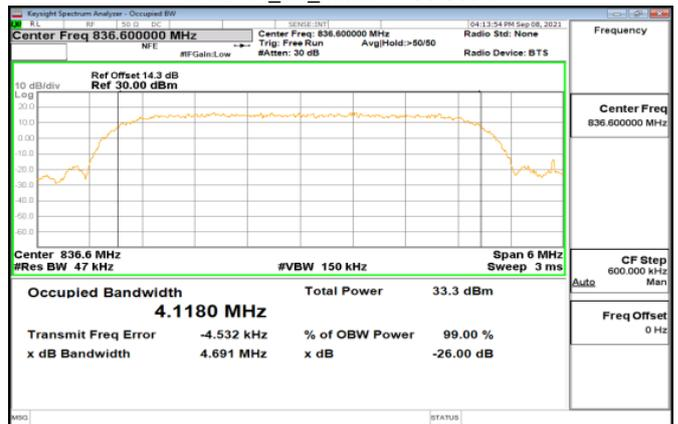

Unless otherwise stated the results shown in this test report refer only to the sample(s) tested and such sample(s) are retained for 90 days only.

除非另有說明，此報告結果僅對測試之樣品負責，同時此樣品僅保留90天。本報告未經本公司書面許可，不可部份複製。

This document is issued by the Company subject to its General Conditions of Service printed overleaf, available on request or accessible at <http://www.sgs.com.tw/Terms-and-Conditions> and for electronic format documents, subject to Terms and Conditions for Electronic Documents at <http://www.sgs.com.tw/Terms-and-Conditions>. Attention is drawn to the limitation of liability, indemnification and jurisdiction issues defined therein. Any holder of this document is advised that information contained herein reflects the Company's findings at the time of its intervention only and within the limits of Client's instructions, if any. The Company's sole responsibility is to its Client and this document does not exonerate parties to a transaction from exercising all their rights and obligations under the transaction documents. This document cannot be reproduced except in full, without prior written approval of the Company. Any unauthorized alteration, forgery or falsification of the content or appearance of this document is unlawful and offenders may be prosecuted to the fullest extent of the law.

HSDPA_B5_HighCH4233-846.6

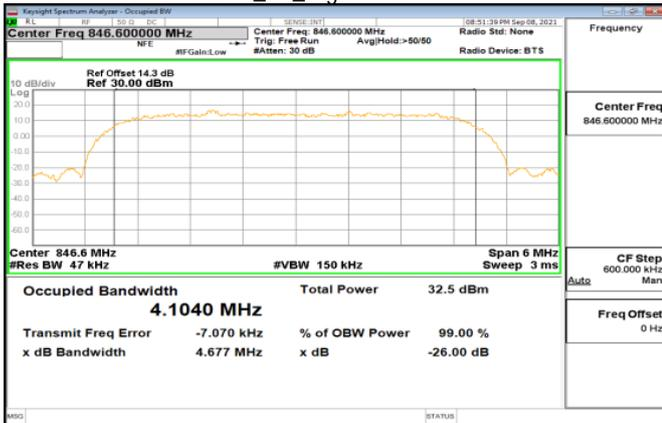

HSUPA_B5_HighCH4233-846.6

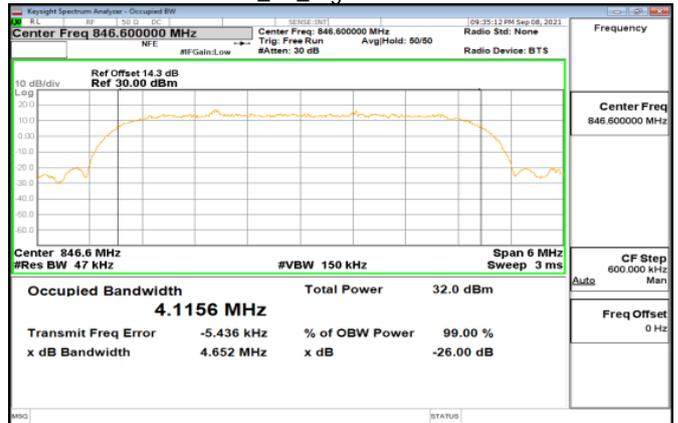

HSDPA_B5_LowCH4132-826.4

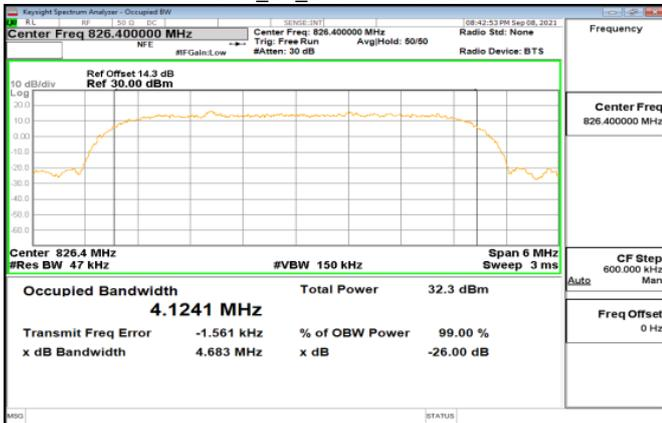

HSUPA_B5_LowCH4132-826.4

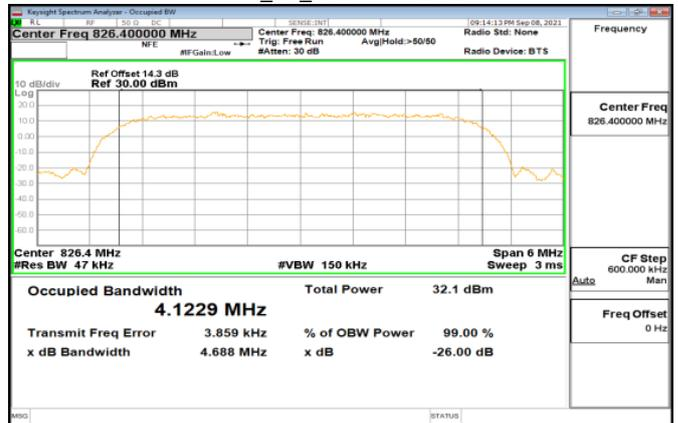

HSDPA_B5_MidCH4183-836.6

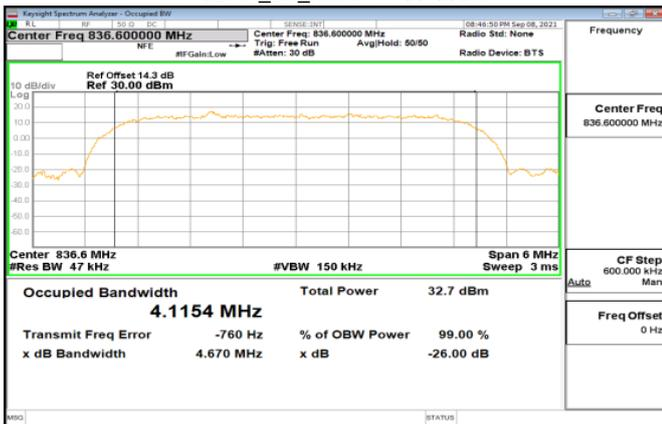

HSUPA_B5_MidCH4183-836.6

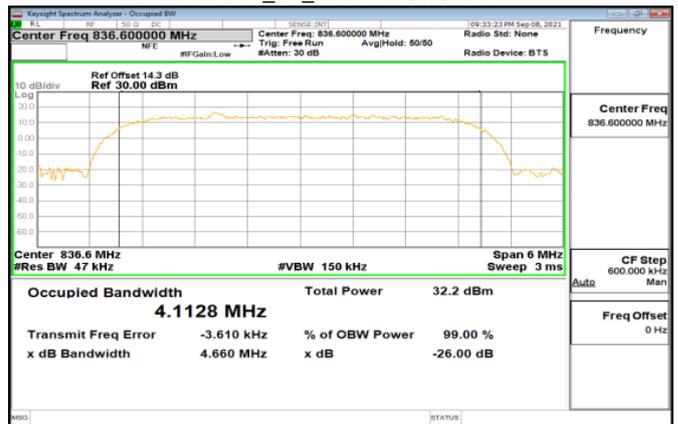

Unless otherwise stated the results shown in this test report refer only to the sample(s) tested and such sample(s) are retained for 90 days only.

除非另有說明，此報告結果僅對測試之樣品負責，同時此樣品僅保留90天。本報告未經本公司書面許可，不可部份複製。

This document is issued by the Company subject to its General Conditions of Service printed overleaf, available on request or accessible at <http://www.sgs.com.tw/Terms-and-Conditions> and for electronic format documents, subject to Terms and Conditions for Electronic Documents at <http://www.sgs.com.tw/Terms-and-Conditions>. Attention is drawn to the limitation of liability, indemnification and jurisdiction issues defined therein. Any holder of this document is advised that information contained herein reflects the Company's findings at the time of its intervention only and within the limits of Client's instructions, if any. The Company's sole responsibility is to its Client and this document does not exonerate parties to a transaction from exercising all their rights and obligations under the transaction documents. This document cannot be reproduced except in full, without prior written approval of the Company. Any unauthorized alteration, forgery or falsification of the content or appearance of this document is unlawful and offenders may be prosecuted to the fullest extent of the law.

8 OUT OF BAND EMISSION AT ANTENNA TERMINALS

8.1 Standard Applicable

FCC §22.917(a), §24.238(a), and RSS-132 §5.5, RSS-133 §6.5.1

Out of band emissions. The power of any emission outside of the authorized operating frequency ranges must be attenuated below the transmitting power (P) by a factor of at least $43 + 10 \log(P)$ dB.

8.2 Test SET-UP

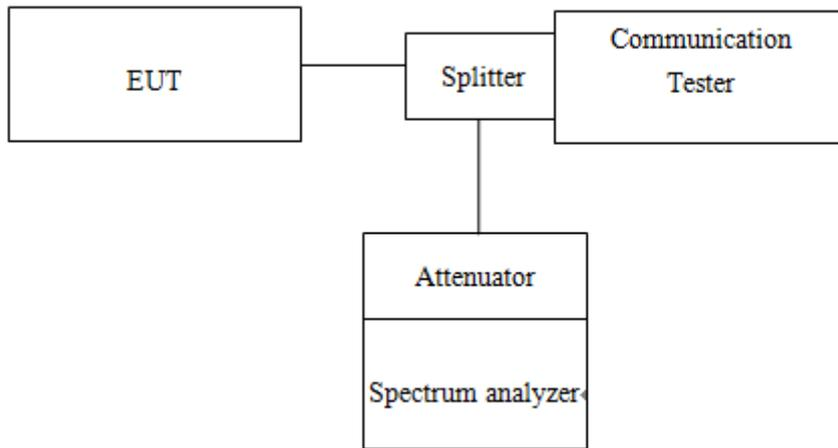

8.3 Measurement Procedure

8.3.1 Conducted Emission

The RF output of the transceiver was connected to a spectrum analyzer through appropriate attenuation. The resolution bandwidth of the spectrum analyzer was set at 1MHz, sufficient scans were taken to show the out of band Emissions if any up to 10th harmonic.

1. To connect Antenna Port of EUT to Spectrum.
2. Set RBW = 1MHz & VBW = 1MHz on Spectrum.
3. Allow trace to fully stabilize
4. Repeat above procedures until all default test channel measured were complete.

8.3.2 Band Edge

1. To connect Antenna Port of EUT to Spectrum.
2. The band edge of low and high channels for the highest RF powers was measured. Setting $RBW \geq 1\% EBW$.
3. Allow trace to fully stabilize
4. Repeat above procedures until all default test channel measured were complete.

Unless otherwise stated the results shown in this test report refer only to the sample(s) tested and such sample(s) are retained for 90 days only.

除非另有說明，此報告結果僅對測試之樣品負責，同時此樣品僅保留90天。本報告未經本公司書面許可，不可部份複製。

This document is issued by the Company subject to its General Conditions of Service printed overleaf, available on request or accessible at <http://www.sgs.com.tw/Terms-and-Conditions> and for electronic format documents, subject to Terms and Conditions for Electronic Documents at <http://www.sgs.com.tw/Terms-and-Conditions>. Attention is drawn to the limitation of liability, indemnification and jurisdiction issues defined therein. Any holder of this document is advised that information contained hereon reflects the Company's findings at the time of its intervention only and within the limits of Client's instructions, if any. The Company's sole responsibility is to its Client and this document does not exonerate parties to a transaction from exercising all their rights and obligations under the transaction documents. This document cannot be reproduced except in full, without prior written approval of the Company. Any unauthorized alteration, forgery or falsification of the content or appearance of this document is unlawful and offenders may be prosecuted to the fullest extent of the law.

8.4 Measurement Equipment Used

Conducted Emission Test Site: Conducted 4					
EQUIPMENT TYPE	MFR	MODEL NUMBER	SERIAL NUMBER	LAST CAL.	CAL DUE.
PXA Spectrum Analyzer	Agilent	N9030A	MY53120760	04/27/2021	04/26/2022
Radio Communication Analyzer	Anritsu	MT8815B	6200711454	04/07/2021	04/06/2022
Test Software	WORLD-PALLAS TECH. CO., LTD.	Dr.E	Ver. 3.0	N.C.R	N.C.R
Temperature Chamber	Giant Force	GTH-150-40-CP-AR	MAA0512-018	05/19/2021	05/18/2022
Attenuator	Mini-Circuit	BW-S10W2+	4	12/16/2020	12/15/2021
DC Block	Mini-Circuits	BLK-18-S+	1	12/16/2020	12/15/2021
Power Divider	RF-LAM-BAD	RFLT2W1G18G	11-JSPF412-017	12/16/2020	12/15/2021
DC Power Supply	Agilent	E3640A	MY40005907	10/29/2020	10/28/2021

8.5 Measurement Result:

Refer to next pages.

Unless otherwise stated the results shown in this test report refer only to the sample(s) tested and such sample(s) are retained for 90 days only.

除非另有說明，此報告結果僅對測試之樣品負責，同時此樣品僅保留90天。本報告未經本公司書面許可，不可部份複製。

This document is issued by the Company subject to its General Conditions of Service printed overleaf, available on request or accessible at <http://www.sgs.com.tw/Terms-and-Conditions> and for electronic format documents, subject to Terms and Conditions for Electronic Documents at <http://www.sgs.com.tw/Terms-and-Conditions>. Attention is drawn to the limitation of liability, indemnification and jurisdiction issues defined therein. Any holder of this document is advised that information contained hereon reflects the Company's findings at the time of its intervention only and within the limits of Client's instructions, if any. The Company's sole responsibility is to its Client and this document does not exonerate parties to a transaction from exercising all their rights and obligations under the transaction documents. This document cannot be reproduced except in full, without prior written approval of the Company. Any unauthorized alteration, forgery or falsification of the content or appearance of this document is unlawful and offenders may be prosecuted to the fullest extent of the law.

Band Edge WCDMA_B2_LowCH9262-1852.4



Band Edge HSDPA_B2_HighCH9538-1907.6



Band Edge WCDMA_B2_HighCH9538-1907.6



Band Edge HSUPA_B2_LowCH9262-1852.4

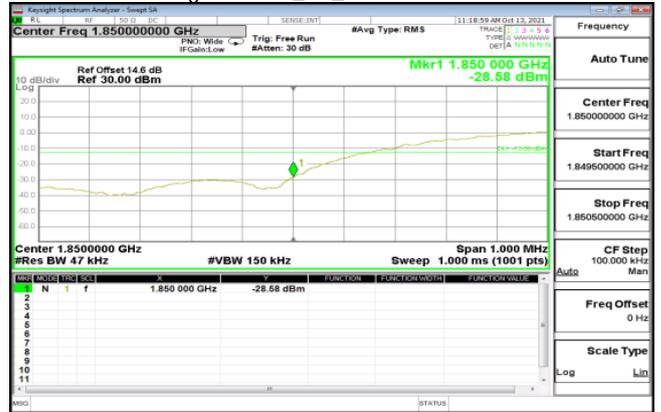

Band Edge HSDPA_B2_LowCH9262-1852.4



Band Edge HSUPA_B2_HighCH9538-1907.6

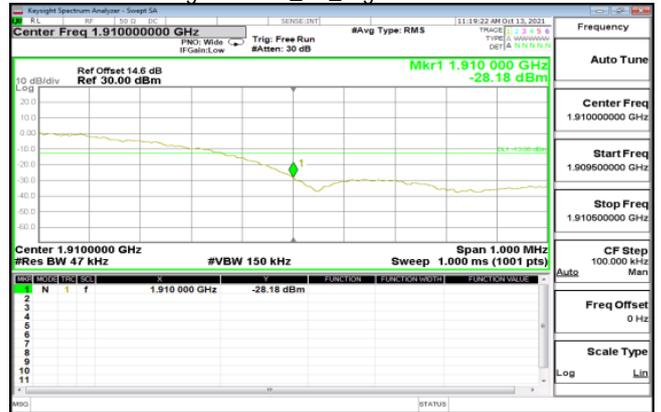

Unless otherwise stated the results shown in this test report refer only to the sample(s) tested and such sample(s) are retained for 90 days only.

除非另有說明，此報告結果僅對測試之樣品負責，同時此樣品僅保留90天。本報告未經本公司書面許可，不可部份複製。

This document is issued by the Company subject to its General Conditions of Service printed overleaf, available on request or accessible at <http://www.sgs.com.tw/Terms-and-Conditions> and for electronic format documents, subject to Terms and Conditions for Electronic Documents at <http://www.sgs.com.tw/Terms-and-Conditions>. Attention is drawn to the limitation of liability, indemnification and jurisdiction issues defined therein. Any holder of this document is advised that information contained herein reflects the Company's findings at the time of its intervention only and within the limits of Client's instructions, if any. The Company's sole responsibility is to its Client and this document does not exonerate parties to a transaction from exercising all their rights and obligations under the transaction documents. This document cannot be reproduced except in full, without prior written approval of the Company. Any unauthorized alteration, forgery or falsification of the content or appearance of this document is unlawful and offenders may be prosecuted to the fullest extent of the law.

Band Edge WCDMA_B5_LowCH4132-826.4



Band Edge HSDPA_B5_HighCH4233-846.6



Band Edge WCDMA_B5_HighCH4233-846.6

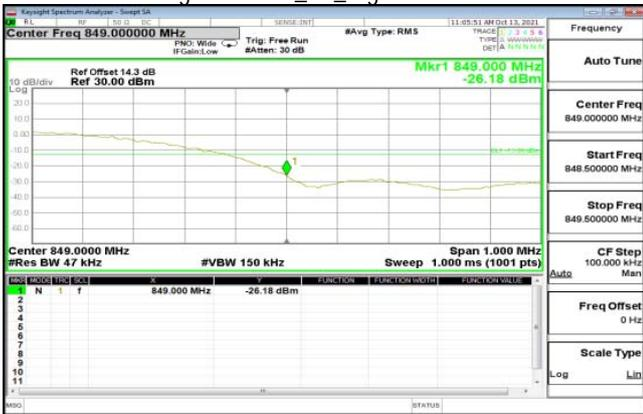

Band Edge HSUPA_B5_LowCH4132-826.4



Band Edge HSDPA_B5_LowCH4132-826.4



Band Edge HSUPA_B5_HighCH4233-846.6

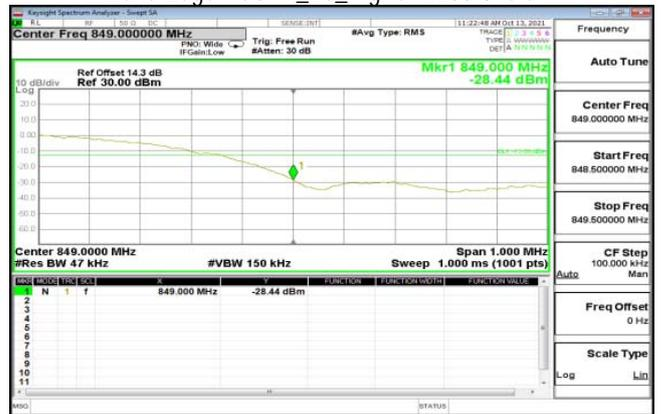

Unless otherwise stated the results shown in this test report refer only to the sample(s) tested and such sample(s) are retained for 90 days only.

除非另有說明，此報告結果僅對測試之樣品負責，同時此樣品僅保留90天。本報告未經本公司書面許可，不可部份複製。

This document is issued by the Company subject to its General Conditions of Service printed overleaf, available on request or accessible at <http://www.sgs.com.tw/Terms-and-Conditions> and for electronic format documents, subject to Terms and Conditions for Electronic Documents at <http://www.sgs.com.tw/Terms-and-Conditions>. Attention is drawn to the limitation of liability, indemnification and jurisdiction issues defined therein. Any holder of this document is advised that information contained herein reflects the Company's findings at the time of its intervention only and within the limits of Client's instructions, if any. The Company's sole responsibility is to its Client and this document does not exonerate parties to a transaction from exercising all their rights and obligations under the transaction documents. This document cannot be reproduced except in full, without prior written approval of the Company. Any unauthorized alteration, forgery or falsification of the content or appearance of this document is unlawful and offenders may be prosecuted to the fullest extent of the law.

WCDMA_B2_LowCH9262-1852.4



HSDPA_B2_LowCH9262-1852.4

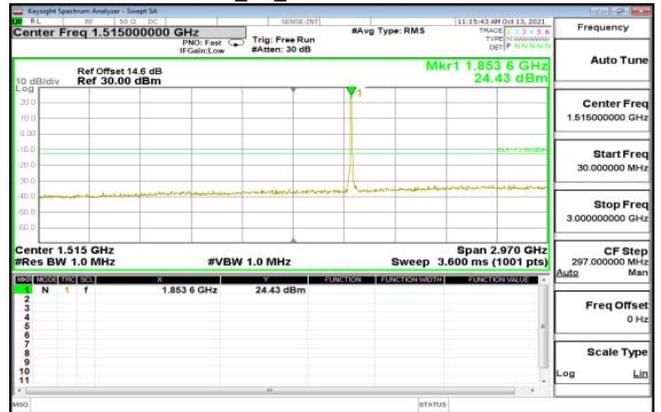

WCDMA_B2_MidCH9400-1880

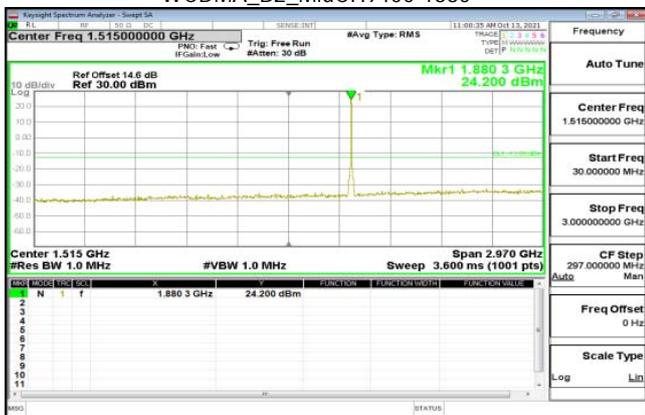

HSDPA_B2_MidCH9400-1880



WCDMA_B2_HighCH9538-1907.6

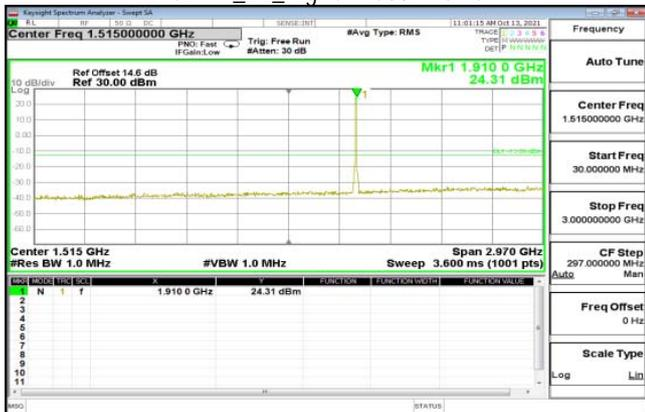

HSDPA_B2_HighCH9538-1907.6

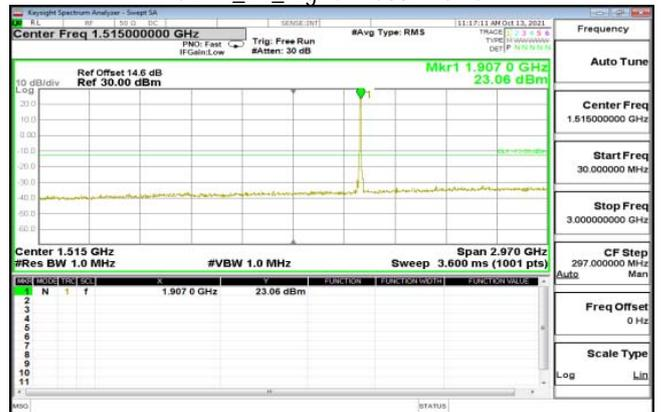

Unless otherwise stated the results shown in this test report refer only to the sample(s) tested and such sample(s) are retained for 90 days only.

除非另有說明，此報告結果僅對測試之樣品負責，同時此樣品僅保留90天。本報告未經本公司書面許可，不可部份複製。

This document is issued by the Company subject to its General Conditions of Service printed overleaf, available on request or accessible at <http://www.sgs.com.tw/Terms-and-Conditions> and for electronic format documents, subject to Terms and Conditions for Electronic Documents at <http://www.sgs.com.tw/Terms-and-Conditions>. Attention is drawn to the limitation of liability, indemnification and jurisdiction issues defined therein. Any holder of this document is advised that information contained herein reflects the Company's findings at the time of its intervention only and within the limits of Client's instructions, if any. The Company's sole responsibility is to its Client and this document does not exonerate parties to a transaction from exercising all their rights and obligations under the transaction documents. This document cannot be reproduced except in full, without prior written approval of the Company. Any unauthorized alteration, forgery or falsification of the content or appearance of this document is unlawful and offenders may be prosecuted to the fullest extent of the law.

HSUPA_B2_LowCH9262-1852.4



WCDMA_B5_LowCH4132-826.4

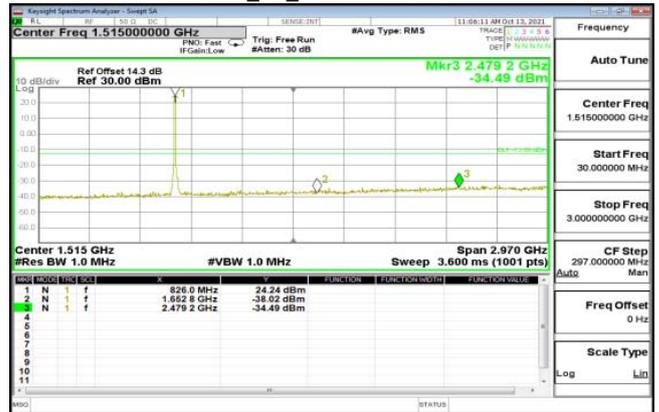

HSUPA_B2_MidCH9400-1880

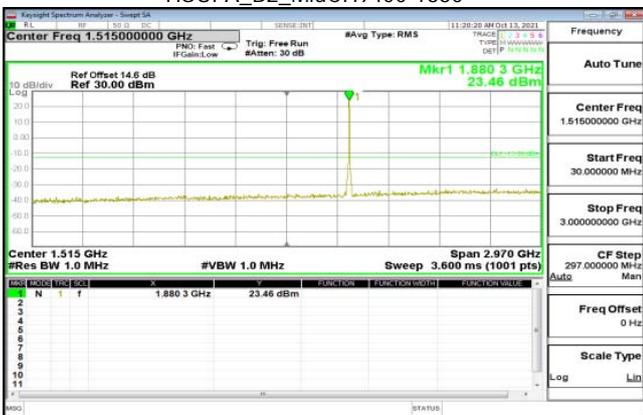

WCDMA_B5_MidCH4183-836.6

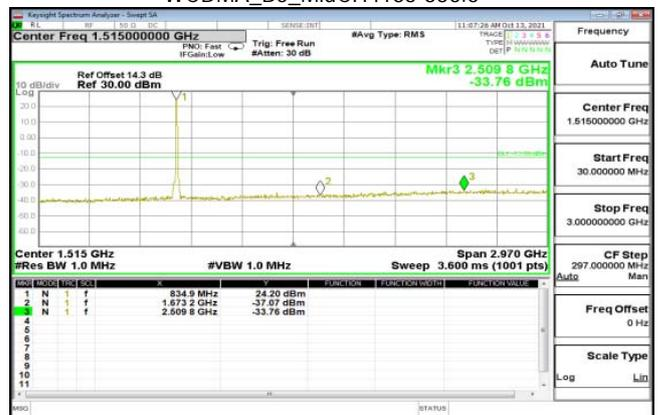

HSUPA_B2_HighCH9538-1907.6

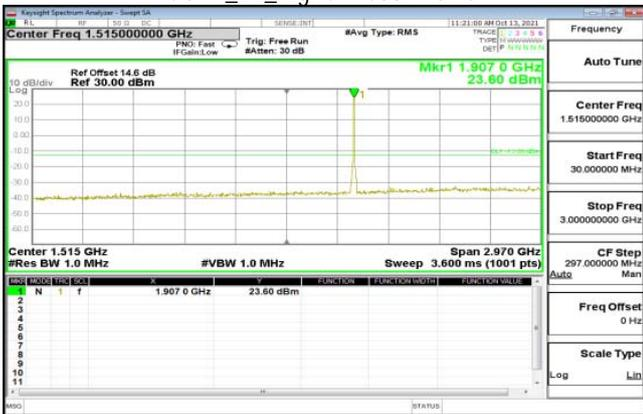

WCDMA_B5_HighCH4233-846.6



Unless otherwise stated the results shown in this test report refer only to the sample(s) tested and such sample(s) are retained for 90 days only.

除非另有說明，此報告結果僅對測試之樣品負責，同時此樣品僅保留90天。本報告未經本公司書面許可，不可部份複製。

This document is issued by the Company subject to its General Conditions of Service printed overleaf, available on request or accessible at <http://www.sgs.com.tw/Terms-and-Conditions> and for electronic format documents, subject to Terms and Conditions for Electronic Documents at <http://www.sgs.com.tw/Terms-and-Conditions>. Attention is drawn to the limitation of liability, indemnification and jurisdiction issues defined therein. Any holder of this document is advised that information contained herein reflects the Company's findings at the time of its intervention only and within the limits of Client's instructions, if any. The Company's sole responsibility is to its Client and this document does not exonerate parties to a transaction from exercising all their rights and obligations under the transaction documents. This document cannot be reproduced except in full, without prior written approval of the Company. Any unauthorized alteration, forgery or falsification of the content or appearance of this document is unlawful and offenders may be prosecuted to the fullest extent of the law.

HSDPA_B5_LowCH4132-826.4



HSUPA_B5_LowCH4132-826.4



HSDPA_B5_MidCH4183-836.6



HSUPA_B5_MidCH4183-836.6



HSDPA_B5_HighCH4233-846.6



HSUPA_B5_HighCH4233-846.6



Unless otherwise stated the results shown in this test report refer only to the sample(s) tested and such sample(s) are retained for 90 days only.

除另有說明，此報告結果僅對測試之樣品負責，同時此樣品僅保留90天。本報告未經本公司書面許可，不可部份複製。

This document is issued by the Company subject to its General Conditions of Service printed overleaf, available on request or accessible at <http://www.sgs.com.tw/Terms-and-Conditions> and for electronic format documents, subject to Terms and Conditions for Electronic Documents at <http://www.sgs.com.tw/Terms-and-Conditions>. Attention is drawn to the limitation of liability, indemnification and jurisdiction issues defined therein. Any holder of this document is advised that information contained herein reflects the Company's findings at the time of its intervention only and within the limits of Client's instructions, if any. The Company's sole responsibility is to its Client and this document does not exonerate parties to a transaction from exercising all their rights and obligations under the transaction documents. This document cannot be reproduced except in full, without prior written approval of the Company. Any unauthorized alteration, forgery or falsification of the content or appearance of this document is unlawful and offenders may be prosecuted to the fullest extent of the law.

WCDMA_B2_LowCH9262-1852.4

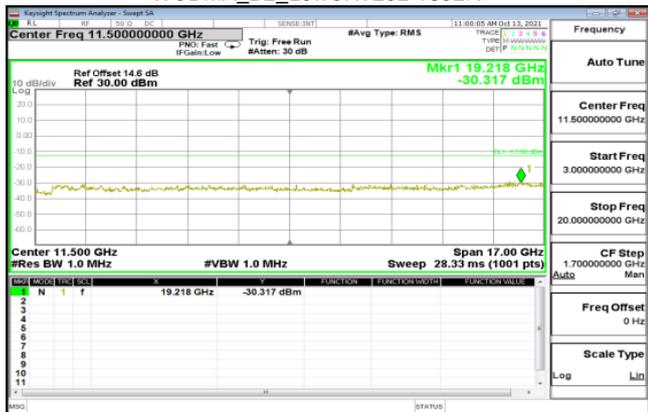

HSDPA_B2_LowCH9262-1852.4



WCDMA_B2_MidCH9400-1880

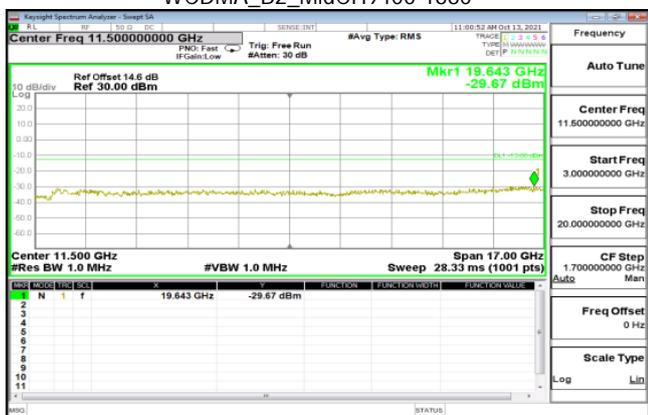

HSDPA_B2_MidCH9400-1880

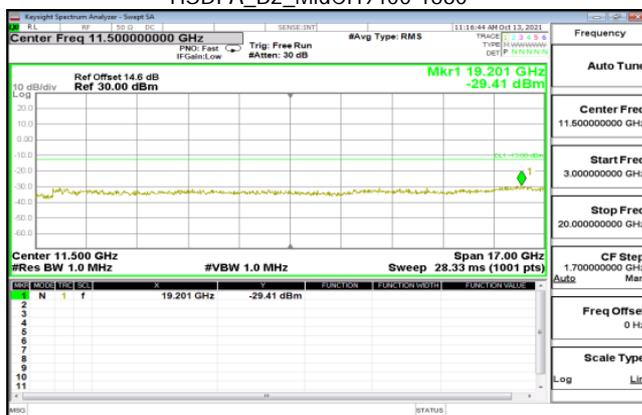

WCDMA_B2_HighCH9538-1907.6

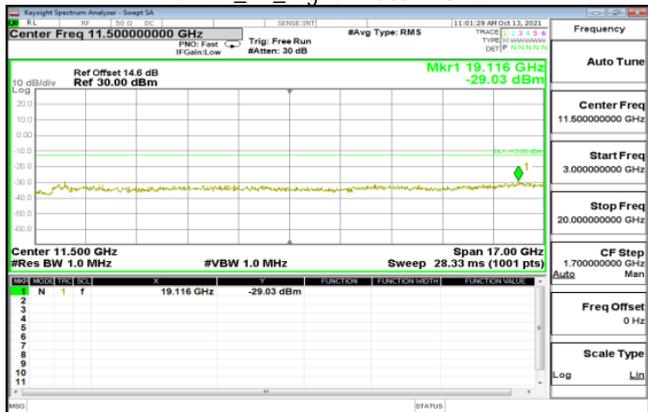

HSDPA_B2_HighCH9538-1907.6

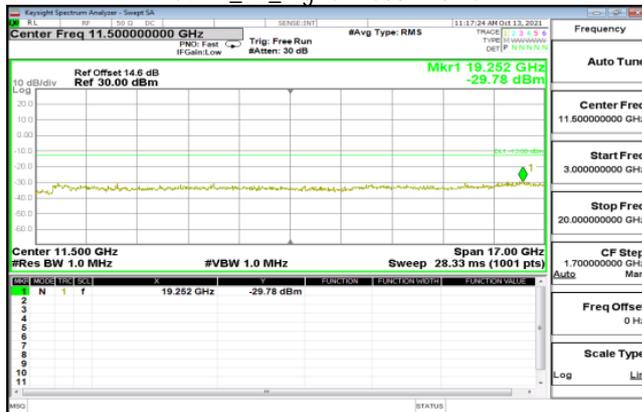

Unless otherwise stated the results shown in this test report refer only to the sample(s) tested and such sample(s) are retained for 90 days only.

除非另有說明，此報告結果僅對測試之樣品負責，同時此樣品僅保留90天。本報告未經本公司書面許可，不可部份複製。
This document is issued by the Company subject to its General Conditions of Service printed overleaf, available on request or accessible at <http://www.sgs.com.tw/Terms-and-Conditions> and for electronic format documents, subject to Terms and Conditions for Electronic Documents at <http://www.sgs.com.tw/Terms-and-Conditions>. Attention is drawn to the limitation of liability, indemnification and jurisdiction issues defined therein. Any holder of this document is advised that information contained herein reflects the Company's findings at the time of its intervention only and within the limits of Client's instructions, if any. The Company's sole responsibility is to its Client and this document does not exonerate parties to a transaction from exercising all their rights and obligations under the transaction documents. This document cannot be reproduced except in full, without prior written approval of the Company. Any unauthorized alteration, forgery or falsification of the content or appearance of this document is unlawful and offenders may be prosecuted to the fullest extent of the law.

HSUPA_B2_LowCH9262-1852.4



WCDMA_B5_LowCH4132-826.4



HSUPA_B2_MidCH9400-1880

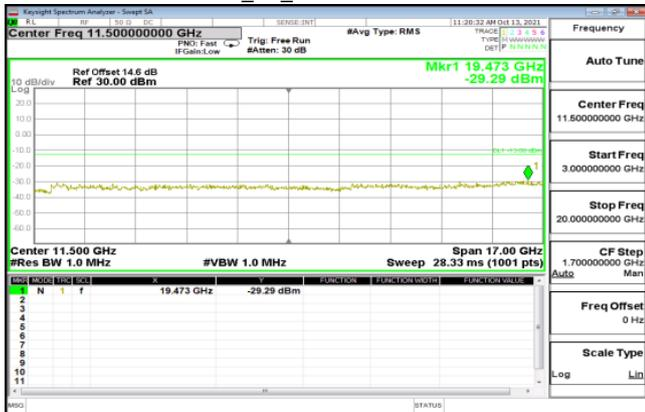

WCDMA_B5_MidCH4183-836.6

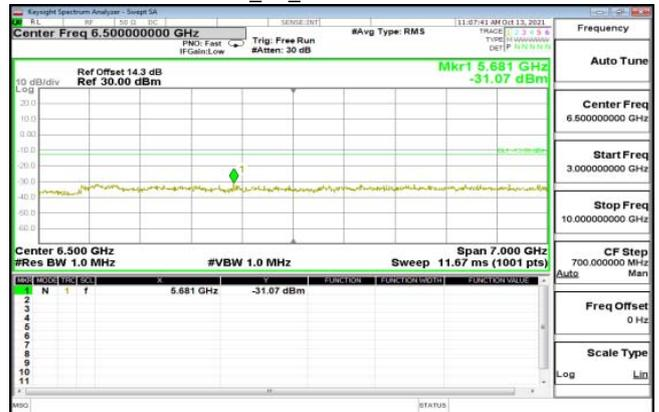

HSUPA_B2_HighCH9538-1907.6

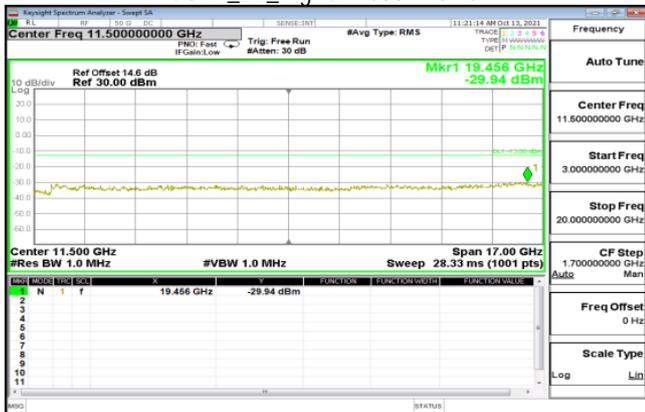

WCDMA_B5_HighCH4233-846.6

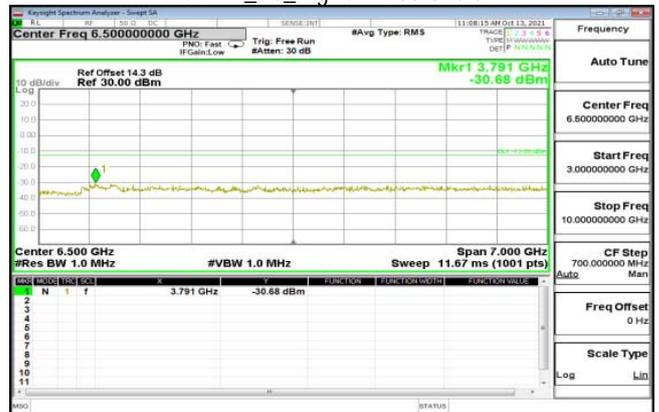

Unless otherwise stated the results shown in this test report refer only to the sample(s) tested and such sample(s) are retained for 90 days only.

除非另有說明，此報告結果僅對測試之樣品負責，同時此樣品僅保留90天。本報告未經本公司書面許可，不可部份複製。

This document is issued by the Company subject to its General Conditions of Service printed overleaf, available on request or accessible at <http://www.sgs.com.tw/Terms-and-Conditions> and for electronic format documents, subject to Terms and Conditions for Electronic Documents at <http://www.sgs.com.tw/Terms-and-Conditions>. Attention is drawn to the limitation of liability, indemnification and jurisdiction issues defined therein. Any holder of this document is advised that information contained herein reflects the Company's findings at the time of its intervention only and within the limits of Client's instructions, if any. The Company's sole responsibility is to its Client and this document does not exonerate parties to a transaction from exercising all their rights and obligations under the transaction documents. This document cannot be reproduced except in full, without prior written approval of the Company. Any unauthorized alteration, forgery or falsification of the content or appearance of this document is unlawful and offenders may be prosecuted to the fullest extent of the law.

HSDPA_B5_LowCH4132-826.4

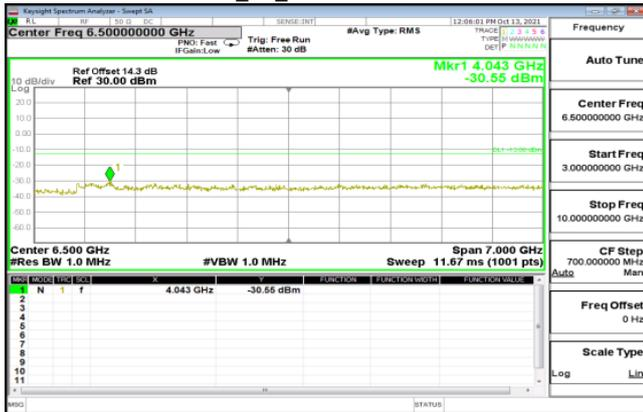

HSUPA_B5_LowCH4132-826.4

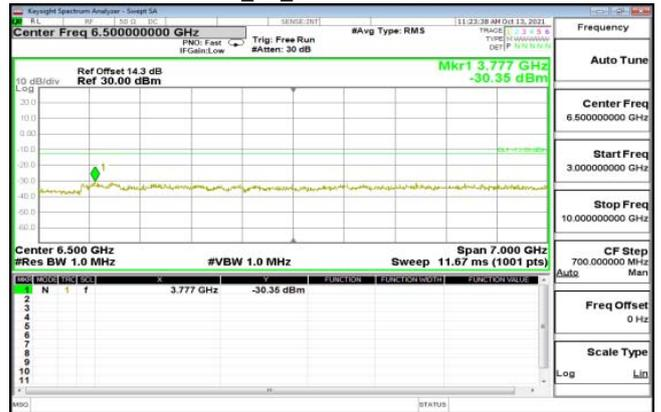

HSDPA_B5_MidCH4183-836.6

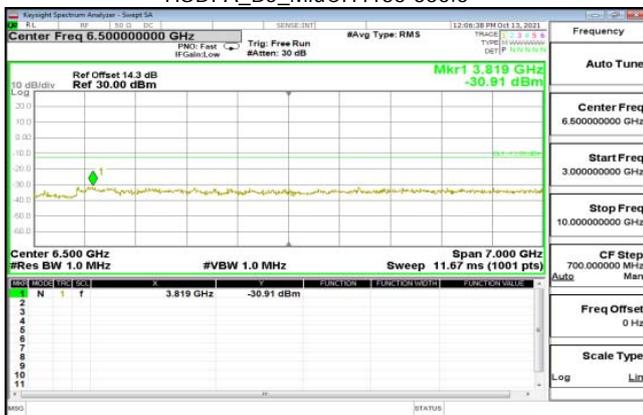

HSUPA_B5_MidCH4183-836.6

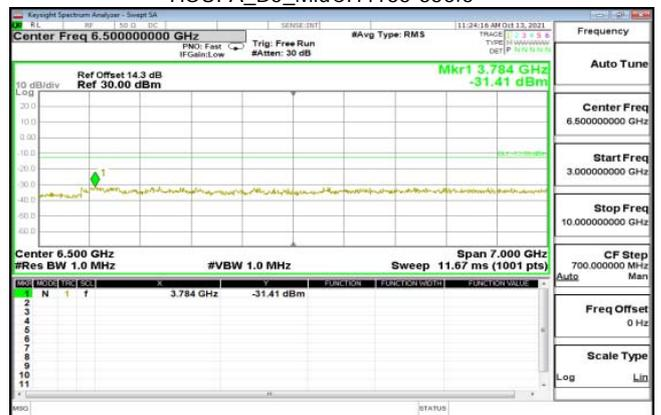

HSDPA_B5_HighCH4233-846.6

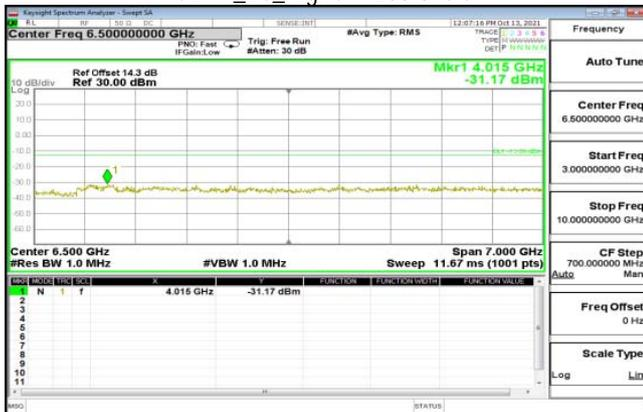

HSUPA_B5_HighCH4233-846.6



Unless otherwise stated the results shown in this test report refer only to the sample(s) tested and such sample(s) are retained for 90 days only.

除非另有說明，此報告結果僅對測試之樣品負責，同時此樣品僅保留90天。本報告未經本公司書面許可，不可部份複製。

This document is issued by the Company subject to its General Conditions of Service printed overleaf, available on request or accessible at <http://www.sgs.com.tw/Terms-and-Conditions> and for electronic format documents, subject to Terms and Conditions for Electronic Documents at <http://www.sgs.com.tw/Terms-and-Conditions>. Attention is drawn to the limitation of liability, indemnification and jurisdiction issues defined therein. Any holder of this document is advised that information contained herein reflects the Company's findings at the time of its intervention only and within the limits of Client's instructions, if any. The Company's sole responsibility is to its Client and this document does not exonerate parties to a transaction from exercising all their rights and obligations under the transaction documents. This document cannot be reproduced except in full, without prior written approval of the Company. Any unauthorized alteration, forgery or falsification of the content or appearance of this document is unlawful and offenders may be prosecuted to the fullest extent of the law.

9 FIELD STRENGTH OF SPURIOUS RADIATION MEASUREMENT

9.1 Standard Applicable

According to FCC §2.1053,

FCC §22.917(a), §24.238(a) and RSS-132 §5.5, RSS-133 §6.5.1

Out of band emissions. The power of any emission outside of the authorized operating frequency ranges must be attenuated below the transmitting power (P) by a factor of at least $43 + 10 \log(P)$ dB.

9.2 EUT Setup

Radiated Emission Test Set-Up, Frequency Below 1000MHz

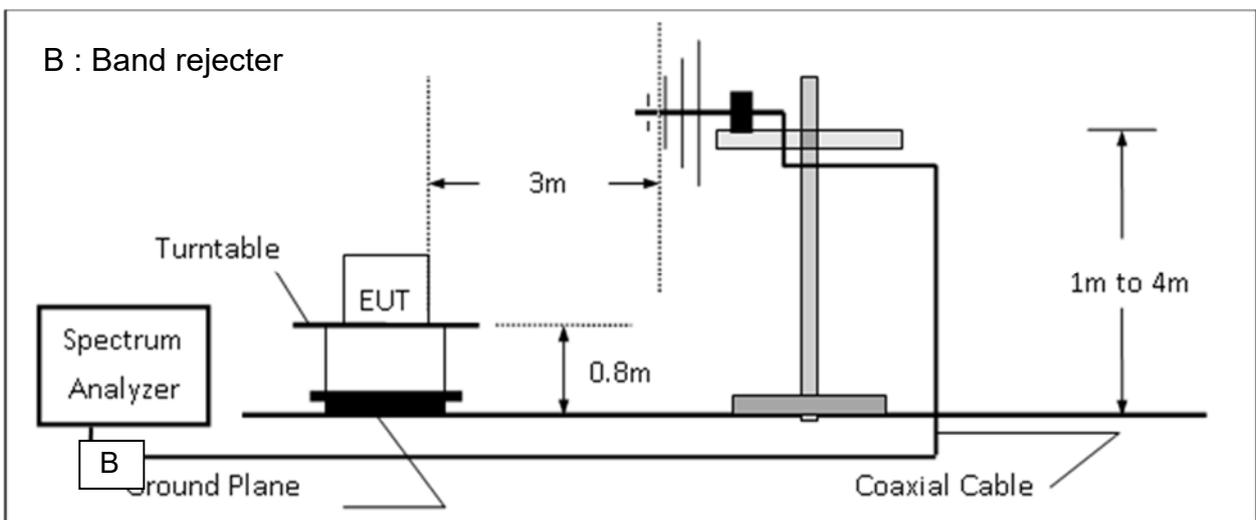

Radiated Emission Test Set-UP Frequency Over 1 GHz

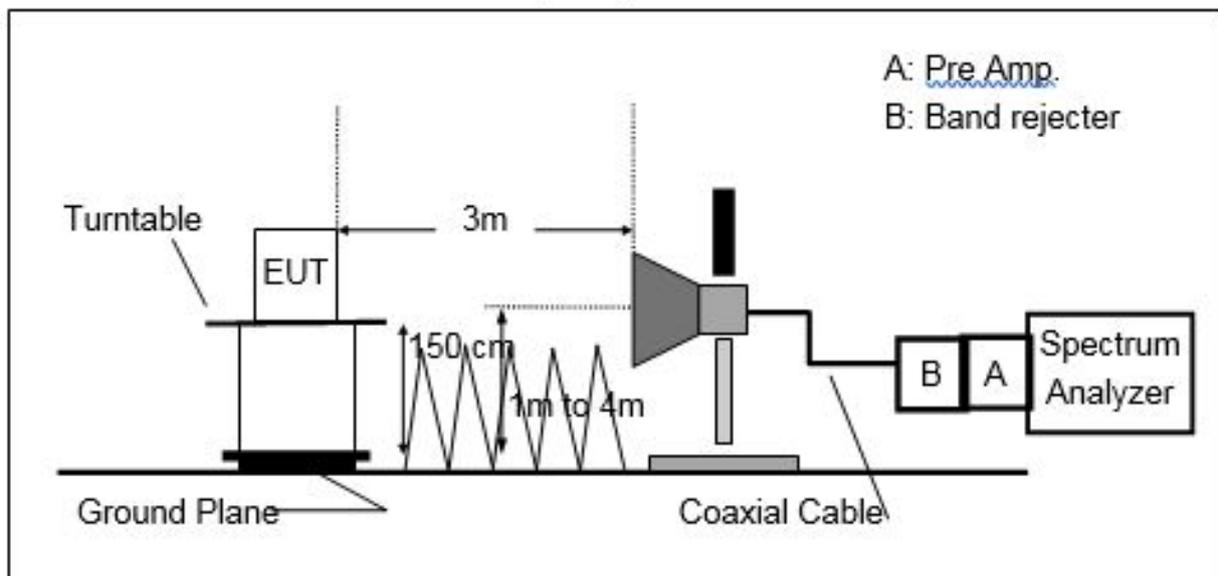

Unless otherwise stated the results shown in this test report refer only to the sample(s) tested and such sample(s) are retained for 90 days only.

除非另有說明，此報告結果僅對測試之樣品負責，同時此樣品僅保留90天。本報告未經本公司書面許可，不可部份複製。

This document is issued by the Company subject to its General Conditions of Service printed overleaf, available on request or accessible at <http://www.sgs.com.tw/Terms-and-Conditions> and for electronic format documents, subject to Terms and Conditions for Electronic Documents at <http://www.sgs.com.tw/Terms-and-Conditions>. Attention is drawn to the limitation of liability, indemnification and jurisdiction issues defined therein. Any holder of this document is advised that information contained hereon reflects the Company's findings at the time of its intervention only and within the limits of Client's instructions, if any. The Company's sole responsibility is to its Client and this document does not exonerate parties to a transaction from exercising all their rights and obligations under the transaction documents. This document cannot be reproduced except in full, without prior written approval of the Company. Any unauthorized alteration, forgery or falsification of the content or appearance of this document is unlawful and offenders may be prosecuted to the fullest extent of the law.

9.3 Measurement Procedure:

The EUT was placed on a non-conductive; the measurement antenna was placed at a distance of 3 meters from the EUT. During the tests, the antenna height and the EUT azimuth were varied in order to identify the maximum level of emissions from the EUT. This maximization process was repeated with the EUT positioned in each of its three orthogonal orientations.

The frequency range up to tenth harmonic was investigated for each of three fundamental frequencies (low, middle and high channels). Once spurious emission was identified, the power of the emission was determined using the substitution method.

The spurious emissions attenuation was calculated as the difference between radiated power at the fundamental frequency and the spurious emissions frequency.

$$\text{ERP (dBm)} = \text{SG Level(dBm)} + \text{Antenna Gain(dBd)} + \text{Cable Loss(dB)}$$

$$\text{EIRP (dBm)} = \text{SG Level(dBm)} + \text{Antenna Gain(dBi)} + \text{Cable Loss(dB)}$$

Unless otherwise stated the results shown in this test report refer only to the sample(s) tested and such sample(s) are retained for 90 days only.

除非另有說明，此報告結果僅對測試之樣品負責，同時此樣品僅保留90天。本報告未經本公司書面許可，不可部份複製。

This document is issued by the Company subject to its General Conditions of Service printed overleaf, available on request or accessible at <http://www.sgs.com.tw/Terms-and-Conditions> and for electronic format documents, subject to Terms and Conditions for Electronic Documents at <http://www.sgs.com.tw/Terms-and-Conditions>. Attention is drawn to the limitation of liability, indemnification and jurisdiction issues defined therein. Any holder of this document is advised that information contained hereon reflects the Company's findings at the time of its intervention only and within the limits of Client's instructions, if any. The Company's sole responsibility is to its Client and this document does not exonerate parties to a transaction from exercising all their rights and obligations under the transaction documents. This document cannot be reproduced except in full, without prior written approval of the Company. Any unauthorized alteration, forgery or falsification of the content or appearance of this document is unlawful and offenders may be prosecuted to the fullest extent of the law.

9.4 Measurement Equipment Used:

Radiated Emission Test Site: SAC 1					
EQUIPMENT TYPE	MFR	MODEL NUMBER	SERIAL NUMBER	LAST CAL.	CAL DUE.
Bi-log Antenna	SCHWARZ-BECK	VULB9168	378	08/20/2021	08/19/2022
Horn Antenna	SCHWARZ-BECK	BBHA9120D	603	05/18/2021	05/17/2022
Horn Antenna	SCHWARZ-BECK	BBHA9170	184	12/11/2020	12/10/2021
Horn Antenna	SCHWARZ-BECK	BBHA9170	185	08/02/2021	08/01/2022
Horn Antenna	SCHWARZ-BECK	BBHA9120D	D803	12/17/2020	12/16/2021
Bi-log Antenna	TESEO	CBL 6112D	35242 & AT-N0555	01/13/2021	01/12/2022
Spectrum Analyzer	Agilent	E4446A	MY51100003	10/29/2020	10/28/2021
Radio Communication Analyer	Anritsu	MT8815B	6200711454	04/07/2021	04/06/2022
Radio Communication Analyer	Anritsu	MT8821C	6262044670	08/18/2021	08/17/2022
Test Software	Audix	e3	Ver. 9.210322	N.C.R	N.C.R
Site Cal	SGS	SAC 1	N/A	01/01/2021	12/31/2021
Pre-Amplifier	EMC Instruments	EMC184045B	980135	10/27/2020	10/26/2021
Pre-Amplifier	HP	8449B	3008A01973	12/16/2020	12/15/2021
Pre-Amplifier	HP	8447D	2944A09469	12/16/2020	12/15/2021
Coaxial Cable	Huber Suhner	succoflex 102	MY2622/2	12/16/2020	12/15/2021
Coaxial Cable	Huber Suhner	succoflex 104A	800086/4a	12/16/2020	12/15/2021
Coaxial Cable	Huber Suhner	EMC 104-SM-SM-2000	160123	12/16/2020	12/15/2021
Coaxial Cable	Huber Suhner	SUCOFLEX 104	160125	12/16/2020	12/15/2021
Coaxial Cable	Huber Suhner	SUCOFLEX 106	76096/6	12/16/2020	12/15/2021
Coaxial Cable	Huber Suhner	SUCOFLEX 102	MY2630/2	12/16/2020	12/15/2021
Coaxial Cable	Huber Suhner	SUCOFLEX 102	MY22962/2	12/16/2020	12/15/2021

Unless otherwise stated the results shown in this test report refer only to the sample(s) tested and such sample(s) are retained for 90 days only.

除非另有說明，此報告結果僅對測試之樣品負責，同時此樣品僅保留90天。本報告未經本公司書面許可，不可部份複製。

This document is issued by the Company subject to its General Conditions of Service printed overleaf, available on request or accessible at <http://www.sgs.com.tw/Terms-and-Conditions> and for electronic format documents, subject to Terms and Conditions for Electronic Documents at <http://www.sgs.com.tw/Terms-and-Conditions>. Attention is drawn to the limitation of liability, indemnification and jurisdiction issues defined therein. Any holder of this document is advised that information contained hereon reflects the Company's findings at the time of its intervention only and within the limits of Client's instructions, if any. The Company's sole responsibility is to its Client and this document does not exonerate parties to a transaction from exercising all their rights and obligations under the transaction documents. This document cannot be reproduced except in full, without prior written approval of the Company. Any unauthorized alteration, forgery or falsification of the content or appearance of this document is unlawful and offenders may be prosecuted to the fullest extent of the law.

Coaxial Cable	Huber Suhner	SUCOFLEX 102	SN 520430/2	12/16/2020	12/15/2021
Bandreject Filter 635-920	Micro-Tronics	WI	4	12/16/2020	12/15/2021
Bandreject Filter 800-1000	Micro-Tronics	EWT	M1	12/16/2020	12/15/2021
Bandreject Filter 1700-2000	Micro-Tronics	EWT	M3	12/16/2020	12/15/2021
Bandreject Filter 2240-2700	Micro-Tronics	WI	2	12/16/2020	12/15/2021
1.3G-15GHz High Pass Filter	WI	WHKX10- 1066-80SS	20	04/20/2021	04/19/2022
3.2GHz High Pass Filter	WI	WHKX10- 2624-80SS	4	04/20/2021	04/19/2022

Unless otherwise stated the results shown in this test report refer only to the sample(s) tested and such sample(s) are retained for 90 days only.

除非另有說明，此報告結果僅對測試之樣品負責，同時此樣品僅保留90天。本報告未經本公司書面許可，不可部份複製。

This document is issued by the Company subject to its General Conditions of Service printed overleaf, available on request or accessible at <http://www.sgs.com.tw/Terms-and-Conditions> and for electronic format documents, subject to Terms and Conditions for Electronic Documents at <http://www.sgs.com.tw/Terms-and-Conditions>. Attention is drawn to the limitation of liability, indemnification and jurisdiction issues defined therein. Any holder of this document is advised that information contained hereon reflects the Company's findings at the time of its intervention only and within the limits of Client's instructions, if any. The Company's sole responsibility is to its Client and this document does not exonerate parties to a transaction from exercising all their rights and obligations under the transaction documents. This document cannot be reproduced except in full, without prior written approval of the Company. Any unauthorized alteration, forgery or falsification of the content or appearance of this document is unlawful and offenders may be prosecuted to the fullest extent of the law.

9.5 Measurement Result:

Report Number :ER/2021/80081
 Operation Mode :WCDMA B2
 Test Mode :Tx CH Low
 EUT Pol :H Plane
 Test Frequency :1852.4 MHz

Test Site :SAC 1
 Test Date :2021-09-08
 Temp./Humi. :26.2/60
 Antenna Pol. :Vertical
 Engineer :Neo Tsai

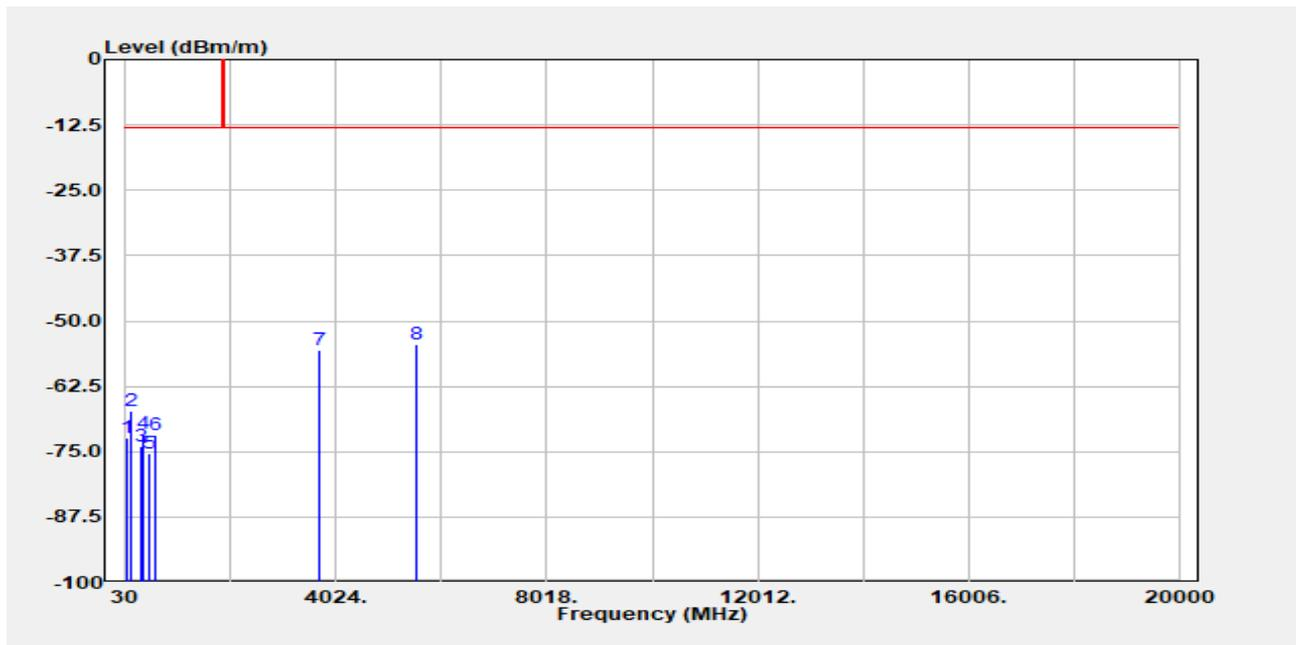

Freq. MHz	EIRP/ERP dBm	SG Output Level dBm	Antenna Gain dBi/dBd	Cable Loss dB	Limit dBm	Margin dB
65.567	-72.49	-63.82	-7.96	-0.79	-13.00	-59.48
114.067	-67.16	-64.46	-1.69	-1.09	-13.00	-54.15
329.083	-74.02	-76.61	4.24	-1.89	-13.00	-61.01
356.567	-71.42	-74.30	4.49	-1.97	-13.00	-58.41
469.733	-75.45	-77.59	4.12	-2.26	-13.00	-62.44
599.067	-71.82	-73.80	3.67	-2.64	-13.00	-58.81
3704.800	-55.61	-61.36	12.31	-7.53	-13.00	-42.60
5557.200	-54.39	-58.22	12.91	-9.55	-13.00	-41.38

Unless otherwise stated the results shown in this test report refer only to the sample(s) tested and such sample(s) are retained for 90 days only.

除非另有說明，此報告結果僅對測試之樣品負責，同時此樣品僅保留90天。本報告未經本公司書面許可，不可部份複製。

This document is issued by the Company subject to its General Conditions of Service printed overleaf, available on request or accessible at <http://www.sgs.com.tw/Terms-and-Conditions> and for electronic format documents, subject to Terms and Conditions for Electronic Documents at <http://www.sgs.com.tw/Terms-and-Conditions>. Attention is drawn to the limitation of liability, indemnification and jurisdiction issues defined therein. Any holder of this document is advised that information contained hereon reflects the Company's findings at the time of its intervention only and within the limits of Client's instructions, if any. The Company's sole responsibility is to its Client and this document does not exonerate parties to a transaction from exercising all their rights and obligations under the transaction documents. This document cannot be reproduced except in full, without prior written approval of the Company. Any unauthorized alteration, forgery or falsification of the content or appearance of this document is unlawful and offenders may be prosecuted to the fullest extent of the law.

Report Number :ER/2021/80081
 Operation Mode :WCDMA B2
 Test Mode :Tx CH Low
 EUT Pol :H Plane
 Test Frequency :1852.4 MHz

Test Site :SAC 1
 Test Date :2021-09-08
 Temp./Humi. :26.2/60
 Antenna Pol. :Horizontal
 Engineer :Neo Tsai

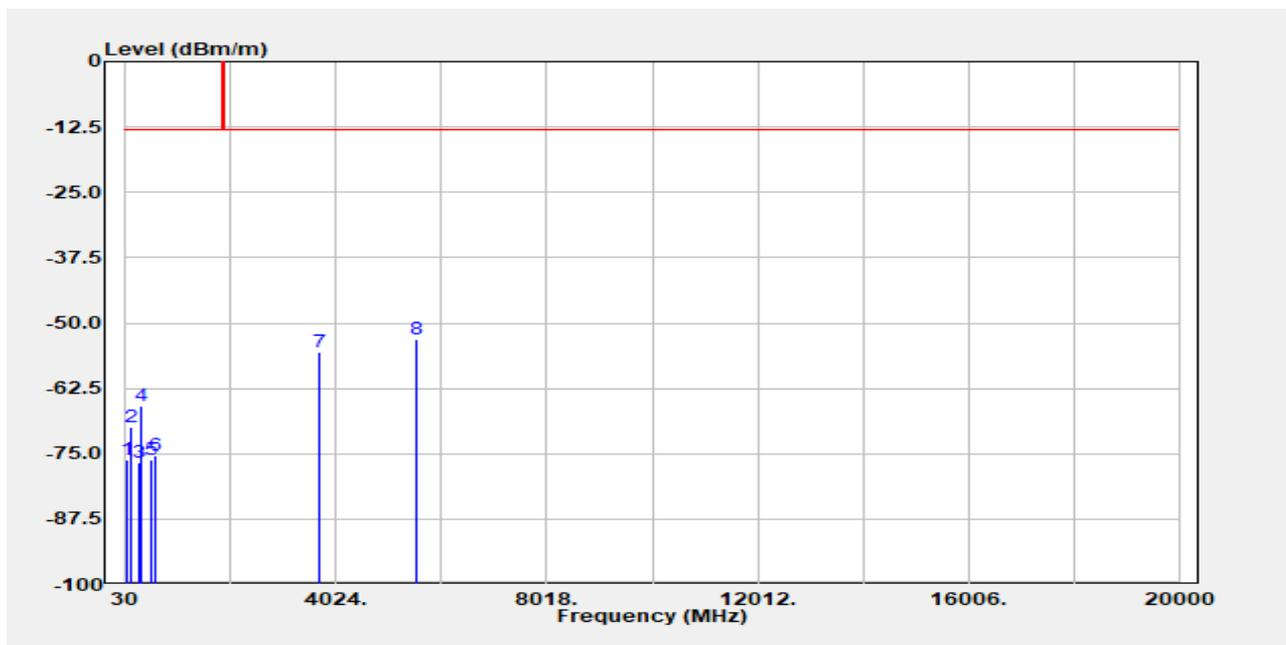

Freq. MHz	EIRP/ERP dBm	SG Output Level dBm	Antenna Gain dBi/dBd	Cable Loss dB	Limit dBm	Margin dB
65.567	-76.28	-67.61	-7.96	-0.79	-13.00	-63.27
141.550	-69.87	-66.92	-1.91	-1.29	-13.00	-56.86
267.650	-76.80	-79.51	4.22	-1.64	-13.00	-63.79
340.400	-65.94	-68.79	4.32	-1.89	-13.00	-52.93
513.383	-76.10	-78.46	4.12	-2.09	-13.00	-63.09
597.450	-75.31	-77.27	3.71	-2.65	-13.00	-62.30
3704.800	-55.60	-61.34	12.31	-7.53	-13.00	-42.59
5557.200	-53.07	-56.91	12.91	-9.55	-13.00	-40.06

Unless otherwise stated the results shown in this test report refer only to the sample(s) tested and such sample(s) are retained for 90 days only.

除非另有說明，此報告結果僅對測試之樣品負責，同時此樣品僅保留90天。本報告未經本公司書面許可，不可部份複製。

This document is issued by the Company subject to its General Conditions of Service printed overleaf, available on request or accessible at <http://www.sgs.com.tw/Terms-and-Conditions> and for electronic format documents, subject to Terms and Conditions for Electronic Documents at <http://www.sgs.com.tw/Terms-and-Conditions>. Attention is drawn to the limitation of liability, indemnification and jurisdiction issues defined therein. Any holder of this document is advised that information contained hereon reflects the Company's findings at the time of its intervention only and within the limits of Client's instructions, if any. The Company's sole responsibility is to its Client and this document does not exonerate parties to a transaction from exercising all their rights and obligations under the transaction documents. This document cannot be reproduced except in full, without prior written approval of the Company. Any unauthorized alteration, forgery or falsification of the content or appearance of this document is unlawful and offenders may be prosecuted to the fullest extent of the law.

Report Number :ER/2021/80081
 Operation Mode :WCDMA B2
 Test Mode :Tx CH Mid
 EUT Pol :H Plane
 Test Frequency :1880 MHz

Test Site :SAC 1
 Test Date :2021-09-08
 Temp./Humi. :26.2/60
 Antenna Pol. :Vertical
 Engineer :Neo Tsai

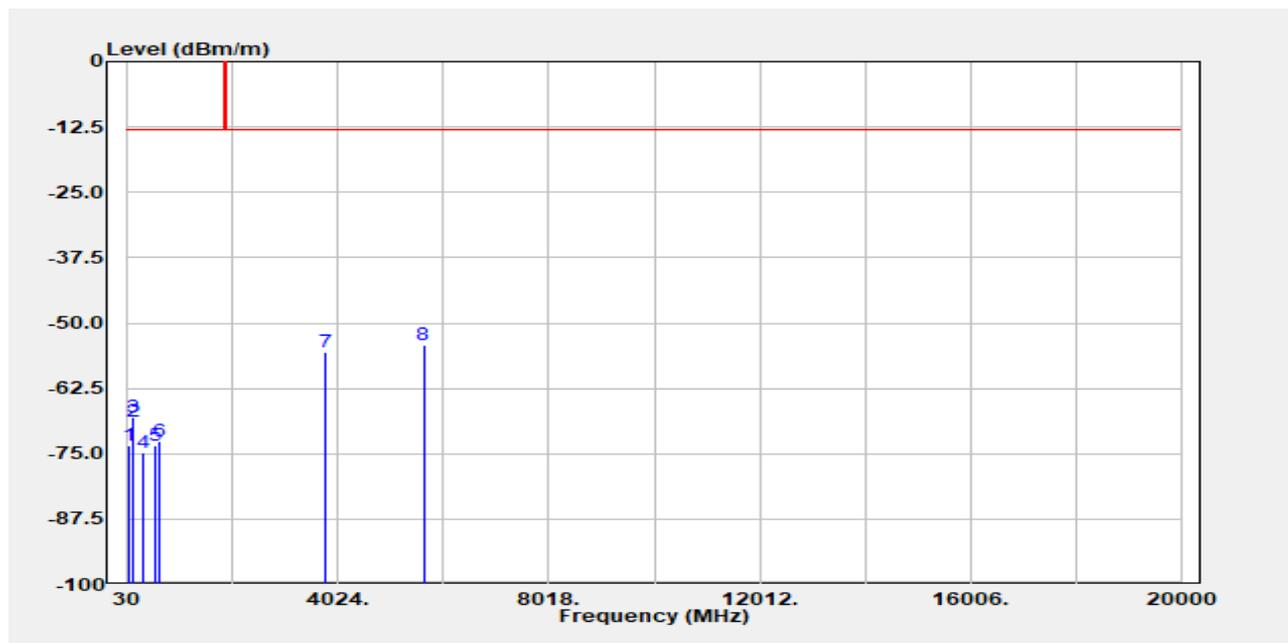

Freq. MHz	EIRP/ERP dBm	SG Output Level dBm	Antenna Gain dBi/dBd	Cable Loss dB	Limit dBm	Margin dB
65.567	-73.37	-64.70	-7.96	-0.79	-13.00	-60.37
114.067	-68.85	-66.16	-1.69	-1.09	-13.00	-55.85
135.083	-68.06	-64.89	-2.10	-1.25	-13.00	-55.06
321.000	-74.84	-77.56	4.19	-1.68	-13.00	-61.84
536.017	-73.52	-75.97	4.28	-2.21	-13.00	-60.52
618.467	-72.63	-74.17	3.44	-2.32	-13.00	-59.63
3760.000	-55.46	-60.63	12.40	-7.63	-13.00	-42.46
5640.000	-54.11	-58.15	13.00	-9.23	-13.00	-41.11

Unless otherwise stated the results shown in this test report refer only to the sample(s) tested and such sample(s) are retained for 90 days only.

除非另有說明，此報告結果僅對測試之樣品負責，同時此樣品僅保留90天。本報告未經本公司書面許可，不可部份複製。

This document is issued by the Company subject to its General Conditions of Service printed overleaf, available on request or accessible at <http://www.sgs.com.tw/Terms-and-Conditions> and for electronic format documents, subject to Terms and Conditions for Electronic Documents at <http://www.sgs.com.tw/Terms-and-Conditions>. Attention is drawn to the limitation of liability, indemnification and jurisdiction issues defined therein. Any holder of this document is advised that information contained hereon reflects the Company's findings at the time of its intervention only and within the limits of Client's instructions, if any. The Company's sole responsibility is to its Client and this document does not exonerate parties to a transaction from exercising all their rights and obligations under the transaction documents. This document cannot be reproduced except in full, without prior written approval of the Company. Any unauthorized alteration, forgery or falsification of the content or appearance of this document is unlawful and offenders may be prosecuted to the fullest extent of the law.

Report Number :ER/2021/80081
 Operation Mode :WCDMA B2
 Test Mode :Tx CH Mid
 EUT Pol :H Plane
 Test Frequency :1880 MHz

Test Site :SAC 1
 Test Date :2021-09-08
 Temp./Humi. :26.2/60
 Antenna Pol. :Horizontal
 Engineer :Neo Tsai

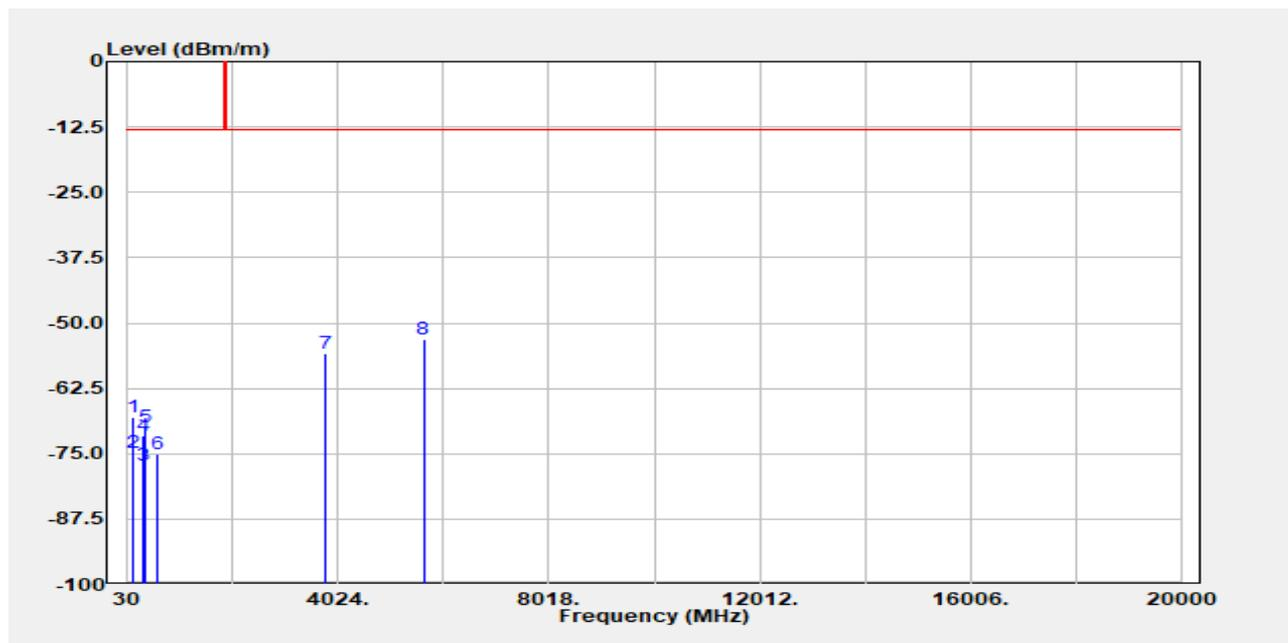

Freq. MHz	EIRP/ERP dBm	SG Output Level dBm	Antenna Gain dBi/dBd	Cable Loss dB	Limit dBm	Margin dB
120.533	-68.05	-65.23	-1.74	-1.13	-13.00	-55.05
141.550	-74.69	-71.74	-1.91	-1.29	-13.00	-61.69
317.767	-77.32	-80.01	4.17	-1.67	-13.00	-64.32
329.083	-71.65	-74.24	4.24	-1.89	-13.00	-58.65
348.483	-69.85	-72.80	4.52	-2.01	-13.00	-56.85
597.450	-75.04	-76.99	3.71	-2.65	-13.00	-62.04
3760.000	-55.77	-60.93	12.40	-7.63	-13.00	-42.77
5640.000	-53.16	-57.19	13.00	-9.23	-13.00	-40.16

Unless otherwise stated the results shown in this test report refer only to the sample(s) tested and such sample(s) are retained for 90 days only.

除非另有說明，此報告結果僅對測試之樣品負責，同時此樣品僅保留90天。本報告未經本公司書面許可，不可部份複製。

This document is issued by the Company subject to its General Conditions of Service printed overleaf, available on request or accessible at <http://www.sgs.com.tw/Terms-and-Conditions> and for electronic format documents, subject to Terms and Conditions for Electronic Documents at <http://www.sgs.com.tw/Terms-and-Conditions>. Attention is drawn to the limitation of liability, indemnification and jurisdiction issues defined therein. Any holder of this document is advised that information contained hereon reflects the Company's findings at the time of its intervention only and within the limits of Client's instructions, if any. The Company's sole responsibility is to its Client and this document does not exonerate parties to a transaction from exercising all their rights and obligations under the transaction documents. This document cannot be reproduced except in full, without prior written approval of the Company. Any unauthorized alteration, forgery or falsification of the content or appearance of this document is unlawful and offenders may be prosecuted to the fullest extent of the law.

Report Number :ER/2021/80081
 Operation Mode :WCDMA B2
 Test Mode :Tx CH High
 EUT Pol :H Plane
 Test Frequency :1907.6 MHz

Test Site :SAC 1
 Test Date :2021-09-08
 Temp./Humi. :26.2/60
 Antenna Pol. :Vertical
 Engineer :Neo Tsai

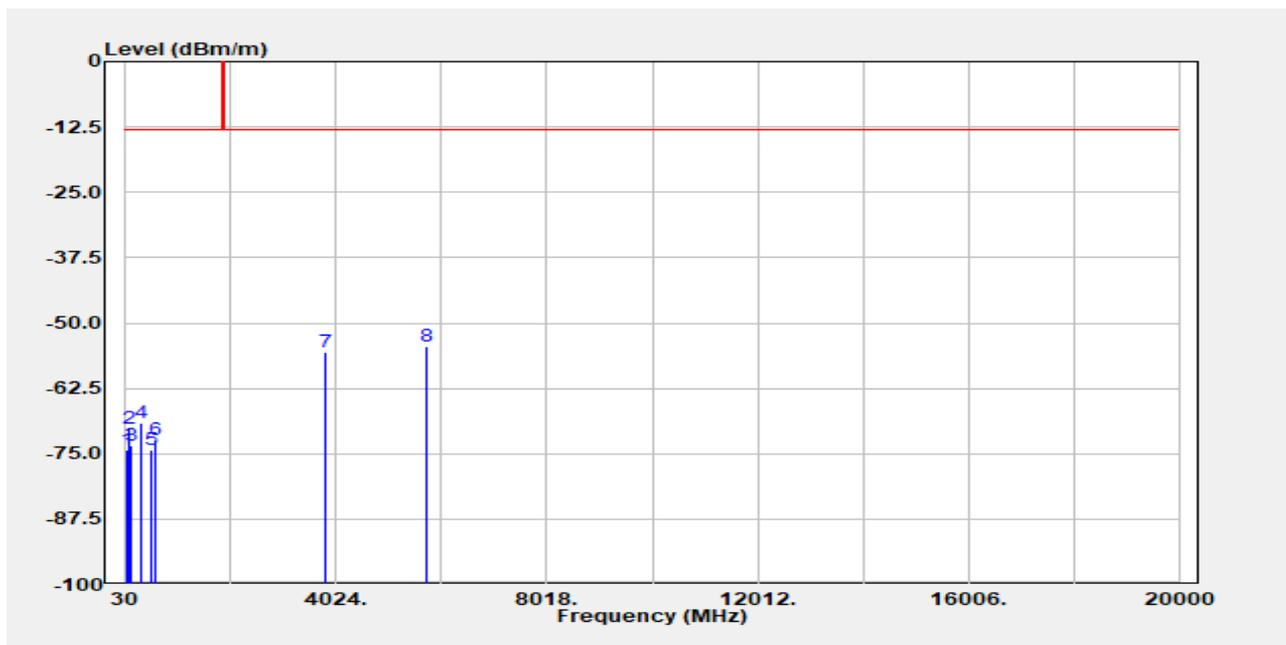

Freq. MHz	EIRP/ERP dBm	SG Output Level dBm	Antenna Gain dBi/dBd	Cable Loss dB	Limit dBm	Margin dB
63.950	-74.25	-64.94	-8.60	-0.78	-13.00	-61.25
109.217	-70.21	-67.76	-1.50	-1.05	-13.00	-57.21
123.767	-73.46	-70.55	-1.84	-1.14	-13.00	-60.46
333.933	-69.07	-71.75	4.27	-1.90	-13.00	-56.07
515.000	-74.13	-76.43	4.12	-2.12	-13.00	-61.13
586.133	-72.30	-73.77	3.82	-2.67	-13.00	-59.30
3815.200	-55.52	-60.88	12.37	-7.66	-13.00	-42.52
5722.800	-54.41	-58.44	12.80	-9.05	-13.00	-41.41

Unless otherwise stated the results shown in this test report refer only to the sample(s) tested and such sample(s) are retained for 90 days only.

除非另有說明，此報告結果僅對測試之樣品負責，同時此樣品僅保留90天。本報告未經本公司書面許可，不可部份複製。

This document is issued by the Company subject to its General Conditions of Service printed overleaf, available on request or accessible at <http://www.sgs.com.tw/Terms-and-Conditions> and for electronic format documents, subject to Terms and Conditions for Electronic Documents at <http://www.sgs.com.tw/Terms-and-Conditions>. Attention is drawn to the limitation of liability, indemnification and jurisdiction issues defined therein. Any holder of this document is advised that information contained hereon reflects the Company's findings at the time of its intervention only and within the limits of Client's instructions, if any. The Company's sole responsibility is to its Client and this document does not exonerate parties to a transaction from exercising all their rights and obligations under the transaction documents. This document cannot be reproduced except in full, without prior written approval of the Company. Any unauthorized alteration, forgery or falsification of the content or appearance of this document is unlawful and offenders may be prosecuted to the fullest extent of the law.

Report Number :ER/2021/80081
 Operation Mode :WCDMA B2
 Test Mode :Tx CH High
 EUT Pol :H Plane
 Test Frequency :1907.6 MHz

Test Site :SAC 1
 Test Date :2021-09-08
 Temp./Humi. :26.2/60
 Antenna Pol. :Horizontal
 Engineer :Neo Tsai

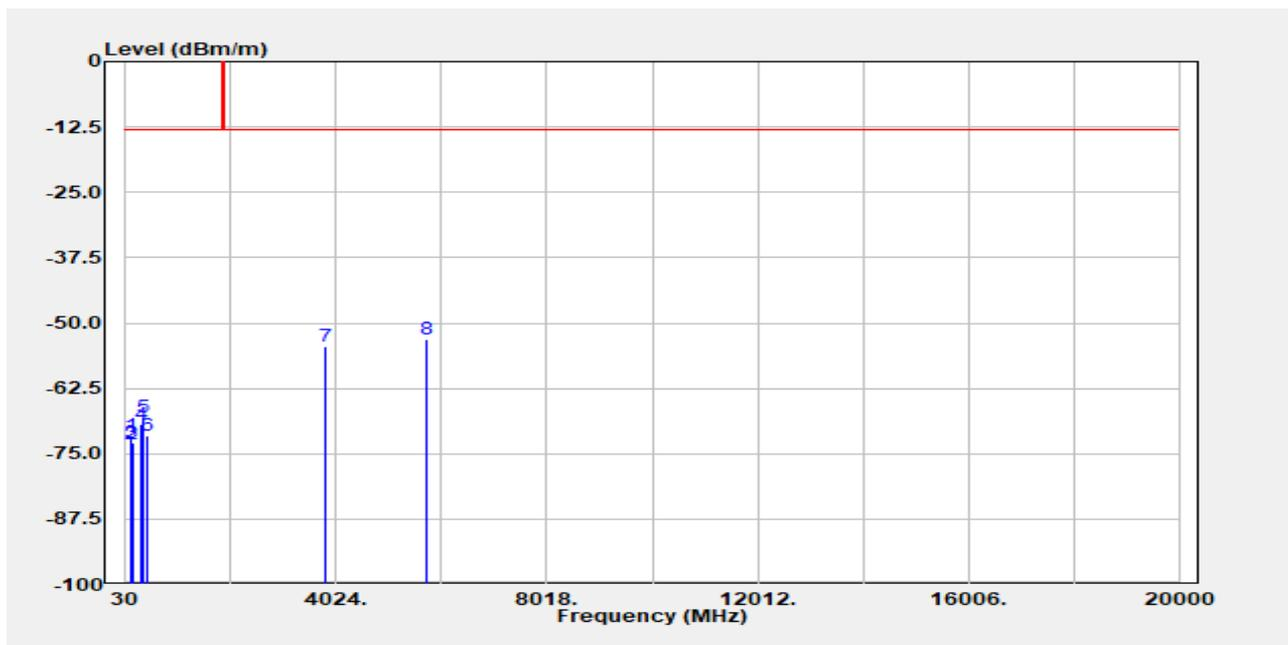

Freq. MHz	EIRP/ERP dBm	SG Output Level dBm	Antenna Gain dBi/dBd	Cable Loss dB	Limit dBm	Margin dB
112.450	-71.61	-68.98	-1.65	-1.07	-13.00	-58.61
123.767	-73.04	-70.13	-1.84	-1.14	-13.00	-60.04
149.633	-72.93	-70.37	-1.62	-1.15	-13.00	-59.93
322.617	-69.31	-72.00	4.20	-1.72	-13.00	-56.31
346.867	-67.98	-70.91	4.48	-1.99	-13.00	-54.98
443.867	-71.66	-74.01	4.13	-2.20	-13.00	-58.66
3815.200	-54.41	-59.77	12.37	-7.66	-13.00	-41.41
5722.800	-53.19	-57.23	12.80	-9.05	-13.00	-40.19

Unless otherwise stated the results shown in this test report refer only to the sample(s) tested and such sample(s) are retained for 90 days only.

除非另有說明，此報告結果僅對測試之樣品負責，同時此樣品僅保留90天。本報告未經本公司書面許可，不可部份複製。

This document is issued by the Company subject to its General Conditions of Service printed overleaf, available on request or accessible at <http://www.sgs.com.tw/Terms-and-Conditions> and for electronic format documents, subject to Terms and Conditions for Electronic Documents at <http://www.sgs.com.tw/Terms-and-Conditions>. Attention is drawn to the limitation of liability, indemnification and jurisdiction issues defined therein. Any holder of this document is advised that information contained hereon reflects the Company's findings at the time of its intervention only and within the limits of Client's instructions, if any. The Company's sole responsibility is to its Client and this document does not exonerate parties to a transaction from exercising all their rights and obligations under the transaction documents. This document cannot be reproduced except in full, without prior written approval of the Company. Any unauthorized alteration, forgery or falsification of the content or appearance of this document is unlawful and offenders may be prosecuted to the fullest extent of the law.

Report Number :ER/2021/80081
 Operation Mode :WCDMA B5
 Test Mode :Tx CH Low
 EUT Pol :H Plane
 Test Frequency :826.4 MHz

Test Site :SAC 1
 Test Date :2021-09-08
 Temp./Humi. :26.2/60
 Antenna Pol. :Vertical
 Engineer :Neo Tsai

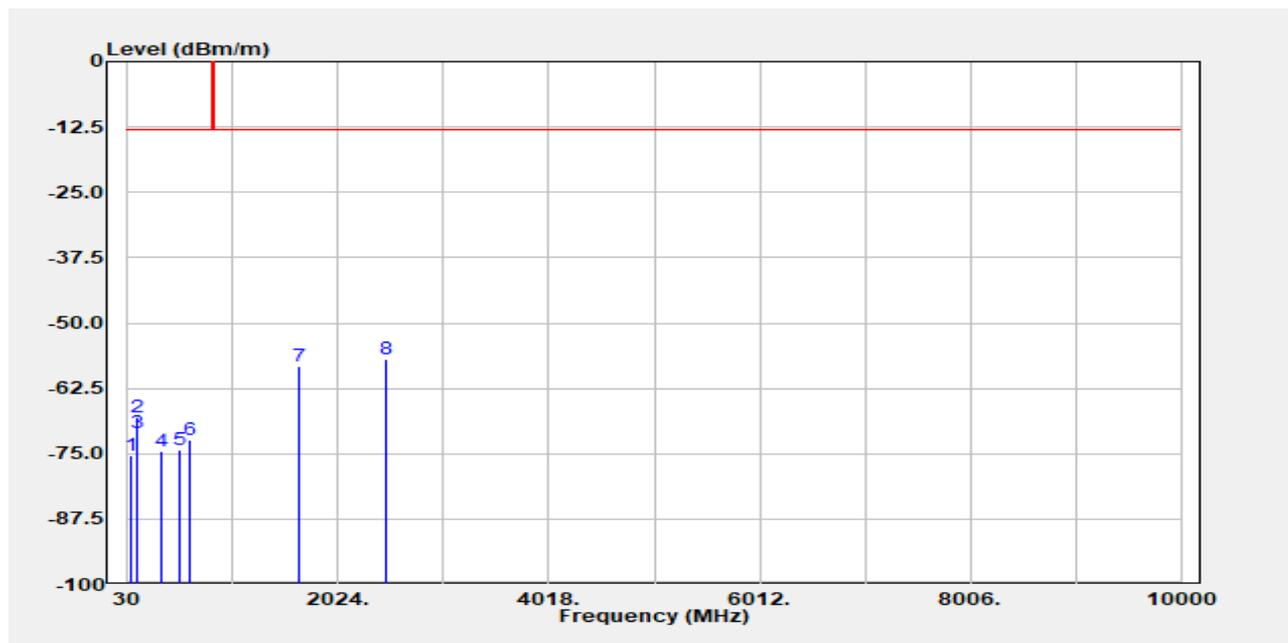

Freq. MHz	EIRP/ERP dBm	SG Output Level dBm	Antenna Gain dBi/dBd	Cable Loss dB	Limit dBm	Margin dB
65.567	-75.24	-66.52	-7.96	-0.79	-13.00	-62.24
112.450	-67.98	-65.31	-1.65	-1.07	-13.00	-54.98
118.917	-71.13	-68.26	-1.80	-1.12	-13.00	-58.13
351.717	-74.61	-77.18	4.53	-2.02	-13.00	-61.61
526.317	-74.34	-76.69	4.18	-2.06	-13.00	-61.34
620.083	-72.23	-74.05	3.43	-2.29	-13.00	-59.23
1652.800	-58.33	-64.29	9.51	-4.26	-13.00	-45.33
2479.200	-56.82	-62.52	10.56	-5.17	-13.00	-43.82

Unless otherwise stated the results shown in this test report refer only to the sample(s) tested and such sample(s) are retained for 90 days only.

除非另有說明，此報告結果僅對測試之樣品負責，同時此樣品僅保留90天。本報告未經本公司書面許可，不可部份複製。

This document is issued by the Company subject to its General Conditions of Service printed overleaf, available on request or accessible at <http://www.sgs.com.tw/Terms-and-Conditions> and for electronic format documents, subject to Terms and Conditions for Electronic Documents at <http://www.sgs.com.tw/Terms-and-Conditions>. Attention is drawn to the limitation of liability, indemnification and jurisdiction issues defined therein. Any holder of this document is advised that information contained hereon reflects the Company's findings at the time of its intervention only and within the limits of Client's instructions, if any. The Company's sole responsibility is to its Client and this document does not exonerate parties to a transaction from exercising all their rights and obligations under the transaction documents. This document cannot be reproduced except in full, without prior written approval of the Company. Any unauthorized alteration, forgery or falsification of the content or appearance of this document is unlawful and offenders may be prosecuted to the fullest extent of the law.

Report Number :ER/2021/80081
 Operation Mode :WCDMA B5
 Test Mode :Tx CH Low
 EUT Pol :H Plane
 Test Frequency :826.4 MHz

Test Site :SAC 1
 Test Date :2021-09-08
 Temp./Humi. :26.2/60
 Antenna Pol. :Horizontal
 Engineer :Neo Tsai

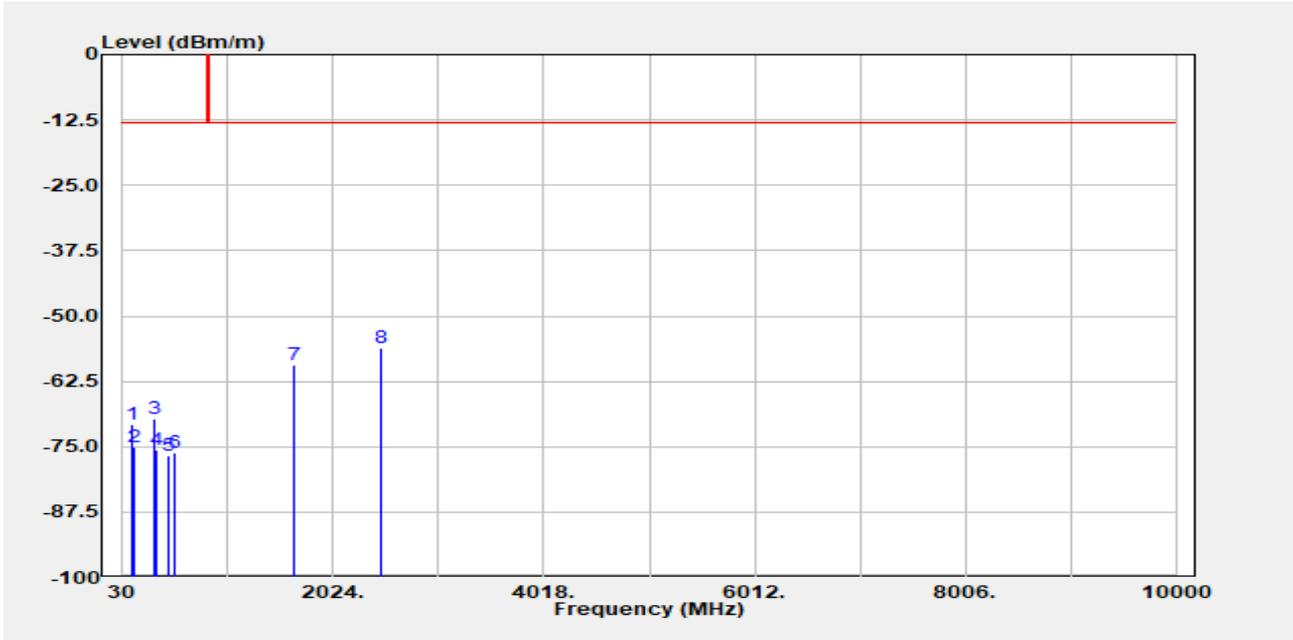

Freq. MHz	EIRP/ERP dBm	SG Output Level dBm	Antenna Gain dBi/dBd	Cable Loss dB	Limit dBm	Margin dB
122.150	-70.65	-67.66	-1.88	-1.14	-13.00	-57.65
141.550	-75.09	-71.90	-1.91	-1.29	-13.00	-62.09
337.167	-69.54	-71.91	4.29	-1.90	-13.00	-56.54
350.100	-75.60	-78.14	4.56	-2.03	-13.00	-62.60
469.733	-76.81	-78.89	4.12	-2.26	-13.00	-63.81
527.933	-76.13	-78.52	4.17	-2.02	-13.00	-63.13
1652.800	-59.37	-65.33	9.51	-4.26	-13.00	-46.37
2479.200	-56.18	-61.88	10.56	-5.17	-13.00	-43.18

Unless otherwise stated the results shown in this test report refer only to the sample(s) tested and such sample(s) are retained for 90 days only.

除非另有說明，此報告結果僅對測試之樣品負責，同時此樣品僅保留90天。本報告未經本公司書面許可，不可部份複製。

This document is issued by the Company subject to its General Conditions of Service printed overleaf, available on request or accessible at <http://www.sgs.com.tw/Terms-and-Conditions> and for electronic format documents, subject to Terms and Conditions for Electronic Documents at <http://www.sgs.com.tw/Terms-and-Conditions>. Attention is drawn to the limitation of liability, indemnification and jurisdiction issues defined therein. Any holder of this document is advised that information contained hereon reflects the Company's findings at the time of its intervention only and within the limits of Client's instructions, if any. The Company's sole responsibility is to its Client and this document does not exonerate parties to a transaction from exercising all their rights and obligations under the transaction documents. This document cannot be reproduced except in full, without prior written approval of the Company. Any unauthorized alteration, forgery or falsification of the content or appearance of this document is unlawful and offenders may be prosecuted to the fullest extent of the law.

Report Number :ER/2021/80081
 Operation Mode :WCDMA B5
 Test Mode :Tx CH Mid
 EUT Pol :H Plane
 Test Frequency :836.6 MHz

Test Site :SAC 1
 Test Date :2021-09-08
 Temp./Humi. :26.2/60
 Antenna Pol. :Vertical
 Engineer :Neo Tsai

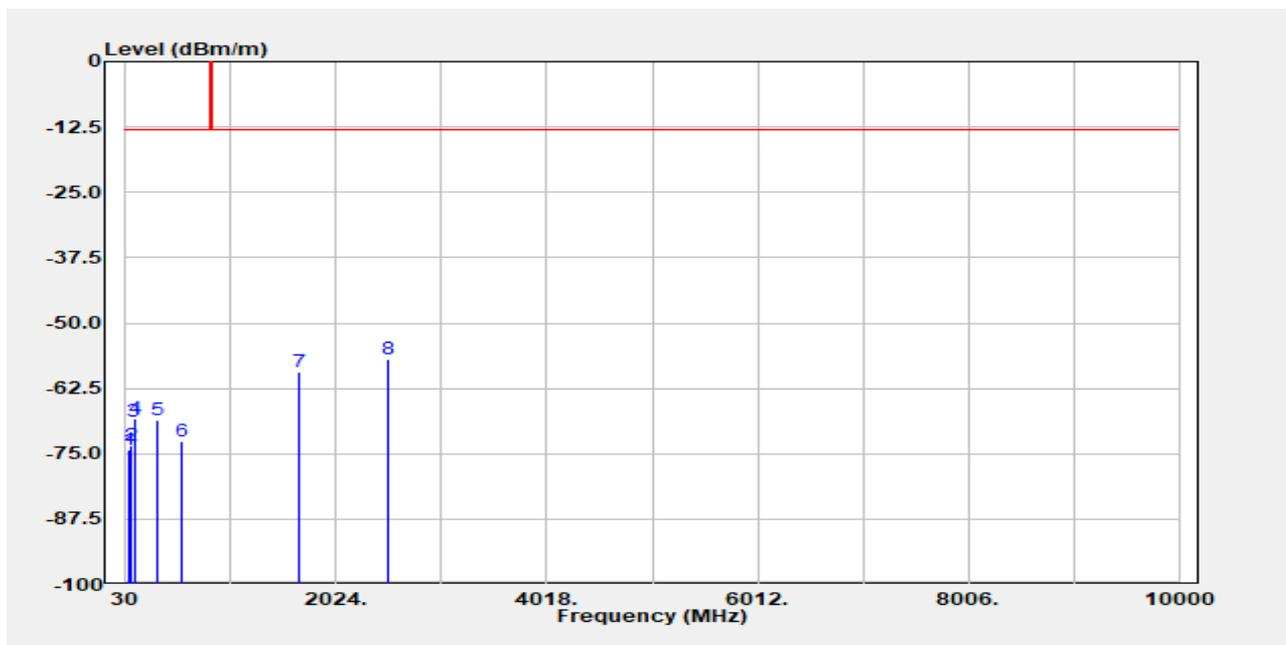

Freq. MHz	EIRP/ERP dBm	SG Output Level dBm	Antenna Gain dBi/dBd	Cable Loss dB	Limit dBm	Margin dB
65.567	-74.37	-65.65	-7.96	-0.79	-13.00	-61.37
80.117	-73.35	-69.49	-3.00	-0.90	-13.00	-60.35
109.217	-68.78	-66.28	-1.50	-1.05	-13.00	-55.78
117.300	-68.19	-65.40	-1.73	-1.11	-13.00	-55.19
329.083	-68.57	-71.08	4.24	-1.89	-13.00	-55.57
557.033	-72.76	-75.05	4.26	-2.52	-13.00	-59.76
1673.200	-59.48	-65.78	9.55	-4.29	-13.00	-46.48
2509.800	-56.87	-62.73	10.62	-5.20	-13.00	-43.87

Unless otherwise stated the results shown in this test report refer only to the sample(s) tested and such sample(s) are retained for 90 days only.

除非另有說明，此報告結果僅對測試之樣品負責，同時此樣品僅保留90天。本報告未經本公司書面許可，不可部份複製。

This document is issued by the Company subject to its General Conditions of Service printed overleaf, available on request or accessible at <http://www.sgs.com.tw/Terms-and-Conditions> and for electronic format documents, subject to Terms and Conditions for Electronic Documents at <http://www.sgs.com.tw/Terms-and-Conditions>. Attention is drawn to the limitation of liability, indemnification and jurisdiction issues defined therein. Any holder of this document is advised that information contained hereon reflects the Company's findings at the time of its intervention only and within the limits of Client's instructions, if any. The Company's sole responsibility is to its Client and this document does not exonerate parties to a transaction from exercising all their rights and obligations under the transaction documents. This document cannot be reproduced except in full, without prior written approval of the Company. Any unauthorized alteration, forgery or falsification of the content or appearance of this document is unlawful and offenders may be prosecuted to the fullest extent of the law.

Report Number :ER/2021/80081
 Operation Mode :WCDMA B5
 Test Mode :Tx CH Mid
 EUT Pol :H Plane
 Test Frequency :836.6 MHz

Test Site :SAC 1
 Test Date :2021-09-08
 Temp./Humi. :26.2/60
 Antenna Pol. :Horizontal
 Engineer :Neo Tsai

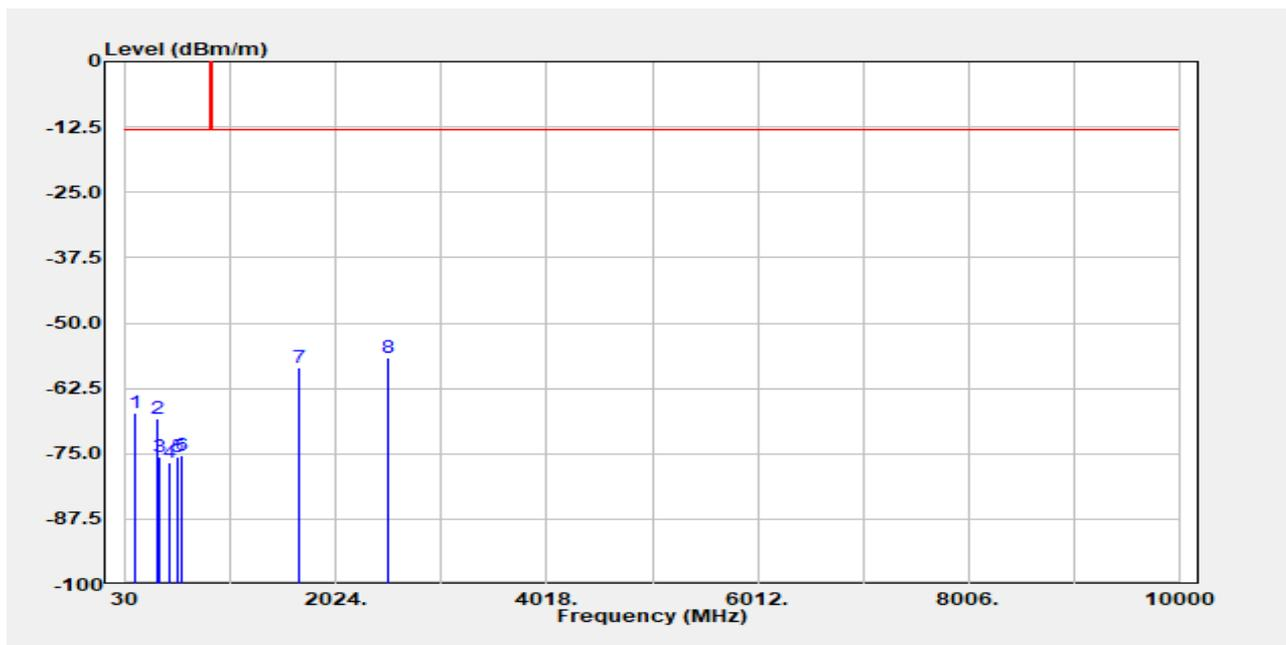

Freq. MHz	EIRP/ERP dBm	SG Output Level dBm	Antenna Gain dBi/dBd	Cable Loss dB	Limit dBm	Margin dB
118.917	-67.31	-64.43	-1.80	-1.12	-13.00	-54.31
335.550	-68.22	-70.62	4.28	-1.90	-13.00	-55.22
343.633	-75.49	-77.90	4.40	-1.94	-13.00	-62.49
440.633	-76.58	-78.69	4.06	-2.21	-13.00	-63.58
527.933	-75.73	-78.12	4.17	-2.02	-13.00	-62.73
555.417	-75.45	-77.79	4.26	-2.46	-13.00	-62.45
1673.200	-58.44	-64.73	9.55	-4.29	-13.00	-45.44
2509.800	-56.59	-62.45	10.62	-5.20	-13.00	-43.59

Unless otherwise stated the results shown in this test report refer only to the sample(s) tested and such sample(s) are retained for 90 days only.

除非另有說明，此報告結果僅對測試之樣品負責，同時此樣品僅保留90天。本報告未經本公司書面許可，不可部份複製。

This document is issued by the Company subject to its General Conditions of Service printed overleaf, available on request or accessible at <http://www.sgs.com.tw/Terms-and-Conditions> and for electronic format documents, subject to Terms and Conditions for Electronic Documents at <http://www.sgs.com.tw/Terms-and-Conditions>. Attention is drawn to the limitation of liability, indemnification and jurisdiction issues defined therein. Any holder of this document is advised that information contained hereon reflects the Company's findings at the time of its intervention only and within the limits of Client's instructions, if any. The Company's sole responsibility is to its Client and this document does not exonerate parties to a transaction from exercising all their rights and obligations under the transaction documents. This document cannot be reproduced except in full, without prior written approval of the Company. Any unauthorized alteration, forgery or falsification of the content or appearance of this document is unlawful and offenders may be prosecuted to the fullest extent of the law.

Report Number :ER/2021/80081
 Operation Mode :WCDMA B5
 Test Mode :Tx CH High
 EUT Pol :H Plane
 Test Frequency :846.6 MHz

Test Site :SAC 1
 Test Date :2021-09-08
 Temp./Humi. :26.2/60
 Antenna Pol. :Vertical
 Engineer :Neo Tsai

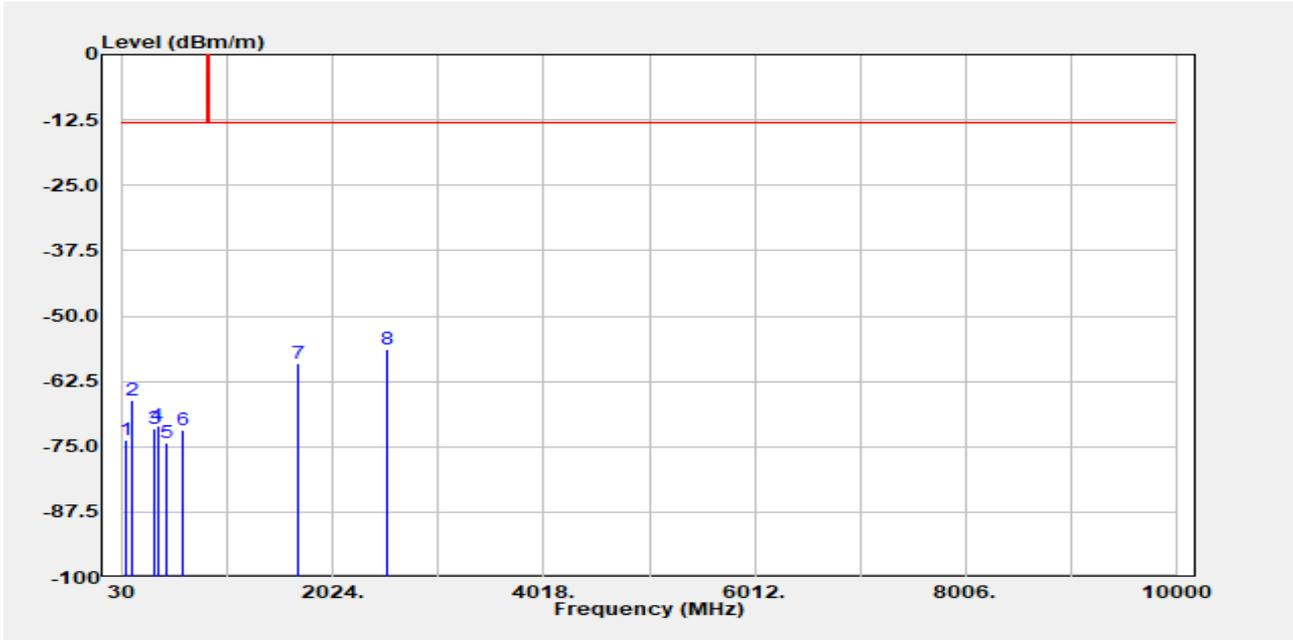

Freq. MHz	EIRP/ERP dBm	SG Output Level dBm	Antenna Gain dBi/dBd	Cable Loss dB	Limit dBm	Margin dB
65.567	-73.65	-64.93	-7.96	-0.79	-13.00	-60.65
122.150	-66.25	-63.26	-1.88	-1.14	-13.00	-53.25
335.550	-71.41	-73.81	4.28	-1.90	-13.00	-58.41
358.183	-71.00	-73.74	4.50	-1.96	-13.00	-58.00
443.867	-74.16	-76.38	4.13	-2.20	-13.00	-61.16
602.300	-71.80	-73.33	3.63	-2.61	-13.00	-58.80
1693.200	-59.18	-65.19	9.59	-4.32	-13.00	-46.18
2539.800	-56.26	-62.05	10.68	-5.23	-13.00	-43.26

Unless otherwise stated the results shown in this test report refer only to the sample(s) tested and such sample(s) are retained for 90 days only.

除非另有說明，此報告結果僅對測試之樣品負責，同時此樣品僅保留90天。本報告未經本公司書面許可，不可部份複製。

This document is issued by the Company subject to its General Conditions of Service printed overleaf, available on request or accessible at <http://www.sgs.com.tw/Terms-and-Conditions> and for electronic format documents, subject to Terms and Conditions for Electronic Documents at <http://www.sgs.com.tw/Terms-and-Conditions>. Attention is drawn to the limitation of liability, indemnification and jurisdiction issues defined therein. Any holder of this document is advised that information contained hereon reflects the Company's findings at the time of its intervention only and within the limits of Client's instructions, if any. The Company's sole responsibility is to its Client and this document does not exonerate parties to a transaction from exercising all their rights and obligations under the transaction documents. This document cannot be reproduced except in full, without prior written approval of the Company. Any unauthorized alteration, forgery or falsification of the content or appearance of this document is unlawful and offenders may be prosecuted to the fullest extent of the law.

Report Number :ER/2021/80081
 Operation Mode :WCDMA B5
 Test Mode :Tx CH High
 EUT Pol :H Plane
 Test Frequency :846.6 MHz

Test Site :SAC 1
 Test Date :2021-09-08
 Temp./Humi. :26.2/60
 Antenna Pol. :Horizontal
 Engineer :Neo Tsai

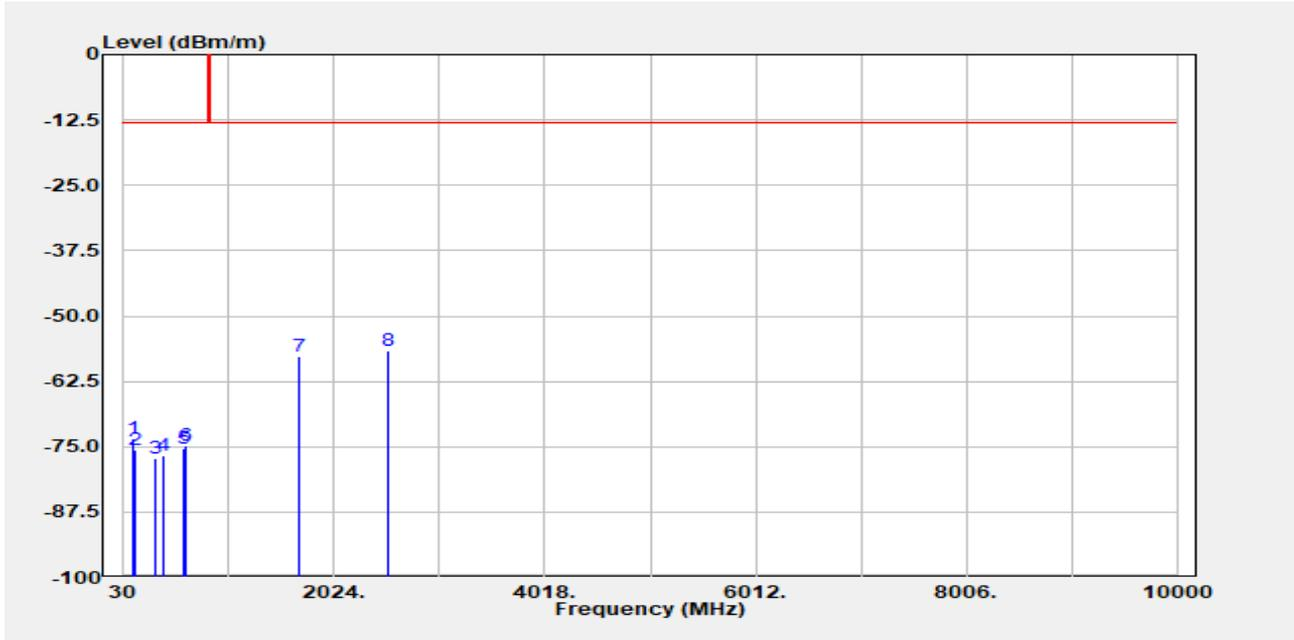

Freq. MHz	EIRP/ERP dBm	SG Output Level dBm	Antenna Gain dBi/dBd	Cable Loss dB	Limit dBm	Margin dB
117.300	-73.57	-70.77	-1.73	-1.11	-13.00	-60.57
143.167	-75.71	-72.58	-1.92	-1.26	-13.00	-62.71
321.000	-77.25	-80.00	4.19	-1.68	-13.00	-64.25
401.833	-76.77	-79.40	4.32	-2.08	-13.00	-63.77
594.217	-75.47	-76.92	3.77	-2.65	-13.00	-62.47
620.083	-74.80	-76.62	3.43	-2.29	-13.00	-61.80
1693.200	-57.71	-63.72	9.59	-4.32	-13.00	-44.71
2539.800	-56.61	-62.40	10.68	-5.23	-13.00	-43.61

Unless otherwise stated the results shown in this test report refer only to the sample(s) tested and such sample(s) are retained for 90 days only.

除非另有說明，此報告結果僅對測試之樣品負責，同時此樣品僅保留90天。本報告未經本公司書面許可，不可部份複製。

This document is issued by the Company subject to its General Conditions of Service printed overleaf, available on request or accessible at <http://www.sgs.com.tw/Terms-and-Conditions> and for electronic format documents, subject to Terms and Conditions for Electronic Documents at <http://www.sgs.com.tw/Terms-and-Conditions>. Attention is drawn to the limitation of liability, indemnification and jurisdiction issues defined therein. Any holder of this document is advised that information contained hereon reflects the Company's findings at the time of its intervention only and within the limits of Client's instructions, if any. The Company's sole responsibility is to its Client and this document does not exonerate parties to a transaction from exercising all their rights and obligations under the transaction documents. This document cannot be reproduced except in full, without prior written approval of the Company. Any unauthorized alteration, forgery or falsification of the content or appearance of this document is unlawful and offenders may be prosecuted to the fullest extent of the law.

10 FREQUENCY STABILITY MEASUREMENT

10.1 Standard Applicabl

The frequency stability shall be sufficient to ensure that the fundamental emission stays within the authorized frequency block.

10.2 Test Set-up

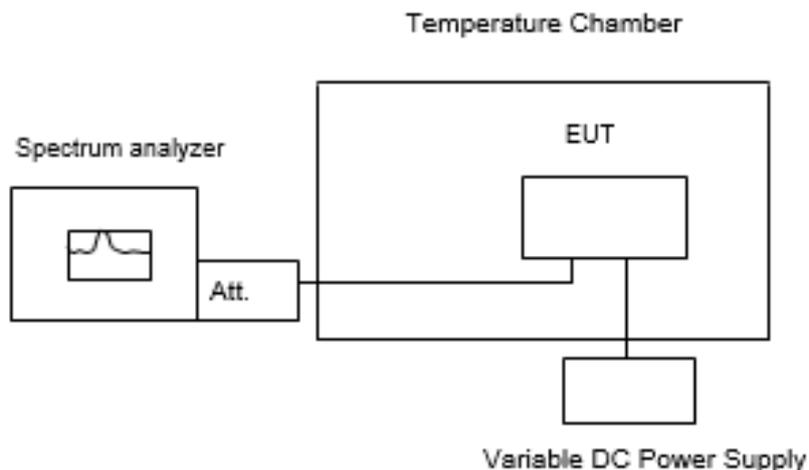

Note: Measurement setup for testing on Antenna connector

10.3 Measurement Procedure

The equipment under test was connected to an external AC or DC power supply and input rated voltage. RF output was connected to a frequency counter or spectrum analyzer via feed through attenuators. The EUT was placed inside the temperature chamber. Set the spectrum analyzer RBW low enough to obtain the desired frequency resolution and measure EUT 25°C operating frequency as reference frequency. Turn EUT off and set the chamber temperature to -30°C. After the temperature stabilized for approximately 30 minutes recorded the frequency. Repeat step measure with 10°C increased per stage until the highest temperature of +50°C reached.

Set chamber temperature to 25°C. Use a variable AC power supply / DC power source to power the EUT and set the voltage to rated voltage. Set the spectrum analyzer RBW low enough to obtain the desired frequency resolution and recorded the frequency.

Reduce the input voltage to specify extreme voltage variation (+/- 15%) and endpoint as declared by the manufacturer, record the maximum frequency change.

Unless otherwise stated the results shown in this test report refer only to the sample(s) tested and such sample(s) are retained for 90 days only.

除非另有說明，此報告結果僅對測試之樣品負責，同時此樣品僅保留90天。本報告未經本公司書面許可，不可部份複製。

This document is issued by the Company subject to its General Conditions of Service printed overleaf, available on request or accessible at <http://www.sgs.com.tw/Terms-and-Conditions> and for electronic format documents, subject to Terms and Conditions for Electronic Documents at <http://www.sgs.com.tw/Terms-and-Conditions>. Attention is drawn to the limitation of liability, indemnification and jurisdiction issues defined therein. Any holder of this document is advised that information contained hereon reflects the Company's findings at the time of its intervention only and within the limits of Client's instructions, if any. The Company's sole responsibility is to its Client and this document does not exonerate parties to a transaction from exercising all their rights and obligations under the transaction documents. This document cannot be reproduced except in full, without prior written approval of the Company. Any unauthorized alteration, forgery or falsification of the content or appearance of this document is unlawful and offenders may be prosecuted to the fullest extent of the law.

10.4 Measurement Equipment Used

Conducted Emission Test Site: Conducted 4					
EQUIPMENT TYPE	MFR	MODEL NUMBER	SERIAL NUMBER	LAST CAL.	CAL DUE.
PXA Spectrum Analyzer	Agilent	N9030A	MY53120760	04/27/2021	04/26/2022
Radio Communication Analyzer	Anritsu	MT8815B	6200711454	04/07/2021	04/06/2022
Test Software	WORLD-PALLAS TECH. CO., LTD.	Dr.E	Ver. 3.0	N.C.R	N.C.R
Temperature Chamber	Giant Force	GTH-150-40-CP-AR	MAA0512-018	05/19/2021	05/18/2022
Attenuator	Mini-Circuit	BW-S10W2+	4	12/16/2020	12/15/2021
DC Block	Mini-Circuits	BLK-18-S+	1	12/16/2020	12/15/2021
Power Divider	RF-LAM-BAD	RFLT2W1G18G	11-JSPF412-017	12/16/2020	12/15/2021
DC Power Supply	Agilent	E3640A	MY40005907	10/29/2020	10/28/2021

10.5 Measurement Result

Note: The battery is rated 7.66V dc.

Unless otherwise stated the results shown in this test report refer only to the sample(s) tested and such sample(s) are retained for 90 days only.

除非另有說明，此報告結果僅對測試之樣品負責，同時此樣品僅保留90天。本報告未經本公司書面許可，不可部份複製。

This document is issued by the Company subject to its General Conditions of Service printed overleaf, available on request or accessible at <http://www.sgs.com.tw/Terms-and-Conditions> and for electronic format documents, subject to Terms and Conditions for Electronic Documents at <http://www.sgs.com.tw/Terms-and-Conditions>. Attention is drawn to the limitation of liability, indemnification and jurisdiction issues defined therein. Any holder of this document is advised that information contained hereon reflects the Company's findings at the time of its intervention only and within the limits of Client's instructions, if any. The Company's sole responsibility is to its Client and this document does not exonerate parties to a transaction from exercising all their rights and obligations under the transaction documents. This document cannot be reproduced except in full, without prior written approval of the Company. Any unauthorized alteration, forgery or falsification of the content or appearance of this document is unlawful and offenders may be prosecuted to the fullest extent of the law.

WCDMA II Mid Channel 1880 MHz				
Limit: +/- 2.5 ppm				
Vdc	Temp. (°C)	Freq. (MHz)	Delta (Hz)	Limit (Hz)
FREQUENCY ERROR vs. VOLTAGE				
8.809	20	1880.000009	9	4700
7.66	20	1879.999993	-7	4700
6.511	20	1880.000004	4	4700
6.3 (End point)	20	1880.000008	8	4700
FREQUENCY ERROR vs. Temp.				
7.66	50	1880.00001	10	4700
7.66	40	1879.999998	-2	4700
7.66	30	1879.999989	-11	4700
7.66	20	1880.00001	10	4700
7.66	10	1879.999989	-11	4700
7.66	0	1879.999989	-11	4700
7.66	-10	1880.000006	6	4700
7.66	-20	1880.000005	5	4700
7.66	-30	1880.000007	7	4700

Unless otherwise stated the results shown in this test report refer only to the sample(s) tested and such sample(s) are retained for 90 days only.

除非另有說明，此報告結果僅對測試之樣品負責，同時此樣品僅保留90天。本報告未經本公司書面許可，不可部份複製。

This document is issued by the Company subject to its General Conditions of Service printed overleaf, available on request or accessible at <http://www.sgs.com.tw/Terms-and-Conditions> and for electronic format documents, subject to Terms and Conditions for Electronic Documents at <http://www.sgs.com.tw/Terms-and-Conditions>. Attention is drawn to the limitation of liability, indemnification and jurisdiction issues defined therein. Any holder of this document is advised that information contained hereon reflects the Company's findings at the time of its intervention only and within the limits of Client's instructions, if any. The Company's sole responsibility is to its Client and this document does not exonerate parties to a transaction from exercising all their rights and obligations under the transaction documents. This document cannot be reproduced except in full, without prior written approval of the Company. Any unauthorized alteration, forgery or falsification of the content or appearance of this document is unlawful and offenders may be prosecuted to the fullest extent of the law.

WCDMA V Mid Channel 836.6 MHz				
Limit: +/- 2.5 ppm				
Vdc	Temp. (°C)	Freq. (MHz)	Delta (Hz)	Limit (Hz)
FREQUENCY ERROR vs. VOLTAGE				
8.809	20	836.599994	-6	2091
7.66	20	836.599992	-8	2091
6.511	20	836.600002	2	2091
6.3 (End point)	20	836.599996	-4	2091
FREQUENCY ERROR vs. Temp.				
7.66	50	836.600002	2	2091
7.66	40	836.599994	-6	2091
7.66	30	836.600009	9	2091
7.66	20	836.599995	-5	2091
7.66	10	836.600001	10	2091
7.66	0	836.600009	9	2091
7.66	-10	836.600001	10	2091
7.66	-20	836.599995	-5	2091
7.66	-30	836.599998	-2	2091

Unless otherwise stated the results shown in this test report refer only to the sample(s) tested and such sample(s) are retained for 90 days only.

除非另有說明，此報告結果僅對測試之樣品負責，同時此樣品僅保留90天。本報告未經本公司書面許可，不可部份複製。

This document is issued by the Company subject to its General Conditions of Service printed overleaf, available on request or accessible at <http://www.sgs.com.tw/Terms-and-Conditions> and for electronic format documents, subject to Terms and Conditions for Electronic Documents at <http://www.sgs.com.tw/Terms-and-Conditions>. Attention is drawn to the limitation of liability, indemnification and jurisdiction issues defined therein. Any holder of this document is advised that information contained hereon reflects the Company's findings at the time of its intervention only and within the limits of Client's instructions, if any. The Company's sole responsibility is to its Client and this document does not exonerate parties to a transaction from exercising all their rights and obligations under the transaction documents. This document cannot be reproduced except in full, without prior written approval of the Company. Any unauthorized alteration, forgery or falsification of the content or appearance of this document is unlawful and offenders may be prosecuted to the fullest extent of the law.

11 PEAK TO AVERAGE RATIO

11.1 Standard Applicable

The peak-to-average ratio (PAR) of the transmission may not exceed 13dB.

11.2 Test SET-UP

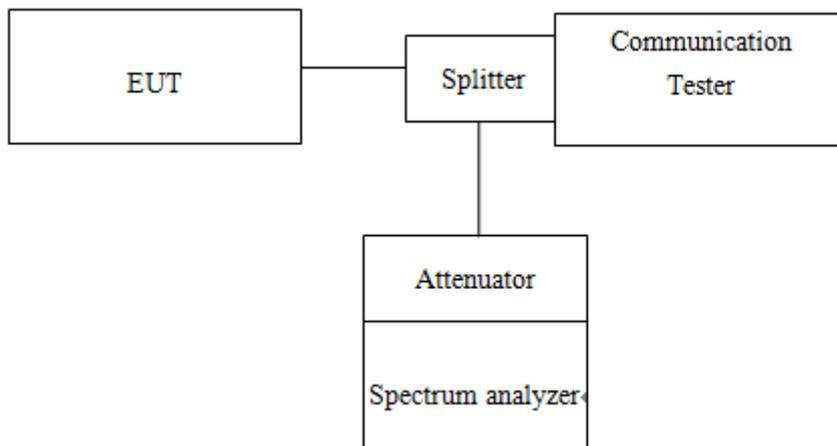

11.3 Measurement Procedure

1. KDB 971168 D01 is employed as the following procedure is proper adjusted accordingly:
2. Set resolution/measurement bandwidth \geq signal's occupied bandwidth; & internal =1ms
3. Set the number of counts to a value that stabilizes the measured CCDF curve.

11.4 Measurement Equipment Used

Conducted Emission Test Site: Conducted 4					
EQUIPMENT TYPE	MFR	MODEL NUMBER	SERIAL NUMBER	LAST CAL.	CAL DUE.
PXA Spectrum Analyzer	Agilent	N9030A	MY53120760	04/27/2021	04/26/2022
Radio Communication Analyzer	Anritsu	MT8815B	6200711454	04/07/2021	04/06/2022
Test Software	WORLD-PALLAS TECH. CO., LTD.	Dr.E	Ver. 3.0	N.C.R	N.C.R
Temperature Chamber	Giant Force	GTH-150-40-CP-AR	MAA0512-018	05/19/2021	05/18/2022
Attenuator	Mini-Circuit	BW-S10W2+	4	12/16/2020	12/15/2021
DC Block	Mini-Circuits	BLK-18-S+	1	12/16/2020	12/15/2021
Power Divider	RF-LAMBAD	RFLT2W1G18G	11-JSPF412-017	12/16/2020	12/15/2021
DC Power Supply	Agilent	E3640A	MY40005907	10/29/2020	10/28/2021

Unless otherwise stated the results shown in this test report refer only to the sample(s) tested and such sample(s) are retained for 90 days only.

除非另有說明，此報告結果僅對測試之樣品負責，同時此樣品僅保留90天。本報告未經本公司書面許可，不可部份複製。

This document is issued by the Company subject to its General Conditions of Service printed overleaf, available on request or accessible at <http://www.sgs.com.tw/Terms-and-Conditions> and for electronic format documents, subject to Terms and Conditions for Electronic Documents at <http://www.sgs.com.tw/Terms-and-Conditions>. Attention is drawn to the limitation of liability, indemnification and jurisdiction issues defined therein. Any holder of this document is advised that information contained hereon reflects the Company's findings at the time of its intervention only and within the limits of Client's instructions, if any. The Company's sole responsibility is to its Client and this document does not exonerate parties to a transaction from exercising all their rights and obligations under the transaction documents. This document cannot be reproduced except in full, without prior written approval of the Company. Any unauthorized alteration, forgery or falsification of the content or appearance of this document is unlawful and offenders may be prosecuted to the fullest extent of the law.

11.5 Measurement Result

Freq. (MHz)	CH	Peak-to-Average Ratio (dB)		
		WCDMA II	HSDPA II	HSUPA II
1852.4	9262	3.02	4.00	3.58
1880	9400	2.90	4.13	3.66
1907.6	9538	3.04	4.01	3.72

Freq. (MHz)	CH	Peak-to-Average Ratio (dB)		
		WCDMA V	HSDPA V	HSUPA V
826.4	4132	3.02	3.86	3.69
836.6	4183	2.99	3.63	3.77
846.6	4233	3.01	4.10	3.75

Unless otherwise stated the results shown in this test report refer only to the sample(s) tested and such sample(s) are retained for 90 days only.

除非另有說明，此報告結果僅對測試之樣品負責，同時此樣品僅保留90天。本報告未經本公司書面許可，不可部份複製。

This document is issued by the Company subject to its General Conditions of Service printed overleaf, available on request or accessible at <http://www.sgs.com.tw/Terms-and-Conditions> and for electronic format documents, subject to Terms and Conditions for Electronic Documents at <http://www.sgs.com.tw/Terms-and-Conditions>. Attention is drawn to the limitation of liability, indemnification and jurisdiction issues defined therein. Any holder of this document is advised that information contained hereon reflects the Company's findings at the time of its intervention only and within the limits of Client's instructions, if any. The Company's sole responsibility is to its Client and this document does not exonerate parties to a transaction from exercising all their rights and obligations under the transaction documents. This document cannot be reproduced except in full, without prior written approval of the Company. Any unauthorized alteration, forgery or falsification of the content or appearance of this document is unlawful and offenders may be prosecuted to the fullest extent of the law.

WCDMA B2 LowCH9262-1852.4

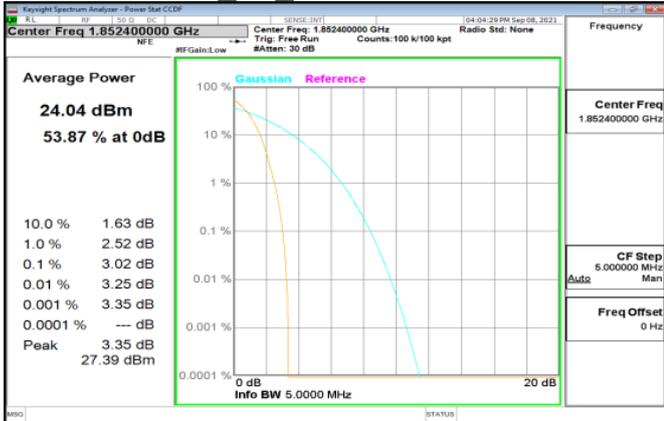

HSDPA B2 LowCH9262-1852.4

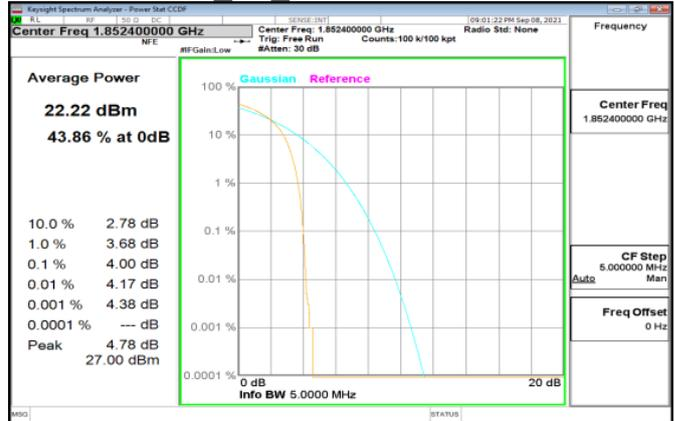

WCDMA B2 MidCH9400-1880

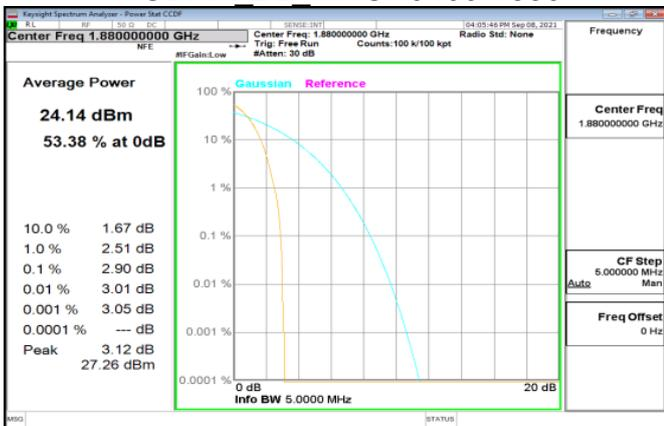

HSDPA B2 MidCH9400-1880

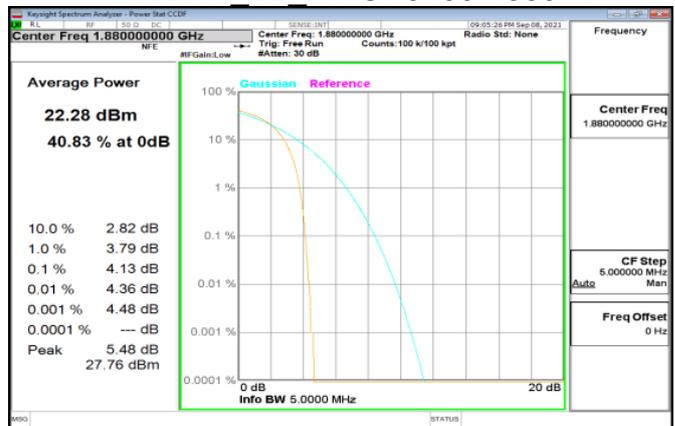

WCDMA B2 HighCH9538-1907.6

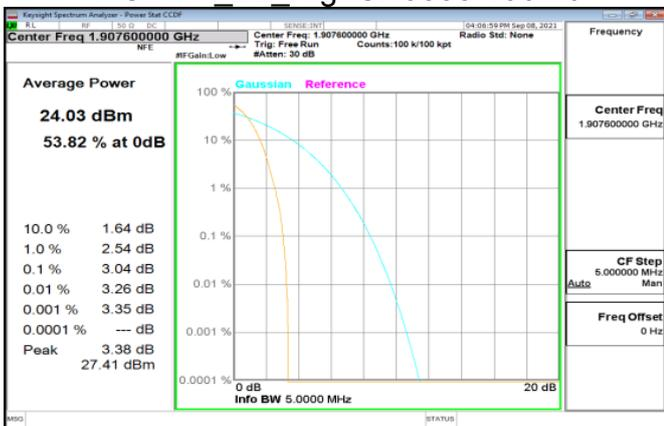

HSDPA B2 HighCH9538-1907.6



Unless otherwise stated the results shown in this test report refer only to the sample(s) tested and such sample(s) are retained for 90 days only.

除非另有說明，此報告結果僅對測試之樣品負責，同時此樣品僅保留90天。本報告未經本公司書面許可，不可部份複製。
This document is issued by the Company subject to its General Conditions of Service printed overleaf, available on request or accessible at <http://www.sgs.com.tw/Terms-and-Conditions> and for electronic format documents, subject to Terms and Conditions for Electronic Documents at <http://www.sgs.com.tw/Terms-and-Conditions>. Attention is drawn to the limitation of liability, indemnification and jurisdiction issues defined therein. Any holder of this document is advised that information contained herein reflects the Company's findings at the time of its intervention only and within the limits of Client's instructions, if any. The Company's sole responsibility is to its Client and this document does not exonerate parties to a transaction from exercising all their rights and obligations under the transaction documents. This document cannot be reproduced except in full, without prior written approval of the Company. Any unauthorized alteration, forgery or falsification of the content or appearance of this document is unlawful and offenders may be prosecuted to the fullest extent of the law.

HSUPA B2 LowCH9262-1852.4

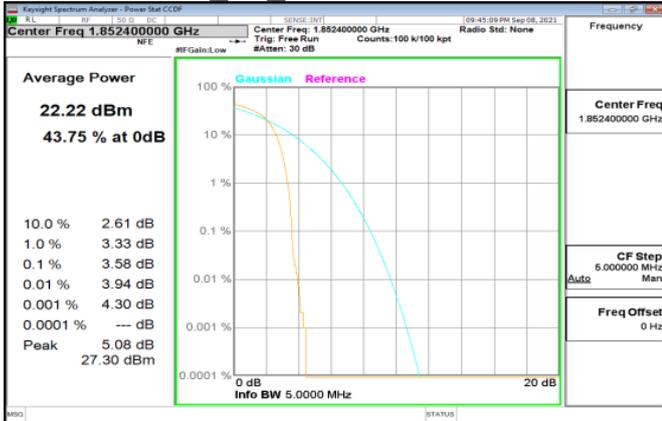

WCDMA B5 LowCH4132-826.4

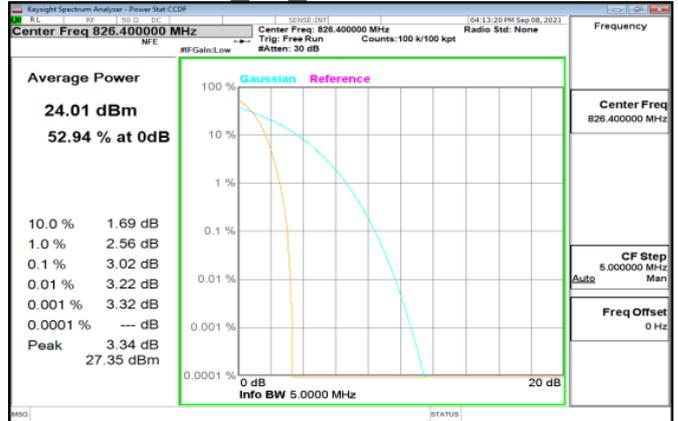

HSUPA B2 MidCH9400-1880

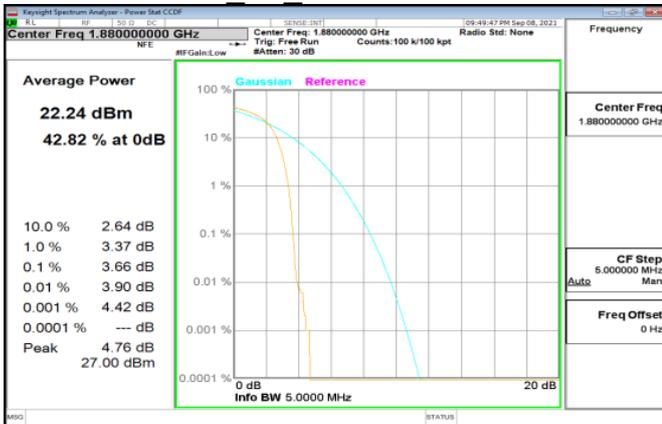

WCDMA B5 MidCH4183-836.6

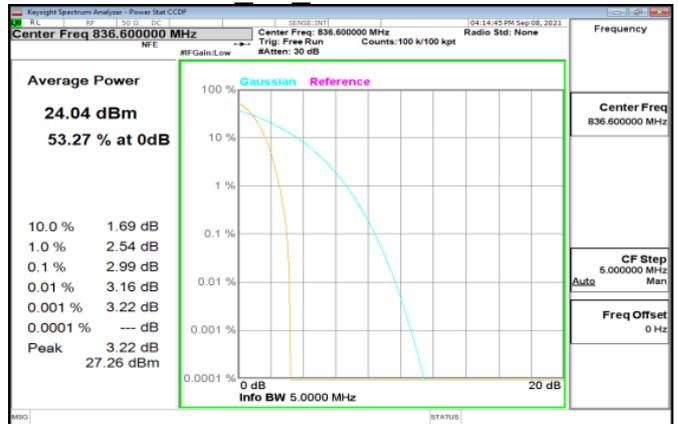

HSUPA B2 HighCH9538-1907.6

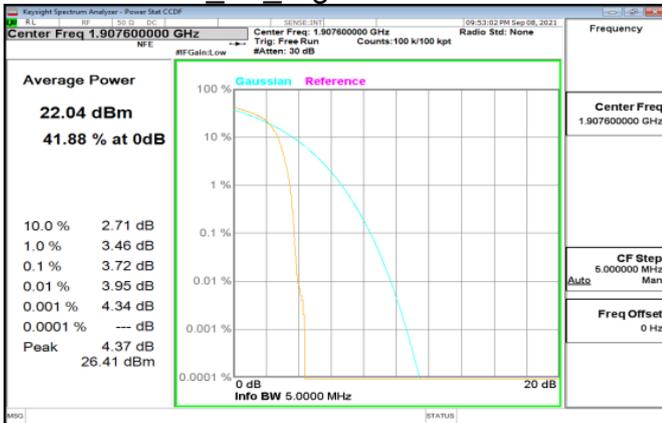

WCDMA B5 HighCH4233-846.6

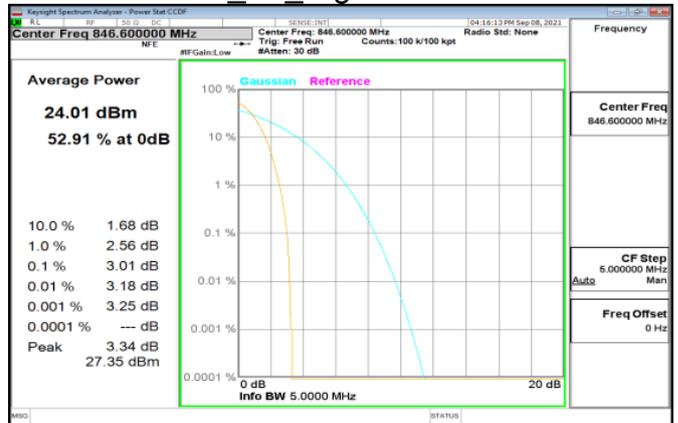

Unless otherwise stated the results shown in this test report refer only to the sample(s) tested and such sample(s) are retained for 90 days only.

除非另有說明，此報告結果僅對測試之樣品負責，同時此樣品僅保留90天。本報告未經本公司書面許可，不可部份複製。

This document is issued by the Company subject to its General Conditions of Service printed overleaf, available on request or accessible at <http://www.sgs.com.tw/Terms-and-Conditions> and for electronic format documents, subject to Terms and Conditions for Electronic Documents at <http://www.sgs.com.tw/Terms-and-Conditions>. Attention is drawn to the limitation of liability, indemnification and jurisdiction issues defined therein. Any holder of this document is advised that information contained herein reflects the Company's findings at the time of its intervention only and within the limits of Client's instructions, if any. The Company's sole responsibility is to its Client and this document does not exonerate parties to a transaction from exercising all their rights and obligations under the transaction documents. This document cannot be reproduced except in full, without prior written approval of the Company. Any unauthorized alteration, forgery or falsification of the content or appearance of this document is unlawful and offenders may be prosecuted to the fullest extent of the law.

HSDPA B5 LowCH4132-826.4

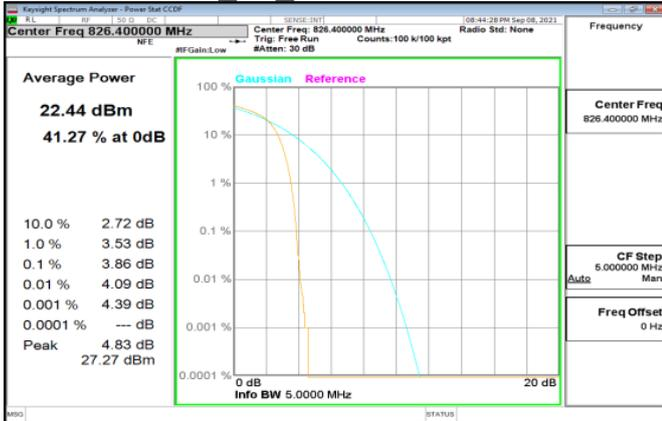

HSUPA B5 LowCH4132-826.4

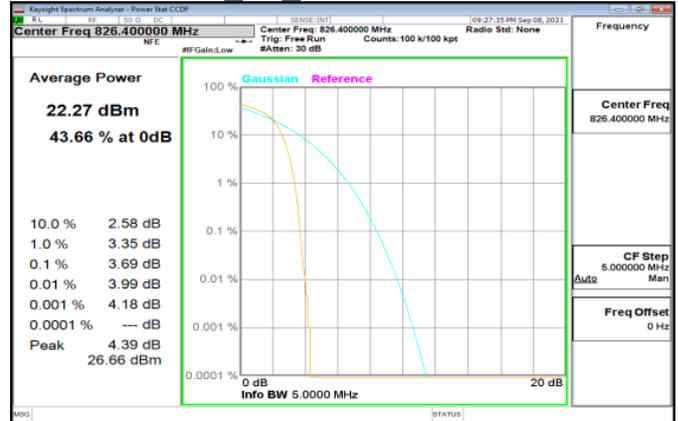

HSDPA B5 MidCH4183-836.6

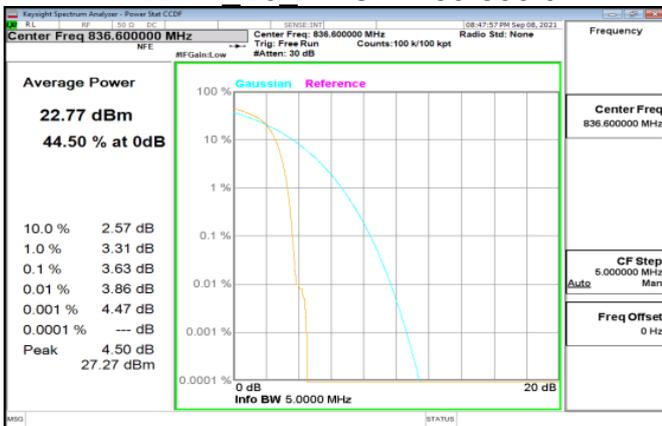

HSUPA B5 MidCH4183-836.6

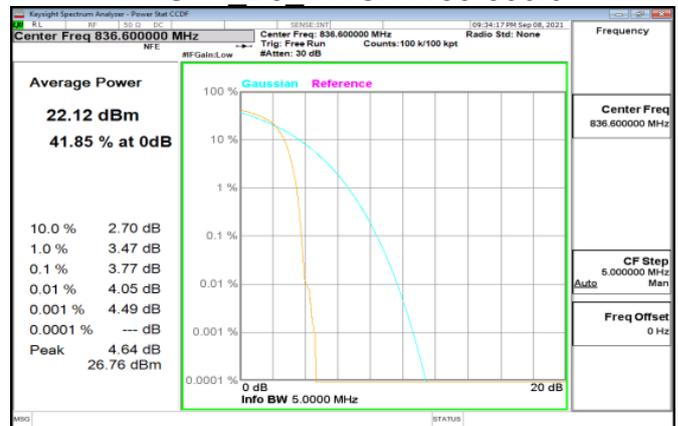

HSDPA B5 HighCH4233-846.6

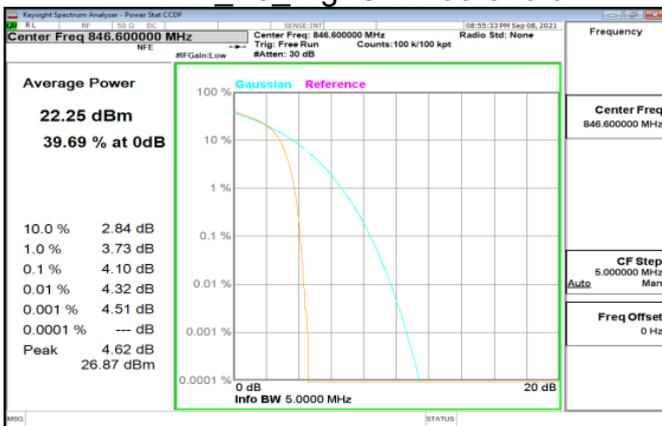

HSUPA B5 HighCH4233-846.6



Unless otherwise stated the results shown in this test report refer only to the sample(s) tested and such sample(s) are retained for 90 days only.

除非另有說明，此報告結果僅對測試之樣品負責，同時此樣品僅保留90天。本報告未經本公司書面許可，不可部份複製。

This document is issued by the Company subject to its General Conditions of Service printed overleaf, available on request or accessible at <http://www.sgs.com.tw/Terms-and-Conditions> and for electronic format documents, subject to Terms and Conditions for Electronic Documents at <http://www.sgs.com.tw/Terms-and-Conditions>. Attention is drawn to the limitation of liability, indemnification and jurisdiction issues defined therein. Any holder of this document is advised that information contained herein reflects the Company's findings at the time of its intervention only and within the limits of Client's instructions, if any. The Company's sole responsibility is to its Client and this document does not exonerate parties to a transaction from exercising all their rights and obligations under the transaction documents. This document cannot be reproduced except in full, without prior written approval of the Company. Any unauthorized alteration, forgery or falsification of the content or appearance of this document is unlawful and offenders may be prosecuted to the fullest extent of the law.

~ End of Report ~

Unless otherwise stated the results shown in this test report refer only to the sample(s) tested and such sample(s) are retained for 90 days only.

除非另有說明，此報告結果僅對測試之樣品負責，同時此樣品僅保留90天。本報告未經本公司書面許可，不可部份複製。

This document is issued by the Company subject to its General Conditions of Service printed overleaf, available on request or accessible at <http://www.sgs.com.tw/Terms-and-Conditions> and for electronic format documents, subject to Terms and Conditions for Electronic Documents at <http://www.sgs.com.tw/Terms-and-Conditions>. Attention is drawn to the limitation of liability, indemnification and jurisdiction issues defined therein. Any holder of this document is advised that information contained hereon reflects the Company's findings at the time of its intervention only and within the limits of Client's instructions, if any. The Company's sole responsibility is to its Client and this document does not exonerate parties to a transaction from exercising all their rights and obligations under the transaction documents. This document cannot be reproduced except in full, without prior written approval of the Company. Any unauthorized alteration, forgery or falsification of the content or appearance of this document is unlawful and offenders may be prosecuted to the fullest extent of the law.