

## FCC Test Report (BT-EDR)

**Report No.:** RFBIED-WTW-P21020590

**FCC ID:** C3K1998

**Test Model:** 1998

**Received Date:** Feb. 17, 2021

**Test Date:** Mar. 10 to 15, 2021

**Issued Date:** Mar. 19, 2021

**Applicant:** MICROSOFT CORPORATION

**Address:** ONE MICROSOFT WAY REDMOND, WA 98052-6399 USA

**Issued By:** Bureau Veritas Consumer Products Services (H.K.) Ltd., Taoyuan Branch  
Lin Kou Laboratories

**Lab Address:** No. 47-2, 14th Ling, Chia Pau Vil., Lin Kou Dist., New Taipei City, Taiwan

**FCC Registration /  
Designation Number:** 198487 / TW2021



This report is for your exclusive use. Any copying or replication of this report to or for any other person or entity, or use of our name or trademark, is permitted only with our prior written permission. This report sets forth our findings solely with respect to the test samples identified herein. The results set forth in this report are not indicative or representative of the quality or characteristics of the lot from which a test sample was taken or any similar or identical product unless specifically and expressly noted. Our report includes all of the tests requested by you and the results thereof based upon the information that you provided to us. You have 60 days from date of issuance of this report to notify us of any material error or omission caused by our negligence, provided, however, that such notice shall be in writing and shall specifically address the issue you wish to raise. A failure to raise such issue within the prescribed time shall constitute your unqualified acceptance of the completeness of this report, the tests conducted and the correctness of the report contents. Unless specifically mentioned, the uncertainty of measurement has been explicitly taken into account to declare the compliance or non-compliance to the specification.

## Table of Contents

<b>Release Control Record</b> .....	<b>4</b>
<b>1 Certificate of Conformity</b> .....	<b>5</b>
<b>2 Summary of Test Results</b> .....	<b>6</b>
2.1 Measurement Uncertainty.....	6
2.2 Modification Record.....	6
<b>3 General Information</b> .....	<b>7</b>
3.1 General Description of EUT.....	7
3.2 Description of Test Modes.....	8
3.2.1 Test Mode Applicability and Tested Channel Detail.....	9
3.3 Description of Support Units.....	11
3.3.1 Configuration of System under Test.....	11
3.4 General Description of Applied Standards and References.....	12
<b>4 Test Types and Results</b> .....	<b>13</b>
4.1 Radiated Emission and Bandedge Measurement.....	13
4.1.1 Limits of Radiated Emission and Bandedge Measurement.....	13
4.1.2 Test Instruments.....	14
4.1.3 Test Procedures.....	15
4.1.4 Deviation from Test Standard.....	15
4.1.5 Test Setup.....	16
4.1.6 EUT Operating Conditions.....	17
4.1.7 Test Results.....	18
4.2 Conducted Emission Measurement.....	27
4.2.1 Limits of Conducted Emission Measurement.....	27
4.2.2 Test Instruments.....	27
4.2.3 Test Procedures.....	28
4.2.4 Deviation From Test Standard.....	28
4.2.5 Test Setup.....	28
4.2.6 EUT Operating Condition.....	28
4.2.7 Test Results.....	29
4.3 Number of Hopping Frequency Used.....	33
4.3.1 Limits of Hopping Frequency Used Measurement.....	33
4.3.2 Test Setup.....	33
4.3.3 Test Instruments.....	33
4.3.4 Test Procedure.....	33
4.3.5 Deviation from Test Standard.....	33
4.3.6 Test Results.....	34
4.4 Dwell Time on Each Channel.....	35
4.4.1 Limits of Dwell Time on Each Channel Measurement.....	35
4.4.2 Test Setup.....	35
4.4.3 Test Instruments.....	35
4.4.4 Test Procedures.....	35
4.4.5 Deviation from Test Standard.....	35
4.4.6 Test Results.....	36
4.5 Channel Bandwidth.....	38
4.5.1 Limits of Channel Bandwidth Measurement.....	38
4.5.2 Test Setup.....	38
4.5.3 Test Instruments.....	38
4.5.4 Test Procedure.....	38
4.5.5 Deviation from Test Standard.....	38
4.5.6 EUT Operating Condition.....	38
4.5.7 Test Results.....	39
4.6 Hopping Channel Separation.....	40

4.6.1	Limits of Hopping Channel Separation Measurement.....	40
4.6.2	Test Setup.....	40
4.6.3	Test Instruments .....	40
4.6.4	Test Procedure .....	40
4.6.5	Deviation from Test Standard .....	40
4.6.6	Test Results .....	41
4.7	Maximum Output Power Measurement .....	42
4.7.1	Limits of Maximum Output Power Measurement .....	42
4.7.2	Test Setup.....	42
4.7.3	Test Instruments .....	42
4.7.4	Test Procedure .....	42
4.7.5	Deviation from Test Standard .....	42
4.7.6	EUT Operating Condition .....	42
4.7.7	Test Results .....	43
4.8	Conducted Out of Band Emission Measurement.....	44
4.8.1	Limits of Conducted Out of Band Emission Measurement.....	44
4.8.2	Test Instruments .....	44
4.8.3	Test Procedure .....	44
4.8.4	Deviation from Test Standard .....	44
4.8.5	EUT Operating Condition .....	44
4.8.6	Test Results .....	44
<b>5</b>	<b>Pictures of Test Arrangements.....</b>	<b>47</b>
	<b>Annex A - Bandedge Measurement .....</b>	<b>48</b>
	<b>Appendix – Information of the Testing Laboratories .....</b>	<b>50</b>

### Release Control Record

Issue No.	Description	Date Issued
RFBIED-WTW-P21020590	Original release.	Mar. 19, 2021

## 1 Certificate of Conformity

**Product:** Headset

**Brand:** Microsoft

**Test Model:** 1998

**Sample Status:** Engineering sample

**Applicant:** MICROSOFT CORPORATION

**Test Date:** Mar. 10 to 15, 2021

**Standards:** 47 CFR FCC Part 15, Subpart C (Section 15.247)  
ANSI C63.10: 2013

The above equipment has been tested by **Bureau Veritas Consumer Products Services (H.K.) Ltd., Taoyuan Branch**, and found compliance with the requirement of the above standards. The test record, data evaluation & Equipment Under Test (EUT) configurations represented herein are true and accurate accounts of the measurements of the sample's RF characteristics under the conditions specified in this report.

**Prepared by :**

*Annie Chang*

**Date:**

Mar. 19, 2021

Annie Chang / Senior Specialist

**Approved by :**

*Rex Lai*

**Date:**

Mar. 19, 2021

Rex Lai / Associate Technical Manager

## 2 Summary of Test Results

47 CFR FCC Part 15, Subpart C (Section 15.247)			
FCC Clause	Test Item	Result	Remarks
15.207	AC Power Conducted Emission	Pass	Meet the requirement of limit. Minimum passing margin is -16.38dB at 0.15781MHz.
15.247(a)(1)(iii)	Number of Hopping Frequency Used	Pass	Meet the requirement of limit.
15.247(a)(1)(iii)	Dwell Time on Each Channel	Pass	Meet the requirement of limit.
15.247(a)(1)	1. Hopping Channel Separation 2. Spectrum Bandwidth of a Frequency Hopping Sequence Spread Spectrum System	Pass	Meet the requirement of limit.
15.247(b)	Maximum Peak Output Power	Pass	Meet the requirement of limit.
15.205 & 209 & 15.247(d)	Radiated Emissions & Band Edge Measurement	Pass	Meet the requirement of limit. Minimum passing margin is -12.00dB at 879.72MHz.
15.247(d)	Antenna Port Emission	Pass	Meet the requirement of limit.
15.203	Antenna Requirement	Pass	No antenna connector is used.

### NOTE:

- Determining compliance based on the results of the compliance measurement, not taking into account measurement instrumentation uncertainty.
- If The Frequency Hopping System operating in 2400-2483.5MHz band and the output power less than 125mW. The hopping channel carrier frequencies separated by a minimum of 25kHz or two-thirds of the 20dB bandwidth of hopping channel whichever is greater.
- For 2.4GHz band compliance with rule 15.247(d) of the band-edge items, the test plots were recorded in Annex A. Test Procedures refer to report 4.1.3.

### 2.1 Measurement Uncertainty

Where relevant, the following measurement uncertainty levels have been estimated for tests performed on the EUT as specified in CISPR 16-4-2:

Measurement	Frequency	Expanded Uncertainty (k=2) ( $\pm$ )
Conducted Emissions at mains ports	150kHz ~ 30MHz	3.00 dB
Conducted Emissions	9kHz ~ 40GHz	2.63 dB
Radiated Emissions up to 1 GHz	9kHz ~ 30MHz	2.61 dB
	30MHz ~ 1GHz	5.43 dB
Radiated Emissions above 1 GHz	Above 1GHz	5.42 dB

### 2.2 Modification Record

There were no modifications required for compliance.

### 3 General Information

#### 3.1 General Description of EUT

Product	Headset
Brand	Microsoft
Test Model	1998
Status of EUT	Engineering sample
Power Supply Rating	3.7Vdc from Battery or 5Vdc from USB port
Modulation Type	GFSK, $\pi/4$ -DQPSK, 8DPSK
Modulation Technology	FHSS
Transfer Rate	Up to 3Mbps
Operating Frequency	2402MHz ~ 2480MHz
Number of Channel	79
Output Power	6.368mW
Antenna Type	Chip antenna with 1.38dBi gain
Antenna Connector	N/A
Accessory Device	N/A
Data Cable Supplied	Shielded USB Type C cable (1.5m)

Note:

1. The above Antenna information is declared by manufacturer and for more detailed features description, please refer to the manufacturer's specifications, the laboratory shall not be held responsible.

2. The EUT uses following rechargeable battery.

Manufacturer	Dongguan Amperex Technology Limited
Model	562438P
Rating	3.7Vdc, 579mAh

3. The EUT was pre-tested with the following modes:

- ✧ Operating Mode (EUT Stand-alone)
- ✧ Operating + Charging Mode (Powered from Adapter)
- ✧ Operating + Charging Mode (Powered from Notebook)

The worst emission level was found when the EUT tested under **Operating + Charging Mode (Powered from Notebook)** therefore, only its test data was recorded in this report.

4. The above EUT information is declared by manufacturer and for more detailed features description, please refer to the manufacturer's specifications or User's Manual.

### 3.2 Description of Test Modes

79 channels are provided for BT-EDR mode:

Channel	Freq. (MHz)	Channel	Freq. (MHz)	Channel	Freq. (MHz)	Channel	Freq. (MHz)
0	2402	20	2422	40	2442	60	2462
1	2403	21	2423	41	2443	61	2463
2	2404	22	2424	42	2444	62	2464
3	2405	23	2425	43	2445	63	2465
4	2406	24	2426	44	2446	64	2466
5	2407	25	2427	45	2447	65	2467
6	2408	26	2428	46	2448	66	2468
7	2409	27	2429	47	2449	67	2469
8	2410	28	2430	48	2450	68	2470
9	2411	29	2431	49	2451	69	2471
10	2412	30	2432	50	2452	70	2472
11	2413	31	2433	51	2453	71	2473
12	2414	32	2434	52	2454	72	2474
13	2415	33	2435	53	2455	73	2475
14	2416	34	2436	54	2456	74	2476
15	2417	35	2437	55	2457	75	2477
16	2418	36	2438	56	2458	76	2478
17	2419	37	2439	57	2459	77	2479
18	2420	38	2440	58	2460	78	2480
19	2421	39	2441	59	2461		



### 3.2.1 Test Mode Applicability and Tested Channel Detail

EUT Configure Mode	Applicable To				Description
	RE $\geq$ 1G	RE $<$ 1G	PLC	APCM	
A	√	√	√	√	Operating + Charging Mode (Powered from Notebook)
B	-	-	√	-	Operating + Charging Mode (Powered from Adapter)

Where **RE $\geq$ 1G**: Radiated Emission above 1GHz      **RE $<$ 1G**: Radiated Emission below 1GHz  
**PLC**: Power Line Conducted Emission      **APCM**: Antenna Port Conducted Measurement

**NOTE**: The EUT had been pre-tested on the positioned of each 3 axis. The worst case was found when positioned on **Z-plane**.

#### Radiated Emission Test (Above 1GHz):

- Pre-Scan has been conducted to determine the worst-case mode from all possible combinations between available modulations, data rates and antenna ports (if EUT with antenna diversity architecture).
- Following channel(s) was (were) selected for the final test as listed below.

EUT Configure Mode	Available Channel	Tested Channel	Modulation Technology	Modulation Type	Packet Type
A	0 to 78	0, 39, 78	FHSS	GFSK	DH5
A	0 to 78	0, 39, 78	FHSS	8DPSK	3DH5

#### Radiated Emission Test (Below 1GHz):

- Pre-Scan has been conducted to determine the worst-case mode from all possible combinations between available modulations, data rates and antenna ports (if EUT with antenna diversity architecture).
- Following channel(s) was (were) selected for the final test as listed below.

EUT Configure Mode	Available Channel	Tested Channel	Modulation Technology	Modulation Type	Packet Type
A	0 to 78	0	FHSS	GFSK	DH5

#### Power Line Conducted Emission Test:

- Pre-Scan has been conducted to determine the worst-case mode from all possible combinations between available modulations, data rates and antenna ports (if EUT with antenna diversity architecture).
- Following channel(s) was (were) selected for the final test as listed below.

EUT Configure Mode	Available Channel	Tested Channel	Modulation Technology	Modulation Type	Packet Type
A & B	0 to 78	0	FHSS	GFSK	DH5

**Antenna Port Conducted Measurement:**

- This item includes all test value of each mode, but only includes spectrum plot of worst value of each mode.
- Pre-Scan has been conducted to determine the worst-case mode from all possible combinations between available modulations, data rates and antenna ports (if EUT with antenna diversity architecture).
- Following channel(s) was (were) selected for the final test as listed below.

EUT Configure Mode	Available Channel	Tested Channel	Modulation Technology	Modulation Type	Packet Type
A	0 to 78	0, 39, 78	FHSS	GFSK	DH5
A	0 to 78	0, 39, 78	FHSS	8DPSK	3DH5

**Test Condition:**

Applicable To	EUT Configure Mode	Environmental Conditions	Input Power	Tested By
RE $\geq$ 1G	A	18deg. C, 77%RH	120Vac, 60Hz (System)	Ian Chang
RE<1G	A	18deg. C, 77%RH	120Vac, 60Hz (System)	Ian Chang
PLC	A	25deg. C, 75%RH	120Vac, 60Hz (System)	Dalen Dai
	B	25deg. C, 75%RH	120Vac, 60Hz (Adapter)	Dalen Dai
APCM	A	25deg. C, 76%RH	120Vac, 60Hz (System)	Pirar Hsieh

### 3.3 Description of Support Units

The EUT has been tested as an independent unit together with other necessary accessories or support units. The following support units or accessories were used to form a representative test configuration during the tests.

ID	Product	Brand	Model No.	Serial No.	FCC ID	Remarks
A.	Notebook	Lenovo	80WG	YD01YRC9	N/A	Provided by Lab
B.	Adapter	Apple	A1385	N/A	N/A	Provided by Lab

Note: All power cords of the above support units are non-shielded (1.8m).

ID	Cable Descriptions	Qty.	Length (m)	Shielding (Yes/No)	Cores (Qty.)	Remarks
1.	Type-C cable	1	1.5	Y	0	Supplied by client

Note: The core(s) is(are) originally attached to the cable(s).

#### 3.3.1 Configuration of System under Test

Operating + Charging Mode (Powered from Notebook)

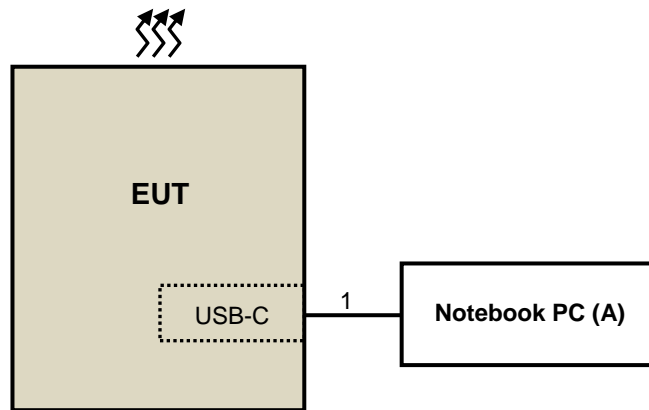

Operating + Charging Mode (Powered from Adapter)

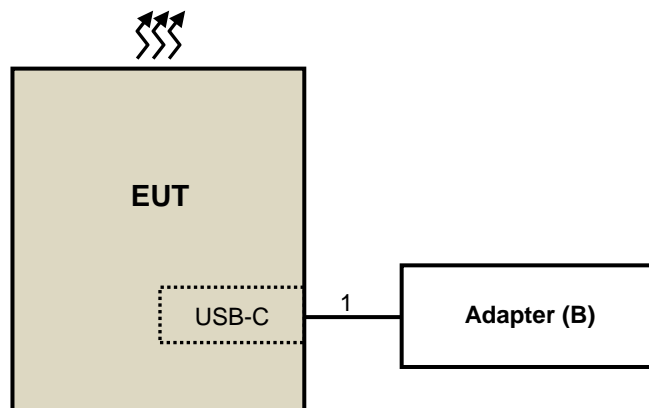

### 3.4 General Description of Applied Standards and References

The EUT is a RF Product. According to the specifications of the manufacturer, it must comply with the requirements of the following standards and references:

**Test standard:**

**FCC Part 15, Subpart C (15.247)**

ANSI C63.10-2013

All test items have been performed and recorded as per the above standards.

**References Test Guidance:**

**KDB 558074 D01 15.247 Meas Guidance v05r02**

All test items have been performed as a reference to the above KDB test guidance.

## 4 Test Types and Results

### 4.1 Radiated Emission and Bandedge Measurement

#### 4.1.1 Limits of Radiated Emission and Bandedge Measurement

Radiated emissions which fall in the restricted bands must comply with the radiated emission limits specified as below table. Other emissions shall be at least 20dB below the highest level of the desired power:

Frequencies (MHz)	Field Strength (microvolts/meter)	Measurement Distance (meters)
0.009 ~ 0.490	2400/F(kHz)	300
0.490 ~ 1.705	24000/F(kHz)	30
1.705 ~ 30.0	30	30
30 ~ 88	100	3
88 ~ 216	150	3
216 ~ 960	200	3
Above 960	500	3

**NOTE:**

1. The lower limit shall apply at the transition frequencies.
2. Emission level (dBuV/m) = 20 log Emission level (uV/m).
3. For frequencies above 1000MHz, the field strength limits are based on average detector, however, the peak field strength of any emission shall not exceed the maximum permitted average limits, specified above by more than 20dB under any condition of modulation.

#### 4.1.2 Test Instruments

DESCRIPTION & MANUFACTURER	MODEL NO.	SERIAL NO.	CALIBRATED DATE	CALIBRATED UNTIL
HP Preamplifier	8447D	2432A03504	Feb. 18, 2021	Feb. 17, 2022
HP Preamplifier	8449B	3008A01201	Feb. 19, 2021	Feb. 18, 2022
MITEQ Preamplifier	AMF-6F-260400-33-8P	892164	Feb. 18, 2021	Feb. 17, 2022
Agilent TEST RECEIVER	N9038A	MY51210129	Mar. 18, 2020	Mar. 17, 2021
Schwarzbeck Antenna	VULB 9168	139	Nov. 6, 2020	Nov. 5, 2021
Schwarzbeck Antenna	VHBA 9123	480	Jun. 3, 2019	Jun. 2, 2021
Schwarzbeck Horn Antenna	BBHA-9170	212	Nov. 22, 2020	Nov. 21, 2021
EMCO Horn Antenna	3115	00027024	Nov. 22, 2020	Nov.21, 2021
ADT. Turn Table	TT100	0306	NA	NA
ADT. Tower	AT100	0306	NA	NA
Software	Radiated_V7.6.15.9.5	NA	NA	NA
SUHNER RF cable With 4dB PAD	SF102	Cable-CH6-01	Jul. 9, 2020	Jul. 8, 2021
EMEC RF cable With 3/4dB PAD	EM102-KMKM	01	Aug. 21, 2020	Aug. 20, 2021
KEYSIGHT MIMO Powermeasurement Test set	U2021XA	U2021XA-001	Jun. 16, 2020	Jun. 15, 2021
KEYSIGHT Spectrum Analyzer	N9030A	MY54490260	Jul. 22, 2020	Jul. 21, 2021
Loop Antenna EMCI	LPA600	270	Aug. 23, 2019	Aug. 22, 2021
EMCO Horn Antenna	3115	00028257	Nov. 22, 2020	Nov. 21, 2021
Highpass filter Wainwright Instruments	WHK 3.1/18G-10SS	SN 8	NA	NA
ROHDE & SCHWARZ Spectrum Analyzer	FSV40	101042	Sep. 8, 2020	Sep. 7, 2021
Anritsu Power Sensor	MA2411B	0738404	Apr. 13, 2020	Apr. 12, 2021
Anritsu Power Meter	ML2495A	0842014	Apr. 13, 2020	Apr. 12, 2021

- NOTE:**
1. The calibration interval of the above test instruments is 12/24 months. And the calibrations are traceable to NML/ROC and NIST/USA.
  2. The horn antenna and HP preamplifier (model: 8449B) are used only for the measurement of emission frequency above 1GHz if tested.
  3. The test was performed in Chamber No. 6.

#### 4.1.3 Test Procedures

##### **For Radiated emission below 30MHz**

- a. The EUT was placed on the top of a rotating table 0.8 meters above the ground at a 3 meter chamber room. The table was rotated 360 degrees to determine the position of the highest radiation.
- b. The EUT was set 3 meters away from the interference-receiving antenna, which was mounted on the top of a variable-height antenna tower.
- c. Parallel, perpendicular, and ground-parallel orientations of the antenna are set to make the measurement.
- d. For each suspected emission, the EUT was arranged to its worst case and the rotatable table was turned from 0 degrees to 360 degrees to find the maximum reading.
- e. The test-receiver system was set to Quasi-Peak Detect Function and Specified Bandwidth with Maximum Hold Mode.

**Note:** The resolution bandwidth and video bandwidth of test receiver/spectrum analyzer is 9kHz at frequency below 30MHz.

##### **For Radiated emission above 30MHz**

- a. The EUT was placed on the top of a rotating table 0.8 meters (for 30MHz ~ 1GHz) / 1.5 meters (for above 1GHz) above the ground at 3 meter chamber room for test. The table was rotated 360 degrees to determine the position of the highest radiation.
- b. The EUT was set 3 meters away from the interference-receiving antenna, which was mounted on the top of a variable-height antenna tower.
- c. The height of antenna is varied from one meter to four meters above the ground to determine the maximum value of the field strength. Both horizontal and vertical polarizations of the antenna are set to make the measurement.
- d. For each suspected emission, the EUT was arranged to its worst case and then the antenna was tuned to heights from 1 meter to 4 meters and the rotatable table was turned from 0 degrees to 360 degrees to find the maximum reading.
- e. The test-receiver system was set to quasi-peak detect function and specified bandwidth with maximum hold mode when the test frequency is below 1 GHz.
- f. The test-receiver system was set to peak and average detect function and specified bandwidth with maximum hold mode when the test frequency is above 1 GHz. If the peak reading value also meets average limit, measurement with the average detector is unnecessary.

**Note:**

1. The resolution bandwidth and video bandwidth of test receiver/spectrum analyzer is 120kHz for Quasi-peak detection (QP) at frequency below 1GHz.
2. The resolution bandwidth of test receiver/spectrum analyzer is 1 MHz and the video bandwidth is 3 MHz for Peak detection (PK) at frequency above 1GHz.
3. The resolution bandwidth of test receiver/spectrum analyzer is 1MHz and the video bandwidth is  $\geq 1/T$  (Duty cycle  $< 98\%$ ) or 10Hz (Duty cycle  $\geq 98\%$ ) for Average detection (AV) at frequency above 1GHz. ((PK) RB=1MHz, VB=3 MHz; (AV) 1M/3M detector RMS trace AV)
4. All modes of operation were investigated and the worst-case emissions are reported.

#### 4.1.4 Deviation from Test Standard

No deviation.

#### 4.1.5 Test Setup

##### For Radiated emission below 30MHz

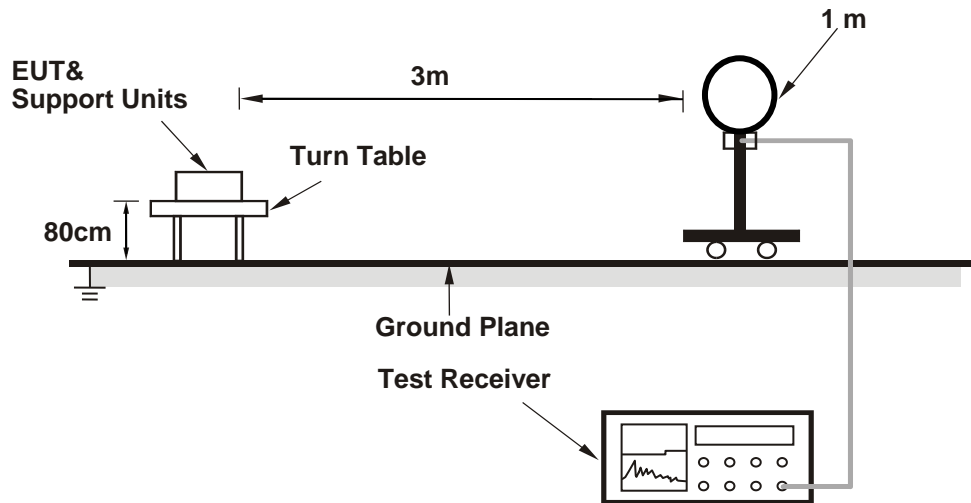

##### For Radiated emission 30MHz to 1GHz

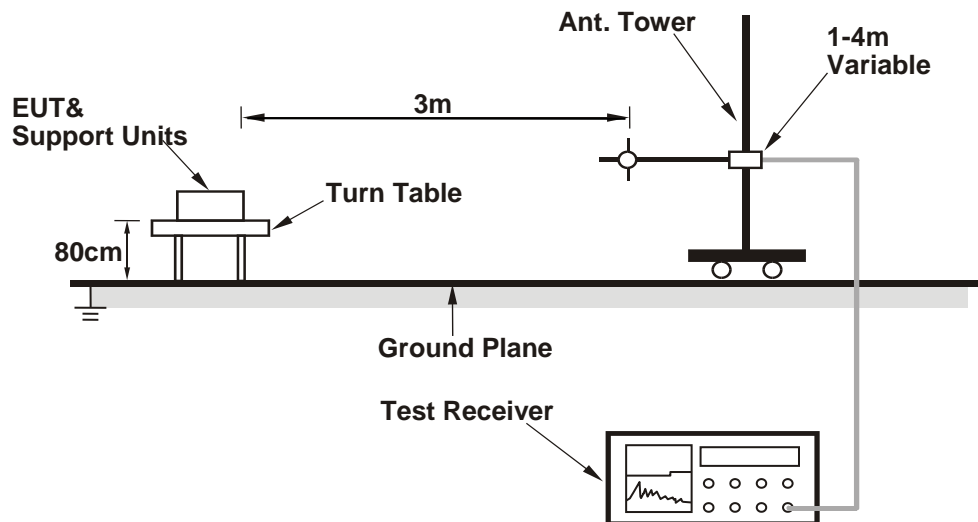



**For Radiated emission above 1GHz**

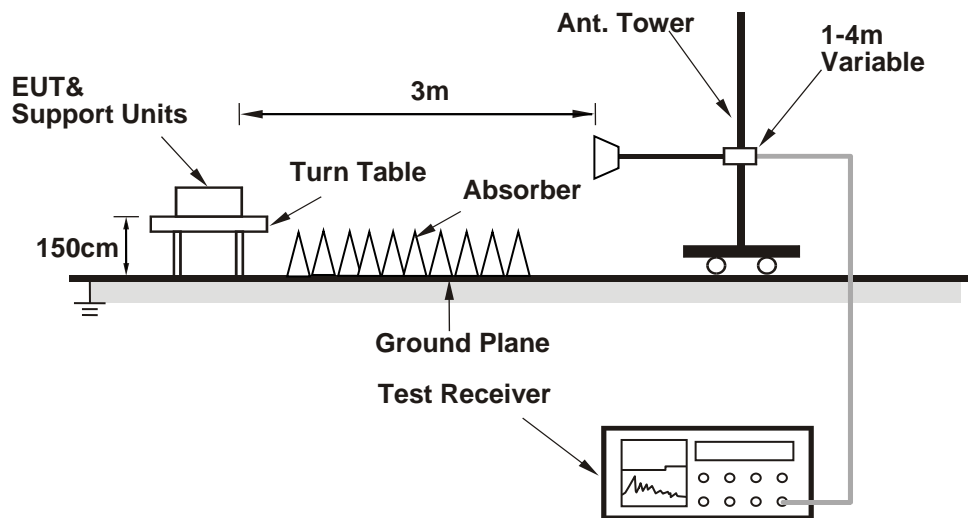

For the actual test configuration, please refer to the attached file (Test Setup Photo).

**4.1.6 EUT Operating Conditions**

- a. Connected EUT with Notebook via USB cable and set the EUT under charging condition.
- b. Set the EUT under transmission condition continuously at specific channel frequency continuously.

4.1.7 Test Results

Mode A

ABOVE 1GHz DATA

RF Mode	TX BT_GFSK	Channel	CH 0 : 2402 MHz
Frequency Range	1GHz ~ 25GHz	Detector Function	Peak (PK) Average (AV)

**Antenna Polarity & Test Distance : Horizontal at 3 m**

No	Frequency (MHz)	Emission Level (dBuV/m)	Limit (dBuV/m)	Margin (dB)	Antenna Height (m)	Table Angle (Degree)	Raw Value (dBuV)	Correction Factor (dB/m)
1	2390.00	46.37 PK	74.00	-27.63	1.45 H	302	45.02	1.35
2	2390.00	35.03 AV	54.00	-18.97	1.45 H	302	33.68	1.35
3	*2402.00	97.27 PK			1.45 H	302	95.86	1.41
4	*2402.00	66.57 AV			1.45 H	302	65.16	1.41
5	4804.00	50.92 PK	74.00	-23.08	3.45 H	99	41.54	9.38
6	4804.00	20.22 AV	54.00	-33.78	3.45 H	99	10.84	9.38

**Antenna Polarity & Test Distance : Vertical at 3 m**

No	Frequency (MHz)	Emission Level (dBuV/m)	Limit (dBuV/m)	Margin (dB)	Antenna Height (m)	Table Angle (Degree)	Raw Value (dBuV)	Correction Factor (dB/m)
1	2390.00	46.21 PK	74.00	-27.79	1.51 V	32	44.86	1.35
2	2390.00	34.94 AV	54.00	-19.06	1.51 V	32	33.59	1.35
3	*2402.00	96.52 PK			1.51 V	32	95.11	1.41
4	*2402.00	65.82 AV			1.51 V	32	64.41	1.41
5	4804.00	50.39 PK	74.00	-23.61	3.54 V	245	41.01	9.38
6	4804.00	19.69 AV	54.00	-34.31	3.54 V	245	10.31	9.38

**Remarks:**

- Emission Level(dBuV/m) = Raw Value(dBuV) + Correction Factor(dB/m)
- Correction Factor(dB/m) = Antenna Factor(dB/m) + Cable Factor(dB) – Pre-Amplifier Factor(dB)
- Margin value = Emission Level – Limit value
- The other emission levels were very low against the limit.
- " \* ": Fundamental frequency.
- The average value of fundamental and harmonic frequency is: Average = Peak value + 20 log(Duty cycle) Where the duty cycle correction factor is calculated from following formula:  
 $20 \log(\text{Duty cycle}) = 20 \log(2.933 \text{ ms} / 100 \text{ ms}) = -30.7 \text{ dB}$   
 Please see page 24 for plotted duty.

<b>RF Mode</b>	TX BT_GFSK	<b>Channel</b>	CH 39 : 2441 MHz
<b>Frequency Range</b>	1GHz ~ 25GHz	<b>Detector Function</b>	Peak (PK) Average (AV)

**Antenna Polarity & Test Distance : Horizontal at 3 m**

No	Frequency (MHz)	Emission Level (dBuV/m)	Limit (dBuV/m)	Margin (dB)	Antenna Height (m)	Table Angle (Degree)	Raw Value (dBuV)	Correction Factor (dB/m)
1	*2441.00	96.69 PK			1.90 H	298	95.14	1.55
2	*2441.00	65.99 AV			1.90 H	298	64.44	1.55
3	4882.00	51.21 PK	74.00	-22.79	3.51 H	102	41.69	9.52
4	4882.00	20.51 AV	54.00	-33.49	3.51 H	102	10.99	9.52

**Antenna Polarity & Test Distance : Vertical at 3 m**

No	Frequency (MHz)	Emission Level (dBuV/m)	Limit (dBuV/m)	Margin (dB)	Antenna Height (m)	Table Angle (Degree)	Raw Value (dBuV)	Correction Factor (dB/m)
1	*2441.00	96.16 PK			1.06 V	324	94.61	1.55
2	*2441.00	65.46 AV			1.06 V	324	63.91	1.55
3	4882.00	50.40 PK	74.00	-23.60	2.61 V	255	40.88	9.52
4	4882.00	19.70 AV	54.00	-34.30	2.61 V	255	10.18	9.52

**Remarks:**

- Emission Level(dBuV/m) = Raw Value(dBuV) + Correction Factor(dB/m)
- Correction Factor(dB/m) = Antenna Factor(dB/m) + Cable Factor(dB) – Pre-Amplifier Factor(dB)
- Margin value = Emission Level – Limit value
- The other emission levels were very low against the limit.
- " \* ": Fundamental frequency.
- The average value of fundamental and harmonic frequency is: Average = Peak value + 20 log(Duty cycle) Where the duty cycle correction factor is calculated from following formula:  
 $20 \log(\text{Duty cycle}) = 20 \log(2.933 \text{ ms} / 100 \text{ ms}) = -30.7 \text{ dB}$   
Please see page 24 for plotted duty.

<b>RF Mode</b>	TX BT_GFSK	<b>Channel</b>	CH 78 : 2480 MHz
<b>Frequency Range</b>	1GHz ~ 25GHz	<b>Detector Function</b>	Peak (PK) Average (AV)

Antenna Polarity & Test Distance : Horizontal at 3 m								
No	Frequency (MHz)	Emission Level (dBuV/m)	Limit (dBuV/m)	Margin (dB)	Antenna Height (m)	Table Angle (Degree)	Raw Value (dBuV)	Correction Factor (dB/m)
1	*2480.00	95.13 PK			2.26 H	298	93.33	1.80
2	*2480.00	64.43 AV			2.26 H	298	62.63	1.80
3	2483.50	46.06 PK	74.00	-27.94	2.26 H	298	44.23	1.83
4	2483.50	35.27 AV	54.00	-18.73	2.26 H	298	33.44	1.83
5	4960.00	50.92 PK	74.00	-23.08	3.41 H	94	41.36	9.56
6	4960.00	20.22 AV	54.00	-33.78	3.41 H	94	10.66	9.56

Antenna Polarity & Test Distance : Vertical at 3 m								
No	Frequency (MHz)	Emission Level (dBuV/m)	Limit (dBuV/m)	Margin (dB)	Antenna Height (m)	Table Angle (Degree)	Raw Value (dBuV)	Correction Factor (dB/m)
1	*2480.00	93.96 PK			1.18 V	339	92.16	1.80
2	*2480.00	63.26 AV			1.18 V	339	61.46	1.80
3	2483.50	45.67 PK	74.00	-28.33	1.18 V	339	43.84	1.83
4	2483.50	34.79 AV	54.00	-19.21	1.18 V	339	32.96	1.83
5	4960.00	50.30 PK	74.00	-23.70	3.59 V	258	40.74	9.56
6	4960.00	19.60 AV	54.00	-34.40	3.59 V	258	10.04	9.56

**Remarks:**

- Emission Level(dBuV/m) = Raw Value(dBuV) + Correction Factor(dB/m)
- Correction Factor(dB/m) = Antenna Factor(dB/m) + Cable Factor(dB) – Pre-Amplifier Factor(dB)
- Margin value = Emission Level – Limit value
- The other emission levels were very low against the limit.
- " \* ": Fundamental frequency.
- The average value of fundamental and harmonic frequency is: Average = Peak value + 20 log(Duty cycle) Where the duty cycle correction factor is calculated from following formula:  
 $20 \log(\text{Duty cycle}) = 20 \log(2.933 \text{ ms} / 100 \text{ ms}) = -30.7 \text{ dB}$   
Please see page 24 for plotted duty.

<b>RF Mode</b>	TX BT_8DPSK	<b>Channel</b>	CH 0 : 2402 MHz
<b>Frequency Range</b>	1GHz ~ 25GHz	<b>Detector Function</b>	Peak (PK) Average (AV)

Antenna Polarity & Test Distance : Horizontal at 3 m								
No	Frequency (MHz)	Emission Level (dBuV/m)	Limit (dBuV/m)	Margin (dB)	Antenna Height (m)	Table Angle (Degree)	Raw Value (dBuV)	Correction Factor (dB/m)
1	2390.00	45.98 PK	74.00	-28.02	1.92 H	298	44.63	1.35
2	2390.00	34.82 AV	54.00	-19.18	1.92 H	298	33.47	1.35
3	*2402.00	99.01 PK			1.92 H	298	97.60	1.41
4	*2402.00	68.31 AV			1.92 H	298	66.90	1.41
5	4804.00	50.66 PK	74.00	-23.34	3.56 H	85	41.28	9.38
6	4804.00	19.96 AV	54.00	-34.04	3.56 H	85	10.58	9.38

Antenna Polarity & Test Distance : Vertical at 3 m								
No	Frequency (MHz)	Emission Level (dBuV/m)	Limit (dBuV/m)	Margin (dB)	Antenna Height (m)	Table Angle (Degree)	Raw Value (dBuV)	Correction Factor (dB/m)
1	2390.00	45.40 PK	74.00	-28.60	1.16 V	314	44.05	1.35
2	2390.00	34.18 AV	54.00	-19.82	1.16 V	314	32.83	1.35
3	*2402.00	97.70 PK			1.16 V	314	96.29	1.41
4	*2402.00	67.00 AV			1.16 V	314	65.59	1.41
5	4804.00	50.00 PK	74.00	-24.00	2.64 V	188	40.62	9.38
6	4804.00	19.30 AV	54.00	-34.70	2.64 V	188	9.92	9.38

**Remarks:**

1. Emission Level(dBuV/m) = Raw Value(dBuV) + Correction Factor(dB/m)
2. Correction Factor(dB/m) = Antenna Factor(dB/m) + Cable Factor(dB) – Pre-Amplifier Factor(dB)
3. Margin value = Emission Level – Limit value
4. The other emission levels were very low against the limit.
5. " \* ": Fundamental frequency.
6. The average value of fundamental and harmonic frequency is: Average = Peak value + 20 log(Duty cycle) Where the duty cycle correction factor is calculated from following formula:  
 $20 \log(\text{Duty cycle}) = 20 \log(2.933 \text{ ms} / 100 \text{ ms}) = -30.7 \text{ dB}$   
 Please see page 24 for plotted duty.

<b>RF Mode</b>	TX BT_8DPSK	<b>Channel</b>	CH 39 : 2441 MHz
<b>Frequency Range</b>	1GHz ~ 25GHz	<b>Detector Function</b>	Peak (PK) Average (AV)

**Antenna Polarity & Test Distance : Horizontal at 3 m**

No	Frequency (MHz)	Emission Level (dBuV/m)	Limit (dBuV/m)	Margin (dB)	Antenna Height (m)	Table Angle (Degree)	Raw Value (dBuV)	Correction Factor (dB/m)
1	*2441.00	97.81 PK			2.10 H	294	96.26	1.55
2	*2441.00	67.11 AV			2.10 H	294	65.56	1.55
3	4882.00	50.86 PK	74.00	-23.14	3.32 H	261	41.34	9.52
4	4882.00	20.16 AV	54.00	-33.84	3.32 H	261	10.64	9.52

**Antenna Polarity & Test Distance : Vertical at 3 m**

No	Frequency (MHz)	Emission Level (dBuV/m)	Limit (dBuV/m)	Margin (dB)	Antenna Height (m)	Table Angle (Degree)	Raw Value (dBuV)	Correction Factor (dB/m)
1	*2441.00	96.83 PK			1.10 V	341	95.28	1.55
2	*2441.00	66.13 AV			1.10 V	341	64.58	1.55
3	4882.00	50.10 PK	74.00	-23.90	1.82 V	116	40.58	9.52
4	4882.00	19.40 AV	54.00	-34.60	1.82 V	116	9.88	9.52

**Remarks:**

- Emission Level(dBuV/m) = Raw Value(dBuV) + Correction Factor(dB/m)
- Correction Factor(dB/m) = Antenna Factor(dB/m) + Cable Factor(dB) – Pre-Amplifier Factor(dB)
- Margin value = Emission Level – Limit value
- The other emission levels were very low against the limit.
- " \* ": Fundamental frequency.
- The average value of fundamental and harmonic frequency is: Average = Peak value + 20 log(Duty cycle) Where the duty cycle correction factor is calculated from following formula:  
 $20 \log(\text{Duty cycle}) = 20 \log(2.933 \text{ ms} / 100 \text{ ms}) = -30.7 \text{ dB}$   
Please see page 24 for plotted duty.

<b>RF Mode</b>	TX BT_8DPSK	<b>Channel</b>	CH 78 : 2480 MHz
<b>Frequency Range</b>	1GHz ~ 25GHz	<b>Detector Function</b>	Peak (PK) Average (AV)

Antenna Polarity & Test Distance : Horizontal at 3 m								
No	Frequency (MHz)	Emission Level (dBuV/m)	Limit (dBuV/m)	Margin (dB)	Antenna Height (m)	Table Angle (Degree)	Raw Value (dBuV)	Correction Factor (dB/m)
1	*2480.00	96.41 PK			2.25 H	297	94.61	1.80
2	*2480.00	65.71 AV			2.25 H	297	63.91	1.80
3	2483.50	46.05 PK	74.00	-27.95	2.25 H	297	44.22	1.83
4	2483.50	35.02 AV	54.00	-18.98	2.25 H	297	33.19	1.83
5	4960.00	51.27 PK	74.00	-22.73	2.39 H	332	41.71	9.56
6	4960.00	20.57 AV	54.00	-33.43	2.39 H	332	11.01	9.56

Antenna Polarity & Test Distance : Vertical at 3 m								
No	Frequency (MHz)	Emission Level (dBuV/m)	Limit (dBuV/m)	Margin (dB)	Antenna Height (m)	Table Angle (Degree)	Raw Value (dBuV)	Correction Factor (dB/m)
1	*2480.00	95.39 PK			1.16 V	328	93.59	1.80
2	*2480.00	64.69 AV			1.16 V	328	62.89	1.80
3	2483.50	45.67 PK	74.00	-28.33	1.16 V	328	43.84	1.83
4	2483.50	34.71 AV	54.00	-19.29	1.16 V	328	32.88	1.83
5	4960.00	50.24 PK	74.00	-23.76	2.50 V	183	40.68	9.56
6	4960.00	19.54 AV	54.00	-34.46	2.50 V	183	9.98	9.56

**Remarks:**

- Emission Level(dBuV/m) = Raw Value(dBuV) + Correction Factor(dB/m)
- Correction Factor(dB/m) = Antenna Factor(dB/m) + Cable Factor(dB) – Pre-Amplifier Factor(dB)
- Margin value = Emission Level – Limit value
- The other emission levels were very low against the limit.
- " \* ": Fundamental frequency.
- The average value of fundamental and harmonic frequency is: Average = Peak value + 20 log(Duty cycle) Where the duty cycle correction factor is calculated from following formula:  
 $20 \log(\text{Duty cycle}) = 20 \log(2.933 \text{ ms} / 100 \text{ ms}) = -30.7 \text{ dB}$   
Please see page 24 for plotted duty.

## Duty Cycle

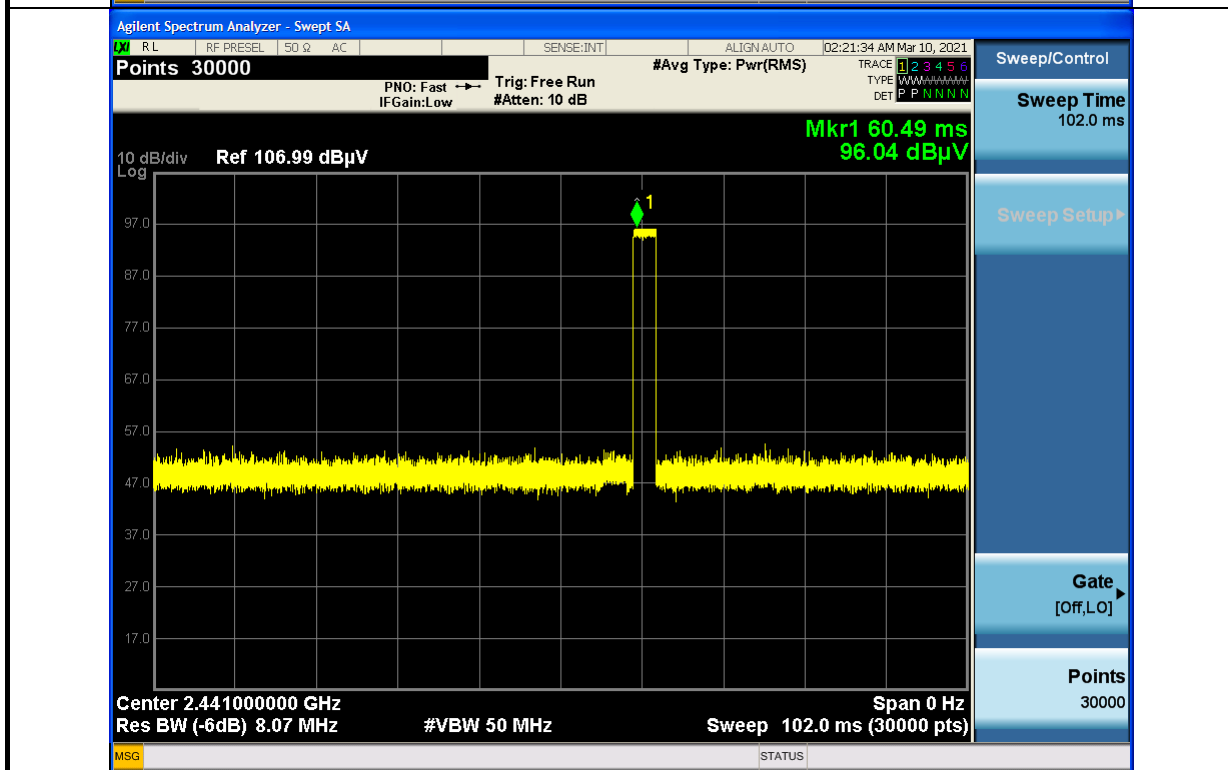
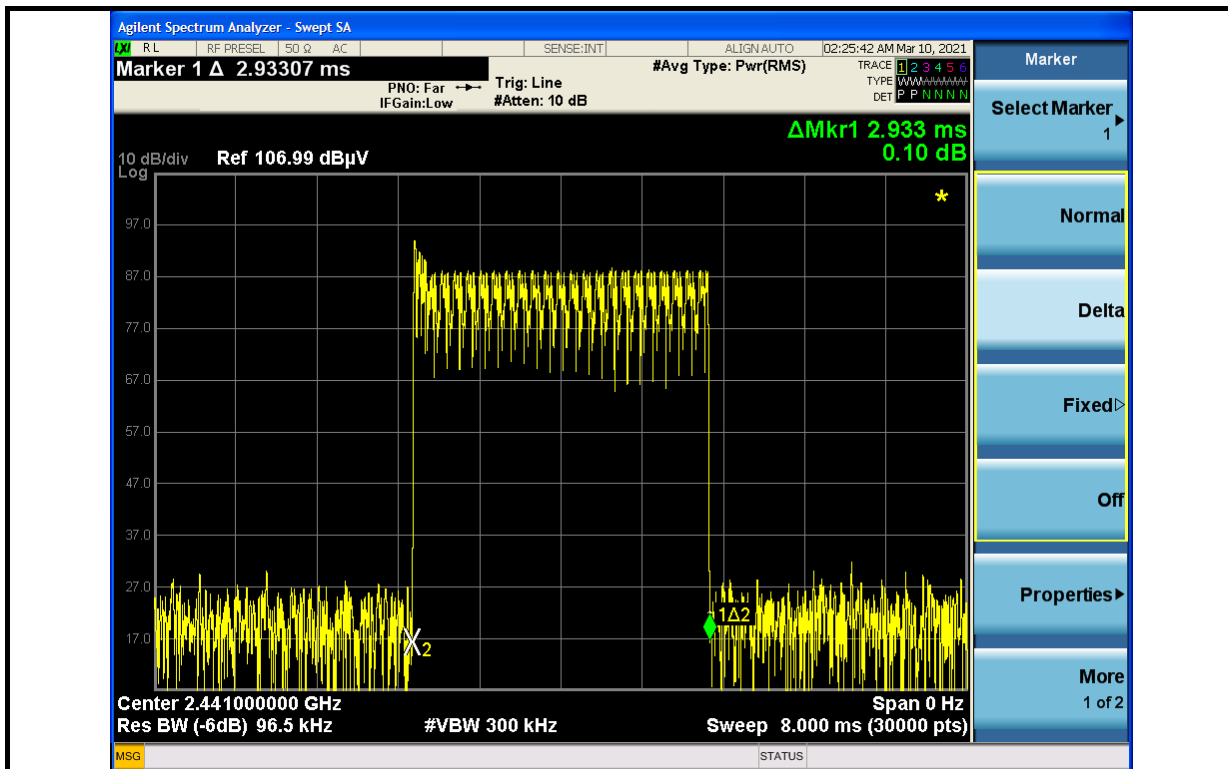

$$\text{Duty cycle} = (2.933 \times 1) / 100 \text{ms} = 0.02933,$$

$$\text{Duty cycle correction factor (dB)} = 20 * \log(0.02933) = -30.7$$



**BELOW 1GHz WORST-CASE DATA**

<b>RF Mode</b>	TX BT_GFSK	<b>Channel</b>	CH 0 : 2402 MHz
<b>Frequency Range</b>	9kHz ~ 1GHz	<b>Detector Function</b>	Quasi-Peak (QP)

Antenna Polarity & Test Distance : Horizontal at 3 m								
No	Frequency (MHz)	Emission Level (dBuV/m)	Limit (dBuV/m)	Margin (dB)	Antenna Height (m)	Table Angle (Degree)	Raw Value (dBuV)	Correction Factor (dB/m)
1	42.61	21.26 QP	40.00	-18.74	1.01 H	175	28.60	-7.34
2	161.92	19.82 QP	43.50	-23.68	1.16 H	195	26.09	-6.27
3	387.93	23.30 QP	46.00	-22.70	2.14 H	292	25.57	-2.27
4	600.36	30.76 QP	46.00	-15.24	1.63 H	242	28.40	2.36
5	630.43	28.80 QP	46.00	-17.20	2.39 H	317	25.59	3.21
6	755.56	29.79 QP	46.00	-16.21	2.63 H	339	24.48	5.31

**Remarks:**

1. Emission Level(dBuV/m) = Raw Value(dBuV) + Correction Factor(dB/m)
2. Correction Factor(dB/m) = Antenna Factor(dB/m) + Cable Factor(dB) – Pre-Amplifier Factor(dB)
3. Margin value = Emission Level – Limit value
4. The other emission levels were very low against the limit of frequency range 30MHz~1000MHz.
5. The emission levels were very low against the limit of frequency range 9kHz~30MHz: the amplitude of spurious emissions attenuated more than 20 dB below the permissible value to be report.

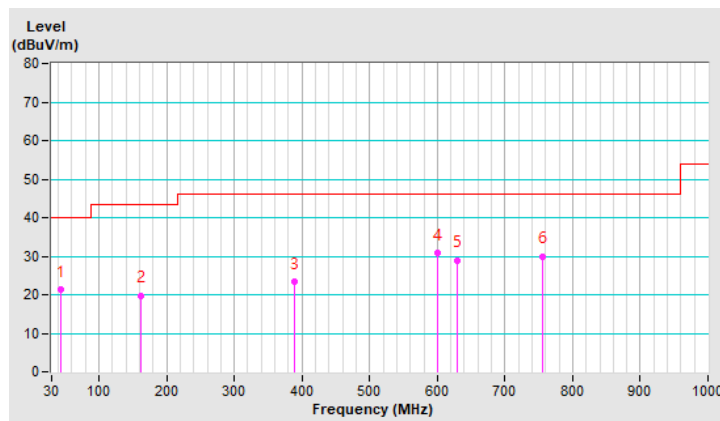

<b>RF Mode</b>	TX BT_GFSK	<b>Channel</b>	CH 0 : 2402 MHz
<b>Frequency Range</b>	9kHz ~ 1GHz	<b>Detector Function</b>	Quasi-Peak (QP)

Antenna Polarity & Test Distance : Vertical at 3 m								
No	Frequency (MHz)	Emission Level (dBuV/m)	Limit (dBuV/m)	Margin (dB)	Antenna Height (m)	Table Angle (Degree)	Raw Value (dBuV)	Correction Factor (dB/m)
1	41.64	22.68 QP	40.00	-17.32	2.19 V	141	30.11	-7.43
2	162.89	20.11 QP	43.50	-23.39	2.42 V	163	26.45	-6.34
3	367.56	23.99 QP	46.00	-22.01	2.67 V	190	26.74	-2.75
4	600.36	31.46 QP	46.00	-14.54	3.02 V	223	29.10	2.36
5	762.35	32.65 QP	46.00	-13.35	3.36 V	256	27.21	5.44
<b>6</b>	<b>879.72</b>	<b>34.00 QP</b>	<b>46.00</b>	<b>-12.00</b>	<b>3.71 V</b>	<b>293</b>	<b>27.10</b>	<b>6.90</b>

**Remarks:**

1. Emission Level(dBuV/m) = Raw Value(dBuV) + Correction Factor(dB/m)
2. Correction Factor(dB/m) = Antenna Factor(dB/m) + Cable Factor(dB) – Pre-Amplifier Factor(dB)
3. Margin value = Emission Level – Limit value
4. The other emission levels were very low against the limit of frequency range 30MHz~1000MHz.
5. The emission levels were very low against the limit of frequency range 9kHz~30MHz: the amplitude of spurious emissions attenuated more than 20 dB below the permissible value to be report.

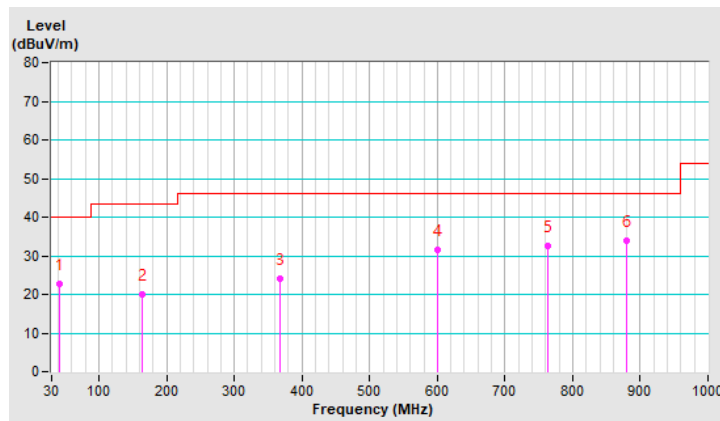

## 4.2 Conducted Emission Measurement

### 4.2.1 Limits of Conducted Emission Measurement

Frequency (MHz)	Conducted Limit (dBuV)	
	Quasi-peak	Average
0.15 - 0.5	66 - 56	56 - 46
0.50 - 5.0	56	46
5.0 - 30.0	60	50

Note: 1. The lower limit shall apply at the transition frequencies.

2. The limit decreases in line with the logarithm of the frequency in the range of 0.15 to 0.50MHz.

### 4.2.2 Test Instruments

Description & Manufacturer	Model No.	Serial No.	Cal. Date	Cal. Due
ROHDE & SCHWARZ TEST RECEIVER	ESCS30	100276	Apr. 16, 2020	Apr. 15, 2021
SCHWARZBECK Artificial Mains Network (for EUT)	NSLK 8128	8128-244	Nov. 19, 2020	Nov. 18, 2021
LISN With Adapter (for EUT)	AD10	C05Ada-001	Nov. 19, 2020	Nov. 18, 2021
R&S Artificial Mains Network (for peripheral)	ESH3-Z5	100220	Dec. 1, 2020	Nov. 30, 2021
Software	Cond_V7.3.7.4	NA	NA	NA
RF cable (JYEBAO) With 10dB PAD	5D-FB	Cable-C05.01	Jan. 29, 2021	Jan. 28, 2022
LYNICS Terminator (For R&S LISN)	0900510	E1-01-305	Feb. 17, 2021	Feb. 16, 2022

Note: 1. The calibration interval of the above test instruments is 12 months and the calibrations are traceable to NML/ROC and NIST/USA.

2. The test was performed in Shielded Room No. 5. (Conduction 5)

3. The VCCI Site Registration No. C-11093.

#### 4.2.3 Test Procedures

- a. The EUT was placed 0.4 meters from the conducting wall of the shielded room with EUT being connected to the power mains through a line impedance stabilization network (LISN). Other support units were connected to the power mains through another LISN. The two LISNs provide 50 ohm/ 50uH of coupling impedance for the measuring instrument.
- b. Both lines of the power mains connected to the EUT were checked for maximum conducted interference.
- c. The frequency range from 150kHz to 30MHz was searched. Emission levels under (Limit - 20dB) was not recorded.

**NOTE:** The resolution bandwidth and video bandwidth of test receiver is 9kHz for quasi-peak detection (QP) and average detection (AV) at frequency 0.15MHz-30MHz.

#### 4.2.4 Deviation From Test Standard

No deviation.

#### 4.2.5 Test Setup

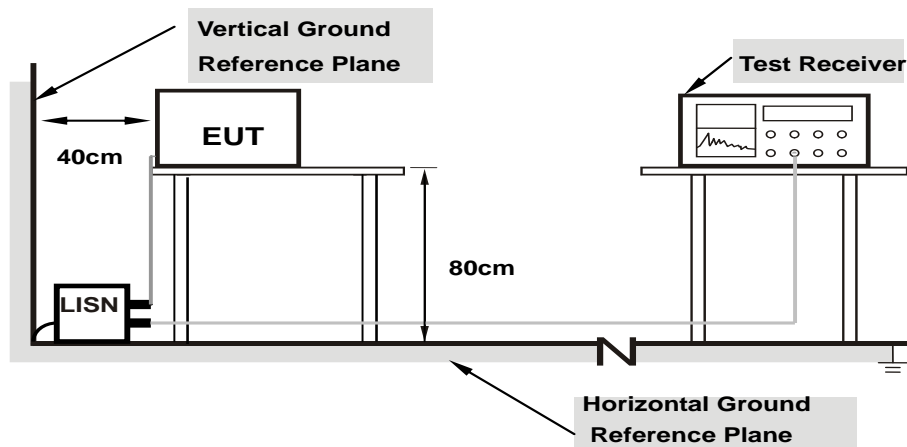

**Note: 1.Support units were connected to second LISN.**

For the actual test configuration, please refer to the attached file (Test Setup Photo).

#### 4.2.6 EUT Operating Condition

- a. Connected EUT with Notebook or Adapter via USB cable and set the EUT under charging condition.
- b. Set the EUT under transmission condition continuously at specific channel frequency continuously.

4.2.7 Test Results

Mode A

Frequency Range	150kHz ~ 30MHz	Detector Function	Quasi-Peak (QP) / Average (AV)
-----------------	----------------	-------------------	--------------------------------

Phase Of Power : Line (L)										
No	Frequency (MHz)	Correction Factor (dB)	Reading Value (dBuV)		Emission Level (dBuV)		Limit (dBuV)		Margin (dB)	
			Q.P.	AV.	Q.P.	AV.	Q.P.	AV.	Q.P.	AV.
1	0.15000	9.70	33.06	9.29	42.76	18.99	66.00	56.00	-23.24	-37.01
2	0.17344	9.70	38.03	19.85	47.73	29.55	64.79	54.79	-17.06	-25.24
3	0.45469	9.68	21.89	11.61	31.57	21.29	56.79	46.79	-25.22	-25.50
4	1.98828	9.72	19.45	13.61	29.17	23.33	56.00	46.00	-26.83	-22.67
5	4.83594	9.77	17.35	8.55	27.12	18.32	56.00	46.00	-28.88	-27.68
6	20.78906	9.99	18.31	12.85	28.30	22.84	60.00	50.00	-31.70	-27.16

Remarks:

1. Q.P. and AV. are abbreviations of quasi-peak and average individually.
2. The emission levels of other frequencies were very low against the limit.
3. Margin value = Emission level – Limit value
4. Correction factor = Insertion loss + Cable loss
5. Emission Level = Correction Factor + Reading Value

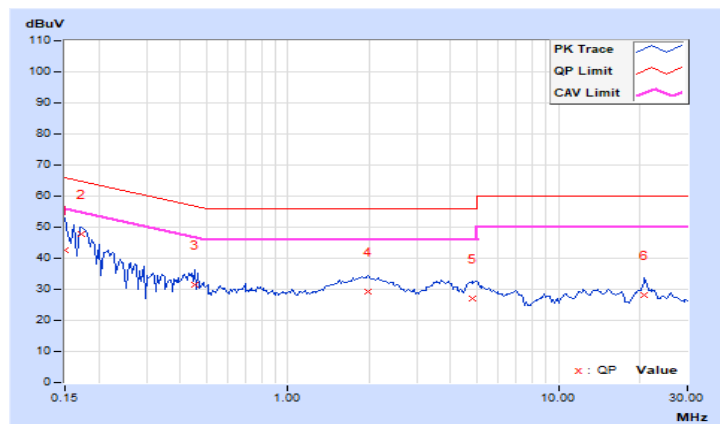

Frequency Range	150kHz ~ 30MHz	Detector Function	Quasi-Peak (QP) / Average (AV)
-----------------	----------------	-------------------	--------------------------------

Phase Of Power : Neutral (N)										
No	Frequency (MHz)	Correction Factor (dB)	Reading Value (dBuV)		Emission Level (dBuV)		Limit (dBuV)		Margin (dB)	
			Q.P.	AV.	Q.P.	AV.	Q.P.	AV.	Q.P.	AV.
1	0.15781	9.69	39.51	20.77	49.20	30.46	65.58	55.58	-16.38	-25.12
2	0.20078	9.68	32.03	16.29	41.71	25.97	63.58	53.58	-21.87	-27.61
3	0.47031	9.67	21.59	11.01	31.26	20.68	56.51	46.51	-25.25	-25.83
4	1.59766	9.72	18.91	13.17	28.63	22.89	56.00	46.00	-27.37	-23.11
5	4.72656	9.76	17.97	10.85	27.73	20.61	56.00	46.00	-28.27	-25.39
6	6.95313	9.80	16.05	10.03	25.85	19.83	60.00	50.00	-34.15	-30.17

**Remarks:**

1. Q.P. and AV. are abbreviations of quasi-peak and average individually.
2. The emission levels of other frequencies were very low against the limit.
3. Margin value = Emission level – Limit value
4. Correction factor = Insertion loss + Cable loss
5. Emission Level = Correction Factor + Reading Value

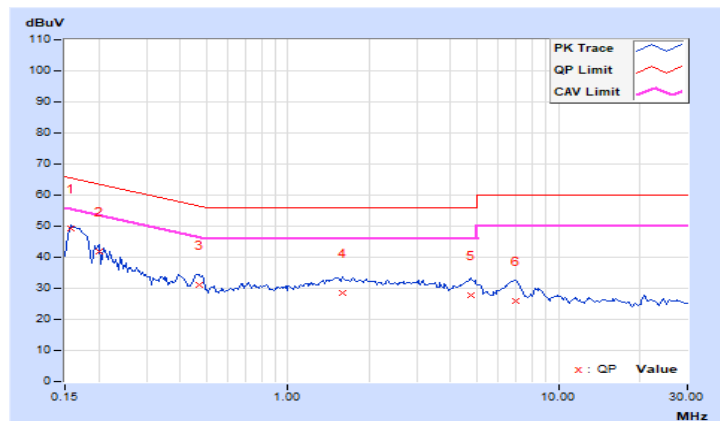

**Mode B**

Frequency Range	150kHz ~ 30MHz	Detector Function	Quasi-Peak (QP) / Average (AV)
-----------------	----------------	-------------------	--------------------------------

Phase Of Power : Line (L)										
No	Frequency (MHz)	Correction Factor (dB)	Reading Value (dBuV)		Emission Level (dBuV)		Limit (dBuV)		Margin (dB)	
			Q.P.	AV.	Q.P.	AV.	Q.P.	AV.	Q.P.	AV.
1	0.16562	9.70	25.95	8.75	35.65	18.45	65.18	55.18	-29.53	-36.73
2	0.24766	9.69	21.97	5.25	31.66	14.94	61.84	51.84	-30.18	-36.90
3	0.78672	9.70	20.93	12.37	30.63	22.07	56.00	46.00	-25.37	-23.93
4	3.01563	9.74	8.73	1.85	18.47	11.59	56.00	46.00	-37.53	-34.41
5	4.41016	9.77	11.31	5.01	21.08	14.78	56.00	46.00	-34.92	-31.22
6	9.20703	9.84	10.37	3.73	20.21	13.57	60.00	50.00	-39.79	-36.43

**Remarks:**

1. Q.P. and AV. are abbreviations of quasi-peak and average individually.
2. The emission levels of other frequencies were very low against the limit.
3. Margin value = Emission level – Limit value
4. Correction factor = Insertion loss + Cable loss
5. Emission Level = Correction Factor + Reading Value

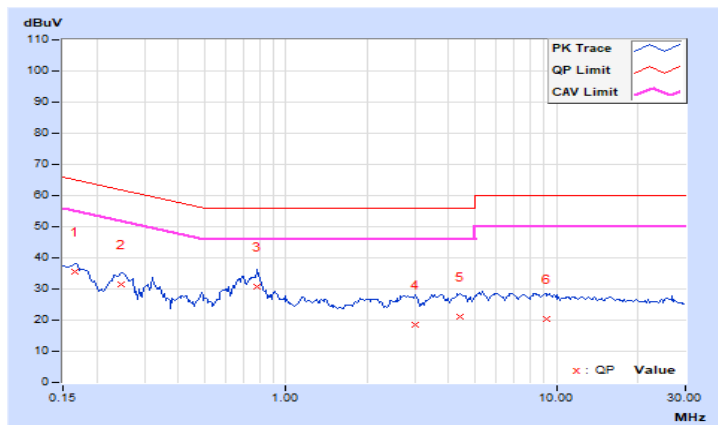

Frequency Range	150kHz ~ 30MHz	Detector Function	Quasi-Peak (QP) / Average (AV)
-----------------	----------------	-------------------	--------------------------------

Phase Of Power : Neutral (N)										
No	Frequency (MHz)	Correction Factor (dB)	Reading Value (dBuV)		Emission Level (dBuV)		Limit (dBuV)		Margin (dB)	
			Q.P.	AV.	Q.P.	AV.	Q.P.	AV.	Q.P.	AV.
1	0.16953	9.69	25.45	9.41	35.14	19.10	64.98	54.98	-29.84	-35.88
2	0.24375	9.68	21.75	7.27	31.43	16.95	61.97	51.97	-30.54	-35.02
3	0.75156	9.69	21.91	12.81	31.60	22.50	56.00	46.00	-24.40	-23.50
4	2.69141	9.73	10.71	4.85	20.44	14.58	56.00	46.00	-35.56	-31.42
5	4.31250	9.76	11.85	5.87	21.61	15.63	56.00	46.00	-34.39	-30.37
6	8.33984	9.82	9.73	2.71	19.55	12.53	60.00	50.00	-40.45	-37.47

**Remarks:**

1. Q.P. and AV. are abbreviations of quasi-peak and average individually.
2. The emission levels of other frequencies were very low against the limit.
3. Margin value = Emission level – Limit value
4. Correction factor = Insertion loss + Cable loss
5. Emission Level = Correction Factor + Reading Value

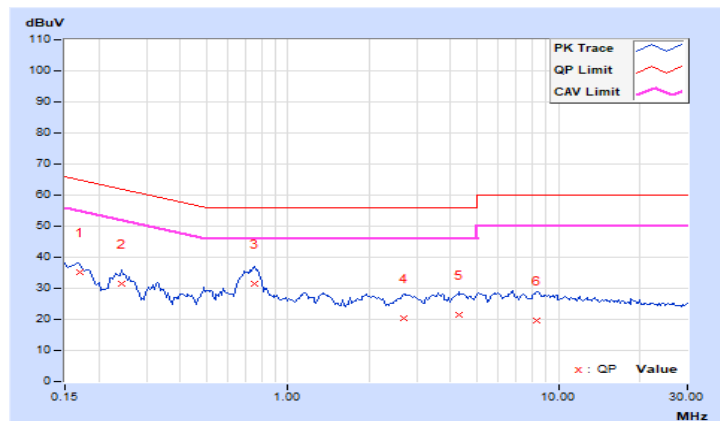



### 4.3 Number of Hopping Frequency Used

#### 4.3.1 Limits of Hopping Frequency Used Measurement

At least 15 channels frequencies, and should be equally spaced.

#### 4.3.2 Test Setup



#### 4.3.3 Test Instruments

Refer to section 4.1.2 to get information of above instrument.

#### 4.3.4 Test Procedure

- a. Check the calibration of the measuring instrument (SA) using either an internal calibrator or a known signal from an external generator.
- b. Turn on the EUT and connect its antenna terminal to measurement via a low loss cable. Then set it to any one measured frequency within its operating range and make sure the instrument is operated in its linear range.
- c. Set the SA on MaxHold Mode, and then keep the EUT in hopping mode. Record all the signals from each channel until each one has been recorded.
- d. Set the SA on View mode and then plot the result on SA screen.
- e. Repeat above procedures until all frequencies measured were complete.

#### 4.3.5 Deviation from Test Standard

No deviation.

### 4.3.6 Test Results

There are 79 hopping frequencies in the hopping mode. Please refer to next page for the test result. On the plots, it shows that the hopping frequencies are equally spaced.

#### Mode A

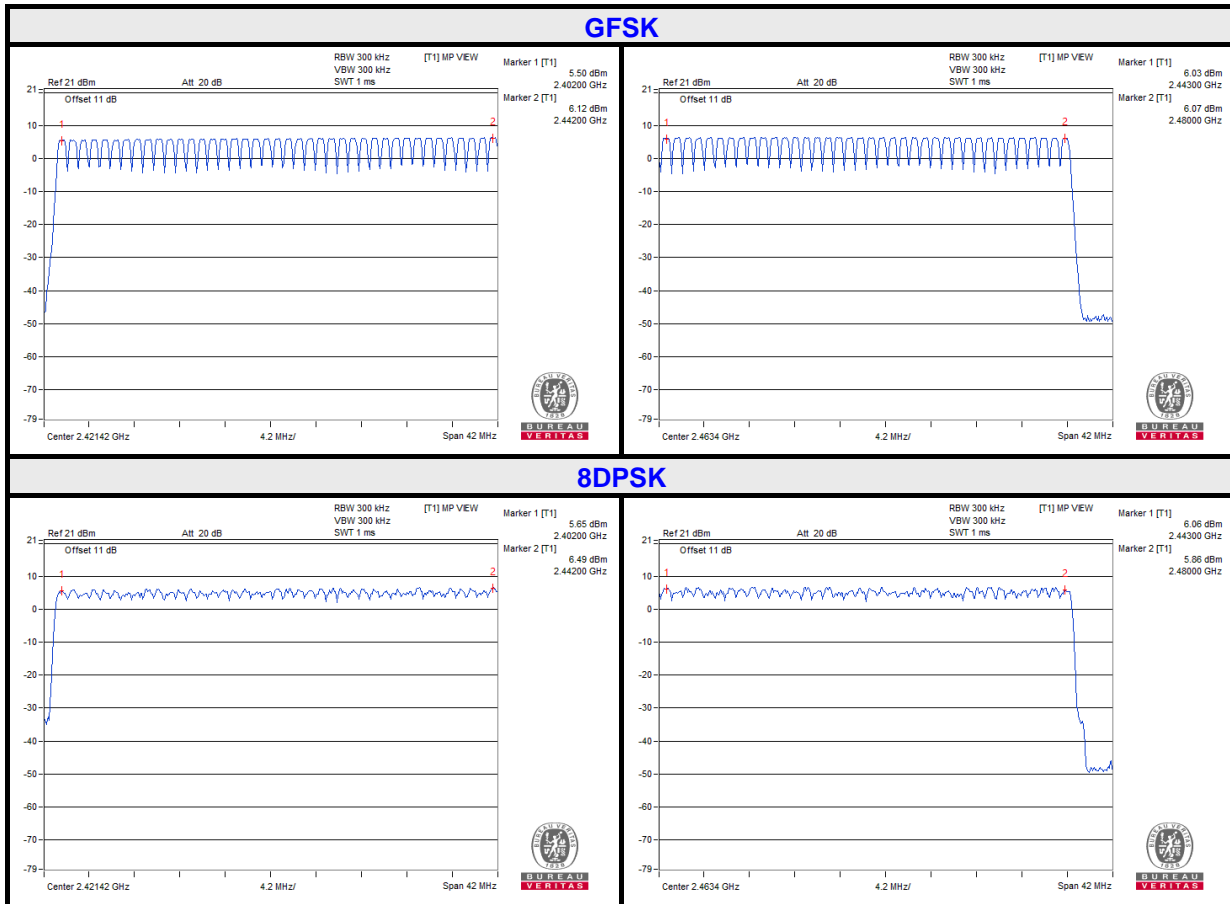

#### 4.4 Dwell Time on Each Channel

##### 4.4.1 Limits of Dwell Time on Each Channel Measurement

The average time of occupancy on any channel shall not be greater than 0.4 seconds within a period of 0.4 seconds multiplied by the number of hopping channels employed.

##### 4.4.2 Test Setup

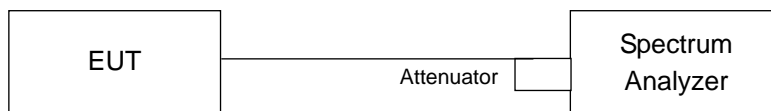

##### 4.4.3 Test Instruments

Refer to section 4.1.2 to get information of above instrument.

##### 4.4.4 Test Procedures

- a. Check the calibration of the measuring instrument (SA) using either an internal calibrator or a known signal from an external generator.
- b. Turn on the EUT and connect its antenna terminal to measurement via a low loss cable. Then set it to any one measured frequency within its operating range and make sure the instrument is operated in its linear range.
- c. Adjust the center frequency of SA on any frequency be measured and set SA to zero span mode. And then, set RBW and VBW of spectrum analyzer to proper value.
- d. Measure the time duration of one transmission on the measured frequency. And then plot the result with time difference of this time duration.
- e. Repeat above procedures until all different time-slot modes have been completed.

##### 4.4.5 Deviation from Test Standard

No deviation.

#### 4.4.6 Test Results

#### Mode A GFSK

Mode	Number of transmission in a 31.6 (79Hopping*0.4)	Length of transmission time (msec)	Result (msec)	Limit (msec)
DH1	50 (times / 5 sec) * 6.32 = 316 times	0.420	132.72	400
DH3	25 (times / 5 sec) * 6.32 = 158 times	1.700	268.60	400
DH5	17 (times / 5 sec) * 6.32 = 108 times	2.933	316.76	400

**NOTE:** Test plots of the transmitting time slot are shown as follows.

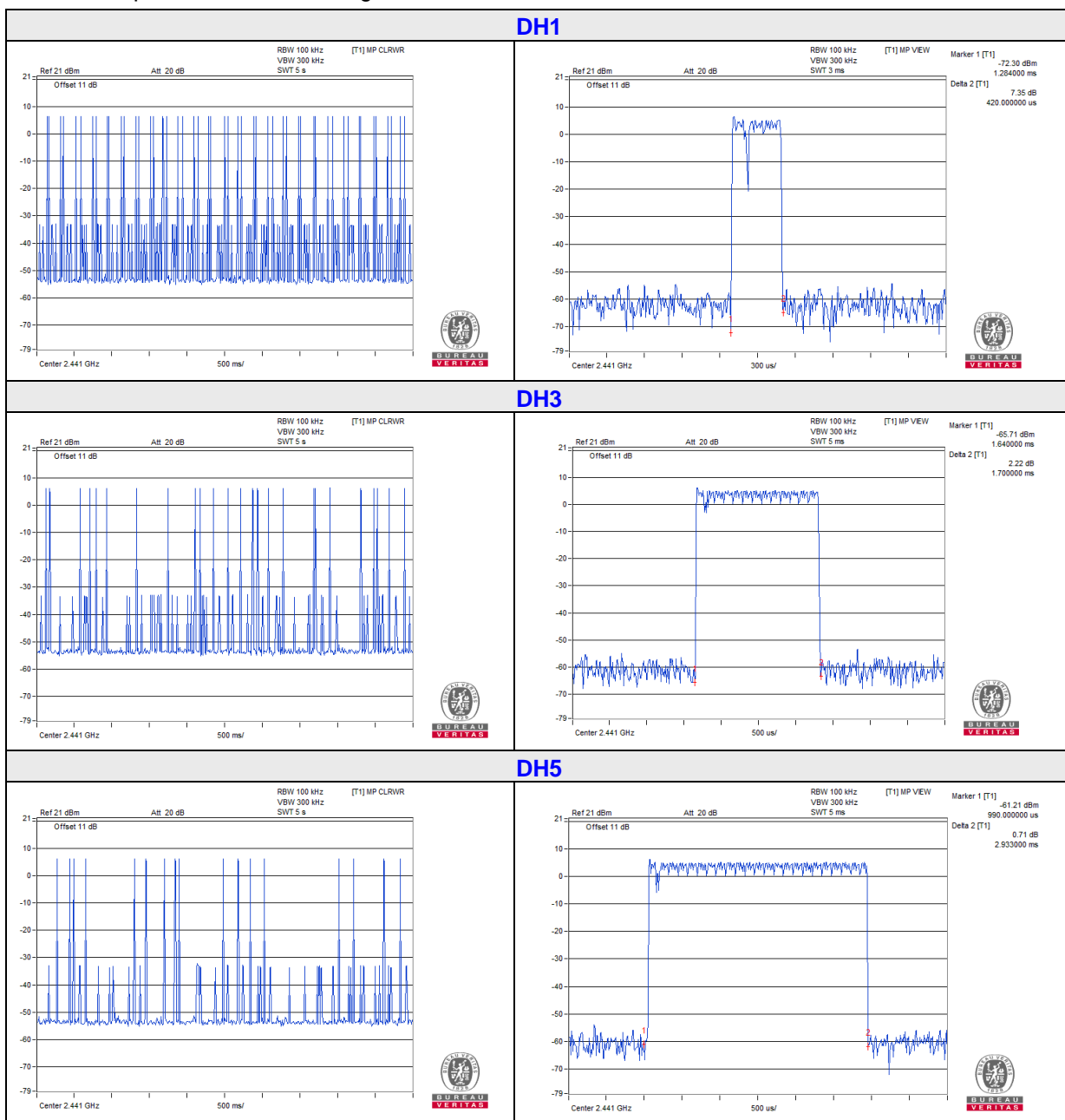

### 8DPSK

Mode	Number of transmission in a 31.6 (79Hopping*0.4)	Length of transmission time (msec)	Result (msec)	Limit (msec)
3DH1	50 (times / 5 sec) * 6.32 = 316 times	0.468	147.89	400
3DH3	25 (times / 5 sec) * 6.32 = 158 times	1.750	276.50	400
3DH5	17 (times / 5 sec) * 6.32 = 108 times	2.930	316.44	400

**NOTE:** Test plots of the transmitting time slot are shown as follows.



## 4.5 Channel Bandwidth

### 4.5.1 Limits of Channel Bandwidth Measurement

For frequency hopping system operating in the 2400-2483.5MHz, If the 20dB bandwidth of hopping channel is greater than 25kHz, two-thirds 20dB bandwidth of hopping channel shall be a minimum limit for the hopping channel separation.

### 4.5.2 Test Setup

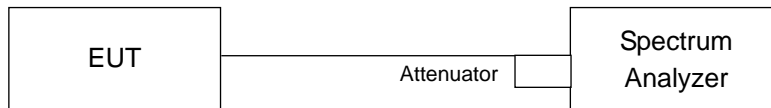

### 4.5.3 Test Instruments

Refer to section 4.1.2 to get information of above instrument.

### 4.5.4 Test Procedure

- Check the calibration of the measuring instrument using either an internal calibrator or a known signal from an external generator.
- Turn on the EUT and connect it to measurement instrument. Then set it to any one convenient frequency within its operating range. Set a reference level on the measuring instrument equal to the highest peak value.
- Measure the frequency difference of two frequencies that were attenuated 20dB from the reference level. Record the frequency difference as the emission bandwidth.
- Repeat above procedures until all frequencies measured were complete.

### 4.5.5 Deviation from Test Standard

No deviation.

### 4.5.6 EUT Operating Condition

The software provided by client enabled the EUT to transmit and receive data at lowest, middle and highest channel frequencies individually.

### 4.5.7 Test Results

#### Mode A

Channel	Frequency (MHz)	20dB Bandwidth (MHz)	
		GFSK	8DPSK
0	2402	0.95	1.30
39	2441	0.96	1.30
78	2480	0.96	1.30

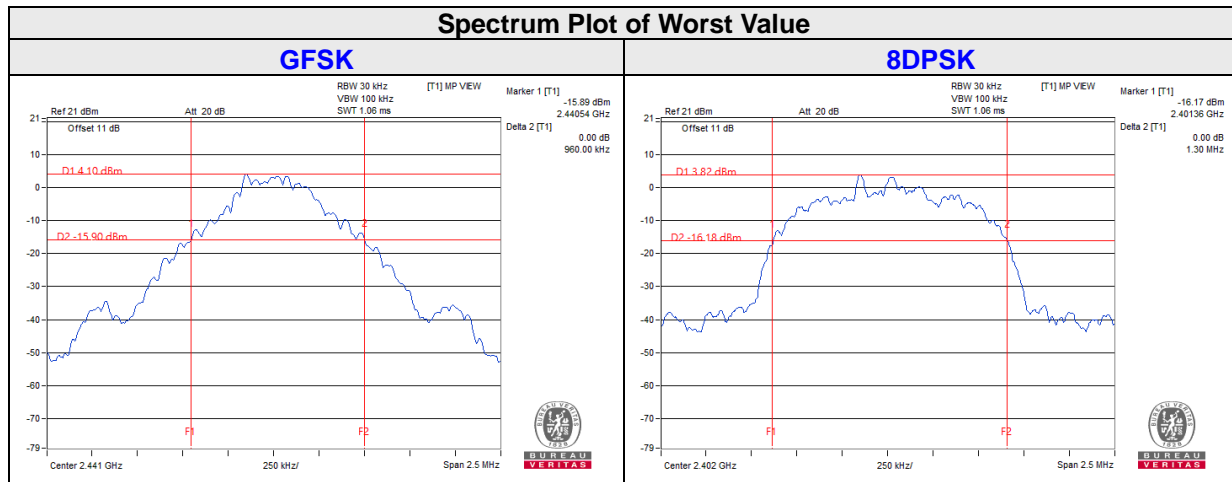

## 4.6 Hopping Channel Separation

### 4.6.1 Limits of Hopping Channel Separation Measurement

At least 25kHz or two-third of 20dB hopping channel bandwidth (whichever is greater).

### 4.6.2 Test Setup

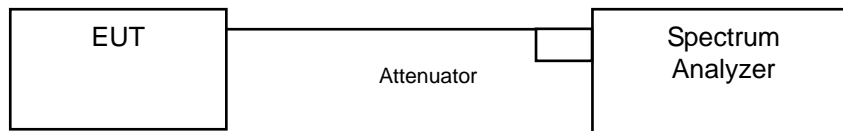

### 4.6.3 Test Instruments

Refer to section 4.1.2 to get information of above instrument.

### 4.6.4 Test Procedure

Measurement Procedure REF

- a. Check the calibration of the measuring instrument using either an internal calibrator or a known signal from an external generator.
- b. Turn on the EUT and connect it to measurement instrument. Then set it to any one convenient frequency within its operating range.
- c. By using the MaxHold function record the separation of two adjacent channels.
- d. Measure the frequency difference of these two adjacent channels by SA MARK function. And then plot the result on SA screen.
- e. Repeat above procedures until all frequencies measured were complete.

### 4.6.5 Deviation from Test Standard

No deviation.



#### 4.6.6 Test Results

##### Mode A

Channel	Frequency (MHz)	Adjacent Channel Separation (MHz)		20dB Bandwidth (MHz)		Minimum Limit (MHz)		Pass / Fail
		GFSK	8DPSK	GFSK	8DPSK	GFSK	8DPSK	
0	2402	1.00	1.00	0.95	1.30	0.64	0.87	Pass
39	2441	1.00	1.00	0.96	1.30	0.64	0.87	Pass
78	2480	1.00	1.00	0.96	1.30	0.64	0.87	Pass

**NOTE:** The minimum limit is two-third 20dB bandwidth.

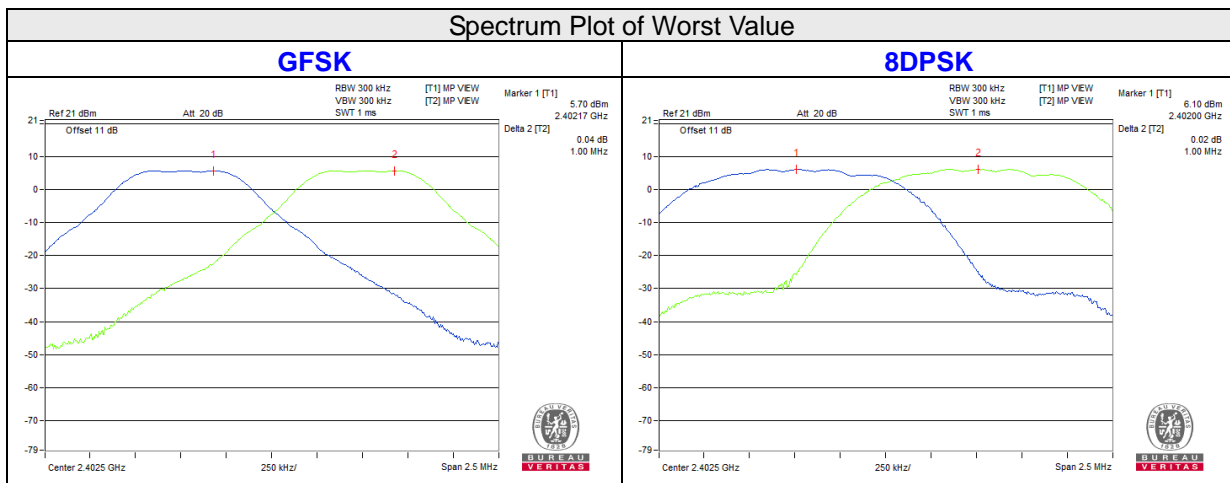

## 4.7 Maximum Output Power Measurement

### 4.7.1 Limits of Maximum Output Power Measurement

The Maximum Output Power Measurement is 125mW.

### 4.7.2 Test Setup

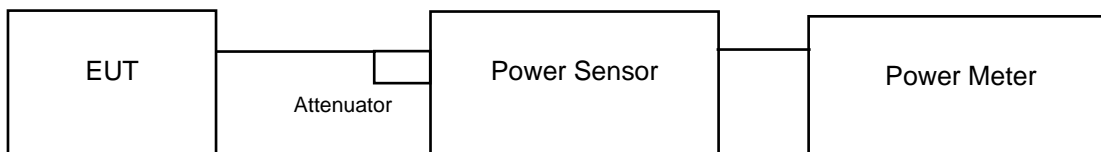

### 4.7.3 Test Instruments

Refer to section 4.1.2 to get information of above instrument.

### 4.7.4 Test Procedure

A peak power sensor was used on the output port of the EUT. A power meter was used to read the response of the peak power sensor. Record the power level.

Average power sensor was used to perform output power measurement, trigger and gating function of wide band power meter is enabled to measure max output power of TX on burst. Duty factor is not added to measured value.

### 4.7.5 Deviation from Test Standard

No deviation.

### 4.7.6 EUT Operating Condition

The software provided by client enabled the EUT to transmit and receive data at lowest, middle and highest channel frequencies individually.

#### 4.7.7 Test Results

##### Mode A

##### FOR PEAK POWER

Channel	Frequency (MHZ)	Output Power (mW)		Output Power (dBm)		Power Limit (mW)	Pass / Fail
		GFSK	8DPSK	GFSK	8DPSK		
0	2402	4.236	4.645	6.27	6.67	125	Pass
39	2441	5.236	5.598	7.19	7.48	125	Pass
78	2480	5.902	<b>6.368</b>	7.71	8.04	125	Pass

##### FOR AVERAGE POWER

Channel	Frequency (MHZ)	Output Power (mW)		Output Power (dBm)	
		GFSK	8DPSK	GFSK	8DPSK
0	2402	4.083	4.406	6.11	6.44
39	2441	5.070	5.508	7.05	7.41
78	2480	5.662	6.209	7.53	7.93

## 4.8 Conducted Out of Band Emission Measurement

### 4.8.1 Limits of Conducted Out of Band Emission Measurement

Below  $-20\text{dB}$  of the highest emission level of operating band (in 100kHz Resolution Bandwidth).

### 4.8.2 Test Instruments

Refer to section 4.1.2 to get information of above instrument.

### 4.8.3 Test Procedure

The transmitter output was connected to the spectrum analyzer via a low lose cable. Set both RBW and VBW of spectrum analyzer to 100 kHz and 300 kHz with suitable frequency span including 100 MHz bandwidth from band edge. The band edges was measured and recorded.

### 4.8.4 Deviation from Test Standard

No deviation.

### 4.8.5 EUT Operating Condition

The software provided by client enabled the EUT to transmit and receive data at lowest, middle and highest channel frequencies individually.

### 4.8.6 Test Results

The spectrum plots are attached on the following images. D1 line indicates the highest level, D2 line indicates the 20dB offset below D1. It shows compliance with the requirement.

Mode A  
GFSK

Hopping disabled\_Low Channel

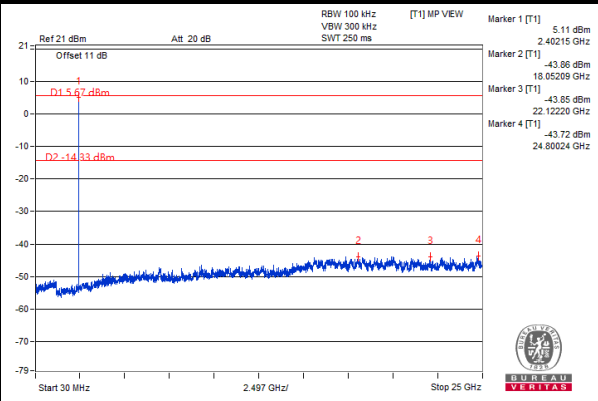
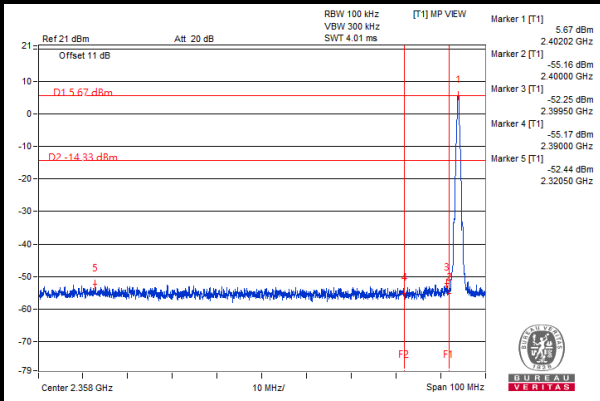

Hopping disabled\_High Channel

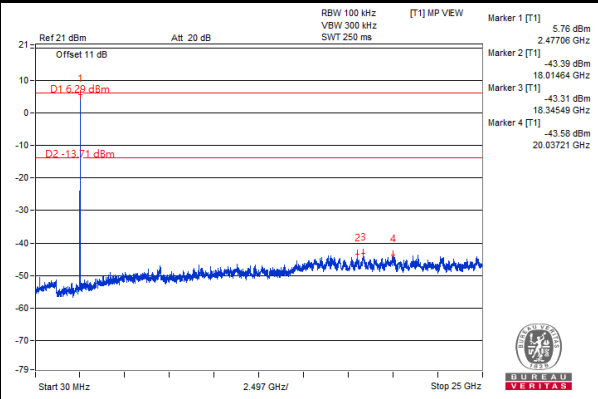
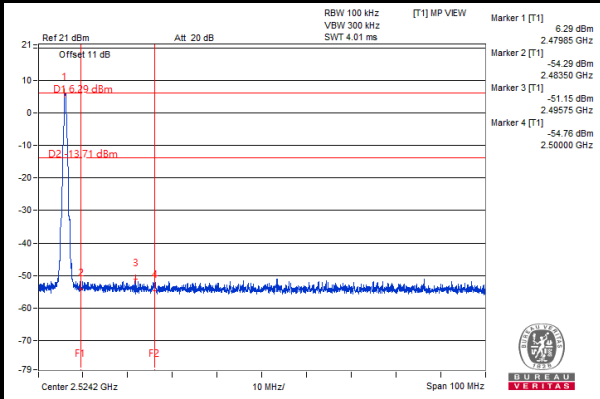

Hopping enabled\_Low Channel

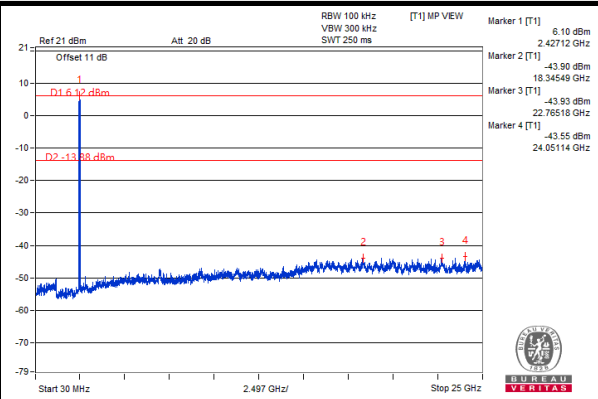
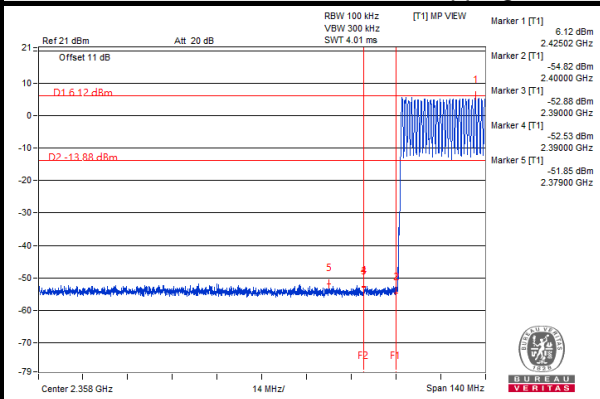

Hopping enabled\_High Channel

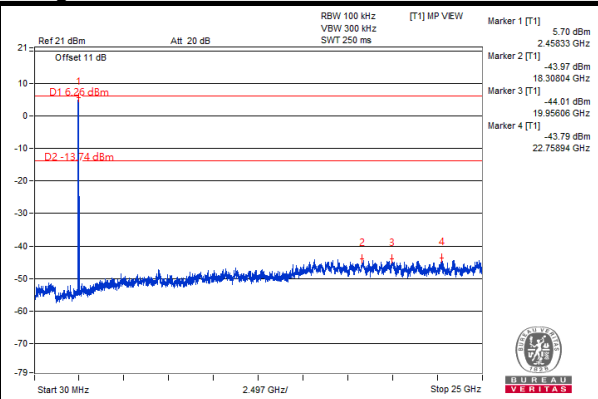
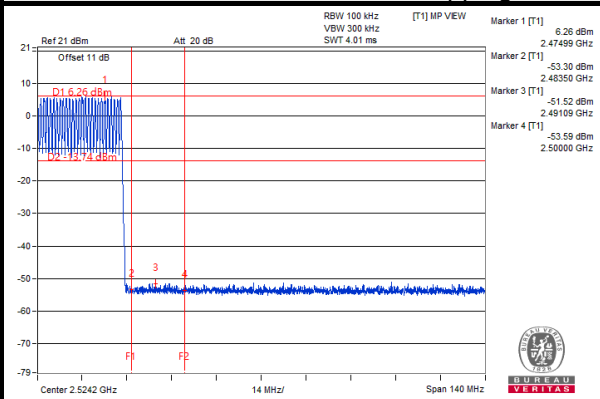

# 8DPSK

## Hopping disabled\_ Low Channel

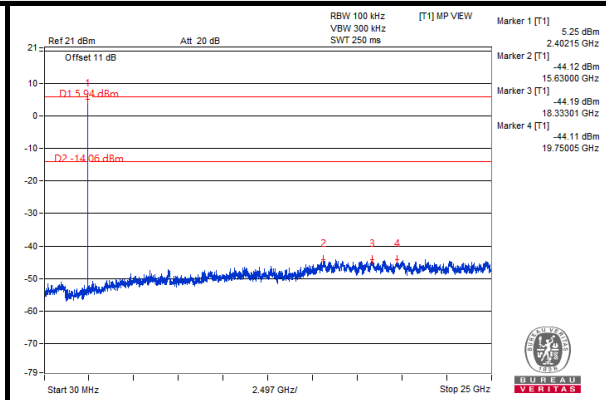
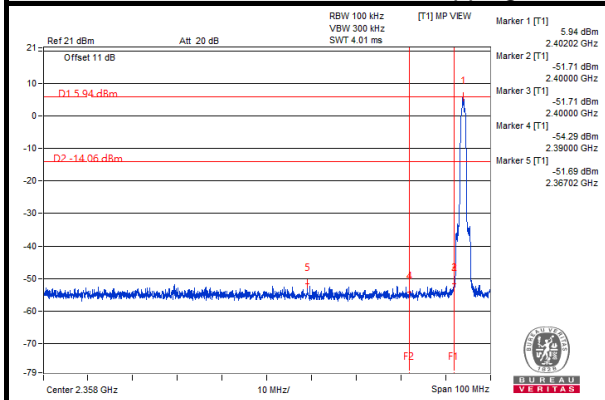

## Hopping disabled\_ High Channel

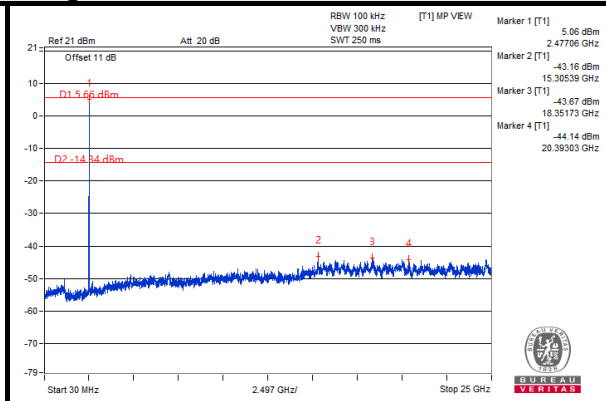
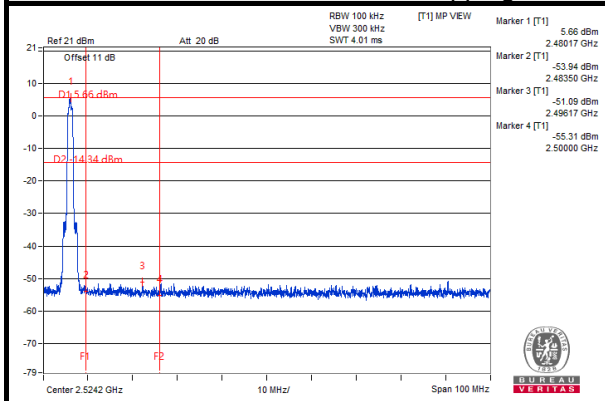

## Hopping enabled\_ Low Channel

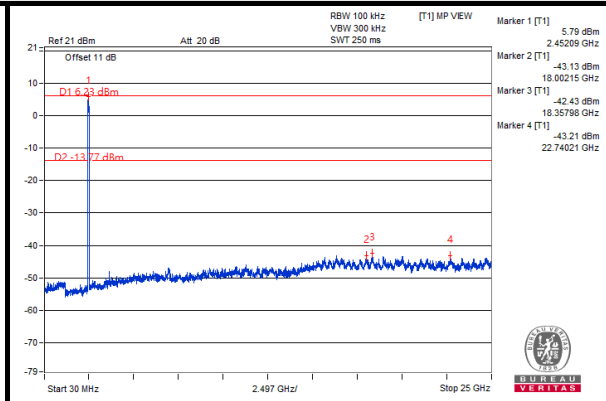
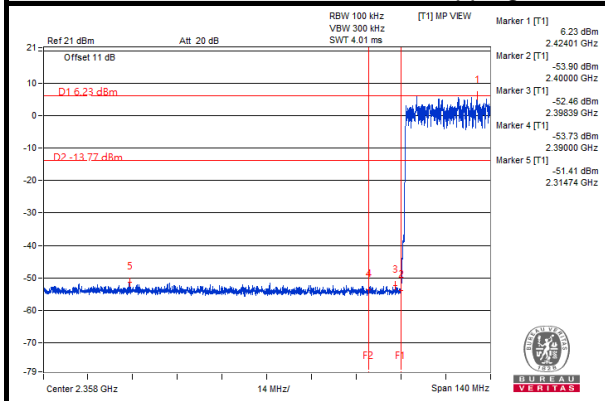

## Hopping enabled\_ High Channel

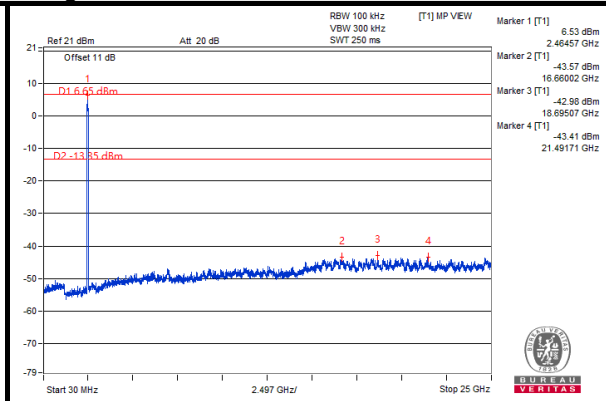
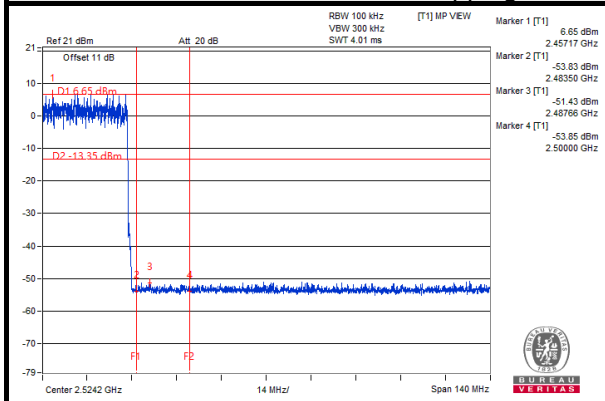

## 5 Pictures of Test Arrangements

Please refer to the attached file (Test Setup Photo).

## Annex A - Bandedge Measurement

### Mode A

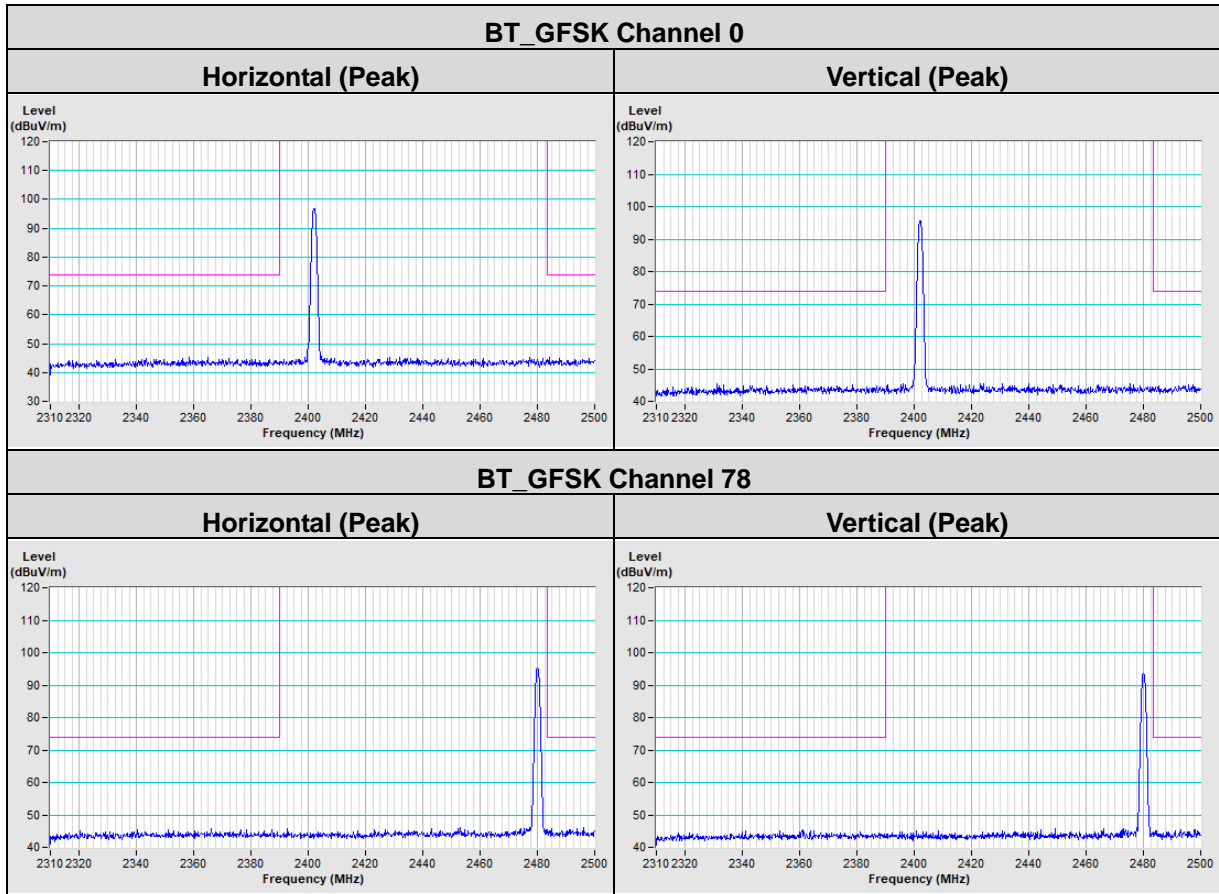



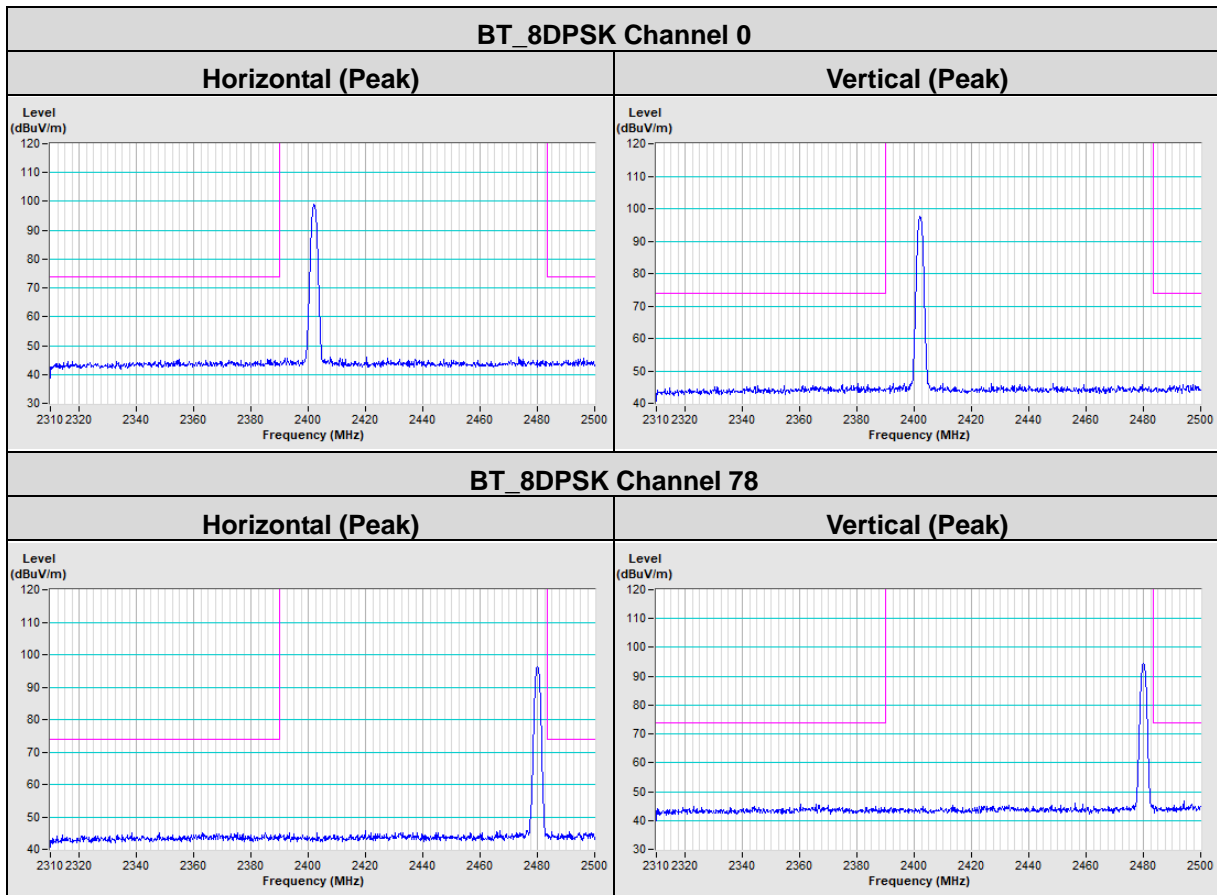

## Appendix – Information of the Testing Laboratories

We, Bureau Veritas Consumer Products Services (H.K.) Ltd., Taoyuan Branch, were founded in 1988 to provide our best service in EMC, Radio, Telecom and Safety consultation. Our laboratories are FCC recognized accredited test firms and accredited according to ISO/IEC 17025.

If you have any comments, please feel free to contact us at the following:

**Lin Kou EMC/RF Lab**

Tel: 886-2-26052180

Fax: 886-2-26051924

**Hsin Chu EMC/RF/Telecom Lab**

Tel: 886-3-6668565

Fax: 886-3-6668323

**Hwa Ya EMC/RF/Safety Lab**

Tel: 886-3-3183232

Fax: 886-3-3270892

**Email:** [service.adt@tw.bureauveritas.com](mailto:service.adt@tw.bureauveritas.com)

**Web Site:** [www.bureauveritas-adt.com](http://www.bureauveritas-adt.com)

The address and road map of all our labs can be found in our web site also.

--- END ---