

SAR TEST REPORT



The following samples were submitted and identified on behalf of the client as:

Product Name Brand	Portable Computing Device
Name	Microsoft
Model No.	1927
Contains Wi-Fi Module	1956
Model No.	
Prepared for	Microsoft Corporation One Microsoft Way, Redmond, WA 98052-6399 USA
Standards	IEEE/ANSI C95.1-1992, IEEE 1528-2013, KDB248227D01v02r02,KDB865664D01v01r04, KDB865664D02v01r02,KDB447498D01v06, KDB616217D04v01r02,KDB941225D01v03r01, KDB941225D05v02r05,KDB941225D05Av01r02
FCC ID	C3K1927
Contains FCC ID	C3K1956
Date of Receipt	Sep. 30, 2019
Date of Test(s)	Nov. 04, 2019 ~ Jan. 09, 2020
Date of Issue	Mar. 04, 2020

In the configuration tested, the EUT complied with the standards specified above.

Remarks:

This report details the results of the testing carried out on one sample, the results contained in this test report do not relate to other samples of the same product. The manufacturer should ensure that all products in series production are in conformity with the product sample detailed in this report.

This report may only be reproduced and distributed in full. If the product in this report is used in any configuration other than that detailed in the report, the manufacturer must ensure the new system complies with all relevant standards. Any mention of SGS Taiwan Electronic & Communication Laboratory or testing done by SGS Taiwan Electronic & Communication Laboratory in connection with distribution or use of the product described in this report must be approved by SGS Taiwan Electronic & Communication Laboratory in writing.

Signed on behalf of SGS

Clerk / Ruby Ou	Engineer / Bond Tsai	Asst. Manager / John Yeh

Date: Mar. 04, 2020

Unless otherwise stated the results shown in this test report refer only to the sample(s) tested and such sample(s) are retained for 90 days only.
除非另有說明，此報告結果僅對測試之樣品負責，同時此樣品僅保留90天。本報告未經本公司書面許可，不可部份複製。

This document is issued by the Company subject to its General Conditions of Service printed overleaf, available on request or accessible at www.sgs.com/terms_and_conditions.htm and for electronic format documents, subject to Terms and Conditions for Electronic Documents at www.sgs.com/terms_e-document.htm. Attention is drawn to the limitation of liability, indemnification and jurisdiction issues defined therein. Any holder of this document is advised that information contained hereon reflects the Company's findings at the time of its intervention only and within the limits of Client's instructions, if any. The Company's sole responsibility is to its Client and this document does not exonerate parties to a transaction from exercising all their rights and obligations under the transaction documents. This document cannot be reproduced except in full, without prior written approval of the Company. Any unauthorized alteration, forgery or falsification of the content or appearance of this document is unlawful and offenders may be prosecuted to the fullest extent of the law.

Revision History

Report Number	Revision	Description	Issue Date
E5/2019/90011	Rev.00	Initial creation of document	Mar. 04, 2020

Unless otherwise stated the results shown in this test report refer only to the sample(s) tested and such sample(s) are retained for 90 days only.

除非另有說明，此報告結果僅對測試之樣品負責，同時此樣品僅保留90天。本報告未經本公司書面許可，不可部份複製。

This document is issued by the Company subject to its General Conditions of Service printed overleaf, available on request or accessible at www.sgs.com/terms_and_conditions.htm and for electronic format documents, subject to Terms and Conditions for Electronic Documents at www.sgs.com/terms_e-document.htm. Attention is drawn to the limitation of liability, indemnification and jurisdiction issues defined therein. Any holder of this document is advised that information contained hereon reflects the Company's findings at the time of its intervention only and within the limits of Client's instructions, if any. The Company's sole responsibility is to its Client and this document does not exonerate parties to a transaction from exercising all their rights and obligations under the transaction documents. This document cannot be reproduced except in full, without prior written approval of the Company. Any unauthorized alteration, forgery or falsification of the content or appearance of this document is unlawful and offenders may be prosecuted to the fullest extent of the law.

Contents

1. General Information.....	4
1.1 Testing Laboratory.....	4
1.2 Details of Applicant.....	4
1.3 Description of EUT.....	5
1.3.1 LTE Downlink CA specification.....	352
1.4 Test Environment.....	357
1.5 Operation Description.....	357
1.6 Proximity sensor operation description.....	367
1.7 The SAR Measurement System.....	367
1.8 System Components.....	439
1.9 SAR System Verification.....	441
1.10 Tissue Simulant Fluid for the Frequency Band.....	443
1.11 Evaluation Procedures.....	447
1.12 Probe Calibration Procedures.....	448
1.13 Test Standards and Limits.....	451
2. Summary of Results.....	453
2.1 Decision rules.....	453
2.2 Summary of Results.....	453
2.3 Reporting statements of conformity.....	468
3. Simultaneous Transmission Analysis.....	469
3.1 Estimated SAR calculation.....	471
3.2 SPLSR evaluation and analysis.....	471
4. Instruments List.....	535
5. Measurements.....	537
6. SAR System Performance Verification.....	607
7. Uncertainty Budget.....	625
Appendixes.....	627
E5201990011 SAR_Appendix A Photographs.....	627
E5201990011 SAR_Appendix B DAE & Probe Cal. Certificate.....	627
E5201990011 SAR_Appendix C Phantom Description & Dipole Cal. Certificate.....	627

Unless otherwise stated the results shown in this test report refer only to the sample(s) tested and such sample(s) are retained for 90 days only.

除非另有說明，此報告結果僅對測試之樣品負責，同時此樣品僅保留90天。本報告未經本公司書面許可，不可部份複製。

This document is issued by the Company subject to its General Conditions of Service printed overleaf, available on request or accessible at www.sgs.com/terms_and_conditions.htm and for electronic format documents, subject to Terms and Conditions for Electronic Documents at www.sgs.com/terms_e-document.htm. Attention is drawn to the limitation of liability, indemnification and jurisdiction issues defined therein. Any holder of this document is advised that information contained hereon reflects the Company's findings at the time of its intervention only and within the limits of Client's instructions, if any. The Company's sole responsibility is to its Client and this document does not exonerate parties to a transaction from exercising all their rights and obligations under the transaction documents. This document cannot be reproduced except in full, without prior written approval of the Company. Any unauthorized alteration, forgery or falsification of the content or appearance of this document is unlawful and offenders may be prosecuted to the fullest extent of the law.

1. General Information

1.1 Testing Laboratory

SGS Taiwan Ltd. Electronics & Communication Laboratory	
No. 2, Keji 1st Rd., Guishan Township, Taoyuan County, 33383, Taiwan	
Tel	+886-2-2299-3279
Fax	+886-2-2298-0488
Internet	http://www.tw.sgs.com/

1.2 Details of Applicant

Company Name	Microsoft Corporation
Company Address	One Microsoft Way, Redmond, WA 98052-6399 USA

Unless otherwise stated the results shown in this test report refer only to the sample(s) tested and such sample(s) are retained for 90 days only.

除非另有說明，此報告結果僅對測試之樣品負責，同時此樣品僅保留90天。本報告未經本公司書面許可，不可部份複製。

This document is issued by the Company subject to its General Conditions of Service printed overleaf, available on request or accessible at www.sgs.com/terms_and_conditions.htm and for electronic format documents, subject to Terms and Conditions for Electronic Documents at www.sgs.com/terms_e-document.htm. Attention is drawn to the limitation of liability, indemnification and jurisdiction issues defined therein. Any holder of this document is advised that information contained hereon reflects the Company's findings at the time of its intervention only and within the limits of Client's instructions, if any. The Company's sole responsibility is to its Client and this document does not exonerate parties to a transaction from exercising all their rights and obligations under the transaction documents. This document cannot be reproduced except in full, without prior written approval of the Company. Any unauthorized alteration, forgery or falsification of the content or appearance of this document is unlawful and offenders may be prosecuted to the fullest extent of the law.

1.3 Description of EUT

General Information of Host:

Equipment Under Test	Portable Computing Device			
Brand Name	Microsoft			
Model No.	1927			
Contains Wi-Fi Module Model No.	1956			
FCC ID	C3K1927			
Contains FCC ID	C3K1956			
Mode of Operation	<input checked="" type="checkbox"/> WCDMA <input checked="" type="checkbox"/> HSDPA <input checked="" type="checkbox"/> HSUPA <input checked="" type="checkbox"/> LTE FDD <input checked="" type="checkbox"/> LTE TDD <input checked="" type="checkbox"/> WLAN802.11 a/b/g/n/ac/ax(20M/40M/80M/160M) <input checked="" type="checkbox"/> Bluetooth			
Duty Cycle	WCDMA		1	
	LTE FDD		1	
	LTE TDD		0.633	
	WLAN802.11 a/b/g/n/ac/ax(20M/40M/80M/160M)		1	
	Bluetooth		1	
TX Frequency Range (MHz)	WCDMA Band II	1850	—	1910
	WCDMA Band V	824	—	849
	LTE FDD Band 2	1850	—	1910
	LTE FDD Band 4	1710	—	1755
	LTE FDD Band 5	824	—	849
	LTE FDD Band 7	2500	—	2570
	LTE FDD Band 12	699	—	716
	LTE FDD Band 13	777	—	787
	LTE FDD Band 14	788	—	798
LTE FDD Band 25	1850	—	1915	

Unless otherwise stated the results shown in this test report refer only to the sample(s) tested and such sample(s) are retained for 90 days only.
除非另有說明，此報告結果僅對測試之樣品負責，同時此樣品僅保留90天。本報告未經本公司書面許可，不可部份複製。

This document is issued by the Company subject to its General Conditions of Service printed overleaf, available on request or accessible at www.sgs.com/terms_and_conditions.htm and for electronic format documents, subject to Terms and Conditions for Electronic Documents at www.sgs.com/terms_e-document.htm. Attention is drawn to the limitation of liability, indemnification and jurisdiction issues defined therein. Any holder of this document is advised that information contained hereon reflects the Company's findings at the time of its intervention only and within the limits of Client's instructions, if any. The Company's sole responsibility is to its Client and this document does not exonerate parties to a transaction from exercising all their rights and obligations under the transaction documents. This document cannot be reproduced except in full, without prior written approval of the Company. Any unauthorized alteration, forgery or falsification of the content or appearance of this document is unlawful and offenders may be prosecuted to the fullest extent of the law.

TX Frequency Range (MHz)	LTE FDD Band 26	814	—	849
	LTE FDD Band 30	2305	—	2315
	LTE TDD Band 38	2570	—	2620
	LTE TDD Band 41	2496	—	2690
	LTE FDD Band 66	1710	—	1780
	WLAN802.11 b/g/n/ax(20M)	2412	—	2472
	WLAN802.11 n/ax(40M)	2422	—	2462
	WLAN802.11 a/n/ac/ax(20M) 5.2G	5180	—	5240
	WLAN802.11 n/ac/ax(40M) 5.2G	5190	—	5230
	WLAN802.11 ac/ax(80M) 5.2G	5210		
	WLAN802.11 ac/ax(160M) 5.2G	5250		
	WLAN802.11 a/n/ac/ax(20M) 5.3G	5260	—	5320
	WLAN802.11 n/ac/ax(40M) 5.3G	5270	—	5310
	WLAN802.11 ac/ax(80M) 5.3G	5290		
	WLAN802.11 a/n/ac/ax(20M) 5.6G	5500	—	5720
	WLAN802.11 n/ac/ax(40M) 5.6G	5510	—	5710
	WLAN802.11 ac/ax(80M) 5.6G	5530	—	5690
	WLAN802.11 ac/ax(160M) 5.6G	5570		
	WLAN802.11 a/n/ac/ax(20M) 5.8G	5745	—	5825
	WLAN802.11 n/ac/ax(40M) 5.8G	5755	—	5795
WLAN802.11 ac/ax(80M) 5.8G	5775			
Bluetooth	2402	—	2480	
Channel Number (ARFCN)	WCDMA Band II	9262	—	9538
	WCDMA Band V	4132	—	4233
	LTE FDD Band 2	18607	—	19193
	LTE FDD Band 4	19957	—	20393
	LTE FDD Band 5	20407	—	20643
	LTE FDD Band 7	20775	—	21425

Unless otherwise stated the results shown in this test report refer only to the sample(s) tested and such sample(s) are retained for 90 days only.
除非另有說明，此報告結果僅對測試之樣品負責，同時此樣品僅保留90天。本報告未經本公司書面許可，不可部份複製。

This document is issued by the Company subject to its General Conditions of Service printed overleaf, available on request or accessible at www.sgs.com/terms_and_conditions.htm and for electronic format documents, subject to Terms and Conditions for Electronic Documents at www.sgs.com/terms_e-document.htm. Attention is drawn to the limitation of liability, indemnification and jurisdiction issues defined therein. Any holder of this document is advised that information contained hereon reflects the Company's findings at the time of its intervention only and within the limits of Client's instructions, if any. The Company's sole responsibility is to its Client and this document does not exonerate parties to a transaction from exercising all their rights and obligations under the transaction documents. This document cannot be reproduced except in full, without prior written approval of the Company. Any unauthorized alteration, forgery or falsification of the content or appearance of this document is unlawful and offenders may be prosecuted to the fullest extent of the law.

Channel Number (ARFCN)	LTE FDD Band 12	23017	—	23173
	LTE FDD Band 13	23205	—	23255
	LTE FDD Band 14	23305	—	23355
	LTE FDD Band 25	26047	—	26683
	LTE FDD Band 26	26697	—	27033
	LTE FDD Band 30	27685	—	27735
	LTE TDD Band 38	37775	—	38225
	LTE TDD Band 41	39675	—	41565
	LTE FDD Band 66	131979	—	132665
	WLAN802.11 b/g/n/ax(20M)	1	—	13
	WLAN802.11 n/ax(40M)	3	—	11
	WLAN802.11 a/n/ac/ax(20M) 5.2G	36	—	48
	WLAN802.11 n/ac/ax(40M) 5.2G	38	—	46
	WLAN802.11 ac/ax(80M) 5.2G		42	
	WLAN802.11 ac/ax(160M) 5.2G		50	
	WLAN802.11 a/n/ac/ax(20M) 5.3G	52	—	64
	WLAN802.11 n/ac/ax(40M) 5.3G	54	—	62
	WLAN802.11 ac/ax(80M) 5.3G		58	
	WLAN802.11 a/n/ac/ax(20M) 5.6G	100	—	144
	WLAN802.11 n/ac/ax(40M) 5.6G	102	—	142
	WLAN802.11 ac/ax(80M) 5.6G	106	—	138
	WLAN802.11 ac/ax(160M) 5.6G		114	
	WLAN802.11 a/n/ac/ax(20M) 5.8G	149	—	165
	WLAN802.11 n/ac/ax(40M) 5.8G	151	—	159
WLAN802.11 ac/ax(80M) 5.8G		155		
Bluetooth	0	—	78	

Note:

This is the SAR report for host FCC ID: [C3K1927] containing module FCC ID: [C3K1956].

Unless otherwise stated the results shown in this test report refer only to the sample(s) tested and such sample(s) are retained for 90 days only.
除非另有說明，此報告結果僅對測試之樣品負責，同時此樣品僅保留90天。本報告未經本公司書面許可，不可部份複製。

This document is issued by the Company subject to its General Conditions of Service printed overleaf, available on request or accessible at www.sgs.com/terms_and_conditions.htm and for electronic format documents, subject to Terms and Conditions for Electronic Documents at www.sgs.com/terms_e-document.htm. Attention is drawn to the limitation of liability, indemnification and jurisdiction issues defined therein. Any holder of this document is advised that information contained hereon reflects the Company's findings at the time of its intervention only and within the limits of Client's instructions, if any. The Company's sole responsibility is to its Client and this document does not exonerate parties to a transaction from exercising all their rights and obligations under the transaction documents. This document cannot be reproduced except in full, without prior written approval of the Company. Any unauthorized alteration, forgery or falsification of the content or appearance of this document is unlawful and offenders may be prosecuted to the fullest extent of the law.

**WWAN only and WWAN+WLAN
Full power**

Max. SAR (1 g) (Unit: W/Kg)				
Band	Measured	Reported	Channel	Position
WCDMA Band II	0.57	0.66	9262	Top side
WCDMA Band V	0.24	0.29	4132	Left side
LTE FDD Band 5	0.22	0.27	20450	Left side
LTE FDD Band 7	1.07	1.11	20850	Left side
LTE FDD Band 12	0.19	0.22	23095	Left side
LTE FDD Band 13	0.19	0.23	23230	Left side
LTE FDD Band 14	0.20	0.24	23330	Left side
LTE FDD Band 25	0.57	0.64	26140	Top side
LTE FDD Band 26	0.22	0.27	26865	Left side
LTE FDD Band 30	0.82	0.92	27710	Left side
LTE TDD Band 41	0.65	0.73	41490	Left side
LTE FDD Band 66	0.80	0.85	132322	Top side

Unless otherwise stated the results shown in this test report refer only to the sample(s) tested and such sample(s) are retained for 90 days only.

除非另有說明，此報告結果僅對測試之樣品負責，同時此樣品僅保留90天。本報告未經本公司書面許可，不可部份複製。

This document is issued by the Company subject to its General Conditions of Service printed overleaf, available on request or accessible at www.sgs.com/terms_and_conditions.htm and for electronic format documents, subject to Terms and Conditions for Electronic Documents at www.sgs.com/terms_e-document.htm. Attention is drawn to the limitation of liability, indemnification and jurisdiction issues defined therein. Any holder of this document is advised that information contained hereon reflects the Company's findings at the time of its intervention only and within the limits of Client's instructions, if any. The Company's sole responsibility is to its Client and this document does not exonerate parties to a transaction from exercising all their rights and obligations under the transaction documents. This document cannot be reproduced except in full, without prior written approval of the Company. Any unauthorized alteration, forgery or falsification of the content or appearance of this document is unlawful and offenders may be prosecuted to the fullest extent of the law.

Reduced power

Max. SAR (1 g) (Unit: W/Kg)				
Band	Measured	Reported	Channel	Position
WCDMA Band II	0.87	0.90	9538	Back side
WCDMA Band V	0.80	0.89	4132	Top side
LTE FDD Band 5	0.89	0.96	20450	Top side
LTE FDD Band 7	0.86	0.95	21350	Back side
LTE FDD Band 12	0.70	0.76	23095	Top side
LTE FDD Band 13	0.83	0.95	23230	Top side
LTE FDD Band 14	0.77	0.88	23330	Top side
LTE FDD Band 25	0.88	0.98	26140	Back side
LTE FDD Band 26	0.89	0.98	26765	Top side
LTE FDD Band 30	0.84	0.88	27710	Back side
LTE TDD Band 41	0.69	0.69	41490	Back side
LTE FDD Band 66	0.89	0.96	132572	Back side

Unless otherwise stated the results shown in this test report refer only to the sample(s) tested and such sample(s) are retained for 90 days only.

除非另有說明，此報告結果僅對測試之樣品負責，同時此樣品僅保留90天。本報告未經本公司書面許可，不可部份複製。

This document is issued by the Company subject to its General Conditions of Service printed overleaf, available on request or accessible at www.sgs.com/terms_and_conditions.htm and for electronic format documents, subject to Terms and Conditions for Electronic Documents at www.sgs.com/terms_e-document.htm. Attention is drawn to the limitation of liability, indemnification and jurisdiction issues defined therein. Any holder of this document is advised that information contained hereon reflects the Company's findings at the time of its intervention only and within the limits of Client's instructions, if any. The Company's sole responsibility is to its Client and this document does not exonerate parties to a transaction from exercising all their rights and obligations under the transaction documents. This document cannot be reproduced except in full, without prior written approval of the Company. Any unauthorized alteration, forgery or falsification of the content or appearance of this document is unlawful and offenders may be prosecuted to the fullest extent of the law.

WWAN+WLAN
WLAN full power

Max. SAR (1g) (Unit: W/Kg)					
Antenna	Band	Measured	Reported	Channel	Position
Tx1	WLAN 802.11b	0.21	0.22	6	Back side
	WLAN 802.11ac(160M) 5.2G	0.11	0.12	50	Back side
	WLAN 802.11ac(80M) 5.3G	0.21	0.21	58	Back side
	WLAN 802.11ac(160M) 5.6G	0.22	0.23	114	Back side
	WLAN 802.11ac(80M) 5.8G	0.20	0.21	155	Back side
Tx2	WLAN 802.11b	0.19	0.19	6	Back side
	Bluetooth(GFSK)	0.05	0.09	39	Back side
	WLAN 802.11ac(160M) 5.2G	0.18	0.19	50	Back side
	WLAN 802.11ac(80M) 5.3G	0.17	0.18	58	Back side
	WLAN 802.11ac(160M) 5.6G	0.10	0.11	114	Back side
	WLAN 802.11ac(80M) 5.8G	0.16	0.17	155	Back side

Unless otherwise stated the results shown in this test report refer only to the sample(s) tested and such sample(s) are retained for 90 days only.

除非另有說明，此報告結果僅對測試之樣品負責，同時此樣品僅保留90天。本報告未經本公司書面許可，不可部份複製。

This document is issued by the Company subject to its General Conditions of Service printed overleaf, available on request or accessible at www.sgs.com/terms_and_conditions.htm and for electronic format documents, subject to Terms and Conditions for Electronic Documents at www.sgs.com/terms_e-document.htm. Attention is drawn to the limitation of liability, indemnification and jurisdiction issues defined therein. Any holder of this document is advised that information contained hereon reflects the Company's findings at the time of its intervention only and within the limits of Client's instructions, if any. The Company's sole responsibility is to its Client and this document does not exonerate parties to a transaction from exercising all their rights and obligations under the transaction documents. This document cannot be reproduced except in full, without prior written approval of the Company. Any unauthorized alteration, forgery or falsification of the content or appearance of this document is unlawful and offenders may be prosecuted to the fullest extent of the law.

WLAN reduced power

Max. SAR (1g) (Unit: W/Kg)					
Antenna	Band	Measured	Reported	Channel	Position
Tx1	WLAN 802.11b	0.06	0.06	1	Top side
	WLAN 802.11ac(160M) 5.2G	0.20	0.20	50	Top side
	WLAN 802.11ac(80M) 5.3G	0.18	0.18	58	Top side
	WLAN 802.11ac(160M) 5.6G	0.22	0.23	114	Top side
	WLAN 802.11ac(80M) 5.8G	0.21	0.21	155	Top side
Tx2	WLAN 802.11b	0.21	0.21	11	Back side
	WLAN 802.11ac(160M) 5.2G	0.24	0.25	50	Back side
	WLAN 802.11ac(80M) 5.3G	0.25	0.25	58	Back side
	WLAN 802.11ac(160M) 5.6G	0.19	0.20	114	Back side
	WLAN 802.11ac(80M) 5.8G	0.22	0.23	155	Back side

Unless otherwise stated the results shown in this test report refer only to the sample(s) tested and such sample(s) are retained for 90 days only.

除非另有說明，此報告結果僅對測試之樣品負責，同時此樣品僅保留90天。本報告未經本公司書面許可，不可部份複製。

This document is issued by the Company subject to its General Conditions of Service printed overleaf, available on request or accessible at www.sgs.com/terms_and_conditions.htm and for electronic format documents, subject to Terms and Conditions for Electronic Documents at www.sgs.com/terms_e-document.htm. Attention is drawn to the limitation of liability, indemnification and jurisdiction issues defined therein. Any holder of this document is advised that information contained hereon reflects the Company's findings at the time of its intervention only and within the limits of Client's instructions, if any. The Company's sole responsibility is to its Client and this document does not exonerate parties to a transaction from exercising all their rights and obligations under the transaction documents. This document cannot be reproduced except in full, without prior written approval of the Company. Any unauthorized alteration, forgery or falsification of the content or appearance of this document is unlawful and offenders may be prosecuted to the fullest extent of the law.

WLAN only
WLAN Full power

Max. SAR (1g) (Unit: W/Kg)					
Antenna	Band	Measured	Reported	Channel	Position
Tx1	WLAN 802.11b	0.87	0.88	1	Back side
	WLAN 802.11ac(80M) 5.2G	0.70	0.71	42	Back side
	WLAN 802.11ac(80M) 5.3G	0.74	0.75	58	Back side
	WLAN 802.11ac(80M) 5.6G	0.90	0.92	122	Back side
	WLAN 802.11ac(80M) 5.8G	0.54	0.55	155	Back side
Tx2	WLAN 802.11b	1.12	1.13	10	Back side
	WLAN 802.11n(40M) 5.2G	0.67	0.69	46	Back side
	WLAN 802.11ac(80M) 5.2G	0.89	0.98	42	Back side
	WLAN 802.11n(40M) 5.3G	1.10	1.13	54	Back side
	WLAN 802.11ac(80M) 5.6G	1.09	1.10	138	Back side
	WLAN 802.11n(40M) 5.8G	0.97	1.00	159	Back side
	WLAN 802.11ac(80M) 5.8G	0.98	1.02	155	Back side

Unless otherwise stated the results shown in this test report refer only to the sample(s) tested and such sample(s) are retained for 90 days only.

除非另有說明，此報告結果僅對測試之樣品負責，同時此樣品僅保留90天。本報告未經本公司書面許可，不可部份複製。

This document is issued by the Company subject to its General Conditions of Service printed overleaf, available on request or accessible at www.sgs.com/terms_and_conditions.htm and for electronic format documents, subject to Terms and Conditions for Electronic Documents at www.sgs.com/terms_e-document.htm. Attention is drawn to the limitation of liability, indemnification and jurisdiction issues defined therein. Any holder of this document is advised that information contained hereon reflects the Company's findings at the time of its intervention only and within the limits of Client's instructions, if any. The Company's sole responsibility is to its Client and this document does not exonerate parties to a transaction from exercising all their rights and obligations under the transaction documents. This document cannot be reproduced except in full, without prior written approval of the Company. Any unauthorized alteration, forgery or falsification of the content or appearance of this document is unlawful and offenders may be prosecuted to the fullest extent of the law.

WLAN Reduced power

Max. SAR (1g) (Unit: W/Kg)					
Antenna	Band	Measured	Reported	Channel	Position
Tx1	WLAN 802.11b	1.07	1.08	1	Top side
	WLAN 802.11ac(160M) 5.2G	0.76	0.78	50	Top side
	WLAN 802.11ac(80M) 5.3G	0.76	0.77	58	Top side
	WLAN 802.11ac(80M) 5.6G	0.84	0.86	138	Top side
	WLAN 802.11ac(160M) 5.6G	0.88	0.90	114	Top side
	WLAN 802.11ac(80M) 5.8G	0.79	0.80	155	Top side
Tx2	WLAN 802.11b	0.89	0.90	11	Back side
	WLAN 802.11ac(160M) 5.2G	0.76	0.78	50	Back side
	WLAN 802.11n(40M) 5.3G	0.93	0.94	62	Back side
	WLAN 802.11ac(80M) 5.3G	0.82	0.84	58	Back side
	WLAN 802.11ac(80M) 5.6G	0.95	0.97	122	Back side
	WLAN 802.11ac(160M) 5.6G	0.92	0.94	114	Back side
	WLAN 802.11ac(80M) 5.8G	0.73	0.75	155	Back side

Unless otherwise stated the results shown in this test report refer only to the sample(s) tested and such sample(s) are retained for 90 days only.

除非另有說明，此報告結果僅對測試之樣品負責，同時此樣品僅保留90天。本報告未經本公司書面許可，不可部份複製。

This document is issued by the Company subject to its General Conditions of Service printed overleaf, available on request or accessible at www.sgs.com/terms_and_conditions.htm and for electronic format documents, subject to Terms and Conditions for Electronic Documents at www.sgs.com/terms_e-document.htm. Attention is drawn to the limitation of liability, indemnification and jurisdiction issues defined therein. Any holder of this document is advised that information contained hereon reflects the Company's findings at the time of its intervention only and within the limits of Client's instructions, if any. The Company's sole responsibility is to its Client and this document does not exonerate parties to a transaction from exercising all their rights and obligations under the transaction documents. This document cannot be reproduced except in full, without prior written approval of the Company. Any unauthorized alteration, forgery or falsification of the content or appearance of this document is unlawful and offenders may be prosecuted to the fullest extent of the law.

Antenna Information

Vendor	Advanced Wireless & Antenna Inc.									
Antenna	Main/Tx1 (monopole)					Aux/Tx2 (monopole)				
Part Number	DQ60AML0001					DQ60AML0001				
Frequency	2.4G	5.2G	5.3G	5.6G	5.8G	2.4G	5.2G	5.3G	5.6G	5.8G
Gain (dBi)	0.30	-1.80	-2.50	-0.20	-1.50	-0.9	-1.80	-1.90	-1.7	-1.4
Vendor	Type	Main / Aux	Antenna Part No.	Modulation	Frequency (MHz)			Peak Antenna Gain (dBi)		
ADVANCED WIRELESS & ANTENNA INC.	Monopole	Main	DQ60AML0001 / AML00-000010	WCDMA / HSPA Band II	1852.4	~	1907.6	0.7		
				WCDMA / HSPA Band V	826.4	~	846.6	-2.5		
				LTE Band 2	1850	~	1910	0.7		
				LTE Band 4	1710	~	1755	2.4		
				LTE Band 5	824	~	849	-2.5		
				LTE Band 7	2503	~	2560	1.3		
				LTE Band 12	699	~	716	-2		
				LTE Band 13	777	~	787	-1.9		
				LTE Band 14	788	~	798	-1.9		
				LTE Band 25	1850	~	1915	0.7		
				LTE Band 26	824	~	849	-2.5		
				LTE Band 26 (Part 90S)	814	~	824	-2.5		
				LTE Band 30	2305	~	2315	0.4		
				LTE Band 38	2573	~	2610	0.6		
LTE Band 41	2496	~	2690	1.3						
LTE Band 66	1710	~	1780	2.4						

WWAN Tune up tolerance:

Bands	WCDMA BII	WCDMA BV	LTE B2	LTE B4	LTE B5	LTE B7	LTE B12	LTE B13
*Full Power	25	25	25	24.5	25	22.8	25	25
	(24 +/- 1dB)	(24 +/- 1dB)	(24 +/- 1dB)	(23.5 +/- 1dB)	(24 +/- 1dB)	(22 + 0.8/- 0.7 dB)	(24 +/- 1dB)	(24 +/- 1dB)
**Down Power	16	19.5	15.6	16.9	20	15	20	20
	(15 +/- 1dB)	(18.5 +/- 1dB)	(14.6 +/- 1dB)	(15.9 +/- 1dB)	(19 +/- 1dB)	(14 +/- 1dB)	(19 +/- 1dB)	(19 +/- 1dB)
Bands	LTE B14	LTE B25	LTE B26	LTE B30	LTE B38	LTE B41	LTE B66	
*Full Power	25	25	25	23.5	24.5	24.5	24.5	
	(24 +/- 1dB)	(24 +/- 1dB)	(24 +/- 1dB)	(22.5 +/- 1dB)	(23.5 +/- 1dB)	(23.5 +/- 1dB)	(23.5 +/- 1dB)	
**Down Power	19.5	15.6	20	16.5	17.3	17.3	16.9	
	(18.5 +/- 1dB)	(14.6 +/- 1dB)	(19 +/- 1dB)	(15.5 +/- 1dB)	(16.3 +/- 1dB)	(16.3 +/- 1dB)	(15.9 +/- 1dB)	

Unless otherwise stated the results shown in this test report refer only to the sample(s) tested and such sample(s) are retained for 90 days only.

除非另有說明，此報告結果僅對測試之樣品負責，同時此樣品僅保留90天。本報告未經本公司書面許可，不可部份複製。

This document is issued by the Company subject to its General Conditions of Service printed overleaf, available on request or accessible at www.sgs.com/terms_and_conditions.htm and for electronic format documents, subject to Terms and Conditions for Electronic Documents at www.sgs.com/terms_e-document.htm. Attention is drawn to the limitation of liability, indemnification and jurisdiction issues defined therein. Any holder of this document is advised that information contained hereon reflects the Company's findings at the time of its intervention only and within the limits of Client's instructions, if any. The Company's sole responsibility is to its Client and this document does not exonerate parties to a transaction from exercising all their rights and obligations under the transaction documents. This document cannot be reproduced except in full, without prior written approval of the Company. Any unauthorized alteration, forgery or falsification of the content or appearance of this document is unlawful and offenders may be prosecuted to the fullest extent of the law.

WCDMA Band II / Band V - HSDPA / HSUPA conducted power table
(Full power):
Unit: dBm

Band		WCDMA II		
TX Channel		9262	9400	9538
Frequency (MHz)		1852.4	1880	1907.6
Max. Rated Avg. Power+Max. Tolerance (dBm)		25.00		
3GPP Rel 99	RMC 12.2Kbps	24.33	24.31	24.32
3GPP Rel 5	HSDPA Subtest-1	23.32	23.28	23.38
	HSDPA Subtest-2	22.79	22.84	22.80
	HSDPA Subtest-3	22.81	22.83	22.85
	HSDPA Subtest-4	22.80	22.72	22.81
3GPP Rel 6	HSUPA Subtest-1	23.18	23.27	23.37
	HSUPA Subtest-2	21.21	21.27	21.23
	HSUPA Subtest-3	22.17	22.24	22.25
	HSUPA Subtest-4	21.24	21.24	21.32
	HSUPA Subtest-5	23.03	23.15	23.11

Band		WCDMA V		
TX Channel		4132	4183	4233
Frequency (MHz)		826.4	836.6	846.6
Max. Rated Avg. Power+Max. Tolerance (dBm)		25.00		
3GPP Rel 99	RMC 12.2Kbps	24.21	24.13	24.08
3GPP Rel 5	HSDPA Subtest-1	23.24	23.10	23.13
	HSDPA Subtest-2	22.74	22.58	22.66
	HSDPA Subtest-3	22.67	22.55	22.65
	HSDPA Subtest-4	22.67	22.58	22.62
3GPP Rel 6	HSUPA Subtest-1	23.23	23.16	23.20
	HSUPA Subtest-2	21.22	21.12	21.16
	HSUPA Subtest-3	22.09	22.14	22.15
	HSUPA Subtest-4	21.19	21.13	21.12
	HSUPA Subtest-5	23.22	23.07	22.96

Unless otherwise stated the results shown in this test report refer only to the sample(s) tested and such sample(s) are retained for 90 days only.

除非另有說明，此報告結果僅對測試之樣品負責，同時此樣品僅保留90天。本報告未經本公司書面許可，不可部份複製。

This document is issued by the Company subject to its General Conditions of Service printed overleaf, available on request or accessible at www.sgs.com/terms_and_conditions.htm and for electronic format documents, subject to Terms and Conditions for Electronic Documents at www.sgs.com/terms_e-document.htm. Attention is drawn to the limitation of liability, indemnification and jurisdiction issues defined therein. Any holder of this document is advised that information contained hereon reflects the Company's findings at the time of its intervention only and within the limits of Client's instructions, if any. The Company's sole responsibility is to its Client and this document does not exonerate parties to a transaction from exercising all their rights and obligations under the transaction documents. This document cannot be reproduced except in full, without prior written approval of the Company. Any unauthorized alteration, forgery or falsification of the content or appearance of this document is unlawful and offenders may be prosecuted to the fullest extent of the law.

WCDMA Band II / Band V - HSDPA / HSUPA conducted power table (Reduced power):

Unit: dBm

Band		WCDMA II		
TX Channel		9262	9400	9538
Frequency (MHz)		1852.4	1880	1907.6
Max. Rated Avg. Power+Max. Tolerance (dBm)		16.00		
3GPP Rel 99	RMC 12.2Kbps	15.80	15.81	15.83
3GPP Rel 5	HSDPA Subtest-1	14.81	14.87	14.78
	HSDPA Subtest-2	14.31	14.28	14.25
	HSDPA Subtest-3	14.34	14.27	14.27
	HSDPA Subtest-4	14.32	14.33	14.42
3GPP Rel 6	HSUPA Subtest-1	14.87	14.60	14.66
	HSUPA Subtest-2	14.26	14.11	14.23
	HSUPA Subtest-3	14.74	14.72	14.56
	HSUPA Subtest-4	14.68	14.67	14.74
	HSUPA Subtest-5	14.75	14.59	14.56

Band		WCDMA V		
TX Channel		4132	4183	4233
Frequency (MHz)		826.4	836.6	846.6
Max. Rated Avg. Power+Max. Tolerance (dBm)		19.50		
3GPP Rel 99	RMC 12.2Kbps	19.05	19.08	19.14
3GPP Rel 5	HSDPA Subtest-1	18.02	18.09	18.13
	HSDPA Subtest-2	17.51	17.55	17.56
	HSDPA Subtest-3	17.56	17.59	17.65
	HSDPA Subtest-4	17.53	17.52	17.58
3GPP Rel 6	HSUPA Subtest-1	17.94	17.99	18.08
	HSUPA Subtest-2	15.93	15.99	16.02
	HSUPA Subtest-3	17.02	17.01	17.11
	HSUPA Subtest-4	16.03	16.14	16.13
	HSUPA Subtest-5	17.81	17.83	18.05

Unless otherwise stated the results shown in this test report refer only to the sample(s) tested and such sample(s) are retained for 90 days only.

除非另有說明，此報告結果僅對測試之樣品負責，同時此樣品僅保留90天。本報告未經本公司書面許可，不可部份複製。

This document is issued by the Company subject to its General Conditions of Service printed overleaf, available on request or accessible at www.sgs.com/terms_and_conditions.htm and for electronic format documents, subject to Terms and Conditions for Electronic Documents at www.sgs.com/terms_e-document.htm. Attention is drawn to the limitation of liability, indemnification and jurisdiction issues defined therein. Any holder of this document is advised that information contained hereon reflects the Company's findings at the time of its intervention only and within the limits of Client's instructions, if any. The Company's sole responsibility is to its Client and this document does not exonerate parties to a transaction from exercising all their rights and obligations under the transaction documents. This document cannot be reproduced except in full, without prior written approval of the Company. Any unauthorized alteration, forgery or falsification of the content or appearance of this document is unlawful and offenders may be prosecuted to the fullest extent of the law.

Sub-Test for HSDPA

SUB-TEST	β_c	β_d	β_d (SF)	β_c/β_d	β_{HS} (Note 1, Note 2)	CM (dB) (Note 3)	MPR (dB) (Note 3)
1	2/15	15/15	64	2/15	4/15	0.0	0.0
2	12/15	15/15	64	12/15	24/15	1.0	0.0
3	15/15	8/15	64	15/8	30/15	1.5	0.5
4	15/15	4/15	64	15/4	30/15	1.5	0.5

Sub-Test for HSUPA

SUB-TEST	β_c	β_d	β_d (SF)	β_c/β_d	β_{HS} (Note 1)	β_{ec}	β_{ed} (Note 5) (Note 6)	β_{ed} (SF)	β_{ed} (Codes)	CM (dB) (Note 2)	MPR (dB) (Note 2)	AG Index (Note 6)	E-TFCI
1	11/15	15/15	64	11/15	22/15	209/225	1309/225	4	1	1.0	0.0	20	75
2	6/15	15/15	64	6/15	12/15	12/15	94/75	4	1	3.0	2.0	12	67
3	15/15	9/15	64	15/9	30/15	30/15	β_{ed1} : 47/15 β_{ed2} : 47/15	4 4	2	2.0	1.0	15	92
4	2/15	15/15	64	2/15	4/15	2/15	56/75	4	1	3.0	2.0	17	71
5	15/15	15/15	64	15/15	30/15	24/15	134/15	4	1	1.0	0.0	21	81

Unless otherwise stated the results shown in this test report refer only to the sample(s) tested and such sample(s) are retained for 90 days only.

除非另有說明，此報告結果僅對測試之樣品負責，同時此樣品僅保留90天。本報告未經本公司書面許可，不可部份複製。

This document is issued by the Company subject to its General Conditions of Service printed overleaf, available on request or accessible at www.sgs.com/terms_and_conditions.htm and for electronic format documents, subject to Terms and Conditions for Electronic Documents at www.sgs.com/terms_e-document.htm. Attention is drawn to the limitation of liability, indemnification and jurisdiction issues defined therein. Any holder of this document is advised that information contained hereon reflects the Company's findings at the time of its intervention only and within the limits of Client's instructions, if any. The Company's sole responsibility is to its Client and this document does not exonerate parties to a transaction from exercising all their rights and obligations under the transaction documents. This document cannot be reproduced except in full, without prior written approval of the Company. Any unauthorized alteration, forgery or falsification of the content or appearance of this document is unlawful and offenders may be prosecuted to the fullest extent of the law.

LTE FDD Band 2 / Band 4 / Band 5 / Band 7 / Band 12 / Band 13 / Band 14 / Band 25 / Band 26 / Band 30 / Band 66 power table (Full power)

FDD Band 2									
BW(Mhz)	Modulation	RB Size	RB Offset	Frequency (MHz)	Channel	Conducted power (dBm)	Target Power + Max. Tolerance (dBm)	MPR Allowed per 3GPP(dB)	
20	QPSK	1 RB	0	1860	18700	24.21	25	0	
				1880	18900	24.11	25	0	
				1900	19100	24.27	25	0	
			50	1860	18700	23.92	25	0	
				1880	18900	24.16	25	0	
				1900	19100	24.22	25	0	
			99	1860	18700	24.07	25	0	
				1880	18900	23.98	25	0	
				1900	19100	24.39	25	0	
		50 RB	0	1860	18700	23.09	24	0-1	
				1880	18900	23.08	24	0-1	
				1900	19100	23.31	24	0-1	
			25	1860	18700	23.02	24	0-1	
				1880	18900	23.00	24	0-1	
				1900	19100	23.25	24	0-1	
			50	1860	18700	23.00	24	0-1	
				1880	18900	22.99	24	0-1	
				1900	19100	23.23	24	0-1	
		100RB	1860	18700	22.43	24	0-1		
			1880	18900	22.53	24	0-1		
			1900	19100	22.80	24	0-1		
		16-QAM	1 RB	0	1860	18700	23.49	24	0-1
					1880	18900	23.33	24	0-1
					1900	19100	23.82	24	0-1
	50			1860	18700	23.12	24	0-1	
				1880	18900	23.02	24	0-1	
				1900	19100	23.11	24	0-1	
	99			1860	18700	23.07	24	0-1	
				1880	18900	23.34	24	0-1	
				1900	19100	23.36	24	0-1	
	50 RB			0	1860	18700	22.04	23	0-2
					1880	18900	22.10	23	0-2
					1900	19100	22.32	23	0-2
			25	1860	18700	22.14	23	0-2	
				1880	18900	22.04	23	0-2	
				1900	19100	22.27	23	0-2	
			50	1860	18700	22.01	23	0-2	
				1880	18900	21.99	23	0-2	
				1900	19100	22.33	23	0-2	
			100RB	1860	18700	21.39	23	0-2	
				1880	18900	21.46	23	0-2	
				1900	19100	21.79	23	0-2	

Unless otherwise stated the results shown in this test report refer only to the sample(s) tested and such sample(s) are retained for 90 days only.

除非另有說明，此報告結果僅對測試之樣品負責，同時此樣品僅保留90天。本報告未經本公司書面許可，不可部份複製。

This document is issued by the Company subject to its General Conditions of Service printed overleaf, available on request or accessible at www.sgs.com/terms_and_conditions.htm and for electronic format documents, subject to Terms and Conditions for Electronic Documents at www.sgs.com/terms_e-document.htm. Attention is drawn to the limitation of liability, indemnification and jurisdiction issues defined therein. Any holder of this document is advised that information contained hereon reflects the Company's findings at the time of its intervention only and within the limits of Client's instructions, if any. The Company's sole responsibility is to its Client and this document does not exonerate parties to a transaction from exercising all their rights and obligations under the transaction documents. This document cannot be reproduced except in full, without prior written approval of the Company. Any unauthorized alteration, forgery or falsification of the content or appearance of this document is unlawful and offenders may be prosecuted to the fullest extent of the law.

FDD Band 2								
BW(Mhz)	Modulation	RB Size	RB Offset	Frequency (MHz)	Channel	Conducted power (dBm)	Target Power + Max. Tolerance (dBm)	MPR Allowed per 3GPP(dB)
20	64-QAM	1 RB	0	1860	18700	23.46	24	0-1
				1880	18900	23.30	24	0-1
				1900	19100	23.79	24	0-1
			50	1860	18700	23.09	24	0-1
				1880	18900	22.99	24	0-1
				1900	19100	23.08	24	0-1
			99	1860	18700	23.04	24	0-1
				1880	18900	23.31	24	0-1
				1900	19100	23.33	24	0-1
		50 RB	0	1860	18700	22.01	23	0-2
				1880	18900	22.07	23	0-2
				1900	19100	22.29	23	0-2
			25	1860	18700	22.11	23	0-2
				1880	18900	22.01	23	0-2
				1900	19100	22.24	23	0-2
			50	1860	18700	21.98	23	0-2
				1880	18900	21.96	23	0-2
				1900	19100	22.30	23	0-2
			100RB	1860	18700	21.36	23	0-2
				1880	18900	21.43	23	0-2
				1900	19100	21.52	23	0-2

Unless otherwise stated the results shown in this test report refer only to the sample(s) tested and such sample(s) are retained for 90 days only.

除非另有說明，此報告結果僅對測試之樣品負責，同時此樣品僅保留90天。本報告未經本公司書面許可，不可部份複製。

This document is issued by the Company subject to its General Conditions of Service printed overleaf, available on request or accessible at www.sgs.com/terms_and_conditions.htm and for electronic format documents, subject to Terms and Conditions for Electronic Documents at www.sgs.com/terms_e-document.htm. Attention is drawn to the limitation of liability, indemnification and jurisdiction issues defined therein. Any holder of this document is advised that information contained hereon reflects the Company's findings at the time of its intervention only and within the limits of Client's instructions, if any. The Company's sole responsibility is to its Client and this document does not exonerate parties to a transaction from exercising all their rights and obligations under the transaction documents. This document cannot be reproduced except in full, without prior written approval of the Company. Any unauthorized alteration, forgery or falsification of the content or appearance of this document is unlawful and offenders may be prosecuted to the fullest extent of the law.

FDD Band 2									
BW(Mhz)	Modulation	RB Size	RB Offset	Frequency (MHz)	Channel	Conducted power (dBm)	Target Power + Max. Tolerance (dBm)	MPR Allowed per 3GPP(dB)	
15	QPSK	1 RB	0	1857.5	18675	23.93	25	0	
				1880	18900	23.90	25	0	
				1902.5	19125	24.06	25	0	
			36	1857.5	18675	23.65	25	0	
				1880	18900	24.01	25	0	
				1902.5	19125	24.17	25	0	
		74	1857.5	18675	23.96	25	0		
			1880	18900	23.76	25	0		
			1902.5	19125	24.36	25	0		
		36 RB	0	1857.5	18675	22.83	24	0-1	
				1880	18900	22.90	24	0-1	
				1902.5	19125	23.03	24	0-1	
			18	1857.5	18675	22.99	24	0-1	
				1880	18900	22.86	24	0-1	
				1902.5	19125	23.15	24	0-1	
		37	1857.5	18675	22.80	24	0-1		
			1880	18900	22.75	24	0-1		
			1902.5	19125	23.16	24	0-1		
		75RB	1857.5	18675	22.30	24	0-1		
			1880	18900	22.31	24	0-1		
			1902.5	19125	22.79	24	0-1		
		16-QAM	1 RB	0	1857.5	18675	23.22	24	0-1
					1880	18900	23.13	24	0-1
					1902.5	19125	23.75	24	0-1
	36			1857.5	18675	23.05	24	0-1	
				1880	18900	22.83	24	0-1	
				1902.5	19125	22.98	24	0-1	
	74			1857.5	18675	22.92	24	0-1	
				1880	18900	23.07	24	0-1	
				1902.5	19125	23.18	24	0-1	
	36 RB			0	1857.5	18675	21.96	23	0-2
					1880	18900	22.00	23	0-2
					1902.5	19125	22.10	23	0-2
			18	1857.5	18675	21.98	23	0-2	
				1880	18900	22.00	23	0-2	
				1902.5	19125	22.15	23	0-2	
	37		1857.5	18675	21.72	23	0-2		
			1880	18900	21.75	23	0-2		
			1902.5	19125	22.13	23	0-2		
	75RB		1857.5	18675	21.15	23	0-2		
			1880	18900	21.42	23	0-2		
			1902.5	19125	21.69	23	0-2		

Unless otherwise stated the results shown in this test report refer only to the sample(s) tested and such sample(s) are retained for 90 days only.

除非另有說明，此報告結果僅對測試之樣品負責，同時此樣品僅保留90天。本報告未經本公司書面許可，不可部份複製。

This document is issued by the Company subject to its General Conditions of Service printed overleaf, available on request or accessible at www.sgs.com/terms_and_conditions.htm and for electronic format documents, subject to Terms and Conditions for Electronic Documents at www.sgs.com/terms_e-document.htm. Attention is drawn to the limitation of liability, indemnification and jurisdiction issues defined therein. Any holder of this document is advised that information contained hereon reflects the Company's findings at the time of its intervention only and within the limits of Client's instructions, if any. The Company's sole responsibility is to its Client and this document does not exonerate parties to a transaction from exercising all their rights and obligations under the transaction documents. This document cannot be reproduced except in full, without prior written approval of the Company. Any unauthorized alteration, forgery or falsification of the content or appearance of this document is unlawful and offenders may be prosecuted to the fullest extent of the law.

FDD Band 2								
BW(Mhz)	Modulation	RB Size	RB Offset	Frequency (MHz)	Channel	Conducted power (dBm)	Target Power + Max. Tolerance (dBm)	MPR Allowed per 3GPP(dB)
15	64-QAM	1 RB	0	1857.5	18675	23.28	24	0-1
				1880	18900	23.24	24	0-1
				1902.5	19125	23.61	24	0-1
			36	1857.5	18675	22.80	24	0-1
				1880	18900	22.95	24	0-1
				1902.5	19125	22.94	24	0-1
			74	1857.5	18675	23.03	24	0-1
				1880	18900	23.26	24	0-1
				1902.5	19125	23.17	24	0-1
		36 RB	0	1857.5	18675	21.77	23	0-2
				1880	18900	21.88	23	0-2
				1902.5	19125	22.02	23	0-2
			18	1857.5	18675	21.99	23	0-2
				1880	18900	21.77	23	0-2
				1902.5	19125	22.13	23	0-2
			37	1857.5	18675	21.78	23	0-2
				1880	18900	21.72	23	0-2
				1902.5	19125	22.15	23	0-2
			75RB	1857.5	18675	21.13	23	0-2
				1880	18900	21.29	23	0-2
				1902.5	19125	21.51	23	0-2

Unless otherwise stated the results shown in this test report refer only to the sample(s) tested and such sample(s) are retained for 90 days only.

除非另有說明，此報告結果僅對測試之樣品負責，同時此樣品僅保留90天。本報告未經本公司書面許可，不可部份複製。

This document is issued by the Company subject to its General Conditions of Service printed overleaf, available on request or accessible at www.sgs.com/terms_and_conditions.htm and for electronic format documents, subject to Terms and Conditions for Electronic Documents at www.sgs.com/terms_e-document.htm. Attention is drawn to the limitation of liability, indemnification and jurisdiction issues defined therein. Any holder of this document is advised that information contained hereon reflects the Company's findings at the time of its intervention only and within the limits of Client's instructions, if any. The Company's sole responsibility is to its Client and this document does not exonerate parties to a transaction from exercising all their rights and obligations under the transaction documents. This document cannot be reproduced except in full, without prior written approval of the Company. Any unauthorized alteration, forgery or falsification of the content or appearance of this document is unlawful and offenders may be prosecuted to the fullest extent of the law.

FDD Band 2									
BW(Mhz)	Modulation	RB Size	RB Offset	Frequency (MHz)	Channel	Conducted power (dBm)	Target Power + Max. Tolerance (dBm)	MPR Allowed per 3GPP(dB)	
10	QPSK	1 RB	0	1855	18650	24.05	25	0	
				1880	18900	24.05	25	0	
				1905	19150	24.08	25	0	
			25	1855	18650	23.64	25	0	
				1880	18900	24.08	25	0	
				1905	19150	24.13	25	0	
		49	1855	18650	24.04	25	0		
			1880	18900	23.96	25	0		
			1905	19150	24.37	25	0		
		25 RB	0	1855	18650	22.83	24	0-1	
				1880	18900	22.87	24	0-1	
				1905	19150	23.19	24	0-1	
			12	1855	18650	22.75	24	0-1	
				1880	18900	22.73	24	0-1	
				1905	19150	23.05	24	0-1	
		25	1855	18650	22.89	24	0-1		
			1880	18900	22.88	24	0-1		
			1905	19150	23.03	24	0-1		
		50RB	1855	18650	22.26	24	0-1		
			1880	18900	22.34	24	0-1		
			1905	19150	22.71	24	0-1		
		16-QAM	1 RB	0	1855	18650	23.41	24	0-1
					1880	18900	23.04	24	0-1
					1905	19150	23.73	24	0-1
	25			1855	18650	23.06	24	0-1	
				1880	18900	22.89	24	0-1	
				1905	19150	22.92	24	0-1	
	49			1855	18650	23.00	24	0-1	
				1880	18900	23.28	24	0-1	
				1905	19150	23.34	24	0-1	
	25 RB			0	1855	18650	21.87	23	0-2
					1880	18900	22.05	23	0-2
					1905	19150	22.19	23	0-2
			12	1855	18650	21.94	23	0-2	
				1880	18900	21.86	23	0-2	
				1905	19150	22.05	23	0-2	
	25		1855	18650	21.76	23	0-2		
			1880	18900	21.75	23	0-2		
			1905	19150	22.32	23	0-2		
	50RB		1855	18650	21.37	23	0-2		
			1880	18900	21.41	23	0-2		
			1905	19150	21.52	23	0-2		

Unless otherwise stated the results shown in this test report refer only to the sample(s) tested and such sample(s) are retained for 90 days only.

除非另有說明，此報告結果僅對測試之樣品負責，同時此樣品僅保留90天。本報告未經本公司書面許可，不可部份複製。

This document is issued by the Company subject to its General Conditions of Service printed overleaf, available on request or accessible at www.sgs.com/terms_and_conditions.htm and for electronic format documents, subject to Terms and Conditions for Electronic Documents at www.sgs.com/terms_e-document.htm. Attention is drawn to the limitation of liability, indemnification and jurisdiction issues defined therein. Any holder of this document is advised that information contained hereon reflects the Company's findings at the time of its intervention only and within the limits of Client's instructions, if any. The Company's sole responsibility is to its Client and this document does not exonerate parties to a transaction from exercising all their rights and obligations under the transaction documents. This document cannot be reproduced except in full, without prior written approval of the Company. Any unauthorized alteration, forgery or falsification of the content or appearance of this document is unlawful and offenders may be prosecuted to the fullest extent of the law.

FDD Band 2								
BW(Mhz)	Modulation	RB Size	RB Offset	Frequency (MHz)	Channel	Conducted power (dBm)	Target Power + Max. Tolerance (dBm)	MPR Allowed per 3GPP(dB)
10	64-QAM	1 RB	0	1855	18650	23.28	24	0-1
				1880	18900	23.09	24	0-1
				1905	19150	23.60	24	0-1
			25	1855	18650	22.80	24	0-1
				1880	18900	22.76	24	0-1
				1905	19150	23.07	24	0-1
			49	1855	18650	22.86	24	0-1
				1880	18900	23.01	24	0-1
				1905	19150	23.06	24	0-1
		25 RB	0	1855	18650	22.00	23	0-2
				1880	18900	22.03	23	0-2
				1905	19150	22.00	23	0-2
			12	1855	18650	21.95	23	0-2
				1880	18900	21.88	23	0-2
				1905	19150	22.10	23	0-2
			25	1855	18650	21.80	23	0-2
				1880	18900	21.91	23	0-2
				1905	19150	22.17	23	0-2
			50RB	1855	18650	21.20	23	0-2
				1880	18900	21.30	23	0-2
				1905	19150	21.45	23	0-2

Unless otherwise stated the results shown in this test report refer only to the sample(s) tested and such sample(s) are retained for 90 days only.

除非另有說明，此報告結果僅對測試之樣品負責，同時此樣品僅保留90天。本報告未經本公司書面許可，不可部份複製。

This document is issued by the Company subject to its General Conditions of Service printed overleaf, available on request or accessible at www.sgs.com/terms_and_conditions.htm and for electronic format documents, subject to Terms and Conditions for Electronic Documents at www.sgs.com/terms_e-document.htm. Attention is drawn to the limitation of liability, indemnification and jurisdiction issues defined therein. Any holder of this document is advised that information contained hereon reflects the Company's findings at the time of its intervention only and within the limits of Client's instructions, if any. The Company's sole responsibility is to its Client and this document does not exonerate parties to a transaction from exercising all their rights and obligations under the transaction documents. This document cannot be reproduced except in full, without prior written approval of the Company. Any unauthorized alteration, forgery or falsification of the content or appearance of this document is unlawful and offenders may be prosecuted to the fullest extent of the law.

FDD Band 2									
BW(Mhz)	Modulation	RB Size	RB Offset	Frequency (MHz)	Channel	Conducted power (dBm)	Target Power + Max. Tolerance (dBm)	MPR Allowed per 3GPP(dB)	
5	QPSK	1 RB	0	1852.5	18625	23.99	25	0	
				1880	18900	23.96	25	0	
				1907.5	19175	23.99	25	0	
			12	1852.5	18625	23.73	25	0	
				1880	18900	24.08	25	0	
				1907.5	19175	24.03	25	0	
		24	1852.5	18625	23.85	25	0		
			1880	18900	23.91	25	0		
			1907.5	19175	24.10	25	0		
		12 RB	0	1852.5	18625	22.88	24	0-1	
				1880	18900	22.85	24	0-1	
				1907.5	19175	23.03	24	0-1	
			6	1852.5	18625	22.79	24	0-1	
				1880	18900	22.76	24	0-1	
				1907.5	19175	23.18	24	0-1	
		13	1852.5	18625	22.72	24	0-1		
			1880	18900	22.86	24	0-1		
			1907.5	19175	23.16	24	0-1		
		25RB	1852.5	18625	22.33	24	0-1		
			1880	18900	22.35	24	0-1		
			1907.5	19175	22.51	24	0-1		
		16-QAM	1 RB	0	1852.5	18625	23.38	24	0-1
					1880	18900	23.06	24	0-1
					1907.5	19175	23.56	24	0-1
	12			1852.5	18625	22.98	24	0-1	
				1880	18900	22.77	24	0-1	
				1907.5	19175	22.81	24	0-1	
	24			1852.5	18625	22.79	24	0-1	
				1880	18900	23.25	24	0-1	
				1907.5	19175	23.33	24	0-1	
	12 RB			0	1852.5	18625	21.85	23	0-2
					1880	18900	21.90	23	0-2
					1907.5	19175	22.26	23	0-2
			6	1852.5	18625	21.94	23	0-2	
				1880	18900	21.99	23	0-2	
				1907.5	19175	22.23	23	0-2	
	13		1852.5	18625	21.90	23	0-2		
			1880	18900	21.83	23	0-2		
			1907.5	19175	22.17	23	0-2		
	25RB		1852.5	18625	21.28	23	0-2		
			1880	18900	21.30	23	0-2		
			1907.5	19175	21.72	23	0-2		

Unless otherwise stated the results shown in this test report refer only to the sample(s) tested and such sample(s) are retained for 90 days only.

除非另有說明，此報告結果僅對測試之樣品負責，同時此樣品僅保留90天。本報告未經本公司書面許可，不可部份複製。

This document is issued by the Company subject to its General Conditions of Service printed overleaf, available on request or accessible at www.sgs.com/terms_and_conditions.htm and for electronic format documents, subject to Terms and Conditions for Electronic Documents at www.sgs.com/terms_e-document.htm. Attention is drawn to the limitation of liability, indemnification and jurisdiction issues defined therein. Any holder of this document is advised that information contained hereon reflects the Company's findings at the time of its intervention only and within the limits of Client's instructions, if any. The Company's sole responsibility is to its Client and this document does not exonerate parties to a transaction from exercising all their rights and obligations under the transaction documents. This document cannot be reproduced except in full, without prior written approval of the Company. Any unauthorized alteration, forgery or falsification of the content or appearance of this document is unlawful and offenders may be prosecuted to the fullest extent of the law.

FDD Band 2								
BW(Mhz)	Modulation	RB Size	RB Offset	Frequency (MHz)	Channel	Conducted power (dBm)	Target Power + Max. Tolerance (dBm)	MPR Allowed per 3GPP(dB)
5	64-QAM	1 RB	0	1852.5	18625	23.39	24	0-1
				1880	18900	23.00	24	0-1
				1907.5	19175	23.69	24	0-1
			12	1852.5	18625	22.92	24	0-1
				1880	18900	22.69	24	0-1
				1907.5	19175	23.03	24	0-1
			24	1852.5	18625	22.95	24	0-1
				1880	18900	23.13	24	0-1
				1907.5	19175	23.14	24	0-1
		12 RB	0	1852.5	18625	21.92	23	0-2
				1880	18900	21.77	23	0-2
				1907.5	19175	22.06	23	0-2
			6	1852.5	18625	21.85	23	0-2
				1880	18900	21.86	23	0-2
				1907.5	19175	22.00	23	0-2
			13	1852.5	18625	21.96	23	0-2
				1880	18900	21.89	23	0-2
				1907.5	19175	22.13	23	0-2
		25RB	1852.5	18625	21.29	23	0-2	
			1880	18900	21.13	23	0-2	
			1907.5	19175	21.47	23	0-2	

Unless otherwise stated the results shown in this test report refer only to the sample(s) tested and such sample(s) are retained for 90 days only.

除非另有說明，此報告結果僅對測試之樣品負責，同時此樣品僅保留90天。本報告未經本公司書面許可，不可部份複製。

This document is issued by the Company subject to its General Conditions of Service printed overleaf, available on request or accessible at www.sgs.com/terms_and_conditions.htm and for electronic format documents, subject to Terms and Conditions for Electronic Documents at www.sgs.com/terms_e-document.htm. Attention is drawn to the limitation of liability, indemnification and jurisdiction issues defined therein. Any holder of this document is advised that information contained hereon reflects the Company's findings at the time of its intervention only and within the limits of Client's instructions, if any. The Company's sole responsibility is to its Client and this document does not exonerate parties to a transaction from exercising all their rights and obligations under the transaction documents. This document cannot be reproduced except in full, without prior written approval of the Company. Any unauthorized alteration, forgery or falsification of the content or appearance of this document is unlawful and offenders may be prosecuted to the fullest extent of the law.

FDD Band 2									
BW(Mhz)	Modulation	RB Size	RB Offset	Frequency (MHz)	Channel	Conducted power (dBm)	Target Power + Max. Tolerance (dBm)	MPR Allowed per 3GPP(dB)	
3	QPSK	1 RB	0	1851.5	18615	24.05	25	0	
				1880	18900	23.83	25	0	
				1908.5	19185	24.05	25	0	
			7	1851.5	18615	23.69	25	0	
				1880	18900	23.98	25	0	
				1908.5	19185	24.03	25	0	
		14	1851.5	18615	23.86	25	0		
			1880	18900	23.85	25	0		
			1908.5	19185	24.11	25	0		
		8 RB	0	1851.5	18615	22.97	24	0-1	
				1880	18900	23.00	24	0-1	
				1908.5	19185	23.08	24	0-1	
			4	1851.5	18615	22.87	24	0-1	
				1880	18900	22.83	24	0-1	
				1908.5	19185	23.24	24	0-1	
			7	1851.5	18615	22.80	24	0-1	
				1880	18900	22.97	24	0-1	
				1908.5	19185	22.99	24	0-1	
		15RB	1851.5	18615	22.37	24	0-1		
			1880	18900	22.48	24	0-1		
			1908.5	19185	22.57	24	0-1		
		16-QAM	1 RB	0	1851.5	18615	23.20	24	0-1
					1880	18900	23.22	24	0-1
					1908.5	19185	23.55	24	0-1
	7			1851.5	18615	23.08	24	0-1	
				1880	18900	22.78	24	0-1	
				1908.5	19185	23.05	24	0-1	
	14			1851.5	18615	22.81	24	0-1	
				1880	18900	23.23	24	0-1	
				1908.5	19185	23.24	24	0-1	
	8 RB			0	1851.5	18615	21.87	23	0-2
					1880	18900	21.88	23	0-2
					1908.5	19185	22.09	23	0-2
			4	1851.5	18615	21.91	23	0-2	
				1880	18900	22.04	23	0-2	
				1908.5	19185	22.12	23	0-2	
			7	1851.5	18615	21.99	23	0-2	
				1880	18900	21.81	23	0-2	
				1908.5	19185	22.04	23	0-2	
	15RB		1851.5	18615	21.39	23	0-2		
			1880	18900	21.31	23	0-2		
			1908.5	19185	21.64	23	0-2		

Unless otherwise stated the results shown in this test report refer only to the sample(s) tested and such sample(s) are retained for 90 days only.

除非另有說明，此報告結果僅對測試之樣品負責，同時此樣品僅保留90天。本報告未經本公司書面許可，不可部份複製。

This document is issued by the Company subject to its General Conditions of Service printed overleaf, available on request or accessible at www.sgs.com/terms_and_conditions.htm and for electronic format documents, subject to Terms and Conditions for Electronic Documents at www.sgs.com/terms_e-document.htm. Attention is drawn to the limitation of liability, indemnification and jurisdiction issues defined therein. Any holder of this document is advised that information contained hereon reflects the Company's findings at the time of its intervention only and within the limits of Client's instructions, if any. The Company's sole responsibility is to its Client and this document does not exonerate parties to a transaction from exercising all their rights and obligations under the transaction documents. This document cannot be reproduced except in full, without prior written approval of the Company. Any unauthorized alteration, forgery or falsification of the content or appearance of this document is unlawful and offenders may be prosecuted to the fullest extent of the law.

FDD Band 2								
BW(Mhz)	Modulation	RB Size	RB Offset	Frequency (MHz)	Channel	Conducted power (dBm)	Target Power + Max. Tolerance (dBm)	MPR Allowed per 3GPP(dB)
3	64-QAM	1 RB	0	1851.5	18615	23.31	24	0-1
				1880	18900	23.18	24	0-1
				1908.5	19185	23.50	24	0-1
			7	1851.5	18615	23.01	24	0-1
				1880	18900	22.80	24	0-1
				1908.5	19185	22.88	24	0-1
			14	1851.5	18615	22.84	24	0-1
				1880	18900	23.12	24	0-1
				1908.5	19185	23.32	24	0-1
		8 RB	0	1851.5	18615	21.84	23	0-2
				1880	18900	21.84	23	0-2
				1908.5	19185	21.99	23	0-2
			4	1851.5	18615	22.10	23	0-2
				1880	18900	21.84	23	0-2
				1908.5	19185	22.23	23	0-2
			7	1851.5	18615	21.71	23	0-2
				1880	18900	21.94	23	0-2
				1908.5	19185	22.17	23	0-2
		15RB	1851.5	18615	21.11	23	0-2	
			1880	18900	21.23	23	0-2	
			1908.5	19185	21.29	23	0-2	

Unless otherwise stated the results shown in this test report refer only to the sample(s) tested and such sample(s) are retained for 90 days only.

除非另有說明，此報告結果僅對測試之樣品負責，同時此樣品僅保留90天。本報告未經本公司書面許可，不可部份複製。

This document is issued by the Company subject to its General Conditions of Service printed overleaf, available on request or accessible at www.sgs.com/terms_and_conditions.htm and for electronic format documents, subject to Terms and Conditions for Electronic Documents at www.sgs.com/terms_e-document.htm. Attention is drawn to the limitation of liability, indemnification and jurisdiction issues defined therein. Any holder of this document is advised that information contained hereon reflects the Company's findings at the time of its intervention only and within the limits of Client's instructions, if any. The Company's sole responsibility is to its Client and this document does not exonerate parties to a transaction from exercising all their rights and obligations under the transaction documents. This document cannot be reproduced except in full, without prior written approval of the Company. Any unauthorized alteration, forgery or falsification of the content or appearance of this document is unlawful and offenders may be prosecuted to the fullest extent of the law.

FDD Band 2									
BW(Mhz)	Modulation	RB Size	RB Offset	Frequency (MHz)	Channel	Conducted power (dBm)	Target Power + Max. Tolerance (dBm)	MPR Allowed per 3GPP(dB)	
1.4	QPSK	1 RB	0	1850.7	18607	24.05	25	0	
				1880	18900	24.09	25	0	
				1909.3	19193	24.11	25	0	
			2	1850.7	18607	23.80	25	0	
				1880	18900	23.95	25	0	
				1909.3	19193	24.14	25	0	
		5	1850.7	18607	23.84	25	0		
			1880	18900	23.86	25	0		
			1909.3	19193	24.31	25	0		
		3 RB	0	1850.7	18607	22.90	24	0-1	
				1880	18900	23.07	24	0-1	
				1909.3	19193	23.01	24	0-1	
			2	1850.7	18607	22.82	24	0-1	
				1880	18900	22.97	24	0-1	
				1909.3	19193	23.05	24	0-1	
			3	1850.7	18607	22.91	24	0-1	
				1880	18900	22.74	24	0-1	
				1909.3	19193	23.01	24	0-1	
		6RB	1850.7	18607	22.20	24	0-1		
			1880	18900	22.32	24	0-1		
			1909.3	19193	22.71	24	0-1		
		16-QAM	1 RB	0	1850.7	18607	23.44	24	0-1
					1880	18900	23.28	24	0-1
					1909.3	19193	23.75	24	0-1
	2			1850.7	18607	23.08	24	0-1	
				1880	18900	22.82	24	0-1	
				1909.3	19193	23.07	24	0-1	
	5			1850.7	18607	23.06	24	0-1	
				1880	18900	23.16	24	0-1	
				1909.3	19193	23.12	24	0-1	
	3 RB			0	1850.7	18607	21.98	23	0-2
					1880	18900	22.05	23	0-2
					1909.3	19193	22.29	23	0-2
			2	1850.7	18607	22.12	23	0-2	
				1880	18900	21.88	23	0-2	
				1909.3	19193	22.23	23.0	0-2	
			3	1850.7	18607	21.98	23	0-2	
				1880	18900	21.84	23	0-2	
				1909.3	19193	22.22	23	0-2	
	6RB		1850.7	18607	21.13	23	0-2		
			1880	18900	21.38	23	0-2		
			1909.3	19193	21.59	23	0-2		

Unless otherwise stated the results shown in this test report refer only to the sample(s) tested and such sample(s) are retained for 90 days only.

除非另有說明，此報告結果僅對測試之樣品負責，同時此樣品僅保留90天。本報告未經本公司書面許可，不可部份複製。

This document is issued by the Company subject to its General Conditions of Service printed overleaf, available on request or accessible at www.sgs.com/terms_and_conditions.htm and for electronic format documents, subject to Terms and Conditions for Electronic Documents at www.sgs.com/terms_e-document.htm. Attention is drawn to the limitation of liability, indemnification and jurisdiction issues defined therein. Any holder of this document is advised that information contained hereon reflects the Company's findings at the time of its intervention only and within the limits of Client's instructions, if any. The Company's sole responsibility is to its Client and this document does not exonerate parties to a transaction from exercising all their rights and obligations under the transaction documents. This document cannot be reproduced except in full, without prior written approval of the Company. Any unauthorized alteration, forgery or falsification of the content or appearance of this document is unlawful and offenders may be prosecuted to the fullest extent of the law.

FDD Band 2								
BW(Mhz)	Modulation	RB Size	RB Offset	Frequency (MHz)	Channel	Conducted power (dBm)	Target Power + Max. Tolerance (dBm)	MPR Allowed per 3GPP(dB)
1.4	64-QAM	1 RB	0	1850.7	18607	23.16	24	0-1
				1880	18900	23.07	24	0-1
				1909.3	19193	23.63	24	0-1
			2	1850.7	18607	22.91	24	0-1
				1880	18900	22.88	24	0-1
				1909.3	19193	22.96	24	0-1
			5	1850.7	18607	23.01	24	0-1
				1880	18900	23.28	24	0-1
				1909.3	19193	23.06	24	0-1
		3 RB	0	1850.7	18607	21.91	23	0-2
				1880	18900	21.90	23	0-2
				1909.3	19193	22.25	23	0-2
			2	1850.7	18607	21.91	23	0-2
				1880	18900	21.75	23	0-2
				1909.3	19193	22.22	23	0-2
			3	1850.7	18607	21.68	23	0-2
				1880	18900	21.67	23	0-2
				1909.3	19193	22.18	23	0-2
			6RB	1850.7	18607	21.25	23	0-2
				1880	18900	21.28	23	0-2
				1909.3	19193	21.27	23	0-2

Unless otherwise stated the results shown in this test report refer only to the sample(s) tested and such sample(s) are retained for 90 days only.

除非另有說明，此報告結果僅對測試之樣品負責，同時此樣品僅保留90天。本報告未經本公司書面許可，不可部份複製。

This document is issued by the Company subject to its General Conditions of Service printed overleaf, available on request or accessible at www.sgs.com/terms_and_conditions.htm and for electronic format documents, subject to Terms and Conditions for Electronic Documents at www.sgs.com/terms_e-document.htm. Attention is drawn to the limitation of liability, indemnification and jurisdiction issues defined therein. Any holder of this document is advised that information contained hereon reflects the Company's findings at the time of its intervention only and within the limits of Client's instructions, if any. The Company's sole responsibility is to its Client and this document does not exonerate parties to a transaction from exercising all their rights and obligations under the transaction documents. This document cannot be reproduced except in full, without prior written approval of the Company. Any unauthorized alteration, forgery or falsification of the content or appearance of this document is unlawful and offenders may be prosecuted to the fullest extent of the law.

FDD Band 4									
BW(Mhz)	Modulation	RB Size	RB Offset	Frequency (MHz)	Channel	Conducted power (dBm)	Target Power + Max. Tolerance (dBm)	MPR Allowed per 3GPP(dB)	
20	QPSK	1 RB	0	1720	20050	23.90	24.5	0	
				1732.5	20175	23.95	24.5	0	
				1745	20300	23.99	24.5	0	
			50	1720	20050	23.94	24.5	0	
				1732.5	20175	23.87	24.5	0	
				1745	20300	23.29	24.5	0	
			99	1720	20050	23.96	24.5	0	
				1732.5	20175	23.65	24.5	0	
				1745	20300	23.90	24.5	0	
		50 RB	0	1720	20050	23.10	23.5	0-1	
				1732.5	20175	23.27	23.5	0-1	
				1745	20300	23.17	23.5	0-1	
			25	1720	20050	23.06	23.5	0-1	
				1732.5	20175	23.12	23.5	0-1	
				1745	20300	22.53	23.5	0-1	
			50	1720	20050	23.09	23.5	0-1	
				1732.5	20175	22.99	23.5	0-1	
				1745	20300	22.73	23.5	0-1	
		100RB	1720	20050	22.63	23.5	0-1		
			1732.5	20175	22.64	23.5	0-1		
			1745	20300	22.58	23.5	0-1		
		16-QAM	1 RB	0	1720	20050	22.28	23.5	0-1
					1732.5	20175	23.48	23.5	0-1
					1745	20300	23.28	23.5	0-1
	50			1720	20050	23.24	23.5	0-1	
				1732.5	20175	22.87	23.5	0-1	
				1745	20300	22.98	23.5	0-1	
	99			1720	20050	23.41	23.5	0-1	
				1732.5	20175	22.95	23.5	0-1	
				1745	20300	23.10	23.5	0-1	
	50 RB			0	1720	20050	22.23	22.5	0-2
					1732.5	20175	22.23	22.5	0-2
					1745	20300	22.09	22.5	0-2
			25	1720	20050	22.26	22.5	0-2	
				1732.5	20175	22.13	22.5	0-2	
				1745	20300	21.59	22.5	0-2	
			50	1720	20050	22.17	22.5	0-2	
				1732.5	20175	22.03	22.5	0-2	
				1745	20300	21.69	22.5	0-2	
	100RB		1720	20050	21.58	22.5	0-2		
			1732.5	20175	21.57	22.5	0-2		
			1745	20300	21.54	22.5	0-2		

Unless otherwise stated the results shown in this test report refer only to the sample(s) tested and such sample(s) are retained for 90 days only.

除非另有說明，此報告結果僅對測試之樣品負責，同時此樣品僅保留90天。本報告未經本公司書面許可，不可部份複製。

This document is issued by the Company subject to its General Conditions of Service printed overleaf, available on request or accessible at www.sgs.com/terms_and_conditions.htm and for electronic format documents, subject to Terms and Conditions for Electronic Documents at www.sgs.com/terms_e-document.htm. Attention is drawn to the limitation of liability, indemnification and jurisdiction issues defined therein. Any holder of this document is advised that information contained hereon reflects the Company's findings at the time of its intervention only and within the limits of Client's instructions, if any. The Company's sole responsibility is to its Client and this document does not exonerate parties to a transaction from exercising all their rights and obligations under the transaction documents. This document cannot be reproduced except in full, without prior written approval of the Company. Any unauthorized alteration, forgery or falsification of the content or appearance of this document is unlawful and offenders may be prosecuted to the fullest extent of the law.

FDD Band 4								
BW(Mhz)	Modulation	RB Size	RB Offset	Frequency (MHz)	Channel	Conducted power (dBm)	Target Power + Max. Tolerance (dBm)	MPR Allowed per 3GPP(dB)
20	64-QAM	1 RB	0	1720	20050	22.17	23.5	0-1
				1732.5	20175	23.37	23.5	0-1
				1745	20300	23.17	23.5	0-1
			50	1720	20050	23.13	23.5	0-1
				1732.5	20175	22.76	23.5	0-1
				1745	20300	22.87	23.5	0-1
			99	1720	20050	23.30	23.5	0-1
				1732.5	20175	22.84	23.5	0-1
				1745	20300	22.99	23.5	0-1
		50 RB	0	1720	20050	22.12	22.5	0-2
				1732.5	20175	22.12	22.5	0-2
				1745	20300	21.98	22.5	0-2
			25	1720	20050	22.15	22.5	0-2
				1732.5	20175	22.02	22.5	0-2
				1745	20300	21.48	22.5	0-2
			50	1720	20050	22.06	22.5	0-2
				1732.5	20175	21.92	22.5	0-2
				1745	20300	21.58	22.5	0-2
		100RB	1720	20050	21.47	22.5	0-2	
			1732.5	20175	21.46	22.5	0-2	
			1745	20300	21.43	22.5	0-2	

Unless otherwise stated the results shown in this test report refer only to the sample(s) tested and such sample(s) are retained for 90 days only.

除非另有說明，此報告結果僅對測試之樣品負責，同時此樣品僅保留90天。本報告未經本公司書面許可，不可部份複製。

This document is issued by the Company subject to its General Conditions of Service printed overleaf, available on request or accessible at www.sgs.com/terms_and_conditions.htm and for electronic format documents, subject to Terms and Conditions for Electronic Documents at www.sgs.com/terms_e-document.htm. Attention is drawn to the limitation of liability, indemnification and jurisdiction issues defined therein. Any holder of this document is advised that information contained hereon reflects the Company's findings at the time of its intervention only and within the limits of Client's instructions, if any. The Company's sole responsibility is to its Client and this document does not exonerate parties to a transaction from exercising all their rights and obligations under the transaction documents. This document cannot be reproduced except in full, without prior written approval of the Company. Any unauthorized alteration, forgery or falsification of the content or appearance of this document is unlawful and offenders may be prosecuted to the fullest extent of the law.

FDD Band 4									
BW(Mhz)	Modulation	RB Size	RB Offset	Frequency (MHz)	Channel	Conducted power (dBm)	Target Power + Max. Tolerance (dBm)	MPR Allowed per 3GPP(dB)	
15	QPSK	1 RB	0	1717.5	20025	23.95	24.5	0	
				1732.5	20175	23.95	24.5	0	
				1747.5	20325	23.89	24.5	0	
			36	1717.5	20025	23.87	24.5	0	
				1732.5	20175	23.57	24.5	0	
				1747.5	20325	22.99	24.5	0	
		74	1717.5	20025	23.95	24.5	0		
			1732.5	20175	23.62	24.5	0		
			1747.5	20325	23.67	24.5	0		
		36 RB	0	1717.5	20025	22.90	23.5	0-1	
				1732.5	20175	23.19	23.5	0-1	
				1747.5	20325	23.05	23.5	0-1	
			18	1717.5	20025	22.84	23.5	0-1	
				1732.5	20175	22.98	23.5	0-1	
				1747.5	20325	22.37	23.5	0-1	
			37	1717.5	20025	22.94	23.5	0-1	
				1732.5	20175	22.86	23.5	0-1	
				1747.5	20325	22.60	23.5	0-1	
			75RB	1717.5	20025	22.54	23.5	0-1	
				1732.5	20175	22.47	23.5	0-1	
				1747.5	20325	22.40	23.5	0-1	
		16-QAM	1 RB	0	1717.5	20025	22.17	23.5	0-1
					1732.5	20175	23.22	23.5	0-1
					1747.5	20325	23.02	23.5	0-1
	36			1717.5	20025	23.16	23.5	0-1	
				1732.5	20175	22.64	23.5	0-1	
				1747.5	20325	22.82	23.5	0-1	
	74			1717.5	20025	23.37	23.5	0-1	
				1732.5	20175	22.82	23.5	0-1	
				1747.5	20325	23.00	23.5	0-1	
	36 RB			0	1717.5	20025	21.96	22.5	0-2
					1732.5	20175	21.96	22.5	0-2
					1747.5	20325	21.86	22.5	0-2
			18	1717.5	20025	22.21	22.5	0-2	
				1732.5	20175	21.99	22.5	0-2	
				1747.5	20325	21.43	22.5	0-2	
			37	1717.5	20025	22.15	22.5	0-2	
				1732.5	20175	21.96	22.5	0-2	
				1747.5	20325	21.40	22.5	0-2	
	75RB		1717.5	20025	21.52	22.5	0-2		
			1732.5	20175	21.37	22.5	0-2		
			1747.5	20325	21.41	22.5	0-2		

Unless otherwise stated the results shown in this test report refer only to the sample(s) tested and such sample(s) are retained for 90 days only.

除非另有說明，此報告結果僅對測試之樣品負責，同時此樣品僅保留90天。本報告未經本公司書面許可，不可部份複製。

This document is issued by the Company subject to its General Conditions of Service printed overleaf, available on request or accessible at www.sgs.com/terms_and_conditions.htm and for electronic format documents, subject to Terms and Conditions for Electronic Documents at www.sgs.com/terms_e-document.htm. Attention is drawn to the limitation of liability, indemnification and jurisdiction issues defined therein. Any holder of this document is advised that information contained hereon reflects the Company's findings at the time of its intervention only and within the limits of Client's instructions, if any. The Company's sole responsibility is to its Client and this document does not exonerate parties to a transaction from exercising all their rights and obligations under the transaction documents. This document cannot be reproduced except in full, without prior written approval of the Company. Any unauthorized alteration, forgery or falsification of the content or appearance of this document is unlawful and offenders may be prosecuted to the fullest extent of the law.

FDD Band 4									
BW(Mhz)	Modulation	RB Size	RB Offset	Frequency (MHz)	Channel	Conducted power (dBm)	Target Power + Max. Tolerance (dBm)	MPR Allowed per 3GPP(dB)	
15	64-QAM	1 RB	0	1717.5	20025	21.89	23.5	0-1	
				1732.5	20175	23.28	23.5	0-1	
				1747.5	20325	23.17	23.5	0-1	
			36	1717.5	20025	23.08	23.5	0-1	
					1732.5	20175	22.48	23.5	0-1
					1747.5	20325	22.60	23.5	0-1
				74	1717.5	20025	23.20	23.5	0-1
					1732.5	20175	22.61	23.5	0-1
					1747.5	20325	22.96	23.5	0-1
		36 RB	0	1717.5	20025	21.96	22.5	0-2	
				1732.5	20175	21.82	22.5	0-2	
				1747.5	20325	21.86	22.5	0-2	
				18	1717.5	20025	22.00	22.5	0-2
					1732.5	20175	21.78	22.5	0-2
					1747.5	20325	21.42	22.5	0-2
			37	1717.5	20025	21.93	22.5	0-2	
				1732.5	20175	21.66	22.5	0-2	
				1747.5	20325	21.50	22.5	0-2	
			75RB	1717.5	20025	21.18	22.5	0-2	
				1732.5	20175	21.35	22.5	0-2	
				1747.5	20325	21.38	22.5	0-2	

Unless otherwise stated the results shown in this test report refer only to the sample(s) tested and such sample(s) are retained for 90 days only.

除非另有說明，此報告結果僅對測試之樣品負責，同時此樣品僅保留90天。本報告未經本公司書面許可，不可部份複製。

This document is issued by the Company subject to its General Conditions of Service printed overleaf, available on request or accessible at www.sgs.com/terms_and_conditions.htm and for electronic format documents, subject to Terms and Conditions for Electronic Documents at www.sgs.com/terms_e-document.htm. Attention is drawn to the limitation of liability, indemnification and jurisdiction issues defined therein. Any holder of this document is advised that information contained hereon reflects the Company's findings at the time of its intervention only and within the limits of Client's instructions, if any. The Company's sole responsibility is to its Client and this document does not exonerate parties to a transaction from exercising all their rights and obligations under the transaction documents. This document cannot be reproduced except in full, without prior written approval of the Company. Any unauthorized alteration, forgery or falsification of the content or appearance of this document is unlawful and offenders may be prosecuted to the fullest extent of the law.

FDD Band 4									
BW(Mhz)	Modulation	RB Size	RB Offset	Frequency (MHz)	Channel	Conducted power (dBm)	Target Power + Max. Tolerance (dBm)	MPR Allowed per 3GPP(dB)	
10	QPSK	1 RB	0	1715	20000	23.91	24.5	0	
				1732.5	20175	23.96	24.5	0	
				1750	20350	23.91	24.5	0	
			25	1715	20000	23.69	24.5	0	
				1732.5	20175	23.77	24.5	0	
				1750	20350	23.24	24.5	0	
		49	1715	20000	23.88	24.5	0		
			1732.5	20175	23.40	24.5	0		
			1750	20350	23.86	24.5	0		
		25 RB	0	1715	20000	22.81	23.5	0-1	
				1732.5	20175	23.09	23.5	0-1	
				1750	20350	22.94	23.5	0-1	
			12	1715	20000	22.93	23.5	0-1	
				1732.5	20175	23.03	23.5	0-1	
				1750	20350	22.36	23.5	0-1	
		25	1715	20000	22.90	23.5	0-1		
			1732.5	20175	22.89	23.5	0-1		
			1750	20350	22.60	23.5	0-1		
		50RB	1715	20000	22.37	23.5	0-1		
			1732.5	20175	22.59	23.5	0-1		
			1750	20350	22.28	23.5	0-1		
		16-QAM	1 RB	0	1715	20000	22.15	23.5	0-1
					1732.5	20175	23.42	23.5	0-1
					1750	20350	23.18	23.5	0-1
	25			1715	20000	23.23	23.5	0-1	
				1732.5	20175	22.57	23.5	0-1	
				1750	20350	22.77	23.5	0-1	
	49		1715	20000	23.41	23.5	0-1		
			1732.5	20175	22.71	23.5	0-1		
			1750	20350	23.05	23.5	0-1		
	25 RB		0	1715	20000	22.11	22.5	0-2	
				1732.5	20175	22.13	22.5	0-2	
				1750	20350	21.86	22.5	0-2	
			12	1715	20000	22.04	22.5	0-2	
				1732.5	20175	22.11	22.5	0-2	
				1750	20350	21.36	22.5	0-2	
	25		1715	20000	21.91	22.5	0-2		
			1732.5	20175	21.95	22.5	0-2		
			1750	20350	21.54	22.5	0-2		
	50RB		1715	20000	21.46	22.5	0-2		
			1732.5	20175	21.43	22.5	0-2		
			1750	20350	21.54	22.5	0-2		

Unless otherwise stated the results shown in this test report refer only to the sample(s) tested and such sample(s) are retained for 90 days only.

除非另有說明，此報告結果僅對測試之樣品負責，同時此樣品僅保留90天。本報告未經本公司書面許可，不可部份複製。

This document is issued by the Company subject to its General Conditions of Service printed overleaf, available on request or accessible at www.sgs.com/terms_and_conditions.htm and for electronic format documents, subject to Terms and Conditions for Electronic Documents at www.sgs.com/terms_e-document.htm. Attention is drawn to the limitation of liability, indemnification and jurisdiction issues defined therein. Any holder of this document is advised that information contained hereon reflects the Company's findings at the time of its intervention only and within the limits of Client's instructions, if any. The Company's sole responsibility is to its Client and this document does not exonerate parties to a transaction from exercising all their rights and obligations under the transaction documents. This document cannot be reproduced except in full, without prior written approval of the Company. Any unauthorized alteration, forgery or falsification of the content or appearance of this document is unlawful and offenders may be prosecuted to the fullest extent of the law.

FDD Band 4								
BW(Mhz)	Modulation	RB Size	RB Offset	Frequency (MHz)	Channel	Conducted power (dBm)	Target Power + Max. Tolerance (dBm)	MPR Allowed per 3GPP(dB)
10	64-QAM	1 RB	0	1715	20000	22.00	23.5	0-1
				1732.5	20175	23.20	23.5	0-1
				1750	20350	23.09	23.5	0-1
			25	1715	20000	22.86	23.5	0-1
				1732.5	20175	22.52	23.5	0-1
				1750	20350	22.82	23.5	0-1
			49	1715	20000	23.14	23.5	0-1
				1732.5	20175	22.76	23.5	0-1
				1750	20350	22.72	23.5	0-1
		25 RB	0	1715	20000	21.98	22.5	0-2
				1732.5	20175	21.87	22.5	0-2
				1750	20350	21.69	22.5	0-2
			12	1715	20000	21.98	22.5	0-2
				1732.5	20175	22.01	22.5	0-2
				1750	20350	21.37	22.5	0-2
			25	1715	20000	21.80	22.5	0-2
				1732.5	20175	21.83	22.5	0-2
				1750	20350	21.57	22.5	0-2
		50RB	1715	20000	21.41	22.5	0-2	
			1732.5	20175	21.16	22.5	0-2	
			1750	20350	21.27	22.5	0-2	

Unless otherwise stated the results shown in this test report refer only to the sample(s) tested and such sample(s) are retained for 90 days only.

除非另有說明，此報告結果僅對測試之樣品負責，同時此樣品僅保留90天。本報告未經本公司書面許可，不可部份複製。

This document is issued by the Company subject to its General Conditions of Service printed overleaf, available on request or accessible at www.sgs.com/terms_and_conditions.htm and for electronic format documents, subject to Terms and Conditions for Electronic Documents at www.sgs.com/terms_e-document.htm. Attention is drawn to the limitation of liability, indemnification and jurisdiction issues defined therein. Any holder of this document is advised that information contained hereon reflects the Company's findings at the time of its intervention only and within the limits of Client's instructions, if any. The Company's sole responsibility is to its Client and this document does not exonerate parties to a transaction from exercising all their rights and obligations under the transaction documents. This document cannot be reproduced except in full, without prior written approval of the Company. Any unauthorized alteration, forgery or falsification of the content or appearance of this document is unlawful and offenders may be prosecuted to the fullest extent of the law.

FDD Band 4											
BW(Mhz)	Modulation	RB Size	RB Offset	Frequency (MHz)	Channel	Conducted power (dBm)	Target Power + Max. Tolerance (dBm)	MPR Allowed per 3GPP(dB)			
5	QPSK	1 RB	0	1712.5	19975	23.85	24.5	0			
				1732.5	20175	23.95	24.5	0			
				1752.5	20375	23.94	24.5	0			
			12	1712.5	19975	23.74	24.5	0			
				1732.5	20175	23.62	24.5	0			
				1752.5	20375	23.15	24.5	0			
		24	1712.5	19975	23.89	24.5	0				
			1732.5	20175	23.38	24.5	0				
			1752.5	20375	23.84	24.5	0				
		12 RB	0	1712.5	19975	23.08	19975	23.08	23.5	0-1	
				1732.5	20175	23.08	20175	23.08	23.5	0-1	
				1752.5	20375	22.90	20375	22.90	23.5	0-1	
			6	1712.5	19975	22.89	19975	22.89	23.5	0-1	
				1732.5	20175	23.04	20175	23.04	23.5	0-1	
				1752.5	20375	22.43	20375	22.43	23.5	0-1	
			13	1712.5	19975	22.98	19975	22.98	23.5	0-1	
				1732.5	20175	22.78	20175	22.78	23.5	0-1	
				1752.5	20375	22.48	20375	22.48	23.5	0-1	
		25RB	1712.5	19975	22.38	19975	22.38	23.5	0-1		
			1732.5	20175	22.62	20175	22.62	23.5	0-1		
			1752.5	20375	22.35	20375	22.35	23.5	0-1		
		16-QAM	1 RB	0	1712.5	19975	22.05	19975	23.5	0-1	
					1732.5	20175	23.31	20175	23.5	0-1	
					1752.5	20375	23.07	20375	23.5	0-1	
	12			1712.5	19975	23.11	19975	23.11	23.5	0-1	
				1732.5	20175	22.78	20175	22.78	23.5	0-1	
				1752.5	20375	22.73	20375	22.73	23.5	0-1	
	24			1712.5	19975	23.21	19975	23.21	23.5	0-1	
				1732.5	20175	22.68	20175	22.68	23.5	0-1	
				1752.5	20375	22.82	20375	22.82	23.5	0-1	
	12 RB			0	1712.5	19975	21.95	19975	21.95	22.5	0-2
					1732.5	20175	21.94	20175	21.94	22.5	0-2
					1752.5	20375	21.86	20375	21.86	22.5	0-2
			6	1712.5	19975	22.18	19975	22.18	22.5	0-2	
				1732.5	20175	21.91	20175	21.91	22.5	0-2	
				1752.5	20375	21.39	20375	21.39	22.5	0-2	
			13	1712.5	19975	21.93	19975	21.93	22.5	0-2	
				1732.5	20175	21.97	20175	21.97	22.5	0-2	
				1752.5	20375	21.49	20375	21.49	22.5	0-2	
	25RB		1712.5	19975	21.29	19975	21.29	22.5	0-2		
			1732.5	20175	21.42	20175	21.42	22.5	0-2		
			1752.5	20375	21.27	20375	21.27	22.5	0-2		

Unless otherwise stated the results shown in this test report refer only to the sample(s) tested and such sample(s) are retained for 90 days only.

除非另有說明，此報告結果僅對測試之樣品負責，同時此樣品僅保留90天。本報告未經本公司書面許可，不可部份複製。

This document is issued by the Company subject to its General Conditions of Service printed overleaf, available on request or accessible at www.sgs.com/terms_and_conditions.htm and for electronic format documents, subject to Terms and Conditions for Electronic Documents at www.sgs.com/terms_e-document.htm. Attention is drawn to the limitation of liability, indemnification and jurisdiction issues defined therein. Any holder of this document is advised that information contained hereon reflects the Company's findings at the time of its intervention only and within the limits of Client's instructions, if any. The Company's sole responsibility is to its Client and this document does not exonerate parties to a transaction from exercising all their rights and obligations under the transaction documents. This document cannot be reproduced except in full, without prior written approval of the Company. Any unauthorized alteration, forgery or falsification of the content or appearance of this document is unlawful and offenders may be prosecuted to the fullest extent of the law.

FDD Band 4								
BW(Mhz)	Modulation	RB Size	RB Offset	Frequency (MHz)	Channel	Conducted power (dBm)	Target Power + Max. Tolerance (dBm)	MPR Allowed per 3GPP(dB)
5	64-QAM	1 RB	0	1712.5	19975	21.98	23.5	0-1
				1732.5	20175	23.29	23.5	0-1
				1752.5	20375	23.04	23.5	0-1
			12	1712.5	19975	22.87	23.5	0-1
				1732.5	20175	22.59	23.5	0-1
				1752.5	20375	22.61	23.5	0-1
			24	1712.5	19975	23.09	23.5	0-1
				1732.5	20175	22.71	23.5	0-1
				1752.5	20375	22.71	23.5	0-1
		12 RB	0	1712.5	19975	21.94	22.5	0-2
				1732.5	20175	21.91	22.5	0-2
				1752.5	20375	21.74	22.5	0-2
			6	1712.5	19975	22.11	22.5	0-2
				1732.5	20175	21.83	22.5	0-2
				1752.5	20375	21.27	22.5	0-2
			13	1712.5	19975	21.77	22.5	0-2
				1732.5	20175	21.91	22.5	0-2
				1752.5	20375	21.33	22.5	0-2
		25RB	1712.5	19975	21.44	22.5	0-2	
			1732.5	20175	21.22	22.5	0-2	
			1752.5	20375	21.19	22.5	0-2	

Unless otherwise stated the results shown in this test report refer only to the sample(s) tested and such sample(s) are retained for 90 days only.

除非另有說明，此報告結果僅對測試之樣品負責，同時此樣品僅保留90天。本報告未經本公司書面許可，不可部份複製。

This document is issued by the Company subject to its General Conditions of Service printed overleaf, available on request or accessible at www.sgs.com/terms_and_conditions.htm and for electronic format documents, subject to Terms and Conditions for Electronic Documents at www.sgs.com/terms_e-document.htm. Attention is drawn to the limitation of liability, indemnification and jurisdiction issues defined therein. Any holder of this document is advised that information contained hereon reflects the Company's findings at the time of its intervention only and within the limits of Client's instructions, if any. The Company's sole responsibility is to its Client and this document does not exonerate parties to a transaction from exercising all their rights and obligations under the transaction documents. This document cannot be reproduced except in full, without prior written approval of the Company. Any unauthorized alteration, forgery or falsification of the content or appearance of this document is unlawful and offenders may be prosecuted to the fullest extent of the law.

FDD Band 4										
BW(Mhz)	Modulation	RB Size	RB Offset	Frequency (MHz)	Channel	Conducted power (dBm)	Target Power + Max. Tolerance (dBm)	MPR Allowed per 3GPP(dB)		
3	QPSK	1 RB	0	1711.5	19965	23.96	24.5	0		
				1732.5	20175	23.95	24.5	0		
				1753.5	20385	23.91	24.5	0		
			7	1711.5	19965	23.75	24.5	0		
				1732.5	20175	23.83	24.5	0		
				1753.5	20385	23.03	24.5	0		
		14	1711.5	19965	23.87	24.5	0			
			1732.5	20175	23.57	24.5	0			
			1753.5	20385	23.77	24.5	0			
		8 RB	0	1711.5	19965	22.94	19965	22.94	23.5	0-1
				1732.5	20175	23.24	20175	23.24	23.5	0-1
				1753.5	20385	23.14	20385	23.14	23.5	0-1
			4	1711.5	19965	22.83	19965	22.83	23.5	0-1
				1732.5	20175	23.00	20175	23.00	23.5	0-1
				1753.5	20385	22.35	20385	22.35	23.5	0-1
			7	1711.5	19965	22.95	19965	22.95	23.5	0-1
				1732.5	20175	22.87	20175	22.87	23.5	0-1
				1753.5	20385	22.56	20385	22.56	23.5	0-1
	15RB	1711.5	19965	22.55	19965	22.55	23.5	0-1		
		1732.5	20175	22.58	20175	22.58	23.5	0-1		
		1753.5	20385	22.57	20385	22.57	23.5	0-1		
	16-QAM	1 RB	0	1711.5	19965	21.98	19965	21.98	23.5	0-1
				1732.5	20175	23.37	20175	23.37	23.5	0-1
				1753.5	20385	23.27	20385	23.27	23.5	0-1
			7	1711.5	19965	23.16	19965	23.16	23.5	0-1
				1732.5	20175	22.67	20175	22.67	23.5	0-1
				1753.5	20385	22.76	20385	22.76	23.5	0-1
			14	1711.5	19965	23.34	19965	23.34	23.5	0-1
				1732.5	20175	22.66	20175	22.66	23.5	0-1
				1753.5	20385	22.90	20385	22.90	23.5	0-1
		8 RB	0	1711.5	19965	22.16	19965	22.16	22.5	0-2
				1732.5	20175	22.10	20175	22.10	22.5	0-2
				1753.5	20385	21.84	20385	21.84	22.5	0-2
			4	1711.5	19965	22.13	19965	22.13	22.5	0-2
				1732.5	20175	21.95	20175	21.95	22.5	0-2
				1753.5	20385	21.36	20385	21.36	22.5	0-2
7			1711.5	19965	22.07	19965	22.07	22.5	0-2	
			1732.5	20175	21.75	20175	21.75	22.5	0-2	
			1753.5	20385	21.67	20385	21.67	22.5	0-2	
15RB	1711.5	19965	21.51	19965	21.51	22.5	0-2			
	1732.5	20175	21.31	20175	21.31	22.5	0-2			
	1753.5	20385	21.36	20385	21.36	22.5	0-2			

Unless otherwise stated the results shown in this test report refer only to the sample(s) tested and such sample(s) are retained for 90 days only.

除非另有說明，此報告結果僅對測試之樣品負責，同時此樣品僅保留90天。本報告未經本公司書面許可，不可部份複製。

This document is issued by the Company subject to its General Conditions of Service printed overleaf, available on request or accessible at www.sgs.com/terms_and_conditions.htm and for electronic format documents, subject to Terms and Conditions for Electronic Documents at www.sgs.com/terms_e-document.htm. Attention is drawn to the limitation of liability, indemnification and jurisdiction issues defined therein. Any holder of this document is advised that information contained hereon reflects the Company's findings at the time of its intervention only and within the limits of Client's instructions, if any. The Company's sole responsibility is to its Client and this document does not exonerate parties to a transaction from exercising all their rights and obligations under the transaction documents. This document cannot be reproduced except in full, without prior written approval of the Company. Any unauthorized alteration, forgery or falsification of the content or appearance of this document is unlawful and offenders may be prosecuted to the fullest extent of the law.

FDD Band 4								
BW(Mhz)	Modulation	RB Size	RB Offset	Frequency (MHz)	Channel	Conducted power (dBm)	Target Power + Max. Tolerance (dBm)	MPR Allowed per 3GPP(dB)
3	64-QAM	1 RB	0	1711.5	19965	22.06	23.5	0-1
				1732.5	20175	23.35	23.5	0-1
				1753.5	20385	22.98	23.5	0-1
			7	1711.5	19965	23.12	23.5	0-1
				1732.5	20175	22.73	23.5	0-1
				1753.5	20385	22.74	23.5	0-1
			14	1711.5	19965	23.25	23.5	0-1
				1732.5	20175	22.62	23.5	0-1
				1753.5	20385	22.73	23.5	0-1
		8 RB	0	1711.5	19965	21.90	22.5	0-2
				1732.5	20175	22.10	22.5	0-2
				1753.5	20385	21.91	22.5	0-2
			4	1711.5	19965	22.11	22.5	0-2
				1732.5	20175	21.89	22.5	0-2
				1753.5	20385	21.31	22.5	0-2
			7	1711.5	19965	21.90	22.5	0-2
				1732.5	20175	21.76	22.5	0-2
				1753.5	20385	21.46	22.5	0-2
		15RB	1711.5	19965	21.33	22.5	0-2	
			1732.5	20175	21.35	22.5	0-2	
			1753.5	20385	21.27	22.5	0-2	

Unless otherwise stated the results shown in this test report refer only to the sample(s) tested and such sample(s) are retained for 90 days only.

除非另有說明，此報告結果僅對測試之樣品負責，同時此樣品僅保留90天。本報告未經本公司書面許可，不可部份複製。

This document is issued by the Company subject to its General Conditions of Service printed overleaf, available on request or accessible at www.sgs.com/terms_and_conditions.htm and for electronic format documents, subject to Terms and Conditions for Electronic Documents at www.sgs.com/terms_e-document.htm. Attention is drawn to the limitation of liability, indemnification and jurisdiction issues defined therein. Any holder of this document is advised that information contained hereon reflects the Company's findings at the time of its intervention only and within the limits of Client's instructions, if any. The Company's sole responsibility is to its Client and this document does not exonerate parties to a transaction from exercising all their rights and obligations under the transaction documents. This document cannot be reproduced except in full, without prior written approval of the Company. Any unauthorized alteration, forgery or falsification of the content or appearance of this document is unlawful and offenders may be prosecuted to the fullest extent of the law.

FDD Band 4									
BW(Mhz)	Modulation	RB Size	RB Offset	Frequency (MHz)	Channel	Conducted power (dBm)	Target Power + Max. Tolerance (dBm)	MPR Allowed per 3GPP(dB)	
1.4	QPSK	1 RB	0	1710.7	19957	23.98	24.5	0	
				1732.5	20175	23.94	24.5	0	
				1754.3	20393	23.92	24.5	0	
			2	1710.7	19957	23.73	24.5	0	
				1732.5	20175	23.77	24.5	0	
				1754.3	20393	23.19	24.5	0	
		5	1710.7	19957	23.91	24.5	0		
			1732.5	20175	23.43	24.5	0		
			1754.3	20393	23.83	24.5	0		
		3 RB	0	1710.7	19957	23.05	23.5	0-1	
				1732.5	20175	23.16	23.5	0-1	
				1754.3	20393	22.87	23.5	0-1	
			2	1710.7	19957	22.77	23.5	0-1	
				1732.5	20175	22.96	23.5	0-1	
				1754.3	20393	22.52	23.5	0-1	
			3	1710.7	19957	22.89	23.5	0-1	
				1732.5	20175	22.71	23.5	0-1	
				1754.3	20393	22.60	23.5	0-1	
		6RB	1710.7	19957	22.37	23.5	0-1		
			1732.5	20175	22.48	23.5	0-1		
			1754.3	20393	22.50	23.5	0-1		
		16-QAM	1 RB	0	1710.7	19957	22.24	23.5	0-1
					1732.5	20175	23.44	23.5	0-1
					1754.3	20393	23.09	23.5	0-1
	2			1710.7	19957	23.15	23.5	0-1	
				1732.5	20175	22.73	23.5	0-1	
				1754.3	20393	22.89	23.5	0-1	
	5			1710.7	19957	23.19	23.5	0-1	
				1732.5	20175	22.68	23.5	0-1	
				1754.3	20393	22.91	23.5	0-1	
	3 RB			0	1710.7	19957	22.15	22.5	0-2
					1732.5	20175	22.03	22.5	0-2
					1754.3	20393	21.94	22.5	0-2
			2	1710.7	19957	22.14	22.5	0-2	
				1732.5	20175	21.97	22.5	0-2	
				1754.3	20393	21.37	22.5	0-2	
			3	1710.7	19957	22.01	22.5	0-2	
				1732.5	20175	21.76	22.5	0-2	
				1754.3	20393	21.39	22.5	0-2	
	6RB		1710.7	19957	21.46	22.5	0-2		
			1732.5	20175	21.56	22.5	0-2		
			1754.3	20393	21.47	22.5	0-2		

Unless otherwise stated the results shown in this test report refer only to the sample(s) tested and such sample(s) are retained for 90 days only.

除非另有說明，此報告結果僅對測試之樣品負責，同時此樣品僅保留90天。本報告未經本公司書面許可，不可部份複製。

This document is issued by the Company subject to its General Conditions of Service printed overleaf, available on request or accessible at www.sgs.com/terms_and_conditions.htm and for electronic format documents, subject to Terms and Conditions for Electronic Documents at www.sgs.com/terms_e-document.htm. Attention is drawn to the limitation of liability, indemnification and jurisdiction issues defined therein. Any holder of this document is advised that information contained hereon reflects the Company's findings at the time of its intervention only and within the limits of Client's instructions, if any. The Company's sole responsibility is to its Client and this document does not exonerate parties to a transaction from exercising all their rights and obligations under the transaction documents. This document cannot be reproduced except in full, without prior written approval of the Company. Any unauthorized alteration, forgery or falsification of the content or appearance of this document is unlawful and offenders may be prosecuted to the fullest extent of the law.

FDD Band 4								
BW(Mhz)	Modulation	RB Size	RB Offset	Frequency (MHz)	Channel	Conducted power (dBm)	Target Power + Max. Tolerance (dBm)	MPR Allowed per 3GPP(dB)
1.4	64-QAM	1 RB	0	1710.7	19957	22.01	23.5	0-1
				1732.5	20175	23.16	23.5	0-1
				1754.3	20393	22.94	23.5	0-1
			2	1710.7	19957	22.85	23.5	0-1
				1732.5	20175	22.60	23.5	0-1
				1754.3	20393	22.72	23.5	0-1
			5	1710.7	19957	23.24	23.5	0-1
				1732.5	20175	22.63	23.5	0-1
				1754.3	20393	22.94	23.5	0-1
		3 RB	0	1710.7	19957	21.89	22.5	0-2
				1732.5	20175	22.06	22.5	0-2
				1754.3	20393	21.68	22.5	0-2
			2	1710.7	19957	21.97	22.5	0-2
				1732.5	20175	21.85	22.5	0-2
				1754.3	20393	21.21	22.5	0-2
			3	1710.7	19957	21.77	22.5	0-2
				1732.5	20175	21.64	22.5	0-2
				1754.3	20393	21.53	22.5	0-2
		6RB	1710.7	19957	21.38	22.5	0-2	
			1732.5	20175	21.36	22.5	0-2	
			1754.3	20393	21.40	22.5	0-2	

Unless otherwise stated the results shown in this test report refer only to the sample(s) tested and such sample(s) are retained for 90 days only.

除非另有說明，此報告結果僅對測試之樣品負責，同時此樣品僅保留90天。本報告未經本公司書面許可，不可部份複製。

This document is issued by the Company subject to its General Conditions of Service printed overleaf, available on request or accessible at www.sgs.com/terms_and_conditions.htm and for electronic format documents, subject to Terms and Conditions for Electronic Documents at www.sgs.com/terms_e-document.htm. Attention is drawn to the limitation of liability, indemnification and jurisdiction issues defined therein. Any holder of this document is advised that information contained hereon reflects the Company's findings at the time of its intervention only and within the limits of Client's instructions, if any. The Company's sole responsibility is to its Client and this document does not exonerate parties to a transaction from exercising all their rights and obligations under the transaction documents. This document cannot be reproduced except in full, without prior written approval of the Company. Any unauthorized alteration, forgery or falsification of the content or appearance of this document is unlawful and offenders may be prosecuted to the fullest extent of the law.

FDD Band 5									
BW(Mhz)	Modulation	RB Size	RB Offset	Frequency (MHz)	Channel	Conducted power (dBm)	Target Power + Max. Tolerance (dBm)	MPR Allowed per 3GPP(dB)	
10	QPSK	1 RB	0	829	20450	24.13	25	0	
				836.5	20525	24.04	25	0	
				844	20600	23.93	25	0	
			25	829	20450	24.01	25	0	
				836.5	20525	23.99	25	0	
				844	20600	24.09	25	0	
			49	829	20450	24.02	25	0	
				836.5	20525	23.86	25	0	
				844	20600	23.88	25	0	
		25 RB	0	829	20450	23.16	24	0-1	
				836.5	20525	23.14	24	0-1	
				844	20600	23.15	24	0-1	
			12	829	20450	23.13	24	0-1	
				836.5	20525	23.07	24	0-1	
				844	20600	23.03	24	0-1	
			25	829	20450	23.11	24	0-1	
				836.5	20525	23.02	24	0-1	
				844	20600	23.08	24	0-1	
		50RB	829	20450	23.08	24	0-1		
			836.5	20525	23.07	24	0-1		
			844	20600	23.06	24	0-1		
		16-QAM	1 RB	0	829	20450	23.55	24	0-1
					836.5	20525	23.55	24	0-1
					844	20600	23.49	24	0-1
	25			829	20450	23.59	24	0-1	
				836.5	20525	23.44	24	0-1	
				844	20600	23.64	24	0-1	
	49			829	20450	23.50	24	0-1	
				836.5	20525	23.38	24	0-1	
				844	20600	23.33	24	0-1	
	25 RB			0	829	20450	22.08	23	0-2
					836.5	20525	22.04	23	0-2
					844	20600	22.08	23	0-2
			12	829	20450	22.10	23	0-2	
				836.5	20525	22.01	23	0-2	
				844	20600	22.09	23	0-2	
			25	829	20450	22.20	23	0-2	
				836.5	20525	22.02	23	0-2	
				844	20600	21.93	23	0-2	
	500RB		829	20450	22.09	23	0-2		
			836.5	20525	22.04	23	0-2		
			844	20600	22.02	23	0-2		

Unless otherwise stated the results shown in this test report refer only to the sample(s) tested and such sample(s) are retained for 90 days only.

除非另有說明，此報告結果僅對測試之樣品負責，同時此樣品僅保留90天。本報告未經本公司書面許可，不可部份複製。

This document is issued by the Company subject to its General Conditions of Service printed overleaf, available on request or accessible at www.sgs.com/terms_and_conditions.htm and for electronic format documents, subject to Terms and Conditions for Electronic Documents at www.sgs.com/terms_e-document.htm. Attention is drawn to the limitation of liability, indemnification and jurisdiction issues defined therein. Any holder of this document is advised that information contained hereon reflects the Company's findings at the time of its intervention only and within the limits of Client's instructions, if any. The Company's sole responsibility is to its Client and this document does not exonerate parties to a transaction from exercising all their rights and obligations under the transaction documents. This document cannot be reproduced except in full, without prior written approval of the Company. Any unauthorized alteration, forgery or falsification of the content or appearance of this document is unlawful and offenders may be prosecuted to the fullest extent of the law.

FDD Band 5								
BW(Mhz)	Modulation	RB Size	RB Offset	Frequency (MHz)	Channel	Conducted power (dBm)	Target Power + Max. Tolerance (dBm)	MPR Allowed per 3GPP(dB)
10	64-QAM	1 RB	0	829	20450	23.41	24	0-1
				836.5	20525	23.36	24	0-1
				844	20600	23.35	24	0-1
			25	829	20450	23.45	24	0-1
				836.5	20525	23.30	24	0-1
				844	20600	23.50	24	0-1
			49	829	20450	23.36	24	0-1
				836.5	20525	23.24	24	0-1
				844	20600	23.19	24	0-1
		25 RB	0	829	20450	21.94	23	0-2
				836.5	20525	21.90	23	0-2
				844	20600	21.94	23	0-2
			12	829	20450	21.96	23	0-2
				836.5	20525	21.87	23	0-2
				844	20600	21.95	23	0-2
			25	829	20450	22.06	23	0-2
				836.5	20525	21.88	23	0-2
				844	20600	21.79	23	0-2
		500RB	829	20450	21.95	23	0-2	
			836.5	20525	21.90	23	0-2	
			844	20600	21.88	23	0-2	

Unless otherwise stated the results shown in this test report refer only to the sample(s) tested and such sample(s) are retained for 90 days only.

除非另有說明，此報告結果僅對測試之樣品負責，同時此樣品僅保留90天。本報告未經本公司書面許可，不可部份複製。

This document is issued by the Company subject to its General Conditions of Service printed overleaf, available on request or accessible at www.sgs.com/terms_and_conditions.htm and for electronic format documents, subject to Terms and Conditions for Electronic Documents at www.sgs.com/terms_e-document.htm. Attention is drawn to the limitation of liability, indemnification and jurisdiction issues defined therein. Any holder of this document is advised that information contained hereon reflects the Company's findings at the time of its intervention only and within the limits of Client's instructions, if any. The Company's sole responsibility is to its Client and this document does not exonerate parties to a transaction from exercising all their rights and obligations under the transaction documents. This document cannot be reproduced except in full, without prior written approval of the Company. Any unauthorized alteration, forgery or falsification of the content or appearance of this document is unlawful and offenders may be prosecuted to the fullest extent of the law.

FDD Band 5									
BW(Mhz)	Modulation	RB Size	RB Offset	Frequency (MHz)	Channel	Conducted power (dBm)	Target Power + Max. Tolerance (dBm)	MPR Allowed per 3GPP(dB)	
5	QPSK	1 RB	0	826.5	20425	23.94	25	0	
				836.5	20525	23.92	25	0	
				846.5	20625	23.70	25	0	
			12	826.5	20425	23.89	25	0	
				836.5	20525	23.90	25	0	
				846.5	20625	23.95	25	0	
		24	826.5	20425	23.85	25	0		
			836.5	20525	23.84	25	0		
			846.5	20625	23.72	25	0		
		12 RB	0	826.5	20425	22.86	24	0-1	
				836.5	20525	22.88	24	0-1	
				846.5	20625	22.93	24	0-1	
			6	826.5	20425	22.94	24	0-1	
				836.5	20525	22.78	24	0-1	
				846.5	20625	22.76	24	0-1	
			13	826.5	20425	23.01	24	0-1	
				836.5	20525	22.84	24	0-1	
				846.5	20625	22.99	24	0-1	
		25RB	826.5	20425	22.95	24	0-1		
			836.5	20525	23.07	24	0-1		
			846.5	20625	23.02	24	0-1		
		16-QAM	1 RB	0	826.5	20425	23.48	24	0-1
					836.5	20525	23.55	24	0-1
					846.5	20625	23.37	24	0-1
	12			826.5	20425	23.33	24	0-1	
				836.5	20525	23.24	24	0-1	
				846.5	20625	23.62	24	0-1	
	24			826.5	20425	23.38	24	0-1	
				836.5	20525	23.22	24	0-1	
				846.5	20625	23.31	24	0-1	
	12 RB			0	826.5	20425	22.02	23	0-2
					836.5	20525	21.90	23	0-2
					846.5	20625	21.91	23	0-2
			6	826.5	20425	21.89	23	0-2	
				836.5	20525	21.89	23	0-2	
				846.5	20625	22.02	23	0-2	
			13	826.5	20425	21.99	23	0-2	
				836.5	20525	21.81	23	0-2	
				846.5	20625	21.81	23	0-2	
	25RB		826.5	20425	22.02	23	0-2		
			836.5	20525	21.88	23	0-2		
			846.5	20625	21.73	23	0-2		

Unless otherwise stated the results shown in this test report refer only to the sample(s) tested and such sample(s) are retained for 90 days only.

除非另有說明，此報告結果僅對測試之樣品負責，同時此樣品僅保留90天。本報告未經本公司書面許可，不可部份複製。

This document is issued by the Company subject to its General Conditions of Service printed overleaf, available on request or accessible at www.sgs.com/terms_and_conditions.htm and for electronic format documents, subject to Terms and Conditions for Electronic Documents at www.sgs.com/terms_e-document.htm. Attention is drawn to the limitation of liability, indemnification and jurisdiction issues defined therein. Any holder of this document is advised that information contained hereon reflects the Company's findings at the time of its intervention only and within the limits of Client's instructions, if any. The Company's sole responsibility is to its Client and this document does not exonerate parties to a transaction from exercising all their rights and obligations under the transaction documents. This document cannot be reproduced except in full, without prior written approval of the Company. Any unauthorized alteration, forgery or falsification of the content or appearance of this document is unlawful and offenders may be prosecuted to the fullest extent of the law.

FDD Band 5								
BW(Mhz)	Modulation	RB Size	RB Offset	Frequency (MHz)	Channel	Conducted power (dBm)	Target Power + Max. Tolerance (dBm)	MPR Allowed per 3GPP(dB)
5	64-QAM	1 RB	0	826.5	20425	23.14	24	0-1
				836.5	20525	23.23	24	0-1
				846.5	20625	23.15	24	0-1
			12	826.5	20425	23.16	24	0-1
				836.5	20525	23.21	24	0-1
				846.5	20625	23.25	24	0-1
			24	826.5	20425	23.06	24	0-1
				836.5	20525	23.17	24	0-1
				846.5	20625	23.00	24	0-1
		12 RB	0	826.5	20425	21.83	23	0-2
				836.5	20525	21.72	23	0-2
				846.5	20625	21.87	23	0-2
			6	826.5	20425	21.79	23	0-2
				836.5	20525	21.80	23	0-2
				846.5	20625	21.86	23	0-2
			13	826.5	20425	21.85	23	0-2
				836.5	20525	21.71	23	0-2
				846.5	20625	21.72	23	0-2
		25RB	826.5	20425	21.87	23	0-2	
			836.5	20525	21.79	23	0-2	
			846.5	20625	21.65	23	0-2	

Unless otherwise stated the results shown in this test report refer only to the sample(s) tested and such sample(s) are retained for 90 days only.

除非另有說明，此報告結果僅對測試之樣品負責，同時此樣品僅保留90天。本報告未經本公司書面許可，不可部份複製。

This document is issued by the Company subject to its General Conditions of Service printed overleaf, available on request or accessible at www.sgs.com/terms_and_conditions.htm and for electronic format documents, subject to Terms and Conditions for Electronic Documents at www.sgs.com/terms_e-document.htm. Attention is drawn to the limitation of liability, indemnification and jurisdiction issues defined therein. Any holder of this document is advised that information contained hereon reflects the Company's findings at the time of its intervention only and within the limits of Client's instructions, if any. The Company's sole responsibility is to its Client and this document does not exonerate parties to a transaction from exercising all their rights and obligations under the transaction documents. This document cannot be reproduced except in full, without prior written approval of the Company. Any unauthorized alteration, forgery or falsification of the content or appearance of this document is unlawful and offenders may be prosecuted to the fullest extent of the law.

FDD Band 5									
BW(Mhz)	Modulation	RB Size	RB Offset	Frequency (MHz)	Channel	Conducted power (dBm)	Target Power + Max. Tolerance (dBm)	MPR Allowed per 3GPP(dB)	
3	QPSK	1 RB	0	825.5	20415	23.94	25	0	
				836.5	20525	24.00	25	0	
				847.5	20635	23.84	25	0	
			7	825.5	20415	23.98	25	0	
				836.5	20525	23.79	25	0	
				847.5	20635	23.91	25	0	
		14	825.5	20415	23.93	25	0		
			836.5	20525	23.60	25	0		
			847.5	20635	23.76	25	0		
		8 RB	0	825.5	20415	22.87	24	0-1	
				836.5	20525	22.95	24	0-1	
				847.5	20635	23.07	24	0-1	
			4	825.5	20415	22.84	24	0-1	
				836.5	20525	23.04	24	0-1	
				847.5	20635	22.93	24	0-1	
			7	825.5	20415	23.01	24	0-1	
				836.5	20525	22.99	24	0-1	
				847.5	20635	23.05	24	0-1	
		15RB	825.5	20415	22.97	24	0-1		
			836.5	20525	23.04	24	0-1		
			847.5	20635	22.89	24	0-1		
		16-QAM	1 RB	0	825.5	20415	23.39	24	0-1
					836.5	20525	23.34	24	0-1
					847.5	20635	23.29	24	0-1
	7			825.5	20415	23.43	24	0-1	
				836.5	20525	23.38	24	0-1	
				847.5	20635	23.45	24	0-1	
	14			825.5	20415	23.27	24	0-1	
				836.5	20525	23.32	24	0-1	
				847.5	20635	23.16	24	0-1	
	8 RB			0	825.5	20415	21.95	23	0-2
					836.5	20525	21.79	23	0-2
					847.5	20635	22.07	23	0-2
			4	825.5	20415	22.03	23	0-2	
				836.5	20525	21.81	23	0-2	
				847.5	20635	22.03	23	0-2	
			7	825.5	20415	21.94	23	0-2	
				836.5	20525	21.85	23	0-2	
				847.5	20635	21.79	23	0-2	
	15RB		825.5	20415	21.81	23	0-2		
			836.5	20525	21.86	23	0-2		
			847.5	20635	21.98	23	0-2		

Unless otherwise stated the results shown in this test report refer only to the sample(s) tested and such sample(s) are retained for 90 days only.

除非另有說明，此報告結果僅對測試之樣品負責，同時此樣品僅保留90天。本報告未經本公司書面許可，不可部份複製。

This document is issued by the Company subject to its General Conditions of Service printed overleaf, available on request or accessible at www.sgs.com/terms_and_conditions.htm and for electronic format documents, subject to Terms and Conditions for Electronic Documents at www.sgs.com/terms_e-document.htm. Attention is drawn to the limitation of liability, indemnification and jurisdiction issues defined therein. Any holder of this document is advised that information contained hereon reflects the Company's findings at the time of its intervention only and within the limits of Client's instructions, if any. The Company's sole responsibility is to its Client and this document does not exonerate parties to a transaction from exercising all their rights and obligations under the transaction documents. This document cannot be reproduced except in full, without prior written approval of the Company. Any unauthorized alteration, forgery or falsification of the content or appearance of this document is unlawful and offenders may be prosecuted to the fullest extent of the law.

FDD Band 5								
BW(Mhz)	Modulation	RB Size	RB Offset	Frequency (MHz)	Channel	Conducted power (dBm)	Target Power + Max. Tolerance (dBm)	MPR Allowed per 3GPP(dB)
3	64-QAM	1 RB	0	825.5	20415	23.40	24	0-1
				836.5	20525	23.26	24	0-1
				847.5	20635	23.20	24	0-1
			7	825.5	20415	23.43	24	0-1
				836.5	20525	23.30	24	0-1
				847.5	20635	23.37	24	0-1
			14	825.5	20415	23.31	24	0-1
				836.5	20525	23.07	24	0-1
				847.5	20635	23.05	24	0-1
		8 RB	0	825.5	20415	21.94	23	0-2
				836.5	20525	21.88	23	0-2
				847.5	20635	21.90	23	0-2
			4	825.5	20415	21.92	23	0-2
				836.5	20525	21.70	23	0-2
				847.5	20635	21.80	23	0-2
			7	825.5	20415	21.87	23	0-2
				836.5	20525	21.75	23	0-2
				847.5	20635	21.61	23	0-2
		15RB	825.5	20415	21.87	23	0-2	
			836.5	20525	21.66	23	0-2	
			847.5	20635	21.83	23	0-2	

Unless otherwise stated the results shown in this test report refer only to the sample(s) tested and such sample(s) are retained for 90 days only.

除非另有說明，此報告結果僅對測試之樣品負責，同時此樣品僅保留90天。本報告未經本公司書面許可，不可部份複製。

This document is issued by the Company subject to its General Conditions of Service printed overleaf, available on request or accessible at www.sgs.com/terms_and_conditions.htm and for electronic format documents, subject to Terms and Conditions for Electronic Documents at www.sgs.com/terms_e-document.htm. Attention is drawn to the limitation of liability, indemnification and jurisdiction issues defined therein. Any holder of this document is advised that information contained hereon reflects the Company's findings at the time of its intervention only and within the limits of Client's instructions, if any. The Company's sole responsibility is to its Client and this document does not exonerate parties to a transaction from exercising all their rights and obligations under the transaction documents. This document cannot be reproduced except in full, without prior written approval of the Company. Any unauthorized alteration, forgery or falsification of the content or appearance of this document is unlawful and offenders may be prosecuted to the fullest extent of the law.

FDD Band 5									
BW(Mhz)	Modulation	RB Size	RB Offset	Frequency (MHz)	Channel	Conducted power (dBm)	Target Power + Max. Tolerance (dBm)	MPR Allowed per 3GPP(dB)	
1.4	QPSK	1 RB	0	824.7	20407	23.88	25	0	
				836.5	20525	23.89	25	0	
				848.3	20643	23.68	25	0	
			2	824.7	20407	24.00	25	0	
				836.5	20525	23.89	25	0	
				848.3	20643	24.07	25	0	
		5	824.7	20407	23.90	25	0		
			836.5	20525	23.84	25	0		
			848.3	20643	23.82	25	0		
		3 RB	0	824.7	20407	22.94	24	0-1	
				836.5	20525	23.04	24	0-1	
				848.3	20643	22.85	24	0-1	
			2	824.7	20407	23.10	24	0-1	
				836.5	20525	22.95	24	0-1	
				848.3	20643	22.87	24	0-1	
			3	824.7	20407	22.90	24	0-1	
				836.5	20525	22.80	24	0-1	
				848.3	20643	22.96	24	0-1	
		6RB	824.7	20407	22.83	24	0-1		
			836.5	20525	22.81	24	0-1		
			848.3	20643	22.97	24	0-1		
		16-QAM	1 RB	0	824.7	20407	23.27	24	0-1
					836.5	20525	23.41	24	0-1
					848.3	20643	23.27	24	0-1
	2			824.7	20407	23.32	24	0-1	
				836.5	20525	23.18	24	0-1	
				848.3	20643	23.60	24	0-1	
	5			824.7	20407	23.42	24	0-1	
				836.5	20525	23.10	24	0-1	
				848.3	20643	23.28	24	0-1	
	3 RB			0	824.7	20407	21.85	23	0-2
					836.5	20525	21.96	23	0-2
					848.3	20643	21.87	23	0-2
			2	824.7	20407	22.01	23	0-2	
				836.5	20525	21.91	23	0-2	
				848.3	20643	22.05	23	0-2	
			3	824.7	20407	22.19	23	0-2	
				836.5	20525	21.81	23	0-2	
				848.3	20643	21.65	23	0-2	
	6RB		824.7	20407	21.80	23	0-2		
			836.5	20525	22.02	23	0-2		
			848.3	20643	21.86	23	0-2		

Unless otherwise stated the results shown in this test report refer only to the sample(s) tested and such sample(s) are retained for 90 days only.

除非另有說明，此報告結果僅對測試之樣品負責，同時此樣品僅保留90天。本報告未經本公司書面許可，不可部份複製。

This document is issued by the Company subject to its General Conditions of Service printed overleaf, available on request or accessible at www.sgs.com/terms_and_conditions.htm and for electronic format documents, subject to Terms and Conditions for Electronic Documents at www.sgs.com/terms_e-document.htm. Attention is drawn to the limitation of liability, indemnification and jurisdiction issues defined therein. Any holder of this document is advised that information contained hereon reflects the Company's findings at the time of its intervention only and within the limits of Client's instructions, if any. The Company's sole responsibility is to its Client and this document does not exonerate parties to a transaction from exercising all their rights and obligations under the transaction documents. This document cannot be reproduced except in full, without prior written approval of the Company. Any unauthorized alteration, forgery or falsification of the content or appearance of this document is unlawful and offenders may be prosecuted to the fullest extent of the law.

FDD Band 5								
BW(Mhz)	Modulation	RB Size	RB Offset	Frequency (MHz)	Channel	Conducted power (dBm)	Target Power + Max. Tolerance (dBm)	MPR Allowed per 3GPP(dB)
1.4	64-QAM	1 RB	0	824.7	20407	23.28	24	0-1
				836.5	20525	23.08	24	0-1
				848.3	20643	23.33	24	0-1
			2	824.7	20407	23.19	24	0-1
				836.5	20525	23.18	24	0-1
				848.3	20643	23.39	24	0-1
			5	824.7	20407	23.30	24	0-1
				836.5	20525	23.02	24	0-1
				848.3	20643	23.02	24	0-1
		3 RB	0	824.7	20407	21.90	23	0-2
				836.5	20525	21.77	23	0-2
				848.3	20643	21.88	23	0-2
			2	824.7	20407	21.70	23	0-2
				836.5	20525	21.81	23	0-2
				848.3	20643	21.68	23	0-2
			3	824.7	20407	22.01	23	0-2
				836.5	20525	21.74	23	0-2
				848.3	20643	21.67	23	0-2
		6RB	824.7	20407	21.81	23	0-2	
			836.5	20525	21.70	23	0-2	
			848.3	20643	21.74	23	0-2	

Unless otherwise stated the results shown in this test report refer only to the sample(s) tested and such sample(s) are retained for 90 days only.

除非另有說明，此報告結果僅對測試之樣品負責，同時此樣品僅保留90天。本報告未經本公司書面許可，不可部份複製。

This document is issued by the Company subject to its General Conditions of Service printed overleaf, available on request or accessible at www.sgs.com/terms_and_conditions.htm and for electronic format documents, subject to Terms and Conditions for Electronic Documents at www.sgs.com/terms_e-document.htm. Attention is drawn to the limitation of liability, indemnification and jurisdiction issues defined therein. Any holder of this document is advised that information contained hereon reflects the Company's findings at the time of its intervention only and within the limits of Client's instructions, if any. The Company's sole responsibility is to its Client and this document does not exonerate parties to a transaction from exercising all their rights and obligations under the transaction documents. This document cannot be reproduced except in full, without prior written approval of the Company. Any unauthorized alteration, forgery or falsification of the content or appearance of this document is unlawful and offenders may be prosecuted to the fullest extent of the law.

FDD Band 7									
BW(Mhz)	Modulation	RB Size	RB Offset	Frequency (MHz)	Channel	Conducted power (dBm)	Target Power + Max. Tolerance (dBm)	MPR Allowed per 3GPP(dB)	
20	QPSK	1 RB	0	2510	20850	22.65	22.8	0	
				2535	21100	22.69	22.8	0	
				2560	21350	22.68	22.8	0	
			50	2510	20850	22.31	22.8	0	
				2535	21100	22.43	22.8	0	
				2560	21350	22.47	22.8	0	
			99	2510	20850	22.44	22.8	0	
				2535	21100	22.51	22.8	0	
				2560	21350	22.68	22.8	0	
		50 RB	0	2510	20850	21.46	21.8	0-1	
				2535	21100	21.54	21.8	0-1	
				2560	21350	21.45	21.8	0-1	
			25	2510	20850	21.47	21.8	0-1	
				2535	21100	21.45	21.8	0-1	
				2560	21350	21.63	21.8	0-1	
			50	2510	20850	21.50	21.8	0-1	
				2535	21100	21.49	21.8	0-1	
				2560	21350	21.57	21.8	0-1	
		100RB	2510	20850	21.43	21.8	0-1		
			2535	21100	21.57	21.8	0-1		
			2560	21350	21.54	21.8	0-1		
		16-QAM	1 RB	0	2510	20850	21.65	21.8	0-1
					2535	21100	21.55	21.8	0-1
					2560	21350	21.61	21.8	0-1
	50			2510	20850	21.51	21.8	0-1	
				2535	21100	21.46	21.8	0-1	
				2560	21350	21.61	21.8	0-1	
	99			2510	20850	21.76	21.8	0-1	
				2535	21100	21.52	21.8	0-1	
				2560	21350	21.54	21.8	0-1	
	50 RB			0	2510	20850	20.61	20.8	0-2
					2535	21100	20.47	20.8	0-2
					2560	21350	20.57	20.8	0-2
			25	2510	20850	20.58	20.8	0-2	
				2535	21100	20.54	20.8	0-2	
				2560	21350	20.56	20.8	0-2	
			50	2510	20850	20.55	20.8	0-2	
				2535	21100	20.48	20.8	0-2	
				2560	21350	20.48	20.8	0-2	
	100RB		2510	20850	20.50	20.8	0-2		
			2535	21100	20.41	20.8	0-2		
			2560	21350	20.60	20.8	0-2		

Unless otherwise stated the results shown in this test report refer only to the sample(s) tested and such sample(s) are retained for 90 days only.

除非另有說明，此報告結果僅對測試之樣品負責，同時此樣品僅保留90天。本報告未經本公司書面許可，不可部份複製。

This document is issued by the Company subject to its General Conditions of Service printed overleaf, available on request or accessible at www.sgs.com/terms_and_conditions.htm and for electronic format documents, subject to Terms and Conditions for Electronic Documents at www.sgs.com/terms_e-document.htm. Attention is drawn to the limitation of liability, indemnification and jurisdiction issues defined therein. Any holder of this document is advised that information contained hereon reflects the Company's findings at the time of its intervention only and within the limits of Client's instructions, if any. The Company's sole responsibility is to its Client and this document does not exonerate parties to a transaction from exercising all their rights and obligations under the transaction documents. This document cannot be reproduced except in full, without prior written approval of the Company. Any unauthorized alteration, forgery or falsification of the content or appearance of this document is unlawful and offenders may be prosecuted to the fullest extent of the law.

FDD Band 7								
BW(Mhz)	Modulation	RB Size	RB Offset	Frequency (MHz)	Channel	Conducted power (dBm)	Target Power + Max. Tolerance (dBm)	MPR Allowed per 3GPP(dB)
20	64-QAM	1 RB	0	2510	20850	21.55	21.8	0-1
				2535	21100	21.75	21.8	0-1
				2560	21350	21.72	21.8	0-1
			50	2510	20850	21.46	21.8	0-1
				2535	21100	21.43	21.8	0-1
				2560	21350	21.64	21.8	0-1
			99	2510	20850	21.67	21.8	0-1
				2535	21100	21.65	21.8	0-1
				2560	21350	21.57	21.8	0-1
		50 RB	0	2510	20850	20.47	20.8	0-2
				2535	21100	20.42	20.8	0-2
				2560	21350	20.48	20.8	0-2
			25	2510	20850	20.60	20.8	0-2
				2535	21100	20.54	20.8	0-2
				2560	21350	20.56	20.8	0-2
			50	2510	20850	20.46	20.8	0-2
				2535	21100	20.55	20.8	0-2
				2560	21350	20.40	20.8	0-2
			100RB	2510	20850	20.46	20.8	0-2
				2535	21100	20.53	20.8	0-2
				2560	21350	20.42	20.8	0-2

Unless otherwise stated the results shown in this test report refer only to the sample(s) tested and such sample(s) are retained for 90 days only.

除非另有說明，此報告結果僅對測試之樣品負責，同時此樣品僅保留90天。本報告未經本公司書面許可，不可部份複製。

This document is issued by the Company subject to its General Conditions of Service printed overleaf, available on request or accessible at www.sgs.com/terms_and_conditions.htm and for electronic format documents, subject to Terms and Conditions for Electronic Documents at www.sgs.com/terms_e-document.htm. Attention is drawn to the limitation of liability, indemnification and jurisdiction issues defined therein. Any holder of this document is advised that information contained hereon reflects the Company's findings at the time of its intervention only and within the limits of Client's instructions, if any. The Company's sole responsibility is to its Client and this document does not exonerate parties to a transaction from exercising all their rights and obligations under the transaction documents. This document cannot be reproduced except in full, without prior written approval of the Company. Any unauthorized alteration, forgery or falsification of the content or appearance of this document is unlawful and offenders may be prosecuted to the fullest extent of the law.

FDD Band 7									
BW(Mhz)	Modulation	RB Size	RB Offset	Frequency (MHz)	Channel	Conducted power (dBm)	Target Power + Max. Tolerance (dBm)	MPR Allowed per 3GPP(dB)	
15	QPSK	1 RB	0	2507.5	20825	22.38	22.8	0	
				2535	21100	22.50	22.8	0	
				2562.5	21375	22.56	22.8	0	
			36	2507.5	20825	22.10	22.8	0	
				2535	21100	22.42	22.8	0	
				2562.5	21375	22.25	22.8	0	
		74	2507.5	20825	22.51	22.8	0		
			2535	21100	22.35	22.8	0		
			2562.5	21375	22.44	22.8	0		
		36 RB	0	2507.5	20825	21.45	21.8	0-1	
				2535	21100	21.50	21.8	0-1	
				2562.5	21375	21.41	21.8	0-1	
			18	2507.5	20825	21.31	21.8	0-1	
				2535	21100	21.47	21.8	0-1	
				2562.5	21375	21.64	21.8	0-1	
		37	2507.5	20825	21.25	21.8	0-1		
			2535	21100	21.37	21.8	0-1		
			2562.5	21375	21.40	21.8	0-1		
		75RB	2507.5	20825	21.42	21.8	0-1		
			2535	21100	21.33	21.8	0-1		
			2562.5	21375	21.50	21.8	0-1		
		16-QAM	1 RB	0	2507.5	20825	21.35	21.8	0-1
					2535	21100	21.46	21.8	0-1
					2562.5	21375	21.60	21.8	0-1
	36			2507.5	20825	21.41	21.8	0-1	
				2535	21100	21.21	21.8	0-1	
				2562.5	21375	21.64	21.8	0-1	
	74		2507.5	20825	21.78	21.8	0-1		
			2535	21100	21.65	21.8	0-1		
			2562.5	21375	21.67	21.8	0-1		
	36 RB		0	2507.5	20825	20.38	20.8	0-2	
				2535	21100	20.32	20.8	0-2	
				2562.5	21375	20.30	20.8	0-2	
			18	2507.5	20825	20.59	20.8	0-2	
				2535	21100	20.22	20.8	0-2	
				2562.5	21375	20.60	20.8	0-2	
	37		2507.5	20825	20.39	20.8	0-2		
			2535	21100	20.32	20.8	0-2		
			2562.5	21375	20.25	20.8	0-2		
	75RB		2507.5	20825	20.20	20.8	0-2		
			2535	21100	20.51	20.8	0-2		
			2562.5	21375	20.55	20.8	0-2		

Unless otherwise stated the results shown in this test report refer only to the sample(s) tested and such sample(s) are retained for 90 days only.

除非另有說明，此報告結果僅對測試之樣品負責，同時此樣品僅保留90天。本報告未經本公司書面許可，不可部份複製。

This document is issued by the Company subject to its General Conditions of Service printed overleaf, available on request or accessible at www.sgs.com/terms_and_conditions.htm and for electronic format documents, subject to Terms and Conditions for Electronic Documents at www.sgs.com/terms_e-document.htm. Attention is drawn to the limitation of liability, indemnification and jurisdiction issues defined therein. Any holder of this document is advised that information contained hereon reflects the Company's findings at the time of its intervention only and within the limits of Client's instructions, if any. The Company's sole responsibility is to its Client and this document does not exonerate parties to a transaction from exercising all their rights and obligations under the transaction documents. This document cannot be reproduced except in full, without prior written approval of the Company. Any unauthorized alteration, forgery or falsification of the content or appearance of this document is unlawful and offenders may be prosecuted to the fullest extent of the law.

FDD Band 7								
BW(Mhz)	Modulation	RB Size	RB Offset	Frequency (MHz)	Channel	Conducted power (dBm)	Target Power + Max. Tolerance (dBm)	MPR Allowed per 3GPP(dB)
15	64-QAM	1 RB	0	2507.5	20825	21.61	21.8	0-1
				2535	21100	21.50	21.8	0-1
				2562.5	21375	21.56	21.8	0-1
			36	2507.5	20825	21.39	21.8	0-1
				2535	21100	21.18	21.8	0-1
				2562.5	21375	21.60	21.8	0-1
			74	2507.5	20825	21.74	21.8	0-1
				2535	21100	21.73	21.8	0-1
				2562.5	21375	21.61	21.8	0-1
		36 RB	0	2507.5	20825	20.32	20.8	0-2
				2535	21100	20.24	20.8	0-2
				2562.5	21375	20.31	20.8	0-2
			18	2507.5	20825	20.28	20.8	0-2
				2535	21100	20.40	20.8	0-2
				2562.5	21375	20.46	20.8	0-2
			37	2507.5	20825	20.33	20.8	0-2
				2535	21100	20.32	20.8	0-2
				2562.5	21375	20.26	20.8	0-2
			75RB	2507.5	20825	20.11	20.8	0-2
				2535	21100	20.47	20.8	0-2
				2562.5	21375	20.56	20.8	0-2

Unless otherwise stated the results shown in this test report refer only to the sample(s) tested and such sample(s) are retained for 90 days only.

除非另有說明，此報告結果僅對測試之樣品負責，同時此樣品僅保留90天。本報告未經本公司書面許可，不可部份複製。

This document is issued by the Company subject to its General Conditions of Service printed overleaf, available on request or accessible at www.sgs.com/terms_and_conditions.htm and for electronic format documents, subject to Terms and Conditions for Electronic Documents at www.sgs.com/terms_e-document.htm. Attention is drawn to the limitation of liability, indemnification and jurisdiction issues defined therein. Any holder of this document is advised that information contained hereon reflects the Company's findings at the time of its intervention only and within the limits of Client's instructions, if any. The Company's sole responsibility is to its Client and this document does not exonerate parties to a transaction from exercising all their rights and obligations under the transaction documents. This document cannot be reproduced except in full, without prior written approval of the Company. Any unauthorized alteration, forgery or falsification of the content or appearance of this document is unlawful and offenders may be prosecuted to the fullest extent of the law.

FDD Band 7									
BW(Mhz)	Modulation	RB Size	RB Offset	Frequency (MHz)	Channel	Conducted power (dBm)	Target Power + Max. Tolerance (dBm)	MPR Allowed per 3GPP(dB)	
10	QPSK	1 RB	0	2505	20800	22.36	22.8	0	
				2535	21100	22.57	22.8	0	
				2565	21400	22.45	22.8	0	
			25	2505	20800	22.15	22.8	0	
				2535	21100	22.22	22.8	0	
				2565	21400	22.49	22.8	0	
		49	2505	20800	22.52	22.8	0		
			2535	21100	22.36	22.8	0		
			2565	21400	22.58	22.8	0		
		25 RB	0	2505	20800	21.33	21.8	0-1	
				2535	21100	21.35	21.8	0-1	
				2565	21400	21.44	21.8	0-1	
			12	2505	20800	21.56	21.8	0-1	
				2535	21100	21.19	21.8	0-1	
				2565	21400	21.40	21.8	0-1	
		25	2505	20800	21.22	21.8	0-1		
			2535	21100	21.21	21.8	0-1		
			2565	21400	21.34	21.8	0-1		
		50RB	2505	20800	21.30	21.8	0-1		
			2535	21100	21.62	21.8	0-1		
			2565	21400	21.47	21.8	0-1		
		16-QAM	1 RB	0	2505	20800	21.51	21.8	0-1
					2535	21100	21.39	21.8	0-1
					2565	21400	21.51	21.8	0-1
	25			2505	20800	21.43	21.8	0-1	
				2535	21100	21.17	21.8	0-1	
				2565	21400	21.69	21.8	0-1	
	49			2505	20800	21.70	21.8	0-1	
				2535	21100	21.74	21.8	0-1	
				2565	21400	21.62	21.8	0-1	
	25 RB			0	2505	20800	20.41	20.8	0-2
					2535	21100	20.33	20.8	0-2
					2565	21400	20.42	20.8	0-2
			12	2505	20800	20.45	20.8	0-2	
				2535	21100	20.43	20.8	0-2	
				2565	21400	20.58	20.8	0-2	
	25		2505	20800	20.42	20.8	0-2		
			2535	21100	20.41	20.8	0-2		
			2565	21400	20.47	20.8	0-2		
	50RB		2505	20800	20.26	20.8	0-2		
			2535	21100	20.28	20.8	0-2		
			2565	21400	20.36	20.8	0-2		

Unless otherwise stated the results shown in this test report refer only to the sample(s) tested and such sample(s) are retained for 90 days only.

除非另有說明，此報告結果僅對測試之樣品負責，同時此樣品僅保留90天。本報告未經本公司書面許可，不可部份複製。

This document is issued by the Company subject to its General Conditions of Service printed overleaf, available on request or accessible at www.sgs.com/terms_and_conditions.htm and for electronic format documents, subject to Terms and Conditions for Electronic Documents at www.sgs.com/terms_e-document.htm. Attention is drawn to the limitation of liability, indemnification and jurisdiction issues defined therein. Any holder of this document is advised that information contained hereon reflects the Company's findings at the time of its intervention only and within the limits of Client's instructions, if any. The Company's sole responsibility is to its Client and this document does not exonerate parties to a transaction from exercising all their rights and obligations under the transaction documents. This document cannot be reproduced except in full, without prior written approval of the Company. Any unauthorized alteration, forgery or falsification of the content or appearance of this document is unlawful and offenders may be prosecuted to the fullest extent of the law.

FDD Band 7								
BW(Mhz)	Modulation	RB Size	RB Offset	Frequency (MHz)	Channel	Conducted power (dBm)	Target Power + Max. Tolerance (dBm)	MPR Allowed per 3GPP(dB)
10	64-QAM	1 RB	0	2505	20800	21.65	21.8	0-1
				2535	21100	21.72	21.8	0-1
				2565	21400	21.67	21.8	0-1
			25	2505	20800	21.23	21.8	0-1
				2535	21100	21.24	21.8	0-1
				2565	21400	21.58	21.8	0-1
			49	2505	20800	21.79	21.8	0-1
				2535	21100	21.69	21.8	0-1
				2565	21400	21.76	21.8	0-1
		25 RB	0	2505	20800	20.19	20.8	0-2
				2535	21100	20.16	20.8	0-2
				2565	21400	20.23	20.8	0-2
			12	2505	20800	20.34	20.8	0-2
				2535	21100	20.27	20.8	0-2
				2565	21400	20.38	20.8	0-2
			25	2505	20800	20.31	20.8	0-2
				2535	21100	20.42	20.8	0-2
				2565	21400	20.40	20.8	0-2
			50RB	2505	20800	20.46	20.8	0-2
				2535	21100	20.44	20.8	0-2
				2565	21400	20.32	20.8	0-2

Unless otherwise stated the results shown in this test report refer only to the sample(s) tested and such sample(s) are retained for 90 days only.

除非另有說明，此報告結果僅對測試之樣品負責，同時此樣品僅保留90天。本報告未經本公司書面許可，不可部份複製。

This document is issued by the Company subject to its General Conditions of Service printed overleaf, available on request or accessible at www.sgs.com/terms_and_conditions.htm and for electronic format documents, subject to Terms and Conditions for Electronic Documents at www.sgs.com/terms_e-document.htm. Attention is drawn to the limitation of liability, indemnification and jurisdiction issues defined therein. Any holder of this document is advised that information contained hereon reflects the Company's findings at the time of its intervention only and within the limits of Client's instructions, if any. The Company's sole responsibility is to its Client and this document does not exonerate parties to a transaction from exercising all their rights and obligations under the transaction documents. This document cannot be reproduced except in full, without prior written approval of the Company. Any unauthorized alteration, forgery or falsification of the content or appearance of this document is unlawful and offenders may be prosecuted to the fullest extent of the law.

FDD Band 7									
BW(Mhz)	Modulation	RB Size	RB Offset	Frequency (MHz)	Channel	Conducted power (dBm)	Target Power + Max. Tolerance (dBm)	MPR Allowed per 3GPP(dB)	
5	QPSK	1 RB	0	2502.5	20775	22.44	22.8	0	
				2535	21100	22.62	22.8	0	
				2567.5	21425	22.49	22.8	0	
			12	2502.5	20775	22.02	22.8	0	
				2535	21100	22.21	22.8	0	
				2567.5	21425	22.37	22.8	0	
		24	2502.5	20775	22.25	22.8	0		
			2535	21100	22.41	22.8	0		
			2567.5	21425	22.48	22.8	0		
		12 RB	0	2502.5	20775	21.39	21.8	0-1	
				2535	21100	21.48	21.8	0-1	
				2567.5	21425	21.31	21.8	0-1	
			6	2502.5	20775	21.36	21.8	0-1	
				2535	21100	21.26	21.8	0-1	
				2567.5	21425	21.48	21.8	0-1	
			13	2502.5	20775	21.32	21.8	0-1	
				2535	21100	21.41	21.8	0-1	
				2567.5	21425	21.50	21.8	0-1	
		25RB	2502.5	20775	21.17	21.8	0-1		
			2535	21100	21.34	21.8	0-1		
			2567.5	21425	21.43	21.8	0-1		
		16-QAM	1 RB	0	2502.5	20775	21.50	21.8	0-1
					2535	21100	21.64	21.8	0-1
					2567.5	21425	21.57	21.8	0-1
	12			2502.5	20775	21.37	21.8	0-1	
				2535	21100	21.28	21.8	0-1	
				2567.5	21425	21.66	21.8	0-1	
	24			2502.5	20775	21.67	21.8	0-1	
				2535	21100	21.72	21.8	0-1	
				2567.5	21425	21.53	21.8	0-1	
	12 RB			0	2502.5	20775	20.20	20.8	0-2
					2535	21100	20.29	20.8	0-2
					2567.5	21425	20.42	20.8	0-2
			6	2502.5	20775	20.24	20.8	0-2	
				2535	21100	20.43	20.8	0-2	
				2567.5	21425	20.44	20.8	0-2	
			13	2502.5	20775	20.34	20.8	0-2	
				2535	21100	20.40	20.8	0-2	
				2567.5	21425	20.37	20.8	0-2	
	25RB		2502.5	20775	20.19	20.8	0-2		
			2535	21100	20.23	20.8	0-2		
			2567.5	21425	20.26	20.8	0-2		

Unless otherwise stated the results shown in this test report refer only to the sample(s) tested and such sample(s) are retained for 90 days only.

除非另有說明，此報告結果僅對測試之樣品負責，同時此樣品僅保留90天。本報告未經本公司書面許可，不可部份複製。

This document is issued by the Company subject to its General Conditions of Service printed overleaf, available on request or accessible at www.sgs.com/terms_and_conditions.htm and for electronic format documents, subject to Terms and Conditions for Electronic Documents at www.sgs.com/terms_e-document.htm. Attention is drawn to the limitation of liability, indemnification and jurisdiction issues defined therein. Any holder of this document is advised that information contained hereon reflects the Company's findings at the time of its intervention only and within the limits of Client's instructions, if any. The Company's sole responsibility is to its Client and this document does not exonerate parties to a transaction from exercising all their rights and obligations under the transaction documents. This document cannot be reproduced except in full, without prior written approval of the Company. Any unauthorized alteration, forgery or falsification of the content or appearance of this document is unlawful and offenders may be prosecuted to the fullest extent of the law.

FDD Band 7								
BW(Mhz)	Modulation	RB Size	RB Offset	Frequency (MHz)	Channel	Conducted power (dBm)	Target Power + Max. Tolerance (dBm)	MPR Allowed per 3GPP(dB)
5	64-QAM	1 RB	0	2502.5	20775	21.37	21.8	0-1
				2535	21100	21.30	21.8	0-1
				2567.5	21425	21.41	21.8	0-1
			12	2502.5	20775	21.55	21.8	0-1
				2535	21100	21.19	21.8	0-1
				2567.5	21425	21.62	21.8	0-1
			24	2502.5	20775	21.64	21.8	0-1
				2535	21100	21.53	21.8	0-1
				2567.5	21425	21.76	21.8	0-1
		12 RB	0	2502.5	20775	20.37	20.8	0-2
				2535	21100	20.42	20.8	0-2
				2567.5	21425	20.16	20.8	0-2
			6	2502.5	20775	20.42	20.8	0-2
				2535	21100	20.36	20.8	0-2
				2567.5	21425	20.45	20.8	0-2
			13	2502.5	20775	20.24	20.8	0-2
				2535	21100	20.37	20.8	0-2
				2567.5	21425	20.28	20.8	0-2
			25RB	2502.5	20775	20.24	20.8	0-2
				2535	21100	20.25	20.8	0-2
				2567.5	21425	20.38	20.8	0-2

Unless otherwise stated the results shown in this test report refer only to the sample(s) tested and such sample(s) are retained for 90 days only.

除非另有說明，此報告結果僅對測試之樣品負責，同時此樣品僅保留90天。本報告未經本公司書面許可，不可部份複製。

This document is issued by the Company subject to its General Conditions of Service printed overleaf, available on request or accessible at www.sgs.com/terms_and_conditions.htm and for electronic format documents, subject to Terms and Conditions for Electronic Documents at www.sgs.com/terms_e-document.htm. Attention is drawn to the limitation of liability, indemnification and jurisdiction issues defined therein. Any holder of this document is advised that information contained hereon reflects the Company's findings at the time of its intervention only and within the limits of Client's instructions, if any. The Company's sole responsibility is to its Client and this document does not exonerate parties to a transaction from exercising all their rights and obligations under the transaction documents. This document cannot be reproduced except in full, without prior written approval of the Company. Any unauthorized alteration, forgery or falsification of the content or appearance of this document is unlawful and offenders may be prosecuted to the fullest extent of the law.

FDD Band 12									
BW(Mhz)	Modulation	RB Size	RB Offset	Frequency (MHz)	Channel	Conducted power (dBm)	Target Power + Max. Tolerance (dBm)	MPR Allowed per 3GPP(dB)	
10	QPSK	1 RB	0	704	23060	23.86	25	0	
				707.5	23095	23.87	25	0	
				711	23130	24.04	25	0	
			25	704	23060	24.00	25	0	
				707.5	23095	24.22	25	0	
				711	23130	23.99	25	0	
			49	704	23060	24.14	25	0	
				707.5	23095	24.32	25	0	
				711	23130	23.90	25	0	
		25 RB	0	704	23060	23.09	24	0-1	
				707.5	23095	23.00	24	0-1	
				711	23130	23.05	24	0-1	
			12	704	23060	23.14	24	0-1	
				707.5	23095	23.14	24	0-1	
				711	23130	23.13	24	0-1	
			25	704	23060	23.12	24	0-1	
				707.5	23095	23.17	24	0-1	
				711	23130	23.12	24	0-1	
		50RB	704	23060	23.20	24	0-1		
			707.5	23095	23.13	24	0-1		
			711	23130	23.00	24	0-1		
		16-QAM	1 RB	0	704	23060	23.15	24	0-1
					707.5	23095	23.07	24	0-1
					711	23130	23.24	24	0-1
	25			704	23060	23.13	24	0-1	
				707.5	23095	23.32	24	0-1	
				711	23130	23.17	24	0-1	
	49			704	23060	23.42	24	0-1	
				707.5	23095	23.51	24	0-1	
				711	23130	23.42	24	0-1	
	25 RB			0	704	23060	22.10	23	0-2
					707.5	23095	22.06	23	0-2
					711	23130	22.08	23	0-2
			12	704	23060	22.02	23	0-2	
				707.5	23095	22.22	23	0-2	
				711	23130	22.09	23	0-2	
			25	704	23060	22.20	23	0-2	
				707.5	23095	22.11	23	0-2	
				711	23130	22.12	23	0-2	
	50RB		704	23060	22.16	23	0-2		
			707.5	23095	22.13	23	0-2		
			711	23130	22.07	23	0-2		

Unless otherwise stated the results shown in this test report refer only to the sample(s) tested and such sample(s) are retained for 90 days only.

除非另有說明，此報告結果僅對測試之樣品負責，同時此樣品僅保留90天。本報告未經本公司書面許可，不可部份複製。

This document is issued by the Company subject to its General Conditions of Service printed overleaf, available on request or accessible at www.sgs.com/terms_and_conditions.htm and for electronic format documents, subject to Terms and Conditions for Electronic Documents at www.sgs.com/terms_e-document.htm. Attention is drawn to the limitation of liability, indemnification and jurisdiction issues defined therein. Any holder of this document is advised that information contained hereon reflects the Company's findings at the time of its intervention only and within the limits of Client's instructions, if any. The Company's sole responsibility is to its Client and this document does not exonerate parties to a transaction from exercising all their rights and obligations under the transaction documents. This document cannot be reproduced except in full, without prior written approval of the Company. Any unauthorized alteration, forgery or falsification of the content or appearance of this document is unlawful and offenders may be prosecuted to the fullest extent of the law.

FDD Band 12								
BW(Mhz)	Modulation	RB Size	RB Offset	Frequency (MHz)	Channel	Conducted power (dBm)	Target Power + Max. Tolerance (dBm)	MPR Allowed per 3GPP(dB)
10	64-QAM	1 RB	0	704	23060	23.07	24	0-1
				707.5	23095	22.99	24	0-1
				711	23130	23.16	24	0-1
			25	704	23060	23.05	24	0-1
				707.5	23095	23.24	24	0-1
				711	23130	23.09	24	0-1
			49	704	23060	23.34	24	0-1
				707.5	23095	23.43	24	0-1
				711	23130	23.34	24	0-1
		25 RB	0	704	23060	22.02	23	0-2
				707.5	23095	21.98	23	0-2
				711	23130	22.00	23	0-2
			12	704	23060	21.94	23	0-2
				707.5	23095	22.14	23	0-2
				711	23130	22.01	23	0-2
			25	704	23060	22.12	23	0-2
				707.5	23095	22.03	23	0-2
				711	23130	22.04	23	0-2
		50RB	704	23060	22.08	23	0-2	
			707.5	23095	22.05	23	0-2	
			711	23130	21.99	23	0-2	

Unless otherwise stated the results shown in this test report refer only to the sample(s) tested and such sample(s) are retained for 90 days only.

除非另有說明，此報告結果僅對測試之樣品負責，同時此樣品僅保留90天。本報告未經本公司書面許可，不可部份複製。

This document is issued by the Company subject to its General Conditions of Service printed overleaf, available on request or accessible at www.sgs.com/terms_and_conditions.htm and for electronic format documents, subject to Terms and Conditions for Electronic Documents at www.sgs.com/terms_e-document.htm. Attention is drawn to the limitation of liability, indemnification and jurisdiction issues defined therein. Any holder of this document is advised that information contained hereon reflects the Company's findings at the time of its intervention only and within the limits of Client's instructions, if any. The Company's sole responsibility is to its Client and this document does not exonerate parties to a transaction from exercising all their rights and obligations under the transaction documents. This document cannot be reproduced except in full, without prior written approval of the Company. Any unauthorized alteration, forgery or falsification of the content or appearance of this document is unlawful and offenders may be prosecuted to the fullest extent of the law.

FDD Band 12									
BW(Mhz)	Modulation	RB Size	RB Offset	Frequency (MHz)	Channel	Conducted power (dBm)	Target Power + Max. Tolerance (dBm)	MPR Allowed per 3GPP(dB)	
5	QPSK	1 RB	0	701.5	23035	23.63	25	0	
				707.5	23095	23.68	25	0	
				713.5	23155	23.88	25	0	
			12	701.5	23035	23.94	25	0	
				707.5	23095	24.08	25	0	
				713.5	23155	23.92	25	0	
		24	701.5	23035	23.98	25	0		
			707.5	23095	24.14	25	0		
			713.5	23155	23.85	25	0		
		12 RB	0	701.5	23035	22.84	24	0-1	
				707.5	23095	22.80	24	0-1	
				713.5	23155	22.84	24	0-1	
			6	701.5	23035	23.04	24	0-1	
				707.5	23095	22.98	24	0-1	
				713.5	23155	23.10	24	0-1	
			13	701.5	23035	22.88	24	0-1	
				707.5	23095	22.87	24	0-1	
				713.5	23155	22.84	24	0-1	
			25RB	701.5	23035	23.08	24	0-1	
				707.5	23095	23.02	24	0-1	
				713.5	23155	22.97	24	0-1	
		16-QAM	1 RB	0	701.5	23035	23.11	24	0-1
					707.5	23095	23.02	24	0-1
					713.5	23155	23.17	24	0-1
	12			701.5	23035	23.13	24	0-1	
				707.5	23095	23.31	24	0-1	
				713.5	23155	22.99	24	0-1	
	24			701.5	23035	23.23	24	0-1	
				707.5	23095	23.41	24	0-1	
				713.5	23155	23.41	24	0-1	
	12 RB			0	701.5	23035	22.06	23	0-2
					707.5	23095	21.81	23	0-2
					713.5	23155	21.83	23	0-2
			6	701.5	23035	21.98	23	0-2	
				707.5	23095	22.07	23	0-2	
				713.5	23155	21.98	23	0-2	
			13	701.5	23035	21.96	23	0-2	
				707.5	23095	22.04	23	0-2	
				713.5	23155	21.92	23	0-2	
	25RB		701.5	23035	21.87	23	0-2		
			707.5	23095	22.01	23	0-2		
			713.5	23155	22.07	23	0-2		

Unless otherwise stated the results shown in this test report refer only to the sample(s) tested and such sample(s) are retained for 90 days only.

除非另有說明，此報告結果僅對測試之樣品負責，同時此樣品僅保留90天。本報告未經本公司書面許可，不可部份複製。

This document is issued by the Company subject to its General Conditions of Service printed overleaf, available on request or accessible at www.sgs.com/terms_and_conditions.htm and for electronic format documents, subject to Terms and Conditions for Electronic Documents at www.sgs.com/terms_e-document.htm. Attention is drawn to the limitation of liability, indemnification and jurisdiction issues defined therein. Any holder of this document is advised that information contained hereon reflects the Company's findings at the time of its intervention only and within the limits of Client's instructions, if any. The Company's sole responsibility is to its Client and this document does not exonerate parties to a transaction from exercising all their rights and obligations under the transaction documents. This document cannot be reproduced except in full, without prior written approval of the Company. Any unauthorized alteration, forgery or falsification of the content or appearance of this document is unlawful and offenders may be prosecuted to the fullest extent of the law.

FDD Band 12								
BW(Mhz)	Modulation	RB Size	RB Offset	Frequency (MHz)	Channel	Conducted power (dBm)	Target Power + Max. Tolerance (dBm)	MPR Allowed per 3GPP(dB)
5	64-QAM	1 RB	0	701.5	23035	22.95	24	0-1
				707.5	23095	22.89	24	0-1
				713.5	23155	22.96	24	0-1
			12	701.5	23035	22.93	24	0-1
				707.5	23095	23.01	24	0-1
				713.5	23155	22.84	24	0-1
			24	701.5	23035	23.10	24	0-1
				707.5	23095	23.35	24	0-1
				713.5	23155	23.25	24	0-1
		12 RB	0	701.5	23035	21.92	23	0-2
				707.5	23095	21.76	23	0-2
				713.5	23155	21.95	23	0-2
			6	701.5	23035	21.67	23	0-2
				707.5	23095	21.85	23	0-2
				713.5	23155	21.79	23	0-2
			13	701.5	23035	22.02	23	0-2
				707.5	23095	21.94	23	0-2
				713.5	23155	21.92	23	0-2
			25RB	701.5	23035	21.87	23	0-2
				707.5	23095	21.93	23	0-2
				713.5	23155	21.78	23	0-2

Unless otherwise stated the results shown in this test report refer only to the sample(s) tested and such sample(s) are retained for 90 days only.

除非另有說明，此報告結果僅對測試之樣品負責，同時此樣品僅保留90天。本報告未經本公司書面許可，不可部份複製。

This document is issued by the Company subject to its General Conditions of Service printed overleaf, available on request or accessible at www.sgs.com/terms_and_conditions.htm and for electronic format documents, subject to Terms and Conditions for Electronic Documents at www.sgs.com/terms_e-document.htm. Attention is drawn to the limitation of liability, indemnification and jurisdiction issues defined therein. Any holder of this document is advised that information contained hereon reflects the Company's findings at the time of its intervention only and within the limits of Client's instructions, if any. The Company's sole responsibility is to its Client and this document does not exonerate parties to a transaction from exercising all their rights and obligations under the transaction documents. This document cannot be reproduced except in full, without prior written approval of the Company. Any unauthorized alteration, forgery or falsification of the content or appearance of this document is unlawful and offenders may be prosecuted to the fullest extent of the law.

FDD Band 12									
BW(Mhz)	Modulation	RB Size	RB Offset	Frequency (MHz)	Channel	Conducted power (dBm)	Target Power + Max. Tolerance (dBm)	MPR Allowed per 3GPP(dB)	
3	QPSK	1 RB	0	700.5	23025	23.66	25	0	
				707.5	23095	23.62	25	0	
				714.5	23165	23.75	25	0	
			7	700.5	23025	23.94	25	0	
				707.5	23095	24.13	25	0	
				714.5	23165	23.99	25	0	
		14	700.5	23025	23.95	25	0		
			707.5	23095	24.12	25	0		
			714.5	23165	23.86	25	0		
		8 RB	0	700.5	23025	23.09	24	0-1	
				707.5	23095	22.99	24	0-1	
				714.5	23165	22.85	24	0-1	
			4	700.5	23025	22.98	24	0-1	
				707.5	23095	22.84	24	0-1	
				714.5	23165	23.05	24	0-1	
		7	700.5	23025	23.02	24	0-1		
			707.5	23095	23.12	24	0-1		
			714.5	23165	22.88	24	0-1		
		15RB	700.5	23025	23.11	24	0-1		
			707.5	23095	22.86	24	0-1		
			714.5	23165	22.92	24	0-1		
		16-QAM	1 RB	0	700.5	23025	23.09	24	0-1
					707.5	23095	23.00	24	0-1
					714.5	23165	23.15	24	0-1
	7			700.5	23025	22.85	24	0-1	
				707.5	23095	23.26	24	0-1	
				714.5	23165	23.04	24	0-1	
	14			700.5	23025	23.27	24	0-1	
				707.5	23095	23.43	24	0-1	
				714.5	23165	23.14	24	0-1	
	8 RB			0	700.5	23025	21.96	23	0-2
					707.5	23095	22.03	23	0-2
					714.5	23165	22.03	23	0-2
			4	700.5	23025	21.97	23	0-2	
				707.5	23095	22.20	23	0-2	
				714.5	23165	21.88	23	0-2	
	7		700.5	23025	21.98	23	0-2		
			707.5	23095	21.96	23	0-2		
			714.5	23165	21.84	23	0-2		
	15RB		700.5	23025	22.07	23	0-2		
			707.5	23095	22.03	23	0-2		
			714.5	23165	21.97	23	0-2		

Unless otherwise stated the results shown in this test report refer only to the sample(s) tested and such sample(s) are retained for 90 days only.

除非另有說明，此報告結果僅對測試之樣品負責，同時此樣品僅保留90天。本報告未經本公司書面許可，不可部份複製。

This document is issued by the Company subject to its General Conditions of Service printed overleaf, available on request or accessible at www.sgs.com/terms_and_conditions.htm and for electronic format documents, subject to Terms and Conditions for Electronic Documents at www.sgs.com/terms_e-document.htm. Attention is drawn to the limitation of liability, indemnification and jurisdiction issues defined therein. Any holder of this document is advised that information contained hereon reflects the Company's findings at the time of its intervention only and within the limits of Client's instructions, if any. The Company's sole responsibility is to its Client and this document does not exonerate parties to a transaction from exercising all their rights and obligations under the transaction documents. This document cannot be reproduced except in full, without prior written approval of the Company. Any unauthorized alteration, forgery or falsification of the content or appearance of this document is unlawful and offenders may be prosecuted to the fullest extent of the law.

FDD Band 12								
BW(Mhz)	Modulation	RB Size	RB Offset	Frequency (MHz)	Channel	Conducted power (dBm)	Target Power + Max. Tolerance (dBm)	MPR Allowed per 3GPP(dB)
3	64-QAM	1 RB	0	700.5	23025	22.81	24	0-1
				707.5	23095	22.84	24	0-1
				714.5	23165	23.05	24	0-1
			7	700.5	23025	22.86	24	0-1
				707.5	23095	23.12	24	0-1
				714.5	23165	22.85	24	0-1
			14	700.5	23025	23.17	24	0-1
				707.5	23095	23.40	24	0-1
				714.5	23165	23.30	24	0-1
		8 RB	0	700.5	23025	21.78	23	0-2
				707.5	23095	21.75	23	0-2
				714.5	23165	21.74	23	0-2
			4	700.5	23025	21.74	23	0-2
				707.5	23095	21.85	23	0-2
				714.5	23165	21.73	23	0-2
			7	700.5	23025	22.03	23	0-2
				707.5	23095	21.80	23	0-2
				714.5	23165	22.03	23	0-2
		15RB	700.5	23025	22.05	23	0-2	
			707.5	23095	21.97	23	0-2	
			714.5	23165	21.94	23	0-2	

Unless otherwise stated the results shown in this test report refer only to the sample(s) tested and such sample(s) are retained for 90 days only.

除非另有說明，此報告結果僅對測試之樣品負責，同時此樣品僅保留90天。本報告未經本公司書面許可，不可部份複製。

This document is issued by the Company subject to its General Conditions of Service printed overleaf, available on request or accessible at www.sgs.com/terms_and_conditions.htm and for electronic format documents, subject to Terms and Conditions for Electronic Documents at www.sgs.com/terms_e-document.htm. Attention is drawn to the limitation of liability, indemnification and jurisdiction issues defined therein. Any holder of this document is advised that information contained hereon reflects the Company's findings at the time of its intervention only and within the limits of Client's instructions, if any. The Company's sole responsibility is to its Client and this document does not exonerate parties to a transaction from exercising all their rights and obligations under the transaction documents. This document cannot be reproduced except in full, without prior written approval of the Company. Any unauthorized alteration, forgery or falsification of the content or appearance of this document is unlawful and offenders may be prosecuted to the fullest extent of the law.

FDD Band 12									
BW(Mhz)	Modulation	RB Size	RB Offset	Frequency (MHz)	Channel	Conducted power (dBm)	Target Power + Max. Tolerance (dBm)	MPR Allowed per 3GPP(dB)	
1.4	QPSK	1 RB	0	699.7	23017	23.76	25	0	
				707.5	23095	23.84	25	0	
				715.3	23173	23.82	25	0	
			2	699.7	23017	23.74	25	0	
				707.5	23095	24.22	25	0	
				715.3	23173	23.88	25	0	
		5	699.7	23017	23.92	25	0		
			707.5	23095	24.05	25	0		
			715.3	23173	23.65	25	0		
		3 RB	0	699.7	23017	22.87	24	0-1	
				707.5	23095	22.89	24	0-1	
				715.3	23173	22.80	24	0-1	
			2	699.7	23017	23.11	24	0-1	
				707.5	23095	22.85	24	0-1	
				715.3	23173	23.02	24	0-1	
			3	699.7	23017	22.91	24	0-1	
				707.5	23095	23.08	24	0-1	
				715.3	23173	23.00	24	0-1	
		6RB	699.7	23017	23.09	24	0-1		
			707.5	23095	22.86	24	0-1		
			715.3	23173	22.79	24	0-1		
		16-QAM	1 RB	0	699.7	23017	22.97	24	0-1
					707.5	23095	22.82	24	0-1
					715.3	23173	23.11	24	0-1
	2			699.7	23017	22.98	24	0-1	
				707.5	23095	23.16	24	0-1	
				715.3	23173	23.16	24	0-1	
	5			699.7	23017	23.36	24	0-1	
				707.5	23095	23.24	24	0-1	
				715.3	23173	23.16	24	0-1	
	3 RB			0	699.7	23017	21.80	23	0-2
					707.5	23095	22.03	23	0-2
					715.3	23173	22.02	23	0-2
			2	699.7	23017	22.01	23	0-2	
				707.5	23095	22.04	23	0-2	
				715.3	23173	21.87	23	0-2	
			3	699.7	23017	22.02	23	0-2	
				707.5	23095	21.94	23	0-2	
				715.3	23173	21.86	23	0-2	
	6RB		699.7	23017	21.92	23	0-2		
			707.5	23095	22.11	23	0-2		
			715.3	23173	21.95	23	0-2		

Unless otherwise stated the results shown in this test report refer only to the sample(s) tested and such sample(s) are retained for 90 days only.

除非另有說明，此報告結果僅對測試之樣品負責，同時此樣品僅保留90天。本報告未經本公司書面許可，不可部份複製。

This document is issued by the Company subject to its General Conditions of Service printed overleaf, available on request or accessible at www.sgs.com/terms_and_conditions.htm and for electronic format documents, subject to Terms and Conditions for Electronic Documents at www.sgs.com/terms_e-document.htm. Attention is drawn to the limitation of liability, indemnification and jurisdiction issues defined therein. Any holder of this document is advised that information contained hereon reflects the Company's findings at the time of its intervention only and within the limits of Client's instructions, if any. The Company's sole responsibility is to its Client and this document does not exonerate parties to a transaction from exercising all their rights and obligations under the transaction documents. This document cannot be reproduced except in full, without prior written approval of the Company. Any unauthorized alteration, forgery or falsification of the content or appearance of this document is unlawful and offenders may be prosecuted to the fullest extent of the law.

FDD Band 12								
BW(Mhz)	Modulation	RB Size	RB Offset	Frequency (MHz)	Channel	Conducted power (dBm)	Target Power + Max. Tolerance (dBm)	MPR Allowed per 3GPP(dB)
1.4	64-QAM	1 RB	0	699.7	23017	23.04	24	0-1
				707.5	23095	22.97	24	0-1
				715.3	23173	23.16	24	0-1
			2	699.7	23017	23.03	24	0-1
				707.5	23095	23.19	24	0-1
				715.3	23173	23.04	24	0-1
			5	699.7	23017	23.16	24	0-1
				707.5	23095	23.15	24	0-1
				715.3	23173	23.22	24	0-1
		3 RB	0	699.7	23017	21.89	23	0-2
				707.5	23095	21.72	23	0-2
				715.3	23173	21.92	23	0-2
			2	699.7	23017	21.66	23	0-2
				707.5	23095	21.94	23	0-2
				715.3	23173	21.74	23	0-2
			3	699.7	23017	21.98	23	0-2
				707.5	23095	21.92	23	0-2
				715.3	23173	21.85	23	0-2
		6RB	699.7	23017	22.06	23	0-2	
			707.5	23095	21.93	23	0-2	
			715.3	23173	21.80	23	0-2	

Unless otherwise stated the results shown in this test report refer only to the sample(s) tested and such sample(s) are retained for 90 days only.

除非另有說明，此報告結果僅對測試之樣品負責，同時此樣品僅保留90天。本報告未經本公司書面許可，不可部份複製。

This document is issued by the Company subject to its General Conditions of Service printed overleaf, available on request or accessible at www.sgs.com/terms_and_conditions.htm and for electronic format documents, subject to Terms and Conditions for Electronic Documents at www.sgs.com/terms_e-document.htm. Attention is drawn to the limitation of liability, indemnification and jurisdiction issues defined therein. Any holder of this document is advised that information contained hereon reflects the Company's findings at the time of its intervention only and within the limits of Client's instructions, if any. The Company's sole responsibility is to its Client and this document does not exonerate parties to a transaction from exercising all their rights and obligations under the transaction documents. This document cannot be reproduced except in full, without prior written approval of the Company. Any unauthorized alteration, forgery or falsification of the content or appearance of this document is unlawful and offenders may be prosecuted to the fullest extent of the law.

FDD Band 13									
BW(Mhz)	Modulation	RB Size	RB Offset	Frequency (MHz)	Channel	Conducted power (dBm)	Target Power + Max. Tolerance (dBm)	MPR Allowed per 3GPP(dB)	
10	QPSK	1 RB	0	782	23230	23.99	25	0	
			25	782	23230	24.12	25	0	
			49	782	23230	24.15	25	0	
		25 RB	0	782	23230	23.19	24	0-1	
			12	782	23230	23.11	24	0-1	
			25	782	23230	23.10	24	0-1	
		50RB			782	23230	23.21	24	0-1
		16-QAM	1 RB	0	782	23230	23.37	24	0-1
				25	782	23230	23.54	24	0-1
	49			782	23230	23.38	24	0-1	
	25 RB		0	782	23230	22.28	23	0-2	
			12	782	23230	22.23	23	0-2	
			25	782	23230	22.08	23	0-2	
	50RB			782	23230	22.14	23	0-2	
	64-QAM		1 RB	0	782	23230	23.22	24	0-1
				25	782	23230	23.39	24	0-1
		49		782	23230	23.23	24	0-1	
		25 RB	0	782	23230	22.13	23	0-2	
			12	782	23230	22.08	23	0-2	
			25	782	23230	21.93	23	0-2	
		50RB			782	23230	21.99	23	0-2

Unless otherwise stated the results shown in this test report refer only to the sample(s) tested and such sample(s) are retained for 90 days only.

除非另有說明，此報告結果僅對測試之樣品負責，同時此樣品僅保留90天。本報告未經本公司書面許可，不可部份複製。

This document is issued by the Company subject to its General Conditions of Service printed overleaf, available on request or accessible at www.sgs.com/terms_and_conditions.htm and for electronic format documents, subject to Terms and Conditions for Electronic Documents at www.sgs.com/terms_e-document.htm. Attention is drawn to the limitation of liability, indemnification and jurisdiction issues defined therein. Any holder of this document is advised that information contained hereon reflects the Company's findings at the time of its intervention only and within the limits of Client's instructions, if any. The Company's sole responsibility is to its Client and this document does not exonerate parties to a transaction from exercising all their rights and obligations under the transaction documents. This document cannot be reproduced except in full, without prior written approval of the Company. Any unauthorized alteration, forgery or falsification of the content or appearance of this document is unlawful and offenders may be prosecuted to the fullest extent of the law.

FDD Band 13									
BW(Mhz)	Modulation	RB Size	RB Offset	Frequency (MHz)	Channel	Conducted power (dBm)	Target Power + Max. Tolerance (dBm)	MPR Allowed per 3GPP(dB)	
5	QPSK	1 RB	0	779.5	23205	23.74	25	0	
				782	23230	23.85	25	0	
				784.5	23255	23.96	25	0	
			12	779.5	23205	24.06	25	0	
				782	23230	24.06	25	0	
				784.5	23255	23.96	25	0	
		24	779.5	23205	23.91	25	0		
			782	23230	24.01	25	0		
			784.5	23255	24.05	25	0		
		12 RB	0	779.5	23205	23.01	24	0-1	
				782	23230	22.90	24	0-1	
				784.5	23255	22.99	24	0-1	
			6	779.5	23205	22.82	24	0-1	
				782	23230	22.83	24	0-1	
				784.5	23255	22.92	24	0-1	
		13	779.5	23205	22.96	24	0-1		
			782	23230	23.08	24	0-1		
			784.5	23255	22.93	24	0-1		
		25RB	779.5	23205	22.92	24	0-1		
			782	23230	23.03	24	0-1		
			784.5	23255	23.10	24	0-1		
		16-QAM	1 RB	0	779.5	23205	23.10	24	0-1
					782	23230	23.40	24	0-1
					784.5	23255	23.23	24	0-1
	12			779.5	23205	23.53	24	0-1	
				782	23230	23.25	24	0-1	
				784.5	23255	23.35	24	0-1	
	24			779.5	23205	23.18	24	0-1	
				782	23230	23.16	24	0-1	
				784.5	23255	23.22	24	0-1	
	12 RB			0	779.5	23205	22.16	23	0-2
					782	23230	22.07	23	0-2
					784.5	23255	22.10	23	0-2
			6	779.5	23205	22.22	23	0-2	
				782	23230	22.14	23	0-2	
				784.5	23255	22.09	23	0-2	
	13		779.5	23205	22.03	23	0-2		
			782	23230	22.02	23	0-2		
			784.5	23255	22.04	23	0-2		
	25RB		779.5	23205	22.06	23	0-2		
			782	23230	22.02	23	0-2		
			784.5	23255	22.05	23	0-2		

Unless otherwise stated the results shown in this test report refer only to the sample(s) tested and such sample(s) are retained for 90 days only.

除非另有說明，此報告結果僅對測試之樣品負責，同時此樣品僅保留90天。本報告未經本公司書面許可，不可部份複製。

This document is issued by the Company subject to its General Conditions of Service printed overleaf, available on request or accessible at www.sgs.com/terms_and_conditions.htm and for electronic format documents, subject to Terms and Conditions for Electronic Documents at www.sgs.com/terms_e-document.htm. Attention is drawn to the limitation of liability, indemnification and jurisdiction issues defined therein. Any holder of this document is advised that information contained hereon reflects the Company's findings at the time of its intervention only and within the limits of Client's instructions, if any. The Company's sole responsibility is to its Client and this document does not exonerate parties to a transaction from exercising all their rights and obligations under the transaction documents. This document cannot be reproduced except in full, without prior written approval of the Company. Any unauthorized alteration, forgery or falsification of the content or appearance of this document is unlawful and offenders may be prosecuted to the fullest extent of the law.

FDD Band 13								
BW(Mhz)	Modulation	RB Size	RB Offset	Frequency (MHz)	Channel	Conducted power (dBm)	Target Power + Max. Tolerance (dBm)	MPR Allowed per 3GPP(dB)
5	64-QAM	1 RB	0	779.5	23205	23.16	24	0-1
				782	23230	23.25	24	0-1
				784.5	23255	23.11	24	0-1
			12	779.5	23205	23.16	24	0-1
				782	23230	23.18	24	0-1
				784.5	23255	23.15	24	0-1
			24	779.5	23205	23.10	24	0-1
				782	23230	23.21	24	0-1
				784.5	23255	23.09	24	0-1
		12 RB	0	779.5	23205	22.00	23	0-2
				782	23230	21.93	23	0-2
				784.5	23255	22.09	23	0-2
			6	779.5	23205	21.93	23	0-2
				782	23230	21.92	23	0-2
				784.5	23255	22.08	23	0-2
			13	779.5	23205	21.85	23	0-2
				782	23230	21.83	23	0-2
				784.5	23255	21.88	23	0-2
		25RB	779.5	23205	21.79	23	0-2	
			782	23230	21.80	23	0-2	
			784.5	23255	21.81	23	0-2	

Unless otherwise stated the results shown in this test report refer only to the sample(s) tested and such sample(s) are retained for 90 days only.

除非另有說明，此報告結果僅對測試之樣品負責，同時此樣品僅保留90天。本報告未經本公司書面許可，不可部份複製。

This document is issued by the Company subject to its General Conditions of Service printed overleaf, available on request or accessible at www.sgs.com/terms_and_conditions.htm and for electronic format documents, subject to Terms and Conditions for Electronic Documents at www.sgs.com/terms_e-document.htm. Attention is drawn to the limitation of liability, indemnification and jurisdiction issues defined therein. Any holder of this document is advised that information contained hereon reflects the Company's findings at the time of its intervention only and within the limits of Client's instructions, if any. The Company's sole responsibility is to its Client and this document does not exonerate parties to a transaction from exercising all their rights and obligations under the transaction documents. This document cannot be reproduced except in full, without prior written approval of the Company. Any unauthorized alteration, forgery or falsification of the content or appearance of this document is unlawful and offenders may be prosecuted to the fullest extent of the law.

FDD Band 14									
BW(Mhz)	Modulation	RB Size	RB Offset	Frequency (MHz)	Channel	Conducted power (dBm)	Target Power + Max. Tolerance (dBm)	MPR Allowed per 3GPP(dB)	
10	QPSK	1 RB	0	793	23330	24.12	25	0	
			25	793	23330	24.10	25	0	
			49	793	23330	24.18	25	0	
		25 RB	0	793	23330	23.29	24	0-1	
			12	793	23330	23.21	24	0-1	
			25	793	23330	23.15	24	0-1	
		50RB		793	23330	23.17	24	0-1	
		16-QAM	1 RB	0	793	23330	23.59	24	0-1
				25	793	23330	23.12	24	0-1
	49			793	23330	23.24	24	0-1	
	25 RB		0	793	23330	22.35	23	0-2	
			12	793	23330	22.28	23	0-2	
			25	793	23330	22.11	23	0-2	
	50RB		793	23330	22.15	23	0-2		
	64-QAM		1 RB	0	793	23330	23.36	24	0-1
				25	793	23330	22.89	24	0-1
		49		793	23330	23.01	24	0-1	
		25 RB	0	793	23330	22.12	23	0-2	
			12	793	23330	22.05	23	0-2	
			25	793	23330	21.88	23	0-2	
		50RB		793	23330	21.92	23	0-2	

Unless otherwise stated the results shown in this test report refer only to the sample(s) tested and such sample(s) are retained for 90 days only.

除非另有說明，此報告結果僅對測試之樣品負責，同時此樣品僅保留90天。本報告未經本公司書面許可，不可部份複製。

This document is issued by the Company subject to its General Conditions of Service printed overleaf, available on request or accessible at www.sgs.com/terms_and_conditions.htm and for electronic format documents, subject to Terms and Conditions for Electronic Documents at www.sgs.com/terms_e-document.htm. Attention is drawn to the limitation of liability, indemnification and jurisdiction issues defined therein. Any holder of this document is advised that information contained hereon reflects the Company's findings at the time of its intervention only and within the limits of Client's instructions, if any. The Company's sole responsibility is to its Client and this document does not exonerate parties to a transaction from exercising all their rights and obligations under the transaction documents. This document cannot be reproduced except in full, without prior written approval of the Company. Any unauthorized alteration, forgery or falsification of the content or appearance of this document is unlawful and offenders may be prosecuted to the fullest extent of the law.

FDD Band 14									
BW(Mhz)	Modulation	RB Size	RB Offset	Frequency (MHz)	Channel	Conducted power (dBm)	Target Power + Max. Tolerance (dBm)	MPR Allowed per 3GPP(dB)	
5	QPSK	1 RB	0	790.5	23305	23.98	25	0	
				793	23330	23.88	25	0	
				795.5	23355	23.82	25	0	
			12	790.5	23305	24.02	25	0	
				793	23330	24.04	25	0	
				795.5	23355	23.85	25	0	
		24	790.5	23305	24.15	25	0		
			793	23330	24.12	25	0		
			795.5	23355	24.08	25	0		
		12 RB	0	790.5	23305	23.16	24	0-1	
				793	23330	23.12	24	0-1	
				795.5	23355	23.04	24	0-1	
			6	790.5	23305	23.16	24	0-1	
				793	23330	23.16	24	0-1	
				795.5	23355	23.13	24	0-1	
			13	790.5	23305	23.12	24	0-1	
				793	23330	23.21	24	0-1	
				795.5	23355	23.06	24	0-1	
			25RB	790.5	23305	23.11	24	0-1	
				793	23330	23.10	24	0-1	
				795.5	23355	23.16	24	0-1	
		16-QAM	1 RB	0	790.5	23305	23.29	24	0-1
					793	23330	23.32	24	0-1
					795.5	23355	23.51	24	0-1
	12			790.5	23305	22.99	24	0-1	
				793	23330	22.96	24	0-1	
				795.5	23355	22.99	24	0-1	
	24			790.5	23305	22.87	24	0-1	
				793	23330	22.94	24	0-1	
				795.5	23355	22.96	24	0-1	
	12 RB			0	790.5	23305	22.29	23	0-2
					793	23330	22.27	23	0-2
					795.5	23355	22.19	23	0-2
			6	790.5	23305	22.27	23	0-2	
				793	23330	22.06	23	0-2	
				795.5	23355	22.14	23	0-2	
			13	790.5	23305	21.94	23	0-2	
				793	23330	22.00	23	0-2	
				795.5	23355	22.03	23	0-2	
	25RB		790.5	23305	21.88	23	0-2		
			793	23330	22.08	23	0-2		
			795.5	23355	22.06	23	0-2		

Unless otherwise stated the results shown in this test report refer only to the sample(s) tested and such sample(s) are retained for 90 days only.

除非另有說明，此報告結果僅對測試之樣品負責，同時此樣品僅保留90天。本報告未經本公司書面許可，不可部份複製。

This document is issued by the Company subject to its General Conditions of Service printed overleaf, available on request or accessible at www.sgs.com/terms_and_conditions.htm and for electronic format documents, subject to Terms and Conditions for Electronic Documents at www.sgs.com/terms_e-document.htm. Attention is drawn to the limitation of liability, indemnification and jurisdiction issues defined therein. Any holder of this document is advised that information contained hereon reflects the Company's findings at the time of its intervention only and within the limits of Client's instructions, if any. The Company's sole responsibility is to its Client and this document does not exonerate parties to a transaction from exercising all their rights and obligations under the transaction documents. This document cannot be reproduced except in full, without prior written approval of the Company. Any unauthorized alteration, forgery or falsification of the content or appearance of this document is unlawful and offenders may be prosecuted to the fullest extent of the law.

FDD Band 14								
BW(Mhz)	Modulation	RB Size	RB Offset	Frequency (MHz)	Channel	Conducted power (dBm)	Target Power + Max. Tolerance (dBm)	MPR Allowed per 3GPP(dB)
5	64-QAM	1 RB	0	790.5	23305	23.24	24	0-1
				793	23330	23.20	24	0-1
				795.5	23355	23.26	24	0-1
			12	790.5	23305	22.74	24	0-1
				793	23330	22.72	24	0-1
				795.5	23355	22.66	24	0-1
			24	790.5	23305	22.88	24	0-1
				793	23330	22.71	24	0-1
				795.5	23355	22.96	24	0-1
		12 RB	0	790.5	23305	21.87	23	0-2
				793	23330	22.01	23	0-2
				795.5	23355	21.81	23	0-2
			6	790.5	23305	21.69	23	0-2
				793	23330	21.94	23	0-2
				795.5	23355	22.04	23	0-2
			13	790.5	23305	21.62	23	0-2
				793	23330	21.77	23	0-2
				795.5	23355	21.96	23	0-2
		25RB	790.5	23305	22.04	23	0-2	
			793	23330	21.80	23	0-2	
			795.5	23355	21.69	23	0-2	

Unless otherwise stated the results shown in this test report refer only to the sample(s) tested and such sample(s) are retained for 90 days only.

除非另有說明，此報告結果僅對測試之樣品負責，同時此樣品僅保留90天。本報告未經本公司書面許可，不可部份複製。

This document is issued by the Company subject to its General Conditions of Service printed overleaf, available on request or accessible at www.sgs.com/terms_and_conditions.htm and for electronic format documents, subject to Terms and Conditions for Electronic Documents at www.sgs.com/terms_e-document.htm. Attention is drawn to the limitation of liability, indemnification and jurisdiction issues defined therein. Any holder of this document is advised that information contained hereon reflects the Company's findings at the time of its intervention only and within the limits of Client's instructions, if any. The Company's sole responsibility is to its Client and this document does not exonerate parties to a transaction from exercising all their rights and obligations under the transaction documents. This document cannot be reproduced except in full, without prior written approval of the Company. Any unauthorized alteration, forgery or falsification of the content or appearance of this document is unlawful and offenders may be prosecuted to the fullest extent of the law.

FDD Band 25									
BW(Mhz)	Modulation	RB Size	RB Offset	Frequency (MHz)	Channel	Conducted power (dBm)	Target Power + Max. Tolerance (dBm)	MPR Allowed per 3GPP(dB)	
20	QPSK	1 RB	0	1860	26140	24.49	25	0	
				1882.5	26365	24.14	25	0	
				1905	26590	24.48	25	0	
			50	1860	26140	23.76	25	0	
				1882.5	26365	23.71	25	0	
				1905	26590	23.97	25	0	
			99	1860	26140	24.05	25	0	
				1882.5	26365	24.08	25	0	
				1905	26590	24.26	25	0	
		50 RB	0	1860	26140	23.01	24	0-1	
				1882.5	26365	23.02	24	0-1	
				1905	26590	23.32	24	0-1	
			25	1860	26140	22.94	24	0-1	
				1882.5	26365	22.88	24	0-1	
				1905	26590	23.21	24	0-1	
			50	1860	26140	22.97	24	0-1	
				1882.5	26365	22.99	24	0-1	
				1905	26590	23.30	24	0-1	
		100RB	1860	26140	22.98	24	0-1		
			1882.5	26365	22.97	24	0-1		
			1905	26590	23.16	24	0-1		
		16-QAM	1 RB	0	1860	26140	23.40	24	0-1
					1882.5	26365	23.67	24	0-1
					1905	26590	23.39	24	0-1
	50			1860	26140	23.40	24	0-1	
				1882.5	26365	23.22	24	0-1	
				1905	26590	23.45	24	0-1	
	99			1860	26140	23.22	24	0-1	
				1882.5	26365	23.27	24	0-1	
				1905	26590	23.44	24	0-1	
	50 RB			0	1860	26140	22.00	23	0-2
					1882.5	26365	22.05	23	0-2
					1905	26590	22.21	23	0-2
			25	1860	26140	21.99	23	0-2	
				1882.5	26365	21.91	23	0-2	
				1905	26590	22.19	23	0-2	
			50	1860	26140	22.07	23	0-2	
				1882.5	26365	22.02	23	0-2	
				1905	26590	22.27	23	0-2	
	100RB		1860	26140	21.99	23	0-2		
			1882.5	26365	21.88	23	0-2		
			1905	26590	22.15	23	0-2		

Unless otherwise stated the results shown in this test report refer only to the sample(s) tested and such sample(s) are retained for 90 days only.

除非另有說明，此報告結果僅對測試之樣品負責，同時此樣品僅保留90天。本報告未經本公司書面許可，不可部份複製。

This document is issued by the Company subject to its General Conditions of Service printed overleaf, available on request or accessible at www.sgs.com/terms_and_conditions.htm and for electronic format documents, subject to Terms and Conditions for Electronic Documents at www.sgs.com/terms_e-document.htm. Attention is drawn to the limitation of liability, indemnification and jurisdiction issues defined therein. Any holder of this document is advised that information contained hereon reflects the Company's findings at the time of its intervention only and within the limits of Client's instructions, if any. The Company's sole responsibility is to its Client and this document does not exonerate parties to a transaction from exercising all their rights and obligations under the transaction documents. This document cannot be reproduced except in full, without prior written approval of the Company. Any unauthorized alteration, forgery or falsification of the content or appearance of this document is unlawful and offenders may be prosecuted to the fullest extent of the law.

FDD Band 25								
BW(Mhz)	Modulation	RB Size	RB Offset	Frequency (MHz)	Channel	Conducted power (dBm)	Target Power + Max. Tolerance (dBm)	MPR Allowed per 3GPP(dB)
20	64-QAM	1 RB	0	1860	26140	23.23	24	0-1
				1882.5	26365	23.50	24	0-1
				1905	26590	23.22	24	0-1
			50	1860	26140	23.23	24	0-1
				1882.5	26365	23.05	24	0-1
				1905	26590	23.28	24	0-1
			99	1860	26140	23.05	24	0-1
				1882.5	26365	23.10	24	0-1
				1905	26590	23.27	24	0-1
		50 RB	0	1860	26140	21.83	23	0-2
				1882.5	26365	21.88	23	0-2
				1905	26590	22.04	23	0-2
			25	1860	26140	21.82	23	0-2
				1882.5	26365	21.74	23	0-2
				1905	26590	22.02	23	0-2
			50	1860	26140	21.90	23	0-2
				1882.5	26365	21.85	23	0-2
				1905	26590	22.10	23	0-2
			100RB	1860	26140	21.82	23	0-2
				1882.5	26365	21.71	23	0-2
				1905	26590	21.98	23	0-2

Unless otherwise stated the results shown in this test report refer only to the sample(s) tested and such sample(s) are retained for 90 days only.

除非另有說明，此報告結果僅對測試之樣品負責，同時此樣品僅保留90天。本報告未經本公司書面許可，不可部份複製。

This document is issued by the Company subject to its General Conditions of Service printed overleaf, available on request or accessible at www.sgs.com/terms_and_conditions.htm and for electronic format documents, subject to Terms and Conditions for Electronic Documents at www.sgs.com/terms_e-document.htm. Attention is drawn to the limitation of liability, indemnification and jurisdiction issues defined therein. Any holder of this document is advised that information contained hereon reflects the Company's findings at the time of its intervention only and within the limits of Client's instructions, if any. The Company's sole responsibility is to its Client and this document does not exonerate parties to a transaction from exercising all their rights and obligations under the transaction documents. This document cannot be reproduced except in full, without prior written approval of the Company. Any unauthorized alteration, forgery or falsification of the content or appearance of this document is unlawful and offenders may be prosecuted to the fullest extent of the law.

FDD Band 25									
BW(Mhz)	Modulation	RB Size	RB Offset	Frequency (MHz)	Channel	Conducted power (dBm)	Target Power + Max. Tolerance (dBm)	MPR Allowed per 3GPP(dB)	
15	QPSK	1 RB	0	1857.5	26115	24.48	25	0	
				1882.5	26365	23.91	25	0	
				1907.5	26615	24.46	25	0	
			36	1857.5	26115	23.57	25	0	
				1882.5	26365	23.60	25	0	
				1907.5	26615	23.95	25	0	
			74	1857.5	26115	23.89	25	0	
				1882.5	26365	23.96	25	0	
				1907.5	26615	24.16	25	0	
		36 RB	0	1857.5	26115	22.80	24	0-1	
				1882.5	26365	22.80	24	0-1	
				1907.5	26615	23.16	24	0-1	
			18	1857.5	26115	22.87	24	0-1	
				1882.5	26365	22.59	24	0-1	
				1907.5	26615	23.03	24	0-1	
			37	1857.5	26115	22.84	24	0-1	
				1882.5	26365	22.87	24	0-1	
				1907.5	26615	23.06	24	0-1	
		75RB	1857.5	26115	22.85	24	0-1		
			1882.5	26365	22.83	24	0-1		
			1907.5	26615	23.07	24	0-1		
		16-QAM	1 RB	0	1857.5	26115	23.14	24	0-1
					1882.5	26365	23.47	24	0-1
					1907.5	26615	23.11	24	0-1
	36			1857.5	26115	23.14	24	0-1	
				1882.5	26365	22.94	24	0-1	
				1907.5	26615	23.44	24	0-1	
	74			1857.5	26115	23.14	24	0-1	
				1882.5	26365	23.16	24	0-1	
				1907.5	26615	23.43	24	0-1	
	36 RB			0	1857.5	26115	21.77	23	0-2
					1882.5	26365	21.90	23	0-2
					1907.5	26615	22.14	23	0-2
			18	1857.5	26115	21.91	23	0-2	
				1882.5	26365	21.62	23	0-2	
				1907.5	26615	22.02	23	0-2	
			37	1857.5	26115	22.06	23	0-2	
				1882.5	26365	21.75	23	0-2	
				1907.5	26615	21.99	23	0-2	
	75RB		1857.5	26115	21.70	23	0-2		
			1882.5	26365	21.86	23	0-2		
			1907.5	26615	22.09	23	0-2		

Unless otherwise stated the results shown in this test report refer only to the sample(s) tested and such sample(s) are retained for 90 days only.

除非另有說明，此報告結果僅對測試之樣品負責，同時此樣品僅保留90天。本報告未經本公司書面許可，不可部份複製。

This document is issued by the Company subject to its General Conditions of Service printed overleaf, available on request or accessible at www.sgs.com/terms_and_conditions.htm and for electronic format documents, subject to Terms and Conditions for Electronic Documents at www.sgs.com/terms_e-document.htm. Attention is drawn to the limitation of liability, indemnification and jurisdiction issues defined therein. Any holder of this document is advised that information contained hereon reflects the Company's findings at the time of its intervention only and within the limits of Client's instructions, if any. The Company's sole responsibility is to its Client and this document does not exonerate parties to a transaction from exercising all their rights and obligations under the transaction documents. This document cannot be reproduced except in full, without prior written approval of the Company. Any unauthorized alteration, forgery or falsification of the content or appearance of this document is unlawful and offenders may be prosecuted to the fullest extent of the law.

FDD Band 25								
BW(Mhz)	Modulation	RB Size	RB Offset	Frequency (MHz)	Channel	Conducted power (dBm)	Target Power + Max. Tolerance (dBm)	MPR Allowed per 3GPP(dB)
15	64-QAM	1 RB	0	1857.5	26115	23.03	24	0-1
				1882.5	26365	23.45	24	0-1
				1907.5	26615	23.01	24	0-1
			36	1857.5	26115	22.96	24	0-1
				1882.5	26365	22.96	24	0-1
				1907.5	26615	23.24	24	0-1
			74	1857.5	26115	23.00	24	0-1
				1882.5	26365	22.97	24	0-1
				1907.5	26615	23.08	24	0-1
		36 RB	0	1857.5	26115	21.60	23	0-2
				1882.5	26365	21.70	23	0-2
				1907.5	26615	21.77	23	0-2
			18	1857.5	26115	21.75	23	0-2
				1882.5	26365	21.61	23	0-2
				1907.5	26615	21.79	23	0-2
			37	1857.5	26115	21.76	23	0-2
				1882.5	26365	21.64	23	0-2
				1907.5	26615	22.00	23	0-2
		75RB	1857.5	26115	21.76	23	0-2	
			1882.5	26365	21.70	23	0-2	
			1907.5	26615	21.75	23	0-2	

Unless otherwise stated the results shown in this test report refer only to the sample(s) tested and such sample(s) are retained for 90 days only.

除非另有說明，此報告結果僅對測試之樣品負責，同時此樣品僅保留90天。本報告未經本公司書面許可，不可部份複製。

This document is issued by the Company subject to its General Conditions of Service printed overleaf, available on request or accessible at www.sgs.com/terms_and_conditions.htm and for electronic format documents, subject to Terms and Conditions for Electronic Documents at www.sgs.com/terms_e-document.htm. Attention is drawn to the limitation of liability, indemnification and jurisdiction issues defined therein. Any holder of this document is advised that information contained hereon reflects the Company's findings at the time of its intervention only and within the limits of Client's instructions, if any. The Company's sole responsibility is to its Client and this document does not exonerate parties to a transaction from exercising all their rights and obligations under the transaction documents. This document cannot be reproduced except in full, without prior written approval of the Company. Any unauthorized alteration, forgery or falsification of the content or appearance of this document is unlawful and offenders may be prosecuted to the fullest extent of the law.

FDD Band 25									
BW(Mhz)	Modulation	RB Size	RB Offset	Frequency (MHz)	Channel	Conducted power (dBm)	Target Power + Max. Tolerance (dBm)	MPR Allowed per 3GPP(dB)	
10	QPSK	1 RB	0	1855	26090	24.44	25	0	
				1882.5	26365	23.87	25	0	
				1910	26640	24.48	25	0	
			25	1855	26090	23.52	25	0	
				1882.5	26365	23.51	25	0	
				1910	26640	23.70	25	0	
			49	1855	26090	23.82	25	0	
				1882.5	26365	23.93	25	0	
				1910	26640	24.07	25	0	
		25 RB	0	1855	26090	22.97	24	0-1	
				1882.5	26365	22.89	24	0-1	
				1910	26640	23.20	24	0-1	
			12	1855	26090	22.75	24	0-1	
				1882.5	26365	22.71	24	0-1	
				1910	26640	23.11	24	0-1	
			25	1855	26090	22.73	24	0-1	
				1882.5	26365	22.70	24	0-1	
				1910	26640	23.20	24	0-1	
		50RB	1855	26090	22.92	24	0-1		
			1882.5	26365	22.95	24	0-1		
			1910	26640	23.00	24	0-1		
		16-QAM	1 RB	0	1855	26090	23.35	24	0-1
					1882.5	26365	23.52	24	0-1
					1910	26640	23.10	24	0-1
	25			1855	26090	23.13	24	0-1	
				1882.5	26365	23.07	24	0-1	
				1910	26640	23.26	24	0-1	
	49			1855	26090	23.20	24	0-1	
				1882.5	26365	23.20	24	0-1	
				1910	26640	23.32	24	0-1	
	25 RB			0	1855	26090	21.86	23	0-2
					1882.5	26365	22.00	23	0-2
					1910	26640	22.08	23	0-2
			12	1855	26090	21.74	23	0-2	
				1882.5	26365	21.83	23	0-2	
				1910	26640	22.18	23	0-2	
			25	1855	26090	21.91	23	0-2	
				1882.5	26365	22.00	23	0-2	
				1910	26640	22.20	23	0-2	
	50RB		1855	26090	21.80	23	0-2		
			1882.5	26365	21.87	23	0-2		
			1910	26640	22.01	23	0-2		

Unless otherwise stated the results shown in this test report refer only to the sample(s) tested and such sample(s) are retained for 90 days only.

除非另有說明，此報告結果僅對測試之樣品負責，同時此樣品僅保留90天。本報告未經本公司書面許可，不可部份複製。

This document is issued by the Company subject to its General Conditions of Service printed overleaf, available on request or accessible at www.sgs.com/terms_and_conditions.htm and for electronic format documents, subject to Terms and Conditions for Electronic Documents at www.sgs.com/terms_e-document.htm. Attention is drawn to the limitation of liability, indemnification and jurisdiction issues defined therein. Any holder of this document is advised that information contained hereon reflects the Company's findings at the time of its intervention only and within the limits of Client's instructions, if any. The Company's sole responsibility is to its Client and this document does not exonerate parties to a transaction from exercising all their rights and obligations under the transaction documents. This document cannot be reproduced except in full, without prior written approval of the Company. Any unauthorized alteration, forgery or falsification of the content or appearance of this document is unlawful and offenders may be prosecuted to the fullest extent of the law.

FDD Band 25								
BW(Mhz)	Modulation	RB Size	RB Offset	Frequency (MHz)	Channel	Conducted power (dBm)	Target Power + Max. Tolerance (dBm)	MPR Allowed per 3GPP(dB)
10	64-QAM	1 RB	0	1855	26090	23.07	24	0-1
				1882.5	26365	23.25	24	0-1
				1910	26640	22.94	24	0-1
			25	1855	26090	23.03	24	0-1
				1882.5	26365	22.91	24	0-1
				1910	26640	23.26	24	0-1
			49	1855	26090	22.80	24	0-1
				1882.5	26365	22.96	24	0-1
				1910	26640	22.98	24	0-1
		25 RB	0	1855	26090	21.79	23	0-2
				1882.5	26365	21.81	23	0-2
				1910	26640	21.97	23	0-2
			12	1855	26090	21.68	23	0-2
				1882.5	26365	21.62	23	0-2
				1910	26640	22.00	23	0-2
			25	1855	26090	21.87	23	0-2
				1882.5	26365	21.81	23	0-2
				1910	26640	21.84	23	0-2
			50RB	1855	26090	21.65	23	0-2
				1882.5	26365	21.69	23	0-2
				1910	26640	21.93	23	0-2

Unless otherwise stated the results shown in this test report refer only to the sample(s) tested and such sample(s) are retained for 90 days only.

除非另有說明，此報告結果僅對測試之樣品負責，同時此樣品僅保留90天。本報告未經本公司書面許可，不可部份複製。

This document is issued by the Company subject to its General Conditions of Service printed overleaf, available on request or accessible at www.sgs.com/terms_and_conditions.htm and for electronic format documents, subject to Terms and Conditions for Electronic Documents at www.sgs.com/terms_e-document.htm. Attention is drawn to the limitation of liability, indemnification and jurisdiction issues defined therein. Any holder of this document is advised that information contained hereon reflects the Company's findings at the time of its intervention only and within the limits of Client's instructions, if any. The Company's sole responsibility is to its Client and this document does not exonerate parties to a transaction from exercising all their rights and obligations under the transaction documents. This document cannot be reproduced except in full, without prior written approval of the Company. Any unauthorized alteration, forgery or falsification of the content or appearance of this document is unlawful and offenders may be prosecuted to the fullest extent of the law.

FDD Band 25									
BW(Mhz)	Modulation	RB Size	RB Offset	Frequency (MHz)	Channel	Conducted power (dBm)	Target Power + Max. Tolerance (dBm)	MPR Allowed per 3GPP(dB)	
5	QPSK	1 RB	0	1852.5	26065	24.33	25	0	
				1882.5	26365	23.87	25	0	
				1912.5	26665	24.26	25	0	
			12	1852.5	26065	23.67	25	0	
				1882.5	26365	23.49	25	0	
				1912.5	26665	23.76	25	0	
			24	1852.5	26065	23.84	25	0	
				1882.5	26365	24.07	25	0	
				1912.5	26665	24.22	25	0	
		12 RB	0	1852.5	26065	22.94	24	0-1	
				1882.5	26365	22.75	24	0-1	
				1912.5	26665	23.16	24	0-1	
			6	1852.5	26065	22.90	24	0-1	
				1882.5	26365	22.73	24	0-1	
				1912.5	26665	23.16	24	0-1	
			13	1852.5	26065	22.83	24	0-1	
				1882.5	26365	22.71	24	0-1	
				1912.5	26665	23.20	24	0-1	
		25RB	1852.5	26065	22.84	24	0-1		
			1882.5	26365	22.88	24	0-1		
			1912.5	26665	22.88	24	0-1		
		16-QAM	1 RB	0	1852.5	26065	23.27	24	0-1
					1882.5	26365	23.49	24	0-1
					1912.5	26665	23.32	24	0-1
	12			1852.5	26065	23.21	24	0-1	
				1882.5	26365	23.17	24	0-1	
				1912.5	26665	23.19	24	0-1	
	24			1852.5	26065	23.15	24	0-1	
				1882.5	26365	23.19	24	0-1	
				1912.5	26665	23.23	24	0-1	
	12 RB		0	1852.5	26065	21.80	23	0-2	
				1882.5	26365	21.81	23	0-2	
				1912.5	26665	22.06	23	0-2	
			6	1852.5	26065	21.95	23	0-2	
				1882.5	26365	21.90	23	0-2	
				1912.5	26665	22.12	23	0-2	
			13	1852.5	26065	21.86	23	0-2	
				1882.5	26365	21.87	23	0-2	
				1912.5	26665	22.00	23	0-2	
	25RB		1852.5	26065	21.70	23	0-2		
			1882.5	26365	21.78	23	0-2		
			1912.5	26665	21.90	23	0-2		

Unless otherwise stated the results shown in this test report refer only to the sample(s) tested and such sample(s) are retained for 90 days only.

除非另有說明，此報告結果僅對測試之樣品負責，同時此樣品僅保留90天。本報告未經本公司書面許可，不可部份複製。

This document is issued by the Company subject to its General Conditions of Service printed overleaf, available on request or accessible at www.sgs.com/terms_and_conditions.htm and for electronic format documents, subject to Terms and Conditions for Electronic Documents at www.sgs.com/terms_e-document.htm. Attention is drawn to the limitation of liability, indemnification and jurisdiction issues defined therein. Any holder of this document is advised that information contained hereon reflects the Company's findings at the time of its intervention only and within the limits of Client's instructions, if any. The Company's sole responsibility is to its Client and this document does not exonerate parties to a transaction from exercising all their rights and obligations under the transaction documents. This document cannot be reproduced except in full, without prior written approval of the Company. Any unauthorized alteration, forgery or falsification of the content or appearance of this document is unlawful and offenders may be prosecuted to the fullest extent of the law.

FDD Band 25								
BW(Mhz)	Modulation	RB Size	RB Offset	Frequency (MHz)	Channel	Conducted power (dBm)	Target Power + Max. Tolerance (dBm)	MPR Allowed per 3GPP(dB)
5	64-QAM	1 RB	0	1852.5	26065	23.22	24	0-1
				1882.5	26365	23.35	24	0-1
				1912.5	26665	23.14	24	0-1
			12	1852.5	26065	23.06	24	0-1
				1882.5	26365	22.94	24	0-1
				1912.5	26665	23.04	24	0-1
			24	1852.5	26065	22.95	24	0-1
				1882.5	26365	23.05	24	0-1
				1912.5	26665	23.24	24	0-1
		12 RB	0	1852.5	26065	21.58	23	0-2
				1882.5	26365	21.84	23	0-2
				1912.5	26665	21.81	23	0-2
			6	1852.5	26065	21.56	23	0-2
				1882.5	26365	21.67	23	0-2
				1912.5	26665	21.87	23	0-2
			13	1852.5	26065	21.76	23	0-2
				1882.5	26365	21.70	23	0-2
				1912.5	26665	22.01	23	0-2
		25RB	1852.5	26065	21.71	23	0-2	
			1882.5	26365	21.64	23	0-2	
			1912.5	26665	21.90	23	0-2	

Unless otherwise stated the results shown in this test report refer only to the sample(s) tested and such sample(s) are retained for 90 days only.

除非另有說明，此報告結果僅對測試之樣品負責，同時此樣品僅保留90天。本報告未經本公司書面許可，不可部份複製。

This document is issued by the Company subject to its General Conditions of Service printed overleaf, available on request or accessible at www.sgs.com/terms_and_conditions.htm and for electronic format documents, subject to Terms and Conditions for Electronic Documents at www.sgs.com/terms_e-document.htm. Attention is drawn to the limitation of liability, indemnification and jurisdiction issues defined therein. Any holder of this document is advised that information contained hereon reflects the Company's findings at the time of its intervention only and within the limits of Client's instructions, if any. The Company's sole responsibility is to its Client and this document does not exonerate parties to a transaction from exercising all their rights and obligations under the transaction documents. This document cannot be reproduced except in full, without prior written approval of the Company. Any unauthorized alteration, forgery or falsification of the content or appearance of this document is unlawful and offenders may be prosecuted to the fullest extent of the law.

FDD Band 25									
BW(Mhz)	Modulation	RB Size	RB Offset	Frequency (MHz)	Channel	Conducted power (dBm)	Target Power + Max. Tolerance (dBm)	MPR Allowed per 3GPP(dB)	
3	QPSK	1 RB	0	1851.5	26055	24.25	25	0	
				1882.5	26365	24.00	25	0	
				1913.5	26675	24.34	25	0	
			7	1851.5	26055	23.48	25	0	
				1882.5	26365	23.67	25	0	
				1913.5	26675	23.77	25	0	
		14	1851.5	26055	23.79	25	0		
			1882.5	26365	23.98	25	0		
			1913.5	26675	24.21	25	0		
		8 RB	0	1851.5	26055	22.99	24	0-1	
				1882.5	26365	22.76	24	0-1	
				1913.5	26675	23.02	24	0-1	
			4	1851.5	26055	22.70	24	0-1	
				1882.5	26365	22.65	24	0-1	
				1913.5	26675	23.19	24	0-1	
			7	1851.5	26055	22.76	24	0-1	
				1882.5	26365	22.74	24	0-1	
				1913.5	26675	23.05	24	0-1	
		15RB	1851.5	26055	22.78	24	0-1		
			1882.5	26365	22.83	24	0-1		
			1913.5	26675	22.94	24	0-1		
		16-QAM	1 RB	0	1851.5	26055	23.15	24	0-1
					1882.5	26365	23.54	24	0-1
					1913.5	26675	23.33	24	0-1
	7			1851.5	26055	23.25	24	0-1	
				1882.5	26365	23.03	24	0-1	
				1913.5	26675	23.28	24	0-1	
	14			1851.5	26055	22.99	24	0-1	
				1882.5	26365	23.11	24	0-1	
				1913.5	26675	23.43	24	0-1	
	8 RB			0	1851.5	26055	21.94	23	0-2
					1882.5	26365	21.86	23	0-2
					1913.5	26675	21.95	23	0-2
			4	1851.5	26055	21.95	23	0-2	
				1882.5	26365	21.91	23	0-2	
				1913.5	26675	22.17	23	0-2	
			7	1851.5	26055	21.98	23	0-2	
				1882.5	26365	21.78	23	0-2	
				1913.5	26675	22.25	23	0-2	
	15RB		1851.5	26055	21.83	23	0-2		
			1882.5	26365	21.80	23	0-2		
			1913.5	26675	21.87	23	0-2		

Unless otherwise stated the results shown in this test report refer only to the sample(s) tested and such sample(s) are retained for 90 days only.

除非另有說明，此報告結果僅對測試之樣品負責，同時此樣品僅保留90天。本報告未經本公司書面許可，不可部份複製。

This document is issued by the Company subject to its General Conditions of Service printed overleaf, available on request or accessible at www.sgs.com/terms_and_conditions.htm and for electronic format documents, subject to Terms and Conditions for Electronic Documents at www.sgs.com/terms_e-document.htm. Attention is drawn to the limitation of liability, indemnification and jurisdiction issues defined therein. Any holder of this document is advised that information contained hereon reflects the Company's findings at the time of its intervention only and within the limits of Client's instructions, if any. The Company's sole responsibility is to its Client and this document does not exonerate parties to a transaction from exercising all their rights and obligations under the transaction documents. This document cannot be reproduced except in full, without prior written approval of the Company. Any unauthorized alteration, forgery or falsification of the content or appearance of this document is unlawful and offenders may be prosecuted to the fullest extent of the law.

FDD Band 25								
BW(Mhz)	Modulation	RB Size	RB Offset	Frequency (MHz)	Channel	Conducted power (dBm)	Target Power + Max. Tolerance (dBm)	MPR Allowed per 3GPP(dB)
3	64-QAM	1 RB	0	1851.5	26055	23.03	24	0-1
				1882.5	26365	23.26	24	0-1
				1913.5	26675	23.19	24	0-1
			7	1851.5	26055	23.03	24	0-1
				1882.5	26365	22.86	24	0-1
				1913.5	26675	23.15	24	0-1
			14	1851.5	26055	22.99	24	0-1
				1882.5	26365	23.09	24	0-1
				1913.5	26675	23.23	24	0-1
		8 RB	0	1851.5	26055	21.72	23	0-2
				1882.5	26365	21.64	23	0-2
				1913.5	26675	21.94	23	0-2
			4	1851.5	26055	21.57	23	0-2
				1882.5	26365	21.60	23	0-2
				1913.5	26675	21.84	23	0-2
			7	1851.5	26055	21.85	23	0-2
				1882.5	26365	21.77	23	0-2
				1913.5	26675	21.92	23	0-2
		15RB	1851.5	26055	21.59	23	0-2	
			1882.5	26365	21.46	23	0-2	
			1913.5	26675	21.94	23	0-2	

Unless otherwise stated the results shown in this test report refer only to the sample(s) tested and such sample(s) are retained for 90 days only.

除非另有說明，此報告結果僅對測試之樣品負責，同時此樣品僅保留90天。本報告未經本公司書面許可，不可部份複製。

This document is issued by the Company subject to its General Conditions of Service printed overleaf, available on request or accessible at www.sgs.com/terms_and_conditions.htm and for electronic format documents, subject to Terms and Conditions for Electronic Documents at www.sgs.com/terms_e-document.htm. Attention is drawn to the limitation of liability, indemnification and jurisdiction issues defined therein. Any holder of this document is advised that information contained hereon reflects the Company's findings at the time of its intervention only and within the limits of Client's instructions, if any. The Company's sole responsibility is to its Client and this document does not exonerate parties to a transaction from exercising all their rights and obligations under the transaction documents. This document cannot be reproduced except in full, without prior written approval of the Company. Any unauthorized alteration, forgery or falsification of the content or appearance of this document is unlawful and offenders may be prosecuted to the fullest extent of the law.

FDD Band 25									
BW(Mhz)	Modulation	RB Size	RB Offset	Frequency (MHz)	Channel	Conducted power (dBm)	Target Power + Max. Tolerance (dBm)	MPR Allowed per 3GPP(dB)	
1.4	QPSK	1 RB	0	1850.7	26047	24.42	25	0	
				1882.5	26365	24.03	25	0	
				1914.3	26683	24.25	25	0	
			2	1850.7	26047	23.55	25	0	
				1882.5	26365	23.66	25	0	
				1914.3	26683	23.78	25	0	
			5	1850.7	26047	24.03	25	0	
				1882.5	26365	23.81	25	0	
				1914.3	26683	24.09	25	0	
		3 RB	0	1850.7	26047	22.79	24	0-1	
				1882.5	26365	22.83	24	0-1	
				1914.3	26683	23.04	24	0-1	
			2	1850.7	26047	22.73	24	0-1	
				1882.5	26365	22.73	24	0-1	
				1914.3	26683	22.92	24	0-1	
			3	1850.7	26047	22.95	24	0-1	
				1882.5	26365	22.82	24	0-1	
				1914.3	26683	23.17	24	0-1	
		6RB	1850.7	26047	22.91	24	0-1		
			1882.5	26365	22.93	24	0-1		
			1914.3	26683	23.00	24	0-1		
		16-QAM	1 RB	0	1850.7	26047	23.21	24	0-1
					1882.5	26365	23.40	24	0-1
					1914.3	26683	23.37	24	0-1
	2			1850.7	26047	23.25	24	0-1	
				1882.5	26365	23.02	24	0-1	
				1914.3	26683	23.32	24	0-1	
	5			1850.7	26047	23.09	24	0-1	
				1882.5	26365	23.21	24	0-1	
				1914.3	26683	23.23	24	0-1	
	3 RB			0	1850.7	26047	21.93	23	0-2
					1882.5	26365	21.87	23	0-2
					1914.3	26683	22.02	23	0-2
			2	1850.7	26047	21.82	23	0-2	
				1882.5	26365	21.76	23	0-2	
				1914.3	26683	22.15	23	0-2	
			3	1850.7	26047	22.01	23	0-2	
				1882.5	26365	21.89	23	0-2	
				1914.3	26683	22.06	23	0-2	
	6RB		1850.7	26047	21.70	23	0-2		
			1882.5	26365	21.67	23	0-2		
			1914.3	26683	22.02	23	0-2		

Unless otherwise stated the results shown in this test report refer only to the sample(s) tested and such sample(s) are retained for 90 days only.

除非另有說明，此報告結果僅對測試之樣品負責，同時此樣品僅保留90天。本報告未經本公司書面許可，不可部份複製。

This document is issued by the Company subject to its General Conditions of Service printed overleaf, available on request or accessible at www.sgs.com/terms_and_conditions.htm and for electronic format documents, subject to Terms and Conditions for Electronic Documents at www.sgs.com/terms_e-document.htm. Attention is drawn to the limitation of liability, indemnification and jurisdiction issues defined therein. Any holder of this document is advised that information contained hereon reflects the Company's findings at the time of its intervention only and within the limits of Client's instructions, if any. The Company's sole responsibility is to its Client and this document does not exonerate parties to a transaction from exercising all their rights and obligations under the transaction documents. This document cannot be reproduced except in full, without prior written approval of the Company. Any unauthorized alteration, forgery or falsification of the content or appearance of this document is unlawful and offenders may be prosecuted to the fullest extent of the law.

FDD Band 25								
BW(Mhz)	Modulation	RB Size	RB Offset	Frequency (MHz)	Channel	Conducted power (dBm)	Target Power + Max. Tolerance (dBm)	MPR Allowed per 3GPP(dB)
1.4	64-QAM	1 RB	0	1850.7	26047	23.04	24	0-1
				1882.5	26365	23.37	24	0-1
				1914.3	26683	22.95	24	0-1
			2	1850.7	26047	23.17	24	0-1
				1882.5	26365	22.87	24	0-1
				1914.3	26683	23.26	24	0-1
			5	1850.7	26047	22.97	24	0-1
				1882.5	26365	22.93	24	0-1
				1914.3	26683	23.14	24	0-1
		3 RB	0	1850.7	26047	21.79	23	0-2
				1882.5	26365	21.71	23	0-2
				1914.3	26683	21.98	23	0-2
			2	1850.7	26047	21.76	23	0-2
				1882.5	26365	21.50	23	0-2
				1914.3	26683	21.99	23	0-2
			3	1850.7	26047	21.66	23	0-2
				1882.5	26365	21.69	23	0-2
				1914.3	26683	21.83	23	0-2
			6RB	1850.7	26047	21.61	23	0-2
				1882.5	26365	21.52	23	0-2
				1914.3	26683	21.71	23	0-2

Unless otherwise stated the results shown in this test report refer only to the sample(s) tested and such sample(s) are retained for 90 days only.

除非另有說明，此報告結果僅對測試之樣品負責，同時此樣品僅保留90天。本報告未經本公司書面許可，不可部份複製。

This document is issued by the Company subject to its General Conditions of Service printed overleaf, available on request or accessible at www.sgs.com/terms_and_conditions.htm and for electronic format documents, subject to Terms and Conditions for Electronic Documents at www.sgs.com/terms_e-document.htm. Attention is drawn to the limitation of liability, indemnification and jurisdiction issues defined therein. Any holder of this document is advised that information contained hereon reflects the Company's findings at the time of its intervention only and within the limits of Client's instructions, if any. The Company's sole responsibility is to its Client and this document does not exonerate parties to a transaction from exercising all their rights and obligations under the transaction documents. This document cannot be reproduced except in full, without prior written approval of the Company. Any unauthorized alteration, forgery or falsification of the content or appearance of this document is unlawful and offenders may be prosecuted to the fullest extent of the law.

FDD Band 26									
BW(Mhz)	Modulation	RB Size	RB Offset	Frequency (MHz)	Channel	Conducted power (dBm)	Target Power + Max. Tolerance (dBm)	MPR Allowed per 3GPP(dB)	
15	QPSK	1 RB	0	821.5	26765	24.05	25	0	
				831.5	26865	24.04	25	0	
				841.5	26965	23.99	25	0	
			36	821.5	26765	24.07	25	0	
				831.5	26865	24.09	25	0	
				841.5	26965	24.04	25	0	
		74	821.5	26765	24.03	25	0		
			831.5	26865	24.00	25	0		
			841.5	26965	23.87	25	0		
		36 RB	0	821.5	26765	23.13	24	0-1	
				831.5	26865	23.07	24	0-1	
				841.5	26965	23.07	24	0-1	
			18	821.5	26765	23.20	24	0-1	
				831.5	26865	23.09	24	0-1	
				841.5	26965	23.03	24	0-1	
		37	821.5	26765	23.09	24	0-1		
			831.5	26865	23.16	24	0-1		
			841.5	26965	23.06	24	0-1		
		75RB	821.5	26765	23.09	24	0-1		
			831.5	26865	23.03	24	0-1		
			841.5	26965	23.06	24	0-1		
		16-QAM	1 RB	0	821.5	26765	23.11	24	0-1
					831.5	26865	23.33	24	0-1
					841.5	26965	23.54	24	0-1
	36			821.5	26765	23.31	24	0-1	
				831.5	26865	23.63	24	0-1	
				841.5	26965	23.13	24	0-1	
	74			821.5	26765	23.61	24	0-1	
				831.5	26865	23.04	24	0-1	
				841.5	26965	22.80	24	0-1	
	36 RB			0	821.5	26765	22.22	23	0-2
					831.5	26865	22.15	23	0-2
					841.5	26965	22.03	23	0-2
			18	821.5	26765	22.16	23	0-2	
				831.5	26865	22.14	23	0-2	
				841.5	26965	22.08	23	0-2	
	37		821.5	26765	22.15	23	0-2		
			831.5	26865	22.06	23	0-2		
			841.5	26965	22.01	23	0-2		
	75RB		821.5	26765	22.12	23	0-2		
			831.5	26865	22.10	23	0-2		
			841.5	26965	22.15	23	0-2		

Unless otherwise stated the results shown in this test report refer only to the sample(s) tested and such sample(s) are retained for 90 days only.

除非另有說明，此報告結果僅對測試之樣品負責，同時此樣品僅保留90天。本報告未經本公司書面許可，不可部份複製。

This document is issued by the Company subject to its General Conditions of Service printed overleaf, available on request or accessible at www.sgs.com/terms_and_conditions.htm and for electronic format documents, subject to Terms and Conditions for Electronic Documents at www.sgs.com/terms_e-document.htm. Attention is drawn to the limitation of liability, indemnification and jurisdiction issues defined therein. Any holder of this document is advised that information contained hereon reflects the Company's findings at the time of its intervention only and within the limits of Client's instructions, if any. The Company's sole responsibility is to its Client and this document does not exonerate parties to a transaction from exercising all their rights and obligations under the transaction documents. This document cannot be reproduced except in full, without prior written approval of the Company. Any unauthorized alteration, forgery or falsification of the content or appearance of this document is unlawful and offenders may be prosecuted to the fullest extent of the law.

FDD Band 26								
BW(Mhz)	Modulation	RB Size	RB Offset	Frequency (MHz)	Channel	Conducted power (dBm)	Target Power + Max. Tolerance (dBm)	MPR Allowed per 3GPP(dB)
15	64-QAM	1 RB	0	821.5	26765	23.04	24	0-1
				831.5	26865	23.26	24	0-1
				841.5	26965	23.47	24	0-1
			36	821.5	26765	23.24	24	0-1
				831.5	26865	23.56	24	0-1
				841.5	26965	23.06	24	0-1
			74	821.5	26765	23.54	24	0-1
				831.5	26865	22.97	24	0-1
				841.5	26965	22.73	24	0-1
		36 RB	0	821.5	26765	22.15	23	0-2
				831.5	26865	22.08	23	0-2
				841.5	26965	21.96	23	0-2
			18	821.5	26765	22.09	23	0-2
				831.5	26865	22.07	23	0-2
				841.5	26965	22.01	23	0-2
			37	821.5	26765	22.08	23	0-2
				831.5	26865	21.99	23	0-2
				841.5	26965	21.94	23	0-2
			75RB	821.5	26765	22.05	23	0-2
				831.5	26865	22.03	23	0-2
				841.5	26965	22.08	23	0-2

Unless otherwise stated the results shown in this test report refer only to the sample(s) tested and such sample(s) are retained for 90 days only.

除非另有說明，此報告結果僅對測試之樣品負責，同時此樣品僅保留90天。本報告未經本公司書面許可，不可部份複製。

This document is issued by the Company subject to its General Conditions of Service printed overleaf, available on request or accessible at www.sgs.com/terms_and_conditions.htm and for electronic format documents, subject to Terms and Conditions for Electronic Documents at www.sgs.com/terms_e-document.htm. Attention is drawn to the limitation of liability, indemnification and jurisdiction issues defined therein. Any holder of this document is advised that information contained hereon reflects the Company's findings at the time of its intervention only and within the limits of Client's instructions, if any. The Company's sole responsibility is to its Client and this document does not exonerate parties to a transaction from exercising all their rights and obligations under the transaction documents. This document cannot be reproduced except in full, without prior written approval of the Company. Any unauthorized alteration, forgery or falsification of the content or appearance of this document is unlawful and offenders may be prosecuted to the fullest extent of the law.

FDD Band 26									
BW(Mhz)	Modulation	RB Size	RB Offset	Frequency (MHz)	Channel	Conducted power (dBm)	Target Power + Max. Tolerance (dBm)	MPR Allowed per 3GPP(dB)	
10	QPSK	1 RB	0	819	26740	23.80	25	0	
				831.5	26865	23.87	25	0	
				844	26990	23.98	25	0	
			25	819	26740	23.97	25	0	
				831.5	26865	23.87	25	0	
				844	26990	24.04	25	0	
			49	819	26740	23.95	25	0	
				831.5	26865	23.76	25	0	
				844	26990	23.64	25	0	
		25 RB	0	819	26740	23.04	24	0-1	
				831.5	26865	22.80	24	0-1	
				844	26990	23.02	24	0-1	
			12	819	26740	22.96	24	0-1	
				831.5	26865	22.80	24	0-1	
				844	26990	22.97	24	0-1	
			25	819	26740	22.91	24	0-1	
				831.5	26865	22.87	24	0-1	
				844	26990	22.90	24	0-1	
		50RB	819	26740	23.04	24	0-1		
			831.5	26865	22.98	24	0-1		
			844	26990	23.05	24	0-1		
		16-QAM	1 RB	0	819	26740	23.05	24	0-1
					831.5	26865	23.20	24	0-1
					844	26990	23.47	24	0-1
	25			819	26740	23.15	24	0-1	
				831.5	26865	23.60	24	0-1	
				844	26990	22.86	24	0-1	
	49			819	26740	23.46	24	0-1	
				831.5	26865	22.93	24	0-1	
				844	26990	22.54	24	0-1	
	25 RB			0	819	26740	22.10	23	0-2
					831.5	26865	22.07	23	0-2
					844	26990	21.77	23	0-2
			12	819	26740	22.10	23	0-2	
				831.5	26865	22.07	23	0-2	
				844	26990	22.06	23	0-2	
			25	819	26740	22.07	23	0-2	
				831.5	26865	21.94	23	0-2	
				844	26990	21.95	23	0-2	
	50RB		819	26740	22.08	23	0-2		
			831.5	26865	21.80	23	0-2		
			844	26990	22.09	23	0-2		

Unless otherwise stated the results shown in this test report refer only to the sample(s) tested and such sample(s) are retained for 90 days only.

除非另有說明，此報告結果僅對測試之樣品負責，同時此樣品僅保留90天。本報告未經本公司書面許可，不可部份複製。

This document is issued by the Company subject to its General Conditions of Service printed overleaf, available on request or accessible at www.sgs.com/terms_and_conditions.htm and for electronic format documents, subject to Terms and Conditions for Electronic Documents at www.sgs.com/terms_e-document.htm. Attention is drawn to the limitation of liability, indemnification and jurisdiction issues defined therein. Any holder of this document is advised that information contained hereon reflects the Company's findings at the time of its intervention only and within the limits of Client's instructions, if any. The Company's sole responsibility is to its Client and this document does not exonerate parties to a transaction from exercising all their rights and obligations under the transaction documents. This document cannot be reproduced except in full, without prior written approval of the Company. Any unauthorized alteration, forgery or falsification of the content or appearance of this document is unlawful and offenders may be prosecuted to the fullest extent of the law.

FDD Band 26								
BW(Mhz)	Modulation	RB Size	RB Offset	Frequency (MHz)	Channel	Conducted power (dBm)	Target Power + Max. Tolerance (dBm)	MPR Allowed per 3GPP(dB)
10	64-QAM	1 RB	0	819	26740	23.01	24	0-1
				831.5	26865	23.09	24	0-1
				844	26990	23.41	24	0-1
			25	819	26740	23.03	24	0-1
				831.5	26865	23.42	24	0-1
				844	26990	22.85	24	0-1
			49	819	26740	23.40	24	0-1
				831.5	26865	22.91	24	0-1
				844	26990	22.50	24	0-1
		25 RB	0	819	26740	21.92	23	0-2
				831.5	26865	21.84	23	0-2
				844	26990	21.69	23	0-2
			12	819	26740	21.93	23	0-2
				831.5	26865	21.82	23	0-2
				844	26990	21.71	23	0-2
			25	819	26740	22.04	23	0-2
				831.5	26865	21.72	23	0-2
				844	26990	21.93	23	0-2
			50RB	819	26740	22.02	23	0-2
				831.5	26865	21.97	23	0-2
				844	26990	22.08	23	0-2

Unless otherwise stated the results shown in this test report refer only to the sample(s) tested and such sample(s) are retained for 90 days only.

除非另有說明，此報告結果僅對測試之樣品負責，同時此樣品僅保留90天。本報告未經本公司書面許可，不可部份複製。

This document is issued by the Company subject to its General Conditions of Service printed overleaf, available on request or accessible at www.sgs.com/terms_and_conditions.htm and for electronic format documents, subject to Terms and Conditions for Electronic Documents at www.sgs.com/terms_e-document.htm. Attention is drawn to the limitation of liability, indemnification and jurisdiction issues defined therein. Any holder of this document is advised that information contained hereon reflects the Company's findings at the time of its intervention only and within the limits of Client's instructions, if any. The Company's sole responsibility is to its Client and this document does not exonerate parties to a transaction from exercising all their rights and obligations under the transaction documents. This document cannot be reproduced except in full, without prior written approval of the Company. Any unauthorized alteration, forgery or falsification of the content or appearance of this document is unlawful and offenders may be prosecuted to the fullest extent of the law.

FDD Band 26									
BW(Mhz)	Modulation	RB Size	RB Offset	Frequency (MHz)	Channel	Conducted power (dBm)	Target Power + Max. Tolerance (dBm)	MPR Allowed per 3GPP(dB)	
5	QPSK	1 RB	0	816.5	26715	23.83	25	0	
				831.5	26865	23.94	25	0	
				846.5	27015	23.78	25	0	
			12	816.5	26715	23.78	25	0	
				831.5	26865	23.98	25	0	
				846.5	27015	23.88	25	0	
		24	816.5	26715	23.89	25	0		
			831.5	26865	23.79	25	0		
			846.5	27015	23.62	25	0		
		12 RB	0	816.5	26715	23.02	24	0-1	
				831.5	26865	23.06	24	0-1	
				846.5	27015	22.84	24	0-1	
			6	816.5	26715	23.02	24	0-1	
				831.5	26865	22.97	24	0-1	
				846.5	27015	22.81	24	0-1	
			13	816.5	26715	23.04	24	0-1	
				831.5	26865	22.86	24	0-1	
				846.5	27015	22.88	24	0-1	
		25RB	816.5	26715	22.87	24	0-1		
			831.5	26865	22.95	24	0-1		
			846.5	27015	22.83	24	0-1		
		16-QAM	1 RB	0	816.5	26715	23.07	24	0-1
					831.5	26865	23.32	24	0-1
					846.5	27015	23.25	24	0-1
	12			816.5	26715	23.14	24	0-1	
				831.5	26865	23.53	24	0-1	
				846.5	27015	23.06	24	0-1	
	24			816.5	26715	23.33	24	0-1	
				831.5	26865	23.00	24	0-1	
				846.5	27015	22.65	24	0-1	
	12 RB			0	816.5	26715	22.16	23	0-2
					831.5	26865	21.87	23	0-2
					846.5	27015	21.90	23	0-2
			6	816.5	26715	21.97	23	0-2	
				831.5	26865	22.03	23	0-2	
				846.5	27015	22.03	23	0-2	
			13	816.5	26715	22.07	23	0-2	
				831.5	26865	21.89	23	0-2	
				846.5	27015	21.83	23	0-2	
	25RB		816.5	26715	21.89	23	0-2		
			831.5	26865	21.96	23	0-2		
			846.5	27015	21.92	23	0-2		

Unless otherwise stated the results shown in this test report refer only to the sample(s) tested and such sample(s) are retained for 90 days only.

除非另有說明，此報告結果僅對測試之樣品負責，同時此樣品僅保留90天。本報告未經本公司書面許可，不可部份複製。

This document is issued by the Company subject to its General Conditions of Service printed overleaf, available on request or accessible at www.sgs.com/terms_and_conditions.htm and for electronic format documents, subject to Terms and Conditions for Electronic Documents at www.sgs.com/terms_e-document.htm. Attention is drawn to the limitation of liability, indemnification and jurisdiction issues defined therein. Any holder of this document is advised that information contained hereon reflects the Company's findings at the time of its intervention only and within the limits of Client's instructions, if any. The Company's sole responsibility is to its Client and this document does not exonerate parties to a transaction from exercising all their rights and obligations under the transaction documents. This document cannot be reproduced except in full, without prior written approval of the Company. Any unauthorized alteration, forgery or falsification of the content or appearance of this document is unlawful and offenders may be prosecuted to the fullest extent of the law.

FDD Band 26								
BW(Mhz)	Modulation	RB Size	RB Offset	Frequency (MHz)	Channel	Conducted power (dBm)	Target Power + Max. Tolerance (dBm)	MPR Allowed per 3GPP(dB)
5	64-QAM	1 RB	0	816.5	26715	22.88	24	0-1
				831.5	26865	23.20	24	0-1
				846.5	27015	23.32	24	0-1
			12	816.5	26715	23.02	24	0-1
				831.5	26865	23.38	24	0-1
				846.5	27015	22.85	24	0-1
			24	816.5	26715	23.49	24	0-1
				831.5	26865	22.93	24	0-1
				846.5	27015	22.63	24	0-1
		12 RB	0	816.5	26715	21.94	23	0-2
				831.5	26865	21.79	23	0-2
				846.5	27015	21.86	23	0-2
			6	816.5	26715	22.09	23	0-2
				831.5	26865	22.02	23	0-2
				846.5	27015	21.96	23	0-2
			13	816.5	26715	21.78	23	0-2
				831.5	26865	21.81	23	0-2
				846.5	27015	21.87	23	0-2
			25RB	816.5	26715	21.80	23	0-2
				831.5	26865	21.81	23	0-2
				846.5	27015	21.78	23	0-2

Unless otherwise stated the results shown in this test report refer only to the sample(s) tested and such sample(s) are retained for 90 days only.

除非另有說明，此報告結果僅對測試之樣品負責，同時此樣品僅保留90天。本報告未經本公司書面許可，不可部份複製。

This document is issued by the Company subject to its General Conditions of Service printed overleaf, available on request or accessible at www.sgs.com/terms_and_conditions.htm and for electronic format documents, subject to Terms and Conditions for Electronic Documents at www.sgs.com/terms_e-document.htm. Attention is drawn to the limitation of liability, indemnification and jurisdiction issues defined therein. Any holder of this document is advised that information contained hereon reflects the Company's findings at the time of its intervention only and within the limits of Client's instructions, if any. The Company's sole responsibility is to its Client and this document does not exonerate parties to a transaction from exercising all their rights and obligations under the transaction documents. This document cannot be reproduced except in full, without prior written approval of the Company. Any unauthorized alteration, forgery or falsification of the content or appearance of this document is unlawful and offenders may be prosecuted to the fullest extent of the law.

FDD Band 26									
BW(Mhz)	Modulation	RB Size	RB Offset	Frequency (MHz)	Channel	Conducted power (dBm)	Target Power + Max. Tolerance (dBm)	MPR Allowed per 3GPP(dB)	
3	QPSK	1 RB	0	815.5	26705	23.87	25	0	
				831.5	26865	23.98	25	0	
				847.5	27025	23.74	25	0	
			7	815.5	26705	23.92	25	0	
				831.5	26865	24.02	25	0	
				847.5	27025	23.77	25	0	
		14	815.5	26705	23.87	25	0		
			831.5	26865	23.77	25	0		
			847.5	27025	23.58	25	0		
		8 RB	0	815.5	26705	23.01	24	0-1	
				831.5	26865	22.84	24	0-1	
				847.5	27025	22.99	24	0-1	
			4	815.5	26705	23.00	24	0-1	
				831.5	26865	22.93	24	0-1	
				847.5	27025	22.87	24	0-1	
			7	815.5	26705	22.89	24	0-1	
				831.5	26865	23.00	24	0-1	
				847.5	27025	22.92	24	0-1	
		15RB	815.5	26705	23.04	24	0-1		
			831.5	26865	22.93	24	0-1		
			847.5	27025	23.02	24	0-1		
		16-QAM	1 RB	0	815.5	26705	22.86	24	0-1
					831.5	26865	23.26	24	0-1
					847.5	27025	23.28	24	0-1
	7			815.5	26705	23.01	24	0-1	
				831.5	26865	23.52	24	0-1	
				847.5	27025	22.99	24	0-1	
	14			815.5	26705	23.39	24	0-1	
				831.5	26865	22.92	24	0-1	
				847.5	27025	22.53	24	0-1	
	8 RB			0	815.5	26705	22.05	23	0-2
					831.5	26865	22.03	23	0-2
					847.5	27025	21.81	23	0-2
			4	815.5	26705	22.12	23	0-2	
				831.5	26865	21.88	23	0-2	
				847.5	27025	21.98	23	0-2	
			7	815.5	26705	22.09	23	0-2	
				831.5	26865	22.04	23	0-2	
				847.5	27025	21.86	23	0-2	
	15RB		815.5	26705	21.82	23	0-2		
			831.5	26865	22.10	23	0-2		
			847.5	27025	21.99	23	0-2		

Unless otherwise stated the results shown in this test report refer only to the sample(s) tested and such sample(s) are retained for 90 days only.

除非另有說明，此報告結果僅對測試之樣品負責，同時此樣品僅保留90天。本報告未經本公司書面許可，不可部份複製。

This document is issued by the Company subject to its General Conditions of Service printed overleaf, available on request or accessible at www.sgs.com/terms_and_conditions.htm and for electronic format documents, subject to Terms and Conditions for Electronic Documents at www.sgs.com/terms_e-document.htm. Attention is drawn to the limitation of liability, indemnification and jurisdiction issues defined therein. Any holder of this document is advised that information contained hereon reflects the Company's findings at the time of its intervention only and within the limits of Client's instructions, if any. The Company's sole responsibility is to its Client and this document does not exonerate parties to a transaction from exercising all their rights and obligations under the transaction documents. This document cannot be reproduced except in full, without prior written approval of the Company. Any unauthorized alteration, forgery or falsification of the content or appearance of this document is unlawful and offenders may be prosecuted to the fullest extent of the law.

FDD Band 26								
BW(Mhz)	Modulation	RB Size	RB Offset	Frequency (MHz)	Channel	Conducted power (dBm)	Target Power + Max. Tolerance (dBm)	MPR Allowed per 3GPP(dB)
3	64-QAM	1 RB	0	815.5	26705	22.86	24	0-1
				831.5	26865	23.02	24	0-1
				847.5	27025	23.45	24	0-1
			7	815.5	26705	23.07	24	0-1
				831.5	26865	23.41	24	0-1
				847.5	27025	22.87	24	0-1
			14	815.5	26705	23.51	24	0-1
				831.5	26865	22.91	24	0-1
				847.5	27025	22.54	24	0-1
		8 RB	0	815.5	26705	21.88	23	0-2
				831.5	26865	21.95	23	0-2
				847.5	27025	21.74	23	0-2
			4	815.5	26705	21.90	23	0-2
				831.5	26865	22.01	23	0-2
				847.5	27025	21.79	23	0-2
			7	815.5	26705	22.06	23	0-2
				831.5	26865	21.83	23	0-2
				847.5	27025	21.78	23	0-2
		15RB	815.5	26705	22.00	23	0-2	
			831.5	26865	21.84	23	0-2	
			847.5	27025	21.98	23	0-2	

Unless otherwise stated the results shown in this test report refer only to the sample(s) tested and such sample(s) are retained for 90 days only.

除非另有說明，此報告結果僅對測試之樣品負責，同時此樣品僅保留90天。本報告未經本公司書面許可，不可部份複製。

This document is issued by the Company subject to its General Conditions of Service printed overleaf, available on request or accessible at www.sgs.com/terms_and_conditions.htm and for electronic format documents, subject to Terms and Conditions for Electronic Documents at www.sgs.com/terms_e-document.htm. Attention is drawn to the limitation of liability, indemnification and jurisdiction issues defined therein. Any holder of this document is advised that information contained hereon reflects the Company's findings at the time of its intervention only and within the limits of Client's instructions, if any. The Company's sole responsibility is to its Client and this document does not exonerate parties to a transaction from exercising all their rights and obligations under the transaction documents. This document cannot be reproduced except in full, without prior written approval of the Company. Any unauthorized alteration, forgery or falsification of the content or appearance of this document is unlawful and offenders may be prosecuted to the fullest extent of the law.

FDD Band 26									
BW(Mhz)	Modulation	RB Size	RB Offset	Frequency (MHz)	Channel	Conducted power (dBm)	Target Power + Max. Tolerance (dBm)	MPR Allowed per 3GPP(dB)	
1.4	QPSK	1 RB	0	814.7	26697	23.83	25	0	
				831.5	26865	23.75	25	0	
				848.3	27033	23.87	25	0	
			2	814.7	26697	24.06	25	0	
				831.5	26865	23.94	25	0	
				848.3	27033	23.75	25	0	
		5	814.7	26697	23.88	25	0		
			831.5	26865	23.70	25	0		
			848.3	27033	23.75	25	0		
		3 RB	0	814.7	26697	23.09	24	0-1	
				831.5	26865	23.02	24	0-1	
				848.3	27033	22.87	24	0-1	
			2	814.7	26697	23.15	24	0-1	
				831.5	26865	22.99	24	0-1	
				848.3	27033	22.76	24	0-1	
			3	814.7	26697	22.93	24	0-1	
				831.5	26865	23.02	24	0-1	
				848.3	27033	22.90	24	0-1	
		6RB	814.7	26697	23.08	24	0-1		
			831.5	26865	22.85	24	0-1		
			848.3	27033	22.81	24	0-1		
		16-QAM	1 RB	0	814.7	26697	23.08	24	0-1
					831.5	26865	23.19	24	0-1
					848.3	27033	23.42	24	0-1
	2			814.7	26697	23.26	24	0-1	
				831.5	26865	23.62	24	0-1	
				848.3	27033	22.84	24	0-1	
	5			814.7	26697	23.34	24	0-1	
				831.5	26865	22.92	24	0-1	
				848.3	27033	22.51	24	0-1	
	3 RB			0	814.7	26697	21.93	23	0-2
					831.5	26865	21.88	23	0-2
					848.3	27033	21.95	23	0-2
			2	814.7	26697	21.94	23	0-2	
				831.5	26865	22.01	23	0-2	
				848.3	27033	22.05	23	0-2	
			3	814.7	26697	21.89	23	0-2	
				831.5	26865	22.04	23	0-2	
				848.3	27033	21.77	23	0-2	
	6RB		814.7	26697	22.10	23	0-2		
			831.5	26865	21.81	23	0-2		
			848.3	27033	22.04	23	0-2		

Unless otherwise stated the results shown in this test report refer only to the sample(s) tested and such sample(s) are retained for 90 days only.

除非另有說明，此報告結果僅對測試之樣品負責，同時此樣品僅保留90天。本報告未經本公司書面許可，不可部份複製。

This document is issued by the Company subject to its General Conditions of Service printed overleaf, available on request or accessible at www.sgs.com/terms_and_conditions.htm and for electronic format documents, subject to Terms and Conditions for Electronic Documents at www.sgs.com/terms_e-document.htm. Attention is drawn to the limitation of liability, indemnification and jurisdiction issues defined therein. Any holder of this document is advised that information contained hereon reflects the Company's findings at the time of its intervention only and within the limits of Client's instructions, if any. The Company's sole responsibility is to its Client and this document does not exonerate parties to a transaction from exercising all their rights and obligations under the transaction documents. This document cannot be reproduced except in full, without prior written approval of the Company. Any unauthorized alteration, forgery or falsification of the content or appearance of this document is unlawful and offenders may be prosecuted to the fullest extent of the law.

FDD Band 26								
BW(Mhz)	Modulation	RB Size	RB Offset	Frequency (MHz)	Channel	Conducted power (dBm)	Target Power + Max. Tolerance (dBm)	MPR Allowed per 3GPP(dB)
1.4	64-QAM	1 RB	0	814.7	26697	22.87	24	0-1
				831.5	26865	23.11	24	0-1
				848.3	27033	23.38	24	0-1
			2	814.7	26697	23.01	24	0-1
				831.5	26865	23.31	24	0-1
				848.3	27033	23.00	24	0-1
			5	814.7	26697	23.26	24	0-1
				831.5	26865	22.70	24	0-1
				848.3	27033	22.58	24	0-1
		3 RB	0	814.7	26697	22.01	23	0-2
				831.5	26865	21.80	23	0-2
				848.3	27033	21.74	23	0-2
			2	814.7	26697	21.99	23	0-2
				831.5	26865	21.79	23	0-2
				848.3	27033	22.01	23	0-2
			3	814.7	26697	21.95	23	0-2
				831.5	26865	21.79	23	0-2
				848.3	27033	21.84	23	0-2
			6RB	814.7	26697	21.86	23	0-2
				831.5	26865	21.94	23	0-2
				848.3	27033	22.06	23	0-2

Unless otherwise stated the results shown in this test report refer only to the sample(s) tested and such sample(s) are retained for 90 days only.

除非另有說明，此報告結果僅對測試之樣品負責，同時此樣品僅保留90天。本報告未經本公司書面許可，不可部份複製。

This document is issued by the Company subject to its General Conditions of Service printed overleaf, available on request or accessible at www.sgs.com/terms_and_conditions.htm and for electronic format documents, subject to Terms and Conditions for Electronic Documents at www.sgs.com/terms_e-document.htm. Attention is drawn to the limitation of liability, indemnification and jurisdiction issues defined therein. Any holder of this document is advised that information contained hereon reflects the Company's findings at the time of its intervention only and within the limits of Client's instructions, if any. The Company's sole responsibility is to its Client and this document does not exonerate parties to a transaction from exercising all their rights and obligations under the transaction documents. This document cannot be reproduced except in full, without prior written approval of the Company. Any unauthorized alteration, forgery or falsification of the content or appearance of this document is unlawful and offenders may be prosecuted to the fullest extent of the law.

FDD Band 30									
BW(Mhz)	Modulation	RB Size	RB Offset	Frequency (MHz)	Channel	Conducted power (dBm)	Target Power + Max. Tolerance (dBm)	MPR Allowed per 3GPP(dB)	
10	QPSK	1 RB	0	2310	27710	22.99	23.5	0	
			25	2310	27710	22.98	23.5	0	
			49	2310	27710	22.96	23.5	0	
		25 RB	0	2310	27710	22.26	22.5	0-1	
			12	2310	27710	22.20	22.5	0-1	
			25	2310	27710	22.25	22.5	0-1	
		50RB		2310	27710	22.23	22.5	0-1	
		16-QAM	1 RB	0	2310	27710	22.44	22.5	0-1
				25	2310	27710	22.50	22.5	0-1
	49			2310	27710	22.43	22.5	0-1	
	25 RB		0	2310	27710	21.30	21.5	0-2	
			12	2310	27710	21.22	21.5	0-2	
			25	2310	27710	21.20	21.5	0-2	
	50RB		2310	27710	21.26	21.5	0-2		
	64-QAM		1 RB	0	2310	27710	22.21	22.5	0-1
				25	2310	27710	22.27	22.5	0-1
		49		2310	27710	22.50	22.5	0-1	
		25 RB	0	2310	27710	21.07	21.5	0-2	
			12	2310	27710	21.12	21.5	0-2	
			25	2310	27710	21.19	21.5	0-2	
		50RB		2310	27710	21.03	21.5	0-2	

Unless otherwise stated the results shown in this test report refer only to the sample(s) tested and such sample(s) are retained for 90 days only.

除非另有說明，此報告結果僅對測試之樣品負責，同時此樣品僅保留90天。本報告未經本公司書面許可，不可部份複製。

This document is issued by the Company subject to its General Conditions of Service printed overleaf, available on request or accessible at www.sgs.com/terms_and_conditions.htm and for electronic format documents, subject to Terms and Conditions for Electronic Documents at www.sgs.com/terms_e-document.htm. Attention is drawn to the limitation of liability, indemnification and jurisdiction issues defined therein. Any holder of this document is advised that information contained hereon reflects the Company's findings at the time of its intervention only and within the limits of Client's instructions, if any. The Company's sole responsibility is to its Client and this document does not exonerate parties to a transaction from exercising all their rights and obligations under the transaction documents. This document cannot be reproduced except in full, without prior written approval of the Company. Any unauthorized alteration, forgery or falsification of the content or appearance of this document is unlawful and offenders may be prosecuted to the fullest extent of the law.

FDD Band 30									
BW(Mhz)	Modulation	RB Size	RB Offset	Frequency (MHz)	Channel	Conducted power (dBm)	Target Power + Max. Tolerance (dBm)	MPR Allowed per 3GPP(dB)	
5	QPSK	1 RB	0	2307.5	27685	23.25	23.5	0	
				2310	27710	23.41	23.5	0	
				2312.5	27735	23.22	23.5	0	
			12	2307.5	27685	23.20	23.5	0	
				2310	27710	23.25	23.5	0	
				2312.5	27735	23.25	23.5	0	
		24	2307.5	27685	23.17	23.5	0		
			2310	27710	23.09	23.5	0		
			2312.5	27735	23.21	23.5	0		
		12 RB	0	2307.5	27685	22.25	22.5	0-1	
				2310	27710	22.23	22.5	0-1	
				2312.5	27735	22.19	22.5	0-1	
			6	2307.5	27685	22.02	22.5	0-1	
				2310	27710	22.06	22.5	0-1	
				2312.5	27735	22.18	22.5	0-1	
			13	2307.5	27685	22.20	22.5	0-1	
				2310	27710	22.07	22.5	0-1	
				2312.5	27735	22.17	22.5	0-1	
			25RB	2307.5	27685	22.16	22.5	0-1	
				2310	27710	22.06	22.5	0-1	
				2312.5	27735	22.16	22.5	0-1	
		16-QAM	1 RB	0	2307.5	27685	22.29	22.5	0-1
					2310	27710	22.25	22.5	0-1
					2312.5	27735	22.19	22.5	0-1
	12			2307.5	27685	22.21	22.5	0-1	
				2310	27710	22.27	22.5	0-1	
				2312.5	27735	22.47	22.5	0-1	
	24			2307.5	27685	22.27	22.5	0-1	
				2310	27710	22.40	22.5	0-1	
				2312.5	27735	22.42	22.5	0-1	
	12 RB			0	2307.5	27685	21.26	21.5	0-2
					2310	27710	21.09	21.5	0-2
					2312.5	27735	21.05	21.5	0-2
			6	2307.5	27685	21.06	21.5	0-2	
				2310	27710	21.19	21.5	0-2	
				2312.5	27735	21.02	21.5	0-2	
			13	2307.5	27685	21.03	21.5	0-2	
				2310	27710	21.09	21.5	0-2	
				2312.5	27735	21.04	21.5	0-2	
	25RB		2307.5	27685	21.04	21.5	0-2		
			2310	27710	21.13	21.5	0-2		
			2312.5	27735	21.13	21.5	0-2		

Unless otherwise stated the results shown in this test report refer only to the sample(s) tested and such sample(s) are retained for 90 days only.

除非另有說明，此報告結果僅對測試之樣品負責，同時此樣品僅保留90天。本報告未經本公司書面許可，不可部份複製。

This document is issued by the Company subject to its General Conditions of Service printed overleaf, available on request or accessible at www.sgs.com/terms_and_conditions.htm and for electronic format documents, subject to Terms and Conditions for Electronic Documents at www.sgs.com/terms_e-document.htm. Attention is drawn to the limitation of liability, indemnification and jurisdiction issues defined therein. Any holder of this document is advised that information contained hereon reflects the Company's findings at the time of its intervention only and within the limits of Client's instructions, if any. The Company's sole responsibility is to its Client and this document does not exonerate parties to a transaction from exercising all their rights and obligations under the transaction documents. This document cannot be reproduced except in full, without prior written approval of the Company. Any unauthorized alteration, forgery or falsification of the content or appearance of this document is unlawful and offenders may be prosecuted to the fullest extent of the law.

FDD Band 30								
BW(Mhz)	Modulation	RB Size	RB Offset	Frequency (MHz)	Channel	Conducted power (dBm)	Target Power + Max. Tolerance (dBm)	MPR Allowed per 3GPP(dB)
5	64-QAM	1 RB	0	2307.5	27685	22.14	22.5	0-1
				2310	27710	22.16	22.5	0-1
				2312.5	27735	22.06	22.5	0-1
			12	2307.5	27685	22.05	22.5	0-1
				2310	27710	22.15	22.5	0-1
				2312.5	27735	22.11	22.5	0-1
			24	2307.5	27685	22.28	22.5	0-1
				2310	27710	22.28	22.5	0-1
				2312.5	27735	22.31	22.5	0-1
		12 RB	0	2307.5	27685	21.04	21.5	0-2
				2310	27710	21.02	21.5	0-2
				2312.5	27735	21.07	21.5	0-2
			6	2307.5	27685	21.01	21.5	0-2
				2310	27710	21.03	21.5	0-2
				2312.5	27735	21.15	21.5	0-2
			13	2307.5	27685	21.02	21.5	0-2
				2310	27710	21.06	21.5	0-2
				2312.5	27735	21.18	21.5	0-2
			25RB	2307.5	27685	21.05	21.5	0-2
				2310	27710	21.07	21.5	0-2
				2312.5	27735	21.09	21.5	0-2

Unless otherwise stated the results shown in this test report refer only to the sample(s) tested and such sample(s) are retained for 90 days only.

除非另有說明，此報告結果僅對測試之樣品負責，同時此樣品僅保留90天。本報告未經本公司書面許可，不可部份複製。

This document is issued by the Company subject to its General Conditions of Service printed overleaf, available on request or accessible at www.sgs.com/terms_and_conditions.htm and for electronic format documents, subject to Terms and Conditions for Electronic Documents at www.sgs.com/terms_e-document.htm. Attention is drawn to the limitation of liability, indemnification and jurisdiction issues defined therein. Any holder of this document is advised that information contained hereon reflects the Company's findings at the time of its intervention only and within the limits of Client's instructions, if any. The Company's sole responsibility is to its Client and this document does not exonerate parties to a transaction from exercising all their rights and obligations under the transaction documents. This document cannot be reproduced except in full, without prior written approval of the Company. Any unauthorized alteration, forgery or falsification of the content or appearance of this document is unlawful and offenders may be prosecuted to the fullest extent of the law.

FDD Band 66									
BW(Mhz)	Modulation	RB Size	RB Offset	Frequency (MHz)	Channel	Conducted power (dBm)	Target Power + Max. Tolerance (dBm)	MPR Allowed per 3GPP(dB)	
20	QPSK	1 RB	0	1720	132072	24.49	24.5	0	
				1745	132322	24.28	24.5	0	
				1770	132572	24.47	24.5	0	
			50	1720	132072	24.18	24.5	0	
				1745	132322	24.18	24.5	0	
				1770	132572	24.32	24.5	0	
			99	1720	132072	24.24	24.5	0	
				1745	132322	24.15	24.5	0	
				1770	132572	24.23	24.5	0	
		50 RB	0	1720	132072	23.35	23.5	0-1	
				1745	132322	23.46	23.5	0-1	
				1770	132572	23.34	23.5	0-1	
			25	1720	132072	23.21	23.5	0-1	
				1745	132322	23.39	23.5	0-1	
				1770	132572	23.43	23.5	0-1	
			50	1720	132072	23.26	23.5	0-1	
				1745	132322	23.23	23.5	0-1	
				1770	132572	23.27	23.5	0-1	
			100RB	1720	132072	22.95	23.5	0-1	
				1745	132322	23.00	23.5	0-1	
				1770	132572	23.12	23.5	0-1	
		16-QAM	1 RB	0	1720	132072	23.46	23.5	0-1
					1745	132322	23.41	23.5	0-1
					1770	132572	23.44	23.5	0-1
	50			1720	132072	23.41	23.5	0-1	
				1745	132322	23.09	23.5	0-1	
				1770	132572	23.47	23.5	0-1	
	99			1720	132072	23.41	23.5	0-1	
				1745	132322	23.37	23.5	0-1	
				1770	132572	23.47	23.5	0-1	
	50 RB			0	1720	132072	22.29	22.5	0-2
					1745	132322	22.46	22.5	0-2
					1770	132572	22.43	22.5	0-2
			25	1720	132072	22.31	22.5	0-2	
				1745	132322	22.36	22.5	0-2	
				1770	132572	22.34	22.5	0-2	
			50	1720	132072	22.32	22.5	0-2	
				1745	132322	22.21	22.5	0-2	
				1770	132572	22.33	22.5	0-2	
	100RB		1720	132072	21.98	22.5	0-2		
			1745	132322	22.03	22.5	0-2		
			1770	132572	22.06	22.5	0-2		

Unless otherwise stated the results shown in this test report refer only to the sample(s) tested and such sample(s) are retained for 90 days only.

除非另有說明，此報告結果僅對測試之樣品負責，同時此樣品僅保留90天。本報告未經本公司書面許可，不可部份複製。

This document is issued by the Company subject to its General Conditions of Service printed overleaf, available on request or accessible at www.sgs.com/terms_and_conditions.htm and for electronic format documents, subject to Terms and Conditions for Electronic Documents at www.sgs.com/terms_e-document.htm. Attention is drawn to the limitation of liability, indemnification and jurisdiction issues defined therein. Any holder of this document is advised that information contained hereon reflects the Company's findings at the time of its intervention only and within the limits of Client's instructions, if any. The Company's sole responsibility is to its Client and this document does not exonerate parties to a transaction from exercising all their rights and obligations under the transaction documents. This document cannot be reproduced except in full, without prior written approval of the Company. Any unauthorized alteration, forgery or falsification of the content or appearance of this document is unlawful and offenders may be prosecuted to the fullest extent of the law.

FDD Band 66								
BW(Mhz)	Modulation	RB Size	RB Offset	Frequency (MHz)	Channel	Conducted power (dBm)	Target Power + Max. Tolerance (dBm)	MPR Allowed per 3GPP(dB)
20	64-QAM	1 RB	0	1720	132072	23.44	23.5	0-1
				1745	132322	23.49	23.5	0-1
				1770	132572	23.42	23.5	0-1
			50	1720	132072	23.49	23.5	0-1
				1745	132322	22.97	23.5	0-1
				1770	132572	23.45	23.5	0-1
			99	1720	132072	23.39	23.5	0-1
				1745	132322	23.25	23.5	0-1
				1770	132572	23.45	23.5	0-1
		50 RB	0	1720	132072	22.17	22.5	0-2
				1745	132322	22.34	22.5	0-2
				1770	132572	22.31	22.5	0-2
			25	1720	132072	22.19	22.5	0-2
				1745	132322	22.24	22.5	0-2
				1770	132572	22.22	22.5	0-2
			50	1720	132072	22.20	22.5	0-2
				1745	132322	22.09	22.5	0-2
				1770	132572	22.21	22.5	0-2
			100RB	1720	132072	21.86	22.5	0-2
				1745	132322	21.91	22.5	0-2
				1770	132572	21.94	22.5	0-2

Unless otherwise stated the results shown in this test report refer only to the sample(s) tested and such sample(s) are retained for 90 days only.

除非另有說明，此報告結果僅對測試之樣品負責，同時此樣品僅保留90天。本報告未經本公司書面許可，不可部份複製。

This document is issued by the Company subject to its General Conditions of Service printed overleaf, available on request or accessible at www.sgs.com/terms_and_conditions.htm and for electronic format documents, subject to Terms and Conditions for Electronic Documents at www.sgs.com/terms_e-document.htm. Attention is drawn to the limitation of liability, indemnification and jurisdiction issues defined therein. Any holder of this document is advised that information contained hereon reflects the Company's findings at the time of its intervention only and within the limits of Client's instructions, if any. The Company's sole responsibility is to its Client and this document does not exonerate parties to a transaction from exercising all their rights and obligations under the transaction documents. This document cannot be reproduced except in full, without prior written approval of the Company. Any unauthorized alteration, forgery or falsification of the content or appearance of this document is unlawful and offenders may be prosecuted to the fullest extent of the law.

FDD Band 66									
BW(Mhz)	Modulation	RB Size	RB Offset	Frequency (MHz)	Channel	Conducted power (dBm)	Target Power + Max. Tolerance (dBm)	MPR Allowed per 3GPP(dB)	
15	QPSK	1 RB	0	1717.5	132047	24.37	24.5	0	
				1745	132322	24.21	24.5	0	
				1772.5	132597	24.43	24.5	0	
			36	1717.5	132047	24.05	24.5	0	
				1745	132322	24.08	24.5	0	
				1772.5	132597	24.29	24.5	0	
		74	1717.5	132047	24.03	24.5	0		
			1745	132322	23.91	24.5	0		
			1772.5	132597	24.15	24.5	0		
		36 RB	0	1717.5	132047	23.27	23.5	0-1	
				1745	132322	23.25	23.5	0-1	
				1772.5	132597	23.28	23.5	0-1	
			18	1717.5	132047	23.18	23.5	0-1	
				1745	132322	23.14	23.5	0-1	
				1772.5	132597	23.21	23.5	0-1	
			37	1717.5	132047	23.06	23.5	0-1	
				1745	132322	23.04	23.5	0-1	
				1772.5	132597	23.26	23.5	0-1	
			75RB	1717.5	132047	22.82	23.5	0-1	
				1745	132322	22.86	23.5	0-1	
				1772.5	132597	23.09	23.5	0-1	
		16-QAM	1 RB	0	1717.5	132047	23.46	23.5	0-1
					1745	132322	23.4	23.5	0-1
					1772.5	132597	23.42	23.5	0-1
	36			1717.5	132047	23.33	23.5	0-1	
				1745	132322	22.97	23.5	0-1	
				1772.5	132597	23.32	23.5	0-1	
	74			1717.5	132047	23.43	23.5	0-1	
				1745	132322	23.23	23.5	0-1	
				1772.5	132597	23.35	23.5	0-1	
	36 RB			0	1717.5	132047	22.01	22.5	0-2
					1745	132322	22.38	22.5	0-2
					1772.5	132597	22.25	22.5	0-2
			18	1717.5	132047	22.08	22.5	0-2	
				1745	132322	22.17	22.5	0-2	
				1772.5	132597	22.19	22.5	0-2	
			37	1717.5	132047	22.06	22.5	0-2	
				1745	132322	21.97	22.5	0-2	
				1772.5	132597	22.22	22.5	0-2	
			75RB	1717.5	132047	21.87	22.5	0-2	
				1745	132322	22.03	22.5	0-2	
				1772.5	132597	22	22.5	0-2	

Unless otherwise stated the results shown in this test report refer only to the sample(s) tested and such sample(s) are retained for 90 days only.

除非另有說明，此報告結果僅對測試之樣品負責，同時此樣品僅保留90天。本報告未經本公司書面許可，不可部份複製。

This document is issued by the Company subject to its General Conditions of Service printed overleaf, available on request or accessible at www.sgs.com/terms_and_conditions.htm and for electronic format documents, subject to Terms and Conditions for Electronic Documents at www.sgs.com/terms_e-document.htm. Attention is drawn to the limitation of liability, indemnification and jurisdiction issues defined therein. Any holder of this document is advised that information contained hereon reflects the Company's findings at the time of its intervention only and within the limits of Client's instructions, if any. The Company's sole responsibility is to its Client and this document does not exonerate parties to a transaction from exercising all their rights and obligations under the transaction documents. This document cannot be reproduced except in full, without prior written approval of the Company. Any unauthorized alteration, forgery or falsification of the content or appearance of this document is unlawful and offenders may be prosecuted to the fullest extent of the law.

FDD Band 66										
BW(MHz)	Modulation	RB Size	RB Offset	Frequency (MHz)	Channel	Conducted power (dBm)	Target Power + Max. Tolerance (dBm)	MPR Allowed per 3GPP(dB)		
15	64-QAM	1 RB	0	1717.5	132047	23.49	23.5	0-1		
				1745	132322	23.44	23.5	0-1		
				1772.5	132597	23.47	23.5	0-1		
			36	74	1717.5	132047	23.38	23.5	0-1	
					1745	132322	22.88	23.5	0-1	
					1772.5	132597	23.19	23.5	0-1	
			36 RB	0	18	1717.5	132047	22.09	22.5	0-2
						1745	132322	22.08	22.5	0-2
						1772.5	132597	22.03	22.5	0-2
		37		75RB	1717.5	132047	22.03	22.5	0-2	
					1745	132322	22.15	22.5	0-2	
					1772.5	132597	22.15	22.5	0-2	
		75RB		0	1717.5	132047	21.98	22.5	0-2	
					1745	132322	21.95	22.5	0-2	
					1772.5	132597	21.92	22.5	0-2	
		75RB		0	1717.5	132047	21.59	22.5	0-2	
					1745	132322	21.66	22.5	0-2	
					1772.5	132597	21.92	22.5	0-2	

Unless otherwise stated the results shown in this test report refer only to the sample(s) tested and such sample(s) are retained for 90 days only.

除非另有說明，此報告結果僅對測試之樣品負責，同時此樣品僅保留90天。本報告未經本公司書面許可，不可部份複製。

This document is issued by the Company subject to its General Conditions of Service printed overleaf, available on request or accessible at www.sgs.com/terms_and_conditions.htm and for electronic format documents, subject to Terms and Conditions for Electronic Documents at www.sgs.com/terms_e-document.htm. Attention is drawn to the limitation of liability, indemnification and jurisdiction issues defined therein. Any holder of this document is advised that information contained hereon reflects the Company's findings at the time of its intervention only and within the limits of Client's instructions, if any. The Company's sole responsibility is to its Client and this document does not exonerate parties to a transaction from exercising all their rights and obligations under the transaction documents. This document cannot be reproduced except in full, without prior written approval of the Company. Any unauthorized alteration, forgery or falsification of the content or appearance of this document is unlawful and offenders may be prosecuted to the fullest extent of the law.

FDD Band 66									
BW(Mhz)	Modulation	RB Size	RB Offset	Frequency (MHz)	Channel	Conducted power (dBm)	Target Power + Max. Tolerance (dBm)	MPR Allowed per 3GPP(dB)	
10	QPSK	1 RB	0	1715	132022	24.32	24.5	0	
				1745	132322	24.20	24.5	0	
				1775	132622	24.45	24.5	0	
			25	1715	132022	24.13	24.5	0	
				1745	132322	24.13	24.5	0	
				1775	132622	24.23	24.5	0	
			49	1715	132022	24.22	24.5	0	
				1745	132322	24.09	24.5	0	
				1775	132622	24.19	24.5	0	
		25 RB	0	1715	132022	23.12	23.5	0-1	
				1745	132322	23.25	23.5	0-1	
				1775	132622	23.26	23.5	0-1	
			12	1715	132022	23.00	23.5	0-1	
				1745	132322	23.31	23.5	0-1	
				1775	132622	23.17	23.5	0-1	
			25	1715	132022	23.23	23.5	0-1	
				1745	132322	23.18	23.5	0-1	
				1775	132622	23.07	23.5	0-1	
			50RB	1715	132022	22.73	23.5	0-1	
				1745	132322	22.81	23.5	0-1	
				1775	132622	23.01	23.5	0-1	
		16-QAM	1 RB	0	1715	132022	23.45	23.5	0-1
					1745	132322	23.49	23.5	0-1
					1775	132622	23.48	23.5	0-1
	25			1715	132022	23.49	23.5	0-1	
				1745	132322	22.93	23.5	0-1	
				1775	132622	23.43	23.5	0-1	
	49			1715	132022	23.45	23.5	0-1	
				1745	132322	23.32	23.5	0-1	
				1775	132622	23.43	23.5	0-1	
	25 RB			0	1715	132022	22.25	22.5	0-2
					1745	132322	22.19	22.5	0-2
					1775	132622	22.20	22.5	0-2
			12	1715	132022	22.25	22.5	0-2	
				1745	132322	22.32	22.5	0-2	
				1775	132622	22.19	22.5	0-2	
			25	1715	132022	22.25	22.5	0-2	
				1745	132322	21.99	22.5	0-2	
				1775	132622	22.18	22.5	0-2	
	50RB		1715	132022	21.70	22.5	0-2		
			1745	132322	21.80	22.5	0-2		
			1775	132622	21.81	22.5	0-2		

Unless otherwise stated the results shown in this test report refer only to the sample(s) tested and such sample(s) are retained for 90 days only.

除非另有說明，此報告結果僅對測試之樣品負責，同時此樣品僅保留90天。本報告未經本公司書面許可，不可部份複製。

This document is issued by the Company subject to its General Conditions of Service printed overleaf, available on request or accessible at www.sgs.com/terms_and_conditions.htm and for electronic format documents, subject to Terms and Conditions for Electronic Documents at www.sgs.com/terms_e-document.htm. Attention is drawn to the limitation of liability, indemnification and jurisdiction issues defined therein. Any holder of this document is advised that information contained hereon reflects the Company's findings at the time of its intervention only and within the limits of Client's instructions, if any. The Company's sole responsibility is to its Client and this document does not exonerate parties to a transaction from exercising all their rights and obligations under the transaction documents. This document cannot be reproduced except in full, without prior written approval of the Company. Any unauthorized alteration, forgery or falsification of the content or appearance of this document is unlawful and offenders may be prosecuted to the fullest extent of the law.

FDD Band 66								
BW(MHz)	Modulation	RB Size	RB Offset	Frequency (MHz)	Channel	Conducted power (dBm)	Target Power + Max. Tolerance (dBm)	MPR Allowed per 3GPP(dB)
10	64-QAM	1 RB	0	1715	132022	23.40	23.5	0-1
				1745	132322	23.38	23.5	0-1
				1775	132622	23.47	23.5	0-1
			25	1715	132022	23.22	23.5	0-1
				1745	132322	22.96	23.5	0-1
				1775	132622	23.19	23.5	0-1
			49	1715	132022	23.49	23.5	0-1
				1745	132322	23.20	23.5	0-1
				1775	132622	23.36	23.5	0-1
		25 RB	0	1715	132022	21.97	22.5	0-2
				1745	132322	22.05	22.5	0-2
				1775	132622	22.14	22.5	0-2
			12	1715	132022	21.93	22.5	0-2
				1745	132322	22.09	22.5	0-2
				1775	132622	21.93	22.5	0-2
			25	1715	132022	21.90	22.5	0-2
				1745	132322	21.93	22.5	0-2
				1775	132622	21.98	22.5	0-2
			50RB	1715	132022	21.70	22.5	0-2
				1745	132322	21.76	22.5	0-2
				1775	132622	21.91	22.5	0-2

Unless otherwise stated the results shown in this test report refer only to the sample(s) tested and such sample(s) are retained for 90 days only.

除非另有說明，此報告結果僅對測試之樣品負責，同時此樣品僅保留90天。本報告未經本公司書面許可，不可部份複製。

This document is issued by the Company subject to its General Conditions of Service printed overleaf, available on request or accessible at www.sgs.com/terms_and_conditions.htm and for electronic format documents, subject to Terms and Conditions for Electronic Documents at www.sgs.com/terms_e-document.htm. Attention is drawn to the limitation of liability, indemnification and jurisdiction issues defined therein. Any holder of this document is advised that information contained hereon reflects the Company's findings at the time of its intervention only and within the limits of Client's instructions, if any. The Company's sole responsibility is to its Client and this document does not exonerate parties to a transaction from exercising all their rights and obligations under the transaction documents. This document cannot be reproduced except in full, without prior written approval of the Company. Any unauthorized alteration, forgery or falsification of the content or appearance of this document is unlawful and offenders may be prosecuted to the fullest extent of the law.

FDD Band 66									
BW(Mhz)	Modulation	RB Size	RB Offset	Frequency (MHz)	Channel	Conducted power (dBm)	Target Power + Max. Tolerance (dBm)	MPR Allowed per 3GPP(dB)	
5	QPSK	1 RB	0	1712.5	131997	24.23	24.5	0	
				1745	132322	24.05	24.5	0	
				1777.5	132647	24.37	24.5	0	
			12	1712.5	131997	24.15	24.5	0	
				1745	132322	24.00	24.5	0	
				1777.5	132647	24.31	24.5	0	
		24	1712.5	131997	24.05	24.5	0		
			1745	132322	23.95	24.5	0		
			1777.5	132647	24.07	24.5	0		
		12 RB	0	1712.5	131997	23.17	23.5	0-1	
				1745	132322	23.45	23.5	0-1	
				1777.5	132647	23.11	23.5	0-1	
			6	1712.5	131997	23.11	23.5	0-1	
				1745	132322	23.38	23.5	0-1	
				1777.5	132647	23.34	23.5	0-1	
			13	1712.5	131997	23.00	23.5	0-1	
				1745	132322	22.95	23.5	0-1	
				1777.5	132647	23.07	23.5	0-1	
			25RB	1712.5	131997	22.71	23.5	0-1	
				1745	132322	22.96	23.5	0-1	
				1777.5	132647	23.00	23.5	0-1	
		16-QAM	1 RB	0	1712.5	131997	23.42	23.5	0-1
					1745	132322	23.38	23.5	0-1
					1777.5	132647	23.40	23.5	0-1
	12			1712.5	131997	23.41	23.5	0-1	
				1745	132322	22.82	23.5	0-1	
				1777.5	132647	23.43	23.5	0-1	
	24			1712.5	131997	23.40	23.5	0-1	
				1745	132322	23.21	23.5	0-1	
				1777.5	132647	23.44	23.5	0-1	
	12 RB			0	1712.5	131997	22.26	22.5	0-2
					1745	132322	22.20	22.5	0-2
					1777.5	132647	22.19	22.5	0-2
			6	1712.5	131997	22.21	22.5	0-2	
				1745	132322	22.09	22.5	0-2	
				1777.5	132647	22.31	22.5	0-2	
			13	1712.5	131997	22.10	22.5	0-2	
				1745	132322	21.96	22.5	0-2	
				1777.5	132647	22.31	22.5	0-2	
			25RB	1712.5	131997	21.69	22.5	0-2	
				1745	132322	21.94	22.5	0-2	
				1777.5	132647	21.92	22.5	0-2	

Unless otherwise stated the results shown in this test report refer only to the sample(s) tested and such sample(s) are retained for 90 days only.

除非另有說明，此報告結果僅對測試之樣品負責，同時此樣品僅保留90天。本報告未經本公司書面許可，不可部份複製。

This document is issued by the Company subject to its General Conditions of Service printed overleaf, available on request or accessible at www.sgs.com/terms_and_conditions.htm and for electronic format documents, subject to Terms and Conditions for Electronic Documents at www.sgs.com/terms_e-document.htm. Attention is drawn to the limitation of liability, indemnification and jurisdiction issues defined therein. Any holder of this document is advised that information contained hereon reflects the Company's findings at the time of its intervention only and within the limits of Client's instructions, if any. The Company's sole responsibility is to its Client and this document does not exonerate parties to a transaction from exercising all their rights and obligations under the transaction documents. This document cannot be reproduced except in full, without prior written approval of the Company. Any unauthorized alteration, forgery or falsification of the content or appearance of this document is unlawful and offenders may be prosecuted to the fullest extent of the law.

FDD Band 66								
BW(MHz)	Modulation	RB Size	RB Offset	Frequency (MHz)	Channel	Conducted power (dBm)	Target Power + Max. Tolerance (dBm)	MPR Allowed per 3GPP(dB)
5	64-QAM	1 RB	0	1712.5	131997	23.43	23.5	0-1
				1745	132322	23.43	23.5	0-1
				1777.5	132647	23.48	23.5	0-1
			12	1712.5	131997	23.37	23.5	0-1
				1745	132322	22.85	23.5	0-1
				1777.5	132647	23.37	23.5	0-1
			24	1712.5	131997	23.45	23.5	0-1
				1745	132322	23.07	23.5	0-1
				1777.5	132647	23.31	23.5	0-1
		12 RB	0	1712.5	131997	22.14	22.5	0-2
				1745	132322	22.22	22.5	0-2
				1777.5	132647	22.22	22.5	0-2
			6	1712.5	131997	22.01	22.5	0-2
				1745	132322	22.19	22.5	0-2
				1777.5	132647	22.07	22.5	0-2
			13	1712.5	131997	22.03	22.5	0-2
				1745	132322	21.92	22.5	0-2
				1777.5	132647	22.01	22.5	0-2
		25RB	1712.5	131997	21.80	22.5	0-2	
			1745	132322	21.67	22.5	0-2	
			1777.5	132647	21.78	22.5	0-2	

Unless otherwise stated the results shown in this test report refer only to the sample(s) tested and such sample(s) are retained for 90 days only.

除非另有說明，此報告結果僅對測試之樣品負責，同時此樣品僅保留90天。本報告未經本公司書面許可，不可部份複製。

This document is issued by the Company subject to its General Conditions of Service printed overleaf, available on request or accessible at www.sgs.com/terms_and_conditions.htm and for electronic format documents, subject to Terms and Conditions for Electronic Documents at www.sgs.com/terms_e-document.htm. Attention is drawn to the limitation of liability, indemnification and jurisdiction issues defined therein. Any holder of this document is advised that information contained hereon reflects the Company's findings at the time of its intervention only and within the limits of Client's instructions, if any. The Company's sole responsibility is to its Client and this document does not exonerate parties to a transaction from exercising all their rights and obligations under the transaction documents. This document cannot be reproduced except in full, without prior written approval of the Company. Any unauthorized alteration, forgery or falsification of the content or appearance of this document is unlawful and offenders may be prosecuted to the fullest extent of the law.

FDD Band 66									
BW(Mhz)	Modulation	RB Size	RB Offset	Frequency (MHz)	Channel	Conducted power (dBm)	Target Power + Max. Tolerance (dBm)	MPR Allowed per 3GPP(dB)	
3	QPSK	1 RB	0	1711.5	131987	24.36	24.5	0	
				1745	132322	24.06	24.5	0	
				1778.5	132657	24.27	24.5	0	
			7	1711.5	131987	23.99	24.5	0	
				1745	132322	24.08	24.5	0	
				1778.5	132657	24.16	24.5	0	
		14	1711.5	131987	24.08	24.5	0		
			1745	132322	24.10	24.5	0		
			1778.5	132657	24.22	24.5	0		
		8 RB	0	1711.5	131987	23.28	23.5	0-1	
				1745	132322	23.42	23.5	0-1	
				1778.5	132657	23.11	23.5	0-1	
			4	1711.5	131987	23.20	23.5	0-1	
				1745	132322	23.30	23.5	0-1	
				1778.5	132657	23.21	23.5	0-1	
			7	1711.5	131987	23.10	23.5	0-1	
				1745	132322	23.03	23.5	0-1	
				1778.5	132657	23.15	23.5	0-1	
		15RB	1711.5	131987	22.79	23.5	0-1		
			1745	132322	22.92	23.5	0-1		
			1778.5	132657	22.86	23.5	0-1		
		16-QAM	1 RB	0	1711.5	131987	23.39	23.5	0-1
					1745	132322	23.33	23.5	0-1
					1778.5	132657	23.42	23.5	0-1
	7			1711.5	131987	23.45	23.5	0-1	
				1745	132322	22.94	23.5	0-1	
				1778.5	132657	23.34	23.5	0-1	
	14			1711.5	131987	23.42	23.5	0-1	
				1745	132322	23.34	23.5	0-1	
				1778.5	132657	23.44	23.5	0-1	
	8 RB			0	1711.5	131987	22.20	22.5	0-2
					1745	132322	22.29	22.5	0-2
					1778.5	132657	22.38	22.5	0-2
			4	1711.5	131987	22.03	22.5	0-2	
				1745	132322	22.24	22.5	0-2	
				1778.5	132657	22.15	22.5	0-2	
			7	1711.5	131987	22.16	22.5	0-2	
				1745	132322	22.19	22.5	0-2	
				1778.5	132657	22.07	22.5	0-2	
	15RB		1711.5	131987	21.72	22.5	0-2		
			1745	132322	21.76	22.5	0-2		
			1778.5	132657	22.03	22.5	0-2		

Unless otherwise stated the results shown in this test report refer only to the sample(s) tested and such sample(s) are retained for 90 days only.

除非另有說明，此報告結果僅對測試之樣品負責，同時此樣品僅保留90天。本報告未經本公司書面許可，不可部份複製。

This document is issued by the Company subject to its General Conditions of Service printed overleaf, available on request or accessible at www.sgs.com/terms_and_conditions.htm and for electronic format documents, subject to Terms and Conditions for Electronic Documents at www.sgs.com/terms_e-document.htm. Attention is drawn to the limitation of liability, indemnification and jurisdiction issues defined therein. Any holder of this document is advised that information contained hereon reflects the Company's findings at the time of its intervention only and within the limits of Client's instructions, if any. The Company's sole responsibility is to its Client and this document does not exonerate parties to a transaction from exercising all their rights and obligations under the transaction documents. This document cannot be reproduced except in full, without prior written approval of the Company. Any unauthorized alteration, forgery or falsification of the content or appearance of this document is unlawful and offenders may be prosecuted to the fullest extent of the law.

FDD Band 66								
BW(Mhz)	Modulation	RB Size	RB Offset	Frequency (MHz)	Channel	Conducted power (dBm)	Target Power + Max. Tolerance (dBm)	MPR Allowed per 3GPP(dB)
3	64-QAM	1 RB	0	1711.5	131987	23.41	23.5	0-1
				1745	132322	23.40	23.5	0-1
				1778.5	132657	23.41	23.5	0-1
			7	1711.5	131987	23.35	23.5	0-1
				1745	132322	22.96	23.5	0-1
				1778.5	132657	23.39	23.5	0-1
			14	1711.5	131987	23.43	23.5	0-1
				1745	132322	23.09	23.5	0-1
				1778.5	132657	23.34	23.5	0-1
		8 RB	0	1711.5	131987	22.13	22.5	0-2
				1745	132322	22.33	22.5	0-2
				1778.5	132657	22.19	22.5	0-2
			4	1711.5	131987	22.15	22.5	0-2
				1745	132322	22.07	22.5	0-2
				1778.5	132657	22.18	22.5	0-2
			7	1711.5	131987	22.00	22.5	0-2
				1745	132322	21.94	22.5	0-2
				1778.5	132657	22.03	22.5	0-2
		15RB	1711.5	131987	21.58	22.5	0-2	
			1745	132322	21.78	22.5	0-2	
			1778.5	132657	21.73	22.5	0-2	

Unless otherwise stated the results shown in this test report refer only to the sample(s) tested and such sample(s) are retained for 90 days only.

除非另有說明，此報告結果僅對測試之樣品負責，同時此樣品僅保留90天。本報告未經本公司書面許可，不可部份複製。

This document is issued by the Company subject to its General Conditions of Service printed overleaf, available on request or accessible at www.sgs.com/terms_and_conditions.htm and for electronic format documents, subject to Terms and Conditions for Electronic Documents at www.sgs.com/terms_e-document.htm. Attention is drawn to the limitation of liability, indemnification and jurisdiction issues defined therein. Any holder of this document is advised that information contained hereon reflects the Company's findings at the time of its intervention only and within the limits of Client's instructions, if any. The Company's sole responsibility is to its Client and this document does not exonerate parties to a transaction from exercising all their rights and obligations under the transaction documents. This document cannot be reproduced except in full, without prior written approval of the Company. Any unauthorized alteration, forgery or falsification of the content or appearance of this document is unlawful and offenders may be prosecuted to the fullest extent of the law.

FDD Band 66									
BW(Mhz)	Modulation	RB Size	RB Offset	Frequency (MHz)	Channel	Conducted power (dBm)	Target Power + Max. Tolerance (dBm)	MPR Allowed per 3GPP(dB)	
1.4	QPSK	1 RB	0	1710.7	131979	24.48	24.5	0	
				1745	132322	24.00	24.5	0	
				1779.3	132665	24.42	24.5	0	
			2	1710.7	131979	23.92	24.5	0	
				1745	132322	23.89	24.5	0	
				1779.3	132665	24.11	24.5	0	
		5	1710.7	131979	24.09	24.5	0		
			1745	132322	24.12	24.5	0		
			1779.3	132665	24.07	24.5	0		
		3 RB	0	1710.7	131979	23.35	23.5	0-1	
				1745	132322	23.31	23.5	0-1	
				1779.3	132665	23.17	23.5	0-1	
			2	1710.7	131979	23.20	23.5	0-1	
				1745	132322	23.15	23.5	0-1	
				1779.3	132665	23.13	23.5	0-1	
			3	1710.7	131979	23.22	23.5	0-1	
				1745	132322	22.97	23.5	0-1	
				1779.3	132665	23.05	23.5	0-1	
		6RB	1710.7	131979	22.83	23.5	0-1		
			1745	132322	22.95	23.5	0-1		
			1779.3	132665	23.00	23.5	0-1		
		16-QAM	1 RB	0	1710.7	131979	23.43	23.5	0-1
					1745	132322	23.44	23.5	0-1
					1779.3	132665	23.49	23.5	0-1
	2			1710.7	131979	23.40	23.5	0-1	
				1745	132322	23.06	23.5	0-1	
				1779.3	132665	23.33	23.5	0-1	
	5			1710.7	131979	23.41	23.5	0-1	
				1745	132322	23.13	23.5	0-1	
				1779.3	132665	23.45	23.5	0-1	
	3 RB			0	1710.7	131979	22.13	22.5	0-2
					1745	132322	22.17	22.5	0-2
					1779.3	132665	22.42	22.5	0-2
			2	1710.7	131979	22.20	22.5	0-2	
				1745	132322	22.31	22.5	0-2	
				1779.3	132665	22.23	22.5	0-2	
			3	1710.7	131979	22.27	22.5	0-2	
				1745	132322	21.96	22.5	0-2	
				1779.3	132665	22.31	22.5	0-2	
	6RB		1710.7	131979	21.85	22.5	0-2		
			1745	132322	21.76	22.5	0-2		
			1779.3	132665	21.80	22.5	0-2		

Unless otherwise stated the results shown in this test report refer only to the sample(s) tested and such sample(s) are retained for 90 days only.

除非另有說明，此報告結果僅對測試之樣品負責，同時此樣品僅保留90天。本報告未經本公司書面許可，不可部份複製。

This document is issued by the Company subject to its General Conditions of Service printed overleaf, available on request or accessible at www.sgs.com/terms_and_conditions.htm and for electronic format documents, subject to Terms and Conditions for Electronic Documents at www.sgs.com/terms_e-document.htm. Attention is drawn to the limitation of liability, indemnification and jurisdiction issues defined therein. Any holder of this document is advised that information contained hereon reflects the Company's findings at the time of its intervention only and within the limits of Client's instructions, if any. The Company's sole responsibility is to its Client and this document does not exonerate parties to a transaction from exercising all their rights and obligations under the transaction documents. This document cannot be reproduced except in full, without prior written approval of the Company. Any unauthorized alteration, forgery or falsification of the content or appearance of this document is unlawful and offenders may be prosecuted to the fullest extent of the law.

FDD Band 66								
BW(MHz)	Modulation	RB Size	RB Offset	Frequency (MHz)	Channel	Conducted power (dBm)	Target Power + Max. Tolerance (dBm)	MPR Allowed per 3GPP(dB)
1.4	64-QAM	1 RB	0	1710.7	131979	23.44	23.5	0-1
				1745	132322	23.46	23.5	0-1
				1779.3	132665	23.38	23.5	0-1
			2	1710.7	131979	23.49	23.5	0-1
				1745	132322	22.69	23.5	0-1
				1779.3	132665	23.43	23.5	0-1
			5	1710.7	131979	23.30	23.5	0-1
				1745	132322	23.23	23.5	0-1
				1779.3	132665	23.27	23.5	0-1
		3 RB	0	1710.7	131979	21.91	22.5	0-2
				1745	132322	22.31	22.5	0-2
				1779.3	132665	22.08	22.5	0-2
			2	1710.7	131979	22.04	22.5	0-2
				1745	132322	22.24	22.5	0-2
				1779.3	132665	22.13	22.5	0-2
			3	1710.7	131979	22.02	22.5	0-2
				1745	132322	21.99	22.5	0-2
				1779.3	132665	22.17	22.5	0-2
		6RB	1710.7	131979	21.68	22.5	0-2	
			1745	132322	21.62	22.5	0-2	
			1779.3	132665	21.81	22.5	0-2	

Unless otherwise stated the results shown in this test report refer only to the sample(s) tested and such sample(s) are retained for 90 days only.

除非另有說明，此報告結果僅對測試之樣品負責，同時此樣品僅保留90天。本報告未經本公司書面許可，不可部份複製。

This document is issued by the Company subject to its General Conditions of Service printed overleaf, available on request or accessible at www.sgs.com/terms_and_conditions.htm and for electronic format documents, subject to Terms and Conditions for Electronic Documents at www.sgs.com/terms_e-document.htm. Attention is drawn to the limitation of liability, indemnification and jurisdiction issues defined therein. Any holder of this document is advised that information contained hereon reflects the Company's findings at the time of its intervention only and within the limits of Client's instructions, if any. The Company's sole responsibility is to its Client and this document does not exonerate parties to a transaction from exercising all their rights and obligations under the transaction documents. This document cannot be reproduced except in full, without prior written approval of the Company. Any unauthorized alteration, forgery or falsification of the content or appearance of this document is unlawful and offenders may be prosecuted to the fullest extent of the law.

LTE TDD Band 38 / Band 41 power table (Full power):

TDD Band 38									
BW(Mhz)	Modulation	RB Size	RB Offset	Frequency (MHz)	Channel	Conducted power (dBm)	Target Power + Max. Tolerance (dBm)	MPR Allowed per 3GPP(dB)	
20	QPSK	1 RB	0	2580	37850	23.99	24.5	0	
				2595	38000	23.83	24.5	0	
				2610	38150	23.78	24.5	0	
			50	2580	37850	23.59	24.5	0	
				2595	38000	23.56	24.5	0	
				2610	38150	23.50	24.5	0	
			99	2580	37850	23.56	24.5	0	
				2595	38000	23.72	24.5	0	
				2610	38150	23.58	24.5	0	
		50 RB	0	2580	37850	22.96	23.5	0-1	
				2595	38000	22.73	23.5	0-1	
				2610	38150	22.78	23.5	0-1	
			25	2580	37850	22.87	23.5	0-1	
				2595	38000	22.70	23.5	0-1	
				2610	38150	22.69	23.5	0-1	
			50	2580	37850	22.67	23.5	0-1	
				2595	38000	22.65	23.5	0-1	
				2610	38150	22.72	23.5	0-1	
		100RB	2580	37850	22.80	23.5	0-1		
			2595	38000	22.75	23.5	0-1		
			2610	38150	22.69	23.5	0-1		
		16-QAM	1 RB	0	2580	37850	23.15	23.5	0-1
					2595	38000	23.06	23.5	0-1
					2610	38150	23.06	23.5	0-1
	50			2580	37850	22.95	23.5	0-1	
				2595	38000	22.79	23.5	0-1	
				2610	38150	22.81	23.5	0-1	
	99			2580	37850	22.81	23.5	0-1	
				2595	38000	22.90	23.5	0-1	
				2610	38150	22.84	23.5	0-1	
	50 RB			0	2580	37850	21.96	22.5	0-2
					2595	38000	21.85	22.5	0-2
					2610	38150	21.83	22.5	0-2
			25	2580	37850	21.83	22.5	0-2	
				2595	38000	21.75	22.5	0-2	
				2610	38150	21.70	22.5	0-2	
			50	2580	37850	21.73	22.5	0-2	
				2595	38000	21.60	22.5	0-2	
				2610	38150	21.65	22.5	0-2	
	100RB		2580	37850	21.79	22.5	0-2		
			2595	38000	21.69	22.5	0-2		
			2610	38150	21.73	22.5	0-2		

Unless otherwise stated the results shown in this test report refer only to the sample(s) tested and such sample(s) are retained for 90 days only.

除非另有說明，此報告結果僅對測試之樣品負責，同時此樣品僅保留90天。本報告未經本公司書面許可，不可部份複製。

This document is issued by the Company subject to its General Conditions of Service printed overleaf, available on request or accessible at www.sgs.com/terms_and_conditions.htm and for electronic format documents, subject to Terms and Conditions for Electronic Documents at www.sgs.com/terms_e-document.htm. Attention is drawn to the limitation of liability, indemnification and jurisdiction issues defined therein. Any holder of this document is advised that information contained hereon reflects the Company's findings at the time of its intervention only and within the limits of Client's instructions, if any. The Company's sole responsibility is to its Client and this document does not exonerate parties to a transaction from exercising all their rights and obligations under the transaction documents. This document cannot be reproduced except in full, without prior written approval of the Company. Any unauthorized alteration, forgery or falsification of the content or appearance of this document is unlawful and offenders may be prosecuted to the fullest extent of the law.

TDD Band 38								
BW(Mhz)	Modulation	RB Size	RB Offset	Frequency (MHz)	Channel	Conducted power (dBm)	Target Power + Max. Tolerance (dBm)	MPR Allowed per 3GPP(dB)
20	64-QAM	1 RB	0	2580	37850	23.07	23.5	0-1
				2595	38000	22.98	23.5	0-1
				2610	38150	22.98	23.5	0-1
			50	2580	37850	22.87	23.5	0-1
				2595	38000	22.71	23.5	0-1
				2610	38150	22.73	23.5	0-1
			99	2580	37850	22.73	23.5	0-1
				2595	38000	22.82	23.5	0-1
				2610	38150	22.76	23.5	0-1
		50 RB	0	2580	37850	21.88	22.5	0-2
				2595	38000	21.77	22.5	0-2
				2610	38150	21.75	22.5	0-2
			25	2580	37850	21.75	22.5	0-2
				2595	38000	21.67	22.5	0-2
				2610	38150	21.62	22.5	0-2
			50	2580	37850	21.65	22.5	0-2
				2595	38000	21.52	22.5	0-2
				2610	38150	21.57	22.5	0-2
			100RB	2580	37850	21.71	22.5	0-2
				2595	38000	21.61	22.5	0-2
				2610	38150	21.69	22.5	0-2

Unless otherwise stated the results shown in this test report refer only to the sample(s) tested and such sample(s) are retained for 90 days only.

除非另有說明，此報告結果僅對測試之樣品負責，同時此樣品僅保留90天。本報告未經本公司書面許可，不可部份複製。

This document is issued by the Company subject to its General Conditions of Service printed overleaf, available on request or accessible at www.sgs.com/terms_and_conditions.htm and for electronic format documents, subject to Terms and Conditions for Electronic Documents at www.sgs.com/terms_e-document.htm. Attention is drawn to the limitation of liability, indemnification and jurisdiction issues defined therein. Any holder of this document is advised that information contained hereon reflects the Company's findings at the time of its intervention only and within the limits of Client's instructions, if any. The Company's sole responsibility is to its Client and this document does not exonerate parties to a transaction from exercising all their rights and obligations under the transaction documents. This document cannot be reproduced except in full, without prior written approval of the Company. Any unauthorized alteration, forgery or falsification of the content or appearance of this document is unlawful and offenders may be prosecuted to the fullest extent of the law.

TDD Band 38											
BW(Mhz)	Modulation	RB Size	RB Offset	Frequency (MHz)	Channel	Conducted power (dBm)	Target Power + Max. Tolerance (dBm)	MPR Allowed per 3GPP(dB)			
15	QPSK	1 RB	0	2577.5	37825	23.98	24.5	0			
				2595	38000	23.54	24.5	0			
				2612.5	38175	23.70	24.5	0			
			36	2577.5	37825	23.49	24.5	0			
				2595	38000	23.48	24.5	0			
				2612.5	38175	23.28	24.5	0			
		74	2577.5	37825	23.31	24.5	0				
			2595	38000	23.67	24.5	0				
			2612.5	38175	23.36	24.5	0				
		36 RB	0	2577.5	37825	22.92	37825	22.92	23.5	0-1	
				2595	38000	22.54	38000	22.54	23.5	0-1	
				2612.5	38175	22.69	38175	22.69	23.5	0-1	
				18	2577.5	37825	22.77	37825	22.77	23.5	0-1
					2595	38000	22.43	38000	22.43	23.5	0-1
					2612.5	38175	22.68	38175	22.68	23.5	0-1
			37	2577.5	37825	22.42	37825	22.42	23.5	0-1	
				2595	38000	22.56	38000	22.56	23.5	0-1	
				2612.5	38175	22.65	38175	22.65	23.5	0-1	
			75RB	2577.5	37825	22.62	37825	22.62	23.5	0-1	
				2595	38000	22.48	38000	22.48	23.5	0-1	
				2612.5	38175	22.45	38175	22.45	23.5	0-1	
		16-QAM	1 RB	0	2577.5	37825	23.12	37825	23.5	0-1	
					2595	38000	22.95	38000	22.95	23.5	0-1
					2612.5	38175	22.88	38175	22.88	23.5	0-1
	36			2577.5	37825	22.69	37825	22.69	23.5	0-1	
				2595	38000	22.54	38000	22.54	23.5	0-1	
				2612.5	38175	22.67	38175	22.67	23.5	0-1	
	74			2577.5	37825	22.63	37825	22.63	23.5	0-1	
				2595	38000	22.89	38000	22.89	23.5	0-1	
				2612.5	38175	22.76	38175	22.76	23.5	0-1	
	36 RB			0	2577.5	37825	21.79	37825	21.79	22.5	0-2
					2595	38000	21.68	38000	21.68	22.5	0-2
					2612.5	38175	21.55	38175	21.55	22.5	0-2
			18	2577.5	37825	21.54	37825	21.54	22.5	0-2	
				2595	38000	21.55	38000	21.55	22.5	0-2	
				2612.5	38175	21.46	38175	21.46	22.5	0-2	
			37	2577.5	37825	21.62	37825	21.62	22.5	0-2	
				2595	38000	21.33	38000	21.33	22.5	0-2	
				2612.5	38175	21.50	38175	21.50	22.5	0-2	
	75RB		2577.5	37825	21.50	37825	21.50	22.5	0-2		
			2595	38000	21.40	38000	21.40	22.5	0-2		
			2612.5	38175	21.44	38175	21.44	22.5	0-2		

Unless otherwise stated the results shown in this test report refer only to the sample(s) tested and such sample(s) are retained for 90 days only.

除非另有說明，此報告結果僅對測試之樣品負責，同時此樣品僅保留90天。本報告未經本公司書面許可，不可部份複製。

This document is issued by the Company subject to its General Conditions of Service printed overleaf, available on request or accessible at www.sgs.com/terms_and_conditions.htm and for electronic format documents, subject to Terms and Conditions for Electronic Documents at www.sgs.com/terms_e-document.htm. Attention is drawn to the limitation of liability, indemnification and jurisdiction issues defined therein. Any holder of this document is advised that information contained hereon reflects the Company's findings at the time of its intervention only and within the limits of Client's instructions, if any. The Company's sole responsibility is to its Client and this document does not exonerate parties to a transaction from exercising all their rights and obligations under the transaction documents. This document cannot be reproduced except in full, without prior written approval of the Company. Any unauthorized alteration, forgery or falsification of the content or appearance of this document is unlawful and offenders may be prosecuted to the fullest extent of the law.

TDD Band 38								
BW(MHz)	Modulation	RB Size	RB Offset	Frequency (MHz)	Channel	Conducted power (dBm)	Target Power + Max. Tolerance (dBm)	MPR Allowed per 3GPP(dB)
15	64-QAM	1 RB	0	2577.5	37825	22.90	23.5	0-1
				2595	38000	22.81	23.5	0-1
				2612.5	38175	22.89	23.5	0-1
			36	2577.5	37825	22.70	23.5	0-1
				2595	38000	22.65	23.5	0-1
				2612.5	38175	22.65	23.5	0-1
			74	2577.5	37825	22.72	23.5	0-1
				2595	38000	22.54	23.5	0-1
				2612.5	38175	22.70	23.5	0-1
		36 RB	0	2577.5	37825	21.81	22.5	0-2
				2595	38000	21.61	22.5	0-2
				2612.5	38175	21.69	22.5	0-2
			18	2577.5	37825	21.61	22.5	0-2
				2595	38000	21.52	22.5	0-2
				2612.5	38175	21.35	22.5	0-2
			37	2577.5	37825	21.49	22.5	0-2
				2595	38000	21.30	22.5	0-2
				2612.5	38175	21.27	22.5	0-2
			75RB	2577.5	37825	21.55	22.5	0-2
				2595	38000	21.32	22.5	0-2
				2612.5	38175	21.47	22.5	0-2

Unless otherwise stated the results shown in this test report refer only to the sample(s) tested and such sample(s) are retained for 90 days only.

除非另有說明，此報告結果僅對測試之樣品負責，同時此樣品僅保留90天。本報告未經本公司書面許可，不可部份複製。

This document is issued by the Company subject to its General Conditions of Service printed overleaf, available on request or accessible at www.sgs.com/terms_and_conditions.htm and for electronic format documents, subject to Terms and Conditions for Electronic Documents at www.sgs.com/terms_e-document.htm. Attention is drawn to the limitation of liability, indemnification and jurisdiction issues defined therein. Any holder of this document is advised that information contained hereon reflects the Company's findings at the time of its intervention only and within the limits of Client's instructions, if any. The Company's sole responsibility is to its Client and this document does not exonerate parties to a transaction from exercising all their rights and obligations under the transaction documents. This document cannot be reproduced except in full, without prior written approval of the Company. Any unauthorized alteration, forgery or falsification of the content or appearance of this document is unlawful and offenders may be prosecuted to the fullest extent of the law.

TDD Band 38											
BW(Mhz)	Modulation	RB Size	RB Offset	Frequency (MHz)	Channel	Conducted power (dBm)	Target Power + Max. Tolerance (dBm)	MPR Allowed per 3GPP(dB)			
10	QPSK	1 RB	0	2575	37800	23.97	24.5	0			
				2595	38000	23.62	24.5	0			
				2615	38200	23.63	24.5	0			
			25	2575	37800	23.49	24.5	0			
				2595	38000	23.48	24.5	0			
				2615	38200	23.21	24.5	0			
		49	2575	37800	23.37	24.5	0				
			2595	38000	23.47	24.5	0				
			2615	38200	23.43	24.5	0				
		25 RB	0	2575	37800	22.68	37800	22.68	23.5	0-1	
				2595	38000	22.71	38000	22.71	23.5	0-1	
				2615	38200	22.64	38200	22.64	23.5	0-1	
			12	2575	37800	22.85	37800	22.85	23.5	0-1	
				2595	38000	22.57	38000	22.57	23.5	0-1	
				2615	38200	22.43	38200	22.43	23.5	0-1	
			25	2575	37800	22.41	37800	22.41	23.5	0-1	
				2595	38000	22.42	38000	22.42	23.5	0-1	
				2615	38200	22.50	38200	22.50	23.5	0-1	
			50RB	2575	37800	22.53	37800	22.53	23.5	0-1	
				2595	38000	22.56	38000	22.56	23.5	0-1	
				2615	38200	22.48	38200	22.48	23.5	0-1	
		16-QAM	1 RB	0	2575	37800	23.09	37800	23.09	23.5	0-1
					2595	38000	22.81	38000	22.81	23.5	0-1
					2615	38200	22.79	38200	22.79	23.5	0-1
	25			2575	37800	22.88	37800	22.88	23.5	0-1	
				2595	38000	22.74	38000	22.74	23.5	0-1	
				2615	38200	22.58	38200	22.58	23.5	0-1	
	49			2575	37800	22.66	37800	22.66	23.5	0-1	
				2595	38000	22.77	38000	22.77	23.5	0-1	
				2615	38200	22.67	38200	22.67	23.5	0-1	
	25 RB			0	2575	37800	21.94	37800	21.94	22.5	0-2
					2595	38000	21.57	38000	21.57	22.5	0-2
					2615	38200	21.61	38200	21.61	22.5	0-2
			12	2575	37800	21.62	37800	21.62	22.5	0-2	
				2595	38000	21.62	38000	21.62	22.5	0-2	
				2615	38200	21.45	38200	21.45	22.5	0-2	
			25	2575	37800	21.66	37800	21.66	22.5	0-2	
				2595	38000	21.47	38000	21.47	22.5	0-2	
				2615	38200	21.55	38200	21.55	22.5	0-2	
	50RB		2575	37800	21.70	37800	21.70	22.5	0-2		
			2595	38000	21.65	38000	21.65	22.5	0-2		
			2615	38200	21.63	38200	21.63	22.5	0-2		

Unless otherwise stated the results shown in this test report refer only to the sample(s) tested and such sample(s) are retained for 90 days only.

除非另有說明，此報告結果僅對測試之樣品負責，同時此樣品僅保留90天。本報告未經本公司書面許可，不可部份複製。

This document is issued by the Company subject to its General Conditions of Service printed overleaf, available on request or accessible at www.sgs.com/terms_and_conditions.htm and for electronic format documents, subject to Terms and Conditions for Electronic Documents at www.sgs.com/terms_e-document.htm. Attention is drawn to the limitation of liability, indemnification and jurisdiction issues defined therein. Any holder of this document is advised that information contained hereon reflects the Company's findings at the time of its intervention only and within the limits of Client's instructions, if any. The Company's sole responsibility is to its Client and this document does not exonerate parties to a transaction from exercising all their rights and obligations under the transaction documents. This document cannot be reproduced except in full, without prior written approval of the Company. Any unauthorized alteration, forgery or falsification of the content or appearance of this document is unlawful and offenders may be prosecuted to the fullest extent of the law.

TDD Band 38								
BW(MHz)	Modulation	RB Size	RB Offset	Frequency (MHz)	Channel	Conducted power (dBm)	Target Power + Max. Tolerance (dBm)	MPR Allowed per 3GPP(dB)
10	64-QAM	1 RB	0	2575	37800	22.89	23.5	0-1
				2595	38000	22.94	23.5	0-1
				2615	38200	22.81	23.5	0-1
			25	2575	37800	22.71	23.5	0-1
				2595	38000	22.65	23.5	0-1
				2615	38200	22.59	23.5	0-1
			49	2575	37800	22.48	23.5	0-1
				2595	38000	22.62	23.5	0-1
				2615	38200	22.53	23.5	0-1
		25 RB	0	2575	37800	21.59	22.5	0-2
				2595	38000	21.67	22.5	0-2
				2615	38200	21.51	22.5	0-2
			12	2575	37800	21.52	22.5	0-2
				2595	38000	21.41	22.5	0-2
				2615	38200	21.50	22.5	0-2
			25	2575	37800	21.60	22.5	0-2
				2595	38000	21.46	22.5	0-2
				2615	38200	21.55	22.5	0-2
			50RB	2575	37800	21.62	22.5	0-2
				2595	38000	21.49	22.5	0-2
				2615	38200	21.51	22.5	0-2

Unless otherwise stated the results shown in this test report refer only to the sample(s) tested and such sample(s) are retained for 90 days only.

除非另有說明，此報告結果僅對測試之樣品負責，同時此樣品僅保留90天。本報告未經本公司書面許可，不可部份複製。

This document is issued by the Company subject to its General Conditions of Service printed overleaf, available on request or accessible at www.sgs.com/terms_and_conditions.htm and for electronic format documents, subject to Terms and Conditions for Electronic Documents at www.sgs.com/terms_e-document.htm. Attention is drawn to the limitation of liability, indemnification and jurisdiction issues defined therein. Any holder of this document is advised that information contained hereon reflects the Company's findings at the time of its intervention only and within the limits of Client's instructions, if any. The Company's sole responsibility is to its Client and this document does not exonerate parties to a transaction from exercising all their rights and obligations under the transaction documents. This document cannot be reproduced except in full, without prior written approval of the Company. Any unauthorized alteration, forgery or falsification of the content or appearance of this document is unlawful and offenders may be prosecuted to the fullest extent of the law.

TDD Band 38											
BW(Mhz)	Modulation	RB Size	RB Offset	Frequency (MHz)	Channel	Conducted power (dBm)	Target Power + Max. Tolerance (dBm)	MPR Allowed per 3GPP(dB)			
5	QPSK	1 RB	0	2572.5	37775	23.97	24.5	0			
				2595	38000	23.70	24.5	0			
				2617.5	38225	23.59	24.5	0			
			12	2572.5	37775	23.36	24.5	0			
				2595	38000	23.38	24.5	0			
				2617.5	38225	23.45	24.5	0			
		24	2572.5	37775	23.54	24.5	0				
			2595	38000	23.66	24.5	0				
			2617.5	38225	23.45	24.5	0				
		12 RB	0	2572.5	37775	22.92	37775	22.92	23.5	0-1	
				2595	38000	22.59	38000	22.59	23.5	0-1	
				2617.5	38225	22.57	38225	22.57	23.5	0-1	
			6	2572.5	37775	22.63	37775	22.63	23.5	0-1	
				2595	38000	22.43	38000	22.43	23.5	0-1	
				2617.5	38225	22.39	38225	22.39	23.5	0-1	
			13	2572.5	37775	22.40	37775	22.40	23.5	0-1	
				2595	38000	22.43	38000	22.43	23.5	0-1	
				2617.5	38225	22.61	38225	22.61	23.5	0-1	
			25RB	2572.5	37775	22.74	37775	22.74	23.5	0-1	
				2595	38000	22.69	38000	22.69	23.5	0-1	
				2617.5	38225	22.54	38225	22.54	23.5	0-1	
		16-QAM	1 RB	0	2572.5	37775	23.02	37775	23.5	0-1	
					2595	38000	23.05	38000	23.5	0-1	
					2617.5	38225	22.89	38225	23.5	0-1	
	12			2572.5	37775	22.90	37775	22.90	23.5	0-1	
				2595	38000	22.73	38000	22.73	23.5	0-1	
				2617.5	38225	22.64	38225	22.64	23.5	0-1	
	24			2572.5	37775	22.60	37775	22.60	23.5	0-1	
				2595	38000	22.77	38000	22.77	23.5	0-1	
				2617.5	38225	22.57	38225	22.57	23.5	0-1	
	12 RB			0	2572.5	37775	21.71	37775	21.71	22.5	0-2
					2595	38000	21.67	38000	21.67	22.5	0-2
					2617.5	38225	21.75	38225	21.75	22.5	0-2
			6	2572.5	37775	21.72	37775	21.72	22.5	0-2	
				2595	38000	21.48	38000	21.48	22.5	0-2	
				2617.5	38225	21.43	38225	21.43	22.5	0-2	
			13	2572.5	37775	21.62	37775	21.62	22.5	0-2	
				2595	38000	21.40	38000	21.40	22.5	0-2	
				2617.5	38225	21.45	38225	21.45	22.5	0-2	
	25RB		2572.5	37775	21.76	37775	21.76	22.5	0-2		
			2595	38000	21.67	38000	21.67	22.5	0-2		
			2617.5	38225	21.72	38225	21.72	22.5	0-2		

Unless otherwise stated the results shown in this test report refer only to the sample(s) tested and such sample(s) are retained for 90 days only.

除非另有說明，此報告結果僅對測試之樣品負責，同時此樣品僅保留90天。本報告未經本公司書面許可，不可部份複製。

This document is issued by the Company subject to its General Conditions of Service printed overleaf, available on request or accessible at www.sgs.com/terms_and_conditions.htm and for electronic format documents, subject to Terms and Conditions for Electronic Documents at www.sgs.com/terms_e-document.htm. Attention is drawn to the limitation of liability, indemnification and jurisdiction issues defined therein. Any holder of this document is advised that information contained hereon reflects the Company's findings at the time of its intervention only and within the limits of Client's instructions, if any. The Company's sole responsibility is to its Client and this document does not exonerate parties to a transaction from exercising all their rights and obligations under the transaction documents. This document cannot be reproduced except in full, without prior written approval of the Company. Any unauthorized alteration, forgery or falsification of the content or appearance of this document is unlawful and offenders may be prosecuted to the fullest extent of the law.

TDD Band 38								
BW(MHz)	Modulation	RB Size	RB Offset	Frequency (MHz)	Channel	Conducted power (dBm)	Target Power + Max. Tolerance (dBm)	MPR Allowed per 3GPP(dB)
5	64-QAM	1 RB	0	2572.5	37775	22.87	23.5	0-1
				2595	38000	22.82	23.5	0-1
				2617.5	38225	22.93	23.5	0-1
			12	2572.5	37775	22.79	23.5	0-1
				2595	38000	22.63	23.5	0-1
				2617.5	38225	22.61	23.5	0-1
			24	2572.5	37775	22.62	23.5	0-1
				2595	38000	22.77	23.5	0-1
				2617.5	38225	22.73	23.5	0-1
		12 RB	0	2572.5	37775	21.64	22.5	0-2
				2595	38000	21.59	22.5	0-2
				2617.5	38225	21.68	22.5	0-2
			6	2572.5	37775	21.67	22.5	0-2
				2595	38000	21.41	22.5	0-2
				2617.5	38225	21.49	22.5	0-2
			13	2572.5	37775	21.62	22.5	0-2
				2595	38000	21.50	22.5	0-2
				2617.5	38225	21.46	22.5	0-2
			25RB	2572.5	37775	21.65	22.5	0-2
				2595	38000	21.52	22.5	0-2
				2617.5	38225	21.53	22.5	0-2

Unless otherwise stated the results shown in this test report refer only to the sample(s) tested and such sample(s) are retained for 90 days only.

除非另有說明，此報告結果僅對測試之樣品負責，同時此樣品僅保留90天。本報告未經本公司書面許可，不可部份複製。

This document is issued by the Company subject to its General Conditions of Service printed overleaf, available on request or accessible at www.sgs.com/terms_and_conditions.htm and for electronic format documents, subject to Terms and Conditions for Electronic Documents at www.sgs.com/terms_e-document.htm. Attention is drawn to the limitation of liability, indemnification and jurisdiction issues defined therein. Any holder of this document is advised that information contained hereon reflects the Company's findings at the time of its intervention only and within the limits of Client's instructions, if any. The Company's sole responsibility is to its Client and this document does not exonerate parties to a transaction from exercising all their rights and obligations under the transaction documents. This document cannot be reproduced except in full, without prior written approval of the Company. Any unauthorized alteration, forgery or falsification of the content or appearance of this document is unlawful and offenders may be prosecuted to the fullest extent of the law.

TDD Band 41								
BW(Mhz)	Modulation	RB Size	RB Offset	Frequency (MHz)	Channel	Conducted power (dBm)	Target Power + Max. Tolerance (dBm)	MPR Allowed per 3GPP(dB)
20	QPSK	1 RB	0	2506	39750	23.84	24.5	0
				2549.5	40185	23.75	24.5	0
				2593	40620	23.75	24.5	0
				2636.5	41055	23.72	24.5	0
			2680	41490	23.99	24.5	0	
			50	2506	39750	23.54	24.5	0
				2549.5	40185	23.54	24.5	0
				2593	40620	23.58	24.5	0
				2636.5	41055	23.58	24.5	0
			2680	41490	23.93	24.5	0	
			99	2506	39750	23.77	24.5	0
				2549.5	40185	23.54	24.5	0
		2593		40620	23.49	24.5	0	
		2636.5		41055	23.52	24.5	0	
		2680	41490	23.98	24.5	0		
		50 RB	0	2506	39750	22.78	23.5	0-1
				2549.5	40185	22.82	23.5	0-1
				2593	40620	22.85	23.5	0-1
				2636.5	41055	22.84	23.5	0-1
			2680	41490	22.95	23.5	0-1	
			25	2506	39750	22.65	23.5	0-1
				2549.5	40185	22.77	23.5	0-1
				2593	40620	22.72	23.5	0-1
				2636.5	41055	22.73	23.5	0-1
			2680	41490	22.95	23.5	0-1	
			50	2506	39750	22.68	23.5	0-1
				2549.5	40185	22.72	23.5	0-1
		2593		40620	22.66	23.5	0-1	
		2636.5		41055	22.63	23.5	0-1	
		2680	41490	22.82	23.5	0-1		
		100RB	2506	39750	22.74	23.5	0-1	
			2549.5	40185	22.81	23.5	0-1	
2593	40620		22.64	23.5	0-1			
2636.5	41055		22.73	23.5	0-1			
2680	41490	22.98	23.5	0-1				

Unless otherwise stated the results shown in this test report refer only to the sample(s) tested and such sample(s) are retained for 90 days only.

除非另有說明，此報告結果僅對測試之樣品負責，同時此樣品僅保留90天。本報告未經本公司書面許可，不可部份複製。

This document is issued by the Company subject to its General Conditions of Service printed overleaf, available on request or accessible at www.sgs.com/terms_and_conditions.htm and for electronic format documents, subject to Terms and Conditions for Electronic Documents at www.sgs.com/terms_e-document.htm. Attention is drawn to the limitation of liability, indemnification and jurisdiction issues defined therein. Any holder of this document is advised that information contained hereon reflects the Company's findings at the time of its intervention only and within the limits of Client's instructions, if any. The Company's sole responsibility is to its Client and this document does not exonerate parties to a transaction from exercising all their rights and obligations under the transaction documents. This document cannot be reproduced except in full, without prior written approval of the Company. Any unauthorized alteration, forgery or falsification of the content or appearance of this document is unlawful and offenders may be prosecuted to the fullest extent of the law.

TDD Band 41								
BW(Mhz)	Modulation	RB Size	RB Offset	Frequency (MHz)	Channel	Conducted power (dBm)	Target Power + Max. Tolerance (dBm)	MPR Allowed per 3GPP(dB)
20	16-QAM	1 RB	0	2506	39750	23.02	23.5	0-1
				2549.5	40185	23.30	23.5	0-1
				2593	40620	23.06	23.5	0-1
				2636.5	41055	23.06	23.5	0-1
			2680	41490	23.45	23.5	0-1	
			50	2506	39750	22.78	23.5	0-1
				2549.5	40185	22.66	23.5	0-1
				2593	40620	22.75	23.5	0-1
				2636.5	41055	22.79	23.5	0-1
			2680	41490	23.00	23.5	0-1	
			99	2506	39750	22.96	23.5	0-1
				2549.5	40185	22.90	23.5	0-1
		2593		40620	22.89	23.5	0-1	
		2636.5		41055	22.74	23.5	0-1	
		2680	41490	23.48	23.5	0-1		
		50 RB	0	2506	39750	21.82	22.5	0-2
				2549.5	40185	21.81	22.5	0-2
				2593	40620	21.85	22.5	0-2
				2636.5	41055	21.77	22.5	0-2
			2680	41490	21.92	22.5	0-2	
			25	2506	39750	21.80	22.5	0-2
				2549.5	40185	21.78	22.5	0-2
				2593	40620	21.71	22.5	0-2
				2636.5	41055	21.76	22.5	0-2
			2680	41490	21.94	22.5	0-2	
			50	2506	39750	21.68	22.5	0-2
				2549.5	40185	21.72	22.5	0-2
		2593		40620	21.76	22.5	0-2	
		2636.5		41055	21.77	22.5	0-2	
		2680	41490	21.92	22.5	0-2		
		100RB	2506	39750	21.72	22.5	0-2	
			2549.5	40185	21.72	22.5	0-2	
			2593	40620	21.70	22.5	0-2	
			2636.5	41055	21.80	22.5	0-2	
		2680	41490	21.93	22.5	0-2		

Unless otherwise stated the results shown in this test report refer only to the sample(s) tested and such sample(s) are retained for 90 days only.

除非另有說明，此報告結果僅對測試之樣品負責，同時此樣品僅保留90天。本報告未經本公司書面許可，不可部份複製。

This document is issued by the Company subject to its General Conditions of Service printed overleaf, available on request or accessible at www.sgs.com/terms_and_conditions.htm and for electronic format documents, subject to Terms and Conditions for Electronic Documents at www.sgs.com/terms_e-document.htm. Attention is drawn to the limitation of liability, indemnification and jurisdiction issues defined therein. Any holder of this document is advised that information contained hereon reflects the Company's findings at the time of its intervention only and within the limits of Client's instructions, if any. The Company's sole responsibility is to its Client and this document does not exonerate parties to a transaction from exercising all their rights and obligations under the transaction documents. This document cannot be reproduced except in full, without prior written approval of the Company. Any unauthorized alteration, forgery or falsification of the content or appearance of this document is unlawful and offenders may be prosecuted to the fullest extent of the law.

TDD Band 41								
BW(Mhz)	Modulation	RB Size	RB Offset	Frequency (MHz)	Channel	Conducted power (dBm)	Target Power + Max. Tolerance (dBm)	MPR Allowed per 3GPP(dB)
20	64-QAM	1 RB	0	2506	39750	22.93	23.5	0-1
				2549.5	40185	23.21	23.5	0-1
				2593	40620	22.97	23.5	0-1
				2636.5	41055	22.97	23.5	0-1
			50	2680	41490	23.46	23.5	0-1
				2506	39750	22.69	23.5	0-1
				2549.5	40185	22.57	23.5	0-1
				2593	40620	22.66	23.5	0-1
			99	2636.5	41055	22.70	23.5	0-1
				2680	41490	22.91	23.5	0-1
				2506	39750	22.87	23.5	0-1
				2549.5	40185	22.81	23.5	0-1
		50 RB	0	2593	40620	22.80	23.5	0-1
				2636.5	41055	22.65	23.5	0-1
				2680	41490	23.49	23.5	0-1
				2506	39750	21.73	22.5	0-2
			25	2549.5	40185	21.72	22.5	0-2
				2593	40620	21.76	22.5	0-2
				2636.5	41055	21.68	22.5	0-2
				2680	41490	21.83	22.5	0-2
			50	2506	39750	21.71	22.5	0-2
				2549.5	40185	21.69	22.5	0-2
				2593	40620	21.62	22.5	0-2
				2636.5	41055	21.67	22.5	0-2
			100RB	2680	41490	21.85	22.5	0-2
				2506	39750	21.59	22.5	0-2
				2549.5	40185	21.63	22.5	0-2
				2593	40620	21.67	22.5	0-2
		100RB	2636.5	41055	21.68	22.5	0-2	
			2680	41490	21.83	22.5	0-2	
			2506	39750	21.63	22.5	0-2	
			2549.5	40185	21.63	22.5	0-2	
100RB	2593	40620	21.61	22.5	0-2			
	2636.5	41055	21.71	22.5	0-2			
	2680	41490	21.84	22.5	0-2			
	2506	39750	21.63	22.5	0-2			

Unless otherwise stated the results shown in this test report refer only to the sample(s) tested and such sample(s) are retained for 90 days only.

除非另有說明，此報告結果僅對測試之樣品負責，同時此樣品僅保留90天。本報告未經本公司書面許可，不可部份複製。

This document is issued by the Company subject to its General Conditions of Service printed overleaf, available on request or accessible at www.sgs.com/terms_and_conditions.htm and for electronic format documents, subject to Terms and Conditions for Electronic Documents at www.sgs.com/terms_e-document.htm. Attention is drawn to the limitation of liability, indemnification and jurisdiction issues defined therein. Any holder of this document is advised that information contained hereon reflects the Company's findings at the time of its intervention only and within the limits of Client's instructions, if any. The Company's sole responsibility is to its Client and this document does not exonerate parties to a transaction from exercising all their rights and obligations under the transaction documents. This document cannot be reproduced except in full, without prior written approval of the Company. Any unauthorized alteration, forgery or falsification of the content or appearance of this document is unlawful and offenders may be prosecuted to the fullest extent of the law.

TDD Band 41									
BW(Mhz)	Modulation	RB Size	RB Offset	Frequency (MHz)	Channel	Conducted power (dBm)	Target Power + Max. Tolerance (dBm)	MPR Allowed per 3GPP(dB)	
15	QPSK	1 RB	0	2503.5	39725	23.82	24.5	0	
				2548.3	40173	23.45	24.5	0	
				2593	40620	23.62	24.5	0	
				2637.8	41068	23.55	24.5	0	
				2682.5	41515	23.98	24.5	0	
			36	2503.5	39725	23.48	24.5	0	
				2548.3	40173	23.53	24.5	0	
				2593	40620	23.32	24.5	0	
				2637.8	41068	23.51	24.5	0	
				2682.5	41515	23.63	24.5	0	
				74	2503.5	39725	23.55	24.5	0
					2548.3	40173	23.38	24.5	0
		2593	40620		23.46	24.5	0		
		2637.8	41068		23.39	24.5	0		
		36 RB	0	2503.5	39725	22.64	23.5	0-1	
				2548.3	40173	22.59	23.5	0-1	
				2593	40620	22.60	23.5	0-1	
				2637.8	41068	22.73	23.5	0-1	
				2682.5	41515	22.88	23.5	0-1	
			18	2503.5	39725	22.50	23.5	0-1	
				2548.3	40173	22.54	23.5	0-1	
				2593	40620	22.52	23.5	0-1	
				2637.8	41068	22.67	23.5	0-1	
				2682.5	41515	22.72	23.5	0-1	
				37	2503.5	39725	22.39	23.5	0-1
					2548.3	40173	22.64	23.5	0-1
			2593		40620	22.38	23.5	0-1	
			2637.8		41068	22.49	23.5	0-1	
			2682.5		41515	22.60	23.5	0-1	
			75RB		2503.5	39725	22.55	23.5	0-1
					2548.3	40173	22.60	23.5	0-1
					2593	40620	22.48	23.5	0-1
2637.8	41068			22.70	23.5	0-1			
2682.5	41515			22.90	23.5	0-1			

Unless otherwise stated the results shown in this test report refer only to the sample(s) tested and such sample(s) are retained for 90 days only.

除非另有說明，此報告結果僅對測試之樣品負責，同時此樣品僅保留90天。本報告未經本公司書面許可，不可部份複製。

This document is issued by the Company subject to its General Conditions of Service printed overleaf, available on request or accessible at www.sgs.com/terms_and_conditions.htm and for electronic format documents, subject to Terms and Conditions for Electronic Documents at www.sgs.com/terms_e-document.htm. Attention is drawn to the limitation of liability, indemnification and jurisdiction issues defined therein. Any holder of this document is advised that information contained hereon reflects the Company's findings at the time of its intervention only and within the limits of Client's instructions, if any. The Company's sole responsibility is to its Client and this document does not exonerate parties to a transaction from exercising all their rights and obligations under the transaction documents. This document cannot be reproduced except in full, without prior written approval of the Company. Any unauthorized alteration, forgery or falsification of the content or appearance of this document is unlawful and offenders may be prosecuted to the fullest extent of the law.

TDD Band 41									
BW(Mhz)	Modulation	RB Size	RB Offset	Frequency (MHz)	Channel	Conducted power (dBm)	Target Power + Max. Tolerance (dBm)	MPR Allowed per 3GPP(dB)	
15	16-QAM	1 RB	0	2503.5	39725	23.00	23.5	0-1	
				2548.3	40173	23.21	23.5	0-1	
				2593	40620	23.00	23.5	0-1	
				2637.8	41068	22.86	23.5	0-1	
				2682.5	41515	23.41	23.5	0-1	
			36	2503.5	39725	22.71	23.5	0-1	
				2548.3	40173	22.58	23.5	0-1	
				2593	40620	22.69	23.5	0-1	
				2637.8	41068	22.75	23.5	0-1	
				2682.5	41515	22.95	23.5	0-1	
				74	2503.5	39725	22.68	23.5	0-1
					2548.3	40173	22.83	23.5	0-1
		2593	40620		22.82	23.5	0-1		
		2637.8	41068		22.52	23.5	0-1		
		2682.5	41515		23.47	23.5	0-1		
		36 RB	0	2503.5	39725	21.73	22.5	0-2	
				2548.3	40173	21.72	22.5	0-2	
				2593	40620	21.65	22.5	0-2	
				2637.8	41068	21.65	22.5	0-2	
				2682.5	41515	21.70	22.5	0-2	
			18	2503.5	39725	21.78	22.5	0-2	
				2548.3	40173	21.50	22.5	0-2	
				2593	40620	21.64	22.5	0-2	
				2637.8	41068	21.49	22.5	0-2	
				2682.5	41515	21.67	22.5	0-2	
				37	2503.5	39725	21.47	22.5	0-2
			2548.3		40173	21.72	22.5	0-2	
			2593		40620	21.76	22.5	0-2	
			2637.8		41068	21.59	22.5	0-2	
			2682.5		41515	21.84	22.5	0-2	
			75RB		2503.5	39725	21.63	22.5	0-2
					2548.3	40173	21.63	22.5	0-2
2593	40620			21.54	22.5	0-2			
2637.8	41068	21.61		22.5	0-2				
2682.5	41515	21.76		22.5	0-2				

Unless otherwise stated the results shown in this test report refer only to the sample(s) tested and such sample(s) are retained for 90 days only.

除非另有說明，此報告結果僅對測試之樣品負責，同時此樣品僅保留90天。本報告未經本公司書面許可，不可部份複製。

This document is issued by the Company subject to its General Conditions of Service printed overleaf, available on request or accessible at www.sgs.com/terms_and_conditions.htm and for electronic format documents, subject to Terms and Conditions for Electronic Documents at www.sgs.com/terms_e-document.htm. Attention is drawn to the limitation of liability, indemnification and jurisdiction issues defined therein. Any holder of this document is advised that information contained hereon reflects the Company's findings at the time of its intervention only and within the limits of Client's instructions, if any. The Company's sole responsibility is to its Client and this document does not exonerate parties to a transaction from exercising all their rights and obligations under the transaction documents. This document cannot be reproduced except in full, without prior written approval of the Company. Any unauthorized alteration, forgery or falsification of the content or appearance of this document is unlawful and offenders may be prosecuted to the fullest extent of the law.

TDD Band 41									
BW(Mhz)	Modulation	RB Size	RB Offset	Frequency (MHz)	Channel	Conducted power (dBm)	Target Power + Max. Tolerance (dBm)	MPR Allowed per 3GPP(dB)	
15	64-QAM	1 RB	0	2503.5	39725	22.67	23.5	0-1	
				2548.3	40173	22.92	23.5	0-1	
				2593	40620	22.80	23.5	0-1	
				2637.8	41068	22.77	23.5	0-1	
				2682.5	41515	23.46	23.5	0-1	
			36	2503.5	39725	22.53	23.5	0-1	
				2548.3	40173	22.45	23.5	0-1	
				2593	40620	22.66	23.5	0-1	
				2637.8	41068	22.55	23.5	0-1	
				2682.5	41515	22.72	23.5	0-1	
				74	2503.5	39725	22.60	23.5	0-1
					2548.3	40173	22.69	23.5	0-1
		2593	40620		22.60	23.5	0-1		
		2637.8	41068		22.38	23.5	0-1		
		36 RB	0	2503.5	39725	21.52	22.5	0-2	
				2548.3	40173	21.72	22.5	0-2	
				2593	40620	21.49	22.5	0-2	
				2637.8	41068	21.48	22.5	0-2	
				2682.5	41515	21.74	22.5	0-2	
			18	2503.5	39725	21.61	22.5	0-2	
				2548.3	40173	21.51	22.5	0-2	
				2593	40620	21.59	22.5	0-2	
				2637.8	41068	21.64	22.5	0-2	
				2682.5	41515	21.67	22.5	0-2	
				37	2503.5	39725	21.51	22.5	0-2
					2548.3	40173	21.54	22.5	0-2
			2593		40620	21.65	22.5	0-2	
			2637.8		41068	21.64	22.5	0-2	
			2682.5		41515	21.60	22.5	0-2	
			75RB		2503.5	39725	21.45	22.5	0-2
					2548.3	40173	21.48	22.5	0-2
					2593	40620	21.50	22.5	0-2
2637.8	41068			21.52	22.5	0-2			
2682.5	41515			21.71	22.5	0-2			

Unless otherwise stated the results shown in this test report refer only to the sample(s) tested and such sample(s) are retained for 90 days only.

除非另有說明，此報告結果僅對測試之樣品負責，同時此樣品僅保留90天。本報告未經本公司書面許可，不可部份複製。

This document is issued by the Company subject to its General Conditions of Service printed overleaf, available on request or accessible at www.sgs.com/terms_and_conditions.htm and for electronic format documents, subject to Terms and Conditions for Electronic Documents at www.sgs.com/terms_e-document.htm. Attention is drawn to the limitation of liability, indemnification and jurisdiction issues defined therein. Any holder of this document is advised that information contained hereon reflects the Company's findings at the time of its intervention only and within the limits of Client's instructions, if any. The Company's sole responsibility is to its Client and this document does not exonerate parties to a transaction from exercising all their rights and obligations under the transaction documents. This document cannot be reproduced except in full, without prior written approval of the Company. Any unauthorized alteration, forgery or falsification of the content or appearance of this document is unlawful and offenders may be prosecuted to the fullest extent of the law.

TDD Band 41								
BW(Mhz)	Modulation	RB Size	RB Offset	Frequency (MHz)	Channel	Conducted power (dBm)	Target Power + Max. Tolerance (dBm)	MPR Allowed per 3GPP(dB)
10	QPSK	1 RB	0	2501	39700	23.77	24.5	0
				2547	40160	23.46	24.5	0
				2593	40620	23.70	24.5	0
				2639	41080	23.69	24.5	0
			2685	41540	23.93	24.5	0	
			25	2501	39700	23.38	24.5	0
				2547	40160	23.39	24.5	0
				2593	40620	23.46	24.5	0
				2639	41080	23.51	24.5	0
			2685	41540	23.85	24.5	0	
			49	2501	39700	23.67	24.5	0
				2547	40160	23.34	24.5	0
		2593		40620	23.48	24.5	0	
		2639		41080	23.29	24.5	0	
		2685	41540	23.97	24.5	0		
		25 RB	0	2501	39700	22.62	23.5	0-1
				2547	40160	22.61	23.5	0-1
				2593	40620	22.57	23.5	0-1
				2639	41080	22.72	23.5	0-1
			2685	41540	22.86	23.5	0-1	
			12	2501	39700	22.40	23.5	0-1
				2547	40160	22.48	23.5	0-1
				2593	40620	22.52	23.5	0-1
				2639	41080	22.63	23.5	0-1
			2685	41540	22.73	23.5	0-1	
			25	2501	39700	22.40	23.5	0-1
				2547	40160	22.62	23.5	0-1
		2593		40620	22.54	23.5	0-1	
		2639		41080	22.52	23.5	0-1	
		2685	41540	22.62	23.5	0-1		
		50RB	2501	39700	22.59	23.5	0-1	
			2547	40160	22.66	23.5	0-1	
2593	40620		22.36	23.5	0-1			
2639	41080		22.53	23.5	0-1			
2685	41540	22.82	23.5	0-1				

Unless otherwise stated the results shown in this test report refer only to the sample(s) tested and such sample(s) are retained for 90 days only.

除非另有說明，此報告結果僅對測試之樣品負責，同時此樣品僅保留90天。本報告未經本公司書面許可，不可部份複製。

This document is issued by the Company subject to its General Conditions of Service printed overleaf, available on request or accessible at www.sgs.com/terms_and_conditions.htm and for electronic format documents, subject to Terms and Conditions for Electronic Documents at www.sgs.com/terms_e-document.htm. Attention is drawn to the limitation of liability, indemnification and jurisdiction issues defined therein. Any holder of this document is advised that information contained hereon reflects the Company's findings at the time of its intervention only and within the limits of Client's instructions, if any. The Company's sole responsibility is to its Client and this document does not exonerate parties to a transaction from exercising all their rights and obligations under the transaction documents. This document cannot be reproduced except in full, without prior written approval of the Company. Any unauthorized alteration, forgery or falsification of the content or appearance of this document is unlawful and offenders may be prosecuted to the fullest extent of the law.

TDD Band 41								
BW(Mhz)	Modulation	RB Size	RB Offset	Frequency (MHz)	Channel	Conducted power (dBm)	Target Power + Max. Tolerance (dBm)	MPR Allowed per 3GPP(dB)
10	16-QAM	1 RB	0	2501	39700	22.77	23.5	0-1
				2547	40160	23.09	23.5	0-1
				2593	40620	22.99	23.5	0-1
				2639	41080	22.95	23.5	0-1
				2685	41540	23.48	23.5	0-1
			25	2501	39700	22.54	23.5	0-1
				2547	40160	22.44	23.5	0-1
				2593	40620	22.50	23.5	0-1
				2639	41080	22.64	23.5	0-1
				2685	41540	22.91	23.5	0-1
			49	2501	39700	22.94	23.5	0-1
				2547	40160	22.65	23.5	0-1
		2593		40620	22.81	23.5	0-1	
		2639		41080	22.70	23.5	0-1	
		2685		41540	23.47	23.5	0-1	
		25 RB	0	2501	39700	21.68	22.5	0-2
				2547	40160	21.58	22.5	0-2
				2593	40620	21.66	22.5	0-2
				2639	41080	21.65	22.5	0-2
				2685	41540	21.91	22.5	0-2
			12	2501	39700	21.75	22.5	0-2
				2547	40160	21.57	22.5	0-2
				2593	40620	21.62	22.5	0-2
				2639	41080	21.52	22.5	0-2
				2685	41540	21.71	22.5	0-2
			25	2501	39700	21.60	22.5	0-2
				2547	40160	21.68	22.5	0-2
		2593		40620	21.73	22.5	0-2	
		2639		41080	21.73	22.5	0-2	
		2685		41540	21.82	22.5	0-2	
		50RB	2501	39700	21.70	22.5	0-2	
			2547	40160	21.46	22.5	0-2	
2593	40620		21.52	22.5	0-2			
2639	41080		21.55	22.5	0-2			
2685	41540		21.81	22.5	0-2			

Unless otherwise stated the results shown in this test report refer only to the sample(s) tested and such sample(s) are retained for 90 days only.

除非另有說明，此報告結果僅對測試之樣品負責，同時此樣品僅保留90天。本報告未經本公司書面許可，不可部份複製。

This document is issued by the Company subject to its General Conditions of Service printed overleaf, available on request or accessible at www.sgs.com/terms_and_conditions.htm and for electronic format documents, subject to Terms and Conditions for Electronic Documents at www.sgs.com/terms_e-document.htm. Attention is drawn to the limitation of liability, indemnification and jurisdiction issues defined therein. Any holder of this document is advised that information contained hereon reflects the Company's findings at the time of its intervention only and within the limits of Client's instructions, if any. The Company's sole responsibility is to its Client and this document does not exonerate parties to a transaction from exercising all their rights and obligations under the transaction documents. This document cannot be reproduced except in full, without prior written approval of the Company. Any unauthorized alteration, forgery or falsification of the content or appearance of this document is unlawful and offenders may be prosecuted to the fullest extent of the law.

TDD Band 41								
BW(Mhz)	Modulation	RB Size	RB Offset	Frequency (MHz)	Channel	Conducted power (dBm)	Target Power + Max. Tolerance (dBm)	MPR Allowed per 3GPP(dB)
10	64-QAM	1 RB	0	2501	39700	22.80	23.5	0-1
				2547	40160	22.99	23.5	0-1
				2593	40620	22.94	23.5	0-1
				2639	41080	22.90	23.5	0-1
				2685	41540	23.42	23.5	0-1
			25	2501	39700	22.57	23.5	0-1
				2547	40160	22.46	23.5	0-1
				2593	40620	22.49	23.5	0-1
				2639	41080	22.46	23.5	0-1
				2685	41540	22.78	23.5	0-1
			49	2501	39700	22.79	23.5	0-1
				2547	40160	22.70	23.5	0-1
		2593		40620	22.52	23.5	0-1	
		2639		41080	22.58	23.5	0-1	
		2685		41540	23.27	23.5	0-1	
		25 RB	0	2501	39700	21.50	22.5	0-2
				2547	40160	21.69	22.5	0-2
				2593	40620	21.66	22.5	0-2
				2639	41080	21.64	22.5	0-2
				2685	41540	21.76	22.5	0-2
			12	2501	39700	21.61	22.5	0-2
				2547	40160	21.49	22.5	0-2
				2593	40620	21.52	22.5	0-2
				2639	41080	21.56	22.5	0-2
				2685	41540	21.55	22.5	0-2
			25	2501	39700	21.52	22.5	0-2
				2547	40160	21.39	22.5	0-2
		2593		40620	21.54	22.5	0-2	
		2639		41080	21.68	22.5	0-2	
		2685		41540	21.67	22.5	0-2	
		50RB	2501	39700	21.50	22.5	0-2	
			2547	40160	21.35	22.5	0-2	
2593	40620		21.41	22.5	0-2			
2639	41080		21.44	22.5	0-2			
2685	41540		21.70	22.5	0-2			

Unless otherwise stated the results shown in this test report refer only to the sample(s) tested and such sample(s) are retained for 90 days only.

除非另有說明，此報告結果僅對測試之樣品負責，同時此樣品僅保留90天。本報告未經本公司書面許可，不可部份複製。

This document is issued by the Company subject to its General Conditions of Service printed overleaf, available on request or accessible at www.sgs.com/terms_and_conditions.htm and for electronic format documents, subject to Terms and Conditions for Electronic Documents at www.sgs.com/terms_e-document.htm. Attention is drawn to the limitation of liability, indemnification and jurisdiction issues defined therein. Any holder of this document is advised that information contained hereon reflects the Company's findings at the time of its intervention only and within the limits of Client's instructions, if any. The Company's sole responsibility is to its Client and this document does not exonerate parties to a transaction from exercising all their rights and obligations under the transaction documents. This document cannot be reproduced except in full, without prior written approval of the Company. Any unauthorized alteration, forgery or falsification of the content or appearance of this document is unlawful and offenders may be prosecuted to the fullest extent of the law.

TDD Band 41								
BW(Mhz)	Modulation	RB Size	RB Offset	Frequency (MHz)	Channel	Conducted power (dBm)	Target Power + Max. Tolerance (dBm)	MPR Allowed per 3GPP(dB)
5	QPSK	1 RB	0	2498.5	39675	23.79	24.5	0
				2547.8	40148	23.68	24.5	0
				2593	40620	23.52	24.5	0
				2640.3	41093	23.59	24.5	0
			2687.5	41565	23.94	24.5	0	
			12	2498.5	39675	23.52	24.5	0
				2547.8	40148	23.45	24.5	0
				2593	40620	23.44	24.5	0
				2640.3	41093	23.32	24.5	0
			24	2687.5	41565	23.75	24.5	0
				2498.5	39675	23.75	24.5	0
				2547.8	40148	23.31	24.5	0
		2593		40620	23.45	24.5	0	
		12 RB	0	2640.3	41093	23.31	24.5	0
				2687.5	41565	23.95	24.5	0
				2498.5	39675	22.60	23.5	0-1
				2547.8	40148	22.68	23.5	0-1
			6	2593	40620	22.63	23.5	0-1
				2640.3	41093	22.71	23.5	0-1
				2687.5	41565	22.70	23.5	0-1
				2498.5	39675	22.46	23.5	0-1
			13	2547.8	40148	22.57	23.5	0-1
				2593	40620	22.46	23.5	0-1
				2640.3	41093	22.48	23.5	0-1
				2687.5	41565	22.75	23.5	0-1
		25RB	2498.5	39675	22.61	23.5	0-1	
			2547.8	40148	22.58	23.5	0-1	
			2593	40620	22.48	23.5	0-1	
			2640.3	41093	22.52	23.5	0-1	
			2687.5	41565	22.70	23.5	0-1	
		25RB	2498.5	39675	22.72	23.5	0-1	
			2547.8	40148	22.58	23.5	0-1	
2593	40620		22.42	23.5	0-1			
2640.3	41093		22.55	23.5	0-1			
2687.5	41565		22.68	23.5	0-1			

Unless otherwise stated the results shown in this test report refer only to the sample(s) tested and such sample(s) are retained for 90 days only.

除非另有說明，此報告結果僅對測試之樣品負責，同時此樣品僅保留90天。本報告未經本公司書面許可，不可部份複製。

This document is issued by the Company subject to its General Conditions of Service printed overleaf, available on request or accessible at www.sgs.com/terms_and_conditions.htm and for electronic format documents, subject to Terms and Conditions for Electronic Documents at www.sgs.com/terms_e-document.htm. Attention is drawn to the limitation of liability, indemnification and jurisdiction issues defined therein. Any holder of this document is advised that information contained hereon reflects the Company's findings at the time of its intervention only and within the limits of Client's instructions, if any. The Company's sole responsibility is to its Client and this document does not exonerate parties to a transaction from exercising all their rights and obligations under the transaction documents. This document cannot be reproduced except in full, without prior written approval of the Company. Any unauthorized alteration, forgery or falsification of the content or appearance of this document is unlawful and offenders may be prosecuted to the fullest extent of the law.

TDD Band 41								
BW(Mhz)	Modulation	RB Size	RB Offset	Frequency (MHz)	Channel	Conducted power (dBm)	Target Power + Max. Tolerance (dBm)	MPR Allowed per 3GPP(dB)
5	16-QAM	1 RB	0	2498.5	39675	23.01	23.5	0-1
				2547.8	40148	23.13	23.5	0-1
				2593	40620	23.04	23.5	0-1
				2640.3	41093	22.99	23.5	0-1
			2687.5	41565	23.47	23.5	0-1	
			12	2498.5	39675	22.66	23.5	0-1
				2547.8	40148	22.58	23.5	0-1
				2593	40620	22.55	23.5	0-1
				2640.3	41093	22.72	23.5	0-1
			2687.5	41565	22.86	23.5	0-1	
			24	2498.5	39675	22.78	23.5	0-1
				2547.8	40148	22.82	23.5	0-1
		2593		40620	22.81	23.5	0-1	
		2640.3		41093	22.58	23.5	0-1	
		2687.5	41565	23.43	23.5	0-1		
		12 RB	0	2498.5	39675	21.59	22.5	0-2
				2547.8	40148	21.79	22.5	0-2
				2593	40620	21.58	22.5	0-2
				2640.3	41093	21.72	22.5	0-2
			2687.5	41565	21.67	22.5	0-2	
			6	2498.5	39675	21.70	22.5	0-2
				2547.8	40148	21.53	22.5	0-2
				2593	40620	21.63	22.5	0-2
				2640.3	41093	21.68	22.5	0-2
			2687.5	41565	21.81	22.5	0-2	
			13	2498.5	39675	21.46	22.5	0-2
				2547.8	40148	21.49	22.5	0-2
		2593		40620	21.54	22.5	0-2	
		2640.3		41093	21.69	22.5	0-2	
		2687.5	41565	21.84	22.5	0-2		
		25RB	2498.5	39675	21.52	22.5	0-2	
			2547.8	40148	21.46	22.5	0-2	
2593	40620		21.68	22.5	0-2			
2640.3	41093		21.77	22.5	0-2			
2687.5	41565	21.85	22.5	0-2				

Unless otherwise stated the results shown in this test report refer only to the sample(s) tested and such sample(s) are retained for 90 days only.

除非另有說明，此報告結果僅對測試之樣品負責，同時此樣品僅保留90天。本報告未經本公司書面許可，不可部份複製。

This document is issued by the Company subject to its General Conditions of Service printed overleaf, available on request or accessible at www.sgs.com/terms_and_conditions.htm and for electronic format documents, subject to Terms and Conditions for Electronic Documents at www.sgs.com/terms_e-document.htm. Attention is drawn to the limitation of liability, indemnification and jurisdiction issues defined therein. Any holder of this document is advised that information contained hereon reflects the Company's findings at the time of its intervention only and within the limits of Client's instructions, if any. The Company's sole responsibility is to its Client and this document does not exonerate parties to a transaction from exercising all their rights and obligations under the transaction documents. This document cannot be reproduced except in full, without prior written approval of the Company. Any unauthorized alteration, forgery or falsification of the content or appearance of this document is unlawful and offenders may be prosecuted to the fullest extent of the law.

TDD Band 41								
BW(Mhz)	Modulation	RB Size	RB Offset	Frequency (MHz)	Channel	Conducted power (dBm)	Target Power + Max. Tolerance (dBm)	MPR Allowed per 3GPP(dB)
5	64-QAM	1 RB	0	2498.5	39675	22.64	23.5	0-1
				2547.8	40148	23.00	23.5	0-1
				2593	40620	22.92	23.5	0-1
				2640.3	41093	22.78	23.5	0-1
			2687.5	41565	23.38	23.5	0-1	
			12	2498.5	39675	22.50	23.5	0-1
				2547.8	40148	22.41	23.5	0-1
				2593	40620	22.44	23.5	0-1
				2640.3	41093	22.68	23.5	0-1
			2687.5	41565	22.78	23.5	0-1	
			24	2498.5	39675	22.86	23.5	0-1
				2547.8	40148	22.57	23.5	0-1
		2593		40620	22.67	23.5	0-1	
		2640.3		41093	22.57	23.5	0-1	
		2687.5	41565	23.21	23.5	0-1		
		12 RB	0	2498.5	39675	21.68	22.5	0-2
				2547.8	40148	21.64	22.5	0-2
				2593	40620	21.46	22.5	0-2
				2640.3	41093	21.41	22.5	0-2
			2687.5	41565	21.71	22.5	0-2	
			6	2498.5	39675	21.69	22.5	0-2
				2547.8	40148	21.57	22.5	0-2
				2593	40620	21.41	22.5	0-2
				2640.3	41093	21.38	22.5	0-2
			2687.5	41565	21.56	22.5	0-2	
			13	2498.5	39675	21.51	22.5	0-2
				2547.8	40148	21.41	22.5	0-2
		2593		40620	21.66	22.5	0-2	
		2640.3		41093	21.62	22.5	0-2	
		2687.5	41565	21.69	22.5	0-2		
		25RB	2498.5	39675	21.39	22.5	0-2	
			2547.8	40148	21.35	22.5	0-2	
2593	40620		21.61	22.5	0-2			
2640.3	41093		21.71	22.5	0-2			
2687.5	41565	21.64	22.5	0-2				

Unless otherwise stated the results shown in this test report refer only to the sample(s) tested and such sample(s) are retained for 90 days only.

除非另有說明，此報告結果僅對測試之樣品負責，同時此樣品僅保留90天。本報告未經本公司書面許可，不可部份複製。

This document is issued by the Company subject to its General Conditions of Service printed overleaf, available on request or accessible at www.sgs.com/terms_and_conditions.htm and for electronic format documents, subject to Terms and Conditions for Electronic Documents at www.sgs.com/terms_e-document.htm. Attention is drawn to the limitation of liability, indemnification and jurisdiction issues defined therein. Any holder of this document is advised that information contained hereon reflects the Company's findings at the time of its intervention only and within the limits of Client's instructions, if any. The Company's sole responsibility is to its Client and this document does not exonerate parties to a transaction from exercising all their rights and obligations under the transaction documents. This document cannot be reproduced except in full, without prior written approval of the Company. Any unauthorized alteration, forgery or falsification of the content or appearance of this document is unlawful and offenders may be prosecuted to the fullest extent of the law.

LTE FDD Band 2 / Band 4 / Band 5 / Band 7 / Band 12 / Band 13 / Band 14 / Band 25 / Band 26 / Band 30 / Band 66 power table (Reduced power):

FDD Band 2									
BW(Mhz)	Modulation	RB Size	RB Offset	Frequency (MHz)	Channel	Conducted power (dBm)	Target Power + Max. Tolerance (dBm)	MPR Allowed per 3GPP(dB)	
20	QPSK	1 RB	0	1860	18700	15.28	15.6	0	
				1880	18900	15.27	15.6	0	
				1900	19100	15.58	15.6	0	
			50	1860	18700	15.06	15.6	0	
				1880	18900	15.03	15.6	0	
				1900	19100	15.22	15.6	0	
		99	1860	18700	15.25	15.6	0		
			1880	18900	15.27	15.6	0		
			1900	19100	15.48	15.6	0		
		50 RB	0	1860	18700	14.20	14.6	0-1	
				1880	18900	14.25	14.6	0-1	
				1900	19100	14.45	14.6	0-1	
			25	1860	18700	14.21	14.6	0-1	
				1880	18900	14.18	14.6	0-1	
				1900	19100	14.44	14.6	0-1	
			50	1860	18700	14.18	14.6	0-1	
				1880	18900	14.17	14.6	0-1	
				1900	19100	14.33	14.6	0-1	
			100RB	1860	18700	13.65	14.6	0-1	
				1880	18900	13.67	14.6	0-1	
				1900	19100	13.91	14.6	0-1	
		16-QAM	1 RB	0	1860	18700	14.35	14.6	0-1
					1880	18900	14.49	14.6	0-1
					1900	19100	14.32	14.6	0-1
	50			1860	18700	13.88	14.6	0-1	
				1880	18900	14.28	14.6	0-1	
				1900	19100	14.60	14.6	0-1	
	99			1860	18700	14.32	14.6	0-1	
				1880	18900	14.56	14.6	0-1	
				1900	19100	14.47	14.6	0-1	
	50 RB			0	1860	18700	13.26	13.6	0-2
					1880	18900	13.21	13.6	0-2
					1900	19100	13.51	13.6	0-2
			25	1860	18700	13.18	13.6	0-2	
				1880	18900	13.18	13.6	0-2	
				1900	19100	13.44	13.6	0-2	
			50	1860	18700	13.17	13.6	0-2	
				1880	18900	13.12	13.6	0-2	
				1900	19100	13.46	13.6	0-2	
			100RB	1860	18700	12.60	13.6	0-2	
				1880	18900	12.62	13.6	0-2	
				1900	19100	12.96	13.6	0-2	

Unless otherwise stated the results shown in this test report refer only to the sample(s) tested and such sample(s) are retained for 90 days only.

除非另有說明，此報告結果僅對測試之樣品負責，同時此樣品僅保留90天。本報告未經本公司書面許可，不可部份複製。

This document is issued by the Company subject to its General Conditions of Service printed overleaf, available on request or accessible at www.sgs.com/terms_and_conditions.htm and for electronic format documents, subject to Terms and Conditions for Electronic Documents at www.sgs.com/terms_e-document.htm. Attention is drawn to the limitation of liability, indemnification and jurisdiction issues defined therein. Any holder of this document is advised that information contained hereon reflects the Company's findings at the time of its intervention only and within the limits of Client's instructions, if any. The Company's sole responsibility is to its Client and this document does not exonerate parties to a transaction from exercising all their rights and obligations under the transaction documents. This document cannot be reproduced except in full, without prior written approval of the Company. Any unauthorized alteration, forgery or falsification of the content or appearance of this document is unlawful and offenders may be prosecuted to the fullest extent of the law.

FDD Band 2								
BW(Mhz)	Modulation	RB Size	RB Offset	Frequency (MHz)	Channel	Conducted power (dBm)	Target Power + Max. Tolerance (dBm)	MPR Allowed per 3GPP(dB)
20	64-QAM	1 RB	0	1860	18700	14.28	14.6	0-1
				1880	18900	14.37	14.6	0-1
				1900	19100	14.22	14.6	0-1
			50	1860	18700	13.74	14.6	0-1
				1880	18900	14.15	14.6	0-1
				1900	19100	14.48	14.6	0-1
			99	1860	18700	14.24	14.6	0-1
				1880	18900	14.43	14.6	0-1
				1900	19100	14.35	14.6	0-1
		50 RB	0	1860	18700	13.16	13.6	0-2
				1880	18900	13.07	13.6	0-2
				1900	19100	13.42	13.6	0-2
			25	1860	18700	13.02	13.6	0-2
				1880	18900	13.07	13.6	0-2
				1900	19100	13.33	13.6	0-2
			50	1860	18700	13.07	13.6	0-2
				1880	18900	12.99	13.6	0-2
				1900	19100	13.32	13.6	0-2
			100RB	1860	18700	12.46	13.6	0-2
				1880	18900	12.52	13.6	0-2
				1900	19100	12.84	13.6	0-2

Unless otherwise stated the results shown in this test report refer only to the sample(s) tested and such sample(s) are retained for 90 days only.

除非另有說明，此報告結果僅對測試之樣品負責，同時此樣品僅保留90天。本報告未經本公司書面許可，不可部份複製。

This document is issued by the Company subject to its General Conditions of Service printed overleaf, available on request or accessible at www.sgs.com/terms_and_conditions.htm and for electronic format documents, subject to Terms and Conditions for Electronic Documents at www.sgs.com/terms_e-document.htm. Attention is drawn to the limitation of liability, indemnification and jurisdiction issues defined therein. Any holder of this document is advised that information contained hereon reflects the Company's findings at the time of its intervention only and within the limits of Client's instructions, if any. The Company's sole responsibility is to its Client and this document does not exonerate parties to a transaction from exercising all their rights and obligations under the transaction documents. This document cannot be reproduced except in full, without prior written approval of the Company. Any unauthorized alteration, forgery or falsification of the content or appearance of this document is unlawful and offenders may be prosecuted to the fullest extent of the law.

FDD Band 2									
BW(Mhz)	Modulation	RB Size	RB Offset	Frequency (MHz)	Channel	Conducted power (dBm)	Target Power + Max. Tolerance (dBm)	MPR Allowed per 3GPP(dB)	
15	QPSK	1 RB	0	1857.5	18675	15.20	15.6	0	
				1880	18900	15.18	15.6	0	
				1902.5	19125	15.41	15.6	0	
			36	1857.5	18675	14.98	15.6	0	
				1880	18900	15.01	15.6	0	
				1902.5	19125	15.07	15.6	0	
			74	1857.5	18675	15.23	15.6	0	
				1880	18900	15.15	15.6	0	
				1902.5	19125	15.31	15.6	0	
		36 RB	0	1857.5	18675	14.14	14.6	0-1	
				1880	18900	14.24	14.6	0-1	
				1902.5	19125	14.39	14.6	0-1	
			18	1857.5	18675	14.11	14.6	0-1	
				1880	18900	14.10	14.6	0-1	
				1902.5	19125	14.43	14.6	0-1	
			37	1857.5	18675	14.19	14.6	0-1	
				1880	18900	14.01	14.6	0-1	
				1902.5	19125	14.23	14.6	0-1	
			75RB	1857.5	18675	13.48	14.6	0-1	
				1880	18900	13.51	14.6	0-1	
				1902.5	19125	13.78	14.6	0-1	
		16-QAM	1 RB	0	1857.5	18675	14.25	14.6	0-1
					1880	18900	14.40	14.6	0-1
					1902.5	19125	14.17	14.6	0-1
	36			1857.5	18675	13.71	14.6	0-1	
				1880	18900	14.16	14.6	0-1	
				1902.5	19125	14.47	14.6	0-1	
	74			1857.5	18675	14.26	14.6	0-1	
				1880	18900	14.39	14.6	0-1	
				1902.5	19125	14.36	14.6	0-1	
	36 RB			0	1857.5	18675	13.16	13.6	0-2
					1880	18900	13.15	13.6	0-2
					1902.5	19125	13.35	13.6	0-2
			18	1857.5	18675	13.08	13.6	0-2	
				1880	18900	13.10	13.6	0-2	
				1902.5	19125	13.43	13.6	0-2	
			37	1857.5	18675	13.01	13.6	0-2	
				1880	18900	13.06	13.6	0-2	
				1902.5	19125	13.34	13.6	0-2	
	75RB		1857.5	18675	12.53	13.6	0-2		
			1880	18900	12.46	13.6	0-2		
			1902.5	19125	12.78	13.6	0-2		

Unless otherwise stated the results shown in this test report refer only to the sample(s) tested and such sample(s) are retained for 90 days only.

除非另有說明，此報告結果僅對測試之樣品負責，同時此樣品僅保留90天。本報告未經本公司書面許可，不可部份複製。

This document is issued by the Company subject to its General Conditions of Service printed overleaf, available on request or accessible at www.sgs.com/terms_and_conditions.htm and for electronic format documents, subject to Terms and Conditions for Electronic Documents at www.sgs.com/terms_e-document.htm. Attention is drawn to the limitation of liability, indemnification and jurisdiction issues defined therein. Any holder of this document is advised that information contained hereon reflects the Company's findings at the time of its intervention only and within the limits of Client's instructions, if any. The Company's sole responsibility is to its Client and this document does not exonerate parties to a transaction from exercising all their rights and obligations under the transaction documents. This document cannot be reproduced except in full, without prior written approval of the Company. Any unauthorized alteration, forgery or falsification of the content or appearance of this document is unlawful and offenders may be prosecuted to the fullest extent of the law.

FDD Band 2								
BW(Mhz)	Modulation	RB Size	RB Offset	Frequency (MHz)	Channel	Conducted power (dBm)	Target Power + Max. Tolerance (dBm)	MPR Allowed per 3GPP(dB)
15	64-QAM	1 RB	0	1857.5	18675	14.11	14.6	0-1
				1880	18900	14.17	14.6	0-1
				1902.5	19125	14.06	14.6	0-1
			36	1857.5	18675	13.72	14.6	0-1
				1880	18900	14.12	14.6	0-1
				1902.5	19125	14.48	14.6	0-1
			74	1857.5	18675	14.11	14.6	0-1
				1880	18900	14.26	14.6	0-1
				1902.5	19125	14.39	14.6	0-1
		36 RB	0	1857.5	18675	13.15	13.6	0-2
				1880	18900	12.97	13.6	0-2
				1902.5	19125	13.24	13.6	0-2
			18	1857.5	18675	13.03	13.6	0-2
				1880	18900	12.89	13.6	0-2
				1902.5	19125	13.29	13.6	0-2
			37	1857.5	18675	13.01	13.6	0-2
				1880	18900	12.90	13.6	0-2
				1902.5	19125	13.21	13.6	0-2
			75RB	1857.5	18675	12.30	13.6	0-2
				1880	18900	12.48	13.6	0-2
				1902.5	19125	12.65	13.6	0-2

Unless otherwise stated the results shown in this test report refer only to the sample(s) tested and such sample(s) are retained for 90 days only.

除非另有說明，此報告結果僅對測試之樣品負責，同時此樣品僅保留90天。本報告未經本公司書面許可，不可部份複製。

This document is issued by the Company subject to its General Conditions of Service printed overleaf, available on request or accessible at www.sgs.com/terms_and_conditions.htm and for electronic format documents, subject to Terms and Conditions for Electronic Documents at www.sgs.com/terms_e-document.htm. Attention is drawn to the limitation of liability, indemnification and jurisdiction issues defined therein. Any holder of this document is advised that information contained hereon reflects the Company's findings at the time of its intervention only and within the limits of Client's instructions, if any. The Company's sole responsibility is to its Client and this document does not exonerate parties to a transaction from exercising all their rights and obligations under the transaction documents. This document cannot be reproduced except in full, without prior written approval of the Company. Any unauthorized alteration, forgery or falsification of the content or appearance of this document is unlawful and offenders may be prosecuted to the fullest extent of the law.

FDD Band 2									
BW(Mhz)	Modulation	RB Size	RB Offset	Frequency (MHz)	Channel	Conducted power (dBm)	Target Power + Max. Tolerance (dBm)	MPR Allowed per 3GPP(dB)	
10	QPSK	1 RB	0	1855	18650	15.16	15.6	0	
				1880	18900	15.24	15.6	0	
				1905	19150	15.50	15.6	0	
			25	1855	18650	15.06	15.6	0	
				1880	18900	14.88	15.6	0	
				1905	19150	15.08	15.6	0	
			49	1855	18650	15.20	15.6	0	
				1880	18900	15.16	15.6	0	
				1905	19150	15.34	15.6	0	
		25 RB	0	1855	18650	14.09	14.6	0-1	
				1880	18900	14.10	14.6	0-1	
				1905	19150	14.24	14.6	0-1	
			12	1855	18650	14.13	14.6	0-1	
				1880	18900	14.04	14.6	0-1	
				1905	19150	14.35	14.6	0-1	
			25	1855	18650	14.16	14.6	0-1	
				1880	18900	14.14	14.6	0-1	
				1905	19150	14.14	14.6	0-1	
			50RB	1855	18650	13.48	14.6	0-1	
				1880	18900	13.59	14.6	0-1	
				1905	19150	13.72	14.6	0-1	
		16-QAM	1 RB	0	1855	18650	14.23	14.6	0-1
					1880	18900	14.40	14.6	0-1
					1905	19150	14.26	14.6	0-1
	25			1855	18650	13.75	14.6	0-1	
				1880	18900	14.10	14.6	0-1	
				1905	19150	14.50	14.6	0-1	
	49			1855	18650	14.15	14.6	0-1	
				1880	18900	14.44	14.6	0-1	
				1905	19150	14.40	14.6	0-1	
	25 RB			0	1855	18650	13.20	13.6	0-2
					1880	18900	13.15	13.6	0-2
					1905	19150	13.54	13.6	0-2
			12	1855	18650	12.98	13.6	0-2	
				1880	18900	13.06	13.6	0-2	
				1905	19150	13.24	13.6	0-2	
			25	1855	18650	13.05	13.6	0-2	
				1880	18900	12.99	13.6	0-2	
				1905	19150	13.43	13.6	0-2	
	50RB		1855	18650	12.58	13.6	0-2		
			1880	18900	12.57	13.6	0-2		
			1905	19150	12.77	13.6	0-2		

Unless otherwise stated the results shown in this test report refer only to the sample(s) tested and such sample(s) are retained for 90 days only.

除非另有說明，此報告結果僅對測試之樣品負責，同時此樣品僅保留90天。本報告未經本公司書面許可，不可部份複製。

This document is issued by the Company subject to its General Conditions of Service printed overleaf, available on request or accessible at www.sgs.com/terms_and_conditions.htm and for electronic format documents, subject to Terms and Conditions for Electronic Documents at www.sgs.com/terms_e-document.htm. Attention is drawn to the limitation of liability, indemnification and jurisdiction issues defined therein. Any holder of this document is advised that information contained hereon reflects the Company's findings at the time of its intervention only and within the limits of Client's instructions, if any. The Company's sole responsibility is to its Client and this document does not exonerate parties to a transaction from exercising all their rights and obligations under the transaction documents. This document cannot be reproduced except in full, without prior written approval of the Company. Any unauthorized alteration, forgery or falsification of the content or appearance of this document is unlawful and offenders may be prosecuted to the fullest extent of the law.

FDD Band 2								
BW(Mhz)	Modulation	RB Size	RB Offset	Frequency (MHz)	Channel	Conducted power (dBm)	Target Power + Max. Tolerance (dBm)	MPR Allowed per 3GPP(dB)
10	64-QAM	1 RB	0	1855	18650	14.12	14.6	0-1
				1880	18900	14.21	14.6	0-1
				1905	19150	13.98	14.6	0-1
			25	1855	18650	13.67	14.6	0-1
				1880	18900	13.98	14.6	0-1
				1905	19150	14.46	14.6	0-1
			49	1855	18650	14.03	14.6	0-1
				1880	18900	14.32	14.6	0-1
				1905	19150	14.35	14.6	0-1
		25 RB	0	1855	18650	13.08	13.6	0-2
				1880	18900	12.90	13.6	0-2
				1905	19150	13.29	13.6	0-2
			12	1855	18650	13.03	13.6	0-2
				1880	18900	13.03	13.6	0-2
				1905	19150	13.24	13.6	0-2
			25	1855	18650	12.96	13.6	0-2
				1880	18900	12.96	13.6	0-2
				1905	19150	13.26	13.6	0-2
			50RB	1855	18650	12.34	13.6	0-2
				1880	18900	12.35	13.6	0-2
				1905	19150	12.67	13.6	0-2

Unless otherwise stated the results shown in this test report refer only to the sample(s) tested and such sample(s) are retained for 90 days only.

除非另有說明，此報告結果僅對測試之樣品負責，同時此樣品僅保留90天。本報告未經本公司書面許可，不可部份複製。

This document is issued by the Company subject to its General Conditions of Service printed overleaf, available on request or accessible at www.sgs.com/terms_and_conditions.htm and for electronic format documents, subject to Terms and Conditions for Electronic Documents at www.sgs.com/terms_e-document.htm. Attention is drawn to the limitation of liability, indemnification and jurisdiction issues defined therein. Any holder of this document is advised that information contained hereon reflects the Company's findings at the time of its intervention only and within the limits of Client's instructions, if any. The Company's sole responsibility is to its Client and this document does not exonerate parties to a transaction from exercising all their rights and obligations under the transaction documents. This document cannot be reproduced except in full, without prior written approval of the Company. Any unauthorized alteration, forgery or falsification of the content or appearance of this document is unlawful and offenders may be prosecuted to the fullest extent of the law.

FDD Band 2									
BW(Mhz)	Modulation	RB Size	RB Offset	Frequency (MHz)	Channel	Conducted power (dBm)	Target Power + Max. Tolerance (dBm)	MPR Allowed per 3GPP(dB)	
5	QPSK	1 RB	0	1852.5	18625	15.14	15.6	0	
				1880	18900	15.21	15.6	0	
				1907.5	19175	15.53	15.6	0	
			12	1852.5	18625	14.93	15.6	0	
				1880	18900	14.92	15.6	0	
				1907.5	19175	15.10	15.6	0	
		24	1852.5	18625	15.11	15.6	0		
			1880	18900	15.19	15.6	0		
			1907.5	19175	15.46	15.6	0		
		12 RB	0	1852.5	18625	14.17	14.6	0-1	
				1880	18900	14.24	14.6	0-1	
				1907.5	19175	14.40	14.6	0-1	
			6	1852.5	18625	14.10	14.6	0-1	
				1880	18900	13.98	14.6	0-1	
				1907.5	19175	14.36	14.6	0-1	
			13	1852.5	18625	14.10	14.6	0-1	
				1880	18900	14.07	14.6	0-1	
				1907.5	19175	14.29	14.6	0-1	
			25RB	1852.5	18625	13.44	14.6	0-1	
				1880	18900	13.62	14.6	0-1	
				1907.5	19175	13.74	14.6	0-1	
		16-QAM	1 RB	0	1852.5	18625	14.26	14.6	0-1
					1880	18900	14.46	14.6	0-1
					1907.5	19175	14.16	14.6	0-1
	12			1852.5	18625	13.84	14.6	0-1	
				1880	18900	14.11	14.6	0-1	
				1907.5	19175	14.52	14.6	0-1	
	24			1852.5	18625	14.23	14.6	0-1	
				1880	18900	14.36	14.6	0-1	
				1907.5	19175	14.27	14.6	0-1	
	12 RB			0	1852.5	18625	13.13	13.6	0-2
					1880	18900	13.19	13.6	0-2
					1907.5	19175	13.38	13.6	0-2
			6	1852.5	18625	13.07	13.6	0-2	
				1880	18900	13.12	13.6	0-2	
				1907.5	19175	13.24	13.6	0-2	
			13	1852.5	18625	13.04	13.6	0-2	
				1880	18900	12.99	13.6	0-2	
				1907.5	19175	13.41	13.6	0-2	
	25RB		1852.5	18625	12.51	13.6	0-2		
			1880	18900	12.54	13.6	0-2		
			1907.5	19175	12.93	13.6	0-2		

Unless otherwise stated the results shown in this test report refer only to the sample(s) tested and such sample(s) are retained for 90 days only.

除非另有說明，此報告結果僅對測試之樣品負責，同時此樣品僅保留90天。本報告未經本公司書面許可，不可部份複製。

This document is issued by the Company subject to its General Conditions of Service printed overleaf, available on request or accessible at www.sgs.com/terms_and_conditions.htm and for electronic format documents, subject to Terms and Conditions for Electronic Documents at www.sgs.com/terms_e-document.htm. Attention is drawn to the limitation of liability, indemnification and jurisdiction issues defined therein. Any holder of this document is advised that information contained hereon reflects the Company's findings at the time of its intervention only and within the limits of Client's instructions, if any. The Company's sole responsibility is to its Client and this document does not exonerate parties to a transaction from exercising all their rights and obligations under the transaction documents. This document cannot be reproduced except in full, without prior written approval of the Company. Any unauthorized alteration, forgery or falsification of the content or appearance of this document is unlawful and offenders may be prosecuted to the fullest extent of the law.

FDD Band 2								
BW(Mhz)	Modulation	RB Size	RB Offset	Frequency (MHz)	Channel	Conducted power (dBm)	Target Power + Max. Tolerance (dBm)	MPR Allowed per 3GPP(dB)
5	64-QAM	1 RB	0	1852.5	18625	14.21	14.6	0-1
				1880	18900	14.27	14.6	0-1
				1907.5	19175	14.00	14.6	0-1
			12	1852.5	18625	13.73	14.6	0-1
				1880	18900	14.05	14.6	0-1
				1907.5	19175	14.38	14.6	0-1
			24	1852.5	18625	14.17	14.6	0-1
				1880	18900	14.33	14.6	0-1
				1907.5	19175	14.26	14.6	0-1
		12 RB	0	1852.5	18625	13.06	13.6	0-2
				1880	18900	13.04	13.6	0-2
				1907.5	19175	13.31	13.6	0-2
			6	1852.5	18625	13.01	13.6	0-2
				1880	18900	13.00	13.6	0-2
				1907.5	19175	13.30	13.6	0-2
			13	1852.5	18625	12.95	13.6	0-2
				1880	18900	12.98	13.6	0-2
				1907.5	19175	13.31	13.6	0-2
			25RB	1852.5	18625	12.40	13.6	0-2
				1880	18900	12.41	13.6	0-2
				1907.5	19175	12.75	13.6	0-2

Unless otherwise stated the results shown in this test report refer only to the sample(s) tested and such sample(s) are retained for 90 days only.

除非另有說明，此報告結果僅對測試之樣品負責，同時此樣品僅保留90天。本報告未經本公司書面許可，不可部份複製。

This document is issued by the Company subject to its General Conditions of Service printed overleaf, available on request or accessible at www.sgs.com/terms_and_conditions.htm and for electronic format documents, subject to Terms and Conditions for Electronic Documents at www.sgs.com/terms_e-document.htm. Attention is drawn to the limitation of liability, indemnification and jurisdiction issues defined therein. Any holder of this document is advised that information contained hereon reflects the Company's findings at the time of its intervention only and within the limits of Client's instructions, if any. The Company's sole responsibility is to its Client and this document does not exonerate parties to a transaction from exercising all their rights and obligations under the transaction documents. This document cannot be reproduced except in full, without prior written approval of the Company. Any unauthorized alteration, forgery or falsification of the content or appearance of this document is unlawful and offenders may be prosecuted to the fullest extent of the law.

FDD Band 2									
BW(Mhz)	Modulation	RB Size	RB Offset	Frequency (MHz)	Channel	Conducted power (dBm)	Target Power + Max. Tolerance (dBm)	MPR Allowed per 3GPP(dB)	
3	QPSK	1 RB	0	1851.5	18615	15.30	15.6	0	
				1880	18900	15.14	15.6	0	
				1908.5	19185	15.47	15.6	0	
			7	1851.5	18615	14.98	15.6	0	
				1880	18900	15.00	15.6	0	
				1908.5	19185	15.16	15.6	0	
		14	1851.5	18615	15.23	15.6	0		
			1880	18900	15.19	15.6	0		
			1908.5	19185	15.39	15.6	0		
		8 RB	0	1851.5	18615	14.13	14.6	0-1	
				1880	18900	14.17	14.6	0-1	
				1908.5	19185	14.38	14.6	0-1	
			4	1851.5	18615	14.13	14.6	0-1	
				1880	18900	14.08	14.6	0-1	
				1908.5	19185	14.41	14.6	0-1	
			7	1851.5	18615	14.11	14.6	0-1	
				1880	18900	14.05	14.6	0-1	
				1908.5	19185	14.23	14.6	0-1	
		15RB	1851.5	18615	13.44	14.6	0-1		
			1880	18900	13.45	14.6	0-1		
			1908.5	19185	13.90	14.6	0-1		
		16-QAM	1 RB	0	1851.5	18615	14.27	14.6	0-1
					1880	18900	14.29	14.6	0-1
					1908.5	19185	14.15	14.6	0-1
	7			1851.5	18615	13.71	14.6	0-1	
				1880	18900	14.10	14.6	0-1	
				1908.5	19185	14.57	14.6	0-1	
	14			1851.5	18615	14.17	14.6	0-1	
				1880	18900	14.43	14.6	0-1	
				1908.5	19185	14.48	14.6	0-1	
	8 RB		0	1851.5	18615	13.14	13.6	0-2	
				1880	18900	13.11	13.6	0-2	
				1908.5	19185	13.51	13.6	0-2	
			4	1851.5	18615	13.05	13.6	0-2	
				1880	18900	13.11	13.6	0-2	
				1908.5	19185	13.34	13.6	0-2	
			7	1851.5	18615	13.14	13.6	0-2	
				1880	18900	12.98	13.6	0-2	
				1908.5	19185	13.41	13.6	0-2	
	15RB		1851.5	18615	12.47	13.6	0-2		
			1880	18900	12.62	13.6	0-2		
			1908.5	19185	12.77	13.6	0-2		

Unless otherwise stated the results shown in this test report refer only to the sample(s) tested and such sample(s) are retained for 90 days only.

除非另有說明，此報告結果僅對測試之樣品負責，同時此樣品僅保留90天。本報告未經本公司書面許可，不可部份複製。

This document is issued by the Company subject to its General Conditions of Service printed overleaf, available on request or accessible at www.sgs.com/terms_and_conditions.htm and for electronic format documents, subject to Terms and Conditions for Electronic Documents at www.sgs.com/terms_e-document.htm. Attention is drawn to the limitation of liability, indemnification and jurisdiction issues defined therein. Any holder of this document is advised that information contained hereon reflects the Company's findings at the time of its intervention only and within the limits of Client's instructions, if any. The Company's sole responsibility is to its Client and this document does not exonerate parties to a transaction from exercising all their rights and obligations under the transaction documents. This document cannot be reproduced except in full, without prior written approval of the Company. Any unauthorized alteration, forgery or falsification of the content or appearance of this document is unlawful and offenders may be prosecuted to the fullest extent of the law.

FDD Band 2								
BW(MHz)	Modulation	RB Size	RB Offset	Frequency (MHz)	Channel	Conducted power (dBm)	Target Power + Max. Tolerance (dBm)	MPR Allowed per 3GPP(dB)
3	64-QAM	1 RB	0	1851.5	18615	14.26	14.6	0-1
				1880	18900	14.25	14.6	0-1
				1908.5	19185	14.08	14.6	0-1
			7	1851.5	18615	13.61	14.6	0-1
				1880	18900	13.97	14.6	0-1
				1908.5	19185	14.46	14.6	0-1
			14	1851.5	18615	14.12	14.6	0-1
				1880	18900	14.38	14.6	0-1
				1908.5	19185	14.20	14.6	0-1
		8 RB	0	1851.5	18615	12.97	13.6	0-2
				1880	18900	12.97	13.6	0-2
				1908.5	19185	13.37	13.6	0-2
			4	1851.5	18615	12.87	13.6	0-2
				1880	18900	12.90	13.6	0-2
				1908.5	19185	13.22	13.6	0-2
			7	1851.5	18615	13.07	13.6	0-2
				1880	18900	12.93	13.6	0-2
				1908.5	19185	13.19	13.6	0-2
		15RB	1851.5	18615	12.34	13.6	0-2	
			1880	18900	12.40	13.6	0-2	
			1908.5	19185	12.81	13.6	0-2	

Unless otherwise stated the results shown in this test report refer only to the sample(s) tested and such sample(s) are retained for 90 days only.

除非另有說明，此報告結果僅對測試之樣品負責，同時此樣品僅保留90天。本報告未經本公司書面許可，不可部份複製。

This document is issued by the Company subject to its General Conditions of Service printed overleaf, available on request or accessible at www.sgs.com/terms_and_conditions.htm and for electronic format documents, subject to Terms and Conditions for Electronic Documents at www.sgs.com/terms_e-document.htm. Attention is drawn to the limitation of liability, indemnification and jurisdiction issues defined therein. Any holder of this document is advised that information contained hereon reflects the Company's findings at the time of its intervention only and within the limits of Client's instructions, if any. The Company's sole responsibility is to its Client and this document does not exonerate parties to a transaction from exercising all their rights and obligations under the transaction documents. This document cannot be reproduced except in full, without prior written approval of the Company. Any unauthorized alteration, forgery or falsification of the content or appearance of this document is unlawful and offenders may be prosecuted to the fullest extent of the law.

FDD Band 2									
BW(MHz)	Modulation	RB Size	RB Offset	Frequency (MHz)	Channel	Conducted power (dBm)	Target Power + Max. Tolerance (dBm)	MPR Allowed per 3GPP(dB)	
1.4	QPSK	1 RB	0	1850.7	18607	15.22	15.6	0	
				1880	18900	15.10	15.6	0	
				1909.3	19193	15.36	15.6	0	
			2	1850.7	18607	14.97	15.6	0	
				1880	18900	14.98	15.6	0	
				1909.3	19193	15.01	15.6	0	
		5	1850.7	18607	15.22	15.6	0		
			1880	18900	15.09	15.6	0		
			1909.3	19193	15.41	15.6	0		
		3 RB	0	1850.7	18607	14.22	14.6	0-1	
				1880	18900	14.12	14.6	0-1	
				1909.3	19193	14.26	14.6	0-1	
			2	1850.7	18607	14.16	14.6	0-1	
				1880	18900	14.10	14.6	0-1	
				1909.3	19193	14.28	14.6	0-1	
			3	1850.7	18607	14.18	14.6	0-1	
				1880	18900	14.02	14.6	0-1	
				1909.3	19193	14.33	14.6	0-1	
		6RB	1850.7	18607	13.57	14.6	0-1		
			1880	18900	13.64	14.6	0-1		
			1909.3	19193	13.79	14.6	0-1		
		16-QAM	1 RB	0	1850.7	18607	14.25	14.6	0-1
					1880	18900	14.38	14.6	0-1
					1909.3	19193	14.31	14.6	0-1
	2			1850.7	18607	13.85	14.6	0-1	
				1880	18900	14.14	14.6	0-1	
				1909.3	19193	14.46	14.6	0-1	
	5			1850.7	18607	14.28	14.6	0-1	
				1880	18900	14.46	14.6	0-1	
				1909.3	19193	14.39	14.6	0-1	
	3 RB			0	1850.7	18607	13.18	13.6	0-2
					1880	18900	13.15	13.6	0-2
					1909.3	19193	13.35	13.6	0-2
			2	1850.7	18607	13.17	13.6	0-2	
				1880	18900	13.04	13.6	0-2	
				1909.3	19193	13.34	13.6	0-2	
			3	1850.7	18607	13.19	13.6	0-2	
				1880	18900	12.97	13.6	0-2	
				1909.3	19193	13.34	13.6	0-2	
	6RB		1850.7	18607	12.41	13.6	0-2		
			1880	18900	12.52	13.6	0-2		
			1909.3	19193	12.94	13.6	0-2		

Unless otherwise stated the results shown in this test report refer only to the sample(s) tested and such sample(s) are retained for 90 days only.

除非另有說明，此報告結果僅對測試之樣品負責，同時此樣品僅保留90天。本報告未經本公司書面許可，不可部份複製。

This document is issued by the Company subject to its General Conditions of Service printed overleaf, available on request or accessible at www.sgs.com/terms_and_conditions.htm and for electronic format documents, subject to Terms and Conditions for Electronic Documents at www.sgs.com/terms_e-document.htm. Attention is drawn to the limitation of liability, indemnification and jurisdiction issues defined therein. Any holder of this document is advised that information contained hereon reflects the Company's findings at the time of its intervention only and within the limits of Client's instructions, if any. The Company's sole responsibility is to its Client and this document does not exonerate parties to a transaction from exercising all their rights and obligations under the transaction documents. This document cannot be reproduced except in full, without prior written approval of the Company. Any unauthorized alteration, forgery or falsification of the content or appearance of this document is unlawful and offenders may be prosecuted to the fullest extent of the law.

FDD Band 2								
BW(Mhz)	Modulation	RB Size	RB Offset	Frequency (MHz)	Channel	Conducted power (dBm)	Target Power + Max. Tolerance (dBm)	MPR Allowed per 3GPP(dB)
1.4	64-QAM	1 RB	0	1850.7	18607	14.15	14.6	0-1
				1880	18900	14.32	14.6	0-1
				1909.3	19193	14.05	14.6	0-1
			2	1850.7	18607	13.71	14.6	0-1
				1880	18900	14.14	14.6	0-1
				1909.3	19193	14.52	14.6	0-1
			5	1850.7	18607	14.08	14.6	0-1
				1880	18900	14.35	14.6	0-1
				1909.3	19193	14.32	14.6	0-1
		3 RB	0	1850.7	18607	13.10	13.6	0-2
				1880	18900	13.05	13.6	0-2
				1909.3	19193	13.33	13.6	0-2
			2	1850.7	18607	12.87	13.6	0-2
				1880	18900	13.02	13.6	0-2
				1909.3	19193	13.15	13.6	0-2
			3	1850.7	18607	12.96	13.6	0-2
				1880	18900	12.85	13.6	0-2
				1909.3	19193	13.17	13.6	0-2
			6RB	1850.7	18607	12.40	13.6	0-2
				1880	18900	12.51	13.6	0-2
				1909.3	19193	12.76	13.6	0-2

Unless otherwise stated the results shown in this test report refer only to the sample(s) tested and such sample(s) are retained for 90 days only.

除非另有說明，此報告結果僅對測試之樣品負責，同時此樣品僅保留90天。本報告未經本公司書面許可，不可部份複製。

This document is issued by the Company subject to its General Conditions of Service printed overleaf, available on request or accessible at www.sgs.com/terms_and_conditions.htm and for electronic format documents, subject to Terms and Conditions for Electronic Documents at www.sgs.com/terms_e-document.htm. Attention is drawn to the limitation of liability, indemnification and jurisdiction issues defined therein. Any holder of this document is advised that information contained hereon reflects the Company's findings at the time of its intervention only and within the limits of Client's instructions, if any. The Company's sole responsibility is to its Client and this document does not exonerate parties to a transaction from exercising all their rights and obligations under the transaction documents. This document cannot be reproduced except in full, without prior written approval of the Company. Any unauthorized alteration, forgery or falsification of the content or appearance of this document is unlawful and offenders may be prosecuted to the fullest extent of the law.

FDD Band 4											
BW(Mhz)	Modulation	RB Size	RB Offset	Frequency (MHz)	Channel	Conducted power (dBm)	Target Power + Max. Tolerance (dBm)	MPR Allowed per 3GPP(dB)			
20	QPSK	1 RB	0	1720	20050	16.39	16.9	0			
				1732.5	20175	16.49	16.9	0			
				1745	20300	16.39	16.9	0			
			50	50	1720	20050	16.17	16.9	0		
					1732.5	20175	16.20	16.9	0		
					1745	20300	16.13	16.9	0		
			99	99	0	1720	20050	16.23	16.9	0	
						1732.5	20175	16.10	16.9	0	
						1745	20300	16.03	16.9	0	
		50 RB	0	0	1720	20050	15.37	15.9	0-1		
					1732.5	20175	15.38	15.9	0-1		
					1745	20300	15.27	15.9	0-1		
				25	25	1720	20050	15.24	15.9	0-1	
						1732.5	20175	15.25	15.9	0-1	
						1745	20300	15.20	15.9	0-1	
			50	50	0	1720	20050	15.28	15.9	0-1	
						1732.5	20175	15.26	15.9	0-1	
						1745	20300	15.14	15.9	0-1	
			100RB	100RB	0	1720	20050	14.80	15.9	0-1	
						1732.5	20175	14.79	15.9	0-1	
						1745	20300	14.74	15.9	0-1	
		16-QAM	1 RB	0	1720	20050	15.73	15.9	0-1		
					1732.5	20175	15.83	15.9	0-1		
					1745	20300	15.74	15.9	0-1		
	50			50	0	1720	20050	15.49	15.9	0-1	
						1732.5	20175	15.55	15.9	0-1	
						1745	20300	15.45	15.9	0-1	
	99			99	0	1720	20050	15.57	15.9	0-1	
						1732.5	20175	15.45	15.9	0-1	
						1745	20300	15.33	15.9	0-1	
	50 RB			0	0	1720	20050	14.32	14.9	0-2	
						1732.5	20175	14.43	14.9	0-2	
						1745	20300	14.34	14.9	0-2	
			25		25	0	1720	20050	14.29	14.9	0-2
							1732.5	20175	14.29	14.9	0-2
							1745	20300	14.23	14.9	0-2
			50	50	0	1720	20050	14.24	14.9	0-2	
						1732.5	20175	14.22	14.9	0-2	
						1745	20300	14.13	14.9	0-2	
			100RB	100RB	0	1720	20050	13.76	14.9	0-2	
						1732.5	20175	13.84	14.9	0-2	
						1745	20300	13.73	14.9	0-2	

Unless otherwise stated the results shown in this test report refer only to the sample(s) tested and such sample(s) are retained for 90 days only.

除非另有說明，此報告結果僅對測試之樣品負責，同時此樣品僅保留90天。本報告未經本公司書面許可，不可部份複製。

This document is issued by the Company subject to its General Conditions of Service printed overleaf, available on request or accessible at www.sgs.com/terms_and_conditions.htm and for electronic format documents, subject to Terms and Conditions for Electronic Documents at www.sgs.com/terms_e-document.htm. Attention is drawn to the limitation of liability, indemnification and jurisdiction issues defined therein. Any holder of this document is advised that information contained hereon reflects the Company's findings at the time of its intervention only and within the limits of Client's instructions, if any. The Company's sole responsibility is to its Client and this document does not exonerate parties to a transaction from exercising all their rights and obligations under the transaction documents. This document cannot be reproduced except in full, without prior written approval of the Company. Any unauthorized alteration, forgery or falsification of the content or appearance of this document is unlawful and offenders may be prosecuted to the fullest extent of the law.

FDD Band 4										
BW(MHz)	Modulation	RB Size	RB Offset	Frequency (MHz)	Channel	Conducted power (dBm)	Target Power + Max. Tolerance (dBm)	MPR Allowed per 3GPP(dB)		
20	64-QAM	1 RB	0	1720	20050	15.52	15.9	0-1		
				1732.5	20175	15.63	15.9	0-1		
				1745	20300	15.51	15.9	0-1		
			50	50	1720	20050	15.24	15.9	0-1	
					1732.5	20175	15.34	15.9	0-1	
					1745	20300	15.22	15.9	0-1	
			99	99	0	1720	20050	15.36	15.9	0-1
						1732.5	20175	15.20	15.9	0-1
						1745	20300	15.12	15.9	0-1
		50 RB	0	0	1720	20050	14.13	14.9	0-2	
					1732.5	20175	14.17	14.9	0-2	
					1745	20300	14.08	14.9	0-2	
			25	25	0	1720	20050	14.07	14.9	0-2
						1732.5	20175	14.10	14.9	0-2
						1745	20300	14.04	14.9	0-2
			50	50	0	1720	20050	14.02	14.9	0-2
						1732.5	20175	13.97	14.9	0-2
						1745	20300	13.92	14.9	0-2
			100RB	100RB	0	1720	20050	13.52	14.9	0-2
						1732.5	20175	13.57	14.9	0-2
						1745	20300	13.47	14.9	0-2

Unless otherwise stated the results shown in this test report refer only to the sample(s) tested and such sample(s) are retained for 90 days only.

除非另有說明，此報告結果僅對測試之樣品負責，同時此樣品僅保留90天。本報告未經本公司書面許可，不可部份複製。

This document is issued by the Company subject to its General Conditions of Service printed overleaf, available on request or accessible at www.sgs.com/terms_and_conditions.htm and for electronic format documents, subject to Terms and Conditions for Electronic Documents at www.sgs.com/terms_e-document.htm. Attention is drawn to the limitation of liability, indemnification and jurisdiction issues defined therein. Any holder of this document is advised that information contained hereon reflects the Company's findings at the time of its intervention only and within the limits of Client's instructions, if any. The Company's sole responsibility is to its Client and this document does not exonerate parties to a transaction from exercising all their rights and obligations under the transaction documents. This document cannot be reproduced except in full, without prior written approval of the Company. Any unauthorized alteration, forgery or falsification of the content or appearance of this document is unlawful and offenders may be prosecuted to the fullest extent of the law.

FDD Band 4									
BW(Mhz)	Modulation	RB Size	RB Offset	Frequency (MHz)	Channel	Conducted power (dBm)	Target Power + Max. Tolerance (dBm)	MPR Allowed per 3GPP(dB)	
15	QPSK	1 RB	0	1717.5	20025	16.16	16.9	0	
				1732.5	20175	16.39	16.9	0	
				1747.5	20325	16.26	16.9	0	
			36	1717.5	20025	16.16	16.9	0	
				1732.5	20175	16.16	16.9	0	
				1747.5	20325	15.92	16.9	0	
			74	1717.5	20025	16.14	16.9	0	
				1732.5	20175	15.97	16.9	0	
				1747.5	20325	15.91	16.9	0	
		36 RB	0	1717.5	20025	15.34	15.9	0-1	
				1732.5	20175	15.26	15.9	0-1	
				1747.5	20325	15.12	15.9	0-1	
			18	1717.5	20025	15.07	15.9	0-1	
				1732.5	20175	15.26	15.9	0-1	
				1747.5	20325	15.01	15.9	0-1	
			37	1717.5	20025	15.16	15.9	0-1	
				1732.5	20175	15.20	15.9	0-1	
				1747.5	20325	14.96	15.9	0-1	
		75RB	1717.5	20025	14.69	15.9	0-1		
			1732.5	20175	14.72	15.9	0-1		
			1747.5	20325	14.54	15.9	0-1		
		16-QAM	1 RB	0	1717.5	20025	15.59	15.9	0-1
					1732.5	20175	15.85	15.9	0-1
					1747.5	20325	15.73	15.9	0-1
	36			1717.5	20025	15.30	15.9	0-1	
				1732.5	20175	15.46	15.9	0-1	
				1747.5	20325	15.32	15.9	0-1	
	74			1717.5	20025	15.57	15.9	0-1	
				1732.5	20175	15.37	15.9	0-1	
				1747.5	20325	15.17	15.9	0-1	
	36 RB		0	1717.5	20025	14.30	14.9	0-2	
				1732.5	20175	14.38	14.9	0-2	
				1747.5	20325	14.22	14.9	0-2	
			18	1717.5	20025	14.25	14.9	0-2	
				1732.5	20175	14.24	14.9	0-2	
				1747.5	20325	14.11	14.9	0-2	
			37	1717.5	20025	14.21	14.9	0-2	
				1732.5	20175	14.19	14.9	0-2	
				1747.5	20325	14.10	14.9	0-2	
	75RB		1717.5	20025	13.60	14.9	0-2		
			1732.5	20175	13.80	14.9	0-2		
			1747.5	20325	13.63	14.9	0-2		

Unless otherwise stated the results shown in this test report refer only to the sample(s) tested and such sample(s) are retained for 90 days only.

除非另有說明，此報告結果僅對測試之樣品負責，同時此樣品僅保留90天。本報告未經本公司書面許可，不可部份複製。

This document is issued by the Company subject to its General Conditions of Service printed overleaf, available on request or accessible at www.sgs.com/terms_and_conditions.htm and for electronic format documents, subject to Terms and Conditions for Electronic Documents at www.sgs.com/terms_e-document.htm. Attention is drawn to the limitation of liability, indemnification and jurisdiction issues defined therein. Any holder of this document is advised that information contained hereon reflects the Company's findings at the time of its intervention only and within the limits of Client's instructions, if any. The Company's sole responsibility is to its Client and this document does not exonerate parties to a transaction from exercising all their rights and obligations under the transaction documents. This document cannot be reproduced except in full, without prior written approval of the Company. Any unauthorized alteration, forgery or falsification of the content or appearance of this document is unlawful and offenders may be prosecuted to the fullest extent of the law.

FDD Band 4								
BW(MHz)	Modulation	RB Size	RB Offset	Frequency (MHz)	Channel	Conducted power (dBm)	Target Power + Max. Tolerance (dBm)	MPR Allowed per 3GPP(dB)
15	64-QAM	1 RB	0	1717.5	20025	15.29	15.9	0-1
				1732.5	20175	15.53	15.9	0-1
				1747.5	20325	15.49	15.9	0-1
			36	1717.5	20025	15.13	15.9	0-1
				1732.5	20175	15.28	15.9	0-1
				1747.5	20325	15.03	15.9	0-1
			74	1717.5	20025	15.27	15.9	0-1
				1732.5	20175	15.16	15.9	0-1
				1747.5	20325	15.01	15.9	0-1
		36 RB	0	1717.5	20025	14.10	14.9	0-2
				1732.5	20175	14.08	14.9	0-2
				1747.5	20325	14.06	14.9	0-2
			18	1717.5	20025	13.85	14.9	0-2
				1732.5	20175	13.93	14.9	0-2
				1747.5	20325	13.89	14.9	0-2
			37	1717.5	20025	14.01	14.9	0-2
				1732.5	20175	13.98	14.9	0-2
				1747.5	20325	13.89	14.9	0-2
			75RB	1717.5	20025	13.48	14.9	0-2
				1732.5	20175	13.57	14.9	0-2
				1747.5	20325	13.43	14.9	0-2

Unless otherwise stated the results shown in this test report refer only to the sample(s) tested and such sample(s) are retained for 90 days only.

除非另有說明，此報告結果僅對測試之樣品負責，同時此樣品僅保留90天。本報告未經本公司書面許可，不可部份複製。

This document is issued by the Company subject to its General Conditions of Service printed overleaf, available on request or accessible at www.sgs.com/terms_and_conditions.htm and for electronic format documents, subject to Terms and Conditions for Electronic Documents at www.sgs.com/terms_e-document.htm. Attention is drawn to the limitation of liability, indemnification and jurisdiction issues defined therein. Any holder of this document is advised that information contained hereon reflects the Company's findings at the time of its intervention only and within the limits of Client's instructions, if any. The Company's sole responsibility is to its Client and this document does not exonerate parties to a transaction from exercising all their rights and obligations under the transaction documents. This document cannot be reproduced except in full, without prior written approval of the Company. Any unauthorized alteration, forgery or falsification of the content or appearance of this document is unlawful and offenders may be prosecuted to the fullest extent of the law.

FDD Band 4									
BW(Mhz)	Modulation	RB Size	RB Offset	Frequency (MHz)	Channel	Conducted power (dBm)	Target Power + Max. Tolerance (dBm)	MPR Allowed per 3GPP(dB)	
10	QPSK	1 RB	0	1715	20000	16.27	16.9	0	
				1732.5	20175	16.30	16.9	0	
				1750	20350	16.18	16.9	0	
			25	1715	20000	15.99	16.9	0	
				1732.5	20175	16.04	16.9	0	
				1750	20350	15.99	16.9	0	
		49	1715	20000	16.10	16.9	0		
			1732.5	20175	16.00	16.9	0		
			1750	20350	15.94	16.9	0		
		25 RB	0	1715	20000	15.21	15.9	0-1	
				1732.5	20175	15.37	15.9	0-1	
				1750	20350	15.12	15.9	0-1	
			12	1715	20000	15.15	15.9	0-1	
				1732.5	20175	15.14	15.9	0-1	
				1750	20350	15.16	15.9	0-1	
			25	1715	20000	15.19	15.9	0-1	
				1732.5	20175	15.22	15.9	0-1	
				1750	20350	15.14	15.9	0-1	
			50RB	1715	20000	14.60	15.9	0-1	
				1732.5	20175	14.67	15.9	0-1	
				1750	20350	14.61	15.9	0-1	
		16-QAM	1 RB	0	1715	20000	15.62	15.9	0-1
					1732.5	20175	15.79	15.9	0-1
					1750	20350	15.62	15.9	0-1
	25			1715	20000	15.44	15.9	0-1	
				1732.5	20175	15.49	15.9	0-1	
				1750	20350	15.35	15.9	0-1	
	49			1715	20000	15.49	15.9	0-1	
				1732.5	20175	15.33	15.9	0-1	
				1750	20350	15.28	15.9	0-1	
	25 RB			0	1715	20000	14.25	14.9	0-2
					1732.5	20175	14.25	14.9	0-2
					1750	20350	14.33	14.9	0-2
			12	1715	20000	14.10	14.9	0-2	
				1732.5	20175	14.17	14.9	0-2	
				1750	20350	14.07	14.9	0-2	
			25	1715	20000	14.17	14.9	0-2	
				1732.5	20175	14.05	14.9	0-2	
				1750	20350	13.98	14.9	0-2	
	50RB		1715	20000	13.62	14.9	0-2		
			1732.5	20175	13.78	14.9	0-2		
			1750	20350	13.69	14.9	0-2		

Unless otherwise stated the results shown in this test report refer only to the sample(s) tested and such sample(s) are retained for 90 days only.

除非另有說明，此報告結果僅對測試之樣品負責，同時此樣品僅保留90天。本報告未經本公司書面許可，不可部份複製。

This document is issued by the Company subject to its General Conditions of Service printed overleaf, available on request or accessible at www.sgs.com/terms_and_conditions.htm and for electronic format documents, subject to Terms and Conditions for Electronic Documents at www.sgs.com/terms_e-document.htm. Attention is drawn to the limitation of liability, indemnification and jurisdiction issues defined therein. Any holder of this document is advised that information contained hereon reflects the Company's findings at the time of its intervention only and within the limits of Client's instructions, if any. The Company's sole responsibility is to its Client and this document does not exonerate parties to a transaction from exercising all their rights and obligations under the transaction documents. This document cannot be reproduced except in full, without prior written approval of the Company. Any unauthorized alteration, forgery or falsification of the content or appearance of this document is unlawful and offenders may be prosecuted to the fullest extent of the law.

FDD Band 4								
BW(MHz)	Modulation	RB Size	RB Offset	Frequency (MHz)	Channel	Conducted power (dBm)	Target Power + Max. Tolerance (dBm)	MPR Allowed per 3GPP(dB)
10	64-QAM	1 RB	0	1715	20000	15.36	15.9	0-1
				1732.5	20175	15.45	15.9	0-1
				1750	20350	15.40	15.9	0-1
			25	1715	20000	15.13	15.9	0-1
				1732.5	20175	15.14	15.9	0-1
				1750	20350	15.12	15.9	0-1
			49	1715	20000	15.16	15.9	0-1
				1732.5	20175	15.08	15.9	0-1
				1750	20350	14.97	15.9	0-1
		25 RB	0	1715	20000	14.05	14.9	0-2
				1732.5	20175	14.07	14.9	0-2
				1750	20350	14.03	14.9	0-2
			12	1715	20000	13.93	14.9	0-2
				1732.5	20175	13.93	14.9	0-2
				1750	20350	13.91	14.9	0-2
			25	1715	20000	13.90	14.9	0-2
				1732.5	20175	13.89	14.9	0-2
				1750	20350	13.85	14.9	0-2
			50RB	1715	20000	13.47	14.9	0-2
				1732.5	20175	13.53	14.9	0-2
				1750	20350	13.39	14.9	0-2

Unless otherwise stated the results shown in this test report refer only to the sample(s) tested and such sample(s) are retained for 90 days only.

除非另有說明，此報告結果僅對測試之樣品負責，同時此樣品僅保留90天。本報告未經本公司書面許可，不可部份複製。

This document is issued by the Company subject to its General Conditions of Service printed overleaf, available on request or accessible at www.sgs.com/terms_and_conditions.htm and for electronic format documents, subject to Terms and Conditions for Electronic Documents at www.sgs.com/terms_e-document.htm. Attention is drawn to the limitation of liability, indemnification and jurisdiction issues defined therein. Any holder of this document is advised that information contained hereon reflects the Company's findings at the time of its intervention only and within the limits of Client's instructions, if any. The Company's sole responsibility is to its Client and this document does not exonerate parties to a transaction from exercising all their rights and obligations under the transaction documents. This document cannot be reproduced except in full, without prior written approval of the Company. Any unauthorized alteration, forgery or falsification of the content or appearance of this document is unlawful and offenders may be prosecuted to the fullest extent of the law.

FDD Band 4									
BW(Mhz)	Modulation	RB Size	RB Offset	Frequency (MHz)	Channel	Conducted power (dBm)	Target Power + Max. Tolerance (dBm)	MPR Allowed per 3GPP(dB)	
5	QPSK	1 RB	0	1712.5	19975	16.22	16.9	0	
				1732.5	20175	16.30	16.9	0	
				1752.5	20375	16.33	16.9	0	
			12	1712.5	19975	16.06	16.9	0	
				1732.5	20175	16.19	16.9	0	
				1752.5	20375	16.04	16.9	0	
		24	1712.5	19975	16.13	16.9	0		
			1732.5	20175	16.09	16.9	0		
			1752.5	20375	15.92	16.9	0		
		12 RB	0	1712.5	19975	15.26	15.9	0-1	
				1732.5	20175	15.22	15.9	0-1	
				1752.5	20375	15.10	15.9	0-1	
			6	1712.5	19975	15.09	15.9	0-1	
				1732.5	20175	15.14	15.9	0-1	
				1752.5	20375	15.08	15.9	0-1	
			13	1712.5	19975	15.10	15.9	0-1	
				1732.5	20175	15.15	15.9	0-1	
				1752.5	20375	15.07	15.9	0-1	
		25RB	1712.5	19975	14.79	15.9	0-1		
			1732.5	20175	14.67	15.9	0-1		
			1752.5	20375	14.73	15.9	0-1		
		16-QAM	1 RB	0	1712.5	19975	15.76	15.9	0-1
					1732.5	20175	15.67	15.9	0-1
					1752.5	20375	15.58	15.9	0-1
	12			1712.5	19975	15.38	15.9	0-1	
				1732.5	20175	15.52	15.9	0-1	
				1752.5	20375	15.36	15.9	0-1	
	24			1712.5	19975	15.39	15.9	0-1	
				1732.5	20175	15.36	15.9	0-1	
				1752.5	20375	15.15	15.9	0-1	
	12 RB		0	1712.5	19975	14.13	14.9	0-2	
				1732.5	20175	14.20	14.9	0-2	
				1752.5	20375	14.27	14.9	0-2	
			6	1712.5	19975	14.12	14.9	0-2	
				1732.5	20175	14.29	14.9	0-2	
				1752.5	20375	14.22	14.9	0-2	
			13	1712.5	19975	14.05	14.9	0-2	
				1732.5	20175	14.17	14.9	0-2	
				1752.5	20375	14.03	14.9	0-2	
	25RB		1712.5	19975	13.62	14.9	0-2		
			1732.5	20175	13.67	14.9	0-2		
			1752.5	20375	13.59	14.9	0-2		

Unless otherwise stated the results shown in this test report refer only to the sample(s) tested and such sample(s) are retained for 90 days only.

除非另有說明，此報告結果僅對測試之樣品負責，同時此樣品僅保留90天。本報告未經本公司書面許可，不可部份複製。

This document is issued by the Company subject to its General Conditions of Service printed overleaf, available on request or accessible at www.sgs.com/terms_and_conditions.htm and for electronic format documents, subject to Terms and Conditions for Electronic Documents at www.sgs.com/terms_e-document.htm. Attention is drawn to the limitation of liability, indemnification and jurisdiction issues defined therein. Any holder of this document is advised that information contained hereon reflects the Company's findings at the time of its intervention only and within the limits of Client's instructions, if any. The Company's sole responsibility is to its Client and this document does not exonerate parties to a transaction from exercising all their rights and obligations under the transaction documents. This document cannot be reproduced except in full, without prior written approval of the Company. Any unauthorized alteration, forgery or falsification of the content or appearance of this document is unlawful and offenders may be prosecuted to the fullest extent of the law.

FDD Band 4								
BW(MHz)	Modulation	RB Size	RB Offset	Frequency (MHz)	Channel	Conducted power (dBm)	Target Power + Max. Tolerance (dBm)	MPR Allowed per 3GPP(dB)
5	64-QAM	1 RB	0	1712.5	19975	15.31	15.9	0-1
				1732.5	20175	15.55	15.9	0-1
				1752.5	20375	15.45	15.9	0-1
			12	1712.5	19975	15.07	15.9	0-1
				1732.5	20175	15.23	15.9	0-1
				1752.5	20375	15.24	15.9	0-1
			24	1712.5	19975	15.24	15.9	0-1
				1732.5	20175	15.06	15.9	0-1
				1752.5	20375	15.06	15.9	0-1
		12 RB	0	1712.5	19975	14.07	14.9	0-2
				1732.5	20175	14.12	14.9	0-2
				1752.5	20375	13.97	14.9	0-2
			6	1712.5	19975	13.88	14.9	0-2
				1732.5	20175	14.05	14.9	0-2
				1752.5	20375	13.91	14.9	0-2
			13	1712.5	19975	13.98	14.9	0-2
				1732.5	20175	13.82	14.9	0-2
				1752.5	20375	13.81	14.9	0-2
		25RB	1712.5	19975	13.38	14.9	0-2	
			1732.5	20175	13.52	14.9	0-2	
			1752.5	20375	13.38	14.9	0-2	

Unless otherwise stated the results shown in this test report refer only to the sample(s) tested and such sample(s) are retained for 90 days only.

除非另有說明，此報告結果僅對測試之樣品負責，同時此樣品僅保留90天。本報告未經本公司書面許可，不可部份複製。

This document is issued by the Company subject to its General Conditions of Service printed overleaf, available on request or accessible at www.sgs.com/terms_and_conditions.htm and for electronic format documents, subject to Terms and Conditions for Electronic Documents at www.sgs.com/terms_e-document.htm. Attention is drawn to the limitation of liability, indemnification and jurisdiction issues defined therein. Any holder of this document is advised that information contained hereon reflects the Company's findings at the time of its intervention only and within the limits of Client's instructions, if any. The Company's sole responsibility is to its Client and this document does not exonerate parties to a transaction from exercising all their rights and obligations under the transaction documents. This document cannot be reproduced except in full, without prior written approval of the Company. Any unauthorized alteration, forgery or falsification of the content or appearance of this document is unlawful and offenders may be prosecuted to the fullest extent of the law.

FDD Band 4								
BW(Mhz)	Modulation	RB Size	RB Offset	Frequency (MHz)	Channel	Conducted power (dBm)	Target Power + Max. Tolerance (dBm)	MPR Allowed per 3GPP(dB)
3	QPSK	1 RB	0	1711.5	19965	16.34	16.9	0
				1732.5	20175	16.35	16.9	0
				1753.5	20385	16.33	16.9	0
			7	1711.5	19965	16.07	16.9	0
				1732.5	20175	16.10	16.9	0
				1753.5	20385	15.98	16.9	0
		14	1711.5	19965	16.07	16.9	0	
			1732.5	20175	16.01	16.9	0	
			1753.5	20385	15.97	16.9	0	
		8 RB	0	1711.5	19965	15.35	15.9	0-1
				1732.5	20175	15.21	15.9	0-1
				1753.5	20385	15.12	15.9	0-1
			4	1711.5	19965	15.17	15.9	0-1
				1732.5	20175	15.24	15.9	0-1
				1753.5	20385	15.08	15.9	0-1
			7	1711.5	19965	15.25	15.9	0-1
				1732.5	20175	15.18	15.9	0-1
				1753.5	20385	15.15	15.9	0-1
		15RB	1711.5	19965	14.63	15.9	0-1	
			1732.5	20175	14.73	15.9	0-1	
			1753.5	20385	14.69	15.9	0-1	
	16-QAM	1 RB	0	1711.5	19965	15.60	15.9	0-1
				1732.5	20175	15.70	15.9	0-1
				1753.5	20385	15.65	15.9	0-1
			7	1711.5	19965	15.47	15.9	0-1
				1732.5	20175	15.39	15.9	0-1
				1753.5	20385	15.27	15.9	0-1
			14	1711.5	19965	15.54	15.9	0-1
				1732.5	20175	15.22	15.9	0-1
				1753.5	20385	15.29	15.9	0-1
		8 RB	0	1711.5	19965	14.16	14.9	0-2
				1732.5	20175	14.28	14.9	0-2
				1753.5	20385	14.25	14.9	0-2
			4	1711.5	19965	14.22	14.9	0-2
				1732.5	20175	14.24	14.9	0-2
				1753.5	20385	14.12	14.9	0-2
			7	1711.5	19965	14.18	14.9	0-2
				1732.5	20175	14.11	14.9	0-2
				1753.5	20385	14.08	14.9	0-2
		15RB	1711.5	19965	13.73	14.9	0-2	
			1732.5	20175	13.79	14.9	0-2	
			1753.5	20385	13.59	14.9	0-2	

Unless otherwise stated the results shown in this test report refer only to the sample(s) tested and such sample(s) are retained for 90 days only.

除非另有說明，此報告結果僅對測試之樣品負責，同時此樣品僅保留90天。本報告未經本公司書面許可，不可部份複製。

This document is issued by the Company subject to its General Conditions of Service printed overleaf, available on request or accessible at www.sgs.com/terms_and_conditions.htm and for electronic format documents, subject to Terms and Conditions for Electronic Documents at www.sgs.com/terms_e-document.htm. Attention is drawn to the limitation of liability, indemnification and jurisdiction issues defined therein. Any holder of this document is advised that information contained hereon reflects the Company's findings at the time of its intervention only and within the limits of Client's instructions, if any. The Company's sole responsibility is to its Client and this document does not exonerate parties to a transaction from exercising all their rights and obligations under the transaction documents. This document cannot be reproduced except in full, without prior written approval of the Company. Any unauthorized alteration, forgery or falsification of the content or appearance of this document is unlawful and offenders may be prosecuted to the fullest extent of the law.

FDD Band 4								
BW(Mhz)	Modulation	RB Size	RB Offset	Frequency (MHz)	Channel	Conducted power (dBm)	Target Power + Max. Tolerance (dBm)	MPR Allowed per 3GPP(dB)
3	64-QAM	1 RB	0	1711.5	19965	15.49	15.9	0-1
				1732.5	20175	15.49	15.9	0-1
				1753.5	20385	15.34	15.9	0-1
			7	1711.5	19965	15.20	15.9	0-1
				1732.5	20175	15.31	15.9	0-1
				1753.5	20385	15.16	15.9	0-1
			14	1711.5	19965	15.22	15.9	0-1
				1732.5	20175	15.07	15.9	0-1
				1753.5	20385	15.02	15.9	0-1
		8 RB	0	1711.5	19965	13.98	14.9	0-2
				1732.5	20175	13.97	14.9	0-2
				1753.5	20385	14.03	14.9	0-2
			4	1711.5	19965	13.88	14.9	0-2
				1732.5	20175	14.07	14.9	0-2
				1753.5	20385	13.91	14.9	0-2
			7	1711.5	19965	14.02	14.9	0-2
				1732.5	20175	13.91	14.9	0-2
				1753.5	20385	13.87	14.9	0-2
		15RB	1711.5	19965	13.38	14.9	0-2	
			1732.5	20175	13.49	14.9	0-2	
			1753.5	20385	13.37	14.9	0-2	

Unless otherwise stated the results shown in this test report refer only to the sample(s) tested and such sample(s) are retained for 90 days only.

除非另有說明，此報告結果僅對測試之樣品負責，同時此樣品僅保留90天。本報告未經本公司書面許可，不可部份複製。

This document is issued by the Company subject to its General Conditions of Service printed overleaf, available on request or accessible at www.sgs.com/terms_and_conditions.htm and for electronic format documents, subject to Terms and Conditions for Electronic Documents at www.sgs.com/terms_e-document.htm. Attention is drawn to the limitation of liability, indemnification and jurisdiction issues defined therein. Any holder of this document is advised that information contained hereon reflects the Company's findings at the time of its intervention only and within the limits of Client's instructions, if any. The Company's sole responsibility is to its Client and this document does not exonerate parties to a transaction from exercising all their rights and obligations under the transaction documents. This document cannot be reproduced except in full, without prior written approval of the Company. Any unauthorized alteration, forgery or falsification of the content or appearance of this document is unlawful and offenders may be prosecuted to the fullest extent of the law.

FDD Band 4									
BW(Mhz)	Modulation	RB Size	RB Offset	Frequency (MHz)	Channel	Conducted power (dBm)	Target Power + Max. Tolerance (dBm)	MPR Allowed per 3GPP(dB)	
1.4	QPSK	1 RB	0	1710.7	19957	16.22	16.9	0	
				1732.5	20175	16.31	16.9	0	
				1754.3	20393	16.33	16.9	0	
			2	1710.7	19957	16.08	16.9	0	
				1732.5	20175	16.10	16.9	0	
				1754.3	20393	15.97	16.9	0	
			5	1710.7	19957	16.18	16.9	0	
				1732.5	20175	16.06	16.9	0	
				1754.3	20393	15.98	16.9	0	
		3 RB	0	1710.7	19957	15.29	15.9	0-1	
				1732.5	20175	15.31	15.9	0-1	
				1754.3	20393	15.11	15.9	0-1	
			2	1710.7	19957	15.11	15.9	0-1	
				1732.5	20175	15.12	15.9	0-1	
				1754.3	20393	15.16	15.9	0-1	
			3	1710.7	19957	15.11	15.9	0-1	
				1732.5	20175	15.16	15.9	0-1	
				1754.3	20393	15.08	15.9	0-1	
		6RB	1710.7	19957	14.60	15.9	0-1		
			1732.5	20175	14.71	15.9	0-1		
			1754.3	20393	14.68	15.9	0-1		
		16-QAM	1 RB	0	1710.7	19957	15.72	15.9	0-1
					1732.5	20175	15.81	15.9	0-1
					1754.3	20393	15.60	15.9	0-1
	2			1710.7	19957	15.36	15.9	0-1	
				1732.5	20175	15.44	15.9	0-1	
				1754.3	20393	15.46	15.9	0-1	
	5			1710.7	19957	15.39	15.9	0-1	
				1732.5	20175	15.39	15.9	0-1	
				1754.3	20393	15.19	15.9	0-1	
	3 RB			0	1710.7	19957	14.26	14.9	0-2
					1732.5	20175	14.34	14.9	0-2
					1754.3	20393	14.12	14.9	0-2
			2	1710.7	19957	14.12	14.9	0-2	
				1732.5	20175	14.22	14.9	0-2	
				1754.3	20393	14.05	14.9	0-2	
			3	1710.7	19957	14.24	14.9	0-2	
				1732.5	20175	14.05	14.9	0-2	
				1754.3	20393	14.01	14.9	0-2	
	6RB		1710.7	19957	13.58	14.9	0-2		
			1732.5	20175	13.77	14.9	0-2		
			1754.3	20393	13.57	14.9	0-2		

Unless otherwise stated the results shown in this test report refer only to the sample(s) tested and such sample(s) are retained for 90 days only.

除非另有說明，此報告結果僅對測試之樣品負責，同時此樣品僅保留90天。本報告未經本公司書面許可，不可部份複製。

This document is issued by the Company subject to its General Conditions of Service printed overleaf, available on request or accessible at www.sgs.com/terms_and_conditions.htm and for electronic format documents, subject to Terms and Conditions for Electronic Documents at www.sgs.com/terms_e-document.htm. Attention is drawn to the limitation of liability, indemnification and jurisdiction issues defined therein. Any holder of this document is advised that information contained hereon reflects the Company's findings at the time of its intervention only and within the limits of Client's instructions, if any. The Company's sole responsibility is to its Client and this document does not exonerate parties to a transaction from exercising all their rights and obligations under the transaction documents. This document cannot be reproduced except in full, without prior written approval of the Company. Any unauthorized alteration, forgery or falsification of the content or appearance of this document is unlawful and offenders may be prosecuted to the fullest extent of the law.

FDD Band 4								
BW(Mhz)	Modulation	RB Size	RB Offset	Frequency (MHz)	Channel	Conducted power (dBm)	Target Power + Max. Tolerance (dBm)	MPR Allowed per 3GPP(dB)
1.4	64-QAM	1 RB	0	1710.7	19957	15.45	15.9	0-1
				1732.5	20175	15.51	15.9	0-1
				1754.3	20393	15.44	15.9	0-1
			2	1710.7	19957	15.24	15.9	0-1
				1732.5	20175	15.19	15.9	0-1
				1754.3	20393	15.06	15.9	0-1
			5	1710.7	19957	15.33	15.9	0-1
				1732.5	20175	15.06	15.9	0-1
				1754.3	20393	15.05	15.9	0-1
		3 RB	0	1710.7	19957	13.99	14.9	0-2
				1732.5	20175	13.98	14.9	0-2
				1754.3	20393	13.97	14.9	0-2
			2	1710.7	19957	13.90	14.9	0-2
				1732.5	20175	13.95	14.9	0-2
				1754.3	20393	13.85	14.9	0-2
			3	1710.7	19957	13.94	14.9	0-2
				1732.5	20175	13.99	14.9	0-2
				1754.3	20393	13.77	14.9	0-2
		6RB	1710.7	19957	13.38	14.9	0-2	
			1732.5	20175	13.42	14.9	0-2	
			1754.3	20393	13.49	14.9	0-2	

Unless otherwise stated the results shown in this test report refer only to the sample(s) tested and such sample(s) are retained for 90 days only.

除非另有說明，此報告結果僅對測試之樣品負責，同時此樣品僅保留90天。本報告未經本公司書面許可，不可部份複製。

This document is issued by the Company subject to its General Conditions of Service printed overleaf, available on request or accessible at www.sgs.com/terms_and_conditions.htm and for electronic format documents, subject to Terms and Conditions for Electronic Documents at www.sgs.com/terms_e-document.htm. Attention is drawn to the limitation of liability, indemnification and jurisdiction issues defined therein. Any holder of this document is advised that information contained hereon reflects the Company's findings at the time of its intervention only and within the limits of Client's instructions, if any. The Company's sole responsibility is to its Client and this document does not exonerate parties to a transaction from exercising all their rights and obligations under the transaction documents. This document cannot be reproduced except in full, without prior written approval of the Company. Any unauthorized alteration, forgery or falsification of the content or appearance of this document is unlawful and offenders may be prosecuted to the fullest extent of the law.

FDD Band 5									
BW(Mhz)	Modulation	RB Size	RB Offset	Frequency (MHz)	Channel	Conducted power (dBm)	Target Power + Max. Tolerance (dBm)	MPR Allowed per 3GPP(dB)	
10	QPSK	1 RB	0	829	20450	19.68	20	0	
				836.5	20525	19.65	20	0	
				844	20600	19.60	20	0	
			25	829	20450	19.58	20	0	
				836.5	20525	19.57	20	0	
				844	20600	19.60	20	0	
			49	829	20450	19.62	20	0	
				836.5	20525	19.51	20	0	
				844	20600	19.48	20	0	
		25 RB	0	829	20450	18.66	19	0-1	
				836.5	20525	18.71	19	0-1	
				844	20600	18.67	19	0-1	
			12	829	20450	18.65	19	0-1	
				836.5	20525	18.73	19	0-1	
				844	20600	18.64	19	0-1	
			25	829	20450	18.74	19	0-1	
				836.5	20525	18.59	19	0-1	
				844	20600	18.61	19	0-1	
		50RB	829	20450	18.63	19	0-1		
			836.5	20525	18.69	19	0-1		
			844	20600	18.63	19	0-1		
		16-QAM	1 RB	0	829	20450	18.94	19	0-1
					836.5	20525	18.95	19	0-1
					844	20600	18.80	19	0-1
	25			829	20450	18.89	19	0-1	
				836.5	20525	18.82	19	0-1	
				844	20600	18.84	19	0-1	
	49			829	20450	18.91	19	0-1	
				836.5	20525	18.77	19	0-1	
				844	20600	18.75	19	0-1	
	25 RB			0	829	20450	17.65	18	0-2
					836.5	20525	17.69	18	0-2
					844	20600	17.65	18	0-2
			12	829	20450	17.66	18	0-2	
				836.5	20525	17.70	18	0-2	
				844	20600	17.65	18	0-2	
			25	829	20450	17.73	18	0-2	
				836.5	20525	17.61	18	0-2	
				844	20600	17.60	18	0-2	
	500RB		829	20450	17.66	18	0-2		
			836.5	20525	17.66	18	0-2		
			844	20600	17.64	18	0-2		

Unless otherwise stated the results shown in this test report refer only to the sample(s) tested and such sample(s) are retained for 90 days only.

除非另有說明，此報告結果僅對測試之樣品負責，同時此樣品僅保留90天。本報告未經本公司書面許可，不可部份複製。

This document is issued by the Company subject to its General Conditions of Service printed overleaf, available on request or accessible at www.sgs.com/terms_and_conditions.htm and for electronic format documents, subject to Terms and Conditions for Electronic Documents at www.sgs.com/terms_e-document.htm. Attention is drawn to the limitation of liability, indemnification and jurisdiction issues defined therein. Any holder of this document is advised that information contained hereon reflects the Company's findings at the time of its intervention only and within the limits of Client's instructions, if any. The Company's sole responsibility is to its Client and this document does not exonerate parties to a transaction from exercising all their rights and obligations under the transaction documents. This document cannot be reproduced except in full, without prior written approval of the Company. Any unauthorized alteration, forgery or falsification of the content or appearance of this document is unlawful and offenders may be prosecuted to the fullest extent of the law.

FDD Band 5								
BW(MHz)	Modulation	RB Size	RB Offset	Frequency (MHz)	Channel	Conducted power (dBm)	Target Power + Max. Tolerance (dBm)	MPR Allowed per 3GPP(dB)
10	64-QAM	1 RB	0	829	20450	18.82	19	0-1
				836.5	20525	18.83	19	0-1
				844	20600	18.68	19	0-1
			25	829	20450	18.79	19	0-1
				836.5	20525	18.70	19	0-1
				844	20600	18.72	19	0-1
			49	829	20450	18.79	19	0-1
				836.5	20525	18.65	19	0-1
				844	20600	18.63	19	0-1
		25 RB	0	829	20450	17.53	18	0-2
				836.5	20525	17.57	18	0-2
				844	20600	17.53	18	0-2
			12	829	20450	17.54	18	0-2
				836.5	20525	17.58	18	0-2
				844	20600	17.53	18	0-2
			25	829	20450	17.61	18	0-2
				836.5	20525	17.49	18	0-2
				844	20600	17.48	18	0-2
			500RB	829	20450	17.54	18	0-2
				836.5	20525	17.54	18	0-2
				844	20600	17.52	18	0-2

Unless otherwise stated the results shown in this test report refer only to the sample(s) tested and such sample(s) are retained for 90 days only.

除非另有說明，此報告結果僅對測試之樣品負責，同時此樣品僅保留90天。本報告未經本公司書面許可，不可部份複製。

This document is issued by the Company subject to its General Conditions of Service printed overleaf, available on request or accessible at www.sgs.com/terms_and_conditions.htm and for electronic format documents, subject to Terms and Conditions for Electronic Documents at www.sgs.com/terms_e-document.htm. Attention is drawn to the limitation of liability, indemnification and jurisdiction issues defined therein. Any holder of this document is advised that information contained hereon reflects the Company's findings at the time of its intervention only and within the limits of Client's instructions, if any. The Company's sole responsibility is to its Client and this document does not exonerate parties to a transaction from exercising all their rights and obligations under the transaction documents. This document cannot be reproduced except in full, without prior written approval of the Company. Any unauthorized alteration, forgery or falsification of the content or appearance of this document is unlawful and offenders may be prosecuted to the fullest extent of the law.

FDD Band 5									
BW(Mhz)	Modulation	RB Size	RB Offset	Frequency (MHz)	Channel	Conducted power (dBm)	Target Power + Max. Tolerance (dBm)	MPR Allowed per 3GPP(dB)	
5	QPSK	1 RB	0	826.5	20425	19.59	20	0	
				836.5	20525	19.54	20	0	
				846.5	20625	19.51	20	0	
			12	826.5	20425	19.53	20	0	
				836.5	20525	19.55	20	0	
				846.5	20625	19.45	20	0	
		24	826.5	20425	19.52	20	0		
			836.5	20525	19.49	20	0		
			846.5	20625	19.43	20	0		
		12 RB	0	826.5	20425	18.62	19	0-1	
				836.5	20525	18.61	19	0-1	
				846.5	20625	18.56	19	0-1	
			6	826.5	20425	18.63	19	0-1	
				836.5	20525	18.59	19	0-1	
				846.5	20625	18.53	19	0-1	
			13	826.5	20425	18.58	19	0-1	
				836.5	20525	18.59	19	0-1	
				846.5	20625	18.51	19	0-1	
		25RB	826.5	20425	18.66	19	0-1		
			836.5	20525	18.62	19	0-1		
			846.5	20625	18.54	19	0-1		
		16-QAM	1 RB	0	826.5	20425	18.88	19	0-1
					836.5	20525	18.87	19	0-1
					846.5	20625	18.82	19	0-1
	12			826.5	20425	18.86	19	0-1	
				836.5	20525	18.71	19	0-1	
				846.5	20625	18.77	19	0-1	
	24			826.5	20425	18.85	19	0-1	
				836.5	20525	18.73	19	0-1	
				846.5	20625	18.71	19	0-1	
	12 RB			0	826.5	20425	17.64	18	0-2
					836.5	20525	17.62	18	0-2
					846.5	20625	17.58	18	0-2
			6	826.5	20425	17.64	18	0-2	
				836.5	20525	17.60	18	0-2	
				846.5	20625	17.54	18	0-2	
			13	826.5	20425	17.63	18	0-2	
				836.5	20525	17.60	18	0-2	
				846.5	20625	17.52	18	0-2	
	25RB		826.5	20425	17.63	18	0-2		
			836.5	20525	17.58	18	0-2		
			846.5	20625	17.54	18	0-2		

Unless otherwise stated the results shown in this test report refer only to the sample(s) tested and such sample(s) are retained for 90 days only.

除非另有說明，此報告結果僅對測試之樣品負責，同時此樣品僅保留90天。本報告未經本公司書面許可，不可部份複製。

This document is issued by the Company subject to its General Conditions of Service printed overleaf, available on request or accessible at www.sgs.com/terms_and_conditions.htm and for electronic format documents, subject to Terms and Conditions for Electronic Documents at www.sgs.com/terms_e-document.htm. Attention is drawn to the limitation of liability, indemnification and jurisdiction issues defined therein. Any holder of this document is advised that information contained hereon reflects the Company's findings at the time of its intervention only and within the limits of Client's instructions, if any. The Company's sole responsibility is to its Client and this document does not exonerate parties to a transaction from exercising all their rights and obligations under the transaction documents. This document cannot be reproduced except in full, without prior written approval of the Company. Any unauthorized alteration, forgery or falsification of the content or appearance of this document is unlawful and offenders may be prosecuted to the fullest extent of the law.

FDD Band 5								
BW(MHz)	Modulation	RB Size	RB Offset	Frequency (MHz)	Channel	Conducted power (dBm)	Target Power + Max. Tolerance (dBm)	MPR Allowed per 3GPP(dB)
5	64-QAM	1 RB	0	826.5	20425	18.77	19	0-1
				836.5	20525	18.76	19	0-1
				846.5	20625	18.71	19	0-1
			12	826.5	20425	18.75	19	0-1
				836.5	20525	18.65	19	0-1
				846.5	20625	18.66	19	0-1
			24	826.5	20425	18.74	19	0-1
				836.5	20525	18.62	19	0-1
				846.5	20625	18.60	19	0-1
		12 RB	0	826.5	20425	17.53	18	0-2
				836.5	20525	17.51	18	0-2
				846.5	20625	17.47	18	0-2
			6	826.5	20425	17.53	18	0-2
				836.5	20525	17.49	18	0-2
				846.5	20625	17.43	18	0-2
			13	826.5	20425	17.52	18	0-2
				836.5	20525	17.49	18	0-2
				846.5	20625	17.41	18	0-2
			25RB	826.5	20425	17.52	18	0-2
				836.5	20525	17.47	18	0-2
				846.5	20625	17.43	18	0-2

Unless otherwise stated the results shown in this test report refer only to the sample(s) tested and such sample(s) are retained for 90 days only.

除非另有說明，此報告結果僅對測試之樣品負責，同時此樣品僅保留90天。本報告未經本公司書面許可，不可部份複製。

This document is issued by the Company subject to its General Conditions of Service printed overleaf, available on request or accessible at www.sgs.com/terms_and_conditions.htm and for electronic format documents, subject to Terms and Conditions for Electronic Documents at www.sgs.com/terms_e-document.htm. Attention is drawn to the limitation of liability, indemnification and jurisdiction issues defined therein. Any holder of this document is advised that information contained hereon reflects the Company's findings at the time of its intervention only and within the limits of Client's instructions, if any. The Company's sole responsibility is to its Client and this document does not exonerate parties to a transaction from exercising all their rights and obligations under the transaction documents. This document cannot be reproduced except in full, without prior written approval of the Company. Any unauthorized alteration, forgery or falsification of the content or appearance of this document is unlawful and offenders may be prosecuted to the fullest extent of the law.

FDD Band 5								
BW(Mhz)	Modulation	RB Size	RB Offset	Frequency (MHz)	Channel	Conducted power (dBm)	Target Power + Max. Tolerance (dBm)	MPR Allowed per 3GPP(dB)
3	QPSK	1 RB	0	825.5	20415	19.51	20	0
				836.5	20525	19.46	20	0
				847.5	20635	19.39	20	0
			7	825.5	20415	19.56	20	0
				836.5	20525	19.55	20	0
				847.5	20635	19.48	20	0
		14	825.5	20415	19.45	20	0	
			836.5	20525	19.39	20	0	
			847.5	20635	19.37	20	0	
		8 RB	0	825.5	20415	18.56	19	0-1
				836.5	20525	18.50	19	0-1
				847.5	20635	18.44	19	0-1
			4	825.5	20415	18.57	19	0-1
				836.5	20525	18.56	19	0-1
				847.5	20635	18.48	19	0-1
			7	825.5	20415	18.55	19	0-1
				836.5	20525	18.51	19	0-1
				847.5	20635	18.42	19	0-1
		15RB	825.5	20415	18.52	19	0-1	
			836.5	20525	18.54	19	0-1	
			847.5	20635	18.44	19	0-1	
	16-QAM	1 RB	0	825.5	20415	18.76	19	0-1
				836.5	20525	18.78	19	0-1
				847.5	20635	18.67	19	0-1
			7	825.5	20415	18.90	19	0-1
				836.5	20525	18.81	19	0-1
				847.5	20635	18.78	19	0-1
			14	825.5	20415	18.73	19	0-1
				836.5	20525	18.66	19	0-1
				847.5	20635	18.60	19	0-1
		8 RB	0	825.5	20415	17.61	18	0-2
				836.5	20525	17.55	18	0-2
				847.5	20635	17.49	18	0-2
			4	825.5	20415	17.61	18	0-2
				836.5	20525	17.61	18	0-2
				847.5	20635	17.49	18	0-2
			7	825.5	20415	17.60	18	0-2
				836.5	20525	17.58	18	0-2
				847.5	20635	17.48	18	0-2
		15RB	825.5	20415	17.55	18	0-2	
			836.5	20525	17.54	18	0-2	
			847.5	20635	17.44	18	0-2	

Unless otherwise stated the results shown in this test report refer only to the sample(s) tested and such sample(s) are retained for 90 days only.

除非另有說明，此報告結果僅對測試之樣品負責，同時此樣品僅保留90天。本報告未經本公司書面許可，不可部份複製。

This document is issued by the Company subject to its General Conditions of Service printed overleaf, available on request or accessible at www.sgs.com/terms_and_conditions.htm and for electronic format documents, subject to Terms and Conditions for Electronic Documents at www.sgs.com/terms_e-document.htm. Attention is drawn to the limitation of liability, indemnification and jurisdiction issues defined therein. Any holder of this document is advised that information contained hereon reflects the Company's findings at the time of its intervention only and within the limits of Client's instructions, if any. The Company's sole responsibility is to its Client and this document does not exonerate parties to a transaction from exercising all their rights and obligations under the transaction documents. This document cannot be reproduced except in full, without prior written approval of the Company. Any unauthorized alteration, forgery or falsification of the content or appearance of this document is unlawful and offenders may be prosecuted to the fullest extent of the law.

FDD Band 5								
BW(MHz)	Modulation	RB Size	RB Offset	Frequency (MHz)	Channel	Conducted power (dBm)	Target Power + Max. Tolerance (dBm)	MPR Allowed per 3GPP(dB)
3	64-QAM	1 RB	0	825.5	20415	18.63	19	0-1
				836.5	20525	18.65	19	0-1
				847.5	20635	18.54	19	0-1
			7	825.5	20415	18.77	19	0-1
				836.5	20525	18.68	19	0-1
				847.5	20635	18.65	19	0-1
			14	825.5	20415	18.60	19	0-1
				836.5	20525	18.53	19	0-1
				847.5	20635	18.47	19	0-1
		8 RB	0	825.5	20415	17.48	18	0-2
				836.5	20525	17.42	18	0-2
				847.5	20635	17.36	18	0-2
			4	825.5	20415	17.46	18	0-2
				836.5	20525	17.48	18	0-2
				847.5	20635	17.36	18	0-2
			7	825.5	20415	17.47	18	0-2
				836.5	20525	17.45	18	0-2
				847.5	20635	17.35	18	0-2
		15RB	825.5	20415	17.42	18	0-2	
			836.5	20525	17.41	18	0-2	
			847.5	20635	17.31	18	0-2	

Unless otherwise stated the results shown in this test report refer only to the sample(s) tested and such sample(s) are retained for 90 days only.

除非另有說明，此報告結果僅對測試之樣品負責，同時此樣品僅保留90天。本報告未經本公司書面許可，不可部份複製。

This document is issued by the Company subject to its General Conditions of Service printed overleaf, available on request or accessible at www.sgs.com/terms_and_conditions.htm and for electronic format documents, subject to Terms and Conditions for Electronic Documents at www.sgs.com/terms_e-document.htm. Attention is drawn to the limitation of liability, indemnification and jurisdiction issues defined therein. Any holder of this document is advised that information contained hereon reflects the Company's findings at the time of its intervention only and within the limits of Client's instructions, if any. The Company's sole responsibility is to its Client and this document does not exonerate parties to a transaction from exercising all their rights and obligations under the transaction documents. This document cannot be reproduced except in full, without prior written approval of the Company. Any unauthorized alteration, forgery or falsification of the content or appearance of this document is unlawful and offenders may be prosecuted to the fullest extent of the law.

FDD Band 5									
BW(Mhz)	Modulation	RB Size	RB Offset	Frequency (MHz)	Channel	Conducted power (dBm)	Target Power + Max. Tolerance (dBm)	MPR Allowed per 3GPP(dB)	
1.4	QPSK	1 RB	0	824.7	20407	19.40	20	0	
				836.5	20525	19.37	20	0	
				848.3	20643	19.28	20	0	
			2	824.7	20407	19.49	20	0	
				836.5	20525	19.46	20	0	
				848.3	20643	19.37	20	0	
		5	824.7	20407	19.41	20	0		
			836.5	20525	19.38	20	0		
			848.3	20643	19.28	20	0		
		3 RB	0	824.7	20407	18.48	19	0-1	
				836.5	20525	18.40	19	0-1	
				848.3	20643	18.34	19	0-1	
			2	824.7	20407	18.53	19	0-1	
				836.5	20525	18.46	19	0-1	
				848.3	20643	18.43	19	0-1	
			3	824.7	20407	18.47	19	0-1	
				836.5	20525	18.42	19	0-1	
				848.3	20643	18.36	19	0-1	
		6RB	824.7	20407	18.48	19	0-1		
			836.5	20525	18.42	19	0-1		
			848.3	20643	18.36	19	0-1		
		16-QAM	1 RB	0	824.7	20407	18.69	19	0-1
					836.5	20525	18.65	19	0-1
					848.3	20643	18.57	19	0-1
	2			824.7	20407	18.76	19	0-1	
				836.5	20525	18.78	19	0-1	
				848.3	20643	18.60	19	0-1	
	5			824.7	20407	18.67	19	0-1	
				836.5	20525	18.69	19	0-1	
				848.3	20643	18.53	19	0-1	
	3 RB			0	824.7	20407	17.51	18	0-2
					836.5	20525	17.54	18	0-2
					848.3	20643	17.37	18	0-2
			2	824.7	20407	17.53	18	0-2	
				836.5	20525	17.57	18	0-2	
				848.3	20643	17.40	18	0-2	
			3	824.7	20407	17.53	18	0-2	
				836.5	20525	17.43	18	0-2	
				848.3	20643	17.34	18	0-2	
	6RB		824.7	20407	17.54	18	0-2		
			836.5	20525	17.51	18	0-2		
			848.3	20643	17.42	18	0-2		

Unless otherwise stated the results shown in this test report refer only to the sample(s) tested and such sample(s) are retained for 90 days only.

除非另有說明，此報告結果僅對測試之樣品負責，同時此樣品僅保留90天。本報告未經本公司書面許可，不可部份複製。

This document is issued by the Company subject to its General Conditions of Service printed overleaf, available on request or accessible at www.sgs.com/terms_and_conditions.htm and for electronic format documents, subject to Terms and Conditions for Electronic Documents at www.sgs.com/terms_e-document.htm. Attention is drawn to the limitation of liability, indemnification and jurisdiction issues defined therein. Any holder of this document is advised that information contained hereon reflects the Company's findings at the time of its intervention only and within the limits of Client's instructions, if any. The Company's sole responsibility is to its Client and this document does not exonerate parties to a transaction from exercising all their rights and obligations under the transaction documents. This document cannot be reproduced except in full, without prior written approval of the Company. Any unauthorized alteration, forgery or falsification of the content or appearance of this document is unlawful and offenders may be prosecuted to the fullest extent of the law.

FDD Band 5								
BW(MHz)	Modulation	RB Size	RB Offset	Frequency (MHz)	Channel	Conducted power (dBm)	Target Power + Max. Tolerance (dBm)	MPR Allowed per 3GPP(dB)
1.4	64-QAM	1 RB	0	824.7	20407	18.57	19	0-1
				836.5	20525	18.53	19	0-1
				848.3	20643	18.45	19	0-1
			2	824.7	20407	18.64	19	0-1
				836.5	20525	18.66	19	0-1
				848.3	20643	18.48	19	0-1
			5	824.7	20407	18.55	19	0-1
				836.5	20525	18.52	19	0-1
				848.3	20643	18.41	19	0-1
		3 RB	0	824.7	20407	17.39	18	0-2
				836.5	20525	17.42	18	0-2
				848.3	20643	17.25	18	0-2
			2	824.7	20407	17.41	18	0-2
				836.5	20525	17.45	18	0-2
				848.3	20643	17.28	18	0-2
			3	824.7	20407	17.41	18	0-2
				836.5	20525	17.31	18	0-2
				848.3	20643	17.22	18	0-2
			6RB	824.7	20407	17.42	18	0-2
				836.5	20525	17.39	18	0-2
				848.3	20643	17.30	18	0-2

Unless otherwise stated the results shown in this test report refer only to the sample(s) tested and such sample(s) are retained for 90 days only.

除非另有說明，此報告結果僅對測試之樣品負責，同時此樣品僅保留90天。本報告未經本公司書面許可，不可部份複製。

This document is issued by the Company subject to its General Conditions of Service printed overleaf, available on request or accessible at www.sgs.com/terms_and_conditions.htm and for electronic format documents, subject to Terms and Conditions for Electronic Documents at www.sgs.com/terms_e-document.htm. Attention is drawn to the limitation of liability, indemnification and jurisdiction issues defined therein. Any holder of this document is advised that information contained hereon reflects the Company's findings at the time of its intervention only and within the limits of Client's instructions, if any. The Company's sole responsibility is to its Client and this document does not exonerate parties to a transaction from exercising all their rights and obligations under the transaction documents. This document cannot be reproduced except in full, without prior written approval of the Company. Any unauthorized alteration, forgery or falsification of the content or appearance of this document is unlawful and offenders may be prosecuted to the fullest extent of the law.

FDD Band 7									
BW(Mhz)	Modulation	RB Size	RB Offset	Frequency (MHz)	Channel	Conducted power (dBm)	Target Power + Max. Tolerance (dBm)	MPR Allowed per 3GPP(dB)	
20	QPSK	1 RB	0	2510	20850	14.48	15	0	
				2535	21100	14.51	15	0	
				2560	21350	14.54	15	0	
			50	2510	20850	14.40	15	0	
				2535	21100	14.35	15	0	
				2560	21350	14.49	15	0	
		99	2510	20850	14.50	15	0		
			2535	21100	14.52	15	0		
			2560	21350	14.38	15	0		
		50 RB	0	2510	20850	13.52	14	0-1	
				2535	21100	13.56	14	0-1	
				2560	21350	13.54	14	0-1	
			25	2510	20850	13.48	14	0-1	
				2535	21100	13.55	14	0-1	
				2560	21350	13.62	14	0-1	
			50	2510	20850	13.47	14	0-1	
				2535	21100	13.57	14	0-1	
				2560	21350	13.56	14	0-1	
			100RB	2510	20850	13.42	14	0-1	
				2535	21100	13.56	14	0-1	
				2560	21350	13.60	14	0-1	
		16-QAM	1 RB	0	2510	20850	13.70	14	0-1
					2535	21100	13.54	14	0-1
					2560	21350	13.77	14	0-1
	50			2510	20850	13.67	14	0-1	
				2535	21100	13.81	14	0-1	
				2560	21350	13.92	14	0-1	
	99			2510	20850	13.88	14	0-1	
				2535	21100	13.81	14	0-1	
				2560	21350	13.55	14	0-1	
	50 RB			0	2510	20850	12.57	13	0-2
					2535	21100	12.56	13	0-2
					2560	21350	12.61	13	0-2
			25	2510	20850	12.53	13	0-2	
				2535	21100	12.63	13	0-2	
				2560	21350	12.67	13	0-2	
			50	2510	20850	12.47	13	0-2	
				2535	21100	12.54	13	0-2	
				2560	21350	12.56	13	0-2	
			100RB	2510	20850	12.54	13	0-2	
				2535	21100	12.58	13	0-2	
				2560	21350	12.60	13	0-2	

Unless otherwise stated the results shown in this test report refer only to the sample(s) tested and such sample(s) are retained for 90 days only.

除非另有說明，此報告結果僅對測試之樣品負責，同時此樣品僅保留90天。本報告未經本公司書面許可，不可部份複製。

This document is issued by the Company subject to its General Conditions of Service printed overleaf, available on request or accessible at www.sgs.com/terms_and_conditions.htm and for electronic format documents, subject to Terms and Conditions for Electronic Documents at www.sgs.com/terms_e-document.htm. Attention is drawn to the limitation of liability, indemnification and jurisdiction issues defined therein. Any holder of this document is advised that information contained hereon reflects the Company's findings at the time of its intervention only and within the limits of Client's instructions, if any. The Company's sole responsibility is to its Client and this document does not exonerate parties to a transaction from exercising all their rights and obligations under the transaction documents. This document cannot be reproduced except in full, without prior written approval of the Company. Any unauthorized alteration, forgery or falsification of the content or appearance of this document is unlawful and offenders may be prosecuted to the fullest extent of the law.

FDD Band 7								
BW(Mhz)	Modulation	RB Size	RB Offset	Frequency (MHz)	Channel	Conducted power (dBm)	Target Power + Max. Tolerance (dBm)	MPR Allowed per 3GPP(dB)
20	64-QAM	1 RB	0	2510	20850	13.48	14	0-1
				2535	21100	13.32	14	0-1
				2560	21350	13.55	14	0-1
			50	2510	20850	13.45	14	0-1
				2535	21100	13.59	14	0-1
				2560	21350	13.70	14	0-1
			99	2510	20850	13.66	14	0-1
				2535	21100	13.59	14	0-1
				2560	21350	13.33	14	0-1
		50 RB	0	2510	20850	12.35	13	0-2
				2535	21100	12.34	13	0-2
				2560	21350	12.39	13	0-2
			25	2510	20850	12.31	13	0-2
				2535	21100	12.41	13	0-2
				2560	21350	12.45	13	0-2
			50	2510	20850	12.25	13	0-2
				2535	21100	12.32	13	0-2
				2560	21350	12.34	13	0-2
			100RB	2510	20850	12.32	13	0-2
				2535	21100	12.36	13	0-2
				2560	21350	12.38	13	0-2

Unless otherwise stated the results shown in this test report refer only to the sample(s) tested and such sample(s) are retained for 90 days only.

除非另有說明，此報告結果僅對測試之樣品負責，同時此樣品僅保留90天。本報告未經本公司書面許可，不可部份複製。

This document is issued by the Company subject to its General Conditions of Service printed overleaf, available on request or accessible at www.sgs.com/terms_and_conditions.htm and for electronic format documents, subject to Terms and Conditions for Electronic Documents at www.sgs.com/terms_e-document.htm. Attention is drawn to the limitation of liability, indemnification and jurisdiction issues defined therein. Any holder of this document is advised that information contained hereon reflects the Company's findings at the time of its intervention only and within the limits of Client's instructions, if any. The Company's sole responsibility is to its Client and this document does not exonerate parties to a transaction from exercising all their rights and obligations under the transaction documents. This document cannot be reproduced except in full, without prior written approval of the Company. Any unauthorized alteration, forgery or falsification of the content or appearance of this document is unlawful and offenders may be prosecuted to the fullest extent of the law.

FDD Band 7									
BW(Mhz)	Modulation	RB Size	RB Offset	Frequency (MHz)	Channel	Conducted power (dBm)	Target Power + Max. Tolerance (dBm)	MPR Allowed per 3GPP(dB)	
15	QPSK	1 RB	0	2507.5	20825	14.51	15	0	
				2535	21100	14.50	15	0	
				2562.5	21375	14.52	15	0	
			36	2507.5	20825	14.43	15	0	
				2535	21100	14.44	15	0	
				2562.5	21375	14.49	15	0	
		74	2507.5	20825	14.48	15	0		
			2535	21100	14.42	15	0		
			2562.5	21375	14.51	15	0		
		36 RB	0	2507.5	20825	13.52	14	0-1	
				2535	21100	13.60	14	0-1	
				2562.5	21375	13.61	14	0-1	
			18	2507.5	20825	13.52	14	0-1	
				2535	21100	13.62	14	0-1	
				2562.5	21375	13.60	14	0-1	
			37	2507.5	20825	13.48	14	0-1	
				2535	21100	13.55	14	0-1	
				2562.5	21375	13.54	14	0-1	
			75RB	2507.5	20825	13.50	14	0-1	
				2535	21100	13.56	14	0-1	
				2562.5	21375	13.58	14	0-1	
		16-QAM	1 RB	0	2507.5	20825	13.79	14	0-1
					2535	21100	13.80	14	0-1
					2562.5	21375	13.74	14	0-1
	36			2507.5	20825	13.70	14	0-1	
				2535	21100	13.74	14	0-1	
				2562.5	21375	13.77	14	0-1	
	74			2507.5	20825	13.70	14	0-1	
				2535	21100	13.68	14	0-1	
				2562.5	21375	13.75	14	0-1	
	36 RB			0	2507.5	20825	12.54	13	0-2
					2535	21100	12.62	13	0-2
					2562.5	21375	12.64	13	0-2
			18	2507.5	20825	12.52	13	0-2	
				2535	21100	12.59	13	0-2	
				2562.5	21375	12.63	13	0-2	
			37	2507.5	20825	12.51	13	0-2	
				2535	21100	12.56	13	0-2	
				2562.5	21375	12.58	13	0-2	
			75RB	2507.5	20825	12.52	13	0-2	
				2535	21100	12.58	13	0-2	
				2562.5	21375	12.61	13	0-2	

Unless otherwise stated the results shown in this test report refer only to the sample(s) tested and such sample(s) are retained for 90 days only.

除非另有說明，此報告結果僅對測試之樣品負責，同時此樣品僅保留90天。本報告未經本公司書面許可，不可部份複製。

This document is issued by the Company subject to its General Conditions of Service printed overleaf, available on request or accessible at www.sgs.com/terms_and_conditions.htm and for electronic format documents, subject to Terms and Conditions for Electronic Documents at www.sgs.com/terms_e-document.htm. Attention is drawn to the limitation of liability, indemnification and jurisdiction issues defined therein. Any holder of this document is advised that information contained hereon reflects the Company's findings at the time of its intervention only and within the limits of Client's instructions, if any. The Company's sole responsibility is to its Client and this document does not exonerate parties to a transaction from exercising all their rights and obligations under the transaction documents. This document cannot be reproduced except in full, without prior written approval of the Company. Any unauthorized alteration, forgery or falsification of the content or appearance of this document is unlawful and offenders may be prosecuted to the fullest extent of the law.

FDD Band 7								
BW(MHz)	Modulation	RB Size	RB Offset	Frequency (MHz)	Channel	Conducted power (dBm)	Target Power + Max. Tolerance (dBm)	MPR Allowed per 3GPP(dB)
15	64-QAM	1 RB	0	2507.5	20825	13.54	14	0-1
				2535	21100	13.55	14	0-1
				2562.5	21375	13.49	14	0-1
			36	2507.5	20825	13.45	14	0-1
				2535	21100	13.49	14	0-1
				2562.5	21375	13.52	14	0-1
			74	2507.5	20825	13.45	14	0-1
				2535	21100	13.43	14	0-1
				2562.5	21375	13.50	14	0-1
		36 RB	0	2507.5	20825	12.29	13	0-2
				2535	21100	12.37	13	0-2
				2562.5	21375	12.39	13	0-2
			18	2507.5	20825	12.27	13	0-2
				2535	21100	12.34	13	0-2
				2562.5	21375	12.38	13	0-2
			37	2507.5	20825	12.26	13	0-2
				2535	21100	12.31	13	0-2
				2562.5	21375	12.33	13	0-2
			75RB	2507.5	20825	12.27	13	0-2
				2535	21100	12.33	13	0-2
				2562.5	21375	12.36	13	0-2

Unless otherwise stated the results shown in this test report refer only to the sample(s) tested and such sample(s) are retained for 90 days only.

除非另有說明，此報告結果僅對測試之樣品負責，同時此樣品僅保留90天。本報告未經本公司書面許可，不可部份複製。

This document is issued by the Company subject to its General Conditions of Service printed overleaf, available on request or accessible at www.sgs.com/terms_and_conditions.htm and for electronic format documents, subject to Terms and Conditions for Electronic Documents at www.sgs.com/terms_e-document.htm. Attention is drawn to the limitation of liability, indemnification and jurisdiction issues defined therein. Any holder of this document is advised that information contained hereon reflects the Company's findings at the time of its intervention only and within the limits of Client's instructions, if any. The Company's sole responsibility is to its Client and this document does not exonerate parties to a transaction from exercising all their rights and obligations under the transaction documents. This document cannot be reproduced except in full, without prior written approval of the Company. Any unauthorized alteration, forgery or falsification of the content or appearance of this document is unlawful and offenders may be prosecuted to the fullest extent of the law.

FDD Band 7									
BW(Mhz)	Modulation	RB Size	RB Offset	Frequency (MHz)	Channel	Conducted power (dBm)	Target Power + Max. Tolerance (dBm)	MPR Allowed per 3GPP(dB)	
10	QPSK	1 RB	0	2505	20800	14.50	15	0	
				2535	21100	14.48	15	0	
				2565	21400	14.51	15	0	
			25	2505	20800	14.44	15	0	
				2535	21100	14.45	15	0	
				2565	21400	14.52	15	0	
			49	2505	20800	14.45	15	0	
				2535	21100	14.41	15	0	
				2565	21400	14.44	15	0	
		25 RB	0	2505	20800	13.48	14	0-1	
				2535	21100	13.57	14	0-1	
				2565	21400	13.59	14	0-1	
			12	2505	20800	13.51	14	0-1	
				2535	21100	13.53	14	0-1	
				2565	21400	13.55	14	0-1	
			25	2505	20800	13.49	14	0-1	
				2535	21100	13.53	14	0-1	
				2565	21400	13.52	14	0-1	
		50RB	2505	20800	13.50	14	0-1		
			2535	21100	13.56	14	0-1		
			2565	21400	13.58	14	0-1		
		16-QAM	1 RB	0	2505	20800	13.74	14	0-1
					2535	21100	13.73	14	0-1
					2565	21400	13.81	14	0-1
	25			2505	20800	13.70	14	0-1	
				2535	21100	13.72	14	0-1	
				2565	21400	13.74	14	0-1	
	49			2505	20800	13.68	14	0-1	
				2535	21100	13.67	14	0-1	
				2565	21400	13.75	14	0-1	
	25 RB			0	2505	20800	12.50	13	0-2
					2535	21100	12.55	13	0-2
					2565	21400	12.59	13	0-2
			12	2505	20800	12.54	13	0-2	
				2535	21100	12.55	13	0-2	
				2565	21400	12.57	13	0-2	
			25	2505	20800	12.47	13	0-2	
				2535	21100	12.53	13	0-2	
				2565	21400	12.53	13	0-2	
	50RB		2505	20800	12.48	13	0-2		
			2535	21100	12.58	13	0-2		
			2565	21400	12.57	13	0-2		

Unless otherwise stated the results shown in this test report refer only to the sample(s) tested and such sample(s) are retained for 90 days only.

除非另有說明，此報告結果僅對測試之樣品負責，同時此樣品僅保留90天。本報告未經本公司書面許可，不可部份複製。

This document is issued by the Company subject to its General Conditions of Service printed overleaf, available on request or accessible at www.sgs.com/terms_and_conditions.htm and for electronic format documents, subject to Terms and Conditions for Electronic Documents at www.sgs.com/terms_e-document.htm. Attention is drawn to the limitation of liability, indemnification and jurisdiction issues defined therein. Any holder of this document is advised that information contained hereon reflects the Company's findings at the time of its intervention only and within the limits of Client's instructions, if any. The Company's sole responsibility is to its Client and this document does not exonerate parties to a transaction from exercising all their rights and obligations under the transaction documents. This document cannot be reproduced except in full, without prior written approval of the Company. Any unauthorized alteration, forgery or falsification of the content or appearance of this document is unlawful and offenders may be prosecuted to the fullest extent of the law.

FDD Band 7								
BW(MHz)	Modulation	RB Size	RB Offset	Frequency (MHz)	Channel	Conducted power (dBm)	Target Power + Max. Tolerance (dBm)	MPR Allowed per 3GPP(dB)
10	64-QAM	1 RB	0	2505	20800	13.55	14	0-1
				2535	21100	13.54	14	0-1
				2565	21400	13.62	14	0-1
			25	2505	20800	13.51	14	0-1
				2535	21100	13.53	14	0-1
				2565	21400	13.55	14	0-1
			49	2505	20800	13.49	14	0-1
				2535	21100	13.48	14	0-1
				2565	21400	13.56	14	0-1
		25 RB	0	2505	20800	12.31	13	0-2
				2535	21100	12.36	13	0-2
				2565	21400	12.40	13	0-2
			12	2505	20800	12.35	13	0-2
				2535	21100	12.36	13	0-2
				2565	21400	12.38	13	0-2
			25	2505	20800	12.28	13	0-2
				2535	21100	12.34	13	0-2
				2565	21400	12.34	13	0-2
			50RB	2505	20800	12.29	13	0-2
				2535	21100	12.39	13	0-2
				2565	21400	12.38	13	0-2

Unless otherwise stated the results shown in this test report refer only to the sample(s) tested and such sample(s) are retained for 90 days only.

除非另有說明，此報告結果僅對測試之樣品負責，同時此樣品僅保留90天。本報告未經本公司書面許可，不可部份複製。

This document is issued by the Company subject to its General Conditions of Service printed overleaf, available on request or accessible at www.sgs.com/terms_and_conditions.htm and for electronic format documents, subject to Terms and Conditions for Electronic Documents at www.sgs.com/terms_e-document.htm. Attention is drawn to the limitation of liability, indemnification and jurisdiction issues defined therein. Any holder of this document is advised that information contained hereon reflects the Company's findings at the time of its intervention only and within the limits of Client's instructions, if any. The Company's sole responsibility is to its Client and this document does not exonerate parties to a transaction from exercising all their rights and obligations under the transaction documents. This document cannot be reproduced except in full, without prior written approval of the Company. Any unauthorized alteration, forgery or falsification of the content or appearance of this document is unlawful and offenders may be prosecuted to the fullest extent of the law.

FDD Band 7									
BW(Mhz)	Modulation	RB Size	RB Offset	Frequency (MHz)	Channel	Conducted power (dBm)	Target Power + Max. Tolerance (dBm)	MPR Allowed per 3GPP(dB)	
5	QPSK	1 RB	0	2502.5	20775	14.46	15	0	
				2535	21100	14.44	15	0	
				2567.5	21425	14.48	15	0	
			12	2502.5	20775	14.45	15	0	
				2535	21100	14.44	15	0	
				2567.5	21425	14.48	15	0	
		24	2502.5	20775	14.42	15	0		
			2535	21100	14.43	15	0		
			2567.5	21425	14.46	15	0		
		12 RB	0	2502.5	20775	13.49	14	0-1	
				2535	21100	13.56	14	0-1	
				2567.5	21425	13.52	14	0-1	
			6	2502.5	20775	13.51	14	0-1	
				2535	21100	13.55	14	0-1	
				2567.5	21425	13.59	14	0-1	
			13	2502.5	20775	13.49	14	0-1	
				2535	21100	13.55	14	0-1	
				2567.5	21425	13.55	14	0-1	
			25RB	2502.5	20775	13.47	14	0-1	
				2535	21100	13.53	14	0-1	
				2567.5	21425	13.54	14	0-1	
		16-QAM	1 RB	0	2502.5	20775	13.74	14	0-1
					2535	21100	13.70	14	0-1
					2567.5	21425	13.73	14	0-1
	12			2502.5	20775	13.70	14	0-1	
				2535	21100	13.71	14	0-1	
				2567.5	21425	13.75	14	0-1	
	24			2502.5	20775	13.69	14	0-1	
				2535	21100	13.68	14	0-1	
				2567.5	21425	13.71	14	0-1	
	12 RB			0	2502.5	20775	12.49	13	0-2
					2535	21100	12.53	13	0-2
					2567.5	21425	12.55	13	0-2
			6	2502.5	20775	12.54	13	0-2	
				2535	21100	12.58	13	0-2	
				2567.5	21425	12.59	13	0-2	
			13	2502.5	20775	12.48	13	0-2	
				2535	21100	12.50	13	0-2	
				2567.5	21425	12.52	13	0-2	
	25RB		2502.5	20775	12.49	13	0-2		
			2535	21100	12.51	13	0-2		
			2567.5	21425	12.56	13	0-2		

Unless otherwise stated the results shown in this test report refer only to the sample(s) tested and such sample(s) are retained for 90 days only.

除非另有說明，此報告結果僅對測試之樣品負責，同時此樣品僅保留90天。本報告未經本公司書面許可，不可部份複製。

This document is issued by the Company subject to its General Conditions of Service printed overleaf, available on request or accessible at www.sgs.com/terms_and_conditions.htm and for electronic format documents, subject to Terms and Conditions for Electronic Documents at www.sgs.com/terms_e-document.htm. Attention is drawn to the limitation of liability, indemnification and jurisdiction issues defined therein. Any holder of this document is advised that information contained hereon reflects the Company's findings at the time of its intervention only and within the limits of Client's instructions, if any. The Company's sole responsibility is to its Client and this document does not exonerate parties to a transaction from exercising all their rights and obligations under the transaction documents. This document cannot be reproduced except in full, without prior written approval of the Company. Any unauthorized alteration, forgery or falsification of the content or appearance of this document is unlawful and offenders may be prosecuted to the fullest extent of the law.

FDD Band 7								
BW(MHz)	Modulation	RB Size	RB Offset	Frequency (MHz)	Channel	Conducted power (dBm)	Target Power + Max. Tolerance (dBm)	MPR Allowed per 3GPP(dB)
5	64-QAM	1 RB	0	2502.5	20775	13.50	14	0-1
				2535	21100	13.46	14	0-1
				2567.5	21425	13.49	14	0-1
			12	2502.5	20775	13.46	14	0-1
				2535	21100	13.47	14	0-1
				2567.5	21425	13.51	14	0-1
			24	2502.5	20775	13.45	14	0-1
				2535	21100	13.44	14	0-1
				2567.5	21425	13.47	14	0-1
		12 RB	0	2502.5	20775	12.25	13	0-2
				2535	21100	12.29	13	0-2
				2567.5	21425	12.31	13	0-2
			6	2502.5	20775	12.30	13	0-2
				2535	21100	12.34	13	0-2
				2567.5	21425	12.35	13	0-2
			13	2502.5	20775	12.24	13	0-2
				2535	21100	12.26	13	0-2
				2567.5	21425	12.28	13	0-2
			25RB	2502.5	20775	12.25	13	0-2
				2535	21100	12.27	13	0-2
				2567.5	21425	12.32	13	0-2

Unless otherwise stated the results shown in this test report refer only to the sample(s) tested and such sample(s) are retained for 90 days only.

除非另有說明，此報告結果僅對測試之樣品負責，同時此樣品僅保留90天。本報告未經本公司書面許可，不可部份複製。

This document is issued by the Company subject to its General Conditions of Service printed overleaf, available on request or accessible at www.sgs.com/terms_and_conditions.htm and for electronic format documents, subject to Terms and Conditions for Electronic Documents at www.sgs.com/terms_e-document.htm. Attention is drawn to the limitation of liability, indemnification and jurisdiction issues defined therein. Any holder of this document is advised that information contained hereon reflects the Company's findings at the time of its intervention only and within the limits of Client's instructions, if any. The Company's sole responsibility is to its Client and this document does not exonerate parties to a transaction from exercising all their rights and obligations under the transaction documents. This document cannot be reproduced except in full, without prior written approval of the Company. Any unauthorized alteration, forgery or falsification of the content or appearance of this document is unlawful and offenders may be prosecuted to the fullest extent of the law.

FDD Band 12									
BW(Mhz)	Modulation	RB Size	RB Offset	Frequency (MHz)	Channel	Conducted power (dBm)	Target Power + Max. Tolerance (dBm)	MPR Allowed per 3GPP(dB)	
10	QPSK	1 RB	0	704	23060	19.48	20	0	
				707.5	23095	19.56	20	0	
				711	23130	19.58	20	0	
			25	704	23060	19.59	20	0	
				707.5	23095	19.65	20	0	
				711	23130	19.58	20	0	
			49	704	23060	19.64	20	0	
				707.5	23095	19.59	20	0	
				711	23130	19.53	20	0	
		25 RB	0	704	23060	18.65	19	0-1	
				707.5	23095	18.63	19	0-1	
				711	23130	18.68	19	0-1	
			12	704	23060	18.69	19	0-1	
				707.5	23095	18.75	19	0-1	
				711	23130	18.66	19	0-1	
			25	704	23060	18.79	19	0-1	
				707.5	23095	18.70	19	0-1	
				711	23130	18.63	19	0-1	
			50RB	704	23060	18.77	19	0-1	
				707.5	23095	18.71	19	0-1	
				711	23130	18.66	19	0-1	
		16-QAM	1 RB	0	704	23060	18.73	19	0-1
					707.5	23095	18.81	19	0-1
					711	23130	18.82	19	0-1
	25			704	23060	18.81	19	0-1	
				707.5	23095	18.85	19	0-1	
				711	23130	18.78	19	0-1	
	49			704	23060	18.87	19	0-1	
				707.5	23095	18.88	19	0-1	
				711	23130	18.76	19	0-1	
	25 RB			0	704	23060	17.68	18	0-2
					707.5	23095	17.64	18	0-2
					711	23130	17.65	18	0-2
			12	704	23060	17.70	18	0-2	
				707.5	23095	17.76	18	0-2	
				711	23130	17.68	18	0-2	
			25	704	23060	17.77	18	0-2	
				707.5	23095	17.70	18	0-2	
				711	23130	17.65	18	0-2	
	50RB		704	23060	17.78	18	0-2		
			707.5	23095	17.72	18	0-2		
			711	23130	17.67	18	0-2		

Unless otherwise stated the results shown in this test report refer only to the sample(s) tested and such sample(s) are retained for 90 days only.

除非另有說明，此報告結果僅對測試之樣品負責，同時此樣品僅保留90天。本報告未經本公司書面許可，不可部份複製。

This document is issued by the Company subject to its General Conditions of Service printed overleaf, available on request or accessible at www.sgs.com/terms_and_conditions.htm and for electronic format documents, subject to Terms and Conditions for Electronic Documents at www.sgs.com/terms_e-document.htm. Attention is drawn to the limitation of liability, indemnification and jurisdiction issues defined therein. Any holder of this document is advised that information contained hereon reflects the Company's findings at the time of its intervention only and within the limits of Client's instructions, if any. The Company's sole responsibility is to its Client and this document does not exonerate parties to a transaction from exercising all their rights and obligations under the transaction documents. This document cannot be reproduced except in full, without prior written approval of the Company. Any unauthorized alteration, forgery or falsification of the content or appearance of this document is unlawful and offenders may be prosecuted to the fullest extent of the law.

FDD Band 12								
BW(Mhz)	Modulation	RB Size	RB Offset	Frequency (MHz)	Channel	Conducted power (dBm)	Target Power + Max. Tolerance (dBm)	MPR Allowed per 3GPP(dB)
10	64-QAM	1 RB	0	704	23060	18.51	19	0-1
				707.5	23095	18.59	19	0-1
				711	23130	18.60	19	0-1
			25	704	23060	18.59	19	0-1
				707.5	23095	18.63	19	0-1
				711	23130	18.56	19	0-1
			49	704	23060	18.65	19	0-1
				707.5	23095	18.66	19	0-1
				711	23130	18.54	19	0-1
		25 RB	0	704	23060	17.46	18	0-2
				707.5	23095	17.42	18	0-2
				711	23130	17.43	18	0-2
			12	704	23060	17.48	18	0-2
				707.5	23095	17.54	18	0-2
				711	23130	17.46	18	0-2
			25	704	23060	17.55	18	0-2
				707.5	23095	17.48	18	0-2
				711	23130	17.43	18	0-2
			50RB	704	23060	17.56	18	0-2
				707.5	23095	17.50	18	0-2
				711	23130	17.45	18	0-2

Unless otherwise stated the results shown in this test report refer only to the sample(s) tested and such sample(s) are retained for 90 days only.

除非另有說明，此報告結果僅對測試之樣品負責，同時此樣品僅保留90天。本報告未經本公司書面許可，不可部份複製。

This document is issued by the Company subject to its General Conditions of Service printed overleaf, available on request or accessible at www.sgs.com/terms_and_conditions.htm and for electronic format documents, subject to Terms and Conditions for Electronic Documents at www.sgs.com/terms_e-document.htm. Attention is drawn to the limitation of liability, indemnification and jurisdiction issues defined therein. Any holder of this document is advised that information contained hereon reflects the Company's findings at the time of its intervention only and within the limits of Client's instructions, if any. The Company's sole responsibility is to its Client and this document does not exonerate parties to a transaction from exercising all their rights and obligations under the transaction documents. This document cannot be reproduced except in full, without prior written approval of the Company. Any unauthorized alteration, forgery or falsification of the content or appearance of this document is unlawful and offenders may be prosecuted to the fullest extent of the law.

FDD Band 12									
BW(Mhz)	Modulation	RB Size	RB Offset	Frequency (MHz)	Channel	Conducted power (dBm)	Target Power + Max. Tolerance (dBm)	MPR Allowed per 3GPP(dB)	
5	QPSK	1 RB	0	701.5	23035	19.35	20	0	
				707.5	23095	19.40	20	0	
				713.5	23155	19.38	20	0	
			12	701.5	23035	19.49	20	0	
				707.5	23095	19.56	20	0	
				713.5	23155	19.44	20	0	
		24	701.5	23035	19.57	20	0		
			707.5	23095	19.52	20	0		
			713.5	23155	19.34	20	0		
		12 RB	0	701.5	23035	18.47	19	0-1	
				707.5	23095	18.45	19	0-1	
				713.5	23155	18.65	19	0-1	
			6	701.5	23035	18.61	19	0-1	
				707.5	23095	18.63	19	0-1	
				713.5	23155	18.59	19	0-1	
			13	701.5	23035	18.66	19	0-1	
				707.5	23095	18.61	19	0-1	
				713.5	23155	18.59	19	0-1	
			25RB	701.5	23035	18.74	19	0-1	
				707.5	23095	18.60	19	0-1	
				713.5	23155	18.50	19	0-1	
		16-QAM	1 RB	0	701.5	23035	18.64	19	0-1
					707.5	23095	18.72	19	0-1
					713.5	23155	18.68	19	0-1
	12			701.5	23035	18.67	19	0-1	
				707.5	23095	18.80	19	0-1	
				713.5	23155	18.70	19	0-1	
	24			701.5	23035	18.75	19	0-1	
				707.5	23095	18.69	19	0-1	
				713.5	23155	18.61	19	0-1	
	12 RB			0	701.5	23035	17.64	18	0-2
					707.5	23095	17.50	18	0-2
					713.5	23155	17.50	18	0-2
			6	701.5	23035	17.64	18	0-2	
				707.5	23095	17.59	18	0-2	
				713.5	23155	17.54	18	0-2	
			13	701.5	23035	17.76	18	0-2	
				707.5	23095	17.58	18	0-2	
				713.5	23155	17.60	18	0-2	
	25RB		701.5	23035	17.69	18	0-2		
			707.5	23095	17.55	18	0-2		
			713.5	23155	17.66	18	0-2		

Unless otherwise stated the results shown in this test report refer only to the sample(s) tested and such sample(s) are retained for 90 days only.

除非另有說明，此報告結果僅對測試之樣品負責，同時此樣品僅保留90天。本報告未經本公司書面許可，不可部份複製。

This document is issued by the Company subject to its General Conditions of Service printed overleaf, available on request or accessible at www.sgs.com/terms_and_conditions.htm and for electronic format documents, subject to Terms and Conditions for Electronic Documents at www.sgs.com/terms_e-document.htm. Attention is drawn to the limitation of liability, indemnification and jurisdiction issues defined therein. Any holder of this document is advised that information contained hereon reflects the Company's findings at the time of its intervention only and within the limits of Client's instructions, if any. The Company's sole responsibility is to its Client and this document does not exonerate parties to a transaction from exercising all their rights and obligations under the transaction documents. This document cannot be reproduced except in full, without prior written approval of the Company. Any unauthorized alteration, forgery or falsification of the content or appearance of this document is unlawful and offenders may be prosecuted to the fullest extent of the law.

FDD Band 12								
BW(Mhz)	Modulation	RB Size	RB Offset	Frequency (MHz)	Channel	Conducted power (dBm)	Target Power + Max. Tolerance (dBm)	MPR Allowed per 3GPP(dB)
5	64-QAM	1 RB	0	701.5	23035	18.39	19	0-1
				707.5	23095	18.52	19	0-1
				713.5	23155	18.45	19	0-1
			12	701.5	23035	18.59	19	0-1
				707.5	23095	18.43	19	0-1
				713.5	23155	18.46	19	0-1
			24	701.5	23035	18.48	19	0-1
				707.5	23095	18.51	19	0-1
				713.5	23155	18.52	19	0-1
		12 RB	0	701.5	23035	17.40	18	0-2
				707.5	23095	17.38	18	0-2
				713.5	23155	17.38	18	0-2
			6	701.5	23035	17.33	18	0-2
				707.5	23095	17.50	18	0-2
				713.5	23155	17.41	18	0-2
			13	701.5	23035	17.53	18	0-2
				707.5	23095	17.47	18	0-2
				713.5	23155	17.27	18	0-2
		25RB	701.5	23035	17.55	18	0-2	
			707.5	23095	17.35	18	0-2	
			713.5	23155	17.37	18	0-2	

Unless otherwise stated the results shown in this test report refer only to the sample(s) tested and such sample(s) are retained for 90 days only.

除非另有說明，此報告結果僅對測試之樣品負責，同時此樣品僅保留90天。本報告未經本公司書面許可，不可部份複製。

This document is issued by the Company subject to its General Conditions of Service printed overleaf, available on request or accessible at www.sgs.com/terms_and_conditions.htm and for electronic format documents, subject to Terms and Conditions for Electronic Documents at www.sgs.com/terms_e-document.htm. Attention is drawn to the limitation of liability, indemnification and jurisdiction issues defined therein. Any holder of this document is advised that information contained hereon reflects the Company's findings at the time of its intervention only and within the limits of Client's instructions, if any. The Company's sole responsibility is to its Client and this document does not exonerate parties to a transaction from exercising all their rights and obligations under the transaction documents. This document cannot be reproduced except in full, without prior written approval of the Company. Any unauthorized alteration, forgery or falsification of the content or appearance of this document is unlawful and offenders may be prosecuted to the fullest extent of the law.

FDD Band 12									
BW(Mhz)	Modulation	RB Size	RB Offset	Frequency (MHz)	Channel	Conducted power (dBm)	Target Power + Max. Tolerance (dBm)	MPR Allowed per 3GPP(dB)	
3	QPSK	1 RB	0	700.5	23025	19.43	20	0	
				707.5	23095	19.53	20	0	
				714.5	23165	19.49	20	0	
			7	700.5	23025	19.49	20	0	
				707.5	23095	19.46	20	0	
				714.5	23165	19.41	20	0	
		14	700.5	23025	19.58	20	0		
			707.5	23095	19.42	20	0		
			714.5	23165	19.34	20	0		
		8 RB	0	700.5	23025	18.46	19	0-1	
				707.5	23095	18.57	19	0-1	
				714.5	23165	18.51	19	0-1	
			4	700.5	23025	18.51	19	0-1	
				707.5	23095	18.63	19	0-1	
				714.5	23165	18.62	19	0-1	
			7	700.5	23025	18.72	19	0-1	
				707.5	23095	18.57	19	0-1	
				714.5	23165	18.44	19	0-1	
		15RB	700.5	23025	18.74	19	0-1		
			707.5	23095	18.67	19	0-1		
			714.5	23165	18.53	19	0-1		
		16-QAM	1 RB	0	700.5	23025	18.63	19	0-1
					707.5	23095	18.74	19	0-1
					714.5	23165	18.69	19	0-1
	7			700.5	23025	18.74	19	0-1	
				707.5	23095	18.67	19	0-1	
				714.5	23165	18.62	19	0-1	
	14			700.5	23025	18.78	19	0-1	
				707.5	23095	18.80	19	0-1	
				714.5	23165	18.74	19	0-1	
	8 RB			0	700.5	23025	17.67	18	0-2
					707.5	23095	17.58	18	0-2
					714.5	23165	17.53	18	0-2
			4	700.5	23025	17.63	18	0-2	
				707.5	23095	17.58	18	0-2	
				714.5	23165	17.55	18	0-2	
			7	700.5	23025	17.70	18	0-2	
				707.5	23095	17.68	18	0-2	
				714.5	23165	17.52	18	0-2	
	15RB		700.5	23025	17.75	18	0-2		
			707.5	23095	17.72	18	0-2		
			714.5	23165	17.61	18	0-2		

Unless otherwise stated the results shown in this test report refer only to the sample(s) tested and such sample(s) are retained for 90 days only.

除非另有說明，此報告結果僅對測試之樣品負責，同時此樣品僅保留90天。本報告未經本公司書面許可，不可部份複製。

This document is issued by the Company subject to its General Conditions of Service printed overleaf, available on request or accessible at www.sgs.com/terms_and_conditions.htm and for electronic format documents, subject to Terms and Conditions for Electronic Documents at www.sgs.com/terms_e-document.htm. Attention is drawn to the limitation of liability, indemnification and jurisdiction issues defined therein. Any holder of this document is advised that information contained hereon reflects the Company's findings at the time of its intervention only and within the limits of Client's instructions, if any. The Company's sole responsibility is to its Client and this document does not exonerate parties to a transaction from exercising all their rights and obligations under the transaction documents. This document cannot be reproduced except in full, without prior written approval of the Company. Any unauthorized alteration, forgery or falsification of the content or appearance of this document is unlawful and offenders may be prosecuted to the fullest extent of the law.

FDD Band 12								
BW(MHz)	Modulation	RB Size	RB Offset	Frequency (MHz)	Channel	Conducted power (dBm)	Target Power + Max. Tolerance (dBm)	MPR Allowed per 3GPP(dB)
3	64-QAM	1 RB	0	700.5	23025	18.32	19	0-1
				707.5	23095	18.40	19	0-1
				714.5	23165	18.42	19	0-1
			7	700.5	23025	18.48	19	0-1
				707.5	23095	18.47	19	0-1
				714.5	23165	18.51	19	0-1
			14	700.5	23025	18.52	19	0-1
				707.5	23095	18.59	19	0-1
				714.5	23165	18.47	19	0-1
		8 RB	0	700.5	23025	17.36	18	0-2
				707.5	23095	17.25	18	0-2
				714.5	23165	17.37	18	0-2
			4	700.5	23025	17.39	18	0-2
				707.5	23095	17.35	18	0-2
				714.5	23165	17.30	18	0-2
			7	700.5	23025	17.38	18	0-2
				707.5	23095	17.32	18	0-2
				714.5	23165	17.27	18	0-2
		15RB	700.5	23025	17.54	18	0-2	
			707.5	23095	17.40	18	0-2	
			714.5	23165	17.43	18	0-2	

Unless otherwise stated the results shown in this test report refer only to the sample(s) tested and such sample(s) are retained for 90 days only.

除非另有說明，此報告結果僅對測試之樣品負責，同時此樣品僅保留90天。本報告未經本公司書面許可，不可部份複製。

This document is issued by the Company subject to its General Conditions of Service printed overleaf, available on request or accessible at www.sgs.com/terms_and_conditions.htm and for electronic format documents, subject to Terms and Conditions for Electronic Documents at www.sgs.com/terms_e-document.htm. Attention is drawn to the limitation of liability, indemnification and jurisdiction issues defined therein. Any holder of this document is advised that information contained hereon reflects the Company's findings at the time of its intervention only and within the limits of Client's instructions, if any. The Company's sole responsibility is to its Client and this document does not exonerate parties to a transaction from exercising all their rights and obligations under the transaction documents. This document cannot be reproduced except in full, without prior written approval of the Company. Any unauthorized alteration, forgery or falsification of the content or appearance of this document is unlawful and offenders may be prosecuted to the fullest extent of the law.

FDD Band 12									
BW(Mhz)	Modulation	RB Size	RB Offset	Frequency (MHz)	Channel	Conducted power (dBm)	Target Power + Max. Tolerance (dBm)	MPR Allowed per 3GPP(dB)	
1.4	QPSK	1 RB	0	699.7	23017	19.44	20	0	
				707.5	23095	19.50	20	0	
				715.3	23173	19.42	20	0	
			2	699.7	23017	19.52	20	0	
				707.5	23095	19.46	20	0	
				715.3	23173	19.45	20	0	
		5	699.7	23017	19.44	20	0		
			707.5	23095	19.58	20	0		
			715.3	23173	19.48	20	0		
		3 RB	0	699.7	23017	18.48	19	0-1	
				707.5	23095	18.60	19	0-1	
				715.3	23173	18.53	19	0-1	
			2	699.7	23017	18.65	19	0-1	
				707.5	23095	18.59	19	0-1	
				715.3	23173	18.60	19	0-1	
			3	699.7	23017	18.61	19	0-1	
				707.5	23095	18.56	19	0-1	
				715.3	23173	18.49	19	0-1	
		6RB	699.7	23017	18.67	19	0-1		
			707.5	23095	18.71	19	0-1		
			715.3	23173	18.61	19	0-1		
		16-QAM	1 RB	0	699.7	23017	18.70	19	0-1
					707.5	23095	18.69	19	0-1
					715.3	23173	18.68	19	0-1
	2			699.7	23017	18.71	19	0-1	
				707.5	23095	18.78	19	0-1	
				715.3	23173	18.60	19	0-1	
	5			699.7	23017	18.79	19	0-1	
				707.5	23095	18.82	19	0-1	
				715.3	23173	18.58	19	0-1	
	3 RB			0	699.7	23017	17.62	18	0-2
					707.5	23095	17.50	18	0-2
					715.3	23173	17.57	18	0-2
			2	699.7	23017	17.63	18	0-2	
				707.5	23095	17.61	18	0-2	
				715.3	23173	17.67	18	0-2	
			3	699.7	23017	17.76	18	0-2	
				707.5	23095	17.50	18	0-2	
				715.3	23173	17.62	18	0-2	
	6RB		699.7	23017	17.64	18	0-2		
			707.5	23095	17.59	18	0-2		
			715.3	23173	17.60	18	0-2		

Unless otherwise stated the results shown in this test report refer only to the sample(s) tested and such sample(s) are retained for 90 days only.

除非另有說明，此報告結果僅對測試之樣品負責，同時此樣品僅保留90天。本報告未經本公司書面許可，不可部份複製。

This document is issued by the Company subject to its General Conditions of Service printed overleaf, available on request or accessible at www.sgs.com/terms_and_conditions.htm and for electronic format documents, subject to Terms and Conditions for Electronic Documents at www.sgs.com/terms_e-document.htm. Attention is drawn to the limitation of liability, indemnification and jurisdiction issues defined therein. Any holder of this document is advised that information contained hereon reflects the Company's findings at the time of its intervention only and within the limits of Client's instructions, if any. The Company's sole responsibility is to its Client and this document does not exonerate parties to a transaction from exercising all their rights and obligations under the transaction documents. This document cannot be reproduced except in full, without prior written approval of the Company. Any unauthorized alteration, forgery or falsification of the content or appearance of this document is unlawful and offenders may be prosecuted to the fullest extent of the law.

FDD Band 12								
BW(MHz)	Modulation	RB Size	RB Offset	Frequency (MHz)	Channel	Conducted power (dBm)	Target Power + Max. Tolerance (dBm)	MPR Allowed per 3GPP(dB)
1.4	64-QAM	1 RB	0	699.7	23017	18.35	19	0-1
				707.5	23095	18.45	19	0-1
				715.3	23173	18.43	19	0-1
			2	699.7	23017	18.50	19	0-1
				707.5	23095	18.56	19	0-1
				715.3	23173	18.48	19	0-1
			5	699.7	23017	18.54	19	0-1
				707.5	23095	18.49	19	0-1
				715.3	23173	18.37	19	0-1
		3 RB	0	699.7	23017	17.44	18	0-2
				707.5	23095	17.42	18	0-2
				715.3	23173	17.37	18	0-2
			2	699.7	23017	17.48	18	0-2
				707.5	23095	17.39	18	0-2
				715.3	23173	17.34	18	0-2
			3	699.7	23017	17.44	18	0-2
				707.5	23095	17.38	18	0-2
				715.3	23173	17.36	18	0-2
		6RB	699.7	23017	17.48	18	0-2	
			707.5	23095	17.35	18	0-2	
			715.3	23173	17.37	18	0-2	

Unless otherwise stated the results shown in this test report refer only to the sample(s) tested and such sample(s) are retained for 90 days only.

除非另有說明，此報告結果僅對測試之樣品負責，同時此樣品僅保留90天。本報告未經本公司書面許可，不可部份複製。

This document is issued by the Company subject to its General Conditions of Service printed overleaf, available on request or accessible at www.sgs.com/terms_and_conditions.htm and for electronic format documents, subject to Terms and Conditions for Electronic Documents at www.sgs.com/terms_e-document.htm. Attention is drawn to the limitation of liability, indemnification and jurisdiction issues defined therein. Any holder of this document is advised that information contained hereon reflects the Company's findings at the time of its intervention only and within the limits of Client's instructions, if any. The Company's sole responsibility is to its Client and this document does not exonerate parties to a transaction from exercising all their rights and obligations under the transaction documents. This document cannot be reproduced except in full, without prior written approval of the Company. Any unauthorized alteration, forgery or falsification of the content or appearance of this document is unlawful and offenders may be prosecuted to the fullest extent of the law.

FDD Band 13									
BW(Mhz)	Modulation	RB Size	RB Offset	Frequency (MHz)	Channel	Conducted power (dBm)	Target Power + Max. Tolerance (dBm)	MPR Allowed per 3GPP(dB)	
10	QPSK	1 RB	0	782	23230	19.52	20	0	
			25	782	23230	19.41	20	0	
			49	782	23230	19.44	20	0	
		25 RB	0	782	23230	18.54	19	0-1	
			12	782	23230	18.51	19	0-1	
			25	782	23230	18.48	19	0-1	
		50RB			782	23230	18.52	19	0-1
		16-QAM	1 RB	0	782	23230	18.75	19	0-1
				25	782	23230	18.69	19	0-1
	49			782	23230	18.64	19	0-1	
	25 RB		0	782	23230	17.57	18	0-2	
			12	782	23230	17.54	18	0-2	
			25	782	23230	17.44	18	0-2	
	50RB			782	23230	17.53	18	0-2	
	64-QAM	1 RB	0	782	23230	18.56	19	0-1	
			25	782	23230	18.50	19	0-1	
			49	782	23230	18.45	19	0-1	
		25 RB	0	782	23230	17.38	18	0-2	
			12	782	23230	17.35	18	0-2	
			25	782	23230	17.25	18	0-2	
		50RB			782	23230	17.34	18	0-2

Unless otherwise stated the results shown in this test report refer only to the sample(s) tested and such sample(s) are retained for 90 days only.

除非另有說明，此報告結果僅對測試之樣品負責，同時此樣品僅保留90天。本報告未經本公司書面許可，不可部份複製。

This document is issued by the Company subject to its General Conditions of Service printed overleaf, available on request or accessible at www.sgs.com/terms_and_conditions.htm and for electronic format documents, subject to Terms and Conditions for Electronic Documents at www.sgs.com/terms_e-document.htm. Attention is drawn to the limitation of liability, indemnification and jurisdiction issues defined therein. Any holder of this document is advised that information contained hereon reflects the Company's findings at the time of its intervention only and within the limits of Client's instructions, if any. The Company's sole responsibility is to its Client and this document does not exonerate parties to a transaction from exercising all their rights and obligations under the transaction documents. This document cannot be reproduced except in full, without prior written approval of the Company. Any unauthorized alteration, forgery or falsification of the content or appearance of this document is unlawful and offenders may be prosecuted to the fullest extent of the law.

FDD Band 13									
BW(Mhz)	Modulation	RB Size	RB Offset	Frequency (MHz)	Channel	Conducted power (dBm)	Target Power + Max. Tolerance (dBm)	MPR Allowed per 3GPP(dB)	
5	QPSK	1 RB	0	779.5	23205	19.50	20	0	
				782	23230	19.44	20	0	
				784.5	23255	19.42	20	0	
			12	779.5	23205	19.44	20	0	
				782	23230	19.39	20	0	
				784.5	23255	19.49	20	0	
		24	779.5	23205	19.41	20	0		
			782	23230	19.33	20	0		
			784.5	23255	19.44	20	0		
		12 RB	0	779.5	23205	18.58	19	0-1	
				782	23230	18.54	19	0-1	
				784.5	23255	18.47	19	0-1	
			6	779.5	23205	18.55	19	0-1	
				782	23230	18.50	19	0-1	
				784.5	23255	18.55	19	0-1	
			13	779.5	23205	18.48	19	0-1	
				782	23230	18.43	19	0-1	
				784.5	23255	18.49	19	0-1	
			25RB	779.5	23205	18.53	19	0-1	
				782	23230	18.50	19	0-1	
				784.5	23255	18.55	19	0-1	
		16-QAM	1 RB	0	779.5	23205	18.65	19	0-1
					782	23230	18.71	19	0-1
					784.5	23255	18.70	19	0-1
	12			779.5	23205	18.70	19	0-1	
				782	23230	18.69	19	0-1	
				784.5	23255	18.76	19	0-1	
	24			779.5	23205	18.71	19	0-1	
				782	23230	18.65	19	0-1	
				784.5	23255	18.63	19	0-1	
	12 RB			0	779.5	23205	17.61	18	0-2
					782	23230	17.54	18	0-2
					784.5	23255	17.50	18	0-2
			6	779.5	23205	17.58	18	0-2	
				782	23230	17.54	18	0-2	
				784.5	23255	17.56	18	0-2	
			13	779.5	23205	17.51	18	0-2	
				782	23230	17.44	18	0-2	
				784.5	23255	17.51	18	0-2	
			25RB	779.5	23205	17.55	18	0-2	
				782	23230	17.50	18	0-2	
				784.5	23255	17.55	18	0-2	

Unless otherwise stated the results shown in this test report refer only to the sample(s) tested and such sample(s) are retained for 90 days only.

除非另有說明，此報告結果僅對測試之樣品負責，同時此樣品僅保留90天。本報告未經本公司書面許可，不可部份複製。

This document is issued by the Company subject to its General Conditions of Service printed overleaf, available on request or accessible at www.sgs.com/terms_and_conditions.htm and for electronic format documents, subject to Terms and Conditions for Electronic Documents at www.sgs.com/terms_e-document.htm. Attention is drawn to the limitation of liability, indemnification and jurisdiction issues defined therein. Any holder of this document is advised that information contained hereon reflects the Company's findings at the time of its intervention only and within the limits of Client's instructions, if any. The Company's sole responsibility is to its Client and this document does not exonerate parties to a transaction from exercising all their rights and obligations under the transaction documents. This document cannot be reproduced except in full, without prior written approval of the Company. Any unauthorized alteration, forgery or falsification of the content or appearance of this document is unlawful and offenders may be prosecuted to the fullest extent of the law.

FDD Band 13								
BW(MHz)	Modulation	RB Size	RB Offset	Frequency (MHz)	Channel	Conducted power (dBm)	Target Power + Max. Tolerance (dBm)	MPR Allowed per 3GPP(dB)
5	64-QAM	1 RB	0	779.5	23205	18.43	19	0-1
				782	23230	18.49	19	0-1
				784.5	23255	18.48	19	0-1
			12	779.5	23205	18.48	19	0-1
				782	23230	18.47	19	0-1
				784.5	23255	18.54	19	0-1
			24	779.5	23205	18.49	19	0-1
				782	23230	18.43	19	0-1
				784.5	23255	18.41	19	0-1
		12 RB	0	779.5	23205	17.39	18	0-2
				782	23230	17.32	18	0-2
				784.5	23255	17.28	18	0-2
			6	779.5	23205	17.36	18	0-2
				782	23230	17.32	18	0-2
				784.5	23255	17.34	18	0-2
			13	779.5	23205	17.29	18	0-2
				782	23230	17.22	18	0-2
				784.5	23255	17.29	18	0-2
			25RB	779.5	23205	17.33	18	0-2
				782	23230	17.28	18	0-2
				784.5	23255	17.33	18	0-2

Unless otherwise stated the results shown in this test report refer only to the sample(s) tested and such sample(s) are retained for 90 days only.

除非另有說明，此報告結果僅對測試之樣品負責，同時此樣品僅保留90天。本報告未經本公司書面許可，不可部份複製。

This document is issued by the Company subject to its General Conditions of Service printed overleaf, available on request or accessible at www.sgs.com/terms_and_conditions.htm and for electronic format documents, subject to Terms and Conditions for Electronic Documents at www.sgs.com/terms_e-document.htm. Attention is drawn to the limitation of liability, indemnification and jurisdiction issues defined therein. Any holder of this document is advised that information contained hereon reflects the Company's findings at the time of its intervention only and within the limits of Client's instructions, if any. The Company's sole responsibility is to its Client and this document does not exonerate parties to a transaction from exercising all their rights and obligations under the transaction documents. This document cannot be reproduced except in full, without prior written approval of the Company. Any unauthorized alteration, forgery or falsification of the content or appearance of this document is unlawful and offenders may be prosecuted to the fullest extent of the law.

FDD Band 14									
BW(Mhz)	Modulation	RB Size	RB Offset	Frequency (MHz)	Channel	Conducted power (dBm)	Target Power + Max. Tolerance (dBm)	MPR Allowed per 3GPP(dB)	
10	QPSK	1 RB	0	793	23330	19.02	19.5	0	
			25	793	23330	18.95	19.5	0	
			49	793	23330	18.89	19.5	0	
		25 RB	0	793	23330	18.06	18.5	0-1	
			12	793	23330	18.04	18.5	0-1	
			25	793	23330	17.95	18.5	0-1	
		50RB		793	23330	18.03	18.5	0-1	
		16-QAM	1 RB	0	793	23330	18.26	18.5	0-1
				25	793	23330	18.20	18.5	0-1
	49			793	23330	18.17	18.5	0-1	
	25 RB		0	793	23330	17.08	17.5	0-2	
			12	793	23330	17.03	17.5	0-2	
			25	793	23330	16.94	17.5	0-2	
	50RB		793	23330	17.03	17.5	0-2		
	64-QAM		1 RB	0	793	23330	18.05	18.5	0-1
				25	793	23330	17.99	18.5	0-1
		49		793	23330	17.96	18.5	0-1	
		25 RB	0	793	23330	16.87	17.5	0-2	
			12	793	23330	16.82	17.5	0-2	
			25	793	23330	16.73	17.5	0-2	
		50RB		793	23330	16.82	17.5	0-2	

Unless otherwise stated the results shown in this test report refer only to the sample(s) tested and such sample(s) are retained for 90 days only.

除非另有說明，此報告結果僅對測試之樣品負責，同時此樣品僅保留90天。本報告未經本公司書面許可，不可部份複製。

This document is issued by the Company subject to its General Conditions of Service printed overleaf, available on request or accessible at www.sgs.com/terms_and_conditions.htm and for electronic format documents, subject to Terms and Conditions for Electronic Documents at www.sgs.com/terms_e-document.htm. Attention is drawn to the limitation of liability, indemnification and jurisdiction issues defined therein. Any holder of this document is advised that information contained hereon reflects the Company's findings at the time of its intervention only and within the limits of Client's instructions, if any. The Company's sole responsibility is to its Client and this document does not exonerate parties to a transaction from exercising all their rights and obligations under the transaction documents. This document cannot be reproduced except in full, without prior written approval of the Company. Any unauthorized alteration, forgery or falsification of the content or appearance of this document is unlawful and offenders may be prosecuted to the fullest extent of the law.

FDD Band 14									
BW(Mhz)	Modulation	RB Size	RB Offset	Frequency (MHz)	Channel	Conducted power (dBm)	Target Power + Max. Tolerance (dBm)	MPR Allowed per 3GPP(dB)	
5	QPSK	1 RB	0	790.5	23305	18.93	19.5	0	
				793	23330	18.92	19.5	0	
				795.5	23355	18.98	19.5	0	
			12	790.5	23305	18.87	19.5	0	
				793	23330	18.94	19.5	0	
				795.5	23355	18.97	19.5	0	
		24	790.5	23305	18.94	19.5	0		
			793	23330	18.88	19.5	0		
			795.5	23355	18.92	19.5	0		
		12 RB	0	790.5	23305	17.97	18.5	0-1	
				793	23330	18.02	18.5	0-1	
				795.5	23355	18.00	18.5	0-1	
			6	790.5	23305	17.95	18.5	0-1	
				793	23330	18.04	18.5	0-1	
				795.5	23355	18.07	18.5	0-1	
			13	790.5	23305	17.98	18.5	0-1	
				793	23330	17.98	18.5	0-1	
				795.5	23355	18.02	18.5	0-1	
			25RB	790.5	23305	17.94	18.5	0-1	
				793	23330	17.98	18.5	0-1	
				795.5	23355	18.03	18.5	0-1	
		16-QAM	1 RB	0	790.5	23305	18.22	18.5	0-1
					793	23330	18.30	18.5	0-1
					795.5	23355	18.21	18.5	0-1
	12			790.5	23305	18.16	18.5	0-1	
				793	23330	18.24	18.5	0-1	
				795.5	23355	18.26	18.5	0-1	
	24			790.5	23305	18.17	18.5	0-1	
				793	23330	18.12	18.5	0-1	
				795.5	23355	18.17	18.5	0-1	
	12 RB			0	790.5	23305	16.99	17.5	0-2
					793	23330	17.03	17.5	0-2
					795.5	23355	16.97	17.5	0-2
			6	790.5	23305	16.96	17.5	0-2	
				793	23330	17.02	17.5	0-2	
				795.5	23355	17.05	17.5	0-2	
			13	790.5	23305	17.00	17.5	0-2	
				793	23330	16.94	17.5	0-2	
				795.5	23355	17.00	17.5	0-2	
	25RB		790.5	23305	16.94	17.5	0-2		
			793	23330	17.02	17.5	0-2		
			795.5	23355	17.05	17.5	0-2		

Unless otherwise stated the results shown in this test report refer only to the sample(s) tested and such sample(s) are retained for 90 days only.

除非另有說明，此報告結果僅對測試之樣品負責，同時此樣品僅保留90天。本報告未經本公司書面許可，不可部份複製。

This document is issued by the Company subject to its General Conditions of Service printed overleaf, available on request or accessible at www.sgs.com/terms_and_conditions.htm and for electronic format documents, subject to Terms and Conditions for Electronic Documents at www.sgs.com/terms_e-document.htm. Attention is drawn to the limitation of liability, indemnification and jurisdiction issues defined therein. Any holder of this document is advised that information contained hereon reflects the Company's findings at the time of its intervention only and within the limits of Client's instructions, if any. The Company's sole responsibility is to its Client and this document does not exonerate parties to a transaction from exercising all their rights and obligations under the transaction documents. This document cannot be reproduced except in full, without prior written approval of the Company. Any unauthorized alteration, forgery or falsification of the content or appearance of this document is unlawful and offenders may be prosecuted to the fullest extent of the law.

FDD Band 14								
BW(Mhz)	Modulation	RB Size	RB Offset	Frequency (MHz)	Channel	Conducted power (dBm)	Target Power + Max. Tolerance (dBm)	MPR Allowed per 3GPP(dB)
5	64-QAM	1 RB	0	790.5	23305	17.99	18.5	0-1
				793	23330	18.07	18.5	0-1
				795.5	23355	17.98	18.5	0-1
			12	790.5	23305	17.93	18.5	0-1
				793	23330	18.01	18.5	0-1
				795.5	23355	18.03	18.5	0-1
			24	790.5	23305	17.94	18.5	0-1
				793	23330	17.89	18.5	0-1
				795.5	23355	17.94	18.5	0-1
		12 RB	0	790.5	23305	16.76	17.5	0-2
				793	23330	16.80	17.5	0-2
				795.5	23355	16.74	17.5	0-2
			6	790.5	23305	16.73	17.5	0-2
				793	23330	16.79	17.5	0-2
				795.5	23355	16.82	17.5	0-2
			13	790.5	23305	16.77	17.5	0-2
				793	23330	16.71	17.5	0-2
				795.5	23355	16.77	17.5	0-2
			25RB	790.5	23305	16.71	17.5	0-2
				793	23330	16.79	17.5	0-2
				795.5	23355	16.82	17.5	0-2

Unless otherwise stated the results shown in this test report refer only to the sample(s) tested and such sample(s) are retained for 90 days only.

除非另有說明，此報告結果僅對測試之樣品負責，同時此樣品僅保留90天。本報告未經本公司書面許可，不可部份複製。

This document is issued by the Company subject to its General Conditions of Service printed overleaf, available on request or accessible at www.sgs.com/terms_and_conditions.htm and for electronic format documents, subject to Terms and Conditions for Electronic Documents at www.sgs.com/terms_e-document.htm. Attention is drawn to the limitation of liability, indemnification and jurisdiction issues defined therein. Any holder of this document is advised that information contained hereon reflects the Company's findings at the time of its intervention only and within the limits of Client's instructions, if any. The Company's sole responsibility is to its Client and this document does not exonerate parties to a transaction from exercising all their rights and obligations under the transaction documents. This document cannot be reproduced except in full, without prior written approval of the Company. Any unauthorized alteration, forgery or falsification of the content or appearance of this document is unlawful and offenders may be prosecuted to the fullest extent of the law.

FDD Band 25									
BW(Mhz)	Modulation	RB Size	RB Offset	Frequency (MHz)	Channel	Conducted power (dBm)	Target Power + Max. Tolerance (dBm)	MPR Allowed per 3GPP(dB)	
20	QPSK	1 RB	0	1860	26140	15.11	15.6	0	
				1882.5	26365	15.02	15.6	0	
				1905	26590	15.08	15.6	0	
			50	1860	26140	14.74	15.6	0	
				1882.5	26365	14.69	15.6	0	
				1905	26590	14.88	15.6	0	
			99	1860	26140	14.93	15.6	0	
				1882.5	26365	14.89	15.6	0	
				1905	26590	15.01	15.6	0	
		50 RB	0	1860	26140	13.88	14.6	0-1	
				1882.5	26365	13.83	14.6	0-1	
				1905	26590	14.09	14.6	0-1	
			25	1860	26140	13.83	14.6	0-1	
				1882.5	26365	13.79	14.6	0-1	
				1905	26590	14.02	14.6	0-1	
			50	1860	26140	13.83	14.6	0-1	
				1882.5	26365	13.81	14.6	0-1	
				1905	26590	14.10	14.6	0-1	
			100RB	1860	26140	13.82	14.6	0-1	
				1882.5	26365	13.76	14.6	0-1	
				1905	26590	14.01	14.6	0-1	
		16-QAM	1 RB	0	1860	26140	14.49	14.6	0-1
					1882.5	26365	14.39	14.6	0-1
					1905	26590	14.44	14.6	0-1
	50			1860	26140	14.06	14.6	0-1	
				1882.5	26365	14.00	14.6	0-1	
				1905	26590	14.25	14.6	0-1	
	99			1860	26140	14.28	14.6	0-1	
				1882.5	26365	14.22	14.6	0-1	
				1905	26590	14.33	14.6	0-1	
	50 RB			0	1860	26140	12.91	13.6	0-2
					1882.5	26365	12.85	13.6	0-2
					1905	26590	13.13	13.6	0-2
			25	1860	26140	12.83	13.6	0-2	
				1882.5	26365	12.80	13.6	0-2	
				1905	26590	13.05	13.6	0-2	
			50	1860	26140	12.91	13.6	0-2	
				1882.5	26365	12.85	13.6	0-2	
				1905	26590	13.08	13.6	0-2	
	100RB		1860	26140	12.87	13.6	0-2		
			1882.5	26365	12.74	13.6	0-2		
			1905	26590	13.02	13.6	0-2		

Unless otherwise stated the results shown in this test report refer only to the sample(s) tested and such sample(s) are retained for 90 days only.

除非另有說明，此報告結果僅對測試之樣品負責，同時此樣品僅保留90天。本報告未經本公司書面許可，不可部份複製。

This document is issued by the Company subject to its General Conditions of Service printed overleaf, available on request or accessible at www.sgs.com/terms_and_conditions.htm and for electronic format documents, subject to Terms and Conditions for Electronic Documents at www.sgs.com/terms_e-document.htm. Attention is drawn to the limitation of liability, indemnification and jurisdiction issues defined therein. Any holder of this document is advised that information contained hereon reflects the Company's findings at the time of its intervention only and within the limits of Client's instructions, if any. The Company's sole responsibility is to its Client and this document does not exonerate parties to a transaction from exercising all their rights and obligations under the transaction documents. This document cannot be reproduced except in full, without prior written approval of the Company. Any unauthorized alteration, forgery or falsification of the content or appearance of this document is unlawful and offenders may be prosecuted to the fullest extent of the law.

FDD Band 25								
BW(MHz)	Modulation	RB Size	RB Offset	Frequency (MHz)	Channel	Conducted power (dBm)	Target Power + Max. Tolerance (dBm)	MPR Allowed per 3GPP(dB)
20	64-QAM	1 RB	0	1860	26140	14.09	14.6	0-1
				1882.5	26365	13.95	14.6	0-1
				1905	26590	14.04	14.6	0-1
			50	1860	26140	13.71	14.6	0-1
				1882.5	26365	13.61	14.6	0-1
				1905	26590	13.84	14.6	0-1
			99	1860	26140	13.88	14.6	0-1
				1882.5	26365	13.86	14.6	0-1
				1905	26590	13.93	14.6	0-1
		50 RB	0	1860	26140	12.53	13.6	0-2
				1882.5	26365	12.44	13.6	0-2
				1905	26590	12.70	13.6	0-2
			25	1860	26140	12.43	13.6	0-2
				1882.5	26365	12.36	13.6	0-2
				1905	26590	12.66	13.6	0-2
			50	1860	26140	12.47	13.6	0-2
				1882.5	26365	12.43	13.6	0-2
				1905	26590	12.71	13.6	0-2
			100RB	1860	26140	12.44	13.6	0-2
				1882.5	26365	12.36	13.6	0-2
				1905	26590	12.62	13.6	0-2

Unless otherwise stated the results shown in this test report refer only to the sample(s) tested and such sample(s) are retained for 90 days only.

除非另有說明，此報告結果僅對測試之樣品負責，同時此樣品僅保留90天。本報告未經本公司書面許可，不可部份複製。

This document is issued by the Company subject to its General Conditions of Service printed overleaf, available on request or accessible at www.sgs.com/terms_and_conditions.htm and for electronic format documents, subject to Terms and Conditions for Electronic Documents at www.sgs.com/terms_e-document.htm. Attention is drawn to the limitation of liability, indemnification and jurisdiction issues defined therein. Any holder of this document is advised that information contained hereon reflects the Company's findings at the time of its intervention only and within the limits of Client's instructions, if any. The Company's sole responsibility is to its Client and this document does not exonerate parties to a transaction from exercising all their rights and obligations under the transaction documents. This document cannot be reproduced except in full, without prior written approval of the Company. Any unauthorized alteration, forgery or falsification of the content or appearance of this document is unlawful and offenders may be prosecuted to the fullest extent of the law.

FDD Band 25									
BW(Mhz)	Modulation	RB Size	RB Offset	Frequency (MHz)	Channel	Conducted power (dBm)	Target Power + Max. Tolerance (dBm)	MPR Allowed per 3GPP(dB)	
15	QPSK	1 RB	0	1857.5	26115	14.92	15.6	0	
				1882.5	26365	14.87	15.6	0	
				1907.5	26615	14.92	15.6	0	
			36	1857.5	26115	14.80	15.6	0	
				1882.5	26365	14.70	15.6	0	
				1907.5	26615	14.89	15.6	0	
			74	1857.5	26115	14.80	15.6	0	
				1882.5	26365	14.77	15.6	0	
				1907.5	26615	14.95	15.6	0	
		36 RB	0	1857.5	26115	13.86	14.6	0-1	
				1882.5	26365	13.81	14.6	0-1	
				1907.5	26615	14.05	14.6	0-1	
			18	1857.5	26115	13.81	14.6	0-1	
				1882.5	26365	13.78	14.6	0-1	
				1907.5	26615	14.13	14.6	0-1	
			37	1857.5	26115	13.73	14.6	0-1	
				1882.5	26365	13.72	14.6	0-1	
				1907.5	26615	14.05	14.6	0-1	
		75RB	1857.5	26115	13.77	14.6	0-1		
			1882.5	26365	13.77	14.6	0-1		
			1907.5	26615	14.08	14.6	0-1		
		16-QAM	1 RB	0	1857.5	26115	14.24	14.6	0-1
					1882.5	26365	14.15	14.6	0-1
					1907.5	26615	14.41	14.6	0-1
	36			1857.5	26115	14.14	14.6	0-1	
				1882.5	26365	14.06	14.6	0-1	
				1907.5	26615	14.33	14.6	0-1	
	74			1857.5	26115	14.14	14.6	0-1	
				1882.5	26365	14.06	14.6	0-1	
				1907.5	26615	14.36	14.6	0-1	
	36 RB			0	1857.5	26115	12.85	13.6	0-2
					1882.5	26365	12.76	13.6	0-2
					1907.5	26615	13.04	13.6	0-2
			18	1857.5	26115	12.84	13.6	0-2	
				1882.5	26365	12.74	13.6	0-2	
				1907.5	26615	13.08	13.6	0-2	
			37	1857.5	26115	12.78	13.6	0-2	
				1882.5	26365	12.70	13.6	0-2	
				1907.5	26615	13.06	13.6	0-2	
	75RB		1857.5	26115	12.83	13.6	0-2		
			1882.5	26365	12.77	13.6	0-2		
			1907.5	26615	13.11	13.6	0-2		

Unless otherwise stated the results shown in this test report refer only to the sample(s) tested and such sample(s) are retained for 90 days only.

除非另有說明，此報告結果僅對測試之樣品負責，同時此樣品僅保留90天。本報告未經本公司書面許可，不可部份複製。

This document is issued by the Company subject to its General Conditions of Service printed overleaf, available on request or accessible at www.sgs.com/terms_and_conditions.htm and for electronic format documents, subject to Terms and Conditions for Electronic Documents at www.sgs.com/terms_e-document.htm. Attention is drawn to the limitation of liability, indemnification and jurisdiction issues defined therein. Any holder of this document is advised that information contained hereon reflects the Company's findings at the time of its intervention only and within the limits of Client's instructions, if any. The Company's sole responsibility is to its Client and this document does not exonerate parties to a transaction from exercising all their rights and obligations under the transaction documents. This document cannot be reproduced except in full, without prior written approval of the Company. Any unauthorized alteration, forgery or falsification of the content or appearance of this document is unlawful and offenders may be prosecuted to the fullest extent of the law.

FDD Band 25								
BW(MHz)	Modulation	RB Size	RB Offset	Frequency (MHz)	Channel	Conducted power (dBm)	Target Power + Max. Tolerance (dBm)	MPR Allowed per 3GPP(dB)
15	64-QAM	1 RB	0	1857.5	26115	14.01	14.6	0-1
				1882.5	26365	13.89	14.6	0-1
				1907.5	26615	14.15	14.6	0-1
			36	1857.5	26115	13.89	14.6	0-1
				1882.5	26365	13.77	14.6	0-1
				1907.5	26615	14.06	14.6	0-1
			74	1857.5	26115	13.87	14.6	0-1
				1882.5	26365	13.82	14.6	0-1
				1907.5	26615	14.11	14.6	0-1
		36 RB	0	1857.5	26115	12.62	13.6	0-2
				1882.5	26365	12.53	13.6	0-2
				1907.5	26615	12.81	13.6	0-2
			18	1857.5	26115	12.54	13.6	0-2
				1882.5	26365	12.46	13.6	0-2
				1907.5	26615	12.81	13.6	0-2
			37	1857.5	26115	12.53	13.6	0-2
				1882.5	26365	12.46	13.6	0-2
				1907.5	26615	12.81	13.6	0-2
			75RB	1857.5	26115	12.53	13.6	0-2
				1882.5	26365	12.52	13.6	0-2
				1907.5	26615	12.86	13.6	0-2

Unless otherwise stated the results shown in this test report refer only to the sample(s) tested and such sample(s) are retained for 90 days only.

除非另有說明，此報告結果僅對測試之樣品負責，同時此樣品僅保留90天。本報告未經本公司書面許可，不可部份複製。

This document is issued by the Company subject to its General Conditions of Service printed overleaf, available on request or accessible at www.sgs.com/terms_and_conditions.htm and for electronic format documents, subject to Terms and Conditions for Electronic Documents at www.sgs.com/terms_e-document.htm. Attention is drawn to the limitation of liability, indemnification and jurisdiction issues defined therein. Any holder of this document is advised that information contained hereon reflects the Company's findings at the time of its intervention only and within the limits of Client's instructions, if any. The Company's sole responsibility is to its Client and this document does not exonerate parties to a transaction from exercising all their rights and obligations under the transaction documents. This document cannot be reproduced except in full, without prior written approval of the Company. Any unauthorized alteration, forgery or falsification of the content or appearance of this document is unlawful and offenders may be prosecuted to the fullest extent of the law.

FDD Band 25									
BW(Mhz)	Modulation	RB Size	RB Offset	Frequency (MHz)	Channel	Conducted power (dBm)	Target Power + Max. Tolerance (dBm)	MPR Allowed per 3GPP(dB)	
10	QPSK	1 RB	0	1855	26090	15.06	15.6	0	
				1882.5	26365	14.96	15.6	0	
				1910	26640	15.04	15.6	0	
			25	1855	26090	14.78	15.6	0	
				1882.5	26365	14.68	15.6	0	
				1910	26640	14.98	15.6	0	
			49	1855	26090	14.95	15.6	0	
				1882.5	26365	14.96	15.6	0	
				1910	26640	14.94	15.6	0	
		25 RB	0	1855	26090	13.86	14.6	0-1	
				1882.5	26365	13.77	14.6	0-1	
				1910	26640	14.08	14.6	0-1	
			12	1855	26090	13.78	14.6	0-1	
				1882.5	26365	13.69	14.6	0-1	
				1910	26640	14.05	14.6	0-1	
			25	1855	26090	13.75	14.6	0-1	
				1882.5	26365	13.74	14.6	0-1	
				1910	26640	14.05	14.6	0-1	
			50RB	1855	26090	13.80	14.6	0-1	
				1882.5	26365	13.75	14.6	0-1	
				1910	26640	14.07	14.6	0-1	
		16-QAM	1 RB	0	1855	26090	14.39	14.6	0-1
					1882.5	26365	14.34	14.6	0-1
					1910	26640	14.44	14.6	0-1
	25			1855	26090	14.07	14.6	0-1	
				1882.5	26365	14.00	14.6	0-1	
				1910	26640	14.32	14.6	0-1	
	49			1855	26090	14.17	14.6	0-1	
				1882.5	26365	14.30	14.6	0-1	
				1910	26640	14.31	14.6	0-1	
	25 RB			0	1855	26090	12.82	13.6	0-2
					1882.5	26365	12.75	13.6	0-2
					1910	26640	13.10	13.6	0-2
			12	1855	26090	12.82	13.6	0-2	
				1882.5	26365	12.78	13.6	0-2	
				1910	26640	13.08	13.6	0-2	
			25	1855	26090	12.79	13.6	0-2	
				1882.5	26365	12.74	13.6	0-2	
				1910	26640	13.04	13.6	0-2	
	50RB		1855	26090	12.84	13.6	0-2		
			1882.5	26365	12.78	13.6	0-2		
			1910	26640	13.04	13.6	0-2		

Unless otherwise stated the results shown in this test report refer only to the sample(s) tested and such sample(s) are retained for 90 days only.

除非另有說明，此報告結果僅對測試之樣品負責，同時此樣品僅保留90天。本報告未經本公司書面許可，不可部份複製。

This document is issued by the Company subject to its General Conditions of Service printed overleaf, available on request or accessible at www.sgs.com/terms_and_conditions.htm and for electronic format documents, subject to Terms and Conditions for Electronic Documents at www.sgs.com/terms_e-document.htm. Attention is drawn to the limitation of liability, indemnification and jurisdiction issues defined therein. Any holder of this document is advised that information contained hereon reflects the Company's findings at the time of its intervention only and within the limits of Client's instructions, if any. The Company's sole responsibility is to its Client and this document does not exonerate parties to a transaction from exercising all their rights and obligations under the transaction documents. This document cannot be reproduced except in full, without prior written approval of the Company. Any unauthorized alteration, forgery or falsification of the content or appearance of this document is unlawful and offenders may be prosecuted to the fullest extent of the law.

FDD Band 25								
BW(MHz)	Modulation	RB Size	RB Offset	Frequency (MHz)	Channel	Conducted power (dBm)	Target Power + Max. Tolerance (dBm)	MPR Allowed per 3GPP(dB)
10	64-QAM	1 RB	0	1855	26090	14.16	14.6	0-1
				1882.5	26365	14.06	14.6	0-1
				1910	26640	14.18	14.6	0-1
			25	1855	26090	13.85	14.6	0-1
				1882.5	26365	13.77	14.6	0-1
				1910	26640	14.09	14.6	0-1
			49	1855	26090	13.97	14.6	0-1
				1882.5	26365	14.06	14.6	0-1
				1910	26640	14.07	14.6	0-1
		25 RB	0	1855	26090	12.59	13.6	0-2
				1882.5	26365	12.53	13.6	0-2
				1910	26640	12.89	13.6	0-2
			12	1855	26090	12.61	13.6	0-2
				1882.5	26365	12.54	13.6	0-2
				1910	26640	12.84	13.6	0-2
			25	1855	26090	12.56	13.6	0-2
				1882.5	26365	12.46	13.6	0-2
				1910	26640	12.79	13.6	0-2
			50RB	1855	26090	12.61	13.6	0-2
				1882.5	26365	12.52	13.6	0-2
				1910	26640	12.82	13.6	0-2

Unless otherwise stated the results shown in this test report refer only to the sample(s) tested and such sample(s) are retained for 90 days only.

除非另有說明，此報告結果僅對測試之樣品負責，同時此樣品僅保留90天。本報告未經本公司書面許可，不可部份複製。

This document is issued by the Company subject to its General Conditions of Service printed overleaf, available on request or accessible at www.sgs.com/terms_and_conditions.htm and for electronic format documents, subject to Terms and Conditions for Electronic Documents at www.sgs.com/terms_e-document.htm. Attention is drawn to the limitation of liability, indemnification and jurisdiction issues defined therein. Any holder of this document is advised that information contained hereon reflects the Company's findings at the time of its intervention only and within the limits of Client's instructions, if any. The Company's sole responsibility is to its Client and this document does not exonerate parties to a transaction from exercising all their rights and obligations under the transaction documents. This document cannot be reproduced except in full, without prior written approval of the Company. Any unauthorized alteration, forgery or falsification of the content or appearance of this document is unlawful and offenders may be prosecuted to the fullest extent of the law.

FDD Band 25									
BW(Mhz)	Modulation	RB Size	RB Offset	Frequency (MHz)	Channel	Conducted power (dBm)	Target Power + Max. Tolerance (dBm)	MPR Allowed per 3GPP(dB)	
5	QPSK	1 RB	0	1852.5	26065	14.79	15.6	0	
				1882.5	26365	14.71	15.6	0	
				1912.5	26665	15.01	15.6	0	
			12	1852.5	26065	14.74	15.6	0	
				1882.5	26365	14.66	15.6	0	
				1912.5	26665	14.95	15.6	0	
		24	1852.5	26065	14.79	15.6	0		
			1882.5	26365	14.67	15.6	0		
			1912.5	26665	14.97	15.6	0		
		12 RB	0	1852.5	26065	13.82	14.6	0-1	
				1882.5	26365	13.70	14.6	0-1	
				1912.5	26665	14.00	14.6	0-1	
			6	1852.5	26065	13.78	14.6	0-1	
				1882.5	26365	13.74	14.6	0-1	
				1912.5	26665	14.04	14.6	0-1	
			13	1852.5	26065	13.79	14.6	0-1	
				1882.5	26365	13.66	14.6	0-1	
				1912.5	26665	13.97	14.6	0-1	
			25RB	1852.5	26065	13.76	14.6	0-1	
				1882.5	26365	13.71	14.6	0-1	
				1912.5	26665	14.02	14.6	0-1	
		16-QAM	1 RB	0	1852.5	26065	14.16	14.6	0-1
					1882.5	26365	14.10	14.6	0-1
					1912.5	26665	14.37	14.6	0-1
	12			1852.5	26065	14.06	14.6	0-1	
				1882.5	26365	14.03	14.6	0-1	
				1912.5	26665	14.28	14.6	0-1	
	24			1852.5	26065	14.06	14.6	0-1	
				1882.5	26365	14.00	14.6	0-1	
				1912.5	26665	14.30	14.6	0-1	
	12 RB			0	1852.5	26065	12.84	13.6	0-2
					1882.5	26365	12.72	13.6	0-2
					1912.5	26665	13.04	13.6	0-2
			6	1852.5	26065	12.84	13.6	0-2	
				1882.5	26365	12.72	13.6	0-2	
				1912.5	26665	13.04	13.6	0-2	
			13	1852.5	26065	12.76	13.6	0-2	
				1882.5	26365	12.65	13.6	0-2	
				1912.5	26665	13.02	13.6	0-2	
	25RB		1852.5	26065	12.81	13.6	0-2		
			1882.5	26365	12.67	13.6	0-2		
			1912.5	26665	13.02	13.6	0-2		

Unless otherwise stated the results shown in this test report refer only to the sample(s) tested and such sample(s) are retained for 90 days only.

除非另有說明，此報告結果僅對測試之樣品負責，同時此樣品僅保留90天。本報告未經本公司書面許可，不可部份複製。

This document is issued by the Company subject to its General Conditions of Service printed overleaf, available on request or accessible at www.sgs.com/terms_and_conditions.htm and for electronic format documents, subject to Terms and Conditions for Electronic Documents at www.sgs.com/terms_e-document.htm. Attention is drawn to the limitation of liability, indemnification and jurisdiction issues defined therein. Any holder of this document is advised that information contained hereon reflects the Company's findings at the time of its intervention only and within the limits of Client's instructions, if any. The Company's sole responsibility is to its Client and this document does not exonerate parties to a transaction from exercising all their rights and obligations under the transaction documents. This document cannot be reproduced except in full, without prior written approval of the Company. Any unauthorized alteration, forgery or falsification of the content or appearance of this document is unlawful and offenders may be prosecuted to the fullest extent of the law.

FDD Band 25								
BW(MHz)	Modulation	RB Size	RB Offset	Frequency (MHz)	Channel	Conducted power (dBm)	Target Power + Max. Tolerance (dBm)	MPR Allowed per 3GPP(dB)
5	64-QAM	1 RB	0	1852.5	26065	14.02	14.6	0-1
				1882.5	26365	13.89	14.6	0-1
				1912.5	26665	14.17	14.6	0-1
			12	1852.5	26065	13.91	14.6	0-1
				1882.5	26365	13.88	14.6	0-1
				1912.5	26665	14.08	14.6	0-1
			24	1852.5	26065	13.88	14.6	0-1
				1882.5	26365	13.79	14.6	0-1
				1912.5	26665	14.09	14.6	0-1
		12 RB	0	1852.5	26065	12.65	13.6	0-2
				1882.5	26365	12.55	13.6	0-2
				1912.5	26665	12.89	13.6	0-2
			6	1852.5	26065	12.66	13.6	0-2
				1882.5	26365	12.54	13.6	0-2
				1912.5	26665	12.87	13.6	0-2
			13	1852.5	26065	12.60	13.6	0-2
				1882.5	26365	12.49	13.6	0-2
				1912.5	26665	12.84	13.6	0-2
			25RB	1852.5	26065	12.63	13.6	0-2
				1882.5	26365	12.53	13.6	0-2
				1912.5	26665	12.85	13.6	0-2

Unless otherwise stated the results shown in this test report refer only to the sample(s) tested and such sample(s) are retained for 90 days only.

除非另有說明，此報告結果僅對測試之樣品負責，同時此樣品僅保留90天。本報告未經本公司書面許可，不可部份複製。

This document is issued by the Company subject to its General Conditions of Service printed overleaf, available on request or accessible at www.sgs.com/terms_and_conditions.htm and for electronic format documents, subject to Terms and Conditions for Electronic Documents at www.sgs.com/terms_e-document.htm. Attention is drawn to the limitation of liability, indemnification and jurisdiction issues defined therein. Any holder of this document is advised that information contained hereon reflects the Company's findings at the time of its intervention only and within the limits of Client's instructions, if any. The Company's sole responsibility is to its Client and this document does not exonerate parties to a transaction from exercising all their rights and obligations under the transaction documents. This document cannot be reproduced except in full, without prior written approval of the Company. Any unauthorized alteration, forgery or falsification of the content or appearance of this document is unlawful and offenders may be prosecuted to the fullest extent of the law.

FDD Band 25									
BW(Mhz)	Modulation	RB Size	RB Offset	Frequency (MHz)	Channel	Conducted power (dBm)	Target Power + Max. Tolerance (dBm)	MPR Allowed per 3GPP(dB)	
3	QPSK	1 RB	0	1851.5	26055	14.72	15.6	0	
				1882.5	26365	14.68	15.6	0	
				1913.5	26675	14.94	15.6	0	
			7	1851.5	26055	14.84	15.6	0	
				1882.5	26365	14.73	15.6	0	
				1913.5	26675	15.03	15.6	0	
			14	1851.5	26055	14.71	15.6	0	
				1882.5	26365	14.64	15.6	0	
				1913.5	26675	14.90	15.6	0	
		8 RB	0	1851.5	26055	13.75	14.6	0-1	
				1882.5	26365	13.72	14.6	0-1	
				1913.5	26675	13.96	14.6	0-1	
			4	1851.5	26055	13.81	14.6	0-1	
				1882.5	26365	13.73	14.6	0-1	
				1913.5	26675	14.01	14.6	0-1	
			7	1851.5	26055	13.77	14.6	0-1	
				1882.5	26365	13.68	14.6	0-1	
				1913.5	26675	14.01	14.6	0-1	
		15RB	1851.5	26055	13.80	14.6	0-1		
			1882.5	26365	13.69	14.6	0-1		
			1913.5	26675	14.00	14.6	0-1		
		16-QAM	1 RB	0	1851.5	26055	14.09	14.6	0-1
					1882.5	26365	14.08	14.6	0-1
					1913.5	26675	14.23	14.6	0-1
	7			1851.5	26055	14.14	14.6	0-1	
				1882.5	26365	14.14	14.6	0-1	
				1913.5	26675	14.42	14.6	0-1	
	14			1851.5	26055	14.03	14.6	0-1	
				1882.5	26365	13.97	14.6	0-1	
				1913.5	26675	14.24	14.6	0-1	
	8 RB		0	1851.5	26055	12.84	13.6	0-2	
				1882.5	26365	12.78	13.6	0-2	
				1913.5	26675	13.07	13.6	0-2	
			4	1851.5	26055	12.83	13.6	0-2	
				1882.5	26365	12.80	13.6	0-2	
				1913.5	26675	13.07	13.6	0-2	
			7	1851.5	26055	12.77	13.6	0-2	
				1882.5	26365	12.75	13.6	0-2	
				1913.5	26675	13.03	13.6	0-2	
	15RB		1851.5	26055	12.82	13.6	0-2		
			1882.5	26365	12.72	13.6	0-2		
			1913.5	26675	13.03	13.6	0-2		

Unless otherwise stated the results shown in this test report refer only to the sample(s) tested and such sample(s) are retained for 90 days only.

除非另有說明，此報告結果僅對測試之樣品負責，同時此樣品僅保留90天。本報告未經本公司書面許可，不可部份複製。

This document is issued by the Company subject to its General Conditions of Service printed overleaf, available on request or accessible at www.sgs.com/terms_and_conditions.htm and for electronic format documents, subject to Terms and Conditions for Electronic Documents at www.sgs.com/terms_e-document.htm. Attention is drawn to the limitation of liability, indemnification and jurisdiction issues defined therein. Any holder of this document is advised that information contained hereon reflects the Company's findings at the time of its intervention only and within the limits of Client's instructions, if any. The Company's sole responsibility is to its Client and this document does not exonerate parties to a transaction from exercising all their rights and obligations under the transaction documents. This document cannot be reproduced except in full, without prior written approval of the Company. Any unauthorized alteration, forgery or falsification of the content or appearance of this document is unlawful and offenders may be prosecuted to the fullest extent of the law.

FDD Band 25								
BW(Mhz)	Modulation	RB Size	RB Offset	Frequency (MHz)	Channel	Conducted power (dBm)	Target Power + Max. Tolerance (dBm)	MPR Allowed per 3GPP(dB)
3	64-QAM	1 RB	0	1851.5	26055	13.86	14.6	0-1
				1882.5	26365	13.82	14.6	0-1
				1913.5	26675	14.01	14.6	0-1
			7	1851.5	26055	13.88	14.6	0-1
				1882.5	26365	13.91	14.6	0-1
				1913.5	26675	14.14	14.6	0-1
			14	1851.5	26055	13.77	14.6	0-1
				1882.5	26365	13.69	14.6	0-1
				1913.5	26675	14.00	14.6	0-1
		8 RB	0	1851.5	26055	12.59	13.6	0-2
				1882.5	26365	12.54	13.6	0-2
				1913.5	26675	12.82	13.6	0-2
			4	1851.5	26055	12.60	13.6	0-2
				1882.5	26365	12.51	13.6	0-2
				1913.5	26675	12.82	13.6	0-2
			7	1851.5	26055	12.56	13.6	0-2
				1882.5	26365	12.46	13.6	0-2
				1913.5	26675	12.81	13.6	0-2
		15RB	1851.5	26055	12.56	13.6	0-2	
			1882.5	26365	12.46	13.6	0-2	
			1913.5	26675	12.76	13.6	0-2	

Unless otherwise stated the results shown in this test report refer only to the sample(s) tested and such sample(s) are retained for 90 days only.

除非另有說明，此報告結果僅對測試之樣品負責，同時此樣品僅保留90天。本報告未經本公司書面許可，不可部份複製。

This document is issued by the Company subject to its General Conditions of Service printed overleaf, available on request or accessible at www.sgs.com/terms_and_conditions.htm and for electronic format documents, subject to Terms and Conditions for Electronic Documents at www.sgs.com/terms_e-document.htm. Attention is drawn to the limitation of liability, indemnification and jurisdiction issues defined therein. Any holder of this document is advised that information contained hereon reflects the Company's findings at the time of its intervention only and within the limits of Client's instructions, if any. The Company's sole responsibility is to its Client and this document does not exonerate parties to a transaction from exercising all their rights and obligations under the transaction documents. This document cannot be reproduced except in full, without prior written approval of the Company. Any unauthorized alteration, forgery or falsification of the content or appearance of this document is unlawful and offenders may be prosecuted to the fullest extent of the law.

FDD Band 25									
BW(Mhz)	Modulation	RB Size	RB Offset	Frequency (MHz)	Channel	Conducted power (dBm)	Target Power + Max. Tolerance (dBm)	MPR Allowed per 3GPP(dB)	
1.4	QPSK	1 RB	0	1850.7	26047	14.71	15.6	0	
				1882.5	26365	14.87	15.6	0	
				1914.3	26683	14.85	15.6	0	
			2	1850.7	26047	14.77	15.6	0	
				1882.5	26365	14.93	15.6	0	
				1914.3	26683	14.95	15.6	0	
			5	1850.7	26047	14.74	15.6	0	
				1882.5	26365	14.88	15.6	0	
				1914.3	26683	14.90	15.6	0	
		3 RB	0	1850.7	26047	14.30	14.6	0-1	
				1882.5	26365	14.47	14.6	0-1	
				1914.3	26683	14.52	14.6	0-1	
			2	1850.7	26047	14.38	14.6	0-1	
				1882.5	26365	14.54	14.6	0-1	
				1914.3	26683	14.56	14.6	0-1	
			3	1850.7	26047	14.35	14.6	0-1	
				1882.5	26365	14.49	14.6	0-1	
				1914.3	26683	14.51	14.6	0-1	
		6RB	1850.7	26047	13.70	14.6	0-1		
			1882.5	26365	13.87	14.6	0-1		
			1914.3	26683	13.95	14.6	0-1		
		16-QAM	1 RB	0	1850.7	26047	14.04	14.6	0-1
					1882.5	26365	14.18	14.6	0-1
					1914.3	26683	14.19	14.6	0-1
	2			1850.7	26047	14.17	14.6	0-1	
				1882.5	26365	14.21	14.6	0-1	
				1914.3	26683	14.29	14.6	0-1	
	5			1850.7	26047	13.97	14.6	0-1	
				1882.5	26365	14.12	14.6	0-1	
				1914.3	26683	14.14	14.6	0-1	
	3 RB			0	1850.7	26047	13.38	13.6	0-2
					1882.5	26365	13.51	13.6	0-2
					1914.3	26683	13.53	13.6	0-2
			2	1850.7	26047	13.39	13.6	0-2	
				1882.5	26365	13.50	13.6	0-2	
				1914.3	26683	13.58	13.6	0-2	
			3	1850.7	26047	13.34	13.6	0-2	
				1882.5	26365	13.48	13.6	0-2	
				1914.3	26683	13.57	13.6	0-2	
	6RB		1850.7	26047	12.76	13.6	0-2		
			1882.5	26365	12.94	13.6	0-2		
			1914.3	26683	12.99	13.6	0-2		

Unless otherwise stated the results shown in this test report refer only to the sample(s) tested and such sample(s) are retained for 90 days only.

除非另有說明，此報告結果僅對測試之樣品負責，同時此樣品僅保留90天。本報告未經本公司書面許可，不可部份複製。

This document is issued by the Company subject to its General Conditions of Service printed overleaf, available on request or accessible at www.sgs.com/terms_and_conditions.htm and for electronic format documents, subject to Terms and Conditions for Electronic Documents at www.sgs.com/terms_e-document.htm. Attention is drawn to the limitation of liability, indemnification and jurisdiction issues defined therein. Any holder of this document is advised that information contained hereon reflects the Company's findings at the time of its intervention only and within the limits of Client's instructions, if any. The Company's sole responsibility is to its Client and this document does not exonerate parties to a transaction from exercising all their rights and obligations under the transaction documents. This document cannot be reproduced except in full, without prior written approval of the Company. Any unauthorized alteration, forgery or falsification of the content or appearance of this document is unlawful and offenders may be prosecuted to the fullest extent of the law.

FDD Band 25								
BW(MHz)	Modulation	RB Size	RB Offset	Frequency (MHz)	Channel	Conducted power (dBm)	Target Power + Max. Tolerance (dBm)	MPR Allowed per 3GPP(dB)
1.4	64-QAM	1 RB	0	1850.7	26047	13.82	14.6	0-1
				1882.5	26365	13.93	14.6	0-1
				1914.3	26683	13.99	14.6	0-1
			2	1850.7	26047	13.94	14.6	0-1
				1882.5	26365	14.00	14.6	0-1
				1914.3	26683	14.06	14.6	0-1
			5	1850.7	26047	13.77	14.6	0-1
				1882.5	26365	13.92	14.6	0-1
				1914.3	26683	13.94	14.6	0-1
		3 RB	0	1850.7	26047	13.16	13.6	0-2
				1882.5	26365	13.28	13.6	0-2
				1914.3	26683	13.34	13.6	0-2
			2	1850.7	26047	13.18	13.6	0-2
				1882.5	26365	13.28	13.6	0-2
				1914.3	26683	13.34	13.6	0-2
			3	1850.7	26047	13.16	13.6	0-2
				1882.5	26365	13.26	13.6	0-2
				1914.3	26683	13.36	13.6	0-2
			6RB	1850.7	26047	12.56	13.6	0-2
				1882.5	26365	12.71	13.6	0-2
				1914.3	26683	12.82	13.6	0-2

Unless otherwise stated the results shown in this test report refer only to the sample(s) tested and such sample(s) are retained for 90 days only.

除非另有說明，此報告結果僅對測試之樣品負責，同時此樣品僅保留90天。本報告未經本公司書面許可，不可部份複製。

This document is issued by the Company subject to its General Conditions of Service printed overleaf, available on request or accessible at www.sgs.com/terms_and_conditions.htm and for electronic format documents, subject to Terms and Conditions for Electronic Documents at www.sgs.com/terms_e-document.htm. Attention is drawn to the limitation of liability, indemnification and jurisdiction issues defined therein. Any holder of this document is advised that information contained hereon reflects the Company's findings at the time of its intervention only and within the limits of Client's instructions, if any. The Company's sole responsibility is to its Client and this document does not exonerate parties to a transaction from exercising all their rights and obligations under the transaction documents. This document cannot be reproduced except in full, without prior written approval of the Company. Any unauthorized alteration, forgery or falsification of the content or appearance of this document is unlawful and offenders may be prosecuted to the fullest extent of the law.

FDD Band 26									
BW(Mhz)	Modulation	RB Size	RB Offset	Frequency (MHz)	Channel	Conducted power (dBm)	Target Power + Max. Tolerance (dBm)	MPR Allowed per 3GPP(dB)	
15	QPSK	1 RB	0	821.5	26765	19.52	20	0	
				831.5	26865	19.51	20	0	
				841.5	26965	19.59	20	0	
			36	821.5	26765	19.57	20	0	
				831.5	26865	19.55	20	0	
				841.5	26965	19.62	20	0	
			74	821.5	26765	19.56	20	0	
				831.5	26865	19.53	20	0	
				841.5	26965	19.46	20	0	
		36 RB	0	821.5	26765	18.68	19	0-1	
				831.5	26865	18.65	19	0-1	
				841.5	26965	18.65	19	0-1	
			18	821.5	26765	18.70	19	0-1	
				831.5	26865	18.66	19	0-1	
				841.5	26965	18.62	19	0-1	
			37	821.5	26765	18.62	19	0-1	
				831.5	26865	18.69	19	0-1	
				841.5	26965	18.62	19	0-1	
		75RB	821.5	26765	18.66	19	0-1		
			831.5	26865	18.60	19	0-1		
			841.5	26965	18.71	19	0-1		
		16-QAM	1 RB	0	821.5	26765	18.86	19	0-1
					831.5	26865	18.80	19	0-1
					841.5	26965	18.89	19	0-1
	36			821.5	26765	18.86	19	0-1	
				831.5	26865	18.88	19	0-1	
				841.5	26965	18.93	19	0-1	
	74			821.5	26765	18.90	19	0-1	
				831.5	26865	18.79	19	0-1	
				841.5	26965	18.75	19	0-1	
	36 RB			0	821.5	26765	17.69	18	0-2
					831.5	26865	17.67	18	0-2
					841.5	26965	17.66	18	0-2
			18	821.5	26765	17.70	18	0-2	
				831.5	26865	17.67	18	0-2	
				841.5	26965	17.63	18	0-2	
			37	821.5	26765	17.64	18	0-2	
				831.5	26865	17.68	18	0-2	
				841.5	26965	17.65	18	0-2	
	75RB		821.5	26765	17.68	18	0-2		
			831.5	26865	17.60	18	0-2		
			841.5	26965	17.71	18	0-2		

Unless otherwise stated the results shown in this test report refer only to the sample(s) tested and such sample(s) are retained for 90 days only.

除非另有說明，此報告結果僅對測試之樣品負責，同時此樣品僅保留90天。本報告未經本公司書面許可，不可部份複製。

This document is issued by the Company subject to its General Conditions of Service printed overleaf, available on request or accessible at www.sgs.com/terms_and_conditions.htm and for electronic format documents, subject to Terms and Conditions for Electronic Documents at www.sgs.com/terms_e-document.htm. Attention is drawn to the limitation of liability, indemnification and jurisdiction issues defined therein. Any holder of this document is advised that information contained hereon reflects the Company's findings at the time of its intervention only and within the limits of Client's instructions, if any. The Company's sole responsibility is to its Client and this document does not exonerate parties to a transaction from exercising all their rights and obligations under the transaction documents. This document cannot be reproduced except in full, without prior written approval of the Company. Any unauthorized alteration, forgery or falsification of the content or appearance of this document is unlawful and offenders may be prosecuted to the fullest extent of the law.

FDD Band 26								
BW(MHz)	Modulation	RB Size	RB Offset	Frequency (MHz)	Channel	Conducted power (dBm)	Target Power + Max. Tolerance (dBm)	MPR Allowed per 3GPP(dB)
15	64-QAM	1 RB	0	821.5	26765	18.54	19	0-1
				831.5	26865	18.48	19	0-1
				841.5	26965	18.57	19	0-1
			36	821.5	26765	18.54	19	0-1
				831.5	26865	18.56	19	0-1
				841.5	26965	18.61	19	0-1
			74	821.5	26765	18.58	19	0-1
				831.5	26865	18.47	19	0-1
				841.5	26965	18.43	19	0-1
		36 RB	0	821.5	26765	17.37	18	0-2
				831.5	26865	17.35	18	0-2
				841.5	26965	17.34	18	0-2
			18	821.5	26765	17.38	18	0-2
				831.5	26865	17.35	18	0-2
				841.5	26965	17.31	18	0-2
			37	821.5	26765	17.32	18	0-2
				831.5	26865	17.36	18	0-2
				841.5	26965	17.33	18	0-2
			75RB	821.5	26765	17.36	18	0-2
				831.5	26865	17.28	18	0-2
				841.5	26965	17.39	18	0-2

Unless otherwise stated the results shown in this test report refer only to the sample(s) tested and such sample(s) are retained for 90 days only.

除非另有說明，此報告結果僅對測試之樣品負責，同時此樣品僅保留90天。本報告未經本公司書面許可，不可部份複製。

This document is issued by the Company subject to its General Conditions of Service printed overleaf, available on request or accessible at www.sgs.com/terms_and_conditions.htm and for electronic format documents, subject to Terms and Conditions for Electronic Documents at www.sgs.com/terms_e-document.htm. Attention is drawn to the limitation of liability, indemnification and jurisdiction issues defined therein. Any holder of this document is advised that information contained hereon reflects the Company's findings at the time of its intervention only and within the limits of Client's instructions, if any. The Company's sole responsibility is to its Client and this document does not exonerate parties to a transaction from exercising all their rights and obligations under the transaction documents. This document cannot be reproduced except in full, without prior written approval of the Company. Any unauthorized alteration, forgery or falsification of the content or appearance of this document is unlawful and offenders may be prosecuted to the fullest extent of the law.

FDD Band 26									
BW(Mhz)	Modulation	RB Size	RB Offset	Frequency (MHz)	Channel	Conducted power (dBm)	Target Power + Max. Tolerance (dBm)	MPR Allowed per 3GPP(dB)	
10	QPSK	1 RB	0	819	26740	19.41	20	0	
				831.5	26865	19.35	20	0	
				844	26990	19.54	20	0	
			25	819	26740	19.54	20	0	
				831.5	26865	19.50	20	0	
				844	26990	19.48	20	0	
		49	819	26740	19.36	20	0		
			831.5	26865	19.46	20	0		
			844	26990	19.26	20	0		
		25 RB	0	819	26740	18.66	19	0-1	
				831.5	26865	18.56	19	0-1	
				844	26990	18.61	19	0-1	
			12	819	26740	18.62	19	0-1	
				831.5	26865	18.47	19	0-1	
				844	26990	18.54	19	0-1	
			25	819	26740	18.50	19	0-1	
				831.5	26865	18.65	19	0-1	
				844	26990	18.56	19	0-1	
			50RB	819	26740	18.49	19	0-1	
				831.5	26865	18.60	19	0-1	
				844	26990	18.52	19	0-1	
		16-QAM	1 RB	0	819	26740	18.70	19	0-1
					831.5	26865	18.62	19	0-1
					844	26990	18.69	19	0-1
	25			819	26740	18.80	19	0-1	
				831.5	26865	18.72	19	0-1	
				844	26990	18.79	19	0-1	
	49			819	26740	18.85	19	0-1	
				831.5	26865	18.73	19	0-1	
				844	26990	18.71	19	0-1	
	25 RB			0	819	26740	17.56	18	0-2
					831.5	26865	17.62	18	0-2
					844	26990	17.59	18	0-2
			12	819	26740	17.52	18	0-2	
				831.5	26865	17.61	18	0-2	
				844	26990	17.58	18	0-2	
			25	819	26740	17.51	18	0-2	
				831.5	26865	17.57	18	0-2	
				844	26990	17.54	18	0-2	
	50RB		819	26740	17.53	18	0-2		
			831.5	26865	17.58	18	0-2		
			844	26990	17.64	18	0-2		

Unless otherwise stated the results shown in this test report refer only to the sample(s) tested and such sample(s) are retained for 90 days only.

除非另有說明，此報告結果僅對測試之樣品負責，同時此樣品僅保留90天。本報告未經本公司書面許可，不可部份複製。

This document is issued by the Company subject to its General Conditions of Service printed overleaf, available on request or accessible at www.sgs.com/terms_and_conditions.htm and for electronic format documents, subject to Terms and Conditions for Electronic Documents at www.sgs.com/terms_e-document.htm. Attention is drawn to the limitation of liability, indemnification and jurisdiction issues defined therein. Any holder of this document is advised that information contained hereon reflects the Company's findings at the time of its intervention only and within the limits of Client's instructions, if any. The Company's sole responsibility is to its Client and this document does not exonerate parties to a transaction from exercising all their rights and obligations under the transaction documents. This document cannot be reproduced except in full, without prior written approval of the Company. Any unauthorized alteration, forgery or falsification of the content or appearance of this document is unlawful and offenders may be prosecuted to the fullest extent of the law.

FDD Band 26								
BW(MHz)	Modulation	RB Size	RB Offset	Frequency (MHz)	Channel	Conducted power (dBm)	Target Power + Max. Tolerance (dBm)	MPR Allowed per 3GPP(dB)
10	64-QAM	1 RB	0	819	26740	18.50	19	0-1
				831.5	26865	18.37	19	0-1
				844	26990	18.42	19	0-1
			25	819	26740	18.35	19	0-1
				831.5	26865	18.37	19	0-1
				844	26990	18.41	19	0-1
			49	819	26740	18.40	19	0-1
				831.5	26865	18.40	19	0-1
				844	26990	18.36	19	0-1
		25 RB	0	819	26740	17.29	18	0-2
				831.5	26865	17.20	18	0-2
				844	26990	17.29	18	0-2
			12	819	26740	17.19	18	0-2
				831.5	26865	17.18	18	0-2
				844	26990	17.14	18	0-2
			25	819	26740	17.32	18	0-2
				831.5	26865	17.32	18	0-2
				844	26990	17.27	18	0-2
			50RB	819	26740	17.23	18	0-2
				831.5	26865	17.25	18	0-2
				844	26990	17.39	18	0-2

Unless otherwise stated the results shown in this test report refer only to the sample(s) tested and such sample(s) are retained for 90 days only.

除非另有說明，此報告結果僅對測試之樣品負責，同時此樣品僅保留90天。本報告未經本公司書面許可，不可部份複製。

This document is issued by the Company subject to its General Conditions of Service printed overleaf, available on request or accessible at www.sgs.com/terms_and_conditions.htm and for electronic format documents, subject to Terms and Conditions for Electronic Documents at www.sgs.com/terms_e-document.htm. Attention is drawn to the limitation of liability, indemnification and jurisdiction issues defined therein. Any holder of this document is advised that information contained hereon reflects the Company's findings at the time of its intervention only and within the limits of Client's instructions, if any. The Company's sole responsibility is to its Client and this document does not exonerate parties to a transaction from exercising all their rights and obligations under the transaction documents. This document cannot be reproduced except in full, without prior written approval of the Company. Any unauthorized alteration, forgery or falsification of the content or appearance of this document is unlawful and offenders may be prosecuted to the fullest extent of the law.

FDD Band 26									
BW(Mhz)	Modulation	RB Size	RB Offset	Frequency (MHz)	Channel	Conducted power (dBm)	Target Power + Max. Tolerance (dBm)	MPR Allowed per 3GPP(dB)	
5	QPSK	1 RB	0	816.5	26715	19.43	20	0	
				831.5	26865	19.42	20	0	
				846.5	27015	19.49	20	0	
			12	816.5	26715	19.53	20	0	
				831.5	26865	19.50	20	0	
				846.5	27015	19.49	20	0	
		24	816.5	26715	19.39	20	0		
			831.5	26865	19.42	20	0		
			846.5	27015	19.42	20	0		
		12 RB	0	816.5	26715	18.59	19	0-1	
				831.5	26865	18.59	19	0-1	
				846.5	27015	18.55	19	0-1	
			6	816.5	26715	18.67	19	0-1	
				831.5	26865	18.61	19	0-1	
				846.5	27015	18.58	19	0-1	
			13	816.5	26715	18.60	19	0-1	
				831.5	26865	18.50	19	0-1	
				846.5	27015	18.61	19	0-1	
		25RB	816.5	26715	18.64	19	0-1		
			831.5	26865	18.59	19	0-1		
			846.5	27015	18.66	19	0-1		
		16-QAM	1 RB	0	816.5	26715	18.85	19	0-1
					831.5	26865	18.74	19	0-1
					846.5	27015	18.71	19	0-1
	12			816.5	26715	18.80	19	0-1	
				831.5	26865	18.85	19	0-1	
				846.5	27015	18.79	19	0-1	
	24			816.5	26715	18.82	19	0-1	
				831.5	26865	18.69	19	0-1	
				846.5	27015	18.55	19	0-1	
	12 RB			0	816.5	26715	17.55	18	0-2
					831.5	26865	17.51	18	0-2
					846.5	27015	17.48	18	0-2
			6	816.5	26715	17.52	18	0-2	
				831.5	26865	17.56	18	0-2	
				846.5	27015	17.49	18	0-2	
			13	816.5	26715	17.50	18	0-2	
				831.5	26865	17.48	18	0-2	
				846.5	27015	17.46	18	0-2	
	25RB		816.5	26715	17.55	18	0-2		
			831.5	26865	17.53	18	0-2		
			846.5	27015	17.67	18	0-2		

Unless otherwise stated the results shown in this test report refer only to the sample(s) tested and such sample(s) are retained for 90 days only.

除非另有說明，此報告結果僅對測試之樣品負責，同時此樣品僅保留90天。本報告未經本公司書面許可，不可部份複製。

This document is issued by the Company subject to its General Conditions of Service printed overleaf, available on request or accessible at www.sgs.com/terms_and_conditions.htm and for electronic format documents, subject to Terms and Conditions for Electronic Documents at www.sgs.com/terms_e-document.htm. Attention is drawn to the limitation of liability, indemnification and jurisdiction issues defined therein. Any holder of this document is advised that information contained hereon reflects the Company's findings at the time of its intervention only and within the limits of Client's instructions, if any. The Company's sole responsibility is to its Client and this document does not exonerate parties to a transaction from exercising all their rights and obligations under the transaction documents. This document cannot be reproduced except in full, without prior written approval of the Company. Any unauthorized alteration, forgery or falsification of the content or appearance of this document is unlawful and offenders may be prosecuted to the fullest extent of the law.

FDD Band 26								
BW(Mhz)	Modulation	RB Size	RB Offset	Frequency (MHz)	Channel	Conducted power (dBm)	Target Power + Max. Tolerance (dBm)	MPR Allowed per 3GPP(dB)
5	64-QAM	1 RB	0	816.5	26715	18.53	19	0-1
				831.5	26865	18.29	19	0-1
				846.5	27015	18.52	19	0-1
			12	816.5	26715	18.43	19	0-1
				831.5	26865	18.55	19	0-1
				846.5	27015	18.49	19	0-1
			24	816.5	26715	18.43	19	0-1
				831.5	26865	18.30	19	0-1
				846.5	27015	18.29	19	0-1
		12 RB	0	816.5	26715	17.33	18	0-2
				831.5	26865	17.25	18	0-2
				846.5	27015	17.30	18	0-2
			6	816.5	26715	17.20	18	0-2
				831.5	26865	17.30	18	0-2
				846.5	27015	17.21	18	0-2
			13	816.5	26715	17.19	18	0-2
				831.5	26865	17.22	18	0-2
				846.5	27015	17.26	18	0-2
			25RB	816.5	26715	17.25	18	0-2
				831.5	26865	17.18	18	0-2
				846.5	27015	17.36	18	0-2

Unless otherwise stated the results shown in this test report refer only to the sample(s) tested and such sample(s) are retained for 90 days only.

除非另有說明，此報告結果僅對測試之樣品負責，同時此樣品僅保留90天。本報告未經本公司書面許可，不可部份複製。

This document is issued by the Company subject to its General Conditions of Service printed overleaf, available on request or accessible at www.sgs.com/terms_and_conditions.htm and for electronic format documents, subject to Terms and Conditions for Electronic Documents at www.sgs.com/terms_e-document.htm. Attention is drawn to the limitation of liability, indemnification and jurisdiction issues defined therein. Any holder of this document is advised that information contained hereon reflects the Company's findings at the time of its intervention only and within the limits of Client's instructions, if any. The Company's sole responsibility is to its Client and this document does not exonerate parties to a transaction from exercising all their rights and obligations under the transaction documents. This document cannot be reproduced except in full, without prior written approval of the Company. Any unauthorized alteration, forgery or falsification of the content or appearance of this document is unlawful and offenders may be prosecuted to the fullest extent of the law.

FDD Band 26									
BW(Mhz)	Modulation	RB Size	RB Offset	Frequency (MHz)	Channel	Conducted power (dBm)	Target Power + Max. Tolerance (dBm)	MPR Allowed per 3GPP(dB)	
3	QPSK	1 RB	0	815.5	26705	19.49	20	0	
				831.5	26865	19.36	20	0	
				847.5	27025	19.57	20	0	
			7	815.5	26705	19.48	20	0	
				831.5	26865	19.47	20	0	
				847.5	27025	19.59	20	0	
		14	815.5	26705	19.39	20	0		
			831.5	26865	19.51	20	0		
			847.5	27025	19.45	20	0		
		8 RB	0	815.5	26705	18.54	19	0-1	
				831.5	26865	18.53	19	0-1	
				847.5	27025	18.50	19	0-1	
			4	815.5	26705	18.68	19	0-1	
				831.5	26865	18.58	19	0-1	
				847.5	27025	18.45	19	0-1	
			7	815.5	26705	18.48	19	0-1	
				831.5	26865	18.63	19	0-1	
				847.5	27025	18.62	19	0-1	
		15RB	815.5	26705	18.48	19	0-1		
			831.5	26865	18.49	19	0-1		
			847.5	27025	18.69	19	0-1		
	16-QAM	1 RB	0	815.5	26705	18.68	19	0-1	
				831.5	26865	18.66	19	0-1	
				847.5	27025	18.81	19	0-1	
			7	815.5	26705	18.74	19	0-1	
				831.5	26865	18.71	19	0-1	
				847.5	27025	18.74	19	0-1	
			14	815.5	26705	18.73	19	0-1	
				831.5	26865	18.64	19	0-1	
				847.5	27025	18.56	19	0-1	
			8 RB	0	815.5	26705	17.55	18	0-2
					831.5	26865	17.65	18	0-2
					847.5	27025	17.66	18	0-2
		4		815.5	26705	17.57	18	0-2	
				831.5	26865	17.57	18	0-2	
				847.5	27025	17.44	18	0-2	
		7		815.5	26705	17.46	18	0-2	
				831.5	26865	17.50	18	0-2	
				847.5	27025	17.58	18	0-2	
		15RB	815.5	26705	17.56	18	0-2		
			831.5	26865	17.52	18	0-2		
			847.5	27025	17.56	18	0-2		

Unless otherwise stated the results shown in this test report refer only to the sample(s) tested and such sample(s) are retained for 90 days only.

除非另有說明，此報告結果僅對測試之樣品負責，同時此樣品僅保留90天。本報告未經本公司書面許可，不可部份複製。

This document is issued by the Company subject to its General Conditions of Service printed overleaf, available on request or accessible at www.sgs.com/terms_and_conditions.htm and for electronic format documents, subject to Terms and Conditions for Electronic Documents at www.sgs.com/terms_e-document.htm. Attention is drawn to the limitation of liability, indemnification and jurisdiction issues defined therein. Any holder of this document is advised that information contained hereon reflects the Company's findings at the time of its intervention only and within the limits of Client's instructions, if any. The Company's sole responsibility is to its Client and this document does not exonerate parties to a transaction from exercising all their rights and obligations under the transaction documents. This document cannot be reproduced except in full, without prior written approval of the Company. Any unauthorized alteration, forgery or falsification of the content or appearance of this document is unlawful and offenders may be prosecuted to the fullest extent of the law.

FDD Band 26								
BW(MHz)	Modulation	RB Size	RB Offset	Frequency (MHz)	Channel	Conducted power (dBm)	Target Power + Max. Tolerance (dBm)	MPR Allowed per 3GPP(dB)
3	64-QAM	1 RB	0	815.5	26705	18.50	19	0-1
				831.5	26865	18.29	19	0-1
				847.5	27025	18.49	19	0-1
			7	815.5	26705	18.45	19	0-1
				831.5	26865	18.47	19	0-1
				847.5	27025	18.45	19	0-1
			14	815.5	26705	18.53	19	0-1
				831.5	26865	18.33	19	0-1
				847.5	27025	18.36	19	0-1
		8 RB	0	815.5	26705	17.29	18	0-2
				831.5	26865	17.25	18	0-2
				847.5	27025	17.24	18	0-2
			4	815.5	26705	17.22	18	0-2
				831.5	26865	17.16	18	0-2
				847.5	27025	17.24	18	0-2
			7	815.5	26705	17.19	18	0-2
				831.5	26865	17.23	18	0-2
				847.5	27025	17.33	18	0-2
		15RB	815.5	26705	17.20	18	0-2	
			831.5	26865	17.09	18	0-2	
			847.5	27025	17.20	18	0-2	

Unless otherwise stated the results shown in this test report refer only to the sample(s) tested and such sample(s) are retained for 90 days only.

除非另有說明，此報告結果僅對測試之樣品負責，同時此樣品僅保留90天。本報告未經本公司書面許可，不可部份複製。

This document is issued by the Company subject to its General Conditions of Service printed overleaf, available on request or accessible at www.sgs.com/terms_and_conditions.htm and for electronic format documents, subject to Terms and Conditions for Electronic Documents at www.sgs.com/terms_e-document.htm. Attention is drawn to the limitation of liability, indemnification and jurisdiction issues defined therein. Any holder of this document is advised that information contained hereon reflects the Company's findings at the time of its intervention only and within the limits of Client's instructions, if any. The Company's sole responsibility is to its Client and this document does not exonerate parties to a transaction from exercising all their rights and obligations under the transaction documents. This document cannot be reproduced except in full, without prior written approval of the Company. Any unauthorized alteration, forgery or falsification of the content or appearance of this document is unlawful and offenders may be prosecuted to the fullest extent of the law.

FDD Band 26									
BW(Mhz)	Modulation	RB Size	RB Offset	Frequency (MHz)	Channel	Conducted power (dBm)	Target Power + Max. Tolerance (dBm)	MPR Allowed per 3GPP(dB)	
1.4	QPSK	1 RB	0	814.7	26697	19.49	20	0	
				831.5	26865	19.32	20	0	
				848.3	27033	19.54	20	0	
			2	814.7	26697	19.45	20	0	
				831.5	26865	19.52	20	0	
				848.3	27033	19.54	20	0	
		5	814.7	26697	19.38	20	0		
			831.5	26865	19.36	20	0		
			848.3	27033	19.29	20	0		
		3 RB	0	814.7	26697	18.63	19	0-1	
				831.5	26865	18.65	19	0-1	
				848.3	27033	18.54	19	0-1	
			2	814.7	26697	18.55	19	0-1	
				831.5	26865	18.65	19	0-1	
				848.3	27033	18.56	19	0-1	
			3	814.7	26697	18.45	19	0-1	
				831.5	26865	18.55	19	0-1	
				848.3	27033	18.48	19	0-1	
		6RB	814.7	26697	18.59	19	0-1		
			831.5	26865	18.44	19	0-1		
			848.3	27033	18.59	19	0-1		
		16-QAM	1 RB	0	814.7	26697	18.78	19	0-1
					831.5	26865	18.65	19	0-1
					848.3	27033	18.70	19	0-1
	2			814.7	26697	18.69	19	0-1	
				831.5	26865	18.83	19	0-1	
				848.3	27033	18.85	19	0-1	
	5			814.7	26697	18.76	19	0-1	
				831.5	26865	18.66	19	0-1	
				848.3	27033	18.67	19	0-1	
	3 RB			0	814.7	26697	17.52	18	0-2
					831.5	26865	17.50	18	0-2
					848.3	27033	17.66	18	0-2
			2	814.7	26697	17.66	18	0-2	
				831.5	26865	17.53	18	0-2	
				848.3	27033	17.53	18	0-2	
			3	814.7	26697	17.60	18	0-2	
				831.5	26865	17.57	18	0-2	
				848.3	27033	17.59	18	0-2	
	6RB		814.7	26697	17.62	18	0-2		
			831.5	26865	17.43	18	0-2		
			848.3	27033	17.57	18	0-2		

Unless otherwise stated the results shown in this test report refer only to the sample(s) tested and such sample(s) are retained for 90 days only.

除非另有說明，此報告結果僅對測試之樣品負責，同時此樣品僅保留90天。本報告未經本公司書面許可，不可部份複製。

This document is issued by the Company subject to its General Conditions of Service printed overleaf, available on request or accessible at www.sgs.com/terms_and_conditions.htm and for electronic format documents, subject to Terms and Conditions for Electronic Documents at www.sgs.com/terms_e-document.htm. Attention is drawn to the limitation of liability, indemnification and jurisdiction issues defined therein. Any holder of this document is advised that information contained hereon reflects the Company's findings at the time of its intervention only and within the limits of Client's instructions, if any. The Company's sole responsibility is to its Client and this document does not exonerate parties to a transaction from exercising all their rights and obligations under the transaction documents. This document cannot be reproduced except in full, without prior written approval of the Company. Any unauthorized alteration, forgery or falsification of the content or appearance of this document is unlawful and offenders may be prosecuted to the fullest extent of the law.

FDD Band 26								
BW(MHz)	Modulation	RB Size	RB Offset	Frequency (MHz)	Channel	Conducted power (dBm)	Target Power + Max. Tolerance (dBm)	MPR Allowed per 3GPP(dB)
1.4	64-QAM	1 RB	0	814.7	26697	18.40	19	0-1
				831.5	26865	18.47	19	0-1
				848.3	27033	18.43	19	0-1
			2	814.7	26697	18.49	19	0-1
				831.5	26865	18.38	19	0-1
				848.3	27033	18.45	19	0-1
			5	814.7	26697	18.54	19	0-1
				831.5	26865	18.46	19	0-1
				848.3	27033	18.30	19	0-1
		3 RB	0	814.7	26697	17.31	18	0-2
				831.5	26865	17.17	18	0-2
				848.3	27033	17.22	18	0-2
			2	814.7	26697	17.21	18	0-2
				831.5	26865	17.17	18	0-2
				848.3	27033	17.22	18	0-2
			3	814.7	26697	17.19	18	0-2
				831.5	26865	17.25	18	0-2
				848.3	27033	17.18	18	0-2
			6RB	814.7	26697	17.23	18	0-2
				831.5	26865	17.15	18	0-2
				848.3	27033	17.26	18	0-2

Unless otherwise stated the results shown in this test report refer only to the sample(s) tested and such sample(s) are retained for 90 days only.

除非另有說明，此報告結果僅對測試之樣品負責，同時此樣品僅保留90天。本報告未經本公司書面許可，不可部份複製。

This document is issued by the Company subject to its General Conditions of Service printed overleaf, available on request or accessible at www.sgs.com/terms_and_conditions.htm and for electronic format documents, subject to Terms and Conditions for Electronic Documents at www.sgs.com/terms_e-document.htm. Attention is drawn to the limitation of liability, indemnification and jurisdiction issues defined therein. Any holder of this document is advised that information contained hereon reflects the Company's findings at the time of its intervention only and within the limits of Client's instructions, if any. The Company's sole responsibility is to its Client and this document does not exonerate parties to a transaction from exercising all their rights and obligations under the transaction documents. This document cannot be reproduced except in full, without prior written approval of the Company. Any unauthorized alteration, forgery or falsification of the content or appearance of this document is unlawful and offenders may be prosecuted to the fullest extent of the law.

FDD Band 30									
BW(Mhz)	Modulation	RB Size	RB Offset	Frequency (MHz)	Channel	Conducted power (dBm)	Target Power + Max. Tolerance (dBm)	MPR Allowed per 3GPP(dB)	
10	QPSK	1 RB	0	2310	27710	16.30	16.5	0	
			25	2310	27710	16.18	16.5	0	
			49	2310	27710	16.26	16.5	0	
		25 RB	0	2310	27710	15.33	15.5	0-1	
			12	2310	27710	15.28	15.5	0-1	
			25	2310	27710	15.25	15.5	0-1	
		50RB			2310	27710	15.24	15.5	0-1
		16-QAM	1 RB	0	2310	27710	15.42	15.5	0-1
				25	2310	27710	15.33	15.5	0-1
	49			2310	27710	15.47	15.5	0-1	
	25 RB		0	2310	27710	14.25	14.5	0-2	
			12	2310	27710	14.24	14.5	0-2	
			25	2310	27710	14.24	14.5	0-2	
	50RB			2310	27710	14.29	14.5	0-2	
	64-QAM	1 RB	0	2310	27710	15.18	15.5	0-1	
			25	2310	27710	15.09	15.5	0-1	
			49	2310	27710	15.23	15.5	0-1	
		25 RB	0	2310	27710	14.01	14.5	0-2	
			12	2310	27710	14.00	14.5	0-2	
			25	2310	27710	14.00	14.5	0-2	
		50RB			2310	27710	14.05	14.5	0-2

Unless otherwise stated the results shown in this test report refer only to the sample(s) tested and such sample(s) are retained for 90 days only.

除非另有說明，此報告結果僅對測試之樣品負責，同時此樣品僅保留90天。本報告未經本公司書面許可，不可部份複製。

This document is issued by the Company subject to its General Conditions of Service printed overleaf, available on request or accessible at www.sgs.com/terms_and_conditions.htm and for electronic format documents, subject to Terms and Conditions for Electronic Documents at www.sgs.com/terms_e-document.htm. Attention is drawn to the limitation of liability, indemnification and jurisdiction issues defined therein. Any holder of this document is advised that information contained hereon reflects the Company's findings at the time of its intervention only and within the limits of Client's instructions, if any. The Company's sole responsibility is to its Client and this document does not exonerate parties to a transaction from exercising all their rights and obligations under the transaction documents. This document cannot be reproduced except in full, without prior written approval of the Company. Any unauthorized alteration, forgery or falsification of the content or appearance of this document is unlawful and offenders may be prosecuted to the fullest extent of the law.

FDD Band 30									
BW(Mhz)	Modulation	RB Size	RB Offset	Frequency (MHz)	Channel	Conducted power (dBm)	Target Power + Max. Tolerance (dBm)	MPR Allowed per 3GPP(dB)	
5	QPSK	1 RB	0	2307.5	27685	16.13	16.5	0	
				2310	27710	15.98	16.5	0	
				2312.5	27735	16.25	16.5	0	
			12	2307.5	27685	16.15	16.5	0	
				2310	27710	15.99	16.5	0	
				2312.5	27735	16.09	16.5	0	
		24	2307.5	27685	16.12	16.5	0		
			2310	27710	16.09	16.5	0		
			2312.5	27735	16.12	16.5	0		
		12 RB	0	2307.5	27685	15.16	15.5	0-1	
				2310	27710	15.25	15.5	0-1	
				2312.5	27735	15.10	15.5	0-1	
			6	2307.5	27685	15.07	15.5	0-1	
				2310	27710	15.34	15.5	0-1	
				2312.5	27735	15.29	15.5	0-1	
			13	2307.5	27685	15.29	15.5	0-1	
				2310	27710	15.18	15.5	0-1	
				2312.5	27735	15.24	15.5	0-1	
			25RB	2307.5	27685	15.13	15.5	0-1	
				2310	27710	15.13	15.5	0-1	
				2312.5	27735	15.41	15.5	0-1	
		16-QAM	1 RB	0	2307.5	27685	15.19	15.5	0-1
					2310	27710	15.31	15.5	0-1
					2312.5	27735	15.32	15.5	0-1
	12			2307.5	27685	15.08	15.5	0-1	
				2310	27710	15.12	15.5	0-1	
				2312.5	27735	15.10	15.5	0-1	
	24			2307.5	27685	15.35	15.5	0-1	
				2310	27710	15.18	15.5	0-1	
				2312.5	27735	15.38	15.5	0-1	
	12 RB			0	2307.5	27685	14.19	14.5	0-2
					2310	27710	14.10	14.5	0-2
					2312.5	27735	14.07	14.5	0-2
			6	2307.5	27685	14.27	14.5	0-2	
				2310	27710	14.19	14.5	0-2	
				2312.5	27735	14.19	14.5	0-2	
			13	2307.5	27685	14.05	14.5	0-2	
				2310	27710	14.26	14.5	0-2	
				2312.5	27735	14.23	14.5	0-2	
	25RB		2307.5	27685	14.12	14.5	0-2		
			2310	27710	14.05	14.5	0-2		
			2312.5	27735	14.23	14.5	0-2		

Unless otherwise stated the results shown in this test report refer only to the sample(s) tested and such sample(s) are retained for 90 days only.

除非另有說明，此報告結果僅對測試之樣品負責，同時此樣品僅保留90天。本報告未經本公司書面許可，不可部份複製。

This document is issued by the Company subject to its General Conditions of Service printed overleaf, available on request or accessible at www.sgs.com/terms_and_conditions.htm and for electronic format documents, subject to Terms and Conditions for Electronic Documents at www.sgs.com/terms_e-document.htm. Attention is drawn to the limitation of liability, indemnification and jurisdiction issues defined therein. Any holder of this document is advised that information contained hereon reflects the Company's findings at the time of its intervention only and within the limits of Client's instructions, if any. The Company's sole responsibility is to its Client and this document does not exonerate parties to a transaction from exercising all their rights and obligations under the transaction documents. This document cannot be reproduced except in full, without prior written approval of the Company. Any unauthorized alteration, forgery or falsification of the content or appearance of this document is unlawful and offenders may be prosecuted to the fullest extent of the law.

FDD Band 30								
BW(Mhz)	Modulation	RB Size	RB Offset	Frequency (MHz)	Channel	Conducted power (dBm)	Target Power + Max. Tolerance (dBm)	MPR Allowed per 3GPP(dB)
5	64-QAM	1 RB	0	2307.5	27685	15.29	15.5	0-1
				2310	27710	15.12	15.5	0-1
				2312.5	27735	15.14	15.5	0-1
			12	2307.5	27685	15.23	15.5	0-1
				2310	27710	15.15	15.5	0-1
				2312.5	27735	15.27	15.5	0-1
			24	2307.5	27685	15.24	15.5	0-1
				2310	27710	15.06	15.5	0-1
				2312.5	27735	15.15	15.5	0-1
		12 RB	0	2307.5	27685	14.07	14.5	0-2
				2310	27710	14.18	14.5	0-2
				2312.5	27735	14.20	14.5	0-2
			6	2307.5	27685	14.12	14.5	0-2
				2310	27710	14.18	14.5	0-2
				2312.5	27735	14.17	14.5	0-2
			13	2307.5	27685	14.14	14.5	0-2
				2310	27710	14.14	14.5	0-2
				2312.5	27735	14.16	14.5	0-2
			25RB	2307.5	27685	14.14	14.5	0-2
				2310	27710	14.22	14.5	0-2
				2312.5	27735	14.16	14.5	0-2

Unless otherwise stated the results shown in this test report refer only to the sample(s) tested and such sample(s) are retained for 90 days only.

除非另有說明，此報告結果僅對測試之樣品負責，同時此樣品僅保留90天。本報告未經本公司書面許可，不可部份複製。

This document is issued by the Company subject to its General Conditions of Service printed overleaf, available on request or accessible at www.sgs.com/terms_and_conditions.htm and for electronic format documents, subject to Terms and Conditions for Electronic Documents at www.sgs.com/terms_e-document.htm. Attention is drawn to the limitation of liability, indemnification and jurisdiction issues defined therein. Any holder of this document is advised that information contained hereon reflects the Company's findings at the time of its intervention only and within the limits of Client's instructions, if any. The Company's sole responsibility is to its Client and this document does not exonerate parties to a transaction from exercising all their rights and obligations under the transaction documents. This document cannot be reproduced except in full, without prior written approval of the Company. Any unauthorized alteration, forgery or falsification of the content or appearance of this document is unlawful and offenders may be prosecuted to the fullest extent of the law.

FDD Band 66									
BW(Mhz)	Modulation	RB Size	RB Offset	Frequency (MHz)	Channel	Conducted power (dBm)	Target Power + Max. Tolerance (dBm)	MPR Allowed per 3GPP(dB)	
20	QPSK	1 RB	0	1720	132072	16.51	16.9	0	
				1745	132322	16.32	16.9	0	
				1770	132572	16.58	16.9	0	
			50	1720	132072	16.10	16.9	0	
				1745	132322	16.18	16.9	0	
				1770	132572	16.49	16.9	0	
			99	1720	132072	16.23	16.9	0	
				1745	132322	16.37	16.9	0	
				1770	132572	15.94	16.9	0	
		50 RB	0	1720	132072	15.38	15.9	0-1	
				1745	132322	15.53	15.9	0-1	
				1770	132572	15.41	15.9	0-1	
			25	1720	132072	15.32	15.9	0-1	
				1745	132322	15.32	15.9	0-1	
				1770	132572	15.47	15.9	0-1	
			50	1720	132072	15.24	15.9	0-1	
				1745	132322	15.23	15.9	0-1	
				1770	132572	15.38	15.9	0-1	
			100RB	1720	132072	15.03	15.9	0-1	
				1745	132322	15.11	15.9	0-1	
				1770	132572	15.12	15.9	0-1	
		16-QAM	1 RB	0	1720	132072	15.81	15.9	0-1
					1745	132322	15.83	15.9	0-1
					1770	132572	15.79	15.9	0-1
	50			1720	132072	15.25	15.9	0-1	
				1745	132322	15.54	15.9	0-1	
				1770	132572	15.84	15.9	0-1	
	99			1720	132072	15.66	15.9	0-1	
				1745	132322	15.85	15.9	0-1	
				1770	132572	14.92	15.9	0-1	
	50 RB			0	1720	132072	14.41	14.9	0-2
					1745	132322	14.33	14.9	0-2
					1770	132572	14.36	14.9	0-2
			25	1720	132072	14.25	14.9	0-2	
				1745	132322	14.26	14.9	0-2	
				1770	132572	14.46	14.9	0-2	
			50	1720	132072	14.32	14.9	0-2	
				1745	132322	14.39	14.9	0-2	
				1770	132572	14.31	14.9	0-2	
	100RB		1720	132072	14.01	14.9	0-2		
			1745	132322	14.05	14.9	0-2		
			1770	132572	14.05	14.9	0-2		

Unless otherwise stated the results shown in this test report refer only to the sample(s) tested and such sample(s) are retained for 90 days only.

除非另有說明，此報告結果僅對測試之樣品負責，同時此樣品僅保留90天。本報告未經本公司書面許可，不可部份複製。

This document is issued by the Company subject to its General Conditions of Service printed overleaf, available on request or accessible at www.sgs.com/terms_and_conditions.htm and for electronic format documents, subject to Terms and Conditions for Electronic Documents at www.sgs.com/terms_e-document.htm. Attention is drawn to the limitation of liability, indemnification and jurisdiction issues defined therein. Any holder of this document is advised that information contained hereon reflects the Company's findings at the time of its intervention only and within the limits of Client's instructions, if any. The Company's sole responsibility is to its Client and this document does not exonerate parties to a transaction from exercising all their rights and obligations under the transaction documents. This document cannot be reproduced except in full, without prior written approval of the Company. Any unauthorized alteration, forgery or falsification of the content or appearance of this document is unlawful and offenders may be prosecuted to the fullest extent of the law.

FDD Band 66								
BW(Mhz)	Modulation	RB Size	RB Offset	Frequency (MHz)	Channel	Conducted power (dBm)	Target Power + Max. Tolerance (dBm)	MPR Allowed per 3GPP(dB)
20	64-QAM	1 RB	0	1720	132072	15.70	15.9	0-1
				1745	132322	15.66	15.9	0-1
				1770	132572	15.60	15.9	0-1
			50	1720	132072	15.02	15.9	0-1
				1745	132322	15.32	15.9	0-1
				1770	132572	15.62	15.9	0-1
			99	1720	132072	15.44	15.9	0-1
				1745	132322	15.64	15.9	0-1
				1770	132572	14.92	15.9	0-1
		50 RB	0	1720	132072	14.19	14.9	0-2
				1745	132322	14.12	14.9	0-2
				1770	132572	14.14	14.9	0-2
			25	1720	132072	14.00	14.9	0-2
				1745	132322	14.05	14.9	0-2
				1770	132572	14.25	14.9	0-2
			50	1720	132072	14.10	14.9	0-2
				1745	132322	14.14	14.9	0-2
				1770	132572	14.11	14.9	0-2
			100RB	1720	132072	13.80	14.9	0-2
				1745	132322	13.82	14.9	0-2
				1770	132572	13.87	14.9	0-2

Unless otherwise stated the results shown in this test report refer only to the sample(s) tested and such sample(s) are retained for 90 days only.

除非另有說明，此報告結果僅對測試之樣品負責，同時此樣品僅保留90天。本報告未經本公司書面許可，不可部份複製。

This document is issued by the Company subject to its General Conditions of Service printed overleaf, available on request or accessible at www.sgs.com/terms_and_conditions.htm and for electronic format documents, subject to Terms and Conditions for Electronic Documents at www.sgs.com/terms_e-document.htm. Attention is drawn to the limitation of liability, indemnification and jurisdiction issues defined therein. Any holder of this document is advised that information contained hereon reflects the Company's findings at the time of its intervention only and within the limits of Client's instructions, if any. The Company's sole responsibility is to its Client and this document does not exonerate parties to a transaction from exercising all their rights and obligations under the transaction documents. This document cannot be reproduced except in full, without prior written approval of the Company. Any unauthorized alteration, forgery or falsification of the content or appearance of this document is unlawful and offenders may be prosecuted to the fullest extent of the law.

FDD Band 66									
BW(Mhz)	Modulation	RB Size	RB Offset	Frequency (MHz)	Channel	Conducted power (dBm)	Target Power + Max. Tolerance (dBm)	MPR Allowed per 3GPP(dB)	
15	QPSK	1 RB	0	1717.5	132047	16.48	16.9	0	
				1745	132322	16.15	16.9	0	
				1772.5	132597	16.57	16.9	0	
			36	1717.5	132047	15.96	16.9	0	
				1745	132322	16.07	16.9	0	
				1772.5	132597	16.33	16.9	0	
		74	1717.5	132047	16.04	16.9	0		
			1745	132322	16.21	16.9	0		
			1772.5	132597	15.83	16.9	0-1		
		36 RB	0	1717.5	132047	15.18	15.9	0-1	
				1745	132322	15.47	15.9	0-1	
				1772.5	132597	15.27	15.9	0-1	
			18	1717.5	132047	15.14	15.9	0-1	
				1745	132322	15.13	15.9	0-1	
				1772.5	132597	15.37	15.9	0-1	
		37	1717.5	132047	15.23	15.9	0-1		
			1745	132322	15.06	15.9	0-1		
			1772.5	132597	15.29	15.9	0-1		
		75RB	1717.5	132047	15.00	15.9	0-1		
			1745	132322	15.09	15.9	0-1		
			1772.5	132597	14.99	15.9	0-1		
		16-QAM	1 RB	0	1717.5	132047	15.87	15.9	0-1
					1745	132322	15.87	15.9	0-1
					1772.5	132597	15.67	15.9	0-1
	36			1717.5	132047	15.06	15.9	0-1	
				1745	132322	15.47	15.9	0-1	
				1772.5	132597	15.68	15.9	0-1	
	74			1717.5	132047	15.61	15.9	0-1	
				1745	132322	15.83	15.9	0-1	
				1772.5	132597	14.91	15.9	0-2	
	36 RB			0	1717.5	132047	14.36	14.9	0-2
					1745	132322	14.24	14.9	0-2
					1772.5	132597	14.16	14.9	0-2
			18	1717.5	132047	14.10	14.9	0-2	
				1745	132322	14.19	14.9	0-2	
				1772.5	132597	14.43	14.9	0-2	
	37		1717.5	132047	14.26	14.9	0-2		
			1745	132322	14.29	14.9	0-2		
			1772.5	132597	14.18	14.9	0-2		
	75RB		1717.5	132047	13.83	14.9	0-2		
			1745	132322	13.92	14.9	0-2		
			1772.5	132597	13.96	14.9	0-1		

Unless otherwise stated the results shown in this test report refer only to the sample(s) tested and such sample(s) are retained for 90 days only.

除非另有說明，此報告結果僅對測試之樣品負責，同時此樣品僅保留90天。本報告未經本公司書面許可，不可部份複製。

This document is issued by the Company subject to its General Conditions of Service printed overleaf, available on request or accessible at www.sgs.com/terms_and_conditions.htm and for electronic format documents, subject to Terms and Conditions for Electronic Documents at www.sgs.com/terms_e-document.htm. Attention is drawn to the limitation of liability, indemnification and jurisdiction issues defined therein. Any holder of this document is advised that information contained hereon reflects the Company's findings at the time of its intervention only and within the limits of Client's instructions, if any. The Company's sole responsibility is to its Client and this document does not exonerate parties to a transaction from exercising all their rights and obligations under the transaction documents. This document cannot be reproduced except in full, without prior written approval of the Company. Any unauthorized alteration, forgery or falsification of the content or appearance of this document is unlawful and offenders may be prosecuted to the fullest extent of the law.

FDD Band 66								
BW(MHz)	Modulation	RB Size	RB Offset	Frequency (MHz)	Channel	Conducted power (dBm)	Target Power + Max. Tolerance (dBm)	MPR Allowed per 3GPP(dB)
15	64-QAM	1 RB	0	1717.5	132047	15.51	15.9	0-1
				1745	132322	15.51	15.9	0-1
				1772.5	132597	15.42	15.9	0-1
			36	1717.5	132047	14.96	15.9	0-1
				1745	132322	15.22	15.9	0-1
				1772.5	132597	15.51	15.9	0-1
			74	1717.5	132047	15.43	15.9	0-1
				1745	132322	15.50	15.9	0-1
				1772.5	132597	14.78	15.9	0-2
		36 RB	0	1717.5	132047	14.04	14.9	0-2
				1745	132322	14.07	14.9	0-2
				1772.5	132597	13.99	14.9	0-2
			18	1717.5	132047	13.88	14.9	0-2
				1745	132322	13.92	14.9	0-2
				1772.5	132597	14.21	14.9	0-2
			37	1717.5	132047	14.08	14.9	0-2
				1745	132322	14.06	14.9	0-2
				1772.5	132597	14.00	14.9	0-2
		75RB	1717.5	132047	13.78	14.9	0-2	
			1745	132322	13.76	14.9	0-2	
			1772.5	132597	13.71	14.9	0-2	

Unless otherwise stated the results shown in this test report refer only to the sample(s) tested and such sample(s) are retained for 90 days only.

除非另有說明，此報告結果僅對測試之樣品負責，同時此樣品僅保留90天。本報告未經本公司書面許可，不可部份複製。

This document is issued by the Company subject to its General Conditions of Service printed overleaf, available on request or accessible at www.sgs.com/terms_and_conditions.htm and for electronic format documents, subject to Terms and Conditions for Electronic Documents at www.sgs.com/terms_e-document.htm. Attention is drawn to the limitation of liability, indemnification and jurisdiction issues defined therein. Any holder of this document is advised that information contained hereon reflects the Company's findings at the time of its intervention only and within the limits of Client's instructions, if any. The Company's sole responsibility is to its Client and this document does not exonerate parties to a transaction from exercising all their rights and obligations under the transaction documents. This document cannot be reproduced except in full, without prior written approval of the Company. Any unauthorized alteration, forgery or falsification of the content or appearance of this document is unlawful and offenders may be prosecuted to the fullest extent of the law.

FDD Band 66									
BW(Mhz)	Modulation	RB Size	RB Offset	Frequency (MHz)	Channel	Conducted power (dBm)	Target Power + Max. Tolerance (dBm)	MPR Allowed per 3GPP(dB)	
10	QPSK	1 RB	0	1715	132022	16.52	16.9	0	
				1745	132322	16.29	16.9	0	
				1775	132622	16.41	16.9	0	
			25	1715	132022	15.97	16.9	0	
				1745	132322	16.08	16.9	0	
				1775	132622	16.24	16.9	0	
		49	1715	132022	16.12	16.9	0		
			1745	132322	16.34	16.9	0		
			1775	132622	15.85	16.9	0-1		
		25 RB	0	1715	132022	15.21	15.9	0-1	
				1745	132322	15.33	15.9	0-1	
				1775	132622	15.25	15.9	0-1	
			12	1715	132022	15.16	15.9	0-1	
				1745	132322	15.13	15.9	0-1	
				1775	132622	15.38	15.9	0-1	
			25	1715	132022	15.18	15.9	0-1	
				1745	132322	15.24	15.9	0-1	
				1775	132622	15.39	15.9	0-1	
			50RB	1715	132022	14.87	15.9	0-1	
				1745	132322	15.09	15.9	0-1	
				1775	132622	15.00	15.9	0-1	
		16-QAM	1 RB	0	1715	132022	15.85	15.9	0-1
					1745	132322	15.74	15.9	0-1
					1775	132622	15.75	15.9	0-1
	25			1715	132022	15.24	15.9	0-1	
				1745	132322	15.42	15.9	0-1	
				1775	132622	15.80	15.9	0-1	
	49			1715	132022	15.64	15.9	0-1	
				1745	132322	15.74	15.9	0-1	
				1775	132622	14.82	15.9	0-2	
	25 RB			0	1715	132022	14.34	14.9	0-2
					1745	132322	14.32	14.9	0-2
					1775	132622	14.31	14.9	0-2
			12	1715	132022	14.16	14.9	0-2	
				1745	132322	14.17	14.9	0-2	
				1775	132622	14.33	14.9	0-2	
			25	1715	132022	14.29	14.9	0-2	
				1745	132322	14.17	14.9	0-2	
				1775	132622	14.15	14.9	0-2	
	50RB		1715	132022	13.94	14.9	0-2		
			1745	132322	13.95	14.9	0-2		
			1775	132622	14.00	14.9	0-1		

Unless otherwise stated the results shown in this test report refer only to the sample(s) tested and such sample(s) are retained for 90 days only.

除非另有說明，此報告結果僅對測試之樣品負責，同時此樣品僅保留90天。本報告未經本公司書面許可，不可部份複製。

This document is issued by the Company subject to its General Conditions of Service printed overleaf, available on request or accessible at www.sgs.com/terms_and_conditions.htm and for electronic format documents, subject to Terms and Conditions for Electronic Documents at www.sgs.com/terms_e-document.htm. Attention is drawn to the limitation of liability, indemnification and jurisdiction issues defined therein. Any holder of this document is advised that information contained hereon reflects the Company's findings at the time of its intervention only and within the limits of Client's instructions, if any. The Company's sole responsibility is to its Client and this document does not exonerate parties to a transaction from exercising all their rights and obligations under the transaction documents. This document cannot be reproduced except in full, without prior written approval of the Company. Any unauthorized alteration, forgery or falsification of the content or appearance of this document is unlawful and offenders may be prosecuted to the fullest extent of the law.

FDD Band 66								
BW(MHz)	Modulation	RB Size	RB Offset	Frequency (MHz)	Channel	Conducted power (dBm)	Target Power + Max. Tolerance (dBm)	MPR Allowed per 3GPP(dB)
10	64-QAM	1 RB	0	1715	132022	15.64	15.9	0-1
				1745	132322	15.61	15.9	0-1
				1775	132622	15.55	15.9	0-1
			25	1715	132022	15.00	15.9	0-1
				1745	132322	15.11	15.9	0-1
				1775	132622	15.60	15.9	0-1
			49	1715	132022	15.40	15.9	0-1
				1745	132322	15.63	15.9	0-1
				1775	132622	14.92	15.9	0-2
		25 RB	0	1715	132022	14.07	14.9	0-2
				1745	132322	14.05	14.9	0-2
				1775	132622	14.01	14.9	0-2
			12	1715	132022	13.95	14.9	0-2
				1745	132322	13.94	14.9	0-2
				1775	132622	14.14	14.9	0-2
			25	1715	132022	14.07	14.9	0-2
				1745	132322	14.01	14.9	0-2
				1775	132622	14.04	14.9	0-2
			50RB	1715	132022	13.74	14.9	0-2
				1745	132322	13.80	14.9	0-2
				1775	132622	13.85	14.9	0-2

Unless otherwise stated the results shown in this test report refer only to the sample(s) tested and such sample(s) are retained for 90 days only.

除非另有說明，此報告結果僅對測試之樣品負責，同時此樣品僅保留90天。本報告未經本公司書面許可，不可部份複製。

This document is issued by the Company subject to its General Conditions of Service printed overleaf, available on request or accessible at www.sgs.com/terms_and_conditions.htm and for electronic format documents, subject to Terms and Conditions for Electronic Documents at www.sgs.com/terms_e-document.htm. Attention is drawn to the limitation of liability, indemnification and jurisdiction issues defined therein. Any holder of this document is advised that information contained hereon reflects the Company's findings at the time of its intervention only and within the limits of Client's instructions, if any. The Company's sole responsibility is to its Client and this document does not exonerate parties to a transaction from exercising all their rights and obligations under the transaction documents. This document cannot be reproduced except in full, without prior written approval of the Company. Any unauthorized alteration, forgery or falsification of the content or appearance of this document is unlawful and offenders may be prosecuted to the fullest extent of the law.

FDD Band 66									
BW(Mhz)	Modulation	RB Size	RB Offset	Frequency (MHz)	Channel	Conducted power (dBm)	Target Power + Max. Tolerance (dBm)	MPR Allowed per 3GPP(dB)	
5	QPSK	1 RB	0	1712.5	131997	16.37	16.9	0	
				1745	132322	16.22	16.9	0	
				1777.5	132647	16.51	16.9	0	
			12	1712.5	131997	15.94	16.9	0	
				1745	132322	16.03	16.9	0	
				1777.5	132647	16.29	16.9	0	
		24	1712.5	131997	16.03	16.9	0		
			1745	132322	16.35	16.9	0		
			1777.5	132647	15.78	16.9	0-1		
		12 RB	0	1712.5	131997	15.21	15.9	0-1	
				1745	132322	15.40	15.9	0-1	
				1777.5	132647	15.34	15.9	0-1	
			6	1712.5	131997	15.24	15.9	0-1	
				1745	132322	15.14	15.9	0-1	
				1777.5	132647	15.25	15.9	0-1	
			13	1712.5	131997	15.12	15.9	0-1	
				1745	132322	15.10	15.9	0-1	
				1777.5	132647	15.29	15.9	0-1	
		25RB	1712.5	131997	15.04	15.9	0-1		
			1745	132322	15.07	15.9	0-1		
			1777.5	132647	15.07	15.9	0-1		
		16-QAM	1 RB	0	1712.5	131997	15.76	15.9	0-1
					1745	132322	15.87	15.9	0-1
					1777.5	132647	15.73	15.9	0-1
	12			1712.5	131997	15.08	15.9	0-1	
				1745	132322	15.48	15.9	0-1	
				1777.5	132647	15.67	15.9	0-1	
	24			1712.5	131997	15.67	15.9	0-1	
				1745	132322	15.68	15.9	0-1	
				1777.5	132647	14.82	15.9	0-2	
	12 RB			0	1712.5	131997	14.24	14.9	0-2
					1745	132322	14.18	14.9	0-2
					1777.5	132647	14.24	14.9	0-2
			6	1712.5	131997	14.08	14.9	0-2	
				1745	132322	14.08	14.9	0-2	
				1777.5	132647	14.31	14.9	0-2	
			13	1712.5	131997	14.30	14.9	0-2	
				1745	132322	14.38	14.9	0-2	
				1777.5	132647	14.22	14.9	0-2	
	25RB		1712.5	131997	13.98	14.9	0-2		
			1745	132322	14.03	14.9	0-2		
			1777.5	132647	14.03	14.9	0-1		

Unless otherwise stated the results shown in this test report refer only to the sample(s) tested and such sample(s) are retained for 90 days only.

除非另有說明，此報告結果僅對測試之樣品負責，同時此樣品僅保留90天。本報告未經本公司書面許可，不可部份複製。

This document is issued by the Company subject to its General Conditions of Service printed overleaf, available on request or accessible at www.sgs.com/terms_and_conditions.htm and for electronic format documents, subject to Terms and Conditions for Electronic Documents at www.sgs.com/terms_e-document.htm. Attention is drawn to the limitation of liability, indemnification and jurisdiction issues defined therein. Any holder of this document is advised that information contained hereon reflects the Company's findings at the time of its intervention only and within the limits of Client's instructions, if any. The Company's sole responsibility is to its Client and this document does not exonerate parties to a transaction from exercising all their rights and obligations under the transaction documents. This document cannot be reproduced except in full, without prior written approval of the Company. Any unauthorized alteration, forgery or falsification of the content or appearance of this document is unlawful and offenders may be prosecuted to the fullest extent of the law.

FDD Band 66								
BW(MHz)	Modulation	RB Size	RB Offset	Frequency (MHz)	Channel	Conducted power (dBm)	Target Power + Max. Tolerance (dBm)	MPR Allowed per 3GPP(dB)
5	64-QAM	1 RB	0	1712.5	131997	15.63	15.9	0-1
				1745	132322	15.48	15.9	0-1
				1777.5	132647	15.57	15.9	0-1
			12	1712.5	131997	14.80	15.9	0-1
				1745	132322	15.22	15.9	0-1
				1777.5	132647	15.42	15.9	0-1
			24	1712.5	131997	15.42	15.9	0-1
				1745	132322	15.47	15.9	0-1
				1777.5	132647	14.91	15.9	0-2
		12 RB	0	1712.5	131997	14.12	14.9	0-2
				1745	132322	13.96	14.9	0-2
				1777.5	132647	14.13	14.9	0-2
			6	1712.5	131997	13.85	14.9	0-2
				1745	132322	13.91	14.9	0-2
				1777.5	132647	14.12	14.9	0-2
			13	1712.5	131997	14.02	14.9	0-2
				1745	132322	13.99	14.9	0-2
				1777.5	132647	14.00	14.9	0-2
			25RB	1712.5	131997	13.66	14.9	0-2
				1745	132322	13.80	14.9	0-2
				1777.5	132647	13.80	14.9	0-2

Unless otherwise stated the results shown in this test report refer only to the sample(s) tested and such sample(s) are retained for 90 days only.

除非另有說明，此報告結果僅對測試之樣品負責，同時此樣品僅保留90天。本報告未經本公司書面許可，不可部份複製。

This document is issued by the Company subject to its General Conditions of Service printed overleaf, available on request or accessible at www.sgs.com/terms_and_conditions.htm and for electronic format documents, subject to Terms and Conditions for Electronic Documents at www.sgs.com/terms_e-document.htm. Attention is drawn to the limitation of liability, indemnification and jurisdiction issues defined therein. Any holder of this document is advised that information contained hereon reflects the Company's findings at the time of its intervention only and within the limits of Client's instructions, if any. The Company's sole responsibility is to its Client and this document does not exonerate parties to a transaction from exercising all their rights and obligations under the transaction documents. This document cannot be reproduced except in full, without prior written approval of the Company. Any unauthorized alteration, forgery or falsification of the content or appearance of this document is unlawful and offenders may be prosecuted to the fullest extent of the law.

FDD Band 66									
BW(Mhz)	Modulation	RB Size	RB Offset	Frequency (MHz)	Channel	Conducted power (dBm)	Target Power + Max. Tolerance (dBm)	MPR Allowed per 3GPP(dB)	
3	QPSK	1 RB	0	1711.5	131987	16.34	16.9	0	
				1745	132322	16.23	16.9	0	
				1778.5	132657	16.38	16.9	0	
			7	1711.5	131987	16.09	16.9	0	
				1745	132322	16.12	16.9	0	
				1778.5	132657	16.44	16.9	0	
		14	1711.5	131987	16.17	16.9	0		
			1745	132322	16.19	16.9	0		
			1778.5	132657	15.78	16.9	0-1		
		8 RB	0	1711.5	131987	15.27	15.9	15.9	0-1
				1745	132322	15.34	15.9	0-1	
				1778.5	132657	15.33	15.9	0-1	
			4	1711.5	131987	15.14	15.9	0-1	
				1745	132322	15.12	15.9	0-1	
				1778.5	132657	15.40	15.9	0-1	
			7	1711.5	131987	15.05	15.9	0-1	
				1745	132322	15.18	15.9	0-1	
				1778.5	132657	15.25	15.9	0-1	
		15RB	1711.5	131987	14.92	15.9	0-1		
			1745	132322	15.06	15.9	0-1		
			1778.5	132657	14.94	15.9	0-1		
		16-QAM	1 RB	0	1711.5	131987	15.83	15.9	0-1
					1745	132322	15.85	15.9	0-1
					1778.5	132657	15.75	15.9	0-1
	7			1711.5	131987	15.17	15.9	0-1	
				1745	132322	15.31	15.9	0-1	
				1778.5	132657	15.75	15.9	0-1	
	14			1711.5	131987	15.60	15.9	0-1	
				1745	132322	15.72	15.9	0-1	
				1778.5	132657	14.74	15.9	0-2	
	8 RB		0	1711.5	131987	14.33	14.9	0-2	
				1745	132322	14.25	14.9	0-2	
				1778.5	132657	14.29	14.9	0-2	
			4	1711.5	131987	14.17	14.9	0-2	
				1745	132322	14.18	14.9	0-2	
				1778.5	132657	14.37	14.9	0-2	
			7	1711.5	131987	14.27	14.9	0-2	
				1745	132322	14.18	14.9	0-2	
				1778.5	132657	14.24	14.9	0-2	
	15RB		1711.5	131987	13.91	14.9	0-2		
			1745	132322	14.01	14.9	0-2		
			1778.5	132657	14.01	14.9	0-1		

Unless otherwise stated the results shown in this test report refer only to the sample(s) tested and such sample(s) are retained for 90 days only.

除非另有說明，此報告結果僅對測試之樣品負責，同時此樣品僅保留90天。本報告未經本公司書面許可，不可部份複製。

This document is issued by the Company subject to its General Conditions of Service printed overleaf, available on request or accessible at www.sgs.com/terms_and_conditions.htm and for electronic format documents, subject to Terms and Conditions for Electronic Documents at www.sgs.com/terms_e-document.htm. Attention is drawn to the limitation of liability, indemnification and jurisdiction issues defined therein. Any holder of this document is advised that information contained hereon reflects the Company's findings at the time of its intervention only and within the limits of Client's instructions, if any. The Company's sole responsibility is to its Client and this document does not exonerate parties to a transaction from exercising all their rights and obligations under the transaction documents. This document cannot be reproduced except in full, without prior written approval of the Company. Any unauthorized alteration, forgery or falsification of the content or appearance of this document is unlawful and offenders may be prosecuted to the fullest extent of the law.

FDD Band 66								
BW(MHz)	Modulation	RB Size	RB Offset	Frequency (MHz)	Channel	Conducted power (dBm)	Target Power + Max. Tolerance (dBm)	MPR Allowed per 3GPP(dB)
3	64-QAM	1 RB	0	1711.5	131987	15.48	15.9	0-1
				1745	132322	15.50	15.9	0-1
				1778.5	132657	15.50	15.9	0-1
			7	1711.5	131987	14.88	15.9	0-1
				1745	132322	15.18	15.9	0-1
				1778.5	132657	15.39	15.9	0-1
			14	1711.5	131987	15.39	15.9	0-1
				1745	132322	15.57	15.9	0-1
				1778.5	132657	14.78	15.9	0-2
		8 RB	0	1711.5	131987	14.16	14.9	0-2
				1745	132322	13.99	14.9	0-2
				1778.5	132657	14.03	14.9	0-2
			4	1711.5	131987	14.01	14.9	0-2
				1745	132322	14.01	14.9	0-2
				1778.5	132657	14.21	14.9	0-2
			7	1711.5	131987	13.93	14.9	0-2
				1745	132322	14.05	14.9	0-2
				1778.5	132657	14.04	14.9	0-2
		15RB	1711.5	131987	13.74	14.9	0-2	
			1745	132322	13.68	14.9	0-2	
			1778.5	132657	13.78	14.9	0-2	

Unless otherwise stated the results shown in this test report refer only to the sample(s) tested and such sample(s) are retained for 90 days only.

除非另有說明，此報告結果僅對測試之樣品負責，同時此樣品僅保留90天。本報告未經本公司書面許可，不可部份複製。

This document is issued by the Company subject to its General Conditions of Service printed overleaf, available on request or accessible at www.sgs.com/terms_and_conditions.htm and for electronic format documents, subject to Terms and Conditions for Electronic Documents at www.sgs.com/terms_e-document.htm. Attention is drawn to the limitation of liability, indemnification and jurisdiction issues defined therein. Any holder of this document is advised that information contained hereon reflects the Company's findings at the time of its intervention only and within the limits of Client's instructions, if any. The Company's sole responsibility is to its Client and this document does not exonerate parties to a transaction from exercising all their rights and obligations under the transaction documents. This document cannot be reproduced except in full, without prior written approval of the Company. Any unauthorized alteration, forgery or falsification of the content or appearance of this document is unlawful and offenders may be prosecuted to the fullest extent of the law.

FDD Band 66									
BW(Mhz)	Modulation	RB Size	RB Offset	Frequency (MHz)	Channel	Conducted power (dBm)	Target Power + Max. Tolerance (dBm)	MPR Allowed per 3GPP(dB)	
1.4	QPSK	1 RB	0	1710.7	131979	16.47	16.9	0	
				1745	132322	16.32	16.9	0	
				1779.3	132665	16.39	16.9	0	
			2	1710.7	131979	16.10	16.9	0	
				1745	132322	16.10	16.9	0	
				1779.3	132665	16.40	16.9	0	
		5	1710.7	131979	16.02	16.9	0		
			1745	132322	16.32	16.9	0		
			1779.3	132665	15.89	16.9	0-1		
		3 RB	0	1710.7	131979	15.21	15.9	0-1	
				1745	132322	15.47	15.9	0-1	
				1779.3	132665	15.39	15.9	0-1	
			2	1710.7	131979	15.21	15.9	0-1	
				1745	132322	15.28	15.9	0-1	
				1779.3	132665	15.42	15.9	0-1	
			3	1710.7	131979	15.22	15.9	0-1	
				1745	132322	15.27	15.9	0-1	
				1779.3	132665	15.37	15.9	0-1	
		6RB	1710.7	131979	14.90	15.9	0-1		
			1745	132322	14.94	15.9	0-1		
			1779.3	132665	14.90	15.9	0-1		
		16-QAM	1 RB	0	1710.7	131979	15.73	15.9	0-1
					1745	132322	15.75	15.9	0-1
					1779.3	132665	15.79	15.9	0-1
	2			1710.7	131979	15.23	15.9	0-1	
				1745	132322	15.50	15.9	0-1	
				1779.3	132665	15.76	15.9	0-1	
	5			1710.7	131979	15.60	15.9	0-1	
				1745	132322	15.84	15.9	0-1	
				1779.3	132665	14.83	15.9	0-2	
	3 RB			0	1710.7	131979	14.24	14.9	0-2
					1745	132322	14.24	14.9	0-2
					1779.3	132665	14.35	14.9	0-2
			2	1710.7	131979	14.14	14.9	0-2	
				1745	132322	14.19	14.9	0-2	
				1779.3	132665	14.37	14.9	0-2	
			3	1710.7	131979	14.24	14.9	0-2	
				1745	132322	14.33	14.9	0-2	
				1779.3	132665	14.23	14.9	0-2	
	6RB		1710.7	131979	13.91	14.9	0-2		
			1745	132322	14.06	14.9	0-2		
			1779.3	132665	13.97	14.9	0-1		

Unless otherwise stated the results shown in this test report refer only to the sample(s) tested and such sample(s) are retained for 90 days only.

除非另有說明，此報告結果僅對測試之樣品負責，同時此樣品僅保留90天。本報告未經本公司書面許可，不可部份複製。

This document is issued by the Company subject to its General Conditions of Service printed overleaf, available on request or accessible at www.sgs.com/terms_and_conditions.htm and for electronic format documents, subject to Terms and Conditions for Electronic Documents at www.sgs.com/terms_e-document.htm. Attention is drawn to the limitation of liability, indemnification and jurisdiction issues defined therein. Any holder of this document is advised that information contained hereon reflects the Company's findings at the time of its intervention only and within the limits of Client's instructions, if any. The Company's sole responsibility is to its Client and this document does not exonerate parties to a transaction from exercising all their rights and obligations under the transaction documents. This document cannot be reproduced except in full, without prior written approval of the Company. Any unauthorized alteration, forgery or falsification of the content or appearance of this document is unlawful and offenders may be prosecuted to the fullest extent of the law.

FDD Band 66								
BW(MHz)	Modulation	RB Size	RB Offset	Frequency (MHz)	Channel	Conducted power (dBm)	Target Power + Max. Tolerance (dBm)	MPR Allowed per 3GPP(dB)
1.4	64-QAM	1 RB	0	1710.7	131979	15.54	15.9	0-1
				1745	132322	15.66	15.9	0-1
				1779.3	132665	15.47	15.9	0-1
			2	1710.7	131979	14.88	15.9	0-1
				1745	132322	15.12	15.9	0-1
				1779.3	132665	15.44	15.9	0-1
			5	1710.7	131979	15.35	15.9	0-1
				1745	132322	15.46	15.9	0-1
				1779.3	132665	14.91	15.9	0-2
		3 RB	0	1710.7	131979	14.00	14.9	0-2
				1745	132322	14.12	14.9	0-2
				1779.3	132665	14.11	14.9	0-2
			2	1710.7	131979	13.94	14.9	0-2
				1745	132322	14.01	14.9	0-2
				1779.3	132665	14.20	14.9	0-2
			3	1710.7	131979	14.01	14.9	0-2
				1745	132322	14.13	14.9	0-2
				1779.3	132665	13.97	14.9	0-2
		6RB	1710.7	131979	13.66	14.9	0-2	
			1745	132322	13.65	14.9	0-2	
			1779.3	132665	13.86	14.9	0-2	

Unless otherwise stated the results shown in this test report refer only to the sample(s) tested and such sample(s) are retained for 90 days only.

除非另有說明，此報告結果僅對測試之樣品負責，同時此樣品僅保留90天。本報告未經本公司書面許可，不可部份複製。

This document is issued by the Company subject to its General Conditions of Service printed overleaf, available on request or accessible at www.sgs.com/terms_and_conditions.htm and for electronic format documents, subject to Terms and Conditions for Electronic Documents at www.sgs.com/terms_e-document.htm. Attention is drawn to the limitation of liability, indemnification and jurisdiction issues defined therein. Any holder of this document is advised that information contained hereon reflects the Company's findings at the time of its intervention only and within the limits of Client's instructions, if any. The Company's sole responsibility is to its Client and this document does not exonerate parties to a transaction from exercising all their rights and obligations under the transaction documents. This document cannot be reproduced except in full, without prior written approval of the Company. Any unauthorized alteration, forgery or falsification of the content or appearance of this document is unlawful and offenders may be prosecuted to the fullest extent of the law.

LTE TDD Band 38 / Band 41 power table (Reduced power):

TDD Band 38									
BW(Mhz)	Modulation	RB Size	RB Offset	Frequency (MHz)	Channel	Conducted power (dBm)	Target Power + Max. Tolerance (dBm)	MPR Allowed per 3GPP(dB)	
20	QPSK	1 RB	0	2580	37850	17.06	17.3	0	
				2595	38000	16.97	17.3	0	
				2610	38150	16.90	17.3	0	
			50	2580	37850	16.80	17.3	0	
				2595	38000	16.73	17.3	0	
				2610	38150	16.69	17.3	0	
			99	2580	37850	16.71	17.3	0	
				2595	38000	16.67	17.3	0	
				2610	38150	16.67	17.3	0	
		50 RB	0	2580	37850	16.03	16.3	0-1	
				2595	38000	15.96	16.3	0-1	
				2610	38150	15.93	16.3	0-1	
			25	2580	37850	15.96	16.3	0-1	
				2595	38000	15.82	16.3	0-1	
				2610	38150	15.83	16.3	0-1	
			50	2580	37850	15.82	16.3	0-1	
				2595	38000	15.69	16.3	0-1	
				2610	38150	15.77	16.3	0-1	
		100RB	2580	37850	15.95	16.3	0-1		
			2595	38000	15.82	16.3	0-1		
			2610	38150	15.79	16.3	0-1		
		16-QAM	1 RB	0	2580	37850	16.29	16.3	0-1
					2595	38000	16.26	16.3	0-1
					2610	38150	16.24	16.3	0-1
	50			2580	37850	16.07	16.3	0-1	
				2595	38000	16.01	16.3	0-1	
				2610	38150	15.93	16.3	0-1	
	99			2580	37850	15.95	16.3	0-1	
				2595	38000	15.98	16.3	0-1	
				2610	38150	15.94	16.3	0-1	
	50 RB			0	2580	37850	15.04	15.3	0-2
					2595	38000	14.97	15.3	0-2
					2610	38150	14.96	15.3	0-2
			25	2580	37850	14.97	15.3	0-2	
				2595	38000	14.88	15.3	0-2	
				2610	38150	14.83	15.3	0-2	
			50	2580	37850	14.91	15.3	0-2	
				2595	38000	14.81	15.3	0-2	
				2610	38150	14.85	15.3	0-2	
	100RB		2580	37850	14.99	15.3	0-2		
			2595	38000	14.84	15.3	0-2		
			2610	38150	14.81	15.3	0-2		

Unless otherwise stated the results shown in this test report refer only to the sample(s) tested and such sample(s) are retained for 90 days only.

除非另有說明，此報告結果僅對測試之樣品負責，同時此樣品僅保留90天。本報告未經本公司書面許可，不可部份複製。

This document is issued by the Company subject to its General Conditions of Service printed overleaf, available on request or accessible at www.sgs.com/terms_and_conditions.htm and for electronic format documents, subject to Terms and Conditions for Electronic Documents at www.sgs.com/terms_e-document.htm. Attention is drawn to the limitation of liability, indemnification and jurisdiction issues defined therein. Any holder of this document is advised that information contained hereon reflects the Company's findings at the time of its intervention only and within the limits of Client's instructions, if any. The Company's sole responsibility is to its Client and this document does not exonerate parties to a transaction from exercising all their rights and obligations under the transaction documents. This document cannot be reproduced except in full, without prior written approval of the Company. Any unauthorized alteration, forgery or falsification of the content or appearance of this document is unlawful and offenders may be prosecuted to the fullest extent of the law.

TDD Band 38								
BW(MHz)	Modulation	RB Size	RB Offset	Frequency (MHz)	Channel	Conducted power (dBm)	Target Power + Max. Tolerance (dBm)	MPR Allowed per 3GPP(dB)
20	64-QAM	1 RB	0	2580	37850	16.14	16.3	0-1
				2595	38000	16.06	16.3	0-1
				2610	38150	16.05	16.3	0-1
			50	2580	37850	15.93	16.3	0-1
				2595	38000	15.80	16.3	0-1
				2610	38150	15.75	16.3	0-1
			99	2580	37850	15.78	16.3	0-1
				2595	38000	15.80	16.3	0-1
				2610	38150	15.74	16.3	0-1
		50 RB	0	2580	37850	14.86	15.3	0-2
				2595	38000	14.82	15.3	0-2
				2610	38150	14.76	15.3	0-2
			25	2580	37850	14.75	15.3	0-2
				2595	38000	14.72	15.3	0-2
				2610	38150	14.65	15.3	0-2
			50	2580	37850	14.73	15.3	0-2
				2595	38000	14.64	15.3	0-2
				2610	38150	14.65	15.3	0-2
			100RB	2580	37850	14.82	15.3	0-2
				2595	38000	14.66	15.3	0-2
				2610	38150	14.62	15.3	0-2

Unless otherwise stated the results shown in this test report refer only to the sample(s) tested and such sample(s) are retained for 90 days only.

除非另有說明，此報告結果僅對測試之樣品負責，同時此樣品僅保留90天。本報告未經本公司書面許可，不可部份複製。

This document is issued by the Company subject to its General Conditions of Service printed overleaf, available on request or accessible at www.sgs.com/terms_and_conditions.htm and for electronic format documents, subject to Terms and Conditions for Electronic Documents at www.sgs.com/terms_e-document.htm. Attention is drawn to the limitation of liability, indemnification and jurisdiction issues defined therein. Any holder of this document is advised that information contained hereon reflects the Company's findings at the time of its intervention only and within the limits of Client's instructions, if any. The Company's sole responsibility is to its Client and this document does not exonerate parties to a transaction from exercising all their rights and obligations under the transaction documents. This document cannot be reproduced except in full, without prior written approval of the Company. Any unauthorized alteration, forgery or falsification of the content or appearance of this document is unlawful and offenders may be prosecuted to the fullest extent of the law.

TDD Band 38									
BW(Mhz)	Modulation	RB Size	RB Offset	Frequency (MHz)	Channel	Conducted power (dBm)	Target Power + Max. Tolerance (dBm)	MPR Allowed per 3GPP(dB)	
15	QPSK	1 RB	0	2577.5	37825	17.01	17.3	0	
				2595	38000	16.92	17.3	0	
				2612.5	38175	16.90	17.3	0	
			36	2577.5	37825	16.86	17.3	0	
				2595	38000	16.79	17.3	0	
				2612.5	38175	16.75	17.3	0	
			74	2577.5	37825	16.83	17.3	0	
				2595	38000	16.77	17.3	0	
				2612.5	38175	16.70	17.3	0	
		36 RB	0	2577.5	37825	15.99	16.3	0-1	
				2595	38000	15.85	16.3	0-1	
				2612.5	38175	15.85	16.3	0-1	
			18	2577.5	37825	15.99	16.3	0-1	
				2595	38000	15.87	16.3	0-1	
				2612.5	38175	15.79	16.3	0-1	
			37	2577.5	37825	15.87	16.3	0-1	
				2595	38000	15.77	16.3	0-1	
				2612.5	38175	15.79	16.3	0-1	
		75RB	2577.5	37825	15.93	16.3	0-1		
			2595	38000	15.85	16.3	0-1		
			2612.5	38175	15.73	16.3	0-1		
		16-QAM	1 RB	0	2577.5	37825	16.24	16.3	0-1
					2595	38000	16.18	16.3	0-1
					2612.5	38175	16.14	16.3	0-1
	36			2577.5	37825	16.14	16.3	0-1	
				2595	38000	16.00	16.3	0-1	
				2612.5	38175	15.94	16.3	0-1	
	74			2577.5	37825	16.00	16.3	0-1	
				2595	38000	15.95	16.3	0-1	
				2612.5	38175	15.95	16.3	0-1	
	36 RB			0	2577.5	37825	15.00	15.3	0-2
					2595	38000	14.88	15.3	0-2
					2612.5	38175	14.81	15.3	0-2
			18	2577.5	37825	14.92	15.3	0-2	
				2595	38000	14.83	15.3	0-2	
				2612.5	38175	14.81	15.3	0-2	
			37	2577.5	37825	14.88	15.3	0-2	
				2595	38000	14.76	15.3	0-2	
				2612.5	38175	14.79	15.3	0-2	
	75RB		2577.5	37825	14.94	15.3	0-2		
			2595	38000	14.88	15.3	0-2		
			2612.5	38175	14.76	15.3	0-2		

Unless otherwise stated the results shown in this test report refer only to the sample(s) tested and such sample(s) are retained for 90 days only.

除非另有說明，此報告結果僅對測試之樣品負責，同時此樣品僅保留90天。本報告未經本公司書面許可，不可部份複製。

This document is issued by the Company subject to its General Conditions of Service printed overleaf, available on request or accessible at www.sgs.com/terms_and_conditions.htm and for electronic format documents, subject to Terms and Conditions for Electronic Documents at www.sgs.com/terms_e-document.htm. Attention is drawn to the limitation of liability, indemnification and jurisdiction issues defined therein. Any holder of this document is advised that information contained hereon reflects the Company's findings at the time of its intervention only and within the limits of Client's instructions, if any. The Company's sole responsibility is to its Client and this document does not exonerate parties to a transaction from exercising all their rights and obligations under the transaction documents. This document cannot be reproduced except in full, without prior written approval of the Company. Any unauthorized alteration, forgery or falsification of the content or appearance of this document is unlawful and offenders may be prosecuted to the fullest extent of the law.

TDD Band 38								
BW(MHz)	Modulation	RB Size	RB Offset	Frequency (MHz)	Channel	Conducted power (dBm)	Target Power + Max. Tolerance (dBm)	MPR Allowed per 3GPP(dB)
15	64-QAM	1 RB	0	2577.5	37825	16.02	16.3	0-1
				2595	38000	15.93	16.3	0-1
				2612.5	38175	15.86	16.3	0-1
			36	2577.5	37825	15.84	16.3	0-1
				2595	38000	15.74	16.3	0-1
				2612.5	38175	15.69	16.3	0-1
			74	2577.5	37825	15.77	16.3	0-1
				2595	38000	15.69	16.3	0-1
				2612.5	38175	15.68	16.3	0-1
		36 RB	0	2577.5	37825	14.73	15.3	0-2
				2595	38000	14.61	15.3	0-2
				2612.5	38175	14.54	15.3	0-2
			18	2577.5	37825	14.66	15.3	0-2
				2595	38000	14.61	15.3	0-2
				2612.5	38175	14.54	15.3	0-2
			37	2577.5	37825	14.60	15.3	0-2
				2595	38000	14.49	15.3	0-2
				2612.5	38175	14.51	15.3	0-2
			75RB	2577.5	37825	14.69	15.3	0-2
				2595	38000	14.57	15.3	0-2
				2612.5	38175	14.50	15.3	0-2

Unless otherwise stated the results shown in this test report refer only to the sample(s) tested and such sample(s) are retained for 90 days only.

除非另有說明，此報告結果僅對測試之樣品負責，同時此樣品僅保留90天。本報告未經本公司書面許可，不可部份複製。

This document is issued by the Company subject to its General Conditions of Service printed overleaf, available on request or accessible at www.sgs.com/terms_and_conditions.htm and for electronic format documents, subject to Terms and Conditions for Electronic Documents at www.sgs.com/terms_e-document.htm. Attention is drawn to the limitation of liability, indemnification and jurisdiction issues defined therein. Any holder of this document is advised that information contained hereon reflects the Company's findings at the time of its intervention only and within the limits of Client's instructions, if any. The Company's sole responsibility is to its Client and this document does not exonerate parties to a transaction from exercising all their rights and obligations under the transaction documents. This document cannot be reproduced except in full, without prior written approval of the Company. Any unauthorized alteration, forgery or falsification of the content or appearance of this document is unlawful and offenders may be prosecuted to the fullest extent of the law.

TDD Band 38									
BW(Mhz)	Modulation	RB Size	RB Offset	Frequency (MHz)	Channel	Conducted power (dBm)	Target Power + Max. Tolerance (dBm)	MPR Allowed per 3GPP(dB)	
10	QPSK	1 RB	0	2575	37800	16.97	17.3	0	
				2595	38000	16.82	17.3	0	
				2615	38200	16.77	17.3	0	
			25	2575	37800	16.87	17.3	0	
				2595	38000	16.75	17.3	0	
				2615	38200	16.74	17.3	0	
			49	2575	37800	16.77	17.3	0	
				2595	38000	16.68	17.3	0	
				2615	38200	16.72	17.3	0	
		25 RB	0	2575	37800	15.97	16.3	0-1	
				2595	38000	15.86	16.3	0-1	
				2615	38200	15.83	16.3	0-1	
			12	2575	37800	15.96	16.3	0-1	
				2595	38000	15.81	16.3	0-1	
				2615	38200	15.85	16.3	0-1	
			25	2575	37800	15.87	16.3	0-1	
				2595	38000	15.77	16.3	0-1	
				2615	38200	15.76	16.3	0-1	
			50RB	2575	37800	15.92	16.3	0-1	
				2595	38000	15.83	16.3	0-1	
				2615	38200	15.84	16.3	0-1	
		16-QAM	1 RB	0	2575	37800	16.23	16.3	0-1
					2595	38000	16.12	16.3	0-1
					2615	38200	16.07	16.3	0-1
	25			2575	37800	16.10	16.3	0-1	
				2595	38000	16.00	16.3	0-1	
				2615	38200	16.04	16.3	0-1	
	49			2575	37800	16.05	16.3	0-1	
				2595	38000	15.93	16.3	0-1	
				2615	38200	15.95	16.3	0-1	
	25 RB			0	2575	37800	14.99	15.3	0-2
					2595	38000	14.88	15.3	0-2
					2615	38200	14.83	15.3	0-2
			12	2575	37800	15.01	15.3	0-2	
				2595	38000	14.87	15.3	0-2	
				2615	38200	14.91	15.3	0-2	
			25	2575	37800	14.90	15.3	0-2	
				2595	38000	14.79	15.3	0-2	
				2615	38200	14.79	15.3	0-2	
	50RB		2575	37800	14.99	15.3	0-2		
			2595	38000	14.80	15.3	0-2		
			2615	38200	14.86	15.3	0-2		

Unless otherwise stated the results shown in this test report refer only to the sample(s) tested and such sample(s) are retained for 90 days only.

除非另有說明，此報告結果僅對測試之樣品負責，同時此樣品僅保留90天。本報告未經本公司書面許可，不可部份複製。

This document is issued by the Company subject to its General Conditions of Service printed overleaf, available on request or accessible at www.sgs.com/terms_and_conditions.htm and for electronic format documents, subject to Terms and Conditions for Electronic Documents at www.sgs.com/terms_e-document.htm. Attention is drawn to the limitation of liability, indemnification and jurisdiction issues defined therein. Any holder of this document is advised that information contained hereon reflects the Company's findings at the time of its intervention only and within the limits of Client's instructions, if any. The Company's sole responsibility is to its Client and this document does not exonerate parties to a transaction from exercising all their rights and obligations under the transaction documents. This document cannot be reproduced except in full, without prior written approval of the Company. Any unauthorized alteration, forgery or falsification of the content or appearance of this document is unlawful and offenders may be prosecuted to the fullest extent of the law.

TDD Band 38								
BW(MHz)	Modulation	RB Size	RB Offset	Frequency (MHz)	Channel	Conducted power (dBm)	Target Power + Max. Tolerance (dBm)	MPR Allowed per 3GPP(dB)
10	64-QAM	1 RB	0	2575	37800	15.99	16.3	0-1
				2595	38000	15.89	16.3	0-1
				2615	38200	15.84	16.3	0-1
			25	2575	37800	15.88	16.3	0-1
				2595	38000	15.77	16.3	0-1
				2615	38200	15.82	16.3	0-1
			49	2575	37800	15.81	16.3	0-1
				2595	38000	15.68	16.3	0-1
				2615	38200	15.74	16.3	0-1
		25 RB	0	2575	37800	14.79	15.3	0-2
				2595	38000	14.65	15.3	0-2
				2615	38200	14.63	15.3	0-2
			12	2575	37800	14.75	15.3	0-2
				2595	38000	14.62	15.3	0-2
				2615	38200	14.70	15.3	0-2
			25	2575	37800	14.68	15.3	0-2
				2595	38000	14.58	15.3	0-2
				2615	38200	14.56	15.3	0-2
			50RB	2575	37800	14.75	15.3	0-2
				2595	38000	14.59	15.3	0-2
				2615	38200	14.64	15.3	0-2

Unless otherwise stated the results shown in this test report refer only to the sample(s) tested and such sample(s) are retained for 90 days only.

除非另有說明，此報告結果僅對測試之樣品負責，同時此樣品僅保留90天。本報告未經本公司書面許可，不可部份複製。

This document is issued by the Company subject to its General Conditions of Service printed overleaf, available on request or accessible at www.sgs.com/terms_and_conditions.htm and for electronic format documents, subject to Terms and Conditions for Electronic Documents at www.sgs.com/terms_e-document.htm. Attention is drawn to the limitation of liability, indemnification and jurisdiction issues defined therein. Any holder of this document is advised that information contained hereon reflects the Company's findings at the time of its intervention only and within the limits of Client's instructions, if any. The Company's sole responsibility is to its Client and this document does not exonerate parties to a transaction from exercising all their rights and obligations under the transaction documents. This document cannot be reproduced except in full, without prior written approval of the Company. Any unauthorized alteration, forgery or falsification of the content or appearance of this document is unlawful and offenders may be prosecuted to the fullest extent of the law.

TDD Band 38									
BW(Mhz)	Modulation	RB Size	RB Offset	Frequency (MHz)	Channel	Conducted power (dBm)	Target Power + Max. Tolerance (dBm)	MPR Allowed per 3GPP(dB)	
5	QPSK	1 RB	0	2572.5	37775	16.92	17.3	0	
				2595	38000	16.76	17.3	0	
				2617.5	38225	16.77	17.3	0	
			12	2572.5	37775	16.88	17.3	0	
				2595	38000	16.75	17.3	0	
				2617.5	38225	16.73	17.3	0	
		24	2572.5	37775	16.80	17.3	0		
			2595	38000	16.64	17.3	0		
			2617.5	38225	16.70	17.3	0		
		12 RB	0	2572.5	37775	16.00	16.3	0-1	
				2595	38000	15.87	16.3	0-1	
				2617.5	38225	15.81	16.3	0-1	
			6	2572.5	37775	15.98	16.3	0-1	
				2595	38000	15.82	16.3	0-1	
				2617.5	38225	15.81	16.3	0-1	
			13	2572.5	37775	15.95	16.3	0-1	
				2595	38000	15.80	16.3	0-1	
				2617.5	38225	15.79	16.3	0-1	
			25RB	2572.5	37775	15.87	16.3	0-1	
				2595	38000	15.79	16.3	0-1	
				2617.5	38225	15.80	16.3	0-1	
		16-QAM	1 RB	0	2572.5	37775	16.10	16.3	0-1
					2595	38000	16.01	16.3	0-1
					2617.5	38225	16.05	16.3	0-1
	12			2572.5	37775	16.17	16.3	0-1	
				2595	38000	15.98	16.3	0-1	
				2617.5	38225	16.02	16.3	0-1	
	24			2572.5	37775	16.05	16.3	0-1	
				2595	38000	15.94	16.3	0-1	
				2617.5	38225	15.96	16.3	0-1	
	12 RB			0	2572.5	37775	14.96	15.3	0-2
					2595	38000	14.85	15.3	0-2
					2617.5	38225	14.85	15.3	0-2
			6	2572.5	37775	15.00	15.3	0-2	
				2595	38000	14.87	15.3	0-2	
				2617.5	38225	14.91	15.3	0-2	
			13	2572.5	37775	14.93	15.3	0-2	
				2595	38000	14.82	15.3	0-2	
				2617.5	38225	14.80	15.3	0-2	
	25RB		2572.5	37775	14.99	15.3	0-2		
			2595	38000	14.82	15.3	0-2		
			2617.5	38225	14.87	15.3	0-2		

Unless otherwise stated the results shown in this test report refer only to the sample(s) tested and such sample(s) are retained for 90 days only.

除非另有說明，此報告結果僅對測試之樣品負責，同時此樣品僅保留90天。本報告未經本公司書面許可，不可部份複製。

This document is issued by the Company subject to its General Conditions of Service printed overleaf, available on request or accessible at www.sgs.com/terms_and_conditions.htm and for electronic format documents, subject to Terms and Conditions for Electronic Documents at www.sgs.com/terms_e-document.htm. Attention is drawn to the limitation of liability, indemnification and jurisdiction issues defined therein. Any holder of this document is advised that information contained hereon reflects the Company's findings at the time of its intervention only and within the limits of Client's instructions, if any. The Company's sole responsibility is to its Client and this document does not exonerate parties to a transaction from exercising all their rights and obligations under the transaction documents. This document cannot be reproduced except in full, without prior written approval of the Company. Any unauthorized alteration, forgery or falsification of the content or appearance of this document is unlawful and offenders may be prosecuted to the fullest extent of the law.

TDD Band 38								
BW(MHz)	Modulation	RB Size	RB Offset	Frequency (MHz)	Channel	Conducted power (dBm)	Target Power + Max. Tolerance (dBm)	MPR Allowed per 3GPP(dB)
5	64-QAM	1 RB	0	2572.5	37775	15.92	16.3	0-1
				2595	38000	15.84	16.3	0-1
				2617.5	38225	15.89	16.3	0-1
			12	2572.5	37775	15.98	16.3	0-1
				2595	38000	15.81	16.3	0-1
				2617.5	38225	15.87	16.3	0-1
			24	2572.5	37775	15.91	16.3	0-1
				2595	38000	15.77	16.3	0-1
				2617.5	38225	15.79	16.3	0-1
		12 RB	0	2572.5	37775	14.76	15.3	0-2
				2595	38000	14.70	15.3	0-2
				2617.5	38225	14.70	15.3	0-2
			6	2572.5	37775	14.83	15.3	0-2
				2595	38000	14.70	15.3	0-2
				2617.5	38225	14.72	15.3	0-2
			13	2572.5	37775	14.80	15.3	0-2
				2595	38000	14.62	15.3	0-2
				2617.5	38225	14.63	15.3	0-2
			25RB	2572.5	37775	14.82	15.3	0-2
				2595	38000	14.67	15.3	0-2
				2617.5	38225	14.70	15.3	0-2

Unless otherwise stated the results shown in this test report refer only to the sample(s) tested and such sample(s) are retained for 90 days only.

除非另有說明，此報告結果僅對測試之樣品負責，同時此樣品僅保留90天。本報告未經本公司書面許可，不可部份複製。

This document is issued by the Company subject to its General Conditions of Service printed overleaf, available on request or accessible at www.sgs.com/terms_and_conditions.htm and for electronic format documents, subject to Terms and Conditions for Electronic Documents at www.sgs.com/terms_e-document.htm. Attention is drawn to the limitation of liability, indemnification and jurisdiction issues defined therein. Any holder of this document is advised that information contained hereon reflects the Company's findings at the time of its intervention only and within the limits of Client's instructions, if any. The Company's sole responsibility is to its Client and this document does not exonerate parties to a transaction from exercising all their rights and obligations under the transaction documents. This document cannot be reproduced except in full, without prior written approval of the Company. Any unauthorized alteration, forgery or falsification of the content or appearance of this document is unlawful and offenders may be prosecuted to the fullest extent of the law.

TDD Band 41								
BW(Mhz)	Modulation	RB Size	RB Offset	Frequency (MHz)	Channel	Conducted power (dBm)	Target Power + Max. Tolerance (dBm)	MPR Allowed per 3GPP(dB)
20	QPSK	1 RB	0	2506	39750	17.10	17.3	0
				2549.5	40185	17.14	17.3	0
				2593	40620	17.15	17.3	0
				2636.5	41055	17.17	17.3	0
			2680	41490	17.28	17.3	0	
			50	2506	39750	17.02	17.3	0
				2549.5	40185	17.03	17.3	0
				2593	40620	17.00	17.3	0
				2636.5	41055	17.06	17.3	0
			2680	41490	17.08	17.3	0	
			99	2506	39750	17.04	17.3	0
				2549.5	40185	17.06	17.3	0
		2593		40620	17.01	17.3	0	
		2636.5		41055	16.97	17.3	0	
		2680	41490	17.18	17.3	0		
		50 RB	0	2506	39750	16.08	16.3	0-1
				2549.5	40185	16.18	16.3	0-1
				2593	40620	16.16	16.3	0-1
				2636.5	41055	16.10	16.3	0-1
			2680	41490	16.27	16.3	0-1	
			25	2506	39750	16.09	16.3	0-1
				2549.5	40185	16.08	16.3	0-1
				2593	40620	16.04	16.3	0-1
				2636.5	41055	16.09	16.3	0-1
			2680	41490	16.12	16.3	0-1	
			50	2506	39750	15.97	16.3	0-1
				2549.5	40185	16.02	16.3	0-1
				2593	40620	16.01	16.3	0-1
				2636.5	41055	15.99	16.3	0-1
			2680	41490	16.10	16.3	0-1	
			100RB	2506	39750	15.97	16.3	0-1
		2549.5		40185	16.07	16.3	0-1	
2593	40620	16.04		16.3	0-1			
2636.5	41055	16.12		16.3	0-1			
2680	41490	16.25	16.3	0-1				

Unless otherwise stated the results shown in this test report refer only to the sample(s) tested and such sample(s) are retained for 90 days only.

除非另有說明，此報告結果僅對測試之樣品負責，同時此樣品僅保留90天。本報告未經本公司書面許可，不可部份複製。

This document is issued by the Company subject to its General Conditions of Service printed overleaf, available on request or accessible at www.sgs.com/terms_and_conditions.htm and for electronic format documents, subject to Terms and Conditions for Electronic Documents at www.sgs.com/terms_e-document.htm. Attention is drawn to the limitation of liability, indemnification and jurisdiction issues defined therein. Any holder of this document is advised that information contained hereon reflects the Company's findings at the time of its intervention only and within the limits of Client's instructions, if any. The Company's sole responsibility is to its Client and this document does not exonerate parties to a transaction from exercising all their rights and obligations under the transaction documents. This document cannot be reproduced except in full, without prior written approval of the Company. Any unauthorized alteration, forgery or falsification of the content or appearance of this document is unlawful and offenders may be prosecuted to the fullest extent of the law.

TDD Band 41									
BW(Mhz)	Modulation	RB Size	RB Offset	Frequency (MHz)	Channel	Conducted power (dBm)	Target Power + Max. Tolerance (dBm)	MPR Allowed per 3GPP(dB)	
20	16-QAM	1 RB	0	2506	39750	16.22	16.3	0-1	
				2549.5	40185	16.25	16.3	0-1	
				2593	40620	16.24	16.3	0-1	
				2636.5	41055	16.27	16.3	0-1	
				2680	41490	16.19	16.3	0-1	
			50	2506	39750	16.17	16.3	0-1	
				2549.5	40185	16.18	16.3	0-1	
				2593	40620	16.20	16.3	0-1	
				2636.5	41055	16.27	16.3	0-1	
			99	2506	39750	16.17	16.3	0-1	
				2549.5	40185	16.22	16.3	0-1	
				2593	40620	16.17	16.3	0-1	
		2636.5		41055	16.13	16.3	0-1		
		50 RB	0	2506	39750	15.08	15.3	0-2	
				2549.5	40185	15.16	15.3	0-2	
				2593	40620	15.15	15.3	0-2	
				2636.5	41055	15.13	15.3	0-2	
			25	2680	41490	15.23	15.3	0-2	
				2506	39750	15.02	15.3	0-2	
				2549.5	40185	15.10	15.3	0-2	
				2593	40620	15.08	15.3	0-2	
				2636.5	41055	15.11	15.3	0-2	
				2680	41490	15.15	15.3	0-2	
				50	2506	39750	15.04	15.3	0-2
					2549.5	40185	15.01	15.3	0-2
			2593		40620	15.08	15.3	0-2	
			2636.5		41055	15.05	15.3	0-2	
			100RB	2680	41490	15.11	15.3	0-2	
				2506	39750	15.06	15.3	0-2	
				2549.5	40185	15.10	15.3	0-2	
				2593	40620	15.09	15.3	0-2	
							2636.5	41055	15.12
					2680	41490	15.19	15.3	0-2

Unless otherwise stated the results shown in this test report refer only to the sample(s) tested and such sample(s) are retained for 90 days only.

除非另有說明，此報告結果僅對測試之樣品負責，同時此樣品僅保留90天。本報告未經本公司書面許可，不可部份複製。

This document is issued by the Company subject to its General Conditions of Service printed overleaf, available on request or accessible at www.sgs.com/terms_and_conditions.htm and for electronic format documents, subject to Terms and Conditions for Electronic Documents at www.sgs.com/terms_e-document.htm. Attention is drawn to the limitation of liability, indemnification and jurisdiction issues defined therein. Any holder of this document is advised that information contained hereon reflects the Company's findings at the time of its intervention only and within the limits of Client's instructions, if any. The Company's sole responsibility is to its Client and this document does not exonerate parties to a transaction from exercising all their rights and obligations under the transaction documents. This document cannot be reproduced except in full, without prior written approval of the Company. Any unauthorized alteration, forgery or falsification of the content or appearance of this document is unlawful and offenders may be prosecuted to the fullest extent of the law.

TDD Band 41								
BW(Mhz)	Modulation	RB Size	RB Offset	Frequency (MHz)	Channel	Conducted power (dBm)	Target Power + Max. Tolerance (dBm)	MPR Allowed per 3GPP(dB)
20	64-QAM	1 RB	0	2506	39750	16.22	16.3	0-1
				2549.5	40185	16.27	16.3	0-1
				2593	40620	16.27	16.3	0-1
				2636.5	41055	16.24	16.3	0-1
				2680	41490	16.21	16.3	0-1
			50	2506	39750	16.05	16.3	0-1
				2549.5	40185	16.09	16.3	0-1
				2593	40620	16.12	16.3	0-1
				2636.5	41055	16.19	16.3	0-1
			99	2506	39750	16.08	16.3	0-1
				2549.5	40185	16.12	16.3	0-1
				2593	40620	16.06	16.3	0-1
		2636.5		41055	16.03	16.3	0-1	
		50 RB	0	2506	39750	15.00	15.3	0-2
				2549.5	40185	15.07	15.3	0-2
				2593	40620	15.06	15.3	0-2
				2636.5	41055	15.06	15.3	0-2
				2680	41490	15.13	15.3	0-2
			25	2506	39750	15.01	15.3	0-2
				2549.5	40185	15.04	15.3	0-2
				2593	40620	15.02	15.3	0-2
				2636.5	41055	15.06	15.3	0-2
			50	2506	39750	15.06	15.3	0-2
				2549.5	40185	14.99	15.3	0-2
				2593	40620	15.02	15.3	0-2
				2636.5	41055	15.06	15.3	0-2
				2680	41490	15.03	15.3	0-2
			100RB	2506	39750	15.02	15.3	0-2
				2549.5	40185	15.00	15.3	0-2
				2593	40620	14.97	15.3	0-2
				2636.5	41055	15.03	15.3	0-2
				2680	41490	15.13	15.3	0-2

Unless otherwise stated the results shown in this test report refer only to the sample(s) tested and such sample(s) are retained for 90 days only.

除非另有說明，此報告結果僅對測試之樣品負責，同時此樣品僅保留90天。本報告未經本公司書面許可，不可部份複製。

This document is issued by the Company subject to its General Conditions of Service printed overleaf, available on request or accessible at www.sgs.com/terms_and_conditions.htm and for electronic format documents, subject to Terms and Conditions for Electronic Documents at www.sgs.com/terms_e-document.htm. Attention is drawn to the limitation of liability, indemnification and jurisdiction issues defined therein. Any holder of this document is advised that information contained hereon reflects the Company's findings at the time of its intervention only and within the limits of Client's instructions, if any. The Company's sole responsibility is to its Client and this document does not exonerate parties to a transaction from exercising all their rights and obligations under the transaction documents. This document cannot be reproduced except in full, without prior written approval of the Company. Any unauthorized alteration, forgery or falsification of the content or appearance of this document is unlawful and offenders may be prosecuted to the fullest extent of the law.

TDD Band 41									
BW(Mhz)	Modulation	RB Size	RB Offset	Frequency (MHz)	Channel	Conducted power (dBm)	Target Power + Max. Tolerance (dBm)	MPR Allowed per 3GPP(dB)	
15	QPSK	1 RB	0	2503.5	39725	17.06	17.3	0	
				2548.3	40173	17.04	17.3	0	
				2593	40620	17.04	17.3	0	
				2637.8	41068	17.13	17.3	0	
				2682.5	41515	17.16	17.3	0	
			36	2503.5	39725	16.97	17.3	0	
				2548.3	40173	17.02	17.3	0	
				2593	40620	16.99	17.3	0	
				2637.8	41068	17.01	17.3	0	
				2682.5	41515	16.98	17.3	0	
				74	2503.5	39725	17.10	17.3	0
					2548.3	40173	17.04	17.3	0
		2593	40620		17.06	17.3	0		
		2637.8	41068		17.02	17.3	0		
		36 RB	0	2503.5	39725	16.07	16.3	0-1	
				2548.3	40173	16.17	16.3	0-1	
				2593	40620	15.98	16.3	0-1	
				2637.8	41068	16.13	16.3	0-1	
				2682.5	41515	16.27	16.3	0-1	
			18	2503.5	39725	16.11	16.3	0-1	
				2548.3	40173	16.05	16.3	0-1	
				2593	40620	16.12	16.3	0-1	
				2637.8	41068	16.26	16.3	0-1	
				2682.5	41515	16.12	16.3	0-1	
				37	2503.5	39725	15.96	16.3	0-1
					2548.3	40173	16.15	16.3	0-1
			2593		40620	16.12	16.3	0-1	
			2637.8		41068	16.16	16.3	0-1	
			2682.5		41515	16.07	16.3	0-1	
			75RB		2503.5	39725	16.00	16.3	0-1
					2548.3	40173	16.11	16.3	0-1
					2593	40620	16.13	16.3	0-1
2637.8	41068			16.13	16.3	0-1			
2682.5	41515			16.11	16.3	0-1			

Unless otherwise stated the results shown in this test report refer only to the sample(s) tested and such sample(s) are retained for 90 days only.

除非另有說明，此報告結果僅對測試之樣品負責，同時此樣品僅保留90天。本報告未經本公司書面許可，不可部份複製。

This document is issued by the Company subject to its General Conditions of Service printed overleaf, available on request or accessible at www.sgs.com/terms_and_conditions.htm and for electronic format documents, subject to Terms and Conditions for Electronic Documents at www.sgs.com/terms_e-document.htm. Attention is drawn to the limitation of liability, indemnification and jurisdiction issues defined therein. Any holder of this document is advised that information contained hereon reflects the Company's findings at the time of its intervention only and within the limits of Client's instructions, if any. The Company's sole responsibility is to its Client and this document does not exonerate parties to a transaction from exercising all their rights and obligations under the transaction documents. This document cannot be reproduced except in full, without prior written approval of the Company. Any unauthorized alteration, forgery or falsification of the content or appearance of this document is unlawful and offenders may be prosecuted to the fullest extent of the law.

TDD Band 41									
BW(Mhz)	Modulation	RB Size	RB Offset	Frequency (MHz)	Channel	Conducted power (dBm)	Target Power + Max. Tolerance (dBm)	MPR Allowed per 3GPP(dB)	
15	16-QAM	1 RB	0	2503.5	39725	16.27	16.3	0-1	
				2548.3	40173	16.21	16.3	0-1	
				2593	40620	16.19	16.3	0-1	
				2637.8	41068	16.23	16.3	0-1	
				2682.5	41515	16.27	16.3	0-1	
			36	2503.5	39725	16.13	16.3	0-1	
				2548.3	40173	16.09	16.3	0-1	
				2593	40620	16.19	16.3	0-1	
				2637.8	41068	16.19	16.3	0-1	
				2682.5	41515	16.25	16.3	0-1	
				74	2503.5	39725	16.12	16.3	0-1
					2548.3	40173	16.22	16.3	0-1
		2593	40620		16.11	16.3	0-1		
		2637.8	41068		16.06	16.3	0-1		
		2682.5	41515		16.21	16.3	0-1		
		36 RB	0	2503.5	39725	14.98	15.3	0-2	
				2548.3	40173	15.17	15.3	0-2	
				2593	40620	15.10	15.3	0-2	
				2637.8	41068	15.08	15.3	0-2	
				2682.5	41515	15.03	15.3	0-2	
			18	2503.5	39725	15.04	15.3	0-2	
				2548.3	40173	15.01	15.3	0-2	
				2593	40620	15.00	15.3	0-2	
				2637.8	41068	15.14	15.3	0-2	
				2682.5	41515	15.13	15.3	0-2	
				37	2503.5	39725	15.00	15.3	0-2
			2548.3		40173	15.06	15.3	0-2	
			2593		40620	15.00	15.3	0-2	
			2637.8		41068	15.03	15.3	0-2	
			2682.5		41515	15.08	15.3	0-2	
			75RB		2503.5	39725	15.05	15.3	0-2
					2548.3	40173	14.98	15.3	0-2
2593	40620			15.06	15.3	0-2			
2637.8	41068	15.09		15.3	0-2				
2682.5	41515	15.07		15.3	0-2				

Unless otherwise stated the results shown in this test report refer only to the sample(s) tested and such sample(s) are retained for 90 days only.

除非另有說明，此報告結果僅對測試之樣品負責，同時此樣品僅保留90天。本報告未經本公司書面許可，不可部份複製。

This document is issued by the Company subject to its General Conditions of Service printed overleaf, available on request or accessible at www.sgs.com/terms_and_conditions.htm and for electronic format documents, subject to Terms and Conditions for Electronic Documents at www.sgs.com/terms_e-document.htm. Attention is drawn to the limitation of liability, indemnification and jurisdiction issues defined therein. Any holder of this document is advised that information contained hereon reflects the Company's findings at the time of its intervention only and within the limits of Client's instructions, if any. The Company's sole responsibility is to its Client and this document does not exonerate parties to a transaction from exercising all their rights and obligations under the transaction documents. This document cannot be reproduced except in full, without prior written approval of the Company. Any unauthorized alteration, forgery or falsification of the content or appearance of this document is unlawful and offenders may be prosecuted to the fullest extent of the law.

TDD Band 41									
BW(Mhz)	Modulation	RB Size	RB Offset	Frequency (MHz)	Channel	Conducted power (dBm)	Target Power + Max. Tolerance (dBm)	MPR Allowed per 3GPP(dB)	
15	64-QAM	1 RB	0	2503.5	39725	16.12	16.3	0-1	
				2548.3	40173	16.27	16.3	0-1	
				2593	40620	16.22	16.3	0-1	
				2637.8	41068	16.27	16.3	0-1	
				2682.5	41515	16.24	16.3	0-1	
			36	2503.5	39725	15.97	16.3	0-1	
				2548.3	40173	16.04	16.3	0-1	
				2593	40620	16.00	16.3	0-1	
				2637.8	41068	16.17	16.3	0-1	
				2682.5	41515	16.13	16.3	0-1	
				74	2503.5	39725	16.02	16.3	0-1
					2548.3	40173	16.01	16.3	0-1
		2593	40620		16.01	16.3	0-1		
		2637.8	41068		16.06	16.3	0-1		
		2682.5	41515		16.25	16.3	0-1		
		36 RB	0	2503.5	39725	14.99	15.3	0-2	
				2548.3	40173	15.02	15.3	0-2	
				2593	40620	15.06	15.3	0-2	
				2637.8	41068	15.07	15.3	0-2	
				2682.5	41515	15.07	15.3	0-2	
			18	2503.5	39725	15.03	15.3	0-2	
				2548.3	40173	15.00	15.3	0-2	
				2593	40620	15.05	15.3	0-2	
				2637.8	41068	15.08	15.3	0-2	
				2682.5	41515	15.04	15.3	0-2	
				37	2503.5	39725	15.06	15.3	0-2
			2548.3		40173	15.09	15.3	0-2	
			2593		40620	15.09	15.3	0-2	
			2637.8		41068	14.96	15.3	0-2	
			2682.5		41515	15.05	15.3	0-2	
			75RB		2503.5	39725	15.12	15.3	0-2
					2548.3	40173	15.02	15.3	0-2
2593	40620			15.08	15.3	0-2			
2637.8	41068	15.00		15.3	0-2				
2682.5	41515	15.12		15.3	0-2				

Unless otherwise stated the results shown in this test report refer only to the sample(s) tested and such sample(s) are retained for 90 days only.

除非另有說明，此報告結果僅對測試之樣品負責，同時此樣品僅保留90天。本報告未經本公司書面許可，不可部份複製。

This document is issued by the Company subject to its General Conditions of Service printed overleaf, available on request or accessible at www.sgs.com/terms_and_conditions.htm and for electronic format documents, subject to Terms and Conditions for Electronic Documents at www.sgs.com/terms_e-document.htm. Attention is drawn to the limitation of liability, indemnification and jurisdiction issues defined therein. Any holder of this document is advised that information contained hereon reflects the Company's findings at the time of its intervention only and within the limits of Client's instructions, if any. The Company's sole responsibility is to its Client and this document does not exonerate parties to a transaction from exercising all their rights and obligations under the transaction documents. This document cannot be reproduced except in full, without prior written approval of the Company. Any unauthorized alteration, forgery or falsification of the content or appearance of this document is unlawful and offenders may be prosecuted to the fullest extent of the law.

TDD Band 41								
BW(Mhz)	Modulation	RB Size	RB Offset	Frequency (MHz)	Channel	Conducted power (dBm)	Target Power + Max. Tolerance (dBm)	MPR Allowed per 3GPP(dB)
10	QPSK	1 RB	0	2501	39700	17.05	17.3	0
				2547	40160	17.14	17.3	0
				2593	40620	17.15	17.3	0
				2639	41080	17.08	17.3	0
			2685	41540	17.18	17.3	0	
			25	2501	39700	16.98	17.3	0
				2547	40160	17.10	17.3	0
				2593	40620	16.99	17.3	0
				2639	41080	17.14	17.3	0
			2685	41540	16.99	17.3	0	
			49	2501	39700	16.99	17.3	0
				2547	40160	17.07	17.3	0
		2593		40620	17.19	17.3	0	
		2639		41080	17.10	17.3	0	
		2685	41540	17.15	17.3	0		
		25 RB	0	2501	39700	16.04	16.3	0-1
				2547	40160	16.09	16.3	0-1
				2593	40620	16.14	16.3	0-1
				2639	41080	16.08	16.3	0-1
			2685	41540	16.19	16.3	0-1	
			12	2501	39700	16.02	16.3	0-1
				2547	40160	16.04	16.3	0-1
				2593	40620	15.99	16.3	0-1
				2639	41080	16.03	16.3	0-1
			2685	41540	16.08	16.3	0-1	
			25	2501	39700	16.12	16.3	0-1
				2547	40160	15.98	16.3	0-1
		2593		40620	16.02	16.3	0-1	
		2639		41080	15.99	16.3	0-1	
		2685	41540	16.06	16.3	0-1		
		50RB	2501	39700	15.99	16.3	0-1	
			2547	40160	15.99	16.3	0-1	
2593	40620		15.97	16.3	0-1			
2639	41080		16.11	16.3	0-1			
2685	41540	16.20	16.3	0-1				

Unless otherwise stated the results shown in this test report refer only to the sample(s) tested and such sample(s) are retained for 90 days only.

除非另有說明，此報告結果僅對測試之樣品負責，同時此樣品僅保留90天。本報告未經本公司書面許可，不可部份複製。

This document is issued by the Company subject to its General Conditions of Service printed overleaf, available on request or accessible at www.sgs.com/terms_and_conditions.htm and for electronic format documents, subject to Terms and Conditions for Electronic Documents at www.sgs.com/terms_e-document.htm. Attention is drawn to the limitation of liability, indemnification and jurisdiction issues defined therein. Any holder of this document is advised that information contained hereon reflects the Company's findings at the time of its intervention only and within the limits of Client's instructions, if any. The Company's sole responsibility is to its Client and this document does not exonerate parties to a transaction from exercising all their rights and obligations under the transaction documents. This document cannot be reproduced except in full, without prior written approval of the Company. Any unauthorized alteration, forgery or falsification of the content or appearance of this document is unlawful and offenders may be prosecuted to the fullest extent of the law.

TDD Band 41									
BW(Mhz)	Modulation	RB Size	RB Offset	Frequency (MHz)	Channel	Conducted power (dBm)	Target Power + Max. Tolerance (dBm)	MPR Allowed per 3GPP(dB)	
10	16-QAM	1 RB	0	2501	39700	16.20	16.3	0-1	
				2547	40160	16.20	16.3	0-1	
				2593	40620	16.23	16.3	0-1	
				2639	41080	16.18	16.3	0-1	
				2685	41540	16.26	16.3	0-1	
			25	2501	39700	16.08	16.3	0-1	
				2547	40160	16.11	16.3	0-1	
				2593	40620	16.07	16.3	0-1	
				2639	41080	16.22	16.3	0-1	
				2685	41540	16.19	16.3	0-1	
				49	2501	39700	16.13	16.3	0-1
					2547	40160	16.16	16.3	0-1
		2593	40620		16.11	16.3	0-1		
		2639	41080		16.03	16.3	0-1		
		25 RB	0	2501	39700	15.04	15.3	0-2	
				2547	40160	15.14	15.3	0-2	
				2593	40620	15.13	15.3	0-2	
				2639	41080	15.08	15.3	0-2	
				2685	41540	15.18	15.3	0-2	
			12	2501	39700	15.02	15.3	0-2	
				2547	40160	15.02	15.3	0-2	
				2593	40620	15.07	15.3	0-2	
				2639	41080	15.10	15.3	0-2	
				2685	41540	15.12	15.3	0-2	
				25	2501	39700	15.23	15.3	0-2
					2547	40160	15.19	15.3	0-2
			2593		40620	15.07	15.3	0-2	
			2639		41080	15.02	15.3	0-2	
			2685		41540	15.08	15.3	0-2	
			50RB		2501	39700	15.03	15.3	0-2
					2547	40160	15.09	15.3	0-2
					2593	40620	15.09	15.3	0-2
2639	41080			15.10	15.3	0-2			
2685	41540			15.10	15.3	0-2			

Unless otherwise stated the results shown in this test report refer only to the sample(s) tested and such sample(s) are retained for 90 days only.

除非另有說明，此報告結果僅對測試之樣品負責，同時此樣品僅保留90天。本報告未經本公司書面許可，不可部份複製。

This document is issued by the Company subject to its General Conditions of Service printed overleaf, available on request or accessible at www.sgs.com/terms_and_conditions.htm and for electronic format documents, subject to Terms and Conditions for Electronic Documents at www.sgs.com/terms_e-document.htm. Attention is drawn to the limitation of liability, indemnification and jurisdiction issues defined therein. Any holder of this document is advised that information contained hereon reflects the Company's findings at the time of its intervention only and within the limits of Client's instructions, if any. The Company's sole responsibility is to its Client and this document does not exonerate parties to a transaction from exercising all their rights and obligations under the transaction documents. This document cannot be reproduced except in full, without prior written approval of the Company. Any unauthorized alteration, forgery or falsification of the content or appearance of this document is unlawful and offenders may be prosecuted to the fullest extent of the law.

TDD Band 41								
BW(Mhz)	Modulation	RB Size	RB Offset	Frequency (MHz)	Channel	Conducted power (dBm)	Target Power + Max. Tolerance (dBm)	MPR Allowed per 3GPP(dB)
10	64-QAM	1 RB	0	2501	39700	16.28	16.3	0-1
				2547	40160	16.18	16.3	0-1
				2593	40620	16.18	16.3	0-1
				2639	41080	16.23	16.3	0-1
				2685	41540	16.26	16.3	0-1
			25	2501	39700	16.04	16.3	0-1
				2547	40160	16.04	16.3	0-1
				2593	40620	16.09	16.3	0-1
				2639	41080	16.13	16.3	0-1
				2685	41540	16.11	16.3	0-1
			49	2501	39700	15.98	16.3	0-1
				2547	40160	16.09	16.3	0-1
		2593		40620	16.00	16.3	0-1	
		2639		41080	16.00	16.3	0-1	
		2685		41540	16.24	16.3	0-1	
		25 RB	0	2501	39700	15.14	15.3	0-2
				2547	40160	15.02	15.3	0-2
				2593	40620	15.05	15.3	0-2
				2639	41080	15.01	15.3	0-2
				2685	41540	15.07	15.3	0-2
			12	2501	39700	15.11	15.3	0-2
				2547	40160	15.05	15.3	0-2
				2593	40620	14.97	15.3	0-2
				2639	41080	14.97	15.3	0-2
				2685	41540	15.05	15.3	0-2
			25	2501	39700	14.95	15.3	0-2
				2547	40160	14.98	15.3	0-2
		2593		40620	15.06	15.3	0-2	
		2639		41080	15.07	15.3	0-2	
		2685		41540	15.00	15.3	0-2	
		50RB	2501	39700	15.01	15.3	0-2	
			2547	40160	15.19	15.3	0-2	
2593	40620		15.03	15.3	0-2			
2639	41080		15.11	15.3	0-2			
2685	41540		15.14	15.3	0-2			

Unless otherwise stated the results shown in this test report refer only to the sample(s) tested and such sample(s) are retained for 90 days only.

除非另有說明，此報告結果僅對測試之樣品負責，同時此樣品僅保留90天。本報告未經本公司書面許可，不可部份複製。

This document is issued by the Company subject to its General Conditions of Service printed overleaf, available on request or accessible at www.sgs.com/terms_and_conditions.htm and for electronic format documents, subject to Terms and Conditions for Electronic Documents at www.sgs.com/terms_e-document.htm. Attention is drawn to the limitation of liability, indemnification and jurisdiction issues defined therein. Any holder of this document is advised that information contained hereon reflects the Company's findings at the time of its intervention only and within the limits of Client's instructions, if any. The Company's sole responsibility is to its Client and this document does not exonerate parties to a transaction from exercising all their rights and obligations under the transaction documents. This document cannot be reproduced except in full, without prior written approval of the Company. Any unauthorized alteration, forgery or falsification of the content or appearance of this document is unlawful and offenders may be prosecuted to the fullest extent of the law.

TDD Band 41									
BW(Mhz)	Modulation	RB Size	RB Offset	Frequency (MHz)	Channel	Conducted power (dBm)	Target Power + Max. Tolerance (dBm)	MPR Allowed per 3GPP(dB)	
5	QPSK	1 RB	0	2498.5	39675	17.02	17.3	0	
				2547.8	40148	17.06	17.3	0	
				2593	40620	17.12	17.3	0	
				2640.3	41093	17.06	17.3	0	
				2687.5	41565	17.14	17.3	0	
			12	2498.5	39675	17.11	17.3	0	
				2547.8	40148	17.12	17.3	0	
				2593	40620	17.08	17.3	0	
				2640.3	41093	17.00	17.3	0	
				2687.5	41565	17.00	17.3	0	
				24	2498.5	39675	17.00	17.3	0
					2547.8	40148	16.95	17.3	0
		2593	40620		17.03	17.3	0		
		2640.3	41093		17.04	17.3	0		
		2687.5	41565		17.16	17.3	0		
		12 RB	0	2498.5	39675	16.06	16.3	0-1	
				2547.8	40148	16.12	16.3	0-1	
				2593	40620	16.11	16.3	0-1	
				2640.3	41093	16.06	16.3	0-1	
				2687.5	41565	16.20	16.3	0-1	
			6	2498.5	39675	15.99	16.3	0-1	
				2547.8	40148	16.02	16.3	0-1	
				2593	40620	16.01	16.3	0-1	
				2640.3	41093	16.09	16.3	0-1	
				2687.5	41565	16.11	16.3	0-1	
				13	2498.5	39675	16.03	16.3	0-1
					2547.8	40148	16.13	16.3	0-1
		2593	40620		16.04	16.3	0-1		
		2640.3	41093		16.13	16.3	0-1		
		2687.5	41565		16.02	16.3	0-1		
		25RB	2498.5	39675	16.16	16.3	0-1		
			2547.8	40148	16.02	16.3	0-1		
2593	40620		15.97	16.3	0-1				
2640.3	41093		16.05	16.3	0-1				
2687.5	41565		16.22	16.3	0-1				

Unless otherwise stated the results shown in this test report refer only to the sample(s) tested and such sample(s) are retained for 90 days only.

除非另有說明，此報告結果僅對測試之樣品負責，同時此樣品僅保留90天。本報告未經本公司書面許可，不可部份複製。

This document is issued by the Company subject to its General Conditions of Service printed overleaf, available on request or accessible at www.sgs.com/terms_and_conditions.htm and for electronic format documents, subject to Terms and Conditions for Electronic Documents at www.sgs.com/terms_e-document.htm. Attention is drawn to the limitation of liability, indemnification and jurisdiction issues defined therein. Any holder of this document is advised that information contained hereon reflects the Company's findings at the time of its intervention only and within the limits of Client's instructions, if any. The Company's sole responsibility is to its Client and this document does not exonerate parties to a transaction from exercising all their rights and obligations under the transaction documents. This document cannot be reproduced except in full, without prior written approval of the Company. Any unauthorized alteration, forgery or falsification of the content or appearance of this document is unlawful and offenders may be prosecuted to the fullest extent of the law.

TDD Band 41								
BW(Mhz)	Modulation	RB Size	RB Offset	Frequency (MHz)	Channel	Conducted power (dBm)	Target Power + Max. Tolerance (dBm)	MPR Allowed per 3GPP(dB)
5	16-QAM	1 RB	0	2498.5	39675	16.16	16.3	0-1
				2547.8	40148	16.24	16.3	0-1
				2593	40620	16.21	16.3	0-1
				2640.3	41093	16.19	16.3	0-1
			2687.5	41565	16.24	16.3	0-1	
			12	2498.5	39675	16.14	16.3	0-1
				2547.8	40148	16.11	16.3	0-1
				2593	40620	16.12	16.3	0-1
				2640.3	41093	16.21	16.3	0-1
			2687.5	41565	16.16	16.3	0-1	
			24	2498.5	39675	16.11	16.3	0-1
				2547.8	40148	16.19	16.3	0-1
		2593		40620	16.06	16.3	0-1	
		2640.3		41093	16.06	16.3	0-1	
		2687.5	41565	16.22	16.3	0-1		
		12 RB	0	2498.5	39675	15.04	15.3	0-2
				2547.8	40148	15.16	15.3	0-2
				2593	40620	15.16	15.3	0-2
				2640.3	41093	15.04	15.3	0-2
			2687.5	41565	15.19	15.3	0-2	
			6	2498.5	39675	15.01	15.3	0-2
				2547.8	40148	15.09	15.3	0-2
				2593	40620	15.04	15.3	0-2
				2640.3	41093	15.08	15.3	0-2
			2687.5	41565	15.06	15.3	0-2	
			13	2498.5	39675	15.17	15.3	0-2
				2547.8	40148	15.08	15.3	0-2
		2593		40620	15.08	15.3	0-2	
		2640.3		41093	15.15	15.3	0-2	
		2687.5	41565	15.08	15.3	0-2		
		25RB	2498.5	39675	15.04	15.3	0-2	
			2547.8	40148	15.02	15.3	0-2	
2593	40620		15.00	15.3	0-2			
2640.3	41093		15.10	15.3	0-2			
2687.5	41565		15.18	15.3	0-2			

Unless otherwise stated the results shown in this test report refer only to the sample(s) tested and such sample(s) are retained for 90 days only.

除非另有說明，此報告結果僅對測試之樣品負責，同時此樣品僅保留90天。本報告未經本公司書面許可，不可部份複製。

This document is issued by the Company subject to its General Conditions of Service printed overleaf, available on request or accessible at www.sgs.com/terms_and_conditions.htm and for electronic format documents, subject to Terms and Conditions for Electronic Documents at www.sgs.com/terms_e-document.htm. Attention is drawn to the limitation of liability, indemnification and jurisdiction issues defined therein. Any holder of this document is advised that information contained hereon reflects the Company's findings at the time of its intervention only and within the limits of Client's instructions, if any. The Company's sole responsibility is to its Client and this document does not exonerate parties to a transaction from exercising all their rights and obligations under the transaction documents. This document cannot be reproduced except in full, without prior written approval of the Company. Any unauthorized alteration, forgery or falsification of the content or appearance of this document is unlawful and offenders may be prosecuted to the fullest extent of the law.

TDD Band 41								
BW(Mhz)	Modulation	RB Size	RB Offset	Frequency (MHz)	Channel	Conducted power (dBm)	Target Power + Max. Tolerance (dBm)	MPR Allowed per 3GPP(dB)
5	64-QAM	1 RB	0	2498.5	39675	16.21	16.3	0-1
				2547.8	40148	16.27	16.3	0-1
				2593	40620	16.26	16.3	0-1
				2640.3	41093	16.25	16.3	0-1
			2687.5	41565	16.15	16.3	0-1	
			12	2498.5	39675	16.02	16.3	0-1
				2547.8	40148	16.08	16.3	0-1
				2593	40620	16.10	16.3	0-1
				2640.3	41093	16.13	16.3	0-1
			2687.5	41565	16.07	16.3	0-1	
			24	2498.5	39675	16.16	16.3	0-1
				2547.8	40148	16.10	16.3	0-1
		2593		40620	16.28	16.3	0-1	
		2640.3		41093	16.03	16.3	0-1	
		2687.5	41565	16.19	16.3	0-1		
		12 RB	0	2498.5	39675	14.99	15.3	0-2
				2547.8	40148	14.98	15.3	0-2
				2593	40620	15.00	15.3	0-2
				2640.3	41093	15.00	15.3	0-2
			2687.5	41565	15.04	15.3	0-2	
			6	2498.5	39675	15.07	15.3	0-2
				2547.8	40148	15.04	15.3	0-2
				2593	40620	15.09	15.3	0-2
				2640.3	41093	15.00	15.3	0-2
			2687.5	41565	15.03	15.3	0-2	
			13	2498.5	39675	14.98	15.3	0-2
				2547.8	40148	15.02	15.3	0-2
		2593		40620	15.03	15.3	0-2	
		2640.3		41093	15.09	15.3	0-2	
		2687.5	41565	15.04	15.3	0-2		
		25RB	2498.5	39675	15.05	15.3	0-2	
			2547.8	40148	14.99	15.3	0-2	
2593	40620		15.06	15.3	0-2			
2640.3	41093		15.03	15.3	0-2			
2687.5	41565	15.06	15.3	0-2				

Unless otherwise stated the results shown in this test report refer only to the sample(s) tested and such sample(s) are retained for 90 days only.

除非另有說明，此報告結果僅對測試之樣品負責，同時此樣品僅保留90天。本報告未經本公司書面許可，不可部份複製。

This document is issued by the Company subject to its General Conditions of Service printed overleaf, available on request or accessible at www.sgs.com/terms_and_conditions.htm and for electronic format documents, subject to Terms and Conditions for Electronic Documents at www.sgs.com/terms_e-document.htm. Attention is drawn to the limitation of liability, indemnification and jurisdiction issues defined therein. Any holder of this document is advised that information contained hereon reflects the Company's findings at the time of its intervention only and within the limits of Client's instructions, if any. The Company's sole responsibility is to its Client and this document does not exonerate parties to a transaction from exercising all their rights and obligations under the transaction documents. This document cannot be reproduced except in full, without prior written approval of the Company. Any unauthorized alteration, forgery or falsification of the content or appearance of this document is unlawful and offenders may be prosecuted to the fullest extent of the law.

WLAN802.11 a/b/g/n(20M/40M)/ac/ax(20M/40M/80M/160M) conducted power table:

Band \ Antenna	SISO		MIMO
	Tx1	Tx2	Tx1 + Tx2
WLAN802.11b	V	V	-
WLAN802.11g	V	V	-
WLAN802.11n(20M)	V	V	V
WLAN802.11n(40M)	V	V	V
WLAN802.11ax(20M)	V	V	V
WLAN802.11ax(40M)	V	V	V
WLAN802.11a	V	V	-
WLAN802.11n(20M) 5G	V	V	V
WLAN802.11n(40M) 5G	V	V	V
WLAN802.11ac(20M) 5G	V	V	V
WLAN802.11ac(40M) 5G	V	V	V
WLAN802.11ac(80M) 5G	V	V	V
WLAN802.11ac(160M) 5G	V	V	V
WLAN802.11ax(20M) 5G	V	V	V
WLAN802.11ax(40M) 5G	V	V	V
WLAN802.11ax(80M) 5G	V	V	V
WLAN802.11ax(160M) 5G	V	V	V

Unless otherwise stated the results shown in this test report refer only to the sample(s) tested and such sample(s) are retained for 90 days only.

除非另有說明，此報告結果僅對測試之樣品負責，同時此樣品僅保留90天。本報告未經本公司書面許可，不可部份複製。

This document is issued by the Company subject to its General Conditions of Service printed overleaf, available on request or accessible at www.sgs.com/terms_and_conditions.htm and for electronic format documents, subject to Terms and Conditions for Electronic Documents at www.sgs.com/terms_e-document.htm. Attention is drawn to the limitation of liability, indemnification and jurisdiction issues defined therein. Any holder of this document is advised that information contained hereon reflects the Company's findings at the time of its intervention only and within the limits of Client's instructions, if any. The Company's sole responsibility is to its Client and this document does not exonerate parties to a transaction from exercising all their rights and obligations under the transaction documents. This document cannot be reproduced except in full, without prior written approval of the Company. Any unauthorized alteration, forgery or falsification of the content or appearance of this document is unlawful and offenders may be prosecuted to the fullest extent of the law.

WWAN + WLAN
WLAN SISO sensor off power

Tx1 antenna						
Band	Mode	Channel	Frequency (MHz)	Data Rate	Max. Rated Avg. Power + Max. Tolerance (dBm)	Average power (dBm)
2450 MHz	802.11b	1	2412	1Mbps	10.50	10.45
		6	2437		10.50	10.44
		11	2462		10.50	10.42
		12	2467		10.50	10.32
		13	2472		10.50	10.35
	802.11g	1	2412	6Mbps	10.50	10.32
		2	2417		10.50	10.45
		6	2437		10.50	10.26
		10	2457		10.50	10.23
		11	2462		10.50	10.37
		12	2467		10.50	10.09
	802.11n20-HT0	1	2412	MCS0	10.50	10.28
		2	2417		10.50	10.34
		6	2437		10.50	10.36
		10	2457		10.50	10.30
		11	2462		10.50	10.23
		12	2467		10.50	10.47
	802.11ax20-HE0	1	2412	MCS0	10.50	10.43
		2	2417		10.50	10.21
		6	2437		10.50	10.33
		10	2457		10.50	10.32
		11	2462		10.50	10.43
		12	2467		10.50	10.31
		13	2472		10.50	10.45

Unless otherwise stated the results shown in this test report refer only to the sample(s) tested and such sample(s) are retained for 90 days only.

除非另有說明，此報告結果僅對測試之樣品負責，同時此樣品僅保留90天。本報告未經本公司書面許可，不可部份複製。

This document is issued by the Company subject to its General Conditions of Service printed overleaf, available on request or accessible at www.sgs.com/terms_and_conditions.htm and for electronic format documents, subject to Terms and Conditions for Electronic Documents at www.sgs.com/terms_e-document.htm. Attention is drawn to the limitation of liability, indemnification and jurisdiction issues defined therein. Any holder of this document is advised that information contained hereon reflects the Company's findings at the time of its intervention only and within the limits of Client's instructions, if any. The Company's sole responsibility is to its Client and this document does not exonerate parties to a transaction from exercising all their rights and obligations under the transaction documents. This document cannot be reproduced except in full, without prior written approval of the Company. Any unauthorized alteration, forgery or falsification of the content or appearance of this document is unlawful and offenders may be prosecuted to the fullest extent of the law.

Tx1 antenna						
Band	Mode	Channel	Frequency (MHz)	Data Rate	Max. Rated Avg. Power + Max. Tolerance (dBm)	Average power (dBm)
2450 MHz	802.11n40-HT0	3	2422	MCS0	10.50	10.38
		4	2427		10.50	10.22
		6	2437		10.50	10.10
		8	2447		10.50	10.23
		9	2452		10.50	10.36
		10	2457		10.50	10.43
		11	2462		10.50	10.29
	802.11ax40-HE0	3	2422	MCS0	10.50	10.26
		4	2427		10.50	10.39
		6	2437		10.50	10.24
		8	2447		10.50	10.21
		9	2452		10.50	10.12
		10	2457		10.50	10.19
		11	2462		10.50	10.30

Unless otherwise stated the results shown in this test report refer only to the sample(s) tested and such sample(s) are retained for 90 days only.

除非另有說明，此報告結果僅對測試之樣品負責，同時此樣品僅保留90天。本報告未經本公司書面許可，不可部份複製。

This document is issued by the Company subject to its General Conditions of Service printed overleaf, available on request or accessible at www.sgs.com/terms_and_conditions.htm and for electronic format documents, subject to Terms and Conditions for Electronic Documents at www.sgs.com/terms_e-document.htm. Attention is drawn to the limitation of liability, indemnification and jurisdiction issues defined therein. Any holder of this document is advised that information contained hereon reflects the Company's findings at the time of its intervention only and within the limits of Client's instructions, if any. The Company's sole responsibility is to its Client and this document does not exonerate parties to a transaction from exercising all their rights and obligations under the transaction documents. This document cannot be reproduced except in full, without prior written approval of the Company. Any unauthorized alteration, forgery or falsification of the content or appearance of this document is unlawful and offenders may be prosecuted to the fullest extent of the law.

Tx1 antenna						
Band	Mode	Channel	Frequency (MHz)	Data Rate	Max. Rated Avg. Power + Max. Tolerance (dBm)	Average power (dBm)
5.15-5.25 GHz	802.11a	36	5180	6Mbps	9.00	8.94
		40	5200		9.00	8.86
		44	5220		9.00	8.94
		48	5240		9.00	8.76
	802.11n20-HT0	36	5180	MCS0	9.00	8.60
		40	5200		9.00	8.56
		44	5220		9.00	8.77
		48	5240		9.00	8.69
	802.11ac20-VHT0	36	5180	MCS0	9.00	8.71
		40	5200		9.00	8.96
		44	5220		9.00	8.95
		48	5240		9.00	8.83
	802.11ax20-HE0	36	5180	MCS0	9.00	8.77
		40	5200		9.00	8.90
		44	5220		9.00	8.64
		48	5240		9.00	8.77
	802.11n40-HT0	38	5190	MCS0	9.00	8.95
		46	5230		9.00	8.97
	802.11ac40-VHT0	38	5190	MCS0	9.00	8.74
		46	5230		9.00	8.71
802.11ax40-HE0	38	5190	MCS0	9.00	8.69	
	46	5230		9.00	8.80	
802.11ac80-VHT0	42	5210	MCS0	9.00	8.92	
802.11ax80-HE0	42	5210	MCS0	9.00	8.84	
802.11ac160-VHT0	50	5250	MCS0	9.00	8.97	
802.11ax160-HE0	50	5250	MCS0	9.00	8.95	

Unless otherwise stated the results shown in this test report refer only to the sample(s) tested and such sample(s) are retained for 90 days only.

除非另有說明，此報告結果僅對測試之樣品負責，同時此樣品僅保留90天。本報告未經本公司書面許可，不可部份複製。

This document is issued by the Company subject to its General Conditions of Service printed overleaf, available on request or accessible at www.sgs.com/terms_and_conditions.htm and for electronic format documents, subject to Terms and Conditions for Electronic Documents at www.sgs.com/terms_e-document.htm. Attention is drawn to the limitation of liability, indemnification and jurisdiction issues defined therein. Any holder of this document is advised that information contained hereon reflects the Company's findings at the time of its intervention only and within the limits of Client's instructions, if any. The Company's sole responsibility is to its Client and this document does not exonerate parties to a transaction from exercising all their rights and obligations under the transaction documents. This document cannot be reproduced except in full, without prior written approval of the Company. Any unauthorized alteration, forgery or falsification of the content or appearance of this document is unlawful and offenders may be prosecuted to the fullest extent of the law.

Tx1 antenna						
Band	Mode	Channel	Frequency (MHz)	Data Rate	Max. Rated Avg. Power + Max. Tolerance (dBm)	Average power (dBm)
5.25-5.35 GHz	802.11a	52	5260	6Mbps	9.00	8.61
		56	5280		9.00	8.70
		60	5300		9.00	8.66
		64	5320		9.00	8.90
	802.11n20-HT0	52	5260	MCS0	9.00	8.91
		56	5280		9.00	8.61
		60	5300		9.00	8.85
		64	5320		9.00	8.91
	802.11ac20-VHT0	52	5260	MCS0	9.00	8.68
		56	5280		9.00	8.65
		60	5300		9.00	8.80
		64	5320		9.00	8.95
	802.11ax20-HE0	52	5260	MCS0	9.00	8.82
		56	5280		9.00	8.66
		60	5300		9.00	8.66
		64	5320		9.00	8.77
	802.11n40-HT0	54	5270	MCS0	9.00	8.91
		62	5310		9.00	8.92
	802.11ac40-VHT0	54	5270	MCS0	9.00	8.74
		62	5310		9.00	8.94
802.11ax40-HE0	54	5270	MCS0	9.00	8.78	
	62	5310		9.00	8.71	
802.11ac80-VHT0	58	5290	MCS0	9.00	8.95	
802.11ax80-HE0	58	5290	MCS0	9.00	8.82	

Unless otherwise stated the results shown in this test report refer only to the sample(s) tested and such sample(s) are retained for 90 days only.

除非另有說明，此報告結果僅對測試之樣品負責，同時此樣品僅保留90天。本報告未經本公司書面許可，不可部份複製。

This document is issued by the Company subject to its General Conditions of Service printed overleaf, available on request or accessible at www.sgs.com/terms_and_conditions.htm and for electronic format documents, subject to Terms and Conditions for Electronic Documents at www.sgs.com/terms_e-document.htm. Attention is drawn to the limitation of liability, indemnification and jurisdiction issues defined therein. Any holder of this document is advised that information contained hereon reflects the Company's findings at the time of its intervention only and within the limits of Client's instructions, if any. The Company's sole responsibility is to its Client and this document does not exonerate parties to a transaction from exercising all their rights and obligations under the transaction documents. This document cannot be reproduced except in full, without prior written approval of the Company. Any unauthorized alteration, forgery or falsification of the content or appearance of this document is unlawful and offenders may be prosecuted to the fullest extent of the law.

Tx1 antenna						
Band	Mode	Channel	Frequency (MHz)	Data Rate	Max. Rated Avg. Power + Max. Tolerance (dBm)	Average power (dBm)
5600 MHz	802.11a	100	5500	6Mbps	9.00	8.96
		104	5520		9.00	8.69
		116	5580		9.00	8.88
		120	5600		9.00	8.94
		136	5680		9.00	8.58
		140	5700		9.00	8.84
		144	5720		9.00	8.69
	802.11n20-HT0	100	5500	MCS0	9.00	8.89
		104	5520		9.00	8.59
		116	5580		9.00	8.59
		120	5600		9.00	8.84
		136	5680		9.00	8.84
		140	5700		9.00	8.79
	802.11ac20-VHT0	100	5500	MCS0	9.00	8.75
		104	5520		9.00	8.79
		116	5580		9.00	8.84
		120	5600		9.00	8.58
		136	5680		9.00	8.71
		140	5700		9.00	8.82
	802.11ax20-HE0	100	5500	MCS0	9.00	8.66
		104	5520		9.00	8.83
		116	5580		9.00	8.65
		120	5600		9.00	8.79
		136	5680		9.00	8.86
		140	5700		9.00	8.63
		144	5720		9.00	8.78

Unless otherwise stated the results shown in this test report refer only to the sample(s) tested and such sample(s) are retained for 90 days only.

除非另有說明，此報告結果僅對測試之樣品負責，同時此樣品僅保留90天。本報告未經本公司書面許可，不可部份複製。

This document is issued by the Company subject to its General Conditions of Service printed overleaf, available on request or accessible at www.sgs.com/terms_and_conditions.htm and for electronic format documents, subject to Terms and Conditions for Electronic Documents at www.sgs.com/terms_e-document.htm. Attention is drawn to the limitation of liability, indemnification and jurisdiction issues defined therein. Any holder of this document is advised that information contained hereon reflects the Company's findings at the time of its intervention only and within the limits of Client's instructions, if any. The Company's sole responsibility is to its Client and this document does not exonerate parties to a transaction from exercising all their rights and obligations under the transaction documents. This document cannot be reproduced except in full, without prior written approval of the Company. Any unauthorized alteration, forgery or falsification of the content or appearance of this document is unlawful and offenders may be prosecuted to the fullest extent of the law.

Tx1 antenna						
Band	Mode	Channel	Frequency (MHz)	Data Rate	Max. Rated Avg. Power + Max. Tolerance (dBm)	Average power (dBm)
5600 MHz	802.11n40-HT0	102	5510	MCS0	9.00	8.74
		110	5550		9.00	8.64
		118	5590		9.00	8.63
		134	5670		9.00	8.76
		142	5710		9.00	8.86
	802.11ac40-VHT0	102	5510	MCS0	9.00	8.63
		110	5550		9.00	8.89
		118	5590		9.00	8.90
		134	5670		9.00	8.72
		142	5710		9.00	8.80
	802.11ax40-HE0	102	5510	MCS0	9.00	8.90
		110	5550		9.00	8.68
		118	5590		9.00	8.74
		134	5670		9.00	8.91
		142	5710		9.00	8.63
	802.11ac80-VHT0	106	5530	MCS0	9.00	8.99
		122	5610		9.00	8.91
		138	5690		9.00	8.97
	802.11ax80-HE0	106	5530	MCS0	9.00	8.82
		122	5610		9.00	8.75
		138	5690		9.00	8.89
	802.11ac160-VHT0	114	5570	MCS0	9.00	8.91
	802.11ax160-HE0	114	5570	MCS0	9.00	8.95

Unless otherwise stated the results shown in this test report refer only to the sample(s) tested and such sample(s) are retained for 90 days only.

除非另有說明，此報告結果僅對測試之樣品負責，同時此樣品僅保留90天。本報告未經本公司書面許可，不可部份複製。

This document is issued by the Company subject to its General Conditions of Service printed overleaf, available on request or accessible at www.sgs.com/terms_and_conditions.htm and for electronic format documents, subject to Terms and Conditions for Electronic Documents at www.sgs.com/terms_e-document.htm. Attention is drawn to the limitation of liability, indemnification and jurisdiction issues defined therein. Any holder of this document is advised that information contained hereon reflects the Company's findings at the time of its intervention only and within the limits of Client's instructions, if any. The Company's sole responsibility is to its Client and this document does not exonerate parties to a transaction from exercising all their rights and obligations under the transaction documents. This document cannot be reproduced except in full, without prior written approval of the Company. Any unauthorized alteration, forgery or falsification of the content or appearance of this document is unlawful and offenders may be prosecuted to the fullest extent of the law.

Tx1 antenna						
Mode	Mode	Channel	Frequency (MHz)	Data Rate	Max. Rated Avg. Power + Max. Tolerance (dBm)	Average power (dBm)
5800 MHz	802.11a	149	5745	6Mbps	9.00	8.68
		157	5785		9.00	8.62
		165	5825		9.00	8.58
	802.11n20-HT0	149	5745	MCS0	9.00	8.86
		157	5785		9.00	8.75
		165	5825		9.00	8.90
	802.11ac20-VHT0	149	5745	MCS0	9.00	8.92
		157	5785		9.00	8.62
		165	5825		9.00	8.77
	802.11ax20-HE0	149	5745	MCS0	9.00	8.76
		157	5785		9.00	8.73
		165	5825		9.00	8.95
	802.11n40-HT0	151	5755	MCS0	9.00	8.97
		159	5795		9.00	8.93
	802.11ac40-VHT0	151	5755	MCS0	9.00	8.75
		159	5795		9.00	8.90
	802.11ax40-HE0	151	5755	MCS0	9.00	8.65
		159	5795		9.00	8.80
802.11ac80-VHT0	155	5775	MCS0	9.00	8.92	
802.11ax80-HE0	155	5775	MCS0	9.00	8.60	

Unless otherwise stated the results shown in this test report refer only to the sample(s) tested and such sample(s) are retained for 90 days only.

除非另有說明，此報告結果僅對測試之樣品負責，同時此樣品僅保留90天。本報告未經本公司書面許可，不可部份複製。

This document is issued by the Company subject to its General Conditions of Service printed overleaf, available on request or accessible at www.sgs.com/terms_and_conditions.htm and for electronic format documents, subject to Terms and Conditions for Electronic Documents at www.sgs.com/terms_e-document.htm. Attention is drawn to the limitation of liability, indemnification and jurisdiction issues defined therein. Any holder of this document is advised that information contained hereon reflects the Company's findings at the time of its intervention only and within the limits of Client's instructions, if any. The Company's sole responsibility is to its Client and this document does not exonerate parties to a transaction from exercising all their rights and obligations under the transaction documents. This document cannot be reproduced except in full, without prior written approval of the Company. Any unauthorized alteration, forgery or falsification of the content or appearance of this document is unlawful and offenders may be prosecuted to the fullest extent of the law.

Tx2 antenna						
Band	Mode	Channel	Frequency (MHz)	Data Rate	Max. Rated Avg. Power + Max. Tolerance (dBm)	Average power (dBm)
2450 MHz	802.11b	1	2412	1Mbps	10.50	10.45
		6	2437		10.50	10.43
		11	2462		10.50	10.45
		12	2467		10.50	10.38
		13	2472		10.50	10.41
	802.11g	1	2412	6Mbps	10.50	10.20
		2	2417		10.50	10.23
		6	2437		10.50	10.49
		10	2457		10.50	10.38
		11	2462		10.50	10.34
		12	2467		10.50	10.28
	802.11n20-HT0	1	2412	MCS0	10.50	10.39
		2	2417		10.50	10.20
		6	2437		10.50	10.36
		10	2457		10.50	10.38
		11	2462		10.50	10.15
		12	2467		10.50	10.43
	802.11ax20-HEC	1	2412	MCS0	10.50	10.11
		2	2417		10.50	10.10
		6	2437		10.50	10.17
		10	2457		10.50	10.38
		11	2462		10.50	10.24
		12	2467		10.50	10.22
		13	2472		10.50	10.41

Unless otherwise stated the results shown in this test report refer only to the sample(s) tested and such sample(s) are retained for 90 days only.

除非另有說明，此報告結果僅對測試之樣品負責，同時此樣品僅保留90天。本報告未經本公司書面許可，不可部份複製。

This document is issued by the Company subject to its General Conditions of Service printed overleaf, available on request or accessible at www.sgs.com/terms_and_conditions.htm and for electronic format documents, subject to Terms and Conditions for Electronic Documents at www.sgs.com/terms_e-document.htm. Attention is drawn to the limitation of liability, indemnification and jurisdiction issues defined therein. Any holder of this document is advised that information contained hereon reflects the Company's findings at the time of its intervention only and within the limits of Client's instructions, if any. The Company's sole responsibility is to its Client and this document does not exonerate parties to a transaction from exercising all their rights and obligations under the transaction documents. This document cannot be reproduced except in full, without prior written approval of the Company. Any unauthorized alteration, forgery or falsification of the content or appearance of this document is unlawful and offenders may be prosecuted to the fullest extent of the law.

Tx2 antenna						
Band	Mode	Channel	Frequency (MHz)	Data Rate	Max. Rated Avg. Power + Max. Tolerance (dBm)	Average power (dBm)
2450 MHz	802.11n40-HT0	3	2422	MCS0	10.50	10.20
		4	2427		10.50	10.08
		6	2437		10.50	10.17
		8	2447		10.50	10.22
		9	2452		10.50	10.35
		10	2457		10.50	10.23
		11	2462		10.50	10.42
	802.11ax40-HE0	3	2422	MCS0	10.50	10.40
		4	2427		10.50	10.41
		6	2437		10.50	10.24
		8	2447		10.50	10.35
		9	2452		10.50	10.31
		10	2457		10.50	10.30
		11	2462		10.50	10.37

Unless otherwise stated the results shown in this test report refer only to the sample(s) tested and such sample(s) are retained for 90 days only.

除非另有說明，此報告結果僅對測試之樣品負責，同時此樣品僅保留90天。本報告未經本公司書面許可，不可部份複製。

This document is issued by the Company subject to its General Conditions of Service printed overleaf, available on request or accessible at www.sgs.com/terms_and_conditions.htm and for electronic format documents, subject to Terms and Conditions for Electronic Documents at www.sgs.com/terms_e-document.htm. Attention is drawn to the limitation of liability, indemnification and jurisdiction issues defined therein. Any holder of this document is advised that information contained hereon reflects the Company's findings at the time of its intervention only and within the limits of Client's instructions, if any. The Company's sole responsibility is to its Client and this document does not exonerate parties to a transaction from exercising all their rights and obligations under the transaction documents. This document cannot be reproduced except in full, without prior written approval of the Company. Any unauthorized alteration, forgery or falsification of the content or appearance of this document is unlawful and offenders may be prosecuted to the fullest extent of the law.

Tx2 antenna						
Band	Mode	Channel	Frequency (MHz)	Data Rate	Max. Rated Avg. Power + Max. Tolerance (dBm)	Average power (dBm)
5.15-5.25 GHz	802.11a	36	5180	6Mbps	9.00	8.77
		40	5200		9.00	8.65
		44	5220		9.00	8.59
		48	5240		9.00	8.61
	802.11n20-HT0	36	5180	MCS0	9.00	8.76
		40	5200		9.00	8.82
		44	5220		9.00	8.70
		48	5240		9.00	8.62
	802.11ac20-VHT0	36	5180	MCS0	9.00	8.69
		40	5200		9.00	8.88
		44	5220		9.00	8.73
		48	5240		9.00	8.89
	802.11ax20-HE0	36	5180	MCS0	9.00	8.58
		40	5200		9.00	8.66
		44	5220		9.00	8.91
		48	5240		9.00	8.69
	802.11n40-HT0	38	5190	MCS0	9.00	8.96
		46	5230		9.00	8.96
	802.11ac40-VHT0	38	5190	MCS0	9.00	8.88
		46	5230		9.00	8.75
802.11ax40-HE0	38	5190	MCS0	9.00	8.95	
	46	5230		9.00	8.86	
802.11ac80-VHT0	42	5210	MCS0	9.00	8.91	
802.11ax80-HE0	42	5210	MCS0	9.00	8.60	
802.11ac160-VHT0	50	5250	MCS0	9.00	8.87	
802.11ax160-HE0	50	5250	MCS0	9.00	8.83	

Unless otherwise stated the results shown in this test report refer only to the sample(s) tested and such sample(s) are retained for 90 days only.

除非另有說明，此報告結果僅對測試之樣品負責，同時此樣品僅保留90天。本報告未經本公司書面許可，不可部份複製。

This document is issued by the Company subject to its General Conditions of Service printed overleaf, available on request or accessible at www.sgs.com/terms_and_conditions.htm and for electronic format documents, subject to Terms and Conditions for Electronic Documents at www.sgs.com/terms_e-document.htm. Attention is drawn to the limitation of liability, indemnification and jurisdiction issues defined therein. Any holder of this document is advised that information contained hereon reflects the Company's findings at the time of its intervention only and within the limits of Client's instructions, if any. The Company's sole responsibility is to its Client and this document does not exonerate parties to a transaction from exercising all their rights and obligations under the transaction documents. This document cannot be reproduced except in full, without prior written approval of the Company. Any unauthorized alteration, forgery or falsification of the content or appearance of this document is unlawful and offenders may be prosecuted to the fullest extent of the law.

Tx2 antenna						
Band	Mode	Channel	Frequency (MHz)	Data Rate	Max. Rated Avg. Power + Max. Tolerance (dBm)	Average power (dBm)
5.25-5.35 GHz	802.11a	52	5260	6Mbps	9.00	8.71
		56	5280		9.00	8.97
		60	5300		9.00	8.60
		64	5320		9.00	8.94
	802.11n20-HT0	52	5260	MCS0	9.00	8.92
		56	5280		9.00	8.80
		60	5300		9.00	8.77
		64	5320		9.00	8.62
	802.11ac20-VHT0	52	5260	MCS0	9.00	8.82
		56	5280		9.00	8.97
		60	5300		9.00	8.60
		64	5320		9.00	8.75
	802.11ax20-HE0	52	5260	MCS0	9.00	8.63
		56	5280		9.00	8.87
		60	5300		9.00	8.79
		64	5320		9.00	8.95
	802.11n40-HT0	54	5270	MCS0	9.00	8.90
		62	5310		9.00	8.95
	802.11ac40-VHT0	54	5270	MCS0	9.00	8.58
		62	5310		9.00	8.89
802.11ax40-HE0	54	5270	MCS0	9.00	8.59	
	62	5310		9.00	8.91	
802.11ac80-VHT0	58	5290	MCS0	9.00	8.89	
802.11ax80-HE0	58	5290	MCS0	9.00	8.83	

Unless otherwise stated the results shown in this test report refer only to the sample(s) tested and such sample(s) are retained for 90 days only.

除非另有說明，此報告結果僅對測試之樣品負責，同時此樣品僅保留90天。本報告未經本公司書面許可，不可部份複製。

This document is issued by the Company subject to its General Conditions of Service printed overleaf, available on request or accessible at www.sgs.com/terms_and_conditions.htm and for electronic format documents, subject to Terms and Conditions for Electronic Documents at www.sgs.com/terms_e-document.htm. Attention is drawn to the limitation of liability, indemnification and jurisdiction issues defined therein. Any holder of this document is advised that information contained hereon reflects the Company's findings at the time of its intervention only and within the limits of Client's instructions, if any. The Company's sole responsibility is to its Client and this document does not exonerate parties to a transaction from exercising all their rights and obligations under the transaction documents. This document cannot be reproduced except in full, without prior written approval of the Company. Any unauthorized alteration, forgery or falsification of the content or appearance of this document is unlawful and offenders may be prosecuted to the fullest extent of the law.

Tx2 antenna						
Band	Mode	Channel	Frequency (MHz)	Data Rate	Max. Rated Avg. Power + Max. Tolerance (dBm)	Average power (dBm)
5600 MHz	802.11a	100	5500	6Mbps	9.00	8.74
		104	5520		9.00	8.76
		116	5580		9.00	8.66
		120	5600		9.00	8.81
		136	5680		9.00	8.89
		140	5700		9.00	8.68
		144	5720		9.00	8.96
	802.11n20-HT0	100	5500	MCS0	9.00	8.64
		104	5520		9.00	8.89
		116	5580		9.00	8.69
		120	5600		9.00	8.77
		136	5680		9.00	8.96
		140	5700		9.00	8.60
	802.11ac20-VHT0	100	5500	MCS0	9.00	8.64
		104	5520		9.00	8.78
		116	5580		9.00	8.90
		120	5600		9.00	8.93
		136	5680		9.00	8.93
		140	5700		9.00	8.71
	802.11ax20-HE0	100	5500	MCS0	9.00	8.94
		104	5520		9.00	8.69
		116	5580		9.00	8.76
		120	5600		9.00	8.69
		136	5680		9.00	8.71
		140	5700		9.00	8.81
		144	5720		9.00	8.58

Unless otherwise stated the results shown in this test report refer only to the sample(s) tested and such sample(s) are retained for 90 days only.

除非另有說明，此報告結果僅對測試之樣品負責，同時此樣品僅保留90天。本報告未經本公司書面許可，不可部份複製。

This document is issued by the Company subject to its General Conditions of Service printed overleaf, available on request or accessible at www.sgs.com/terms_and_conditions.htm and for electronic format documents, subject to Terms and Conditions for Electronic Documents at www.sgs.com/terms_e-document.htm. Attention is drawn to the limitation of liability, indemnification and jurisdiction issues defined therein. Any holder of this document is advised that information contained hereon reflects the Company's findings at the time of its intervention only and within the limits of Client's instructions, if any. The Company's sole responsibility is to its Client and this document does not exonerate parties to a transaction from exercising all their rights and obligations under the transaction documents. This document cannot be reproduced except in full, without prior written approval of the Company. Any unauthorized alteration, forgery or falsification of the content or appearance of this document is unlawful and offenders may be prosecuted to the fullest extent of the law.

Tx2 antenna						
Band	Mode	Channel	Frequency (MHz)	Data Rate	Max. Rated Avg. Power + Max. Tolerance (dBm)	Average power (dBm)
5600 MHz	802.11n40-HT0	102	5510	MCS0	9.00	8.73
		110	5550		9.00	8.93
		118	5590		9.00	8.67
		134	5670		9.00	8.67
		142	5710		9.00	8.70
	802.11ac40-VHT0	102	5510	MCS0	9.00	8.65
		110	5550		9.00	8.97
		118	5590		9.00	8.75
		134	5670		9.00	8.71
		142	5710		9.00	8.93
	802.11ax40-HE0	102	5510	MCS0	9.00	8.73
		110	5550		9.00	8.60
		118	5590		9.00	8.84
		134	5670		9.00	8.63
		142	5710		9.00	8.68
	802.11ac80-VHT0	106	5530	MCS0	9.00	8.95
		122	5610		9.00	8.92
		138	5690		9.00	8.92
	802.11ax80-HE0	106	5530	MCS0	9.00	8.87
		122	5610		9.00	8.59
		138	5690		9.00	8.84
	802.11ac160-VHT0	114	5570	MCS0	9.00	8.89
	802.11ax160-HE0	114	5570	MCS0	9.00	8.65

Unless otherwise stated the results shown in this test report refer only to the sample(s) tested and such sample(s) are retained for 90 days only.

除非另有說明，此報告結果僅對測試之樣品負責，同時此樣品僅保留90天。本報告未經本公司書面許可，不可部份複製。

This document is issued by the Company subject to its General Conditions of Service printed overleaf, available on request or accessible at www.sgs.com/terms_and_conditions.htm and for electronic format documents, subject to Terms and Conditions for Electronic Documents at www.sgs.com/terms_e-document.htm. Attention is drawn to the limitation of liability, indemnification and jurisdiction issues defined therein. Any holder of this document is advised that information contained hereon reflects the Company's findings at the time of its intervention only and within the limits of Client's instructions, if any. The Company's sole responsibility is to its Client and this document does not exonerate parties to a transaction from exercising all their rights and obligations under the transaction documents. This document cannot be reproduced except in full, without prior written approval of the Company. Any unauthorized alteration, forgery or falsification of the content or appearance of this document is unlawful and offenders may be prosecuted to the fullest extent of the law.

Tx2 antenna						
Mode	Mode	Channel	Frequency (MHz)	Data Rate	Max. Rated Avg. Power + Max. Tolerance (dBm)	Average power (dBm)
5800 MHz	802.11a	149	5745	6Mbps	9.00	8.65
		157	5785		9.00	8.81
		165	5825		9.00	8.92
	802.11n20-HT0	149	5745	MCS0	9.00	8.66
		157	5785		9.00	8.79
		165	5825		9.00	8.87
	802.11ac20-VHT0	149	5745	MCS0	9.00	8.85
		157	5785		9.00	8.81
		165	5825		9.00	8.75
	802.11ax20-HE0	149	5745	MCS0	9.00	8.77
		157	5785		9.00	8.84
		165	5825		9.00	8.70
	802.11n40-HT0	151	5755	MCS0	9.00	8.89
		159	5795		9.00	8.90
	802.11ac40-VHT0	151	5755	MCS0	9.00	8.73
		159	5795		9.00	8.82
	802.11ax40-HE0	151	5755	MCS0	9.00	8.69
		159	5795		9.00	8.60
802.11ac80-VHT0	155	5775	MCS0	9.00	8.92	
802.11ax80-HE0	155	5775	MCS0	9.00	8.70	

Unless otherwise stated the results shown in this test report refer only to the sample(s) tested and such sample(s) are retained for 90 days only.

除非另有說明，此報告結果僅對測試之樣品負責，同時此樣品僅保留90天。本報告未經本公司書面許可，不可部份複製。

This document is issued by the Company subject to its General Conditions of Service printed overleaf, available on request or accessible at www.sgs.com/terms_and_conditions.htm and for electronic format documents, subject to Terms and Conditions for Electronic Documents at www.sgs.com/terms_e-document.htm. Attention is drawn to the limitation of liability, indemnification and jurisdiction issues defined therein. Any holder of this document is advised that information contained hereon reflects the Company's findings at the time of its intervention only and within the limits of Client's instructions, if any. The Company's sole responsibility is to its Client and this document does not exonerate parties to a transaction from exercising all their rights and obligations under the transaction documents. This document cannot be reproduced except in full, without prior written approval of the Company. Any unauthorized alteration, forgery or falsification of the content or appearance of this document is unlawful and offenders may be prosecuted to the fullest extent of the law.

WLAN MIMO power

Tx1 antenna						
Band	Mode	Channel	Frequency (MHz)	Data Rate	Max. Rated Avg. Power + Max. Tolerance (dBm)	Average power (dBm)
2450 MHz	802.11n20-HT0	1	2412	MCS0	10.50	10.16
		2	2417		10.50	10.20
		6	2437		10.50	10.23
		10	2457		10.50	10.15
		11	2462		10.50	10.09
		12	2467		10.50	10.36
		13	2472		10.50	10.12
	802.11ax20-HE0	1	2412	MCS0	10.50	10.32
		2	2417		10.50	10.08
		6	2437		10.50	10.20
		10	2457		10.50	10.20
		11	2462		10.50	10.31
		12	2467		10.50	10.19
		13	2472		10.50	10.32
	802.11n40-HT0	3	2422	MCS0	10.50	10.26
		4	2427		10.50	10.10
		6	2437		10.50	9.95
		8	2447		10.50	10.11
		9	2452		10.50	10.22
		10	2457		10.50	10.33
		11	2462		10.50	10.15
	802.11ax40-HE0	3	2422	MCS0	10.50	10.11
		4	2427		10.50	10.27
		6	2437		10.50	10.12
		8	2447		10.50	10.07
		9	2452		10.50	9.99
		10	2457		10.50	10.05
		11	2462		10.50	10.20

Unless otherwise stated the results shown in this test report refer only to the sample(s) tested and such sample(s) are retained for 90 days only.

除非另有說明，此報告結果僅對測試之樣品負責，同時此樣品僅保留90天。本報告未經本公司書面許可，不可部份複製。

This document is issued by the Company subject to its General Conditions of Service printed overleaf, available on request or accessible at www.sgs.com/terms_and_conditions.htm and for electronic format documents, subject to Terms and Conditions for Electronic Documents at www.sgs.com/terms_e-document.htm. Attention is drawn to the limitation of liability, indemnification and jurisdiction issues defined therein. Any holder of this document is advised that information contained hereon reflects the Company's findings at the time of its intervention only and within the limits of Client's instructions, if any. The Company's sole responsibility is to its Client and this document does not exonerate parties to a transaction from exercising all their rights and obligations under the transaction documents. This document cannot be reproduced except in full, without prior written approval of the Company. Any unauthorized alteration, forgery or falsification of the content or appearance of this document is unlawful and offenders may be prosecuted to the fullest extent of the law.

Tx1 antenna						
Band	Mode	Channel	Frequency (MHz)	Data Rate	Max. Rated Avg. Power + Max. Tolerance (dBm)	Average power (dBm)
5.15-5.25 GHz	802.11n20-HT0	36	5180	MCS0	9.00	8.50
		40	5200		9.00	8.46
		44	5220		9.00	8.64
		48	5240		9.00	8.54
	802.11ac20-VHT0	36	5180	MCS0	9.00	8.59
		40	5200		9.00	8.83
		44	5220		9.00	8.82
		48	5240		9.00	8.73
	802.11ax20-HE0	36	5180	MCS0	9.00	8.64
		40	5200		9.00	8.77
		44	5220		9.00	8.50
		48	5240		9.00	8.64
	802.11n40-HT0	38	5190	MCS0	9.00	8.84
		46	5230		9.00	8.86
	802.11ac40-VHT0	38	5190	MCS0	9.00	8.63
		46	5230		9.00	8.58
	802.11ax40-HE0	38	5190	MCS0	9.00	8.57
		46	5230		9.00	8.70
	802.11ac80-VHT0	42	5210	MCS0	9.00	8.82
	802.11ax80-HE0	42	5210	MCS0	9.00	8.73
802.11ac160-VHT0	50	5250	MCS0	9.00	8.85	
802.11ax160-HE0	50	5250	MCS0	9.00	8.83	

Unless otherwise stated the results shown in this test report refer only to the sample(s) tested and such sample(s) are retained for 90 days only.

除非另有說明，此報告結果僅對測試之樣品負責，同時此樣品僅保留90天。本報告未經本公司書面許可，不可部份複製。

This document is issued by the Company subject to its General Conditions of Service printed overleaf, available on request or accessible at www.sgs.com/terms_and_conditions.htm and for electronic format documents, subject to Terms and Conditions for Electronic Documents at www.sgs.com/terms_e-document.htm. Attention is drawn to the limitation of liability, indemnification and jurisdiction issues defined therein. Any holder of this document is advised that information contained hereon reflects the Company's findings at the time of its intervention only and within the limits of Client's instructions, if any. The Company's sole responsibility is to its Client and this document does not exonerate parties to a transaction from exercising all their rights and obligations under the transaction documents. This document cannot be reproduced except in full, without prior written approval of the Company. Any unauthorized alteration, forgery or falsification of the content or appearance of this document is unlawful and offenders may be prosecuted to the fullest extent of the law.

Tx1 antenna						
Band	Mode	Channel	Frequency (MHz)	Data Rate	Max. Rated Avg. Power + Max. Tolerance (dBm)	Average power (dBm)
5.25-5.35 GHz	802.11n20-HT0	52	5260	MCS0	9.00	8.78
		56	5280		9.00	8.48
		60	5300		9.00	8.73
		64	5320		9.00	8.80
	802.11ac20-VHT0	52	5260	MCS0	9.00	8.54
		56	5280		9.00	8.52
		60	5300		9.00	8.66
		64	5320		9.00	8.82
	802.11ax20-HE0	52	5260	MCS0	9.00	8.69
		56	5280		9.00	8.52
		60	5300		9.00	8.52
		64	5320		9.00	8.64
	802.11n40-HT0	54	5270	MCS0	9.00	8.79
		62	5310		9.00	8.79
	802.11ac40-VHT0	54	5270	MCS0	9.00	8.62
		62	5310		9.00	8.82
	802.11ax40-HE0	54	5270	MCS0	9.00	8.63
		62	5310		9.00	8.60
	802.11ac80-VHT0	58	5290	MCS0	9.00	8.84
	802.11ax80-HE0	58	5290	MCS0	9.00	8.68

Unless otherwise stated the results shown in this test report refer only to the sample(s) tested and such sample(s) are retained for 90 days only.

除非另有說明，此報告結果僅對測試之樣品負責，同時此樣品僅保留90天。本報告未經本公司書面許可，不可部份複製。

This document is issued by the Company subject to its General Conditions of Service printed overleaf, available on request or accessible at www.sgs.com/terms_and_conditions.htm and for electronic format documents, subject to Terms and Conditions for Electronic Documents at www.sgs.com/terms_e-document.htm. Attention is drawn to the limitation of liability, indemnification and jurisdiction issues defined therein. Any holder of this document is advised that information contained hereon reflects the Company's findings at the time of its intervention only and within the limits of Client's instructions, if any. The Company's sole responsibility is to its Client and this document does not exonerate parties to a transaction from exercising all their rights and obligations under the transaction documents. This document cannot be reproduced except in full, without prior written approval of the Company. Any unauthorized alteration, forgery or falsification of the content or appearance of this document is unlawful and offenders may be prosecuted to the fullest extent of the law.

Tx1 antenna						
Band	Mode	Channel	Frequency (MHz)	Data Rate	Max. Rated Avg. Power + Max. Tolerance (dBm)	Average power (dBm)
5600 MHz	802.11n20-HT0	100	5500	MCS0	9.00	8.78
		104	5520		9.00	8.46
		116	5580		9.00	8.47
		120	5600		9.00	8.72
		136	5680		9.00	8.72
		140	5700		9.00	8.66
		144	5720		9.00	8.64
	802.11ac20-VHT0	100	5500	MCS0	9.00	8.64
		104	5520		9.00	8.67
		116	5580		9.00	8.73
		120	5600		9.00	8.45
		136	5680		9.00	8.58
		140	5700		9.00	8.71
		144	5720		9.00	8.48
	802.11ax20-HE0	100	5500	MCS0	9.00	8.51
		104	5520		9.00	8.69
		116	5580		9.00	8.53
		120	5600		9.00	8.67
		136	5680		9.00	8.75
		140	5700		9.00	8.49
		144	5720		9.00	8.64

Unless otherwise stated the results shown in this test report refer only to the sample(s) tested and such sample(s) are retained for 90 days only.

除非另有說明，此報告結果僅對測試之樣品負責，同時此樣品僅保留90天。本報告未經本公司書面許可，不可部份複製。

This document is issued by the Company subject to its General Conditions of Service printed overleaf, available on request or accessible at www.sgs.com/terms_and_conditions.htm and for electronic format documents, subject to Terms and Conditions for Electronic Documents at www.sgs.com/terms_e-document.htm. Attention is drawn to the limitation of liability, indemnification and jurisdiction issues defined therein. Any holder of this document is advised that information contained hereon reflects the Company's findings at the time of its intervention only and within the limits of Client's instructions, if any. The Company's sole responsibility is to its Client and this document does not exonerate parties to a transaction from exercising all their rights and obligations under the transaction documents. This document cannot be reproduced except in full, without prior written approval of the Company. Any unauthorized alteration, forgery or falsification of the content or appearance of this document is unlawful and offenders may be prosecuted to the fullest extent of the law.

Tx1 antenna						
Band	Mode	Channel	Frequency (MHz)	Data Rate	Max. Rated Avg. Power + Max. Tolerance (dBm)	Average power (dBm)
5600 MHz	802.11n40-HT0	102	5510	MCS0	9.00	8.63
		110	5550		9.00	8.53
		118	5590		9.00	8.50
		134	5670		9.00	8.64
		142	5710		9.00	8.72
	802.11ac40-VHT0	102	5510	MCS0	9.00	8.51
		110	5550		9.00	8.75
		118	5590		9.00	8.77
		134	5670		9.00	8.57
		142	5710		9.00	8.69
	802.11ax40-HE0	102	5510	MCS0	9.00	8.79
		110	5550		9.00	8.56
		118	5590		9.00	8.61
		134	5670		9.00	8.78
		142	5710		9.00	8.53
	802.11ac80-VHT0	106	5530	MCS0	9.00	8.88
		122	5610		9.00	8.76
		138	5690		9.00	8.85
	802.11ax80-HE0	106	5530	MCS0	9.00	8.68
		122	5610		9.00	8.64
		138	5690		9.00	8.76
802.11ac160-VHT0	114	5570	MCS0	9.00	8.78	
802.11ax160-HE0	114	5570	MCS0	9.00	8.83	

Unless otherwise stated the results shown in this test report refer only to the sample(s) tested and such sample(s) are retained for 90 days only.

除非另有說明，此報告結果僅對測試之樣品負責，同時此樣品僅保留90天。本報告未經本公司書面許可，不可部份複製。

This document is issued by the Company subject to its General Conditions of Service printed overleaf, available on request or accessible at www.sgs.com/terms_and_conditions.htm and for electronic format documents, subject to Terms and Conditions for Electronic Documents at www.sgs.com/terms_e-document.htm. Attention is drawn to the limitation of liability, indemnification and jurisdiction issues defined therein. Any holder of this document is advised that information contained hereon reflects the Company's findings at the time of its intervention only and within the limits of Client's instructions, if any. The Company's sole responsibility is to its Client and this document does not exonerate parties to a transaction from exercising all their rights and obligations under the transaction documents. This document cannot be reproduced except in full, without prior written approval of the Company. Any unauthorized alteration, forgery or falsification of the content or appearance of this document is unlawful and offenders may be prosecuted to the fullest extent of the law.

Tx1 antenna						
Mode	Mode	Channel	Frequency (MHz)	Data Rate	Max. Rated Avg. Power + Max. Tolerance (dBm)	Average power (dBm)
5800 MHz	802.11n20-HT0	149	5745	MCS0	9.00	8.73
		157	5785		9.00	8.60
		165	5825		9.00	8.75
	802.11ac20-VHT0	149	5745	MCS0	9.00	8.78
		157	5785		9.00	8.49
		165	5825		9.00	8.66
	802.11ax20-HE0	149	5745	MCS0	9.00	8.63
		157	5785		9.00	8.60
		165	5825		9.00	8.84
	802.11n40-HT0	151	5755	MCS0	9.00	8.87
		159	5795		9.00	8.80
	802.11ac40-VHT0	151	5755	MCS0	9.00	8.62
		159	5795		9.00	8.79
	802.11ax40-HE0	151	5755	MCS0	9.00	8.54
		159	5795		9.00	8.66
802.11ac80-VHT0	155	5775	MCS0	9.00	8.80	
802.11ax80-HE0	155	5775	MCS0	9.00	8.46	

Unless otherwise stated the results shown in this test report refer only to the sample(s) tested and such sample(s) are retained for 90 days only.

除非另有說明，此報告結果僅對測試之樣品負責，同時此樣品僅保留90天。本報告未經本公司書面許可，不可部份複製。

This document is issued by the Company subject to its General Conditions of Service printed overleaf, available on request or accessible at www.sgs.com/terms_and_conditions.htm and for electronic format documents, subject to Terms and Conditions for Electronic Documents at www.sgs.com/terms_e-document.htm. Attention is drawn to the limitation of liability, indemnification and jurisdiction issues defined therein. Any holder of this document is advised that information contained hereon reflects the Company's findings at the time of its intervention only and within the limits of Client's instructions, if any. The Company's sole responsibility is to its Client and this document does not exonerate parties to a transaction from exercising all their rights and obligations under the transaction documents. This document cannot be reproduced except in full, without prior written approval of the Company. Any unauthorized alteration, forgery or falsification of the content or appearance of this document is unlawful and offenders may be prosecuted to the fullest extent of the law.

Tx2 antenna						
Band	Mode	Channel	Frequency (MHz)	Data Rate	Max. Rated Avg. Power + Max. Tolerance (dBm)	Average power (dBm)
2450 MHz	802.11n20-HT0	1	2412	MCS0	10.50	10.25
		2	2417		10.50	10.08
		6	2437		10.50	10.25
		10	2457		10.50	10.26
		11	2462		10.50	10.05
		12	2467		10.50	10.30
		13	2472		10.50	10.27
	802.11ax20-HEC0	1	2412	MCS0	10.50	9.97
		2	2417		10.50	9.97
		6	2437		10.50	10.05
		10	2457		10.50	10.26
		11	2462		10.50	10.12
		12	2467		10.50	10.09
		13	2472		10.50	10.26
	802.11n40-HT0	3	2422	MCS0	10.50	10.08
		4	2427		10.50	9.96
		6	2437		10.50	10.03
		8	2447		10.50	10.12
		9	2452		10.50	10.21
		10	2457		10.50	10.11
		11	2462		10.50	10.29
	802.11ax40-HEC0	3	2422	MCS0	10.50	10.25
		4	2427		10.50	10.28
		6	2437		10.50	10.11
		8	2447		10.50	10.24
		9	2452		10.50	10.21
		10	2457		10.50	10.15
		11	2462		10.50	10.22

Unless otherwise stated the results shown in this test report refer only to the sample(s) tested and such sample(s) are retained for 90 days only.

除非另有說明，此報告結果僅對測試之樣品負責，同時此樣品僅保留90天。本報告未經本公司書面許可，不可部份複製。

This document is issued by the Company subject to its General Conditions of Service printed overleaf, available on request or accessible at www.sgs.com/terms_and_conditions.htm and for electronic format documents, subject to Terms and Conditions for Electronic Documents at www.sgs.com/terms_e-document.htm. Attention is drawn to the limitation of liability, indemnification and jurisdiction issues defined therein. Any holder of this document is advised that information contained hereon reflects the Company's findings at the time of its intervention only and within the limits of Client's instructions, if any. The Company's sole responsibility is to its Client and this document does not exonerate parties to a transaction from exercising all their rights and obligations under the transaction documents. This document cannot be reproduced except in full, without prior written approval of the Company. Any unauthorized alteration, forgery or falsification of the content or appearance of this document is unlawful and offenders may be prosecuted to the fullest extent of the law.

Tx2 antenna						
Band	Mode	Channel	Frequency (MHz)	Data Rate	Max. Rated Avg. Power + Max. Tolerance (dBm)	Average power (dBm)
5.15-5.25 GHz	802.11n20-HT0	36	5180	MCS0	9.00	8.66
		40	5200		9.00	8.68
		44	5220		9.00	8.56
		48	5240		9.00	8.51
	802.11ac20-VHT0	36	5180	MCS0	9.00	8.56
		40	5200		9.00	8.77
		44	5220		9.00	8.62
		48	5240		9.00	8.75
	802.11ax20-HE0	36	5180	MCS0	9.00	8.44
		40	5200		9.00	8.53
		44	5220		9.00	8.78
		48	5240		9.00	8.54
	802.11n40-HT0	38	5190	MCS0	9.00	8.84
		46	5230		9.00	8.81
	802.11ac40-VHT0	38	5190	MCS0	9.00	8.74
		46	5230		9.00	8.63
	802.11ax40-HE0	38	5190	MCS0	9.00	8.84
		46	5230		9.00	8.73
	802.11ac80-VHT0	42	5210	MCS0	9.00	8.77
	802.11ax80-HE0	42	5210	MCS0	9.00	8.48
802.11ac160-VHT0	50	5250	MCS0	9.00	8.74	
802.11ax160-HE0	50	5250	MCS0	9.00	8.70	

Unless otherwise stated the results shown in this test report refer only to the sample(s) tested and such sample(s) are retained for 90 days only.

除非另有說明，此報告結果僅對測試之樣品負責，同時此樣品僅保留90天。本報告未經本公司書面許可，不可部份複製。

This document is issued by the Company subject to its General Conditions of Service printed overleaf, available on request or accessible at www.sgs.com/terms_and_conditions.htm and for electronic format documents, subject to Terms and Conditions for Electronic Documents at www.sgs.com/terms_e-document.htm. Attention is drawn to the limitation of liability, indemnification and jurisdiction issues defined therein. Any holder of this document is advised that information contained hereon reflects the Company's findings at the time of its intervention only and within the limits of Client's instructions, if any. The Company's sole responsibility is to its Client and this document does not exonerate parties to a transaction from exercising all their rights and obligations under the transaction documents. This document cannot be reproduced except in full, without prior written approval of the Company. Any unauthorized alteration, forgery or falsification of the content or appearance of this document is unlawful and offenders may be prosecuted to the fullest extent of the law.

Tx2 antenna						
Band	Mode	Channel	Frequency (MHz)	Data Rate	Max. Rated Avg. Power + Max. Tolerance (dBm)	Average power (dBm)
5.25-5.35 GHz	802.11n20-HT0	52	5260	MCS0	9.00	8.80
		56	5280		9.00	8.69
		60	5300		9.00	8.63
		64	5320		9.00	8.52
	802.11ac20-VHT0	52	5260	MCS0	9.00	8.70
		56	5280		9.00	8.84
		60	5300		9.00	8.50
		64	5320		9.00	8.61
	802.11ax20-HE0	52	5260	MCS0	9.00	8.50
		56	5280		9.00	8.75
		60	5300		9.00	8.64
		64	5320		9.00	8.82
	802.11n40-HT0	54	5270	MCS0	9.00	8.80
		62	5310		9.00	8.81
	802.11ac40-VHT0	54	5270	MCS0	9.00	8.44
		62	5310		9.00	8.78
	802.11ax40-HE0	54	5270	MCS0	9.00	8.48
		62	5310		9.00	8.78
802.11ac80-VHT0	58	5290	MCS0	9.00	8.78	
802.11ax80-HE0	58	5290	MCS0	9.00	8.70	

Unless otherwise stated the results shown in this test report refer only to the sample(s) tested and such sample(s) are retained for 90 days only.

除非另有說明，此報告結果僅對測試之樣品負責，同時此樣品僅保留90天。本報告未經本公司書面許可，不可部份複製。

This document is issued by the Company subject to its General Conditions of Service printed overleaf, available on request or accessible at www.sgs.com/terms_and_conditions.htm and for electronic format documents, subject to Terms and Conditions for Electronic Documents at www.sgs.com/terms_e-document.htm. Attention is drawn to the limitation of liability, indemnification and jurisdiction issues defined therein. Any holder of this document is advised that information contained hereon reflects the Company's findings at the time of its intervention only and within the limits of Client's instructions, if any. The Company's sole responsibility is to its Client and this document does not exonerate parties to a transaction from exercising all their rights and obligations under the transaction documents. This document cannot be reproduced except in full, without prior written approval of the Company. Any unauthorized alteration, forgery or falsification of the content or appearance of this document is unlawful and offenders may be prosecuted to the fullest extent of the law.

Tx2 antenna						
Band	Mode	Channel	Frequency (MHz)	Data Rate	Max. Rated Avg. Power + Max. Tolerance (dBm)	Average power (dBm)
5600 MHz	802.11n20-HT0	100	5500	MCS0	9.00	8.51
		104	5520		9.00	8.76
		116	5580		9.00	8.55
		120	5600		9.00	8.64
		136	5680		9.00	8.83
		140	5700		9.00	8.47
		144	5720		9.00	8.65
	802.11ac20-VHT0	100	5500	MCS0	9.00	8.49
		104	5520		9.00	8.64
		116	5580		9.00	8.78
		120	5600		9.00	8.81
		136	5680		9.00	8.81
		140	5700		9.00	8.59
	802.11ax20-HE0	100	5500	MCS0	9.00	8.82
		104	5520		9.00	8.57
		116	5580		9.00	8.62
		120	5600		9.00	8.55
		136	5680		9.00	8.60
		140	5700		9.00	8.67
		144	5720		9.00	8.45

Unless otherwise stated the results shown in this test report refer only to the sample(s) tested and such sample(s) are retained for 90 days only.

除非另有說明，此報告結果僅對測試之樣品負責，同時此樣品僅保留90天。本報告未經本公司書面許可，不可部份複製。

This document is issued by the Company subject to its General Conditions of Service printed overleaf, available on request or accessible at www.sgs.com/terms_and_conditions.htm and for electronic format documents, subject to Terms and Conditions for Electronic Documents at www.sgs.com/terms_e-document.htm. Attention is drawn to the limitation of liability, indemnification and jurisdiction issues defined therein. Any holder of this document is advised that information contained hereon reflects the Company's findings at the time of its intervention only and within the limits of Client's instructions, if any. The Company's sole responsibility is to its Client and this document does not exonerate parties to a transaction from exercising all their rights and obligations under the transaction documents. This document cannot be reproduced except in full, without prior written approval of the Company. Any unauthorized alteration, forgery or falsification of the content or appearance of this document is unlawful and offenders may be prosecuted to the fullest extent of the law.

Tx2 antenna						
Band	Mode	Channel	Frequency (MHz)	Data Rate	Max. Rated Avg. Power + Max. Tolerance (dBm)	Average power (dBm)
5600 MHz	802.11n40-HT0	102	5510	MCS0	9.00	8.63
		110	5550		9.00	8.82
		118	5590		9.00	8.56
		134	5670		9.00	8.55
		142	5710		9.00	8.56
	802.11ac40-VHT0	102	5510	MCS0	9.00	8.51
		110	5550		9.00	8.84
		118	5590		9.00	8.64
		134	5670		9.00	8.61
		142	5710		9.00	8.79
	802.11ax40-HE0	102	5510	MCS0	9.00	8.60
		110	5550		9.00	8.48
		118	5590		9.00	8.71
		134	5670		9.00	8.52
		142	5710		9.00	8.57
	802.11ac80-VHT0	106	5530	MCS0	9.00	8.81
		122	5610		9.00	8.79
		138	5690		9.00	8.82
	802.11ax80-HE0	106	5530	MCS0	9.00	8.76
		122	5610		9.00	8.48
		138	5690		9.00	8.72
	802.11ac160-VHT0	114	5570	MCS0	9.00	8.78
	802.11ax160-HE0	114	5570	MCS0	9.00	8.55

Unless otherwise stated the results shown in this test report refer only to the sample(s) tested and such sample(s) are retained for 90 days only.

除非另有說明，此報告結果僅對測試之樣品負責，同時此樣品僅保留90天。本報告未經本公司書面許可，不可部份複製。

This document is issued by the Company subject to its General Conditions of Service printed overleaf, available on request or accessible at www.sgs.com/terms_and_conditions.htm and for electronic format documents, subject to Terms and Conditions for Electronic Documents at www.sgs.com/terms_e-document.htm. Attention is drawn to the limitation of liability, indemnification and jurisdiction issues defined therein. Any holder of this document is advised that information contained hereon reflects the Company's findings at the time of its intervention only and within the limits of Client's instructions, if any. The Company's sole responsibility is to its Client and this document does not exonerate parties to a transaction from exercising all their rights and obligations under the transaction documents. This document cannot be reproduced except in full, without prior written approval of the Company. Any unauthorized alteration, forgery or falsification of the content or appearance of this document is unlawful and offenders may be prosecuted to the fullest extent of the law.

Tx2 antenna						
Mode	Mode	Channel	Frequency (MHz)	Data Rate	Max. Rated Avg. Power + Max. Tolerance (dBm)	Average power (dBm)
5800 MHz	802.11n20-HT0	149	5745	MCS0	9.00	8.55
		157	5785		9.00	8.66
		165	5825		9.00	8.76
	802.11ac20-VHT0	149	5745	MCS0	9.00	8.73
		157	5785		9.00	8.66
		165	5825		9.00	8.64
	802.11ax20-HE0	149	5745	MCS0	9.00	8.66
		157	5785		9.00	8.70
		165	5825		9.00	8.57
	802.11n40-HT0	151	5755	MCS0	9.00	8.76
		159	5795		9.00	8.80
	802.11ac40-VHT0	151	5755	MCS0	9.00	8.62
		159	5795		9.00	8.71
	802.11ax40-HE0	151	5755	MCS0	9.00	8.55
		159	5795		9.00	8.50
802.11ac80-VHT0	155	5775	MCS0	9.00	8.81	
802.11ax80-HE0	155	5775	MCS0	9.00	8.59	

Unless otherwise stated the results shown in this test report refer only to the sample(s) tested and such sample(s) are retained for 90 days only.

除非另有說明，此報告結果僅對測試之樣品負責，同時此樣品僅保留90天。本報告未經本公司書面許可，不可部份複製。

This document is issued by the Company subject to its General Conditions of Service printed overleaf, available on request or accessible at www.sgs.com/terms_and_conditions.htm and for electronic format documents, subject to Terms and Conditions for Electronic Documents at www.sgs.com/terms_e-document.htm. Attention is drawn to the limitation of liability, indemnification and jurisdiction issues defined therein. Any holder of this document is advised that information contained hereon reflects the Company's findings at the time of its intervention only and within the limits of Client's instructions, if any. The Company's sole responsibility is to its Client and this document does not exonerate parties to a transaction from exercising all their rights and obligations under the transaction documents. This document cannot be reproduced except in full, without prior written approval of the Company. Any unauthorized alteration, forgery or falsification of the content or appearance of this document is unlawful and offenders may be prosecuted to the fullest extent of the law.

WLAN SISO sensor on power

Tx1 antenna						
Band	Mode	Channel	Frequency (MHz)	Data Rate	Max. Rated Avg. Power + Max. Tolerance (dBm)	Average power (dBm)
2450 MHz	802.11b	1	2412	1Mbps	8.00	7.97
		6	2437		8.00	7.96
		11	2462		8.00	7.92
		12	2467		8.00	7.83
		13	2472		8.00	7.86
	802.11g	1	2412	6Mbps	8.00	7.82
		2	2417		8.00	7.97
		6	2437		8.00	7.78
		10	2457		8.00	7.74
		11	2462		8.00	7.88
		12	2467		8.00	7.61
	802.11n20-HT0	1	2412	MCS0	8.00	7.79
		2	2417		8.00	7.85
		6	2437		8.00	7.88
		10	2457		8.00	7.80
		11	2462		8.00	7.74
		12	2467		8.00	7.98
	802.11ax20-HE0	1	2412	MCS0	8.00	7.94
		2	2417		8.00	7.73
		6	2437		8.00	7.85
		10	2457		8.00	7.84
		11	2462		8.00	7.94
		12	2467		8.00	7.82
		13	2472		8.00	7.96

Unless otherwise stated the results shown in this test report refer only to the sample(s) tested and such sample(s) are retained for 90 days only.

除非另有說明，此報告結果僅對測試之樣品負責，同時此樣品僅保留90天。本報告未經本公司書面許可，不可部份複製。

This document is issued by the Company subject to its General Conditions of Service printed overleaf, available on request or accessible at www.sgs.com/terms_and_conditions.htm and for electronic format documents, subject to Terms and Conditions for Electronic Documents at www.sgs.com/terms_e-document.htm. Attention is drawn to the limitation of liability, indemnification and jurisdiction issues defined therein. Any holder of this document is advised that information contained hereon reflects the Company's findings at the time of its intervention only and within the limits of Client's instructions, if any. The Company's sole responsibility is to its Client and this document does not exonerate parties to a transaction from exercising all their rights and obligations under the transaction documents. This document cannot be reproduced except in full, without prior written approval of the Company. Any unauthorized alteration, forgery or falsification of the content or appearance of this document is unlawful and offenders may be prosecuted to the fullest extent of the law.

Tx1 antenna						
Band	Mode	Channel	Frequency (MHz)	Data Rate	Max. Rated Avg. Power + Max. Tolerance (dBm)	Average power (dBm)
2450 MHz	802.11n40-HT0	3	2422	MCS0	8.00	7.88
		4	2427		8.00	7.73
		6	2437		8.00	7.61
		8	2447		8.00	7.75
		9	2452		8.00	7.88
		10	2457		8.00	7.94
		11	2462		8.00	7.79
	802.11ax40-HE0	3	2422	MCS0	8.00	7.78
		4	2427		8.00	7.90
		6	2437		8.00	7.76
		8	2447		8.00	7.71
		9	2452		8.00	7.63
		10	2457		8.00	7.70
		11	2462		8.00	7.80

Unless otherwise stated the results shown in this test report refer only to the sample(s) tested and such sample(s) are retained for 90 days only.

除非另有說明，此報告結果僅對測試之樣品負責，同時此樣品僅保留90天。本報告未經本公司書面許可，不可部份複製。

This document is issued by the Company subject to its General Conditions of Service printed overleaf, available on request or accessible at www.sgs.com/terms_and_conditions.htm and for electronic format documents, subject to Terms and Conditions for Electronic Documents at www.sgs.com/terms_e-document.htm. Attention is drawn to the limitation of liability, indemnification and jurisdiction issues defined therein. Any holder of this document is advised that information contained hereon reflects the Company's findings at the time of its intervention only and within the limits of Client's instructions, if any. The Company's sole responsibility is to its Client and this document does not exonerate parties to a transaction from exercising all their rights and obligations under the transaction documents. This document cannot be reproduced except in full, without prior written approval of the Company. Any unauthorized alteration, forgery or falsification of the content or appearance of this document is unlawful and offenders may be prosecuted to the fullest extent of the law.

Tx1 antenna						
Band	Mode	Channel	Frequency (MHz)	Data Rate	Max. Rated Avg. Power + Max. Tolerance (dBm)	Average power (dBm)
5.15-5.25 GHz	802.11a	36	5180	6Mbps	7.00	6.94
		40	5200		7.00	6.86
		44	5220		7.00	6.96
		48	5240		7.00	6.76
	802.11n20-HT0	36	5180	MCS0	7.00	6.61
		40	5200		7.00	6.58
		44	5220		7.00	6.78
		48	5240		7.00	6.70
	802.11ac20-VHT0	36	5180	MCS0	7.00	6.71
		40	5200		7.00	6.98
		44	5220		7.00	6.96
		48	5240		7.00	6.83
	802.11ax20-HE0	36	5180	MCS0	7.00	6.78
		40	5200		7.00	6.91
		44	5220		7.00	6.64
		48	5240		7.00	6.78
	802.11n40-HT0	38	5190	MCS0	7.00	6.96
		46	5230		7.00	6.98
	802.11ac40-VHT0	38	5190	MCS0	7.00	6.74
		46	5230		7.00	6.71
802.11ax40-HE0	38	5190	MCS0	7.00	6.70	
	46	5230		7.00	6.82	
802.11ac80-VHT0	42	5210	MCS0	7.00	6.92	
802.11ax80-HE0	42	5210	MCS0	7.00	6.86	
802.11ac160-VHT0	50	5250	MCS0	7.00	6.97	
802.11ax160-HE0	50	5250	MCS0	7.00	6.96	

Unless otherwise stated the results shown in this test report refer only to the sample(s) tested and such sample(s) are retained for 90 days only.

除非另有說明，此報告結果僅對測試之樣品負責，同時此樣品僅保留90天。本報告未經本公司書面許可，不可部份複製。

This document is issued by the Company subject to its General Conditions of Service printed overleaf, available on request or accessible at www.sgs.com/terms_and_conditions.htm and for electronic format documents, subject to Terms and Conditions for Electronic Documents at www.sgs.com/terms_e-document.htm. Attention is drawn to the limitation of liability, indemnification and jurisdiction issues defined therein. Any holder of this document is advised that information contained hereon reflects the Company's findings at the time of its intervention only and within the limits of Client's instructions, if any. The Company's sole responsibility is to its Client and this document does not exonerate parties to a transaction from exercising all their rights and obligations under the transaction documents. This document cannot be reproduced except in full, without prior written approval of the Company. Any unauthorized alteration, forgery or falsification of the content or appearance of this document is unlawful and offenders may be prosecuted to the fullest extent of the law.

Tx1 antenna						
Band	Mode	Channel	Frequency (MHz)	Data Rate	Max. Rated Avg. Power + Max. Tolerance (dBm)	Average power (dBm)
5.25-5.35 GHz	802.11a	52	5260	6Mbps	7.00	6.63
		56	5280		7.00	6.72
		60	5300		7.00	6.67
		64	5320		7.00	6.92
	802.11n20-HT0	52	5260	MCS0	7.00	6.92
		56	5280		7.00	6.61
		60	5300		7.00	6.85
		64	5320		7.00	6.92
	802.11ac20-VHT0	52	5260	MCS0	7.00	6.68
		56	5280		7.00	6.65
		60	5300		7.00	6.82
		64	5320		7.00	6.96
	802.11ax20-HE0	52	5260	MCS0	7.00	6.84
		56	5280		7.00	6.67
		60	5300		7.00	6.67
		64	5320		7.00	6.77
	802.11n40-HT0	54	5270	MCS0	7.00	6.92
		62	5310		7.00	6.94
	802.11ac40-VHT0	54	5270	MCS0	7.00	6.76
		62	5310		7.00	6.95
802.11ax40-HE0	54	5270	MCS0	7.00	6.79	
	62	5310		7.00	6.71	
802.11ac80-VHT0	58	5290	MCS0	7.00	6.97	
802.11ax80-HE0	58	5290	MCS0	7.00	6.84	

Unless otherwise stated the results shown in this test report refer only to the sample(s) tested and such sample(s) are retained for 90 days only.

除非另有說明，此報告結果僅對測試之樣品負責，同時此樣品僅保留90天。本報告未經本公司書面許可，不可部份複製。

This document is issued by the Company subject to its General Conditions of Service printed overleaf, available on request or accessible at www.sgs.com/terms_and_conditions.htm and for electronic format documents, subject to Terms and Conditions for Electronic Documents at www.sgs.com/terms_e-document.htm. Attention is drawn to the limitation of liability, indemnification and jurisdiction issues defined therein. Any holder of this document is advised that information contained hereon reflects the Company's findings at the time of its intervention only and within the limits of Client's instructions, if any. The Company's sole responsibility is to its Client and this document does not exonerate parties to a transaction from exercising all their rights and obligations under the transaction documents. This document cannot be reproduced except in full, without prior written approval of the Company. Any unauthorized alteration, forgery or falsification of the content or appearance of this document is unlawful and offenders may be prosecuted to the fullest extent of the law.

Tx1 antenna						
Band	Mode	Channel	Frequency (MHz)	Data Rate	Max. Rated Avg. Power + Max. Tolerance (dBm)	Average power (dBm)
5600 MHz	802.11a	100	5500	6Mbps	7.00	6.97
		104	5520		7.00	6.70
		116	5580		7.00	6.89
		120	5600		7.00	6.95
		136	5680		7.00	6.60
		140	5700		7.00	6.84
		144	5720		7.00	6.69
	802.11n20-HT0	100	5500	MCS0	7.00	6.89
		104	5520		7.00	6.61
		116	5580		7.00	6.60
		120	5600		7.00	6.86
		136	5680		7.00	6.84
		140	5700		7.00	6.79
	802.11ac20-VHT0	100	5500	MCS0	7.00	6.76
		104	5520		7.00	6.80
		116	5580		7.00	6.86
		120	5600		7.00	6.59
		136	5680		7.00	6.72
		140	5700		7.00	6.82
	802.11ax20-HE0	100	5500	MCS0	7.00	6.66
		104	5520		7.00	6.83
		116	5580		7.00	6.66
		120	5600		7.00	6.81
		136	5680		7.00	6.87
		140	5700		7.00	6.64
		144	5720		7.00	6.79

Unless otherwise stated the results shown in this test report refer only to the sample(s) tested and such sample(s) are retained for 90 days only.

除非另有說明，此報告結果僅對測試之樣品負責，同時此樣品僅保留90天。本報告未經本公司書面許可，不可部份複製。

This document is issued by the Company subject to its General Conditions of Service printed overleaf, available on request or accessible at www.sgs.com/terms_and_conditions.htm and for electronic format documents, subject to Terms and Conditions for Electronic Documents at www.sgs.com/terms_e-document.htm. Attention is drawn to the limitation of liability, indemnification and jurisdiction issues defined therein. Any holder of this document is advised that information contained hereon reflects the Company's findings at the time of its intervention only and within the limits of Client's instructions, if any. The Company's sole responsibility is to its Client and this document does not exonerate parties to a transaction from exercising all their rights and obligations under the transaction documents. This document cannot be reproduced except in full, without prior written approval of the Company. Any unauthorized alteration, forgery or falsification of the content or appearance of this document is unlawful and offenders may be prosecuted to the fullest extent of the law.

Tx1 antenna						
Band	Mode	Channel	Frequency (MHz)	Data Rate	Max. Rated Avg. Power + Max. Tolerance (dBm)	Average power (dBm)
5600 MHz	802.11n40-HT0	102	5510	MCS0	7.00	6.75
		110	5550		7.00	6.64
		118	5590		7.00	6.65
		134	5670		7.00	6.78
		142	5710		7.00	6.87
	802.11ac40-VHT0	102	5510	MCS0	7.00	6.63
		110	5550		7.00	6.90
		118	5590		7.00	6.92
		134	5670		7.00	6.74
		142	5710		7.00	6.81
	802.11ax40-HE0	102	5510	MCS0	7.00	6.90
		110	5550		7.00	6.68
		118	5590		7.00	6.74
		134	5670		7.00	6.92
		142	5710		7.00	6.64
	802.11ac80-VHT0	106	5530	MCS0	7.00	6.99
		122	5610		7.00	6.91
		138	5690		7.00	6.98
	802.11ax80-HE0	106	5530	MCS0	7.00	6.83
		122	5610		7.00	6.75
		138	5690		7.00	6.89
802.11ac160-VHT0	114	5570	MCS0	7.00	6.93	
802.11ax160-HE0	114	5570	MCS0	7.00	6.95	

Unless otherwise stated the results shown in this test report refer only to the sample(s) tested and such sample(s) are retained for 90 days only.

除非另有說明，此報告結果僅對測試之樣品負責，同時此樣品僅保留90天。本報告未經本公司書面許可，不可部份複製。

This document is issued by the Company subject to its General Conditions of Service printed overleaf, available on request or accessible at www.sgs.com/terms_and_conditions.htm and for electronic format documents, subject to Terms and Conditions for Electronic Documents at www.sgs.com/terms_e-document.htm. Attention is drawn to the limitation of liability, indemnification and jurisdiction issues defined therein. Any holder of this document is advised that information contained hereon reflects the Company's findings at the time of its intervention only and within the limits of Client's instructions, if any. The Company's sole responsibility is to its Client and this document does not exonerate parties to a transaction from exercising all their rights and obligations under the transaction documents. This document cannot be reproduced except in full, without prior written approval of the Company. Any unauthorized alteration, forgery or falsification of the content or appearance of this document is unlawful and offenders may be prosecuted to the fullest extent of the law.

Tx1 antenna						
Mode	Mode	Channel	Frequency (MHz)	Data Rate	Max. Rated Avg. Power + Max. Tolerance (dBm)	Average power (dBm)
5800 MHz	802.11a	149	5745	6Mbps	7.00	6.69
		157	5785		7.00	6.63
		165	5825		7.00	6.59
	802.11n20-HT0	149	5745	MCS0	7.00	6.87
		157	5785		7.00	6.76
		165	5825		7.00	6.90
	802.11ac20-VHT0	149	5745	MCS0	7.00	6.93
		157	5785		7.00	6.64
		165	5825		7.00	6.78
	802.11ax20-HE0	149	5745	MCS0	7.00	6.77
		157	5785		7.00	6.75
		165	5825		7.00	6.96
	802.11n40-HT0	151	5755	MCS0	7.00	6.97
		159	5795		7.00	6.93
	802.11ac40-VHT0	151	5755	MCS0	7.00	6.76
		159	5795		7.00	6.91
	802.11ax40-HE0	151	5755	MCS0	7.00	6.67
		159	5795		7.00	6.82
802.11ac80-VHT0	155	5775	MCS0	7.00	6.93	
802.11ax80-HE0	155	5775	MCS0	7.00	6.61	

Unless otherwise stated the results shown in this test report refer only to the sample(s) tested and such sample(s) are retained for 90 days only.

除非另有說明，此報告結果僅對測試之樣品負責，同時此樣品僅保留90天。本報告未經本公司書面許可，不可部份複製。

This document is issued by the Company subject to its General Conditions of Service printed overleaf, available on request or accessible at www.sgs.com/terms_and_conditions.htm and for electronic format documents, subject to Terms and Conditions for Electronic Documents at www.sgs.com/terms_e-document.htm. Attention is drawn to the limitation of liability, indemnification and jurisdiction issues defined therein. Any holder of this document is advised that information contained hereon reflects the Company's findings at the time of its intervention only and within the limits of Client's instructions, if any. The Company's sole responsibility is to its Client and this document does not exonerate parties to a transaction from exercising all their rights and obligations under the transaction documents. This document cannot be reproduced except in full, without prior written approval of the Company. Any unauthorized alteration, forgery or falsification of the content or appearance of this document is unlawful and offenders may be prosecuted to the fullest extent of the law.

Tx2 antenna						
Band	Mode	Channel	Frequency (MHz)	Data Rate	Max. Rated Avg. Power + Max. Tolerance (dBm)	Average power (dBm)
2450 MHz	802.11b	1	2412	1Mbps	8.00	7.95
		6	2437		8.00	7.94
		11	2462		8.00	7.96
		12	2467		8.00	7.90
		13	2472		8.00	7.91
	802.11g	1	2412	6Mbps	8.00	7.72
		2	2417		8.00	7.74
		6	2437		8.00	7.99
		10	2457		8.00	7.90
		11	2462		8.00	7.84
		12	2467		8.00	7.78
		13	2472		8.00	7.98
	802.11n20-HT0	1	2412	MCS0	8.00	7.90
		2	2417		8.00	7.72
		6	2437		8.00	7.87
		10	2457		8.00	7.88
		11	2462		8.00	7.67
		12	2467		8.00	7.95
		13	2472		8.00	7.92
	802.11ax20-HEC	1	2412	MCS0	8.00	7.61
		2	2417		8.00	7.60
		6	2437		8.00	7.67
		10	2457		8.00	7.89
		11	2462		8.00	7.74
12		2467	8.00		7.74	
13		2472	8.00		7.92	

Unless otherwise stated the results shown in this test report refer only to the sample(s) tested and such sample(s) are retained for 90 days only.

除非另有說明，此報告結果僅對測試之樣品負責，同時此樣品僅保留90天。本報告未經本公司書面許可，不可部份複製。

This document is issued by the Company subject to its General Conditions of Service printed overleaf, available on request or accessible at www.sgs.com/terms_and_conditions.htm and for electronic format documents, subject to Terms and Conditions for Electronic Documents at www.sgs.com/terms_e-document.htm. Attention is drawn to the limitation of liability, indemnification and jurisdiction issues defined therein. Any holder of this document is advised that information contained hereon reflects the Company's findings at the time of its intervention only and within the limits of Client's instructions, if any. The Company's sole responsibility is to its Client and this document does not exonerate parties to a transaction from exercising all their rights and obligations under the transaction documents. This document cannot be reproduced except in full, without prior written approval of the Company. Any unauthorized alteration, forgery or falsification of the content or appearance of this document is unlawful and offenders may be prosecuted to the fullest extent of the law.

Tx2 antenna						
Band	Mode	Channel	Frequency (MHz)	Data Rate	Max. Rated Avg. Power + Max. Tolerance (dBm)	Average power (dBm)
2450 MHz	802.11n40-HT0	3	2422	MCS0	8.00	7.71
		4	2427		8.00	7.59
		6	2437		8.00	7.67
		8	2447		8.00	7.74
		9	2452		8.00	7.87
		10	2457		8.00	7.73
		11	2462		8.00	7.94
	802.11ax40-HE0	3	2422	MCS0	8.00	7.92
		4	2427		8.00	7.91
		6	2437		8.00	7.74
		8	2447		8.00	7.87
		9	2452		8.00	7.81
		10	2457		8.00	7.80
		11	2462		8.00	7.88

Unless otherwise stated the results shown in this test report refer only to the sample(s) tested and such sample(s) are retained for 90 days only.

除非另有說明，此報告結果僅對測試之樣品負責，同時此樣品僅保留90天。本報告未經本公司書面許可，不可部份複製。

This document is issued by the Company subject to its General Conditions of Service printed overleaf, available on request or accessible at www.sgs.com/terms_and_conditions.htm and for electronic format documents, subject to Terms and Conditions for Electronic Documents at www.sgs.com/terms_e-document.htm. Attention is drawn to the limitation of liability, indemnification and jurisdiction issues defined therein. Any holder of this document is advised that information contained hereon reflects the Company's findings at the time of its intervention only and within the limits of Client's instructions, if any. The Company's sole responsibility is to its Client and this document does not exonerate parties to a transaction from exercising all their rights and obligations under the transaction documents. This document cannot be reproduced except in full, without prior written approval of the Company. Any unauthorized alteration, forgery or falsification of the content or appearance of this document is unlawful and offenders may be prosecuted to the fullest extent of the law.

Tx2 antenna						
Band	Mode	Channel	Frequency (MHz)	Data Rate	Max. Rated Avg. Power + Max. Tolerance (dBm)	Average power (dBm)
5.15-5.25 GHz	802.11a	36	5180	6Mbps	7.00	6.77
		40	5200		7.00	6.66
		44	5220		7.00	6.60
		48	5240		7.00	6.62
	802.11n20-HT0	36	5180	MCS0	7.00	6.76
		40	5200		7.00	6.82
		44	5220		7.00	6.72
		48	5240		7.00	6.63
	802.11ac20-VHT0	36	5180	MCS0	7.00	6.70
		40	5200		7.00	6.88
		44	5220		7.00	6.73
		48	5240		7.00	6.89
	802.11ax20-HE0	36	5180	MCS0	7.00	6.60
		40	5200		7.00	6.67
		44	5220		7.00	6.93
		48	5240		7.00	6.70
	802.11n40-HT0	38	5190	MCS0	7.00	6.97
		46	5230		7.00	6.96
	802.11ac40-VHT0	38	5190	MCS0	7.00	6.88
		46	5230		7.00	6.75
802.11ax40-HE0	38	5190	MCS0	7.00	6.97	
	46	5230		7.00	6.88	
802.11ac80-VHT0	42	5210	MCS0	7.00	6.92	
802.11ax80-HE0	42	5210	MCS0	7.00	6.61	
802.11ac160-VHT0	50	5250	MCS0	7.00	6.88	
802.11ax160-HE0	50	5250	MCS0	7.00	6.84	

Unless otherwise stated the results shown in this test report refer only to the sample(s) tested and such sample(s) are retained for 90 days only.

除非另有說明，此報告結果僅對測試之樣品負責，同時此樣品僅保留90天。本報告未經本公司書面許可，不可部份複製。

This document is issued by the Company subject to its General Conditions of Service printed overleaf, available on request or accessible at www.sgs.com/terms_and_conditions.htm and for electronic format documents, subject to Terms and Conditions for Electronic Documents at www.sgs.com/terms_e-document.htm. Attention is drawn to the limitation of liability, indemnification and jurisdiction issues defined therein. Any holder of this document is advised that information contained hereon reflects the Company's findings at the time of its intervention only and within the limits of Client's instructions, if any. The Company's sole responsibility is to its Client and this document does not exonerate parties to a transaction from exercising all their rights and obligations under the transaction documents. This document cannot be reproduced except in full, without prior written approval of the Company. Any unauthorized alteration, forgery or falsification of the content or appearance of this document is unlawful and offenders may be prosecuted to the fullest extent of the law.

Tx2 antenna						
Band	Mode	Channel	Frequency (MHz)	Data Rate	Max. Rated Avg. Power + Max. Tolerance (dBm)	Average power (dBm)
5.25-5.35 GHz	802.11a	52	5260	6Mbps	7.00	6.73
		56	5280		7.00	6.98
		60	5300		7.00	6.62
		64	5320		7.00	6.95
	802.11n20-HT0	52	5260	MCS0	7.00	6.93
		56	5280		7.00	6.82
		60	5300		7.00	6.77
		64	5320		7.00	6.63
	802.11ac20-VHT0	52	5260	MCS0	7.00	6.84
		56	5280		7.00	6.98
		60	5300		7.00	6.62
		64	5320		7.00	6.75
	802.11ax20-HE0	52	5260	MCS0	7.00	6.65
		56	5280		7.00	6.87
		60	5300		7.00	6.81
		64	5320		7.00	6.96
	802.11n40-HT0	54	5270	MCS0	7.00	6.92
		62	5310		7.00	6.97
	802.11ac40-VHT0	54	5270	MCS0	7.00	6.59
		62	5310		7.00	6.89
802.11ax40-HE0	54	5270	MCS0	7.00	6.61	
	62	5310		7.00	6.92	
802.11ac80-VHT0	58	5290	MCS0	7.00	6.90	
802.11ax80-HE0	58	5290	MCS0	7.00	6.85	

Unless otherwise stated the results shown in this test report refer only to the sample(s) tested and such sample(s) are retained for 90 days only.

除非另有說明，此報告結果僅對測試之樣品負責，同時此樣品僅保留90天。本報告未經本公司書面許可，不可部份複製。

This document is issued by the Company subject to its General Conditions of Service printed overleaf, available on request or accessible at www.sgs.com/terms_and_conditions.htm and for electronic format documents, subject to Terms and Conditions for Electronic Documents at www.sgs.com/terms_e-document.htm. Attention is drawn to the limitation of liability, indemnification and jurisdiction issues defined therein. Any holder of this document is advised that information contained hereon reflects the Company's findings at the time of its intervention only and within the limits of Client's instructions, if any. The Company's sole responsibility is to its Client and this document does not exonerate parties to a transaction from exercising all their rights and obligations under the transaction documents. This document cannot be reproduced except in full, without prior written approval of the Company. Any unauthorized alteration, forgery or falsification of the content or appearance of this document is unlawful and offenders may be prosecuted to the fullest extent of the law.

Tx2 antenna						
Band	Mode	Channel	Frequency (MHz)	Data Rate	Max. Rated Avg. Power + Max. Tolerance (dBm)	Average power (dBm)
5600 MHz	802.11a	100	5500	6Mbps	7.00	6.75
		104	5520		7.00	6.78
		116	5580		7.00	6.67
		120	5600		7.00	6.81
		136	5680		7.00	6.90
		140	5700		7.00	6.70
		144	5720		7.00	6.97
	802.11n20-HT0	100	5500	MCS0	7.00	6.64
		104	5520		7.00	6.91
		116	5580		7.00	6.71
		120	5600		7.00	6.77
		136	5680		7.00	6.97
		140	5700		7.00	6.61
	802.11ac20-VHT0	100	5500	MCS0	7.00	6.65
		104	5520		7.00	6.78
		116	5580		7.00	6.91
		120	5600		7.00	6.94
		136	5680		7.00	6.94
		140	5700		7.00	6.72
		144	5720		7.00	6.94
	802.11ax20-HE0	100	5500	MCS0	7.00	6.95
		104	5520		7.00	6.71
		116	5580		7.00	6.78
		120	5600		7.00	6.70
		136	5680		7.00	6.73
		140	5700		7.00	6.81
		144	5720		7.00	6.60

Unless otherwise stated the results shown in this test report refer only to the sample(s) tested and such sample(s) are retained for 90 days only.

除非另有說明，此報告結果僅對測試之樣品負責，同時此樣品僅保留90天。本報告未經本公司書面許可，不可部份複製。

This document is issued by the Company subject to its General Conditions of Service printed overleaf, available on request or accessible at www.sgs.com/terms_and_conditions.htm and for electronic format documents, subject to Terms and Conditions for Electronic Documents at www.sgs.com/terms_e-document.htm. Attention is drawn to the limitation of liability, indemnification and jurisdiction issues defined therein. Any holder of this document is advised that information contained hereon reflects the Company's findings at the time of its intervention only and within the limits of Client's instructions, if any. The Company's sole responsibility is to its Client and this document does not exonerate parties to a transaction from exercising all their rights and obligations under the transaction documents. This document cannot be reproduced except in full, without prior written approval of the Company. Any unauthorized alteration, forgery or falsification of the content or appearance of this document is unlawful and offenders may be prosecuted to the fullest extent of the law.

Tx2 antenna						
Band	Mode	Channel	Frequency (MHz)	Data Rate	Max. Rated Avg. Power + Max. Tolerance (dBm)	Average power (dBm)
5600 MHz	802.11n40-HT0	102	5510	MCS0	7.00	6.74
		110	5550		7.00	6.95
		118	5590		7.00	6.68
		134	5670		7.00	6.68
		142	5710		7.00	6.71
	802.11ac40-VHT0	102	5510	MCS0	7.00	6.66
		110	5550		7.00	6.99
		118	5590		7.00	6.77
		134	5670		7.00	6.72
		142	5710		7.00	6.94
	802.11ax40-HE0	102	5510	MCS0	7.00	6.75
		110	5550		7.00	6.60
		118	5590		7.00	6.84
		134	5670		7.00	6.64
		142	5710		7.00	6.69
	802.11ac80-VHT0	106	5530	MCS0	7.00	6.95
		122	5610		7.00	6.94
		138	5690		7.00	6.94
	802.11ax80-HE0	106	5530	MCS0	7.00	6.88
		122	5610		7.00	6.60
138		5690	7.00		6.85	
802.11ac160-VHT0	114	5570	MCS0	7.00	6.90	
802.11ax160-HE0	114	5570	MCS0	7.00	6.65	

Unless otherwise stated the results shown in this test report refer only to the sample(s) tested and such sample(s) are retained for 90 days only.

除非另有說明，此報告結果僅對測試之樣品負責，同時此樣品僅保留90天。本報告未經本公司書面許可，不可部份複製。

This document is issued by the Company subject to its General Conditions of Service printed overleaf, available on request or accessible at www.sgs.com/terms_and_conditions.htm and for electronic format documents, subject to Terms and Conditions for Electronic Documents at www.sgs.com/terms_e-document.htm. Attention is drawn to the limitation of liability, indemnification and jurisdiction issues defined therein. Any holder of this document is advised that information contained hereon reflects the Company's findings at the time of its intervention only and within the limits of Client's instructions, if any. The Company's sole responsibility is to its Client and this document does not exonerate parties to a transaction from exercising all their rights and obligations under the transaction documents. This document cannot be reproduced except in full, without prior written approval of the Company. Any unauthorized alteration, forgery or falsification of the content or appearance of this document is unlawful and offenders may be prosecuted to the fullest extent of the law.

Tx2 antenna						
Mode	Mode	Channel	Frequency (MHz)	Data Rate	Max. Rated Avg. Power + Max. Tolerance (dBm)	Average power (dBm)
5800 MHz	802.11a	149	5745	6Mbps	7.00	6.66
		157	5785		7.00	6.83
		165	5825		7.00	6.94
	802.11n20-HT0	149	5745	MCS0	7.00	6.68
		157	5785		7.00	6.80
		165	5825		7.00	6.88
	802.11ac20-VHT0	149	5745	MCS0	7.00	6.86
		157	5785		7.00	6.83
		165	5825		7.00	6.77
	802.11ax20-HE0	149	5745	MCS0	7.00	6.79
		157	5785		7.00	6.85
		165	5825		7.00	6.71
	802.11n40-HT0	151	5755	MCS0	7.00	6.91
		159	5795		7.00	6.90
	802.11ac40-VHT0	151	5755	MCS0	7.00	6.74
		159	5795		7.00	6.82
	802.11ax40-HE0	151	5755	MCS0	7.00	6.70
		159	5795		7.00	6.61
802.11ac80-VHT0	155	5775	MCS0	7.00	6.94	
802.11ax80-HE0	155	5775	MCS0	7.00	6.70	

Unless otherwise stated the results shown in this test report refer only to the sample(s) tested and such sample(s) are retained for 90 days only.

除非另有說明，此報告結果僅對測試之樣品負責，同時此樣品僅保留90天。本報告未經本公司書面許可，不可部份複製。

This document is issued by the Company subject to its General Conditions of Service printed overleaf, available on request or accessible at www.sgs.com/terms_and_conditions.htm and for electronic format documents, subject to Terms and Conditions for Electronic Documents at www.sgs.com/terms_e-document.htm. Attention is drawn to the limitation of liability, indemnification and jurisdiction issues defined therein. Any holder of this document is advised that information contained hereon reflects the Company's findings at the time of its intervention only and within the limits of Client's instructions, if any. The Company's sole responsibility is to its Client and this document does not exonerate parties to a transaction from exercising all their rights and obligations under the transaction documents. This document cannot be reproduced except in full, without prior written approval of the Company. Any unauthorized alteration, forgery or falsification of the content or appearance of this document is unlawful and offenders may be prosecuted to the fullest extent of the law.

WLAN MIMO power

Tx1 antenna						
Band	Mode	Channel	Frequency (MHz)	Data Rate	Max. Rated Avg. Power + Max. Tolerance (dBm)	Average power (dBm)
2450 MHz	802.11n20-HT0	1	2412	MCS0	8.00	7.70
		6	2437		8.00	7.89
		11	2462		8.00	7.86
		12	2467		8.00	7.61
		13	2472		8.00	7.76
	802.11ax20-HEC	1	2412	MCS0	8.00	7.62
		2	2417		8.00	7.71
		6	2437		8.00	7.89
		10	2457		8.00	7.85
		11	2462		8.00	7.79
		12	2467		8.00	7.51
	802.11n40-HT0	3	2422	MCS0	8.00	7.53
		4	2427		8.00	7.69
		6	2437		8.00	7.55
		8	2447		8.00	7.82
		9	2452		8.00	7.72
		10	2457		8.00	7.67
	802.11ax40-HEC	11	2462	MCS0	8.00	7.77
		3	2422		8.00	7.67
		4	2427		8.00	7.77
		6	2437		8.00	7.62
		8	2447		8.00	7.63
		9	2452		8.00	7.62
		10	2457		8.00	7.58
	11	2462	8.00	7.53		

Unless otherwise stated the results shown in this test report refer only to the sample(s) tested and such sample(s) are retained for 90 days only.

除非另有說明，此報告結果僅對測試之樣品負責，同時此樣品僅保留90天。本報告未經本公司書面許可，不可部份複製。

This document is issued by the Company subject to its General Conditions of Service printed overleaf, available on request or accessible at www.sgs.com/terms_and_conditions.htm and for electronic format documents, subject to Terms and Conditions for Electronic Documents at www.sgs.com/terms_e-document.htm. Attention is drawn to the limitation of liability, indemnification and jurisdiction issues defined therein. Any holder of this document is advised that information contained hereon reflects the Company's findings at the time of its intervention only and within the limits of Client's instructions, if any. The Company's sole responsibility is to its Client and this document does not exonerate parties to a transaction from exercising all their rights and obligations under the transaction documents. This document cannot be reproduced except in full, without prior written approval of the Company. Any unauthorized alteration, forgery or falsification of the content or appearance of this document is unlawful and offenders may be prosecuted to the fullest extent of the law.

Tx1 antenna						
Band	Mode	Channel	Frequency (MHz)	Data Rate	Max. Rated Avg. Power + Max. Tolerance (dBm)	Average power (dBm)
5.15-5.25 GHz	802.11n20-HT0	36	5180	MCS0	7.00	6.83
		40	5200		7.00	6.58
		44	5220		7.00	6.89
		48	5240		7.00	6.72
	802.11ac20-VHT0	36	5180	MCS0	7.00	6.83
		40	5200		7.00	6.55
		44	5220		7.00	6.76
		48	5240		7.00	6.71
	802.11ax20-HE0	36	5180	MCS0	7.00	6.75
		40	5200		7.00	6.67
		44	5220		7.00	6.82
		48	5240		7.00	6.55
	802.11n40-HT0	38	5190	MCS0	7.00	6.61
		46	5230		7.00	6.53
	802.11ac40-VHT0	38	5190	MCS0	7.00	6.77
		46	5230		7.00	6.62
	802.11ax40-HE0	38	5190	MCS0	7.00	6.72
		46	5230		7.00	6.60
802.11ac80-VHT0	42	5210	MCS0	7.00	6.82	
802.11ax80-HE0	42	5210	MCS0	7.00	6.65	
802.11ac160-VHT0	50	5250	MCS0	7.00	6.70	
802.11ax160-HE0	50	5250	MCS0	7.00	6.77	

Unless otherwise stated the results shown in this test report refer only to the sample(s) tested and such sample(s) are retained for 90 days only.

除非另有說明，此報告結果僅對測試之樣品負責，同時此樣品僅保留90天。本報告未經本公司書面許可，不可部份複製。

This document is issued by the Company subject to its General Conditions of Service printed overleaf, available on request or accessible at www.sgs.com/terms_and_conditions.htm and for electronic format documents, subject to Terms and Conditions for Electronic Documents at www.sgs.com/terms_e-document.htm. Attention is drawn to the limitation of liability, indemnification and jurisdiction issues defined therein. Any holder of this document is advised that information contained hereon reflects the Company's findings at the time of its intervention only and within the limits of Client's instructions, if any. The Company's sole responsibility is to its Client and this document does not exonerate parties to a transaction from exercising all their rights and obligations under the transaction documents. This document cannot be reproduced except in full, without prior written approval of the Company. Any unauthorized alteration, forgery or falsification of the content or appearance of this document is unlawful and offenders may be prosecuted to the fullest extent of the law.

Tx1 antenna						
Band	Mode	Channel	Frequency (MHz)	Data Rate	Max. Rated Avg. Power + Max. Tolerance (dBm)	Average power (dBm)
5.25-5.35 GHz	802.11n20-HT0	52	5260	MCS0	7.00	6.53
		56	5280		7.00	6.54
		60	5300		7.00	6.68
		64	5320		7.00	6.99
	802.11ac20-VHT0	52	5260	MCS0	7.00	6.62
		56	5280		7.00	6.79
		60	5300		7.00	6.83
		64	5320		7.00	6.85
	802.11ax20-HE0	52	5260	MCS0	7.00	6.48
		56	5280		7.00	6.76
		60	5300		7.00	6.66
		64	5320		7.00	6.70
	802.11n40-HT0	54	5270	MCS0	7.00	6.69
		62	5310		7.00	6.87
	802.11ac40-VHT0	54	5270	MCS0	7.00	6.79
		62	5310		7.00	6.87
	802.11ax40-HE0	54	5270	MCS0	7.00	6.60
		62	5310		7.00	6.72
802.11ac80-VHT0	58	5290	MCS0	7.00	6.82	
802.11ax80-HE0	58	5290	MCS0	7.00	6.91	

Unless otherwise stated the results shown in this test report refer only to the sample(s) tested and such sample(s) are retained for 90 days only.

除非另有說明，此報告結果僅對測試之樣品負責，同時此樣品僅保留90天。本報告未經本公司書面許可，不可部份複製。

This document is issued by the Company subject to its General Conditions of Service printed overleaf, available on request or accessible at www.sgs.com/terms_and_conditions.htm and for electronic format documents, subject to Terms and Conditions for Electronic Documents at www.sgs.com/terms_e-document.htm. Attention is drawn to the limitation of liability, indemnification and jurisdiction issues defined therein. Any holder of this document is advised that information contained hereon reflects the Company's findings at the time of its intervention only and within the limits of Client's instructions, if any. The Company's sole responsibility is to its Client and this document does not exonerate parties to a transaction from exercising all their rights and obligations under the transaction documents. This document cannot be reproduced except in full, without prior written approval of the Company. Any unauthorized alteration, forgery or falsification of the content or appearance of this document is unlawful and offenders may be prosecuted to the fullest extent of the law.

Tx1 antenna						
Band	Mode	Channel	Frequency (MHz)	Data Rate	Max. Rated Avg. Power + Max. Tolerance (dBm)	Average power (dBm)
5600 MHz	802.11n20-HT0	100	5500	MCS0	7.00	6.53
		104	5520		7.00	6.93
		116	5580		7.00	6.62
		120	5600		7.00	6.93
		136	5680		7.00	6.53
		140	5700		7.00	6.66
		144	5720		7.00	6.51
	802.11ac20-VHT0	100	5500	MCS0	7.00	6.65
		104	5520		7.00	6.80
		116	5580		7.00	6.57
		120	5600		7.00	6.93
		136	5680		7.00	6.62
		140	5700		7.00	6.51
	802.11ax20-HE0	100	5500	MCS0	7.00	6.90
		104	5520		7.00	6.77
		116	5580		7.00	6.73
		120	5600		7.00	6.70
		136	5680		7.00	6.66
		140	5700		7.00	6.87
		144	5720		7.00	6.86

Unless otherwise stated the results shown in this test report refer only to the sample(s) tested and such sample(s) are retained for 90 days only.

除非另有說明，此報告結果僅對測試之樣品負責，同時此樣品僅保留90天。本報告未經本公司書面許可，不可部份複製。

This document is issued by the Company subject to its General Conditions of Service printed overleaf, available on request or accessible at www.sgs.com/terms_and_conditions.htm and for electronic format documents, subject to Terms and Conditions for Electronic Documents at www.sgs.com/terms_e-document.htm. Attention is drawn to the limitation of liability, indemnification and jurisdiction issues defined therein. Any holder of this document is advised that information contained hereon reflects the Company's findings at the time of its intervention only and within the limits of Client's instructions, if any. The Company's sole responsibility is to its Client and this document does not exonerate parties to a transaction from exercising all their rights and obligations under the transaction documents. This document cannot be reproduced except in full, without prior written approval of the Company. Any unauthorized alteration, forgery or falsification of the content or appearance of this document is unlawful and offenders may be prosecuted to the fullest extent of the law.

Tx1 antenna						
Band	Mode	Channel	Frequency (MHz)	Data Rate	Max. Rated Avg. Power + Max. Tolerance (dBm)	Average power (dBm)
5600 MHz	802.11n40-HT0	102	5510	MCS0	7.00	6.68
		110	5550		7.00	6.76
		118	5590		7.00	6.72
		134	5670		7.00	6.52
		142	5710		7.00	6.73
	802.11ac40-VHT0	102	5510	MCS0	7.00	6.97
		110	5550		7.00	6.70
		118	5590		7.00	6.81
		134	5670		7.00	6.49
		142	5710		7.00	6.87
	802.11ax40-HE0	102	5510	MCS0	7.00	6.79
		110	5550		7.00	6.83
		118	5590		7.00	6.50
		134	5670		7.00	6.84
		142	5710		7.00	6.78
	802.11ac80-VHT0	106	5530	MCS0	7.00	6.91
		122	5610		7.00	6.96
		138	5690		7.00	6.86
	802.11ax80-HE0	106	5530	MCS0	7.00	6.77
		122	5610		7.00	6.49
		138	5690		7.00	6.71
802.11ac160-VHT0	114	5570	MCS0	7.00	6.94	
802.11ax160-HE0	114	5570	MCS0	7.00	6.75	

Unless otherwise stated the results shown in this test report refer only to the sample(s) tested and such sample(s) are retained for 90 days only.

除非另有說明，此報告結果僅對測試之樣品負責，同時此樣品僅保留90天。本報告未經本公司書面許可，不可部份複製。

This document is issued by the Company subject to its General Conditions of Service printed overleaf, available on request or accessible at www.sgs.com/terms_and_conditions.htm and for electronic format documents, subject to Terms and Conditions for Electronic Documents at www.sgs.com/terms_e-document.htm. Attention is drawn to the limitation of liability, indemnification and jurisdiction issues defined therein. Any holder of this document is advised that information contained hereon reflects the Company's findings at the time of its intervention only and within the limits of Client's instructions, if any. The Company's sole responsibility is to its Client and this document does not exonerate parties to a transaction from exercising all their rights and obligations under the transaction documents. This document cannot be reproduced except in full, without prior written approval of the Company. Any unauthorized alteration, forgery or falsification of the content or appearance of this document is unlawful and offenders may be prosecuted to the fullest extent of the law.

Tx1 antenna						
Mode	Mode	Channel	Frequency (MHz)	Data Rate	Max. Rated Avg. Power + Max. Tolerance (dBm)	Average power (dBm)
5800 MHz	802.11n20-HT0	149	5745	MCS0	7.00	6.68
		157	5785		7.00	6.65
		165	5825		7.00	6.70
	802.11ac20-VHT0	149	5745	MCS0	7.00	6.84
		157	5785		7.00	6.91
		165	5825		7.00	6.75
	802.11ax20-HE0	149	5745	MCS0	7.00	6.80
		157	5785		7.00	6.63
		165	5825		7.00	6.81
	802.11n40-HT0	151	5755	MCS0	7.00	6.80
		159	5795		7.00	6.78
	802.11ac40-VHT0	151	5755	MCS0	7.00	6.74
		159	5795		7.00	6.76
	802.11ax40-HE0	151	5755	MCS0	7.00	6.93
		159	5795		7.00	6.60
802.11ac80-VHT0	155	5775	MCS0	7.00	6.82	
802.11ax80-HE0	155	5775	MCS0	7.00	6.69	

Unless otherwise stated the results shown in this test report refer only to the sample(s) tested and such sample(s) are retained for 90 days only.

除非另有說明，此報告結果僅對測試之樣品負責，同時此樣品僅保留90天。本報告未經本公司書面許可，不可部份複製。

This document is issued by the Company subject to its General Conditions of Service printed overleaf, available on request or accessible at www.sgs.com/terms_and_conditions.htm and for electronic format documents, subject to Terms and Conditions for Electronic Documents at www.sgs.com/terms_e-document.htm. Attention is drawn to the limitation of liability, indemnification and jurisdiction issues defined therein. Any holder of this document is advised that information contained hereon reflects the Company's findings at the time of its intervention only and within the limits of Client's instructions, if any. The Company's sole responsibility is to its Client and this document does not exonerate parties to a transaction from exercising all their rights and obligations under the transaction documents. This document cannot be reproduced except in full, without prior written approval of the Company. Any unauthorized alteration, forgery or falsification of the content or appearance of this document is unlawful and offenders may be prosecuted to the fullest extent of the law.

Tx2 antenna							
Band	Mode	Channel	Frequency (MHz)	Data Rate	Max. Rated Avg. Power + Max. Tolerance (dBm)	Average power (dBm)	
2450 MHz	802.11n20-HT0	1	2412	MCS0	8.00	7.72	
		6	2437		8.00	7.64	
		11	2462		8.00	7.83	
		12	2467		8.00	7.51	
		13	2472		8.00	7.74	
	802.11ax20-HE0	1	2412	MCS0	8.00	7.52	
		2	2417		8.00	7.62	
		6	2437		8.00	7.61	
		10	2457		8.00	7.70	
		11	2462		8.00	7.85	
		12	2467		8.00	7.83	
	802.11n40-HT0	3	2422	MCS0	8.00	7.46	
		4	2427		8.00	7.64	
		6	2437		8.00	7.94	
		8	2447		8.00	7.90	
		9	2452		8.00	7.60	
		10	2457		8.00	7.69	
	802.11ax40-HE0	3	2422	MCS0	8.00	7.57	
		4	2427		8.00	7.61	
		6	2437		8.00	7.81	
		8	2447		8.00	7.78	
		9	2452		8.00	7.77	
		10	2457		8.00	7.96	
			11	2462		8.00	7.57

Unless otherwise stated the results shown in this test report refer only to the sample(s) tested and such sample(s) are retained for 90 days only.

除非另有說明，此報告結果僅對測試之樣品負責，同時此樣品僅保留90天。本報告未經本公司書面許可，不可部份複製。

This document is issued by the Company subject to its General Conditions of Service printed overleaf, available on request or accessible at www.sgs.com/terms_and_conditions.htm and for electronic format documents, subject to Terms and Conditions for Electronic Documents at www.sgs.com/terms_e-document.htm. Attention is drawn to the limitation of liability, indemnification and jurisdiction issues defined therein. Any holder of this document is advised that information contained hereon reflects the Company's findings at the time of its intervention only and within the limits of Client's instructions, if any. The Company's sole responsibility is to its Client and this document does not exonerate parties to a transaction from exercising all their rights and obligations under the transaction documents. This document cannot be reproduced except in full, without prior written approval of the Company. Any unauthorized alteration, forgery or falsification of the content or appearance of this document is unlawful and offenders may be prosecuted to the fullest extent of the law.

Tx2 antenna						
Band	Mode	Channel	Frequency (MHz)	Data Rate	Max. Rated Avg. Power + Max. Tolerance (dBm)	Average power (dBm)
5.15-5.25 GHz	802.11n20-HT0	36	5180	MCS0	7.00	6.57
		40	5200		7.00	6.69
		44	5220		7.00	6.74
		48	5240		7.00	6.41
	802.11ac20-VHT0	36	5180	MCS0	7.00	6.89
		40	5200		7.00	6.60
		44	5220		7.00	6.79
		48	5240		7.00	6.64
	802.11ax20-HE0	36	5180	MCS0	7.00	6.72
		40	5200		7.00	6.62
		44	5220		7.00	6.68
		48	5240		7.00	6.66
	802.11n40-HT0	38	5190	MCS0	7.00	6.70
		46	5230		7.00	6.57
	802.11ac40-VHT0	38	5190	MCS0	7.00	6.78
		46	5230		7.00	6.51
	802.11ax40-HE0	38	5190	MCS0	7.00	6.69
		46	5230		7.00	6.78
	802.11ac80-VHT0	42	5210	MCS0	7.00	6.75
	802.11ax80-HE0	42	5210	MCS0	7.00	6.48
802.11ac160-VHT0	50	5250	MCS0	7.00	6.92	
802.11ax160-HE0	50	5250	MCS0	7.00	6.63	

Unless otherwise stated the results shown in this test report refer only to the sample(s) tested and such sample(s) are retained for 90 days only.

除非另有說明，此報告結果僅對測試之樣品負責，同時此樣品僅保留90天。本報告未經本公司書面許可，不可部份複製。

This document is issued by the Company subject to its General Conditions of Service printed overleaf, available on request or accessible at www.sgs.com/terms_and_conditions.htm and for electronic format documents, subject to Terms and Conditions for Electronic Documents at www.sgs.com/terms_e-document.htm. Attention is drawn to the limitation of liability, indemnification and jurisdiction issues defined therein. Any holder of this document is advised that information contained hereon reflects the Company's findings at the time of its intervention only and within the limits of Client's instructions, if any. The Company's sole responsibility is to its Client and this document does not exonerate parties to a transaction from exercising all their rights and obligations under the transaction documents. This document cannot be reproduced except in full, without prior written approval of the Company. Any unauthorized alteration, forgery or falsification of the content or appearance of this document is unlawful and offenders may be prosecuted to the fullest extent of the law.

Tx2 antenna						
Band	Mode	Channel	Frequency (MHz)	Data Rate	Max. Rated Avg. Power + Max. Tolerance (dBm)	Average power (dBm)
5.25-5.35 GHz	802.11n20-HT0	52	5260	MCS0	7.00	6.62
		56	5280		7.00	6.65
		60	5300		7.00	6.69
		64	5320		7.00	6.89
	802.11ac20-VHT0	52	5260	MCS0	7.00	6.63
		56	5280		7.00	6.96
		60	5300		7.00	6.59
		64	5320		7.00	6.85
	802.11ax20-HE0	52	5260	MCS0	7.00	6.71
		56	5280		7.00	6.51
		60	5300		7.00	6.66
		64	5320		7.00	6.47
	802.11n40-HT0	54	5270	MCS0	7.00	6.85
		62	5310		7.00	6.92
	802.11ac40-VHT0	54	5270	MCS0	7.00	6.81
		62	5310		7.00	6.72
	802.11ax40-HE0	54	5270	MCS0	7.00	6.59
		62	5310		7.00	6.85
	802.11ac80-VHT0	58	5290	MCS0	7.00	6.75
	802.11ax80-HE0	58	5290	MCS0	7.00	6.61

Unless otherwise stated the results shown in this test report refer only to the sample(s) tested and such sample(s) are retained for 90 days only.

除非另有說明，此報告結果僅對測試之樣品負責，同時此樣品僅保留90天。本報告未經本公司書面許可，不可部份複製。

This document is issued by the Company subject to its General Conditions of Service printed overleaf, available on request or accessible at www.sgs.com/terms_and_conditions.htm and for electronic format documents, subject to Terms and Conditions for Electronic Documents at www.sgs.com/terms_e-document.htm. Attention is drawn to the limitation of liability, indemnification and jurisdiction issues defined therein. Any holder of this document is advised that information contained hereon reflects the Company's findings at the time of its intervention only and within the limits of Client's instructions, if any. The Company's sole responsibility is to its Client and this document does not exonerate parties to a transaction from exercising all their rights and obligations under the transaction documents. This document cannot be reproduced except in full, without prior written approval of the Company. Any unauthorized alteration, forgery or falsification of the content or appearance of this document is unlawful and offenders may be prosecuted to the fullest extent of the law.

Tx2 antenna						
Band	Mode	Channel	Frequency (MHz)	Data Rate	Max. Rated Avg. Power + Max. Tolerance (dBm)	Average power (dBm)
5600 MHz	802.11n20-HT0	100	5500	MCS0	7.00	6.51
		104	5520		7.00	6.58
		116	5580		7.00	6.65
		120	5600		7.00	6.68
		136	5680		7.00	6.82
		140	5700		7.00	6.62
		144	5720		7.00	6.57
	802.11ac20-VHT0	100	5500	MCS0	7.00	6.66
		104	5520		7.00	6.59
		116	5580		7.00	6.68
		120	5600		7.00	6.93
		136	5680		7.00	6.88
		140	5700		7.00	6.77
	802.11ax20-HE0	100	5500	MCS0	7.00	6.72
		104	5520		7.00	6.60
		116	5580		7.00	6.53
		120	5600		7.00	6.68
		136	5680		7.00	6.75
		140	5700		7.00	6.73
		144	5720		7.00	6.63

Unless otherwise stated the results shown in this test report refer only to the sample(s) tested and such sample(s) are retained for 90 days only.

除非另有說明，此報告結果僅對測試之樣品負責，同時此樣品僅保留90天。本報告未經本公司書面許可，不可部份複製。

This document is issued by the Company subject to its General Conditions of Service printed overleaf, available on request or accessible at www.sgs.com/terms_and_conditions.htm and for electronic format documents, subject to Terms and Conditions for Electronic Documents at www.sgs.com/terms_e-document.htm. Attention is drawn to the limitation of liability, indemnification and jurisdiction issues defined therein. Any holder of this document is advised that information contained hereon reflects the Company's findings at the time of its intervention only and within the limits of Client's instructions, if any. The Company's sole responsibility is to its Client and this document does not exonerate parties to a transaction from exercising all their rights and obligations under the transaction documents. This document cannot be reproduced except in full, without prior written approval of the Company. Any unauthorized alteration, forgery or falsification of the content or appearance of this document is unlawful and offenders may be prosecuted to the fullest extent of the law.

Tx2 antenna						
Band	Mode	Channel	Frequency (MHz)	Data Rate	Max. Rated Avg. Power + Max. Tolerance (dBm)	Average power (dBm)
5600 MHz	802.11n40-HT0	102	5510	MCS0	7.00	6.54
		110	5550		7.00	6.85
		118	5590		7.00	6.57
		134	5670		7.00	6.67
		142	5710		7.00	6.96
	802.11ac40-VHT0	102	5510	MCS0	7.00	6.89
		110	5550		7.00	6.79
		118	5590		7.00	6.58
		134	5670		7.00	6.40
		142	5710		7.00	6.95
	802.11ax40-HE0	102	5510	MCS0	7.00	6.52
		110	5550		7.00	6.77
		118	5590		7.00	6.74
		134	5670		7.00	6.62
		142	5710		7.00	6.59
	802.11ac80-VHT0	106	5530	MCS0	7.00	6.82
		122	5610		7.00	6.88
		138	5690		7.00	6.64
	802.11ax80-HE0	106	5530	MCS0	7.00	6.72
		122	5610		7.00	6.55
		138	5690		7.00	6.94
	802.11ac160-VHT0	114	5570	MCS0	7.00	6.64
	802.11ax160-HE0	114	5570	MCS0	7.00	6.45

Unless otherwise stated the results shown in this test report refer only to the sample(s) tested and such sample(s) are retained for 90 days only.

除非另有說明，此報告結果僅對測試之樣品負責，同時此樣品僅保留90天。本報告未經本公司書面許可，不可部份複製。

This document is issued by the Company subject to its General Conditions of Service printed overleaf, available on request or accessible at www.sgs.com/terms_and_conditions.htm and for electronic format documents, subject to Terms and Conditions for Electronic Documents at www.sgs.com/terms_e-document.htm. Attention is drawn to the limitation of liability, indemnification and jurisdiction issues defined therein. Any holder of this document is advised that information contained hereon reflects the Company's findings at the time of its intervention only and within the limits of Client's instructions, if any. The Company's sole responsibility is to its Client and this document does not exonerate parties to a transaction from exercising all their rights and obligations under the transaction documents. This document cannot be reproduced except in full, without prior written approval of the Company. Any unauthorized alteration, forgery or falsification of the content or appearance of this document is unlawful and offenders may be prosecuted to the fullest extent of the law.

Tx2 antenna						
Mode	Mode	Channel	Frequency (MHz)	Data Rate	Max. Rated Avg. Power + Max. Tolerance (dBm)	Average power (dBm)
5800 MHz	802.11n20-HT0	149	5745	MCS0	7.00	6.87
		157	5785		7.00	6.60
		165	5825		7.00	6.86
	802.11ac20-VHT0	149	5745	MCS0	7.00	6.85
		157	5785		7.00	6.49
		165	5825		7.00	6.60
	802.11ax20-HE0	149	5745	MCS0	7.00	6.86
		157	5785		7.00	6.93
		165	5825		7.00	6.67
	802.11n40-HT0	151	5755	MCS0	7.00	6.87
		159	5795		7.00	6.62
	802.11ac40-VHT0	151	5755	MCS0	7.00	6.86
		159	5795		7.00	6.70
	802.11ax40-HE0	151	5755	MCS0	7.00	6.64
		159	5795		7.00	6.80
802.11ac80-VHT0	155	5775	MCS0	7.00	6.79	
802.11ax80-HE0	155	5775	MCS0	7.00	6.84	

Unless otherwise stated the results shown in this test report refer only to the sample(s) tested and such sample(s) are retained for 90 days only.

除非另有說明，此報告結果僅對測試之樣品負責，同時此樣品僅保留90天。本報告未經本公司書面許可，不可部份複製。

This document is issued by the Company subject to its General Conditions of Service printed overleaf, available on request or accessible at www.sgs.com/terms_and_conditions.htm and for electronic format documents, subject to Terms and Conditions for Electronic Documents at www.sgs.com/terms_e-document.htm. Attention is drawn to the limitation of liability, indemnification and jurisdiction issues defined therein. Any holder of this document is advised that information contained hereon reflects the Company's findings at the time of its intervention only and within the limits of Client's instructions, if any. The Company's sole responsibility is to its Client and this document does not exonerate parties to a transaction from exercising all their rights and obligations under the transaction documents. This document cannot be reproduced except in full, without prior written approval of the Company. Any unauthorized alteration, forgery or falsification of the content or appearance of this document is unlawful and offenders may be prosecuted to the fullest extent of the law.

WLAN only

WLAN SISO Full power

Tx1 antenna						
Band	Mode	Channel	Frequency (MHz)	Data Rate	Max. Rated Avg. Power + Max. Tolerance (dBm)	Average power (dBm)
2450 MHz	802.11b	1	2412	1Mbps	16.50	16.49
		2	2417		16.50	16.37
		6	2437		16.50	16.48
		10	2457		16.50	16.41
		11	2462		16.50	16.44
		12	2467		16.50	16.42
		13	2472		15.75	15.56
	802.11g	1	2412	6Mbps	16.50	16.34
		2	2417		16.50	16.37
		6	2437		16.50	16.40
		10	2457		16.50	16.43
		11	2462		16.00	16.00
		12	2467		14.00	13.78
		13	2472		11.50	11.37
	802.11n20-HT0	1	2412	MCS0	16.50	16.31
		2	2417		16.50	16.38
		6	2437		16.50	16.41
		10	2457		16.50	16.37
		11	2462		16.00	15.60
		12	2467		14.00	13.81
		13	2472		11.50	11.14
	802.11ax20-HEC	1	2412	MCS0	16.50	16.45
		2	2417		16.50	16.48
		6	2437		16.50	16.41
		10	2457		16.50	16.37
		11	2462		16.00	15.82
		12	2467		14.00	13.91
		13	2472		11.50	11.18

Unless otherwise stated the results shown in this test report refer only to the sample(s) tested and such sample(s) are retained for 90 days only.

除非另有說明，此報告結果僅對測試之樣品負責，同時此樣品僅保留90天。本報告未經本公司書面許可，不可部份複製。

This document is issued by the Company subject to its General Conditions of Service printed overleaf, available on request or accessible at www.sgs.com/terms_and_conditions.htm and for electronic format documents, subject to Terms and Conditions for Electronic Documents at www.sgs.com/terms_e-document.htm. Attention is drawn to the limitation of liability, indemnification and jurisdiction issues defined therein. Any holder of this document is advised that information contained hereon reflects the Company's findings at the time of its intervention only and within the limits of Client's instructions, if any. The Company's sole responsibility is to its Client and this document does not exonerate parties to a transaction from exercising all their rights and obligations under the transaction documents. This document cannot be reproduced except in full, without prior written approval of the Company. Any unauthorized alteration, forgery or falsification of the content or appearance of this document is unlawful and offenders may be prosecuted to the fullest extent of the law.

Tx1 antenna						
Band	Mode	Channel	Frequency (MHz)	Data Rate	Max. Rated Avg. Power + Max. Tolerance (dBm)	Average power (dBm)
2450 MHz	802.11n40-HT0	3	2422	MCS0	16.50	16.34
		4	2427		16.50	16.38
		6	2437		16.50	16.35
		8	2447		15.00	14.86
		9	2452		14.25	14.14
		10	2457		12.00	11.75
		11	2462		12.00	11.65
	802.11ax40-HE0	3	2422	MCS0	16.50	16.42
		4	2427		16.50	16.37
		6	2437		16.50	16.35
		8	2447		15.00	14.85
		9	2452		14.25	14.04
		10	2457		12.00	11.68
		11	2462		12.00	11.61

Unless otherwise stated the results shown in this test report refer only to the sample(s) tested and such sample(s) are retained for 90 days only.

除非另有說明，此報告結果僅對測試之樣品負責，同時此樣品僅保留90天。本報告未經本公司書面許可，不可部份複製。

This document is issued by the Company subject to its General Conditions of Service printed overleaf, available on request or accessible at www.sgs.com/terms_and_conditions.htm and for electronic format documents, subject to Terms and Conditions for Electronic Documents at www.sgs.com/terms_e-document.htm. Attention is drawn to the limitation of liability, indemnification and jurisdiction issues defined therein. Any holder of this document is advised that information contained hereon reflects the Company's findings at the time of its intervention only and within the limits of Client's instructions, if any. The Company's sole responsibility is to its Client and this document does not exonerate parties to a transaction from exercising all their rights and obligations under the transaction documents. This document cannot be reproduced except in full, without prior written approval of the Company. Any unauthorized alteration, forgery or falsification of the content or appearance of this document is unlawful and offenders may be prosecuted to the fullest extent of the law.

Tx1 antenna						
Band	Mode	Channel	Frequency (MHz)	Data Rate	Max. Rated Avg. Power + Max. Tolerance (dBm)	Average power (dBm)
5.15-5.25 GHz	802.11a	36	5180	6Mbps	17.50	17.10
		40	5200		17.50	17.46
		44	5220		17.50	17.45
		48	5240		17.50	17.15
	802.11n20-HT0	36	5180	MCS0	17.50	17.46
		40	5200		17.50	17.42
		44	5220		17.50	17.21
		48	5240		17.50	17.47
	802.11ac20-VHT0	36	5180	MCS0	17.50	17.31
		40	5200		17.50	17.41
		44	5220		17.50	17.20
		48	5240		17.50	17.47
	802.11ax20-HE0	36	5180	MCS0	17.50	17.19
		40	5200		17.50	17.32
		44	5220		17.50	17.41
		48	5240		17.50	17.26
	802.11n40-HT0	38	5190	MCS0	17.50	17.46
		46	5230		17.50	17.45
	802.11ac40-VHT0	38	5190	MCS0	17.50	17.37
		46	5230		17.50	17.11
802.11ax40-HE0	38	5190	MCS0	17.50	17.39	
	46	5230		17.50	17.37	
802.11ac80-VHT0	42	5210	MCS0	17.50	17.49	
802.11ax80-HE0	42	5210	MCS0	17.50	17.46	
802.11ac160-VHT0	50	5250	MCS0	15.00	14.85	
802.11ax160-HE0	50	5250	MCS0	15.00	14.90	

Unless otherwise stated the results shown in this test report refer only to the sample(s) tested and such sample(s) are retained for 90 days only.

除非另有說明，此報告結果僅對測試之樣品負責，同時此樣品僅保留90天。本報告未經本公司書面許可，不可部份複製。

This document is issued by the Company subject to its General Conditions of Service printed overleaf, available on request or accessible at www.sgs.com/terms_and_conditions.htm and for electronic format documents, subject to Terms and Conditions for Electronic Documents at www.sgs.com/terms_e-document.htm. Attention is drawn to the limitation of liability, indemnification and jurisdiction issues defined therein. Any holder of this document is advised that information contained hereon reflects the Company's findings at the time of its intervention only and within the limits of Client's instructions, if any. The Company's sole responsibility is to its Client and this document does not exonerate parties to a transaction from exercising all their rights and obligations under the transaction documents. This document cannot be reproduced except in full, without prior written approval of the Company. Any unauthorized alteration, forgery or falsification of the content or appearance of this document is unlawful and offenders may be prosecuted to the fullest extent of the law.

Tx1 antenna						
Band	Mode	Channel	Frequency (MHz)	Data Rate	Max. Rated Avg. Power + Max. Tolerance (dBm)	Average power (dBm)
5.25-5.35 GHz	802.11a	52	5260	6Mbps	17.50	17.48
		56	5280		17.50	17.45
		60	5300		17.50	17.49
		64	5320		17.50	17.46
	802.11n20-HT0	52	5260	MCS0	17.50	17.26
		56	5280		17.50	17.38
		60	5300		17.50	17.16
		64	5320		17.50	17.32
	802.11ac20-VHT0	52	5260	MCS0	17.50	17.26
		56	5280		17.50	17.41
		60	5300		17.50	17.13
		64	5320		17.50	17.20
	802.11ax20-HE0	52	5260	MCS0	17.50	17.24
		56	5280		17.50	17.42
		60	5300		17.50	17.43
		64	5320		17.50	17.46
	802.11n40-HT0	54	5270	MCS0	17.50	17.41
		62	5310		17.50	17.39
	802.11ac40-VHT0	54	5270	MCS0	17.50	17.12
		62	5310		17.50	17.20
802.11ax40-HE0	54	5270	MCS0	17.50	17.48	
	62	5310		17.50	17.17	
802.11ac80-VHT0	58	5290	MCS0	17.50	17.48	
802.11ax80-HE0	58	5290	MCS0	17.50	17.23	

Unless otherwise stated the results shown in this test report refer only to the sample(s) tested and such sample(s) are retained for 90 days only.

除非另有說明，此報告結果僅對測試之樣品負責，同時此樣品僅保留90天。本報告未經本公司書面許可，不可部份複製。

This document is issued by the Company subject to its General Conditions of Service printed overleaf, available on request or accessible at www.sgs.com/terms_and_conditions.htm and for electronic format documents, subject to Terms and Conditions for Electronic Documents at www.sgs.com/terms_e-document.htm. Attention is drawn to the limitation of liability, indemnification and jurisdiction issues defined therein. Any holder of this document is advised that information contained hereon reflects the Company's findings at the time of its intervention only and within the limits of Client's instructions, if any. The Company's sole responsibility is to its Client and this document does not exonerate parties to a transaction from exercising all their rights and obligations under the transaction documents. This document cannot be reproduced except in full, without prior written approval of the Company. Any unauthorized alteration, forgery or falsification of the content or appearance of this document is unlawful and offenders may be prosecuted to the fullest extent of the law.

Tx1 antenna						
Band	Mode	Channel	Frequency (MHz)	Data Rate	Max. Rated Avg. Power + Max. Tolerance (dBm)	Average power (dBm)
5600 MHz	802.11a	100	5500	6Mbps	17.50	17.28
		104	5520		17.50	17.40
		116	5580		17.50	17.31
		120	5600		17.50	17.35
		136	5680		17.50	17.31
		140	5700		17.50	17.41
		144	5720		17.50	17.35
	802.11n20-HT0	100	5500	MCS0	17.50	17.22
		104	5520		17.50	17.25
		116	5580		17.50	17.22
		120	5600		17.50	17.45
		136	5680		17.50	17.14
		140	5700		17.50	17.43
	802.11ac20-VHT0	100	5500	MCS0	17.50	17.33
		104	5520		17.50	17.30
		116	5580		17.50	17.13
		120	5600		17.50	17.39
		136	5680		17.50	17.18
		140	5700		17.50	17.32
		144	5720		17.50	17.41
	802.11ax20-HE0	100	5500	MCS0	17.50	17.31
		104	5520		17.50	17.14
		116	5580		17.50	17.25
		120	5600		17.50	17.40
		136	5680		17.50	17.20
		140	5700		17.50	17.35
		144	5720		17.50	17.39

Unless otherwise stated the results shown in this test report refer only to the sample(s) tested and such sample(s) are retained for 90 days only.

除非另有說明，此報告結果僅對測試之樣品負責，同時此樣品僅保留90天。本報告未經本公司書面許可，不可部份複製。

This document is issued by the Company subject to its General Conditions of Service printed overleaf, available on request or accessible at www.sgs.com/terms_and_conditions.htm and for electronic format documents, subject to Terms and Conditions for Electronic Documents at www.sgs.com/terms_e-document.htm. Attention is drawn to the limitation of liability, indemnification and jurisdiction issues defined therein. Any holder of this document is advised that information contained hereon reflects the Company's findings at the time of its intervention only and within the limits of Client's instructions, if any. The Company's sole responsibility is to its Client and this document does not exonerate parties to a transaction from exercising all their rights and obligations under the transaction documents. This document cannot be reproduced except in full, without prior written approval of the Company. Any unauthorized alteration, forgery or falsification of the content or appearance of this document is unlawful and offenders may be prosecuted to the fullest extent of the law.

Tx1 antenna						
Band	Mode	Channel	Frequency (MHz)	Data Rate	Max. Rated Avg. Power + Max. Tolerance (dBm)	Average power (dBm)
5600 MHz	802.11n40-HT0	102	5510	MCS0	17.50	17.32
		110	5550		17.50	17.47
		118	5590		17.50	17.40
		134	5670		17.50	17.46
		142	5710		17.50	17.12
	802.11ac40-VHT0	102	5510	MCS0	17.50	17.49
		110	5550		17.50	17.45
		118	5590		17.50	17.45
		134	5670		17.50	17.15
		142	5710		17.50	17.33
	802.11ax40-HE0	102	5510	MCS0	17.50	17.45
		110	5550		17.50	17.24
		118	5590		17.50	17.13
		134	5670		17.50	17.30
		142	5710		17.50	17.20
	802.11ac80-VHT0	106	5530	MCS0	17.50	17.49
		122	5610		17.50	17.47
		138	5690		17.50	17.42
	802.11ax80-HE0	106	5530	MCS0	17.50	17.38
		122	5610		17.50	17.32
138		5690	17.50		17.34	
802.11ac160-VHT0	114	5570	MCS0	15.00	14.99	
802.11ax160-HE0	114	5570	MCS0	15.00	14.32	

Unless otherwise stated the results shown in this test report refer only to the sample(s) tested and such sample(s) are retained for 90 days only.

除非另有說明，此報告結果僅對測試之樣品負責，同時此樣品僅保留90天。本報告未經本公司書面許可，不可部份複製。

This document is issued by the Company subject to its General Conditions of Service printed overleaf, available on request or accessible at www.sgs.com/terms_and_conditions.htm and for electronic format documents, subject to Terms and Conditions for Electronic Documents at www.sgs.com/terms_e-document.htm. Attention is drawn to the limitation of liability, indemnification and jurisdiction issues defined therein. Any holder of this document is advised that information contained hereon reflects the Company's findings at the time of its intervention only and within the limits of Client's instructions, if any. The Company's sole responsibility is to its Client and this document does not exonerate parties to a transaction from exercising all their rights and obligations under the transaction documents. This document cannot be reproduced except in full, without prior written approval of the Company. Any unauthorized alteration, forgery or falsification of the content or appearance of this document is unlawful and offenders may be prosecuted to the fullest extent of the law.

Tx1 antenna						
Mode	Mode	Channel	Frequency (MHz)	Data Rate	Max. Rated Avg. Power + Max. Tolerance (dBm)	Average power (dBm)
5800 MHz	802.11a	149	5745	6Mbps	16.50	16.44
		157	5785		16.50	16.39
		165	5825		16.50	16.41
	802.11n20-HT0	149	5745	MCS0	16.50	16.38
		157	5785		16.50	16.33
		165	5825		16.50	16.35
	802.11ac20-VHT0	149	5745	MCS0	16.50	16.48
		157	5785		16.50	16.42
		165	5825		16.50	16.45
	802.11ax20-HE0	149	5745	MCS0	16.50	16.37
		157	5785		16.50	16.40
		165	5825		16.50	16.42
	802.11n40-HT0	151	5755	MCS0	16.50	16.44
		159	5795		16.50	16.48
	802.11ac40-VHT0	151	5755	MCS0	16.50	16.39
		159	5795		16.50	16.33
	802.11ax40-HE0	151	5755	MCS0	16.50	16.36
		159	5795		16.50	16.31
802.11ac80-VHT0	155	5775	MCS0	16.50	16.49	
802.11ax80-HE0	155	5775	MCS0	16.50	16.29	

Unless otherwise stated the results shown in this test report refer only to the sample(s) tested and such sample(s) are retained for 90 days only.

除非另有說明，此報告結果僅對測試之樣品負責，同時此樣品僅保留90天。本報告未經本公司書面許可，不可部份複製。

This document is issued by the Company subject to its General Conditions of Service printed overleaf, available on request or accessible at www.sgs.com/terms_and_conditions.htm and for electronic format documents, subject to Terms and Conditions for Electronic Documents at www.sgs.com/terms_e-document.htm. Attention is drawn to the limitation of liability, indemnification and jurisdiction issues defined therein. Any holder of this document is advised that information contained hereon reflects the Company's findings at the time of its intervention only and within the limits of Client's instructions, if any. The Company's sole responsibility is to its Client and this document does not exonerate parties to a transaction from exercising all their rights and obligations under the transaction documents. This document cannot be reproduced except in full, without prior written approval of the Company. Any unauthorized alteration, forgery or falsification of the content or appearance of this document is unlawful and offenders may be prosecuted to the fullest extent of the law.

Tx2 antenna						
Band	Mode	Channel	Frequency (MHz)	Data Rate	Max. Rated Avg. Power + Max. Tolerance (dBm)	Average power (dBm)
2450 MHz	802.11b	1	2412	1Mbps	19.00	18.97
		2	2417		19.00	18.81
		6	2437		19.00	18.91
		10	2457		19.00	18.99
		11	2462		18.75	18.65
		12	2467		17.00	16.95
		13	2472		15.75	15.67
	802.11g	1	2412	6Mbps	17.50	17.43
		2	2417		19.00	18.91
		6	2437		19.00	18.97
		10	2457		19.00	18.96
		11	2462		16.00	15.94
		12	2467		14.00	13.74
		13	2472		11.25	11.11
	802.11n20-HT0	1	2412	MCS0	17.50	17.39
		2	2417		19.00	18.96
		6	2437		19.00	18.83
		10	2457		19.00	18.65
		11	2462		16.00	15.65
		12	2467		14.00	13.62
		13	2472		11.25	11.17
	802.11ax20-HE0	1	2412	MCS0	17.50	17.33
		2	2417		19.00	18.68
		6	2437		19.00	18.76
		10	2457		19.00	18.71
		11	2462		16.00	15.97
		12	2467		14.00	13.70
		13	2472		11.25	11.12

Unless otherwise stated the results shown in this test report refer only to the sample(s) tested and such sample(s) are retained for 90 days only.

除非另有說明，此報告結果僅對測試之樣品負責，同時此樣品僅保留90天。本報告未經本公司書面許可，不可部份複製。

This document is issued by the Company subject to its General Conditions of Service printed overleaf, available on request or accessible at www.sgs.com/terms_and_conditions.htm and for electronic format documents, subject to Terms and Conditions for Electronic Documents at www.sgs.com/terms_e-document.htm. Attention is drawn to the limitation of liability, indemnification and jurisdiction issues defined therein. Any holder of this document is advised that information contained hereon reflects the Company's findings at the time of its intervention only and within the limits of Client's instructions, if any. The Company's sole responsibility is to its Client and this document does not exonerate parties to a transaction from exercising all their rights and obligations under the transaction documents. This document cannot be reproduced except in full, without prior written approval of the Company. Any unauthorized alteration, forgery or falsification of the content or appearance of this document is unlawful and offenders may be prosecuted to the fullest extent of the law.

Tx2 antenna						
Band	Mode	Channel	Frequency (MHz)	Data Rate	Max. Rated Avg. Power + Max. Tolerance (dBm)	Average power (dBm)
2450 MHz	802.11n40-HT0	3	2422	MCS0	17.50	17.45
		4	2427		18.00	17.63
		6	2437		18.00	17.67
		8	2447		15.00	14.62
		9	2452		14.25	13.94
		10	2457		12.00	11.64
		11	2462		11.50	11.37
	802.11ax40-HE0	3	2422	MCS0	17.50	17.25
		4	2427		18.00	17.69
		6	2437		18.00	18.00
		8	2447		15.00	14.67
		9	2452		14.25	13.90
		10	2457		12.00	11.81
		11	2462		11.50	11.38

Unless otherwise stated the results shown in this test report refer only to the sample(s) tested and such sample(s) are retained for 90 days only.

除非另有說明，此報告結果僅對測試之樣品負責，同時此樣品僅保留90天。本報告未經本公司書面許可，不可部份複製。

This document is issued by the Company subject to its General Conditions of Service printed overleaf, available on request or accessible at www.sgs.com/terms_and_conditions.htm and for electronic format documents, subject to Terms and Conditions for Electronic Documents at www.sgs.com/terms_e-document.htm. Attention is drawn to the limitation of liability, indemnification and jurisdiction issues defined therein. Any holder of this document is advised that information contained hereon reflects the Company's findings at the time of its intervention only and within the limits of Client's instructions, if any. The Company's sole responsibility is to its Client and this document does not exonerate parties to a transaction from exercising all their rights and obligations under the transaction documents. This document cannot be reproduced except in full, without prior written approval of the Company. Any unauthorized alteration, forgery or falsification of the content or appearance of this document is unlawful and offenders may be prosecuted to the fullest extent of the law.

Tx2 antenna						
Band	Mode	Channel	Frequency (MHz)	Data Rate	Max. Rated Avg. Power + Max. Tolerance (dBm)	Average power (dBm)
5.15-5.25 GHz	802.11a	36	5180	6Mbps	19.00	18.79
		40	5200		19.00	18.95
		44	5220		19.00	18.93
		48	5240		19.00	18.99
	802.11n20-HT0	36	5180	MCS0	19.00	18.72
		40	5200		19.00	18.83
		44	5220		19.00	18.71
		48	5240		19.00	18.67
	802.11ac20-VHT0	36	5180	MCS0	19.00	18.76
		40	5200		19.00	18.82
		44	5220		19.00	18.72
		48	5240		19.00	18.94
	802.11ax20-HE0	36	5180	MCS0	19.00	18.68
		40	5200		19.00	18.78
		44	5220		19.00	18.61
		48	5240		19.00	18.80
	802.11n40-HT0	38	5190	MCS0	19.00	18.73
		46	5230		19.00	18.93
	802.11ac40-VHT0	38	5190	MCS0	19.00	18.69
		46	5230		19.00	18.82
802.11ax40-HE0	38	5190	MCS0	19.00	18.73	
	46	5230		19.00	18.89	
802.11ac80-VHT0	42	5210	MCS0	19.00	18.62	
802.11ax80-HE0	42	5210	MCS0	19.00	18.90	
802.11ac160-VHT0	50	5250	MCS0	15.25	15.22	
802.11ax160-HE0	50	5250	MCS0	15.25	14.96	

Unless otherwise stated the results shown in this test report refer only to the sample(s) tested and such sample(s) are retained for 90 days only.

除非另有說明，此報告結果僅對測試之樣品負責，同時此樣品僅保留90天。本報告未經本公司書面許可，不可部份複製。

This document is issued by the Company subject to its General Conditions of Service printed overleaf, available on request or accessible at www.sgs.com/terms_and_conditions.htm and for electronic format documents, subject to Terms and Conditions for Electronic Documents at www.sgs.com/terms_e-document.htm. Attention is drawn to the limitation of liability, indemnification and jurisdiction issues defined therein. Any holder of this document is advised that information contained hereon reflects the Company's findings at the time of its intervention only and within the limits of Client's instructions, if any. The Company's sole responsibility is to its Client and this document does not exonerate parties to a transaction from exercising all their rights and obligations under the transaction documents. This document cannot be reproduced except in full, without prior written approval of the Company. Any unauthorized alteration, forgery or falsification of the content or appearance of this document is unlawful and offenders may be prosecuted to the fullest extent of the law.

Tx2 antenna						
Band	Mode	Channel	Frequency (MHz)	Data Rate	Max. Rated Avg. Power + Max. Tolerance (dBm)	Average power (dBm)
5.25-5.35 GHz	802.11a	52	5260	6Mbps	19.00	18.96
		56	5280		19.00	18.99
		60	5300		19.00	18.94
		64	5320		19.00	18.81
	802.11n20-HT0	52	5260	MCS0	19.00	18.82
		56	5280		19.00	18.73
		60	5300		19.00	18.65
		64	5320		19.00	18.82
	802.11ac20-VHT0	52	5260	MCS0	19.00	18.78
		56	5280		19.00	18.77
		60	5300		19.00	18.69
		64	5320		19.00	18.68
	802.11ax20-HE0	52	5260	MCS0	19.00	18.72
		56	5280		19.00	18.88
		60	5300		19.00	18.87
		64	5320		19.00	18.83
	802.11n40-HT0	54	5270	MCS0	19.00	18.92
		62	5310		18.00	17.73
	802.11ac40-VHT0	54	5270	MCS0	19.00	18.68
		62	5310		18.00	17.68
802.11ax40-HE0	54	5270	MCS0	19.00	18.80	
	62	5310		18.00	17.81	
802.11ac80-VHT0	58	5290	MCS0	18.00	17.85	
802.11ax80-HE0	58	5290	MCS0	18.00	17.81	

Unless otherwise stated the results shown in this test report refer only to the sample(s) tested and such sample(s) are retained for 90 days only.

除非另有說明，此報告結果僅對測試之樣品負責，同時此樣品僅保留90天。本報告未經本公司書面許可，不可部份複製。

This document is issued by the Company subject to its General Conditions of Service printed overleaf, available on request or accessible at www.sgs.com/terms_and_conditions.htm and for electronic format documents, subject to Terms and Conditions for Electronic Documents at www.sgs.com/terms_e-document.htm. Attention is drawn to the limitation of liability, indemnification and jurisdiction issues defined therein. Any holder of this document is advised that information contained hereon reflects the Company's findings at the time of its intervention only and within the limits of Client's instructions, if any. The Company's sole responsibility is to its Client and this document does not exonerate parties to a transaction from exercising all their rights and obligations under the transaction documents. This document cannot be reproduced except in full, without prior written approval of the Company. Any unauthorized alteration, forgery or falsification of the content or appearance of this document is unlawful and offenders may be prosecuted to the fullest extent of the law.

Tx2 antenna						
Band	Mode	Channel	Frequency (MHz)	Data Rate	Max. Rated Avg. Power + Max. Tolerance (dBm)	Average power (dBm)
5600 MHz	802.11a	100	5500	6Mbps	19.00	18.62
		104	5520		19.00	18.80
		116	5580		19.00	18.68
		120	5600		19.00	18.80
		136	5680		19.00	18.98
		140	5700		19.00	18.83
		144	5720		19.00	18.73
	802.11n20-HT0	100	5500	MCS0	19.00	18.83
		104	5520		19.00	18.62
		116	5580		19.00	18.91
		120	5600		19.00	18.79
		136	5680		19.00	18.99
		140	5700		19.00	18.93
	802.11ac20-VHT0	100	5500	MCS0	19.00	18.78
		104	5520		19.00	18.61
		116	5580		19.00	18.98
		120	5600		19.00	18.85
		136	5680		19.00	18.80
		140	5700		19.00	18.40
		144	5720		19.00	18.69
	802.11ax20-HE0	100	5500	MCS0	19.00	18.69
		104	5520		19.00	18.76
		116	5580		19.00	18.73
		120	5600		19.00	18.82
		136	5680		19.00	18.99
		140	5700		19.00	18.93
		144	5720		19.00	18.83

Unless otherwise stated the results shown in this test report refer only to the sample(s) tested and such sample(s) are retained for 90 days only.

除非另有說明，此報告結果僅對測試之樣品負責，同時此樣品僅保留90天。本報告未經本公司書面許可，不可部份複製。

This document is issued by the Company subject to its General Conditions of Service printed overleaf, available on request or accessible at www.sgs.com/terms_and_conditions.htm and for electronic format documents, subject to Terms and Conditions for Electronic Documents at www.sgs.com/terms_e-document.htm. Attention is drawn to the limitation of liability, indemnification and jurisdiction issues defined therein. Any holder of this document is advised that information contained hereon reflects the Company's findings at the time of its intervention only and within the limits of Client's instructions, if any. The Company's sole responsibility is to its Client and this document does not exonerate parties to a transaction from exercising all their rights and obligations under the transaction documents. This document cannot be reproduced except in full, without prior written approval of the Company. Any unauthorized alteration, forgery or falsification of the content or appearance of this document is unlawful and offenders may be prosecuted to the fullest extent of the law.

Tx2 antenna						
Band	Mode	Channel	Frequency (MHz)	Data Rate	Max. Rated Avg. Power + Max. Tolerance (dBm)	Average power (dBm)
5600 MHz	802.11n40-HT0	102	5510	MCS0	19.00	18.88
		110	5550		19.00	18.95
		118	5590		19.00	18.92
		134	5670		19.00	18.89
		142	5710		19.00	18.96
	802.11ac40-VHT0	102	5510	MCS0	19.00	18.88
		110	5550		19.00	18.91
		118	5590		19.00	18.76
		134	5670		19.00	18.85
		142	5710		19.00	18.89
	802.11ax40-HE0	102	5510	MCS0	19.00	18.81
		110	5550		19.00	18.67
		118	5590		19.00	18.87
		134	5670		19.00	18.60
		142	5710		19.00	18.78
	802.11ac80-VHT0	106	5530	MCS0	19.00	18.83
		122	5610		19.00	18.97
		138	5690		19.00	18.99
	802.11ax80-HE0	106	5530	MCS0	19.00	18.49
		122	5610		19.00	18.62
		138	5690		19.00	18.69
802.11ac160-VHT0	114	5570	MCS0	16.00	15.60	
802.11ax160-HE0	114	5570	MCS0	16.00	15.60	

Unless otherwise stated the results shown in this test report refer only to the sample(s) tested and such sample(s) are retained for 90 days only.

除非另有說明，此報告結果僅對測試之樣品負責，同時此樣品僅保留90天。本報告未經本公司書面許可，不可部份複製。

This document is issued by the Company subject to its General Conditions of Service printed overleaf, available on request or accessible at www.sgs.com/terms_and_conditions.htm and for electronic format documents, subject to Terms and Conditions for Electronic Documents at www.sgs.com/terms_e-document.htm. Attention is drawn to the limitation of liability, indemnification and jurisdiction issues defined therein. Any holder of this document is advised that information contained hereon reflects the Company's findings at the time of its intervention only and within the limits of Client's instructions, if any. The Company's sole responsibility is to its Client and this document does not exonerate parties to a transaction from exercising all their rights and obligations under the transaction documents. This document cannot be reproduced except in full, without prior written approval of the Company. Any unauthorized alteration, forgery or falsification of the content or appearance of this document is unlawful and offenders may be prosecuted to the fullest extent of the law.

Tx2 antenna						
Mode	Mode	Channel	Frequency (MHz)	Data Rate	Max. Rated Avg. Power + Max. Tolerance (dBm)	Average power (dBm)
5800 MHz	802.11a	149	5745	6Mbps	19.00	18.99
		157	5785		19.00	18.95
		165	5825		19.00	18.97
	802.11n20-HT0	149	5745	MCS0	19.00	18.94
		157	5785		19.00	18.97
		165	5825		19.00	18.87
	802.11ac20-VHT0	149	5745	MCS0	19.00	18.88
		157	5785		19.00	18.95
		165	5825		19.00	18.60
	802.11ax20-HE0	149	5745	MCS0	19.00	18.78
		157	5785		19.00	18.85
		165	5825		19.00	18.70
	802.11n40-HT0	151	5755	MCS0	19.00	18.94
		159	5795		19.00	18.91
	802.11ac40-VHT0	151	5755	MCS0	19.00	18.86
		159	5795		19.00	18.78
	802.11ax40-HE0	151	5755	MCS0	19.00	18.90
		159	5795		19.00	18.99
	802.11ac80-VHT0	155	5775	MCS0	19.00	18.90
	802.11ax80-HE0	155	5775	MCS0	19.00	18.94

Unless otherwise stated the results shown in this test report refer only to the sample(s) tested and such sample(s) are retained for 90 days only.

除非另有說明，此報告結果僅對測試之樣品負責，同時此樣品僅保留90天。本報告未經本公司書面許可，不可部份複製。

This document is issued by the Company subject to its General Conditions of Service printed overleaf, available on request or accessible at www.sgs.com/terms_and_conditions.htm and for electronic format documents, subject to Terms and Conditions for Electronic Documents at www.sgs.com/terms_e-document.htm. Attention is drawn to the limitation of liability, indemnification and jurisdiction issues defined therein. Any holder of this document is advised that information contained hereon reflects the Company's findings at the time of its intervention only and within the limits of Client's instructions, if any. The Company's sole responsibility is to its Client and this document does not exonerate parties to a transaction from exercising all their rights and obligations under the transaction documents. This document cannot be reproduced except in full, without prior written approval of the Company. Any unauthorized alteration, forgery or falsification of the content or appearance of this document is unlawful and offenders may be prosecuted to the fullest extent of the law.

WLAN MIMO Full power

Tx1 antenna						
Band	Mode	Channel	Frequency (MHz)	Data Rate	Max. Rated Avg. Power + Max. Tolerance (dBm)	Average power (dBm)
2450 MHz	802.11n20-HT0	1	2412	MCS0	16.50	16.35
		2	2417		16.50	16.40
		6	2437		16.50	16.50
		10	2457		16.50	16.43
		11	2462		15.00	14.96
		12	2467		13.50	13.47
		13	2472		8.25	8.11
	802.11ax20-HE0	1	2412	MCS0	16.50	16.39
		2	2417		16.50	16.39
		6	2437		16.50	16.44
		10	2457		16.50	16.31
		11	2462		15.00	14.86
		12	2467		13.50	13.44
		13	2472		8.25	8.16
	802.11n40-HT0	3	2422	MCS0	16.50	16.42
		4	2427		15.00	14.85
		6	2437		16.50	16.41
		8	2447		14.00	13.87
		9	2452		13.75	13.72
		10	2457		11.00	10.95
		11	2462		9.00	8.83
	802.11ax40-HE0	3	2422	MCS0	16.50	16.39
		4	2427		15.00	14.95
		6	2437		16.50	16.40
		8	2447		14.00	14.00
		9	2452		13.75	13.75
		10	2457		11.00	10.80
		11	2462		9.00	8.84

Unless otherwise stated the results shown in this test report refer only to the sample(s) tested and such sample(s) are retained for 90 days only.

除非另有說明，此報告結果僅對測試之樣品負責，同時此樣品僅保留90天。本報告未經本公司書面許可，不可部份複製。

This document is issued by the Company subject to its General Conditions of Service printed overleaf, available on request or accessible at www.sgs.com/terms_and_conditions.htm and for electronic format documents, subject to Terms and Conditions for Electronic Documents at www.sgs.com/terms_e-document.htm. Attention is drawn to the limitation of liability, indemnification and jurisdiction issues defined therein. Any holder of this document is advised that information contained hereon reflects the Company's findings at the time of its intervention only and within the limits of Client's instructions, if any. The Company's sole responsibility is to its Client and this document does not exonerate parties to a transaction from exercising all their rights and obligations under the transaction documents. This document cannot be reproduced except in full, without prior written approval of the Company. Any unauthorized alteration, forgery or falsification of the content or appearance of this document is unlawful and offenders may be prosecuted to the fullest extent of the law.

Tx1 antenna						
Band	Mode	Channel	Frequency (MHz)	Data Rate	Max. Rated Avg. Power + Max. Tolerance (dBm)	Average power (dBm)
5.15-5.25 GHz	802.11n20-HT0	36	5180	MCS0	15.50	15.13
		40	5200		15.50	15.32
		44	5220		15.50	15.02
		48	5240		15.50	15.11
	802.11ac20-VHT0	36	5180	MCS0	15.50	15.01
		40	5200		15.50	15.44
		44	5220		15.00	14.94
		48	5240		15.50	15.08
	802.11ax20-HE0	36	5180	MCS0	15.00	14.88
		40	5200		15.00	14.80
		44	5220		15.00	14.81
		48	5240		15.00	14.91
	802.11n40-HT0	38	5190	MCS0	17.00	16.71
		46	5230		17.50	17.12
	802.11ac40-VHT0	38	5190	MCS0	17.00	16.66
		46	5230		17.50	17.24
802.11ax40-HE0	38	5190	MCS0	17.00	16.79	
	46	5230		17.50	17.22	
802.11ac80-VHT0	42	5210	MCS0	17.00	16.78	
802.11ax80-HE0	42	5210	MCS0	17.00	16.85	
802.11ac160-VHT0	50	5250	MCS0	13.50	13.29	
802.11ax160-HE0	50	5250	MCS0	13.50	13.18	

Unless otherwise stated the results shown in this test report refer only to the sample(s) tested and such sample(s) are retained for 90 days only.

除非另有說明，此報告結果僅對測試之樣品負責，同時此樣品僅保留90天。本報告未經本公司書面許可，不可部份複製。

This document is issued by the Company subject to its General Conditions of Service printed overleaf, available on request or accessible at www.sgs.com/terms_and_conditions.htm and for electronic format documents, subject to Terms and Conditions for Electronic Documents at www.sgs.com/terms_e-document.htm. Attention is drawn to the limitation of liability, indemnification and jurisdiction issues defined therein. Any holder of this document is advised that information contained hereon reflects the Company's findings at the time of its intervention only and within the limits of Client's instructions, if any. The Company's sole responsibility is to its Client and this document does not exonerate parties to a transaction from exercising all their rights and obligations under the transaction documents. This document cannot be reproduced except in full, without prior written approval of the Company. Any unauthorized alteration, forgery or falsification of the content or appearance of this document is unlawful and offenders may be prosecuted to the fullest extent of the law.

Tx1 antenna						
Band	Mode	Channel	Frequency (MHz)	Data Rate	Max. Rated Avg. Power + Max. Tolerance (dBm)	Average power (dBm)
5.25-5.35 GHz	802.11n20-HT0	52	5260	MCS0	17.50	17.34
		56	5280		17.50	17.34
		60	5300		17.50	17.14
		64	5320		17.50	17.10
	802.11ac20-VHT0	52	5260	MCS0	17.50	17.32
		56	5280		17.50	17.14
		60	5300		17.50	17.23
		64	5320		17.50	17.39
	802.11ax20-HE0	52	5260	MCS0	17.50	17.17
		56	5280		17.50	17.17
		60	5300		17.50	17.31
		64	5320		17.50	17.16
	802.11n40-HT0	54	5270	MCS0	17.50	17.29
		62	5310		16.50	16.18
	802.11ac40-VHT0	54	5270	MCS0	17.50	17.26
		62	5310		16.50	16.26
	802.11ax40-HE0	54	5270	MCS0	17.50	17.22
		62	5310		16.50	16.40
	802.11ac80-VHT0	58	5290	MCS0	16.25	15.98
	802.11ax80-HE0	58	5290	MCS0	16.25	15.91

Unless otherwise stated the results shown in this test report refer only to the sample(s) tested and such sample(s) are retained for 90 days only.

除非另有說明，此報告結果僅對測試之樣品負責，同時此樣品僅保留90天。本報告未經本公司書面許可，不可部份複製。

This document is issued by the Company subject to its General Conditions of Service printed overleaf, available on request or accessible at www.sgs.com/terms_and_conditions.htm and for electronic format documents, subject to Terms and Conditions for Electronic Documents at www.sgs.com/terms_e-document.htm. Attention is drawn to the limitation of liability, indemnification and jurisdiction issues defined therein. Any holder of this document is advised that information contained hereon reflects the Company's findings at the time of its intervention only and within the limits of Client's instructions, if any. The Company's sole responsibility is to its Client and this document does not exonerate parties to a transaction from exercising all their rights and obligations under the transaction documents. This document cannot be reproduced except in full, without prior written approval of the Company. Any unauthorized alteration, forgery or falsification of the content or appearance of this document is unlawful and offenders may be prosecuted to the fullest extent of the law.

Tx1 antenna						
Band	Mode	Channel	Frequency (MHz)	Data Rate	Max. Rated Avg. Power + Max. Tolerance (dBm)	Average power (dBm)
5600 MHz	802.11n20-HT0	100	5500	MCS0	17.50	17.36
		104	5520		17.50	17.30
		116	5580		17.50	17.21
		120	5600		17.50	17.20
		136	5680		17.50	17.37
		140	5700		17.50	17.27
		144	5720		17.50	17.12
	802.11ac20-VHT0	100	5500	MCS0	17.50	17.25
		104	5520		17.50	17.26
		116	5580		17.50	17.39
		120	5600		17.50	17.13
		136	5680		17.50	17.27
		140	5700		17.50	17.29
	802.11ax20-HE0	100	5500	MCS0	17.50	17.29
		104	5520		17.50	17.19
		116	5580		17.50	17.33
		120	5600		17.50	17.26
		136	5680		17.50	17.11
		140	5700		17.50	17.30
		144	5720		17.50	17.22

Unless otherwise stated the results shown in this test report refer only to the sample(s) tested and such sample(s) are retained for 90 days only.

除非另有說明，此報告結果僅對測試之樣品負責，同時此樣品僅保留90天。本報告未經本公司書面許可，不可部份複製。

This document is issued by the Company subject to its General Conditions of Service printed overleaf, available on request or accessible at www.sgs.com/terms_and_conditions.htm and for electronic format documents, subject to Terms and Conditions for Electronic Documents at www.sgs.com/terms_e-document.htm. Attention is drawn to the limitation of liability, indemnification and jurisdiction issues defined therein. Any holder of this document is advised that information contained hereon reflects the Company's findings at the time of its intervention only and within the limits of Client's instructions, if any. The Company's sole responsibility is to its Client and this document does not exonerate parties to a transaction from exercising all their rights and obligations under the transaction documents. This document cannot be reproduced except in full, without prior written approval of the Company. Any unauthorized alteration, forgery or falsification of the content or appearance of this document is unlawful and offenders may be prosecuted to the fullest extent of the law.

Tx1 antenna						
Band	Mode	Channel	Frequency (MHz)	Data Rate	Max. Rated Avg. Power + Max. Tolerance (dBm)	Average power (dBm)
5600 MHz	802.11n40-HT0	102	5510	MCS0	17.50	17.23
		110	5550		17.50	17.33
		118	5590		17.50	17.34
		134	5670		17.50	17.20
		142	5710		17.50	17.36
	802.11ac40-VHT0	102	5510	MCS0	17.50	17.23
		110	5550		17.50	17.32
		118	5590		17.50	17.15
		134	5670		17.50	17.27
		142	5710		17.50	17.21
	802.11ax40-HE0	102	5510	MCS0	17.50	17.31
		110	5550		17.50	17.24
		118	5590		17.50	17.12
		134	5670		17.50	17.33
		142	5710		17.50	17.30
	802.11ac80-VHT0	106	5530	MCS0	17.50	17.14
		122	5610		17.50	17.26
		138	5690		17.50	17.14
	802.11ax80-HE0	106	5530	MCS0	17.50	17.35
		122	5610		17.50	17.23
		138	5690		17.50	17.29
	802.11ac160-VHT0	114	5570	MCS0	13.50	13.33
	802.11ax160-HE0	114	5570	MCS0	13.50	13.24

Unless otherwise stated the results shown in this test report refer only to the sample(s) tested and such sample(s) are retained for 90 days only.

除非另有說明，此報告結果僅對測試之樣品負責，同時此樣品僅保留90天。本報告未經本公司書面許可，不可部份複製。

This document is issued by the Company subject to its General Conditions of Service printed overleaf, available on request or accessible at www.sgs.com/terms_and_conditions.htm and for electronic format documents, subject to Terms and Conditions for Electronic Documents at www.sgs.com/terms_e-document.htm. Attention is drawn to the limitation of liability, indemnification and jurisdiction issues defined therein. Any holder of this document is advised that information contained hereon reflects the Company's findings at the time of its intervention only and within the limits of Client's instructions, if any. The Company's sole responsibility is to its Client and this document does not exonerate parties to a transaction from exercising all their rights and obligations under the transaction documents. This document cannot be reproduced except in full, without prior written approval of the Company. Any unauthorized alteration, forgery or falsification of the content or appearance of this document is unlawful and offenders may be prosecuted to the fullest extent of the law.

Tx1 antenna						
Mode	Mode	Channel	Frequency (MHz)	Data Rate	Max. Rated Avg. Power + Max. Tolerance (dBm)	Average power (dBm)
5800 MHz	802.11n20-HT0	149	5745	MCS0	16.50	16.46
		157	5785		16.50	16.33
		165	5825		16.50	16.39
	802.11ac20-VHT0	149	5745	MCS0	16.50	16.49
		157	5785		16.50	16.41
		165	5825		16.50	16.42
	802.11ax20-HE0	149	5745	MCS0	16.50	16.39
		157	5785		16.50	16.45
		165	5825		16.50	16.33
	802.11n40-HT0	151	5755	MCS0	16.50	16.36
		159	5795		16.50	16.32
	802.11ac40-VHT0	151	5755	MCS0	16.50	16.32
		159	5795		16.50	16.36
	802.11ax40-HE0	151	5755	MCS0	16.50	16.44
		159	5795		16.50	16.36
802.11ac80-VHT0	155	5775	MCS0	16.50	16.38	
802.11ax80-HE0	155	5775	MCS0	16.50	16.41	

Unless otherwise stated the results shown in this test report refer only to the sample(s) tested and such sample(s) are retained for 90 days only.

除非另有說明，此報告結果僅對測試之樣品負責，同時此樣品僅保留90天。本報告未經本公司書面許可，不可部份複製。

This document is issued by the Company subject to its General Conditions of Service printed overleaf, available on request or accessible at www.sgs.com/terms_and_conditions.htm and for electronic format documents, subject to Terms and Conditions for Electronic Documents at www.sgs.com/terms_e-document.htm. Attention is drawn to the limitation of liability, indemnification and jurisdiction issues defined therein. Any holder of this document is advised that information contained hereon reflects the Company's findings at the time of its intervention only and within the limits of Client's instructions, if any. The Company's sole responsibility is to its Client and this document does not exonerate parties to a transaction from exercising all their rights and obligations under the transaction documents. This document cannot be reproduced except in full, without prior written approval of the Company. Any unauthorized alteration, forgery or falsification of the content or appearance of this document is unlawful and offenders may be prosecuted to the fullest extent of the law.

Tx2 antenna						
Band	Mode	Channel	Frequency (MHz)	Data Rate	Max. Rated Avg. Power + Max. Tolerance (dBm)	Average power (dBm)
2450 MHz	802.11n20-HT0	1	2412	MCS0	16.75	16.74
		2	2417		18.00	17.81
		6	2437		18.00	17.99
		10	2457		18.00	17.98
		11	2462		15.00	14.98
		12	2467		13.50	13.47
		13	2472		8.25	8.10
	802.11ax20-HEC0	1	2412	MCS0	16.75	16.57
		2	2417		18.00	17.99
		6	2437		18.00	17.91
		10	2457		18.00	17.91
		11	2462		15.00	14.88
		12	2467		13.50	13.32
		13	2472		8.25	8.05
	802.11n40-HT0	3	2422	MCS0	16.75	16.60
		4	2427		15.00	14.94
		6	2437		17.00	16.85
		8	2447		14.00	13.85
		9	2452		13.75	13.66
		10	2457		11.00	10.97
		11	2462		9.00	8.95
	802.11ax40-HEC0	3	2422	MCS0	16.75	16.74
		4	2427		15.00	14.92
		6	2437		17.00	16.81
		8	2447		14.00	13.90
		9	2452		13.75	13.59
		10	2457		11.00	10.90
		11	2462		9.00	8.91

Unless otherwise stated the results shown in this test report refer only to the sample(s) tested and such sample(s) are retained for 90 days only.

除非另有說明，此報告結果僅對測試之樣品負責，同時此樣品僅保留90天。本報告未經本公司書面許可，不可部份複製。

This document is issued by the Company subject to its General Conditions of Service printed overleaf, available on request or accessible at www.sgs.com/terms_and_conditions.htm and for electronic format documents, subject to Terms and Conditions for Electronic Documents at www.sgs.com/terms_e-document.htm. Attention is drawn to the limitation of liability, indemnification and jurisdiction issues defined therein. Any holder of this document is advised that information contained hereon reflects the Company's findings at the time of its intervention only and within the limits of Client's instructions, if any. The Company's sole responsibility is to its Client and this document does not exonerate parties to a transaction from exercising all their rights and obligations under the transaction documents. This document cannot be reproduced except in full, without prior written approval of the Company. Any unauthorized alteration, forgery or falsification of the content or appearance of this document is unlawful and offenders may be prosecuted to the fullest extent of the law.

Tx2 antenna						
Band	Mode	Channel	Frequency (MHz)	Data Rate	Max. Rated Avg. Power + Max. Tolerance (dBm)	Average power (dBm)
5.15-5.25 GHz	802.11n20-HT0	36	5180	MCS0	15.50	15.42
		40	5200		15.50	15.42
		44	5220		15.50	15.47
		48	5240		15.50	15.50
	802.11ac20-VHT0	36	5180	MCS0	15.50	15.47
		40	5200		15.50	15.44
		44	5220		15.50	15.43
		48	5240		15.50	15.44
	802.11ax20-HE0	36	5180	MCS0	15.50	15.29
		40	5200		15.50	15.46
		44	5220		15.50	15.28
		48	5240		15.50	15.35
	802.11n40-HT0	38	5190	MCS0	17.00	16.83
		46	5230		19.00	18.63
	802.11ac40-VHT0	38	5190	MCS0	17.00	16.77
		46	5230		19.00	18.85
802.11ax40-HE0	38	5190	MCS0	17.00	16.80	
	46	5230		19.00	18.63	
802.11ac80-VHT0	42	5210	MCS0	17.00	16.70	
802.11ax80-HE0	42	5210	MCS0	17.00	16.63	
802.11ac160-VHT0	50	5250	MCS0	13.50	13.18	
802.11ax160-HE0	50	5250	MCS0	13.50	13.20	

Unless otherwise stated the results shown in this test report refer only to the sample(s) tested and such sample(s) are retained for 90 days only.

除非另有說明，此報告結果僅對測試之樣品負責，同時此樣品僅保留90天。本報告未經本公司書面許可，不可部份複製。

This document is issued by the Company subject to its General Conditions of Service printed overleaf, available on request or accessible at www.sgs.com/terms_and_conditions.htm and for electronic format documents, subject to Terms and Conditions for Electronic Documents at www.sgs.com/terms_e-document.htm. Attention is drawn to the limitation of liability, indemnification and jurisdiction issues defined therein. Any holder of this document is advised that information contained hereon reflects the Company's findings at the time of its intervention only and within the limits of Client's instructions, if any. The Company's sole responsibility is to its Client and this document does not exonerate parties to a transaction from exercising all their rights and obligations under the transaction documents. This document cannot be reproduced except in full, without prior written approval of the Company. Any unauthorized alteration, forgery or falsification of the content or appearance of this document is unlawful and offenders may be prosecuted to the fullest extent of the law.

Tx2 antenna						
Band	Mode	Channel	Frequency (MHz)	Data Rate	Max. Rated Avg. Power + Max. Tolerance (dBm)	Average power (dBm)
5.25-5.35 GHz	802.11n20-HT0	52	5260	MCS0	19.00	18.79
		56	5280		19.00	18.85
		60	5300		19.00	18.85
		64	5320		18.00	17.62
	802.11ac20-VHT0	52	5260	MCS0	19.00	18.70
		56	5280		19.00	18.90
		60	5300		19.00	18.73
		64	5320		18.00	17.71
	802.11ax20-HE0	52	5260	MCS0	19.00	18.63
		56	5280		19.00	18.85
		60	5300		19.00	18.74
		64	5320		18.00	17.74
	802.11n40-HT0	54	5270	MCS0	19.00	18.85
		62	5310		16.50	16.10
	802.11ac40-VHT0	54	5270	MCS0	19.00	18.89
		62	5310		16.50	16.22
	802.11ax40-HE0	54	5270	MCS0	19.00	18.77
		62	5310		16.50	16.19
802.11ac80-VHT0	58	5290	MCS0	16.25	16.14	
802.11ax80-HE0	58	5290	MCS0	16.25	16.13	

Unless otherwise stated the results shown in this test report refer only to the sample(s) tested and such sample(s) are retained for 90 days only.

除非另有說明，此報告結果僅對測試之樣品負責，同時此樣品僅保留90天。本報告未經本公司書面許可，不可部份複製。

This document is issued by the Company subject to its General Conditions of Service printed overleaf, available on request or accessible at www.sgs.com/terms_and_conditions.htm and for electronic format documents, subject to Terms and Conditions for Electronic Documents at www.sgs.com/terms_e-document.htm. Attention is drawn to the limitation of liability, indemnification and jurisdiction issues defined therein. Any holder of this document is advised that information contained hereon reflects the Company's findings at the time of its intervention only and within the limits of Client's instructions, if any. The Company's sole responsibility is to its Client and this document does not exonerate parties to a transaction from exercising all their rights and obligations under the transaction documents. This document cannot be reproduced except in full, without prior written approval of the Company. Any unauthorized alteration, forgery or falsification of the content or appearance of this document is unlawful and offenders may be prosecuted to the fullest extent of the law.

Tx2 antenna						
Band	Mode	Channel	Frequency (MHz)	Data Rate	Max. Rated Avg. Power + Max. Tolerance (dBm)	Average power (dBm)
5600 MHz	802.11n20-HT0	100	5500	MCS0	19.00	18.78
		104	5520		19.00	18.72
		116	5580		19.00	18.76
		120	5600		19.00	18.72
		136	5680		19.00	18.82
		140	5700		17.75	17.37
		144	5720		19.00	18.68
	802.11ac20-VHT0	100	5500	MCS0	19.00	18.66
		104	5520		19.00	18.70
		116	5580		19.00	18.62
		120	5600		19.00	18.80
		136	5680		19.00	18.70
		140	5700		17.75	17.57
	802.11ax20-HE0	100	5500	MCS0	19.00	18.74
		104	5520		19.00	18.82
		116	5580		19.00	18.81
		120	5600		19.00	18.65
		136	5680		19.00	18.65
		140	5700		17.75	17.37
		144	5720		19.00	18.81

Unless otherwise stated the results shown in this test report refer only to the sample(s) tested and such sample(s) are retained for 90 days only.

除非另有說明，此報告結果僅對測試之樣品負責，同時此樣品僅保留90天。本報告未經本公司書面許可，不可部份複製。

This document is issued by the Company subject to its General Conditions of Service printed overleaf, available on request or accessible at www.sgs.com/terms_and_conditions.htm and for electronic format documents, subject to Terms and Conditions for Electronic Documents at www.sgs.com/terms_e-document.htm. Attention is drawn to the limitation of liability, indemnification and jurisdiction issues defined therein. Any holder of this document is advised that information contained hereon reflects the Company's findings at the time of its intervention only and within the limits of Client's instructions, if any. The Company's sole responsibility is to its Client and this document does not exonerate parties to a transaction from exercising all their rights and obligations under the transaction documents. This document cannot be reproduced except in full, without prior written approval of the Company. Any unauthorized alteration, forgery or falsification of the content or appearance of this document is unlawful and offenders may be prosecuted to the fullest extent of the law.

Tx2 antenna						
Band	Mode	Channel	Frequency (MHz)	Data Rate	Max. Rated Avg. Power + Max. Tolerance (dBm)	Average power (dBm)
5600 MHz	802.11n40-HT0	102	5510	MCS0	18.50	18.21
		110	5550		19.00	18.77
		118	5590		19.00	18.69
		134	5670		19.00	18.70
		142	5710		19.00	18.69
	802.11ac40-VHT0	102	5510	MCS0	18.50	18.30
		110	5550		19.00	18.61
		118	5590		19.00	18.63
		134	5670		19.00	18.67
		142	5710		19.00	18.75
	802.11ax40-HE0	102	5510	MCS0	18.50	18.16
		110	5550		19.00	18.72
		118	5590		19.00	18.64
		134	5670		19.00	18.84
		142	5710		19.00	18.87
	802.11ac80-VHT0	106	5530	MCS0	18.00	17.71
		122	5610		19.00	18.86
		138	5690		19.00	18.83
	802.11ax80-HE0	106	5530	MCS0	18.00	17.88
		122	5610		19.00	18.63
		138	5690		19.00	18.70
	802.11ac160-VHT0	114	5570	MCS0	13.50	13.31
	802.11ax160-HE0	114	5570	MCS0	13.50	13.33

Unless otherwise stated the results shown in this test report refer only to the sample(s) tested and such sample(s) are retained for 90 days only.

除非另有說明，此報告結果僅對測試之樣品負責，同時此樣品僅保留90天。本報告未經本公司書面許可，不可部份複製。

This document is issued by the Company subject to its General Conditions of Service printed overleaf, available on request or accessible at www.sgs.com/terms_and_conditions.htm and for electronic format documents, subject to Terms and Conditions for Electronic Documents at www.sgs.com/terms_e-document.htm. Attention is drawn to the limitation of liability, indemnification and jurisdiction issues defined therein. Any holder of this document is advised that information contained hereon reflects the Company's findings at the time of its intervention only and within the limits of Client's instructions, if any. The Company's sole responsibility is to its Client and this document does not exonerate parties to a transaction from exercising all their rights and obligations under the transaction documents. This document cannot be reproduced except in full, without prior written approval of the Company. Any unauthorized alteration, forgery or falsification of the content or appearance of this document is unlawful and offenders may be prosecuted to the fullest extent of the law.

Tx2 antenna						
Mode	Mode	Channel	Frequency (MHz)	Data Rate	Max. Rated Avg. Power + Max. Tolerance (dBm)	Average power (dBm)
5800 MHz	802.11n20-HT0	149	5745	MCS0	19.00	18.88
		157	5785		19.00	18.88
		165	5825		19.00	18.62
	802.11ac20-VHT0	149	5745	MCS0	19.00	18.84
		157	5785		19.00	18.89
		165	5825		19.00	18.63
	802.11ax20-HE0	149	5745	MCS0	19.00	18.74
		157	5785		19.00	18.80
		165	5825		19.00	18.89
	802.11n40-HT0	151	5755	MCS0	19.00	18.76
		159	5795		19.00	18.84
	802.11ac40-VHT0	151	5755	MCS0	19.00	18.67
		159	5795		19.00	18.75
	802.11ax40-HE0	151	5755	MCS0	19.00	18.66
		159	5795		19.00	18.71
802.11ac80-VHT0	155	5775	MCS0	18.75	18.55	
802.11ax80-HE0	155	5775	MCS0	18.75	18.51	

Unless otherwise stated the results shown in this test report refer only to the sample(s) tested and such sample(s) are retained for 90 days only.

除非另有說明，此報告結果僅對測試之樣品負責，同時此樣品僅保留90天。本報告未經本公司書面許可，不可部份複製。

This document is issued by the Company subject to its General Conditions of Service printed overleaf, available on request or accessible at www.sgs.com/terms_and_conditions.htm and for electronic format documents, subject to Terms and Conditions for Electronic Documents at www.sgs.com/terms_e-document.htm. Attention is drawn to the limitation of liability, indemnification and jurisdiction issues defined therein. Any holder of this document is advised that information contained hereon reflects the Company's findings at the time of its intervention only and within the limits of Client's instructions, if any. The Company's sole responsibility is to its Client and this document does not exonerate parties to a transaction from exercising all their rights and obligations under the transaction documents. This document cannot be reproduced except in full, without prior written approval of the Company. Any unauthorized alteration, forgery or falsification of the content or appearance of this document is unlawful and offenders may be prosecuted to the fullest extent of the law.

WLAN SISO Reduced power

Tx1 antenna						
Band	Mode	Channel	Frequency (MHz)	Data Rate	Max. Rated Avg. Power + Max. Tolerance (dBm)	Average power (dBm)
2450 MHz	802.11b	1	2412	1Mbps	16.50	16.49
		2	2417		16.50	16.41
		6	2437		16.50	16.48
		10	2457		16.50	16.39
		11	2462		16.50	16.44
		12	2467		16.50	16.35
		13	2472		15.75	15.00
	802.11g	1	2412	6Mbps	16.50	16.41
		2	2417		16.50	16.32
		6	2437		16.50	16.35
		10	2457		16.50	16.38
		11	2462		16.00	15.69
		12	2467		14.00	13.88
		13	2472		11.50	11.23
	802.11n20-HT0	1	2412	MCS0	16.50	16.40
		2	2417		16.50	16.38
		6	2437		16.50	16.36
		10	2457		16.50	16.39
		11	2462		16.00	15.96
		12	2467		14.00	13.82
		13	2472		11.50	10.98
	802.11ax20-HE0	1	2412	MCS0	16.50	16.33
		2	2417		16.50	16.37
		6	2437		16.50	16.38
		10	2457		16.50	16.43
		11	2462		16.00	15.49
		12	2467		14.00	13.77
		13	2472		11.50	10.73

Unless otherwise stated the results shown in this test report refer only to the sample(s) tested and such sample(s) are retained for 90 days only.

除非另有說明，此報告結果僅對測試之樣品負責，同時此樣品僅保留90天。本報告未經本公司書面許可，不可部份複製。

This document is issued by the Company subject to its General Conditions of Service printed overleaf, available on request or accessible at www.sgs.com/terms_and_conditions.htm and for electronic format documents, subject to Terms and Conditions for Electronic Documents at www.sgs.com/terms_e-document.htm. Attention is drawn to the limitation of liability, indemnification and jurisdiction issues defined therein. Any holder of this document is advised that information contained hereon reflects the Company's findings at the time of its intervention only and within the limits of Client's instructions, if any. The Company's sole responsibility is to its Client and this document does not exonerate parties to a transaction from exercising all their rights and obligations under the transaction documents. This document cannot be reproduced except in full, without prior written approval of the Company. Any unauthorized alteration, forgery or falsification of the content or appearance of this document is unlawful and offenders may be prosecuted to the fullest extent of the law.

Tx1 antenna						
Band	Mode	Channel	Frequency (MHz)	Data Rate	Max. Rated Avg. Power + Max. Tolerance (dBm)	Average power (dBm)
2450 MHz	802.11n40-HT0	3	2422	MCS0	16.50	16.36
		4	2427		16.50	16.39
		6	2437		16.50	16.42
		8	2447		15.00	14.82
		9	2452		14.25	14.02
		10	2457		12.00	11.73
		11	2462		12.00	11.91
	802.11ax40-HE0	3	2422	MCS0	16.50	16.38
		4	2427		16.50	16.41
		6	2437		16.50	16.40
		8	2447		15.00	14.60
		9	2452		14.25	14.14
		10	2457		12.00	11.80
		11	2462		12.00	11.91

Unless otherwise stated the results shown in this test report refer only to the sample(s) tested and such sample(s) are retained for 90 days only.

除非另有說明，此報告結果僅對測試之樣品負責，同時此樣品僅保留90天。本報告未經本公司書面許可，不可部份複製。

This document is issued by the Company subject to its General Conditions of Service printed overleaf, available on request or accessible at www.sgs.com/terms_and_conditions.htm and for electronic format documents, subject to Terms and Conditions for Electronic Documents at www.sgs.com/terms_e-document.htm. Attention is drawn to the limitation of liability, indemnification and jurisdiction issues defined therein. Any holder of this document is advised that information contained hereon reflects the Company's findings at the time of its intervention only and within the limits of Client's instructions, if any. The Company's sole responsibility is to its Client and this document does not exonerate parties to a transaction from exercising all their rights and obligations under the transaction documents. This document cannot be reproduced except in full, without prior written approval of the Company. Any unauthorized alteration, forgery or falsification of the content or appearance of this document is unlawful and offenders may be prosecuted to the fullest extent of the law.

Tx1 antenna						
Band	Mode	Channel	Frequency (MHz)	Data Rate	Max. Rated Avg. Power + Max. Tolerance (dBm)	Average power (dBm)
5.15-5.25 GHz	802.11a	36	5180	6Mbps	14.00	13.97
		40	5200		14.00	13.75
		44	5220		14.00	13.98
		48	5240		14.00	13.96
	802.11n20-HT0	36	5180	MCS0	14.00	13.93
		40	5200		14.00	13.97
		44	5220		14.00	13.65
		48	5240		14.00	13.92
	802.11ac20-VHT0	36	5180	MCS0	14.00	13.88
		40	5200		14.00	13.97
		44	5220		14.00	13.80
		48	5240		14.00	13.66
	802.11ax20-HE0	36	5180	MCS0	14.00	13.71
		40	5200		14.00	13.68
		44	5220		14.00	13.79
		48	5240		14.00	13.86
	802.11n40-HT0	38	5190	MCS0	14.00	13.82
		46	5230		14.00	13.91
	802.11ac40-VHT0	38	5190	MCS0	14.00	13.98
		46	5230		14.00	13.70
802.11ax40-HE0	38	5190	MCS0	14.00	13.65	
	46	5230		14.00	13.76	
802.11ac80-VHT0	42	5210	MCS0	14.00	13.95	
802.11ax80-HE0	42	5210	MCS0	14.00	13.75	
802.11ac160-VHT0	50	5250	MCS0	14.00	13.93	
802.11ax160-HE0	50	5250	MCS0	14.00	13.67	

Unless otherwise stated the results shown in this test report refer only to the sample(s) tested and such sample(s) are retained for 90 days only.

除非另有說明，此報告結果僅對測試之樣品負責，同時此樣品僅保留90天。本報告未經本公司書面許可，不可部份複製。

This document is issued by the Company subject to its General Conditions of Service printed overleaf, available on request or accessible at www.sgs.com/terms_and_conditions.htm and for electronic format documents, subject to Terms and Conditions for Electronic Documents at www.sgs.com/terms_e-document.htm. Attention is drawn to the limitation of liability, indemnification and jurisdiction issues defined therein. Any holder of this document is advised that information contained hereon reflects the Company's findings at the time of its intervention only and within the limits of Client's instructions, if any. The Company's sole responsibility is to its Client and this document does not exonerate parties to a transaction from exercising all their rights and obligations under the transaction documents. This document cannot be reproduced except in full, without prior written approval of the Company. Any unauthorized alteration, forgery or falsification of the content or appearance of this document is unlawful and offenders may be prosecuted to the fullest extent of the law.

Tx1 antenna						
Band	Mode	Channel	Frequency (MHz)	Data Rate	Max. Rated Avg. Power + Max. Tolerance (dBm)	Average power (dBm)
5.25-5.35 GHz	802.11a	52	5260	6Mbps	14.00	13.87
		56	5280		14.00	13.83
		60	5300		14.00	13.69
		64	5320		14.00	13.86
	802.11n20-HT0	52	5260	MCS0	14.00	13.64
		56	5280		14.00	13.86
		60	5300		14.00	13.62
		64	5320		14.00	13.81
	802.11ac20-VHT0	52	5260	MCS0	14.00	13.98
		56	5280		14.00	13.66
		60	5300		14.00	13.66
		64	5320		14.00	13.76
	802.11ax20-HE0	52	5260	MCS0	14.00	13.69
		56	5280		14.00	13.72
		60	5300		14.00	13.78
		64	5320		14.00	13.86
	802.11n40-HT0	54	5270	MCS0	14.00	13.96
		62	5310		14.00	13.93
	802.11ac40-VHT0	54	5270	MCS0	14.00	13.90
		62	5310		14.00	13.64
802.11ax40-HE0	54	5270	MCS0	14.00	13.85	
	62	5310		14.00	13.93	
802.11ac80-VHT0	58	5290	MCS0	14.00	13.98	
802.11ax80-HE0	58	5290	MCS0	14.00	13.82	

Unless otherwise stated the results shown in this test report refer only to the sample(s) tested and such sample(s) are retained for 90 days only.

除非另有說明，此報告結果僅對測試之樣品負責，同時此樣品僅保留90天。本報告未經本公司書面許可，不可部份複製。

This document is issued by the Company subject to its General Conditions of Service printed overleaf, available on request or accessible at www.sgs.com/terms_and_conditions.htm and for electronic format documents, subject to Terms and Conditions for Electronic Documents at www.sgs.com/terms_e-document.htm. Attention is drawn to the limitation of liability, indemnification and jurisdiction issues defined therein. Any holder of this document is advised that information contained hereon reflects the Company's findings at the time of its intervention only and within the limits of Client's instructions, if any. The Company's sole responsibility is to its Client and this document does not exonerate parties to a transaction from exercising all their rights and obligations under the transaction documents. This document cannot be reproduced except in full, without prior written approval of the Company. Any unauthorized alteration, forgery or falsification of the content or appearance of this document is unlawful and offenders may be prosecuted to the fullest extent of the law.

Tx1 antenna						
Band	Mode	Channel	Frequency (MHz)	Data Rate	Max. Rated Avg. Power + Max. Tolerance (dBm)	Average power (dBm)
5600 MHz	802.11a	100	5500	6Mbps	14.00	13.79
		104	5520		14.00	13.81
		116	5580		14.00	13.63
		120	5600		14.00	13.78
		136	5680		14.00	13.99
		140	5700		14.00	13.98
		144	5720		14.00	13.82
	802.11n20-HT0	100	5500	MCS0	14.00	13.79
		104	5520		14.00	13.83
		116	5580		14.00	13.60
		120	5600		14.00	13.65
		136	5680		14.00	13.93
		140	5700		14.00	13.85
	802.11ac20-VHT0	100	5500	MCS0	14.00	13.83
		104	5520		14.00	13.96
		116	5580		14.00	13.90
		120	5600		14.00	13.86
		136	5680		14.00	13.88
		140	5700		14.00	13.88
	802.11ax20-HE0	100	5500	MCS0	14.00	13.77
		104	5520		14.00	13.69
		116	5580		14.00	13.75
		120	5600		14.00	13.96
		136	5680		14.00	13.96
140		5700	14.00		13.71	
144		5720	14.00		13.74	

Unless otherwise stated the results shown in this test report refer only to the sample(s) tested and such sample(s) are retained for 90 days only.

除非另有說明，此報告結果僅對測試之樣品負責，同時此樣品僅保留90天。本報告未經本公司書面許可，不可部份複製。

This document is issued by the Company subject to its General Conditions of Service printed overleaf, available on request or accessible at www.sgs.com/terms_and_conditions.htm and for electronic format documents, subject to Terms and Conditions for Electronic Documents at www.sgs.com/terms_e-document.htm. Attention is drawn to the limitation of liability, indemnification and jurisdiction issues defined therein. Any holder of this document is advised that information contained hereon reflects the Company's findings at the time of its intervention only and within the limits of Client's instructions, if any. The Company's sole responsibility is to its Client and this document does not exonerate parties to a transaction from exercising all their rights and obligations under the transaction documents. This document cannot be reproduced except in full, without prior written approval of the Company. Any unauthorized alteration, forgery or falsification of the content or appearance of this document is unlawful and offenders may be prosecuted to the fullest extent of the law.

Tx1 antenna						
Band	Mode	Channel	Frequency (MHz)	Data Rate	Max. Rated Avg. Power + Max. Tolerance (dBm)	Average power (dBm)
5600 MHz	802.11n40-HT0	102	5510	MCS0	14.00	13.72
		110	5550		14.00	13.64
		118	5590		14.00	13.69
		134	5670		14.00	13.73
		142	5710		14.00	13.96
	802.11ac40-VHT0	102	5510	MCS0	14.00	13.67
		110	5550		14.00	13.67
		118	5590		14.00	13.96
		134	5670		14.00	13.66
		142	5710		14.00	13.85
	802.11ax40-HE0	102	5510	MCS0	14.00	13.85
		110	5550		14.00	13.98
		118	5590		14.00	13.94
		134	5670		14.00	13.90
		142	5710		14.00	13.91
	802.11ac80-VHT0	106	5530	MCS0	14.00	13.94
		122	5610		14.00	13.99
		138	5690		14.00	13.97
	802.11ax80-HE0	106	5530	MCS0	14.00	13.97
		122	5610		14.00	13.93
		138	5690		14.00	13.79
	802.11ac160-VHT0	114	5570	MCS0	14.00	13.98
	802.11ax160-HE0	114	5570	MCS0	14.00	13.78

Unless otherwise stated the results shown in this test report refer only to the sample(s) tested and such sample(s) are retained for 90 days only.

除非另有說明，此報告結果僅對測試之樣品負責，同時此樣品僅保留90天。本報告未經本公司書面許可，不可部份複製。

This document is issued by the Company subject to its General Conditions of Service printed overleaf, available on request or accessible at www.sgs.com/terms_and_conditions.htm and for electronic format documents, subject to Terms and Conditions for Electronic Documents at www.sgs.com/terms_e-document.htm. Attention is drawn to the limitation of liability, indemnification and jurisdiction issues defined therein. Any holder of this document is advised that information contained hereon reflects the Company's findings at the time of its intervention only and within the limits of Client's instructions, if any. The Company's sole responsibility is to its Client and this document does not exonerate parties to a transaction from exercising all their rights and obligations under the transaction documents. This document cannot be reproduced except in full, without prior written approval of the Company. Any unauthorized alteration, forgery or falsification of the content or appearance of this document is unlawful and offenders may be prosecuted to the fullest extent of the law.

Tx1 antenna						
Mode	Mode	Channel	Frequency (MHz)	Data Rate	Max. Rated Avg. Power + Max. Tolerance (dBm)	Average power (dBm)
5800 MHz	802.11a	149	5745	6Mbps	14.00	13.98
		157	5785		14.00	13.88
		165	5825		14.00	13.89
	802.11n20-HT0	149	5745	MCS0	14.00	13.70
		157	5785		14.00	13.97
		165	5825		14.00	13.73
	802.11ac20-VHT0	149	5745	MCS0	14.00	13.81
		157	5785		14.00	13.83
		165	5825		14.00	13.70
	802.11ax20-HE0	149	5745	MCS0	14.00	13.65
		157	5785		14.00	13.94
		165	5825		14.00	13.66
	802.11n40-HT0	151	5755	MCS0	14.00	13.93
		159	5795		14.00	13.95
	802.11ac40-VHT0	151	5755	MCS0	14.00	13.66
		159	5795		14.00	13.79
	802.11ax40-HE0	151	5755	MCS0	14.00	13.88
		159	5795		14.00	13.60
802.11ac80-VHT0	155	5775	MCS0	14.00	13.99	
802.11ax80-HE0	155	5775	MCS0	14.00	13.93	

Unless otherwise stated the results shown in this test report refer only to the sample(s) tested and such sample(s) are retained for 90 days only.

除非另有說明，此報告結果僅對測試之樣品負責，同時此樣品僅保留90天。本報告未經本公司書面許可，不可部份複製。

This document is issued by the Company subject to its General Conditions of Service printed overleaf, available on request or accessible at www.sgs.com/terms_and_conditions.htm and for electronic format documents, subject to Terms and Conditions for Electronic Documents at www.sgs.com/terms_e-document.htm. Attention is drawn to the limitation of liability, indemnification and jurisdiction issues defined therein. Any holder of this document is advised that information contained hereon reflects the Company's findings at the time of its intervention only and within the limits of Client's instructions, if any. The Company's sole responsibility is to its Client and this document does not exonerate parties to a transaction from exercising all their rights and obligations under the transaction documents. This document cannot be reproduced except in full, without prior written approval of the Company. Any unauthorized alteration, forgery or falsification of the content or appearance of this document is unlawful and offenders may be prosecuted to the fullest extent of the law.

Tx2 antenna						
Band	Mode	Channel	Frequency (MHz)	Data Rate	Max. Rated Avg. Power + Max. Tolerance (dBm)	Average power (dBm)
2450 MHz	802.11b	1	2412	1Mbps	14.50	14.41
		2	2417		14.50	14.23
		6	2437		14.50	14.44
		10	2457		14.50	14.39
		11	2462		14.50	14.48
		12	2467		14.50	14.36
		13	2472		14.50	14.19
	802.11g	1	2412	6Mbps	14.50	14.30
		2	2417		14.50	14.15
		6	2437		14.50	14.28
		10	2457		14.50	14.50
		11	2462		14.50	14.43
		12	2467		14.00	13.90
		13	2472		11.25	10.97
	802.11n20-HT0	1	2412	MCS0	14.50	14.12
		2	2417		14.50	14.27
		6	2437		14.50	14.44
		10	2457		14.50	14.41
		11	2462		14.50	14.42
		12	2467		14.00	13.94
		13	2472		11.25	10.79
	802.11ax20-HE0	1	2412	MCS0	14.50	14.44
		2	2417		14.50	14.21
		6	2437		14.50	14.44
10		2457	14.50		14.34	
11		2462	14.50		14.27	
12		2467	14.00		13.69	
13		2472	11.25		11.10	

Unless otherwise stated the results shown in this test report refer only to the sample(s) tested and such sample(s) are retained for 90 days only.

除非另有說明，此報告結果僅對測試之樣品負責，同時此樣品僅保留90天。本報告未經本公司書面許可，不可部份複製。

This document is issued by the Company subject to its General Conditions of Service printed overleaf, available on request or accessible at www.sgs.com/terms_and_conditions.htm and for electronic format documents, subject to Terms and Conditions for Electronic Documents at www.sgs.com/terms_e-document.htm. Attention is drawn to the limitation of liability, indemnification and jurisdiction issues defined therein. Any holder of this document is advised that information contained hereon reflects the Company's findings at the time of its intervention only and within the limits of Client's instructions, if any. The Company's sole responsibility is to its Client and this document does not exonerate parties to a transaction from exercising all their rights and obligations under the transaction documents. This document cannot be reproduced except in full, without prior written approval of the Company. Any unauthorized alteration, forgery or falsification of the content or appearance of this document is unlawful and offenders may be prosecuted to the fullest extent of the law.

Tx2 antenna						
Band	Mode	Channel	Frequency (MHz)	Data Rate	Max. Rated Avg. Power + Max. Tolerance (dBm)	Average power (dBm)
2450 MHz	802.11n40-HT0	3	2422	MCS0	14.50	14.42
		4	2427		14.50	14.15
		6	2437		14.50	14.49
		8	2447		14.50	14.32
		9	2452		14.25	14.23
		10	2457		12.00	11.61
		11	2462		11.50	11.42
	802.11ax40-HE0	3	2422	MCS0	14.50	14.16
		4	2427		14.50	14.18
		6	2437		14.50	14.16
		8	2447		14.50	14.34
		9	2452		14.25	13.92
		10	2457		12.00	11.93
		11	2462		11.50	11.12

Unless otherwise stated the results shown in this test report refer only to the sample(s) tested and such sample(s) are retained for 90 days only.

除非另有說明，此報告結果僅對測試之樣品負責，同時此樣品僅保留90天。本報告未經本公司書面許可，不可部份複製。

This document is issued by the Company subject to its General Conditions of Service printed overleaf, available on request or accessible at www.sgs.com/terms_and_conditions.htm and for electronic format documents, subject to Terms and Conditions for Electronic Documents at www.sgs.com/terms_e-document.htm. Attention is drawn to the limitation of liability, indemnification and jurisdiction issues defined therein. Any holder of this document is advised that information contained hereon reflects the Company's findings at the time of its intervention only and within the limits of Client's instructions, if any. The Company's sole responsibility is to its Client and this document does not exonerate parties to a transaction from exercising all their rights and obligations under the transaction documents. This document cannot be reproduced except in full, without prior written approval of the Company. Any unauthorized alteration, forgery or falsification of the content or appearance of this document is unlawful and offenders may be prosecuted to the fullest extent of the law.

Tx2 antenna						
Band	Mode	Channel	Frequency (MHz)	Data Rate	Max. Rated Avg. Power + Max. Tolerance (dBm)	Average power (dBm)
5.15-5.25 GHz	802.11a	36	5180	6Mbps	14.00	13.96
		40	5200		14.00	13.84
		44	5220		14.00	13.86
		48	5240		14.00	13.65
	802.11n20-HT0	36	5180	MCS0	14.00	13.82
		40	5200		14.00	13.86
		44	5220		14.00	13.79
		48	5240		14.00	13.79
	802.11ac20-VHT0	36	5180	MCS0	14.00	13.82
		40	5200		14.00	13.85
		44	5220		14.00	13.91
		48	5240		14.00	13.63
	802.11ax20-HE0	36	5180	MCS0	14.00	13.97
		40	5200		14.00	14.00
		44	5220		14.00	13.71
		48	5240		14.00	13.63
	802.11n40-HT0	38	5190	MCS0	14.00	13.86
		46	5230		14.00	13.69
	802.11ac40-VHT0	38	5190	MCS0	14.00	13.88
		46	5230		14.00	13.98
802.11ax40-HE0	38	5190	MCS0	14.00	13.77	
	46	5230		14.00	13.61	
802.11ac80-VHT0	42	5210	MCS0	14.00	13.96	
802.11ax80-HE0	42	5210	MCS0	14.00	13.99	
802.11ac160-VHT0	50	5250	MCS0	14.00	13.93	
802.11ax160-HE0	50	5250	MCS0	14.00	13.73	

Unless otherwise stated the results shown in this test report refer only to the sample(s) tested and such sample(s) are retained for 90 days only.

除非另有說明，此報告結果僅對測試之樣品負責，同時此樣品僅保留90天。本報告未經本公司書面許可，不可部份複製。

This document is issued by the Company subject to its General Conditions of Service printed overleaf, available on request or accessible at www.sgs.com/terms_and_conditions.htm and for electronic format documents, subject to Terms and Conditions for Electronic Documents at www.sgs.com/terms_e-document.htm. Attention is drawn to the limitation of liability, indemnification and jurisdiction issues defined therein. Any holder of this document is advised that information contained hereon reflects the Company's findings at the time of its intervention only and within the limits of Client's instructions, if any. The Company's sole responsibility is to its Client and this document does not exonerate parties to a transaction from exercising all their rights and obligations under the transaction documents. This document cannot be reproduced except in full, without prior written approval of the Company. Any unauthorized alteration, forgery or falsification of the content or appearance of this document is unlawful and offenders may be prosecuted to the fullest extent of the law.

Tx2 antenna						
Band	Mode	Channel	Frequency (MHz)	Data Rate	Max. Rated Avg. Power + Max. Tolerance (dBm)	Average power (dBm)
5.25-5.35 GHz	802.11a	52	5260	6Mbps	14.00	13.78
		56	5280		14.00	13.79
		60	5300		14.00	13.62
		64	5320		14.00	13.66
	802.11n20-HT0	52	5260	MCS0	14.00	13.95
		56	5280		14.00	13.91
		60	5300		14.00	13.74
		64	5320		14.00	13.85
	802.11ac20-VHT0	52	5260	MCS0	14.00	13.76
		56	5280		14.00	13.65
		60	5300		14.00	13.90
		64	5320		14.00	13.66
	802.11ax20-HE0	52	5260	MCS0	14.00	13.87
		56	5280		14.00	13.91
		60	5300		14.00	13.97
		64	5320		14.00	13.68
	802.11n40-HT0	54	5270	MCS0	14.00	13.97
		62	5310		14.00	13.99
	802.11ac40-VHT0	54	5270	MCS0	14.00	13.64
		62	5310		14.00	13.86
802.11ax40-HE0	54	5270	MCS0	14.00	13.91	
	62	5310		14.00	13.71	
802.11ac80-VHT0	58	5290	MCS0	14.00	13.96	
802.11ax80-HE0	58	5290	MCS0	14.00	13.97	

Unless otherwise stated the results shown in this test report refer only to the sample(s) tested and such sample(s) are retained for 90 days only.

除非另有說明，此報告結果僅對測試之樣品負責，同時此樣品僅保留90天。本報告未經本公司書面許可，不可部份複製。

This document is issued by the Company subject to its General Conditions of Service printed overleaf, available on request or accessible at www.sgs.com/terms_and_conditions.htm and for electronic format documents, subject to Terms and Conditions for Electronic Documents at www.sgs.com/terms_e-document.htm. Attention is drawn to the limitation of liability, indemnification and jurisdiction issues defined therein. Any holder of this document is advised that information contained hereon reflects the Company's findings at the time of its intervention only and within the limits of Client's instructions, if any. The Company's sole responsibility is to its Client and this document does not exonerate parties to a transaction from exercising all their rights and obligations under the transaction documents. This document cannot be reproduced except in full, without prior written approval of the Company. Any unauthorized alteration, forgery or falsification of the content or appearance of this document is unlawful and offenders may be prosecuted to the fullest extent of the law.

Tx2 antenna						
Band	Mode	Channel	Frequency (MHz)	Data Rate	Max. Rated Avg. Power + Max. Tolerance (dBm)	Average power (dBm)
5600 MHz	802.11a	100	5500	6Mbps	14.00	13.67
		104	5520		14.00	13.98
		116	5580		14.00	13.86
		120	5600		14.00	13.78
		136	5680		14.00	13.64
		140	5700		14.00	13.64
		144	5720		14.00	13.71
	802.11n20-HT0	100	5500	MCS0	14.00	13.64
		104	5520		14.00	13.66
		116	5580		14.00	13.92
		120	5600		14.00	13.79
		136	5680		14.00	13.80
		140	5700		14.00	13.93
	802.11ac20-VHT0	100	5500	MCS0	14.00	13.64
		104	5520		14.00	13.78
		116	5580		14.00	13.82
		120	5600		14.00	13.77
		136	5680		14.00	13.87
		140	5700		14.00	13.95
	802.11ax20-HE0	100	5500	MCS0	14.00	13.74
		104	5520		14.00	13.73
		116	5580		14.00	13.80
		120	5600		14.00	13.77
		136	5680		14.00	13.76
		140	5700		14.00	13.70
		144	5720		14.00	13.89

Unless otherwise stated the results shown in this test report refer only to the sample(s) tested and such sample(s) are retained for 90 days only.

除非另有說明，此報告結果僅對測試之樣品負責，同時此樣品僅保留90天。本報告未經本公司書面許可，不可部份複製。

This document is issued by the Company subject to its General Conditions of Service printed overleaf, available on request or accessible at www.sgs.com/terms_and_conditions.htm and for electronic format documents, subject to Terms and Conditions for Electronic Documents at www.sgs.com/terms_e-document.htm. Attention is drawn to the limitation of liability, indemnification and jurisdiction issues defined therein. Any holder of this document is advised that information contained hereon reflects the Company's findings at the time of its intervention only and within the limits of Client's instructions, if any. The Company's sole responsibility is to its Client and this document does not exonerate parties to a transaction from exercising all their rights and obligations under the transaction documents. This document cannot be reproduced except in full, without prior written approval of the Company. Any unauthorized alteration, forgery or falsification of the content or appearance of this document is unlawful and offenders may be prosecuted to the fullest extent of the law.

Tx2 antenna						
Band	Mode	Channel	Frequency (MHz)	Data Rate	Max. Rated Avg. Power + Max. Tolerance (dBm)	Average power (dBm)
5600 MHz	802.11n40-HT0	102	5510	MCS0	14.00	13.90
		110	5550		14.00	13.69
		118	5590		14.00	14.00
		134	5670		14.00	13.73
		142	5710		14.00	13.62
	802.11ac40-VHT0	102	5510	MCS0	14.00	13.67
		110	5550		14.00	13.79
		118	5590		14.00	13.91
		134	5670		14.00	13.99
		142	5710		14.00	13.75
	802.11ax40-HE0	102	5510	MCS0	14.00	13.81
		110	5550		14.00	13.70
		118	5590		14.00	13.70
		134	5670		14.00	13.75
		142	5710		14.00	13.64
	802.11ac80-VHT0	106	5530	MCS0	14.00	13.93
		122	5610		14.00	13.96
		138	5690		14.00	13.95
	802.11ax80-HE0	106	5530	MCS0	14.00	13.83
		122	5610		14.00	13.93
138		5690	14.00		13.64	
802.11ac160-VHT0	114	5570	MCS0	14.00	13.96	
802.11ax160-HE0	114	5570	MCS0	14.00	14.00	

Unless otherwise stated the results shown in this test report refer only to the sample(s) tested and such sample(s) are retained for 90 days only.

除非另有說明，此報告結果僅對測試之樣品負責，同時此樣品僅保留90天。本報告未經本公司書面許可，不可部份複製。

This document is issued by the Company subject to its General Conditions of Service printed overleaf, available on request or accessible at www.sgs.com/terms_and_conditions.htm and for electronic format documents, subject to Terms and Conditions for Electronic Documents at www.sgs.com/terms_e-document.htm. Attention is drawn to the limitation of liability, indemnification and jurisdiction issues defined therein. Any holder of this document is advised that information contained hereon reflects the Company's findings at the time of its intervention only and within the limits of Client's instructions, if any. The Company's sole responsibility is to its Client and this document does not exonerate parties to a transaction from exercising all their rights and obligations under the transaction documents. This document cannot be reproduced except in full, without prior written approval of the Company. Any unauthorized alteration, forgery or falsification of the content or appearance of this document is unlawful and offenders may be prosecuted to the fullest extent of the law.

Tx2 antenna						
Mode	Mode	Channel	Frequency (MHz)	Data Rate	Max. Rated Avg. Power + Max. Tolerance (dBm)	Average power (dBm)
5800 MHz	802.11a	149	5745	6Mbps	14.00	13.80
		157	5785		14.00	13.87
		165	5825		14.00	13.84
	802.11n20-HT0	149	5745	MCS0	14.00	13.82
		157	5785		14.00	13.79
		165	5825		14.00	13.66
	802.11ac20-VHT0	149	5745	MCS0	14.00	13.82
		157	5785		14.00	13.66
		165	5825		14.00	13.62
	802.11ax20-HE0	149	5745	MCS0	14.00	13.96
		157	5785		14.00	14.00
		165	5825		14.00	13.95
	802.11n40-HT0	151	5755	MCS0	14.00	13.94
		159	5795		14.00	13.96
	802.11ac40-VHT0	151	5755	MCS0	14.00	13.61
		159	5795		14.00	13.95
	802.11ax40-HE0	151	5755	MCS0	14.00	13.83
		159	5795		14.00	13.75
802.11ac80-VHT0	155	5775	MCS0	14.00	13.95	
802.11ax80-HE0	155	5775	MCS0	14.00	13.96	

Unless otherwise stated the results shown in this test report refer only to the sample(s) tested and such sample(s) are retained for 90 days only.

除非另有說明，此報告結果僅對測試之樣品負責，同時此樣品僅保留90天。本報告未經本公司書面許可，不可部份複製。

This document is issued by the Company subject to its General Conditions of Service printed overleaf, available on request or accessible at www.sgs.com/terms_and_conditions.htm and for electronic format documents, subject to Terms and Conditions for Electronic Documents at www.sgs.com/terms_e-document.htm. Attention is drawn to the limitation of liability, indemnification and jurisdiction issues defined therein. Any holder of this document is advised that information contained hereon reflects the Company's findings at the time of its intervention only and within the limits of Client's instructions, if any. The Company's sole responsibility is to its Client and this document does not exonerate parties to a transaction from exercising all their rights and obligations under the transaction documents. This document cannot be reproduced except in full, without prior written approval of the Company. Any unauthorized alteration, forgery or falsification of the content or appearance of this document is unlawful and offenders may be prosecuted to the fullest extent of the law.

WLAN MIMO Reduced power

Tx1 antenna						
Band	Mode	Channel	Frequency (MHz)	Data Rate	Max. Rated Avg. Power + Max. Tolerance (dBm)	Average power (dBm)
2450 MHz	802.11n20-HT0	1	2412	MCS0	16.50	16.35
		2	2417		16.50	16.40
		6	2437		16.50	16.50
		10	2457		16.50	16.43
		11	2462		15.00	14.96
		12	2467		13.50	13.47
		13	2472		8.25	8.11
	802.11ax20-HE0	1	2412	MCS0	16.50	16.39
		2	2417		16.50	16.39
		6	2437		16.50	16.44
		10	2457		16.50	16.31
		11	2462		15.00	14.86
		12	2467		13.50	13.44
		13	2472		8.25	8.16
	802.11n40-HT0	3	2422	MCS0	16.50	16.42
		4	2427		15.00	14.85
		6	2437		16.50	16.41
		8	2447		14.00	13.87
		9	2452		13.75	13.72
		10	2457		11.00	10.95
		11	2462		9.00	8.83
	802.11ax40-HE0	3	2422	MCS0	16.50	16.39
		4	2427		15.00	14.95
		6	2437		16.50	16.40
		8	2447		14.00	14.00
		9	2452		13.75	13.75
		10	2457		11.00	10.80
		11	2462		9.00	8.84

Unless otherwise stated the results shown in this test report refer only to the sample(s) tested and such sample(s) are retained for 90 days only.

除非另有說明，此報告結果僅對測試之樣品負責，同時此樣品僅保留90天。本報告未經本公司書面許可，不可部份複製。

This document is issued by the Company subject to its General Conditions of Service printed overleaf, available on request or accessible at www.sgs.com/terms_and_conditions.htm and for electronic format documents, subject to Terms and Conditions for Electronic Documents at www.sgs.com/terms_e-document.htm. Attention is drawn to the limitation of liability, indemnification and jurisdiction issues defined therein. Any holder of this document is advised that information contained hereon reflects the Company's findings at the time of its intervention only and within the limits of Client's instructions, if any. The Company's sole responsibility is to its Client and this document does not exonerate parties to a transaction from exercising all their rights and obligations under the transaction documents. This document cannot be reproduced except in full, without prior written approval of the Company. Any unauthorized alteration, forgery or falsification of the content or appearance of this document is unlawful and offenders may be prosecuted to the fullest extent of the law.

Tx1 antenna						
Band	Mode	Channel	Frequency (MHz)	Data Rate	Max. Rated Avg. Power + Max. Tolerance (dBm)	Average power (dBm)
5.15-5.25 GHz	802.11n20-HT0	36	5180	MCS0	14.00	13.81
		40	5200		14.00	13.79
		44	5220		14.00	13.87
		48	5240		14.00	13.73
	802.11ac20-VHT0	36	5180	MCS0	14.00	13.82
		40	5200		14.00	13.74
		44	5220		14.00	13.76
		48	5240		14.00	13.85
	802.11ax20-HE0	36	5180	MCS0	14.00	13.76
		40	5200		14.00	13.73
		44	5220		14.00	13.90
		48	5240		14.00	13.73
	802.11n40-HT0	38	5190	MCS0	14.00	13.85
		46	5230		14.00	13.71
	802.11ac40-VHT0	38	5190	MCS0	14.00	13.83
		46	5230		14.00	13.81
	802.11ax40-HE0	38	5190	MCS0	14.00	13.72
		46	5230		14.00	13.84
802.11ac80-VHT0	42	5210	MCS0	14.00	13.87	
802.11ax80-HE0	42	5210	MCS0	14.00	13.87	
802.11ac160-VHT0	50	5250	MCS0	13.50	13.34	
802.11ax160-HE0	50	5250	MCS0	13.50	13.35	

Unless otherwise stated the results shown in this test report refer only to the sample(s) tested and such sample(s) are retained for 90 days only.

除非另有說明，此報告結果僅對測試之樣品負責，同時此樣品僅保留90天。本報告未經本公司書面許可，不可部份複製。

This document is issued by the Company subject to its General Conditions of Service printed overleaf, available on request or accessible at www.sgs.com/terms_and_conditions.htm and for electronic format documents, subject to Terms and Conditions for Electronic Documents at www.sgs.com/terms_e-document.htm. Attention is drawn to the limitation of liability, indemnification and jurisdiction issues defined therein. Any holder of this document is advised that information contained hereon reflects the Company's findings at the time of its intervention only and within the limits of Client's instructions, if any. The Company's sole responsibility is to its Client and this document does not exonerate parties to a transaction from exercising all their rights and obligations under the transaction documents. This document cannot be reproduced except in full, without prior written approval of the Company. Any unauthorized alteration, forgery or falsification of the content or appearance of this document is unlawful and offenders may be prosecuted to the fullest extent of the law.

Tx1 antenna						
Band	Mode	Channel	Frequency (MHz)	Data Rate	Max. Rated Avg. Power + Max. Tolerance (dBm)	Average power (dBm)
5.25-5.35 GHz	802.11n20-HT0	52	5260	MCS0	14.00	13.87
		56	5280		14.00	13.71
		60	5300		14.00	13.78
		64	5320		14.00	13.79
	802.11ac20-VHT0	52	5260	MCS0	14.00	13.74
		56	5280		14.00	13.71
		60	5300		14.00	13.86
		64	5320		14.00	13.78
	802.11ax20-HE0	52	5260	MCS0	14.00	13.81
		56	5280		14.00	13.75
		60	5300		14.00	13.70
		64	5320		14.00	13.79
	802.11n40-HT0	54	5270	MCS0	14.00	13.84
		62	5310		14.00	13.90
	802.11ac40-VHT0	54	5270	MCS0	14.00	13.84
		62	5310		14.00	13.80
	802.11ax40-HE0	54	5270	MCS0	14.00	13.78
		62	5310		14.00	13.80
	802.11ac80-VHT0	58	5290	MCS0	14.00	13.85
	802.11ax80-HE0	58	5290	MCS0	14.00	13.90

Unless otherwise stated the results shown in this test report refer only to the sample(s) tested and such sample(s) are retained for 90 days only.

除非另有說明，此報告結果僅對測試之樣品負責，同時此樣品僅保留90天。本報告未經本公司書面許可，不可部份複製。

This document is issued by the Company subject to its General Conditions of Service printed overleaf, available on request or accessible at www.sgs.com/terms_and_conditions.htm and for electronic format documents, subject to Terms and Conditions for Electronic Documents at www.sgs.com/terms_e-document.htm. Attention is drawn to the limitation of liability, indemnification and jurisdiction issues defined therein. Any holder of this document is advised that information contained hereon reflects the Company's findings at the time of its intervention only and within the limits of Client's instructions, if any. The Company's sole responsibility is to its Client and this document does not exonerate parties to a transaction from exercising all their rights and obligations under the transaction documents. This document cannot be reproduced except in full, without prior written approval of the Company. Any unauthorized alteration, forgery or falsification of the content or appearance of this document is unlawful and offenders may be prosecuted to the fullest extent of the law.

Tx1 antenna						
Band	Mode	Channel	Frequency (MHz)	Data Rate	Max. Rated Avg. Power + Max. Tolerance (dBm)	Average power (dBm)
5600 MHz	802.11n20-HT0	100	5500	MCS0	14.00	13.89
		104	5520		14.00	13.79
		116	5580		14.00	13.71
		120	5600		14.00	13.90
		136	5680		14.00	13.84
		140	5700		14.00	13.84
		144	5720		14.00	13.74
	802.11ac20-VHT0	100	5500	MCS0	14.00	13.72
		104	5520		14.00	13.77
		116	5580		14.00	13.88
		120	5600		14.00	13.84
		136	5680		14.00	13.81
		140	5700		14.00	13.87
		144	5720		14.00	13.72
	802.11ax20-HE0	100	5500	MCS0	14.00	13.70
		104	5520		14.00	13.80
		116	5580		14.00	13.83
		120	5600		14.00	13.82
		136	5680		14.00	13.73
		140	5700		14.00	13.84
		144	5720		14.00	13.86

Unless otherwise stated the results shown in this test report refer only to the sample(s) tested and such sample(s) are retained for 90 days only.

除非另有說明，此報告結果僅對測試之樣品負責，同時此樣品僅保留90天。本報告未經本公司書面許可，不可部份複製。

This document is issued by the Company subject to its General Conditions of Service printed overleaf, available on request or accessible at www.sgs.com/terms_and_conditions.htm and for electronic format documents, subject to Terms and Conditions for Electronic Documents at www.sgs.com/terms_e-document.htm. Attention is drawn to the limitation of liability, indemnification and jurisdiction issues defined therein. Any holder of this document is advised that information contained hereon reflects the Company's findings at the time of its intervention only and within the limits of Client's instructions, if any. The Company's sole responsibility is to its Client and this document does not exonerate parties to a transaction from exercising all their rights and obligations under the transaction documents. This document cannot be reproduced except in full, without prior written approval of the Company. Any unauthorized alteration, forgery or falsification of the content or appearance of this document is unlawful and offenders may be prosecuted to the fullest extent of the law.

Tx1 antenna						
Band	Mode	Channel	Frequency (MHz)	Data Rate	Max. Rated Avg. Power + Max. Tolerance (dBm)	Average power (dBm)
5600 MHz	802.11n40-HT0	102	5510	MCS0	14.00	13.77
		110	5550		14.00	13.89
		118	5590		14.00	13.75
		134	5670		14.00	13.74
		142	5710		14.00	13.72
	802.11ac40-VHT0	102	5510	MCS0	14.00	13.80
		110	5550		14.00	13.79
		118	5590		14.00	13.77
		134	5670		14.00	13.82
		142	5710		14.00	13.75
	802.11ax40-HE0	102	5510	MCS0	14.00	13.87
		110	5550		14.00	13.82
		118	5590		14.00	13.81
		134	5670		14.00	13.79
		142	5710		14.00	13.89
	802.11ac80-VHT0	106	5530	MCS0	14.00	13.72
		122	5610		14.00	13.74
		138	5690		14.00	13.80
	802.11ax80-HE0	106	5530	MCS0	14.00	13.75
		122	5610		14.00	13.81
		138	5690		14.00	13.72
	802.11ac160-VHT0	114	5570	MCS0	13.50	13.25
	802.11ax160-HE0	114	5570	MCS0	13.50	13.39

Unless otherwise stated the results shown in this test report refer only to the sample(s) tested and such sample(s) are retained for 90 days only.

除非另有說明，此報告結果僅對測試之樣品負責，同時此樣品僅保留90天。本報告未經本公司書面許可，不可部份複製。

This document is issued by the Company subject to its General Conditions of Service printed overleaf, available on request or accessible at www.sgs.com/terms_and_conditions.htm and for electronic format documents, subject to Terms and Conditions for Electronic Documents at www.sgs.com/terms_e-document.htm. Attention is drawn to the limitation of liability, indemnification and jurisdiction issues defined therein. Any holder of this document is advised that information contained hereon reflects the Company's findings at the time of its intervention only and within the limits of Client's instructions, if any. The Company's sole responsibility is to its Client and this document does not exonerate parties to a transaction from exercising all their rights and obligations under the transaction documents. This document cannot be reproduced except in full, without prior written approval of the Company. Any unauthorized alteration, forgery or falsification of the content or appearance of this document is unlawful and offenders may be prosecuted to the fullest extent of the law.

Tx1 antenna						
Mode	Mode	Channel	Frequency (MHz)	Data Rate	Max. Rated Avg. Power + Max. Tolerance (dBm)	Average power (dBm)
5800 MHz	802.11n20-HT0	149	5745	MCS0	14.00	13.77
		157	5785		14.00	13.84
		165	5825		14.00	13.82
	802.11ac20-VHT0	149	5745	MCS0	14.00	13.88
		157	5785		14.00	13.89
		165	5825		14.00	13.90
	802.11ax20-HE0	149	5745	MCS0	14.00	13.72
		157	5785		14.00	13.78
		165	5825		14.00	13.79
	802.11n40-HT0	151	5755	MCS0	14.00	13.73
		159	5795		14.00	13.75
	802.11ac40-VHT0	151	5755	MCS0	14.00	13.78
		159	5795		14.00	13.74
	802.11ax40-HE0	151	5755	MCS0	14.00	13.84
		159	5795		14.00	13.71
802.11ac80-VHT0	155	5775	MCS0	14.00	13.82	
802.11ax80-HE0	155	5775	MCS0	14.00	13.82	

Unless otherwise stated the results shown in this test report refer only to the sample(s) tested and such sample(s) are retained for 90 days only.

除非另有說明，此報告結果僅對測試之樣品負責，同時此樣品僅保留90天。本報告未經本公司書面許可，不可部份複製。

This document is issued by the Company subject to its General Conditions of Service printed overleaf, available on request or accessible at www.sgs.com/terms_and_conditions.htm and for electronic format documents, subject to Terms and Conditions for Electronic Documents at www.sgs.com/terms_e-document.htm. Attention is drawn to the limitation of liability, indemnification and jurisdiction issues defined therein. Any holder of this document is advised that information contained hereon reflects the Company's findings at the time of its intervention only and within the limits of Client's instructions, if any. The Company's sole responsibility is to its Client and this document does not exonerate parties to a transaction from exercising all their rights and obligations under the transaction documents. This document cannot be reproduced except in full, without prior written approval of the Company. Any unauthorized alteration, forgery or falsification of the content or appearance of this document is unlawful and offenders may be prosecuted to the fullest extent of the law.

Tx2 antenna						
Band	Mode	Channel	Frequency (MHz)	Data Rate	Max. Rated Avg. Power + Max. Tolerance (dBm)	Average power (dBm)
2450 MHz	802.11n20-HT0	1	2412	MCS0	14.50	13.80
		2	2417		14.50	12.75
		6	2437		14.50	12.73
		10	2457		14.50	12.83
		11	2462		14.50	13.36
		12	2467		13.50	12.27
		13	2472		8.25	7.12
	802.11ax20-HE0	1	2412	MCS0	14.50	13.78
		2	2417		14.50	13.32
		6	2437		14.50	13.39
		10	2457		14.50	13.36
		11	2462		14.50	13.71
		12	2467		13.50	12.86
		13	2472		8.25	7.51
	802.11n40-HT0	3	2422	MCS0	14.50	13.76
		4	2427		14.50	13.90
		6	2437		14.50	13.87
		8	2447		14.00	13.35
		9	2452		13.75	13.10
		10	2457		11.00	10.35
		11	2462		9.00	8.22
	802.11ax40-HE0	3	2422	MCS0	14.50	14.07
		4	2427		14.50	14.11
		6	2437		14.50	14.15
		8	2447		14.00	13.82
		9	2452		13.75	13.35
		10	2457		11.00	10.75
		11	2462		9.00	8.53

Unless otherwise stated the results shown in this test report refer only to the sample(s) tested and such sample(s) are retained for 90 days only.

除非另有說明，此報告結果僅對測試之樣品負責，同時此樣品僅保留90天。本報告未經本公司書面許可，不可部份複製。

This document is issued by the Company subject to its General Conditions of Service printed overleaf, available on request or accessible at www.sgs.com/terms_and_conditions.htm and for electronic format documents, subject to Terms and Conditions for Electronic Documents at www.sgs.com/terms_e-document.htm. Attention is drawn to the limitation of liability, indemnification and jurisdiction issues defined therein. Any holder of this document is advised that information contained hereon reflects the Company's findings at the time of its intervention only and within the limits of Client's instructions, if any. The Company's sole responsibility is to its Client and this document does not exonerate parties to a transaction from exercising all their rights and obligations under the transaction documents. This document cannot be reproduced except in full, without prior written approval of the Company. Any unauthorized alteration, forgery or falsification of the content or appearance of this document is unlawful and offenders may be prosecuted to the fullest extent of the law.

Tx2 antenna						
Band	Mode	Channel	Frequency (MHz)	Data Rate	Max. Rated Avg. Power + Max. Tolerance (dBm)	Average power (dBm)
5.15-5.25 GHz	802.11n20-HT0	36	5180	MCS0	14.00	13.90
		40	5200		14.00	13.80
		44	5220		14.00	13.87
		48	5240		14.00	13.84
	802.11ac20-VHT0	36	5180	MCS0	14.00	13.78
		40	5200		14.00	13.84
		44	5220		14.00	13.71
		48	5240		14.00	13.88
	802.11ax20-HE0	36	5180	MCS0	14.00	13.70
		40	5200		14.00	13.71
		44	5220		14.00	13.88
		48	5240		14.00	13.89
	802.11n40-HT0	38	5190	MCS0	14.00	13.85
		46	5230		14.00	13.87
	802.11ac40-VHT0	38	5190	MCS0	14.00	13.75
		46	5230		14.00	13.83
	802.11ax40-HE0	38	5190	MCS0	14.00	13.90
		46	5230		14.00	13.74
802.11ac80-VHT0	42	5210	MCS0	14.00	13.84	
802.11ax80-HE0	42	5210	MCS0	14.00	13.79	
802.11ac160-VHT0	50	5250	MCS0	13.50	13.39	
802.11ax160-HE0	50	5250	MCS0	13.50	13.40	

Unless otherwise stated the results shown in this test report refer only to the sample(s) tested and such sample(s) are retained for 90 days only.

除非另有說明，此報告結果僅對測試之樣品負責，同時此樣品僅保留90天。本報告未經本公司書面許可，不可部份複製。

This document is issued by the Company subject to its General Conditions of Service printed overleaf, available on request or accessible at www.sgs.com/terms_and_conditions.htm and for electronic format documents, subject to Terms and Conditions for Electronic Documents at www.sgs.com/terms_e-document.htm. Attention is drawn to the limitation of liability, indemnification and jurisdiction issues defined therein. Any holder of this document is advised that information contained hereon reflects the Company's findings at the time of its intervention only and within the limits of Client's instructions, if any. The Company's sole responsibility is to its Client and this document does not exonerate parties to a transaction from exercising all their rights and obligations under the transaction documents. This document cannot be reproduced except in full, without prior written approval of the Company. Any unauthorized alteration, forgery or falsification of the content or appearance of this document is unlawful and offenders may be prosecuted to the fullest extent of the law.

Tx2 antenna						
Band	Mode	Channel	Frequency (MHz)	Data Rate	Max. Rated Avg. Power + Max. Tolerance (dBm)	Average power (dBm)
5.25-5.35 GHz	802.11n20-HT0	52	5260	MCS0	14.00	13.72
		56	5280		14.00	13.71
		60	5300		14.00	13.71
		64	5320		14.00	13.74
	802.11ac20-VHT0	52	5260	MCS0	14.00	13.82
		56	5280		14.00	13.85
		60	5300		14.00	13.79
		64	5320		14.00	13.88
	802.11ax20-HE0	52	5260	MCS0	14.00	13.78
		56	5280		14.00	13.75
		60	5300		14.00	13.85
		64	5320		14.00	13.75
	802.11n40-HT0	54	5270	MCS0	14.00	13.73
		62	5310		14.00	13.73
	802.11ac40-VHT0	54	5270	MCS0	14.00	13.83
		62	5310		14.00	13.84
	802.11ax40-HE0	54	5270	MCS0	14.00	13.82
		62	5310		14.00	13.78
	802.11ac80-VHT0	58	5290	MCS0	14.00	13.85
	802.11ax80-HE0	58	5290	MCS0	14.00	13.85

Unless otherwise stated the results shown in this test report refer only to the sample(s) tested and such sample(s) are retained for 90 days only.

除非另有說明，此報告結果僅對測試之樣品負責，同時此樣品僅保留90天。本報告未經本公司書面許可，不可部份複製。

This document is issued by the Company subject to its General Conditions of Service printed overleaf, available on request or accessible at www.sgs.com/terms_and_conditions.htm and for electronic format documents, subject to Terms and Conditions for Electronic Documents at www.sgs.com/terms_e-document.htm. Attention is drawn to the limitation of liability, indemnification and jurisdiction issues defined therein. Any holder of this document is advised that information contained hereon reflects the Company's findings at the time of its intervention only and within the limits of Client's instructions, if any. The Company's sole responsibility is to its Client and this document does not exonerate parties to a transaction from exercising all their rights and obligations under the transaction documents. This document cannot be reproduced except in full, without prior written approval of the Company. Any unauthorized alteration, forgery or falsification of the content or appearance of this document is unlawful and offenders may be prosecuted to the fullest extent of the law.

Tx2 antenna						
Band	Mode	Channel	Frequency (MHz)	Data Rate	Max. Rated Avg. Power + Max. Tolerance (dBm)	Average power (dBm)
5600 MHz	802.11n20-HT0	100	5500	MCS0	14.00	13.86
		104	5520		14.00	13.77
		116	5580		14.00	13.78
		120	5600		14.00	13.84
		136	5680		14.00	13.87
		140	5700		14.00	13.79
		144	5720		14.00	13.76
	802.11ac20-VHT0	100	5500	MCS0	14.00	13.85
		104	5520		14.00	13.77
		116	5580		14.00	13.90
		120	5600		14.00	13.79
		136	5680		14.00	13.88
		140	5700		14.00	13.79
		144	5720		14.00	13.82
	802.11ax20-HE0	100	5500	MCS0	14.00	13.74
		104	5520		14.00	13.82
		116	5580		14.00	13.76
		120	5600		14.00	13.82
		136	5680		14.00	13.78
		140	5700		14.00	13.80
		144	5720		14.00	13.72

Unless otherwise stated the results shown in this test report refer only to the sample(s) tested and such sample(s) are retained for 90 days only.

除非另有說明，此報告結果僅對測試之樣品負責，同時此樣品僅保留90天。本報告未經本公司書面許可，不可部份複製。

This document is issued by the Company subject to its General Conditions of Service printed overleaf, available on request or accessible at www.sgs.com/terms_and_conditions.htm and for electronic format documents, subject to Terms and Conditions for Electronic Documents at www.sgs.com/terms_e-document.htm. Attention is drawn to the limitation of liability, indemnification and jurisdiction issues defined therein. Any holder of this document is advised that information contained hereon reflects the Company's findings at the time of its intervention only and within the limits of Client's instructions, if any. The Company's sole responsibility is to its Client and this document does not exonerate parties to a transaction from exercising all their rights and obligations under the transaction documents. This document cannot be reproduced except in full, without prior written approval of the Company. Any unauthorized alteration, forgery or falsification of the content or appearance of this document is unlawful and offenders may be prosecuted to the fullest extent of the law.

Tx2 antenna						
Band	Mode	Channel	Frequency (MHz)	Data Rate	Max. Rated Avg. Power + Max. Tolerance (dBm)	Average power (dBm)
5600 MHz	802.11n40-HT0	102	5510	MCS0	14.00	13.86
		110	5550		14.00	13.83
		118	5590		14.00	13.79
		134	5670		14.00	13.85
		142	5710		14.00	13.79
	802.11ac40-VHT0	102	5510	MCS0	14.00	13.70
		110	5550		14.00	13.83
		118	5590		14.00	13.79
		134	5670		14.00	13.78
		142	5710		14.00	13.70
	802.11ax40-HE0	102	5510	MCS0	14.00	13.84
		110	5550		14.00	13.75
		118	5590		14.00	13.90
		134	5670		14.00	13.79
		142	5710		14.00	13.89
	802.11ac80-VHT0	106	5530	MCS0	14.00	13.90
		122	5610		14.00	13.70
		138	5690		14.00	13.75
	802.11ax80-HE0	106	5530	MCS0	14.00	13.84
		122	5610		14.00	13.83
		138	5690		14.00	13.72
	802.11ac160-VHT0	114	5570	MCS0	13.50	13.38
	802.11ax160-HE0	114	5570	MCS0	13.50	13.33

Unless otherwise stated the results shown in this test report refer only to the sample(s) tested and such sample(s) are retained for 90 days only.

除非另有說明，此報告結果僅對測試之樣品負責，同時此樣品僅保留90天。本報告未經本公司書面許可，不可部份複製。

This document is issued by the Company subject to its General Conditions of Service printed overleaf, available on request or accessible at www.sgs.com/terms_and_conditions.htm and for electronic format documents, subject to Terms and Conditions for Electronic Documents at www.sgs.com/terms_e-document.htm. Attention is drawn to the limitation of liability, indemnification and jurisdiction issues defined therein. Any holder of this document is advised that information contained hereon reflects the Company's findings at the time of its intervention only and within the limits of Client's instructions, if any. The Company's sole responsibility is to its Client and this document does not exonerate parties to a transaction from exercising all their rights and obligations under the transaction documents. This document cannot be reproduced except in full, without prior written approval of the Company. Any unauthorized alteration, forgery or falsification of the content or appearance of this document is unlawful and offenders may be prosecuted to the fullest extent of the law.

Tx2 antenna						
Mode	Mode	Channel	Frequency (MHz)	Data Rate	Max. Rated Avg. Power + Max. Tolerance (dBm)	Average power (dBm)
5800 MHz	802.11n20-HT0	149	5745	MCS0	14.00	13.78
		157	5785		14.00	13.89
		165	5825		14.00	13.88
	802.11ac20-VHT0	149	5745	MCS0	14.00	13.76
		157	5785		14.00	13.75
		165	5825		14.00	13.72
	802.11ax20-HE0	149	5745	MCS0	14.00	13.73
		157	5785		14.00	13.81
		165	5825		14.00	13.86
	802.11n40-HT0	151	5755	MCS0	14.00	13.85
		159	5795		14.00	13.83
	802.11ac40-VHT0	151	5755	MCS0	14.00	13.80
		159	5795		14.00	13.87
	802.11ax40-HE0	151	5755	MCS0	14.00	13.82
		159	5795		14.00	13.84
802.11ac80-VHT0	155	5775	MCS0	14.00	13.88	
802.11ax80-HE0	155	5775	MCS0	14.00	13.83	

Unless otherwise stated the results shown in this test report refer only to the sample(s) tested and such sample(s) are retained for 90 days only.

除非另有說明，此報告結果僅對測試之樣品負責，同時此樣品僅保留90天。本報告未經本公司書面許可，不可部份複製。

This document is issued by the Company subject to its General Conditions of Service printed overleaf, available on request or accessible at www.sgs.com/terms_and_conditions.htm and for electronic format documents, subject to Terms and Conditions for Electronic Documents at www.sgs.com/terms_e-document.htm. Attention is drawn to the limitation of liability, indemnification and jurisdiction issues defined therein. Any holder of this document is advised that information contained hereon reflects the Company's findings at the time of its intervention only and within the limits of Client's instructions, if any. The Company's sole responsibility is to its Client and this document does not exonerate parties to a transaction from exercising all their rights and obligations under the transaction documents. This document cannot be reproduced except in full, without prior written approval of the Company. Any unauthorized alteration, forgery or falsification of the content or appearance of this document is unlawful and offenders may be prosecuted to the fullest extent of the law.

Bluetooth conducted power table:

Mode	Channel	Frequency (MHz)	1Mbps		2Mbps		3Mbps	
			Max. Rated Avg. Power + Max. Tolerance (dBm)	Average power (dBm)	Max. Rated Avg. Power + Max. Tolerance (dBm)	Average power (dBm)	Max. Rated Avg. Power + Max. Tolerance (dBm)	Average power (dBm)
BR/EDR	CH 00	2402	11.50	9.61	7.50	7.36	7.50	6.20
	CH 39	2441		10.09		7.43		6.28
	CH 78	2480		9.75		7.41		6.30

Mode	Channel	Frequency (MHz)	GFSK	
			Max. Rated Avg. Power + Max. Tolerance (dBm)	Average Output Power (dBm)
LE	CH 00	2402	7.5	7.48
	CH 19	2440		7.42
	CH 39	2480		7.46

Unless otherwise stated the results shown in this test report refer only to the sample(s) tested and such sample(s) are retained for 90 days only.

除非另有說明，此報告結果僅對測試之樣品負責，同時此樣品僅保留90天。本報告未經本公司書面許可，不可部份複製。

This document is issued by the Company subject to its General Conditions of Service printed overleaf, available on request or accessible at www.sgs.com/terms_and_conditions.htm and for electronic format documents, subject to Terms and Conditions for Electronic Documents at www.sgs.com/terms_e-document.htm. Attention is drawn to the limitation of liability, indemnification and jurisdiction issues defined therein. Any holder of this document is advised that information contained hereon reflects the Company's findings at the time of its intervention only and within the limits of Client's instructions, if any. The Company's sole responsibility is to its Client and this document does not exonerate parties to a transaction from exercising all their rights and obligations under the transaction documents. This document cannot be reproduced except in full, without prior written approval of the Company. Any unauthorized alteration, forgery or falsification of the content or appearance of this document is unlawful and offenders may be prosecuted to the fullest extent of the law.

2.4G b_duty(8.352/8.396=0.995)

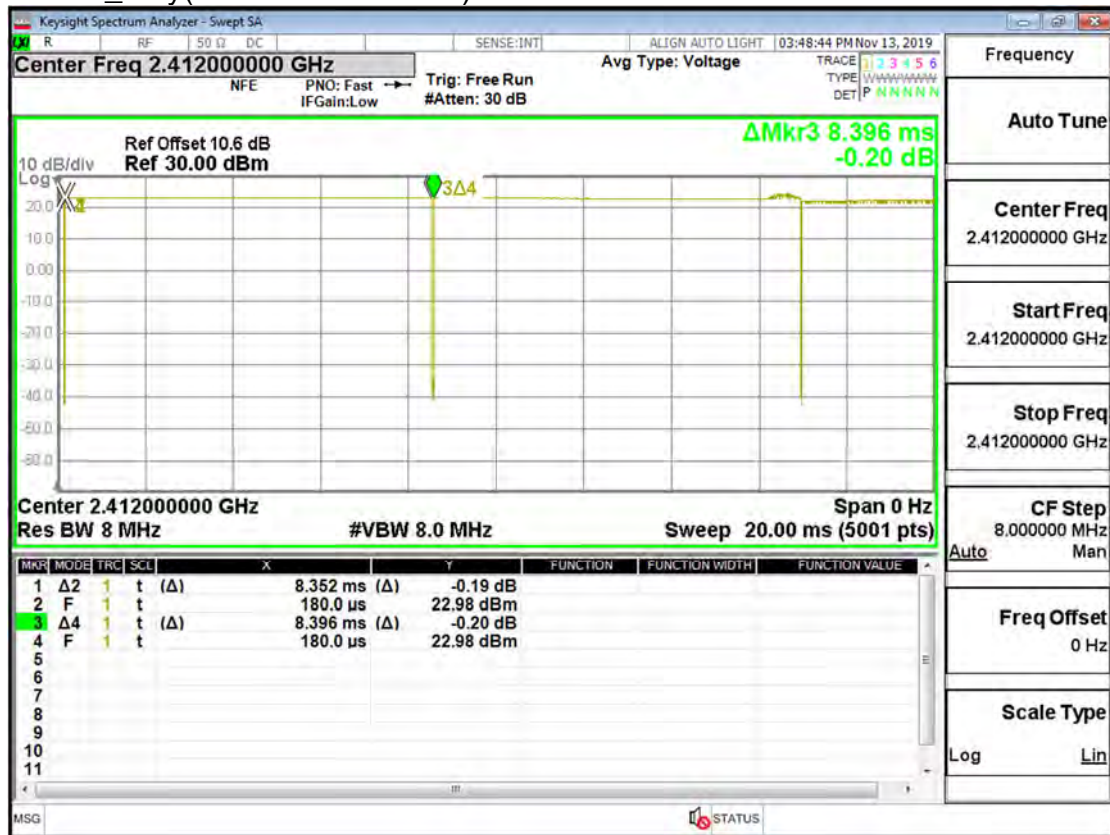

Unless otherwise stated the results shown in this test report refer only to the sample(s) tested and such sample(s) are retained for 90 days only.

除非另有說明，此報告結果僅對測試之樣品負責，同時此樣品僅保留90天。本報告未經本公司書面許可，不可部份複製。

This document is issued by the Company subject to its General Conditions of Service printed overleaf, available on request or accessible at www.sgs.com/terms_and_conditions.htm and for electronic format documents, subject to Terms and Conditions for Electronic Documents at www.sgs.com/terms_e-document.htm. Attention is drawn to the limitation of liability, indemnification and jurisdiction issues defined therein. Any holder of this document is advised that information contained hereon reflects the Company's findings at the time of its intervention only and within the limits of Client's instructions, if any. The Company's sole responsibility is to its Client and this document does not exonerate parties to a transaction from exercising all their rights and obligations under the transaction documents. This document cannot be reproduced except in full, without prior written approval of the Company. Any unauthorized alteration, forgery or falsification of the content or appearance of this document is unlawful and offenders may be prosecuted to the fullest extent of the law.

2.4G n20_duty(3.98/4.025=0.989)



Unless otherwise stated the results shown in this test report refer only to the sample(s) tested and such sample(s) are retained for 90 days only.

除非另有說明，此報告結果僅對測試之樣品負責，同時此樣品僅保留90天。本報告未經本公司書面許可，不可部份複製。

This document is issued by the Company subject to its General Conditions of Service printed overleaf, available on request or accessible at www.sgs.com/terms_and_conditions.htm and for electronic format documents, subject to Terms and Conditions for Electronic Documents at www.sgs.com/terms_e-document.htm. Attention is drawn to the limitation of liability, indemnification and jurisdiction issues defined therein. Any holder of this document is advised that information contained hereon reflects the Company's findings at the time of its intervention only and within the limits of Client's instructions, if any. The Company's sole responsibility is to its Client and this document does not exonerate parties to a transaction from exercising all their rights and obligations under the transaction documents. This document cannot be reproduced except in full, without prior written approval of the Company. Any unauthorized alteration, forgery or falsification of the content or appearance of this document is unlawful and offenders may be prosecuted to the fullest extent of the law.

2.4G n40_duty(3.98/4.025=0.989)



Unless otherwise stated the results shown in this test report refer only to the sample(s) tested and such sample(s) are retained for 90 days only.

除非另有說明，此報告結果僅對測試之樣品負責，同時此樣品僅保留90天。本報告未經本公司書面許可，不可部份複製。

This document is issued by the Company subject to its General Conditions of Service printed overleaf, available on request or accessible at www.sgs.com/terms_and_conditions.htm and for electronic format documents, subject to Terms and Conditions for Electronic Documents at www.sgs.com/terms_e-document.htm. Attention is drawn to the limitation of liability, indemnification and jurisdiction issues defined therein. Any holder of this document is advised that information contained hereon reflects the Company's findings at the time of its intervention only and within the limits of Client's instructions, if any. The Company's sole responsibility is to its Client and this document does not exonerate parties to a transaction from exercising all their rights and obligations under the transaction documents. This document cannot be reproduced except in full, without prior written approval of the Company. Any unauthorized alteration, forgery or falsification of the content or appearance of this document is unlawful and offenders may be prosecuted to the fullest extent of the law.

BT_duty(2.88/3.75=0.768)



5G n40_duty(3.98/4.026=0.99)

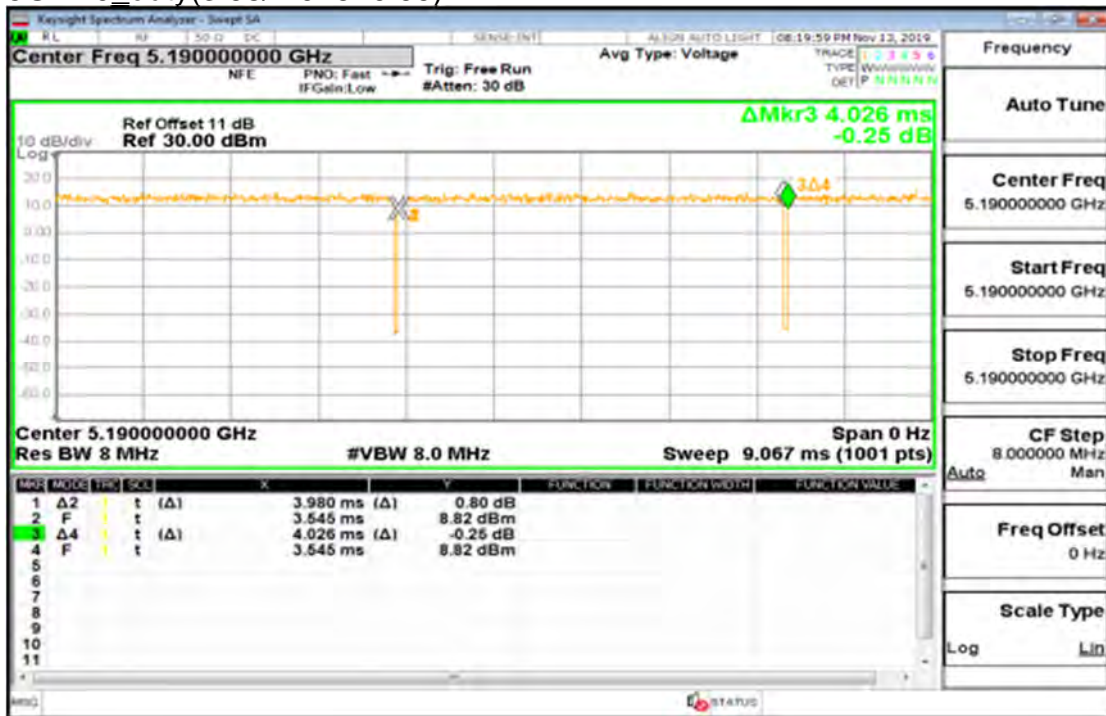

Unless otherwise stated the results shown in this test report refer only to the sample(s) tested and such sample(s) are retained for 90 days only.

除非另有說明，此報告結果僅對測試之樣品負責，同時此樣品僅保留90天。本報告未經本公司書面許可，不可部份複製。

This document is issued by the Company subject to its General Conditions of Service printed overleaf, available on request or accessible at www.sgs.com/terms_and_conditions.htm and for electronic format documents, subject to Terms and Conditions for Electronic Documents at www.sgs.com/terms_e-document.htm. Attention is drawn to the limitation of liability, indemnification and jurisdiction issues defined therein. Any holder of this document is advised that information contained hereon reflects the Company's findings at the time of its intervention only and within the limits of Client's instructions, if any. The Company's sole responsibility is to its Client and this document does not exonerate parties to a transaction from exercising all their rights and obligations under the transaction documents. This document cannot be reproduced except in full, without prior written approval of the Company. Any unauthorized alteration, forgery or falsification of the content or appearance of this document is unlawful and offenders may be prosecuted to the fullest extent of the law.

5G ac80_duty(3.966/4.007=0.99)



Unless otherwise stated the results shown in this test report refer only to the sample(s) tested and such sample(s) are retained for 90 days only.

除非另有說明，此報告結果僅對測試之樣品負責，同時此樣品僅保留90天。本報告未經本公司書面許可，不可部份複製。

This document is issued by the Company subject to its General Conditions of Service printed overleaf, available on request or accessible at www.sgs.com/terms_and_conditions.htm and for electronic format documents, subject to Terms and Conditions for Electronic Documents at www.sgs.com/terms_e-document.htm. Attention is drawn to the limitation of liability, indemnification and jurisdiction issues defined therein. Any holder of this document is advised that information contained hereon reflects the Company's findings at the time of its intervention only and within the limits of Client's instructions, if any. The Company's sole responsibility is to its Client and this document does not exonerate parties to a transaction from exercising all their rights and obligations under the transaction documents. This document cannot be reproduced except in full, without prior written approval of the Company. Any unauthorized alteration, forgery or falsification of the content or appearance of this document is unlawful and offenders may be prosecuted to the fullest extent of the law.

5G ac160_duty(2.789/2.832=0.985)



Unless otherwise stated the results shown in this test report refer only to the sample(s) tested and such sample(s) are retained for 90 days only.

除非另有說明，此報告結果僅對測試之樣品負責，同時此樣品僅保留90天。本報告未經本公司書面許可，不可部份複製。

This document is issued by the Company subject to its General Conditions of Service printed overleaf, available on request or accessible at www.sgs.com/terms_and_conditions.htm and for electronic format documents, subject to Terms and Conditions for Electronic Documents at www.sgs.com/terms_e-document.htm. Attention is drawn to the limitation of liability, indemnification and jurisdiction issues defined therein. Any holder of this document is advised that information contained hereon reflects the Company's findings at the time of its intervention only and within the limits of Client's instructions, if any. The Company's sole responsibility is to its Client and this document does not exonerate parties to a transaction from exercising all their rights and obligations under the transaction documents. This document cannot be reproduced except in full, without prior written approval of the Company. Any unauthorized alteration, forgery or falsification of the content or appearance of this document is unlawful and offenders may be prosecuted to the fullest extent of the law.

1.3.1 LTE Downlink CA specification

LTE Downlink 2CA conducted power table

Two Component Carrier Maximum Conducted Power																	
PCC							DL				SCC				Full power		Configurations
UL							DL				DL				DL CA active	DL CA inactive	
Band	Bandwidth [MHz]	Modulation	RB	RB Offset	Frequency [MHz]	Channel	Frequency [MHz]	Channel	Band	Bandwidth [MHz]	Frequency [MHz]	Channel	DL CA active	DL CA inactive			
LTE B66	20	QPSK	1	0	1720	132072	2120	66536	LTE B29	10	722.5	9715	24.45	24.49	CA_29A-66A		

Two Component Carrier Maximum Conducted Power																	
PCC							DL				SCC				Reduced power		Configurations
UL							DL				DL				DL CA active	DL CA inactive	
Band	Bandwidth [MHz]	Modulation	RB	RB Offset	Frequency [MHz]	Channel	Frequency [MHz]	Channel	Band	Bandwidth [MHz]	Frequency [MHz]	Channel	DL CA active	DL CA inactive			
LTE B66	20	QPSK	1	0	1770	132572	2120	66536	LTE B29	10	722.5	9715	16.50	16.58	CA_29A-66A		

Unless otherwise stated the results shown in this test report refer only to the sample(s) tested and such sample(s) are retained for 90 days only.

除非另有說明，此報告結果僅對測試之樣品負責，同時此樣品僅保留90天。本報告未經本公司書面許可，不可部份複製。

This document is issued by the Company subject to its General Conditions of Service printed overleaf, available on request or accessible at www.sgs.com/terms_and_conditions.htm and for electronic format documents, subject to Terms and Conditions for Electronic Documents at www.sgs.com/terms_e-document.htm. Attention is drawn to the limitation of liability, indemnification and jurisdiction issues defined therein. Any holder of this document is advised that information contained hereon reflects the Company's findings at the time of its intervention only and within the limits of Client's instructions, if any. The Company's sole responsibility is to its Client and this document does not exonerate parties to a transaction from exercising all their rights and obligations under the transaction documents. This document cannot be reproduced except in full, without prior written approval of the Company. Any unauthorized alteration, forgery or falsification of the content or appearance of this document is unlawful and offenders may be prosecuted to the fullest extent of the law.

LTE Downlink 3CA conducted power table

Three Component Carrier Maximum Conducted Power																			
PCC								SCC 1				SCC 2				Full power		Configurations	
Band	Bandwidth [MHz]	Modulation	RB	RB Offset	Frequency [MHz]	Channel	Frequency [MHz]	Channel	Band	Bandwidth [MHz]	Frequency [MHz]	Channel	Band	Bandwidth [MHz]	Frequency [MHz]	Channel	DL CA active		DL CA inactive
LTE B2	20	QPSK	1	99	1900	19100	1980	1100	LTE B4	20	2132.5	2175	LTE B5	10	881.5	2525	24.22	24.39	CA_2A-4A-5A
LTE B4	20	QPSK	1	0	1745	20300	2145	2300	LTE B2	20	1960	900	LTE B5	10	881.5	2525	23.87	23.99	CA_2A-4A-5A
LTE B5	10	QPSK	1	0	829	20450	874	2450	LTE B2	20	1960	900	LTE B4	20	2132.5	2175	24.04	24.13	CA_2A-4A-5A
LTE B2	20	QPSK	1	99	1900	19100	1980	1100	LTE B4	20	2132.5	2175	LTE B12	10	737.5	5095	24.22	24.39	CA_2A-12A-12A
LTE B4	20	QPSK	1	0	1745	20300	2145	2300	LTE B2	20	1960	900	LTE B12	10	737.5	5095	23.83	23.99	CA_2A-12A-12A
LTE B12	10	QPSK	1	49	707.5	23095	737.5	5095	LTE B2	20	1960	900	LTE B4	20	2132.5	2175	24.15	24.32	CA_2A-4A-12A
LTE B2	20	QPSK	1	99	1900	19100	1980	1100	LTE B4	20	2132.5	2175	LTE B13	10	751	5230	24.38	24.39	CA_2A-4A-13A
LTE B4	20	QPSK	1	0	1745	20300	2145	2300	LTE B2	20	1960	900	LTE B13	10	751	5230	23.80	23.99	CA_2A-4A-13A
LTE B13	10	QPSK	1	49	782	23230	751	5230	LTE B2	20	1960	900	LTE B4	20	2132.5	2175	24.15	24.15	CA_2A-4A-13A
LTE B2	20	QPSK	1	99	1900	19100	1980	1100	LTE B5	10	881.5	2525	LTE B30	10	2355	9820	24.27	24.39	CA_2A-5A-30A
LTE B5	10	QPSK	1	0	829	20450	874	2450	LTE B2	20	1960	900	LTE B30	10	2355	9820	24.08	24.13	CA_2A-5A-30A
LTE B30	10	QPSK	1	0	2310	27710	2355	9820	LTE B2	20	1960	900	LTE B5	10	881.5	2525	22.91	22.99	CA_2A-5A-30A
LTE B2	20	QPSK	1	99	1900	19100	1980	1100	LTE B5	10	881.5	2525	LTE B66	20	2145	66786	24.33	24.39	CA_2A-5A-66A
LTE B5	10	QPSK	1	0	829	20450	874	2450	LTE B2	20	1960	900	LTE B66	20	2145	66786	23.96	24.13	CA_2A-5A-66A
LTE B66	20	QPSK	1	0	1720	132072	2120	66536	LTE B2	20	1960	900	LTE B5	10	881.5	2525	24.40	24.49	CA_2A-5A-66A
LTE B2	20	QPSK	1	99	1900	19100	1980	1100	LTE B12	10	737.5	5095	LTE B30	10	2355	9820	24.21	24.39	CA_2A-12A-30A
LTE B12	10	QPSK	1	49	707.5	23095	737.5	5095	LTE B2	20	1960	900	LTE B30	10	2355	9820	24.18	24.32	CA_2A-12A-30A
LTE B30	10	QPSK	1	0	2310	27710	2355	9820	LTE B2	20	1960	900	LTE B12	10	737.5	5095	22.95	22.99	CA_2A-12A-30A
LTE B2	20	QPSK	1	99	1900	19100	1980	1100	LTE B12	10	737.5	5095	LTE B66	20	2145	66786	24.28	24.39	CA_2A-12A-66A
LTE B12	10	QPSK	1	49	707.5	23095	737.5	5095	LTE B2	20	1960	900	LTE B12	10	737.5	5095	24.46	24.49	CA_2A-12A-66A
LTE B66	20	QPSK	1	0	1720	132072	2120	66536	LTE B2	20	1960	900	LTE B12	10	737.5	5095	24.38	24.39	CA_2A-12A-66A
LTE B2	20	QPSK	1	99	1900	19100	1980	1100	LTE B13	10	751	5230	LTE B66	20	2145	66786	24.36	24.39	CA_2A-13A-66A
LTE B13	10	QPSK	1	49	782	23230	751	5230	LTE B2	20	1960	900	LTE B66	20	2145	66786	23.98	24.15	CA_2A-13A-66A
LTE B66	20	QPSK	1	0	1720	132072	2120	66536	LTE B2	20	1960	900	LTE B13	10	751	5230	24.40	24.49	CA_2A-13A-66A
LTE B2	20	QPSK	1	99	1900	19100	1980	1100	LTE B29	10	722.5	9715	LTE B30	10	2355	9820	24.23	24.39	CA_2A-29A-30A
LTE B29	10	QPSK	1	0	2310	27710	2355	9820	LTE B2	20	1960	900	LTE B29	10	722.5	9715	22.88	22.89	CA_2A-29A-30A
LTE B4	20	QPSK	1	0	1745	20300	2145	2300	LTE B5	10	881.5	2525	LTE B30	10	2355	9820	23.81	23.99	CA_4A-5A-30A
LTE B5	10	QPSK	1	0	829	20450	874	2450	LTE B4	20	2132.5	2175	LTE B30	10	2355	9820	24.13	24.13	CA_4A-5A-30A
LTE B30	10	QPSK	1	0	2310	27710	2355	9820	LTE B4	20	2132.5	2175	LTE B5	10	881.5	2525	22.83	22.99	CA_4A-5A-30A
LTE B4	20	QPSK	1	0	1745	20300	2145	2300	LTE B12	10	737.5	5095	LTE B30	10	2355	9820	23.81	23.99	CA_4A-12A-30A
LTE B12	10	QPSK	1	49	707.5	23095	737.5	5095	LTE B4	20	2132.5	2175	LTE B30	10	2355	9820	24.18	24.32	CA_4A-12A-30A
LTE B30	10	QPSK	1	0	2310	27710	2355	9820	LTE B4	20	2132.5	2175	LTE B12	10	737.5	5095	22.85	22.99	CA_4A-12A-30A
LTE B4	20	QPSK	1	0	1745	20300	2145	2300	LTE B29	10	722.5	9715	LTE B30	10	2355	9820	23.97	23.99	CA_4A-29A-30A
LTE B29	10	QPSK	1	0	2310	27710	2355	9820	LTE B4	20	2132.5	2175	LTE B29	10	722.5	9715	22.98	22.99	CA_4A-29A-30A
LTE B5	10	QPSK	1	0	829	20450	874	2450	LTE B30	10	2355	9820	LTE B66	20	2145	66786	24.09	24.13	CA_5A-30A-66A
LTE B30	10	QPSK	1	0	2310	27710	2355	9820	LTE B5	10	881.5	2525	LTE B66	20	2145	66786	22.93	22.99	CA_5A-30A-66A
LTE B66	20	QPSK	1	0	1720	132072	2120	66536	LTE B5	10	881.5	2525	LTE B30	10	2355	9820	24.46	24.49	CA_5A-30A-66A
LTE B12	10	QPSK	1	49	707.5	23095	737.5	5095	LTE B30	10	2355	9820	LTE B66	20	2145	66786	24.30	24.32	CA_12A-30A-66A
LTE B30	10	QPSK	1	0	2310	27710	2355	9820	LTE B12	10	737.5	5095	LTE B66	20	2145	66786	22.95	22.99	CA_12A-30A-66A
LTE B66	20	QPSK	1	0	1720	132072	2120	66536	LTE B12	10	737.5	5095	LTE B30	10	2355	9820	24.48	24.49	CA_12A-30A-66A
LTE B2	20	QPSK	1	99	1900	19100	1980	1100	LTE B66	20	2120	66536	LTE B66	20	2170	67036	24.25	24.39	CA_2A-66A-66A
LTE B66	20	QPSK	1	0	1720	132072	2120	66536	LTE B66	20	2170	67036	LTE B2	20	1960	900	24.38	24.49	CA_2A-66A-66A
LTE B66	20	QPSK	1	0	1720	132572	2170	67036	LTE B66	20	2120	66536	LTE B2	20	1960	900	24.34	24.47	CA_2A-66A-66A
LTE B5	10	QPSK	1	0	829	20450	874	2450	LTE B66	20	2120	66536	LTE B66	20	2170	67036	23.94	24.13	CA_5A-66A-66A
LTE B66	20	QPSK	1	0	1720	132072	2120	66536	LTE B66	20	2170	67036	LTE B5	10	881.5	2525	24.33	24.49	CA_5A-66A-66A
LTE B66	20	QPSK	1	0	1770	132572	2170	67036	LTE B66	20	2120	66536	LTE B5	10	881.5	2525	24.33	24.47	CA_5A-66A-66A
LTE B12	10	QPSK	1	49	707.5	23095	737.5	5095	LTE B66	20	2120	66536	LTE B66	20	2170	67036	24.25	24.32	CA_12A-66A-66A
LTE B66	20	QPSK	1	0	1770	132572	2170	67036	LTE B66	20	2170	67036	LTE B12	10	737.5	5095	24.35	24.49	CA_12A-66A-66A
LTE B12	10	QPSK	1	49	782	23230	751	5230	LTE B66	20	2120	66536	LTE B12	10	737.5	5095	24.33	24.47	CA_12A-66A-66A
LTE B13	10	QPSK	1	49	782	23230	751	5230	LTE B66	20	2120	66536	LTE B66	20	2170	67036	23.97	24.15	CA_13A-66A-66A
LTE B66	20	QPSK	1	0	1770	132572	2170	67036	LTE B66	20	2170	67036	LTE B13	10	751	5230	24.27	24.49	CA_13A-66A-66A
LTE B66	20	QPSK	1	0	1770	132572	2170	67036	LTE B66	20	2120	66536	LTE B13	10	751	5230	24.42	24.47	CA_13A-66A-66A
LTE B30	10	QPSK	1	0	2310	27710	2355	9820	LTE B66	20	2120	66536	LTE B66	20	2170	67036	23.97	23.99	CA_30A-66A-66A
LTE B66	20	QPSK	1	0	1720	132072	2120	66536	LTE B66	20	2170	67036	LTE B30	10	2355	9820	24.31	24.49	CA_30A-66A-66A
LTE B66	20	QPSK	1	0	1770	132572	2170	67036	LTE B66	20	2120	66536	LTE B30	10	2355	9820	24.34	24.47	CA_30A-66A-66A
LTE B2	20	QPSK	1	0	1860	18700	1940	700	LTE B2	20	1960	1100	LTE B5	10	881.5	2525	24.21	24.21	CA_2A-2A-5A
LTE B2	20	QPSK	1	99	1900	19100	1980	1100	LTE B2	20	1940	700	LTE B5	10	881.5	2525	24.28	24.39	CA_2A-2A-5A
LTE B5	10	QPSK	1	0	829	20450	874	2450	LTE B2	20	1940	700	LTE B2	20	1980	1100	24.09	24.13	CA_2A-2A-5A
LTE B2	20	QPSK																	

Three Component Carrier Maximum Conducted Power																				
PCC										SCC 1				SCC 2				Reduced power		Configurations
UL					DL					DL				DL				DL CA active	DL CA inactive	
Band	Bandwidth [MHz]	Modulation	RB	RB Offset	Frequency [MHz]	Channel	Frequency [MHz]	Channel	Band	Bandwidth [MHz]	Frequency [MHz]	Channel	Band	Bandwidth [MHz]	Frequency [MHz]	Channel				
LTE B2	20	QPSK	1	0	1900	19100	1980	1100	LTE B4	20	2132.5	2175	LTE B5	10	881.5	2525	15.66	15.94	CA 2A-4A-5A	
LTE B4	20	QPSK	1	0	1732.5	20175	2123.5	2175	LTE B2	20	1960	900	LTE B5	10	881.5	2525	17.45	17.60	CA 2A-4A-5A	
LTE B5	10	QPSK	1	0	829	20450	874	2450	LTE B2	20	1960	900	LTE B4	20	2132.5	2175	19.56	19.68	CA 2A-4A-5A	
LTE B2	20	QPSK	1	0	1900	19100	1980	1100	LTE B4	20	2132.5	2175	LTE B12	10	737.5	5095	15.79	15.94	CA 2A-4A-12A	
LTE B4	20	QPSK	1	0	1732.5	20175	2123.5	2175	LTE B2	20	1960	900	LTE B12	10	737.5	5095	17.35	17.60	CA 2A-4A-12A	
LTE B12	10	QPSK	1	25	707.5	23095	737.5	5095	LTE B2	20	1960	900	LTE B4	20	2132.5	2175	19.54	19.65	CA 2A-4A-12A	
LTE B2	20	QPSK	1	0	1900	19100	1980	1100	LTE B4	20	2132.5	2175	LTE B13	10	751	5230	15.70	15.94	CA 2A-4A-13A	
LTE B4	20	QPSK	1	0	1732.5	20175	2123.5	2175	LTE B2	20	1960	900	LTE B13	10	751	5230	17.46	17.60	CA 2A-4A-13A	
LTE B13	10	QPSK	1	0	782	23230	751	5230	LTE B2	20	1960	900	LTE B4	20	2132.5	2175	19.23	19.52	CA 2A-4A-13A	
LTE B2	20	QPSK	1	0	1900	19100	1980	1100	LTE B5	10	881.5	2525	LTE B30	10	2355	9820	15.74	15.94	CA 2A-5A-30A	
LTE B5	10	QPSK	1	0	829	20450	874	2450	LTE B2	20	1960	900	LTE B30	10	2355	9820	19.51	19.68	CA 2A-5A-30A	
LTE B30	10	QPSK	1	0	2310	27710	2355	9820	LTE B2	20	1960	900	LTE B5	10	881.5	2525	16.01	16.30	CA 2A-5A-30A	
LTE B2	20	QPSK	1	0	1900	19100	1980	1100	LTE B5	10	881.5	2525	LTE B66	20	2145	66786	15.65	15.94	CA 2A-5A-66A	
LTE B5	10	QPSK	1	0	829	20450	874	2450	LTE B2	20	1960	900	LTE B66	20	2145	66786	19.49	19.68	CA 2A-5A-66A	
LTE B66	20	QPSK	1	0	1770	132572	2170	67036	LTE B2	20	1960	900	LTE B5	10	881.5	2525	16.50	16.58	CA 2A-5A-66A	
LTE B2	20	QPSK	1	0	1900	19100	1980	1100	LTE B12	10	737.5	5095	LTE B30	10	2355	9820	15.84	15.94	CA 2A-12A-30A	
LTE B12	10	QPSK	1	25	707.5	23095	737.5	5095	LTE B2	20	1960	900	LTE B30	10	2355	9820	19.46	19.65	CA 2A-12A-30A	
LTE B30	10	QPSK	1	0	2310	27710	2355	9820	LTE B12	10	737.5	5095	LTE B66	20	2145	66786	15.72	15.94	CA 2A-12A-66A	
LTE B12	10	QPSK	1	25	707.5	23095	737.5	5095	LTE B2	20	1960	900	LTE B66	20	2145	66786	19.48	19.65	CA 2A-12A-66A	
LTE B66	20	QPSK	1	0	1770	132572	2170	67036	LTE B2	20	1960	900	LTE B12	10	737.5	5095	16.50	16.58	CA 2A-12A-66A	
LTE B2	20	QPSK	1	0	1900	19100	1980	1100	LTE B13	10	751	5230	LTE B66	20	2145	66786	15.72	15.94	CA 2A-13A-66A	
LTE B13	10	QPSK	1	0	782	23230	751	5230	LTE B2	20	1960	900	LTE B66	20	2145	66786	19.37	19.52	CA 2A-13A-66A	
LTE B66	20	QPSK	1	0	1770	132572	2170	67036	LTE B2	20	1960	900	LTE B13	10	751	5230	16.52	16.58	CA 2A-13A-66A	
LTE B30	10	QPSK	1	0	2310	27710	2355	9820	LTE B4	20	2132.5	2175	LTE B12	10	737.5	5095	16.17	16.30	CA 2A-29A-30A	
LTE B4	20	QPSK	1	0	1732.5	20175	2123.5	2175	LTE B2	20	1960	900	LTE B29	10	722.5	9715	16.01	16.30	CA 2A-29A-30A	
LTE B2	20	QPSK	1	0	1900	19100	1980	1100	LTE B5	10	881.5	2525	LTE B30	10	2355	9820	17.46	17.60	CA 4A-5A-30A	
LTE B5	10	QPSK	1	0	829	20450	874	2450	LTE B4	20	2132.5	2175	LTE B30	10	2355	9820	19.48	19.68	CA 4A-5A-30A	
LTE B30	10	QPSK	1	0	2310	27710	2355	9820	LTE B4	20	2132.5	2175	LTE B5	10	881.5	2525	16.11	16.30	CA 4A-5A-30A	
LTE B4	20	QPSK	1	0	1732.5	20175	2123.5	2175	LTE B12	10	737.5	5095	LTE B30	10	2355	9820	17.34	17.60	CA 4A-5A-30A	
LTE B12	10	QPSK	1	25	707.5	23095	737.5	5095	LTE B4	20	2132.5	2175	LTE B30	10	2355	9820	19.37	19.65	CA 4A-5A-30A	
LTE B30	10	QPSK	1	0	2310	27710	2355	9820	LTE B4	20	2132.5	2175	LTE B12	10	737.5	5095	16.17	16.30	CA 4A-5A-30A	
LTE B4	20	QPSK	1	0	1732.5	20175	2123.5	2175	LTE B29	10	722.5	9715	LTE B30	10	2355	9820	17.43	17.60	CA 4A-29A-30A	
LTE B30	10	QPSK	1	0	2310	27710	2355	9820	LTE B4	20	2132.5	2175	LTE B29	10	722.5	9715	16.17	16.30	CA 4A-29A-30A	
LTE B5	10	QPSK	1	0	829	20450	874	2450	LTE B30	10	2355	9820	LTE B66	20	2145	66786	19.45	19.68	CA 5A-30A-66A	
LTE B30	10	QPSK	1	0	2310	27710	2355	9820	LTE B5	10	881.5	2525	LTE B66	20	2145	66786	16.08	16.30	CA 5A-30A-66A	
LTE B66	20	QPSK	1	0	1770	132572	2170	67036	LTE B5	10	881.5	2525	LTE B30	10	2355	9820	16.52	16.58	CA 5A-30A-66A	
LTE B12	10	QPSK	1	25	707.5	23095	737.5	5095	LTE B30	10	2355	9820	LTE B66	20	2145	66786	19.35	19.65	CA 12A-30A-66A	
LTE B30	10	QPSK	1	0	2310	27710	2355	9820	LTE B12	10	737.5	5095	LTE B66	20	2145	66786	16.09	16.30	CA 12A-30A-66A	
LTE B66	20	QPSK	1	0	1770	132572	2170	67036	LTE B12	10	737.5	5095	LTE B30	10	2355	9820	16.53	16.58	CA 12A-30A-66A	
LTE B2	20	QPSK	1	0	1900	19100	1980	1100	LTE B66	20	2120	66536	LTE B66	20	2170	67036	15.75	15.94	CA 2A-66A-66A	
LTE B66	20	QPSK	1	0	1720	132072	2120	66536	LTE B66	20	2170	67036	LTE B2	20	1960	900	16.45	16.51	CA 2A-66A-66A	
LTE B66	20	QPSK	1	0	1770	132572	2170	67036	LTE B66	20	2120	66536	LTE B2	20	1960	900	16.52	16.58	CA 2A-66A-66A	
LTE B5	10	QPSK	1	0	829	20450	874	2450	LTE B66	20	2120	66536	LTE B66	20	2170	67036	19.53	19.68	CA 5A-66A-66A	
LTE B66	20	QPSK	1	0	1720	132072	2120	66536	LTE B66	20	2170	67036	LTE B5	10	881.5	2525	16.44	16.51	CA 5A-66A-66A	
LTE B66	20	QPSK	1	0	1770	132572	2170	67036	LTE B66	20	2120	66536	LTE B66	20	2170	67036	16.52	16.58	CA 5A-66A-66A	
LTE B12	10	QPSK	1	25	707.5	23095	737.5	5095	LTE B66	20	2120	66536	LTE B66	20	2170	67036	19.54	19.65	CA 12A-66A-66A	
LTE B66	20	QPSK	1	0	1720	132072	2120	66536	LTE B66	20	2170	67036	LTE B12	10	737.5	5095	16.44	16.51	CA 12A-66A-66A	
LTE B66	20	QPSK	1	0	1770	132572	2170	67036	LTE B66	20	2120	66536	LTE B12	10	737.5	5095	16.53	16.58	CA 12A-66A-66A	
LTE B13	10	QPSK	1	0	782	23230	751	5230	LTE B66	20	2120	66536	LTE B66	20	2170	67036	19.36	19.52	CA 13A-66A-66A	
LTE B66	20	QPSK	1	0	1720	132072	2120	66536	LTE B66	20	2170	67036	LTE B13	10	751	5230	16.45	16.51	CA 13A-66A-66A	
LTE B66	20	QPSK	1	0	1770	132572	2170	67036	LTE B66	20	2120	66536	LTE B13	10	751	5230	16.50	16.58	CA 13A-66A-66A	
LTE B30	10	QPSK	1	0	2310	27710	2355	9820	LTE B66	20	2120	66536	LTE B66	20	2170	67036	16.30	16.30	CA 2A-29A-30A	
LTE B66	20	QPSK	1	0	1720	132072	2120	66536	LTE B66	20	2170	67036	LTE B30	10	2355	9820	16.45	16.51	CA 30A-66A-66A	
LTE B66	20	QPSK	1	0	1770	132572	2170	67036	LTE B66	20	2120	66536	LTE B30	10	2355	9820	16.52	16.58	CA 30A-66A-66A	
LTE B2	20	QPSK	1	0	1900	19100	1980	1100	LTE B2	20	1940	700	LTE B5	10	881.5	2525	15.83	15.94	CA 2A-2A-5A	
LTE B2	20	QPSK	1	99	1900	19100	1980	1100	LTE B2	20	1940	700	LTE B5	10	881.5	2525	15.66	15.94	CA 2A-2A-5A	
LTE B5	10	QPSK	1	0	829	20450	874	2450	LTE B2	20	1940	700	LTE B2	20	1980	1100	19.57	19.68	CA 2A-2A-5A	
LTE B2	20	QPSK	1	0	1900	19100	1980	1100	LTE B2	20	1980	1100	LTE B12	10	737.5	5095	15.78	15.94	CA 2A-2A-12A	
LTE B2	20	QPSK	1	99	1900	19100	1980	1100	LTE B2	20	1940	700	LTE B12	10	737.5	5095	15.65	15.94	CA 2A-2A-12A	
LTE B12	10	QPSK	1	25	707.5	23095	737.5	5095	LTE B2	20	1940	700	LTE B2	20	1980	1100	19.55	19.65	CA 2A-2A-12A	
LTE B2	20	QPSK	1	0	1900	19100	1980	1100	LTE B2	20	1980	1100	LTE B13	10	751	5230	15.65	15.94	CA 2A-2A-13A	
LTE B2	20	QPSK	1	99	1900	19100	1980	1100	LTE B2	20	1940	700	LTE B13	10	751	5230	15.71	15.94	CA 2A-2A-13A	
LTE B13	10	QPSK	1	0	782	23230	751	5230	LTE B2	20	1940	700	LTE B2	20	1980	1100	19.36	19.52	CA 2A-2A-13A	
LTE B2	20	QPSK	1	0	1900	19100	1980	1100	LTE B2	20	1980	1100	LTE B30	10	2355	9820	15.76	15.94	CA 2A-2A-30A	
LTE B2	20	QPSK	1	99	1900	19100	1980	1100	LTE B2	20	1940	700	LTE B30	10	2355	9820	15.79	15.94	CA 2A-2A-30A	
LTE B30	10	QPSK	1																	

Note:

- 1) For the inter-band CA combinations, except B29 can't be PCC, all the listed bands above can be used as PCC or SCC.
- 2) The channel spacing and aggregated channel bandwidth for CA are identical to the associated specification in 3GPP TS 36.521-1 V16.2.1.
- 3) The reference test frequencies for CA refers to 3GPP TS 36.508 V16.2.0
- 4) Testing is not required in bands or modes not intended/allowed for US operation
- 5) Based on TCB workshop April 2018, only indicate "No" in CA combination table need power measurement

Unless otherwise stated the results shown in this test report refer only to the sample(s) tested and such sample(s) are retained for 90 days only.
除非另有說明，此報告結果僅對測試之樣品負責，同時此樣品僅保留90天。本報告未經本公司書面許可，不可部份複製。

This document is issued by the Company subject to its General Conditions of Service printed overleaf, available on request or accessible at www.sgs.com/terms_and_conditions.htm and for electronic format documents, subject to Terms and Conditions for Electronic Documents at www.sgs.com/terms_e-document.htm. Attention is drawn to the limitation of liability, indemnification and jurisdiction issues defined therein. Any holder of this document is advised that information contained hereon reflects the Company's findings at the time of its intervention only and within the limits of Client's instructions, if any. The Company's sole responsibility is to its Client and this document does not exonerate parties to a transaction from exercising all their rights and obligations under the transaction documents. This document cannot be reproduced except in full, without prior written approval of the Company. Any unauthorized alteration, forgery or falsification of the content or appearance of this document is unlawful and offenders may be prosecuted to the fullest extent of the law.

1.4 Test Environment

Ambient Temperature: 22±2° C
Tissue Simulating Liquid: 22±2° C

1.5 Operation Description

For WWAN, the EUT is controlled by using a Radio Communication Tester, and the communication between the EUT and the tester is established by air link. For WLAN, using chipset specific software to control the EUT, and makes it transmit in maximum power. The EUT is set to maximum power level during all tests, and at the beginning of each test the battery is fully charged. The device is a tablet computer with capacitive proximity sensors for power reduction. Proximity sensors are collocated with WWAN antenna, WLAN TX1 antenna, and WLAN TX2 antenna individually. Also, WLAN TX1 and TX2 will be full power or reduced power at the same time when operating in WLAN only mode and WWAN + WLAN mode. Besides, there are the following combination scenarios need to be considered. In the case, we used -1 and -2 to be the power level difference.

Transmission mode	WWAN sensor	WLAN TX1 sensor	WLAN TX2 sensor	WWAN power	WLAN TX1 power	WLAN TX2 power
WLAN only	-	Inactive	Inactive	-	Full-1	Full-1
	-	Inactive	Active	-	Reduce-1	Reduce-1
	-	Active	Inactive	-	Reduce-1	Reduce-1
	-	Active	Active	-	Reduce-1	Reduce-1
WWAN only	Inactive	-	-	Full	-	-
	Active	-	-	Reduced	-	-
WWAN + WLAN	Inactive	Inactive	Inactive	Full	Full-2	Full-2
	Inactive	Inactive	active	Full	Reduce-2	Reduce-2
	Inactive	active	Inactive	Full	Reduce-2	Reduce-2
	Inactive	active	active	Full	Reduce-2	Reduce-2
	active	Inactive	Inactive	Reduced	Full-2	Full-2
	active	Inactive	active	Reduced	Reduce-2	Reduce-2
	active	active	Inactive	Reduced	Reduce-2	Reduce-2
	active	active	active	Reduced	Reduce-2	Reduce-2

Unless otherwise stated the results shown in this test report refer only to the sample(s) tested and such sample(s) are retained for 90 days only.
除非另有說明，此報告結果僅對測試之樣品負責，同時此樣品僅保留90天。本報告未經本公司書面許可，不可部份複製。

This document is issued by the Company subject to its General Conditions of Service printed overleaf, available on request or accessible at www.sgs.com/terms_and_conditions.htm and for electronic format documents, subject to Terms and Conditions for Electronic Documents at www.sgs.com/terms_e-document.htm. Attention is drawn to the limitation of liability, indemnification and jurisdiction issues defined therein. Any holder of this document is advised that information contained hereon reflects the Company's findings at the time of its intervention only and within the limits of Client's instructions, if any. The Company's sole responsibility is to its Client and this document does not exonerate parties to a transaction from exercising all their rights and obligations under the transaction documents. This document cannot be reproduced except in full, without prior written approval of the Company. Any unauthorized alteration, forgery or falsification of the content or appearance of this document is unlawful and offenders may be prosecuted to the fullest extent of the law.

Transmission mode: WLAN only**WLAN TX1_full power**

Backside_0mm, top side_4mm, bottom side/right side/left side_0mm.

WLAN TX1_reduced power

Backside_0mm, top side_0mm.

WLAN TX2_full power

Backside_4mm, top side_9mm, bottom side/right side/left side_0mm.

WLAN TX2_reduced power

Backside_0mm, top side_0mm.

Transmission mode: WWAN only**WWAN TX_full power**

Backside_16mm, top side_19mm, bottom side/right side/left side_0mm.

WWAN TX_reduced power

Backside_0mm, top side_0mm.

Unless otherwise stated the results shown in this test report refer only to the sample(s) tested and such sample(s) are retained for 90 days only.

除非另有說明，此報告結果僅對測試之樣品負責，同時此樣品僅保留90天。本報告未經本公司書面許可，不可部份複製。

This document is issued by the Company subject to its General Conditions of Service printed overleaf, available on request or accessible at www.sgs.com/terms_and_conditions.htm and for electronic format documents, subject to Terms and Conditions for Electronic Documents at www.sgs.com/terms_e-document.htm. Attention is drawn to the limitation of liability, indemnification and jurisdiction issues defined therein. Any holder of this document is advised that information contained hereon reflects the Company's findings at the time of its intervention only and within the limits of Client's instructions, if any. The Company's sole responsibility is to its Client and this document does not exonerate parties to a transaction from exercising all their rights and obligations under the transaction documents. This document cannot be reproduced except in full, without prior written approval of the Company. Any unauthorized alteration, forgery or falsification of the content or appearance of this document is unlawful and offenders may be prosecuted to the fullest extent of the law.

Transmission mode: WWAN + WLAN

WWAN full/reduced power level is the same between WWAN only mode and WWAN + WLAN mode, so testing WWAN one time is sufficient.

WLAN TX1_full power

Backside_0mm, top side_4mm, bottom side/right side/left side_0mm.

WLAN TX1_reduced power

Backside_0mm, top side_0mm.

WLAN TX2_full power

Backside_4mm, top side_9mm, bottom side/right side/left side_0mm.

WLAN TX2_reduced power

Backside_0mm, top side_0mm.

Note:

1. During the SAR testing, the DASY 5 system checks power drift by comparing the e-field strength of one specific location measured at the beginning with that measured at the end of the SAR testing.
2. The 3G SAR test reduction procedure is applied to HSDPA with 12.2 kbps RMC as the primary mode. Since the maximum output power in a secondary mode (HSDPA) is $\leq \frac{1}{4}$ dB higher than the primary mode (WCDMA), SAR measurement is not required for the secondary mode (HSDPA). The following 4 sub-tests were completed according to Release 5 procedures in section 5.2 of 3GPP TS 34.121. A summary of these setting are illustrated below:

Sub-test	β_c	β_d	β_d (SF)	β_c/β_d	$\beta_{HS}^{(1)(2)}$	CM ⁽³⁾ (dB)	MPR ⁽³⁾ (dB)
1	2/15	15/15	64	2/15	4/15	0.0	0.0
2	12/15 ⁽⁴⁾	15/15 ⁽⁴⁾	64	12/15 ⁽⁴⁾	24/15	1.0	0.0
3	15/15	8/15	64	15/8	30/15	1.5	0.5
4	15/15	4/15	64	15/4	30/15	1.5	0.5

Note 1: Δ_{ACK} , Δ_{NACK} and $\Delta_{CCI} = 30/15$ with $\beta_{HS} = 30/15 * \beta_c$.
 Note 2: For the HS-DPCCH power mask requirement test in clause 5.2C, 5.7A, and the Error Vector Magnitude (EVM) with HS-DPCCH test in clause 5.13.1A, and HSDPA EVM with phase discontinuity in clause 5.13.1AA, Δ_{ACK} and $\Delta_{NACK} = 30/15$ with $\beta_{HS} = 30/15 * \beta_c$, and $\Delta_{CCI} = 24/15$ with $\beta_{HS} = 24/15 * \beta_c$.
 Note 3: CM = 1 for $\beta_c/\beta_d = 12/15$, $\beta_{HS}/\beta_c = 24/15$. For all other combinations of DPDCCH, DPCCH and HS-DPCCH the MPR is based on the relative CM difference. This is applicable for only UEs that support HSDPA in release 6 and later releases.
 Note 4: For subtest 2 the β_c/β_d ratio of 12/15 for the TFC during the measurement period (TF1, TF0) is achieved by setting the signalled gain factors for the reference TFC (TF1, TF1) to $\beta_c = 11/15$ and $\beta_d = 15/15$.

Unless otherwise stated the results shown in this test report refer only to the sample(s) tested and such sample(s) are retained for 90 days only.

除非另有說明，此報告結果僅對測試之樣品負責，同時此樣品僅保留90天。本報告未經本公司書面許可，不可部份複製。

This document is issued by the Company subject to its General Conditions of Service printed overleaf, available on request or accessible at www.sgs.com/terms_and_conditions.htm and for electronic format documents, subject to Terms and Conditions for Electronic Documents at www.sgs.com/terms_e-document.htm. Attention is drawn to the limitation of liability, indemnification and jurisdiction issues defined therein. Any holder of this document is advised that information contained hereon reflects the Company's findings at the time of its intervention only and within the limits of Client's instructions, if any. The Company's sole responsibility is to its Client and this document does not exonerate parties to a transaction from exercising all their rights and obligations under the transaction documents. This document cannot be reproduced except in full, without prior written approval of the Company. Any unauthorized alteration, forgery or falsification of the content or appearance of this document is unlawful and offenders may be prosecuted to the fullest extent of the law.

3. The 3G SAR test reduction procedure is applied to HSPA (HSUPA/HSDPA with RMC) with 12.2 kbps RMC as the primary mode. Since the maximum output power in a secondary mode (HSPA) is $\leq \frac{1}{4}$ dB higher than the primary mode (WCDMA), SAR measurement is not required for the secondary mode (HSPA). The following 5 sub-tests were completed according to Release 6 procedures in section 5.2 of 3GPP TS 34.121. A summary of these setting are illustrated below:

Sub-test	β_c	β_d	β_d (SF)	β_c / β_d	$\beta_{HS}^{(1)}$	β_{ec}	$\beta_{ed}^{(4)(5)}$	β_{ed} (SF)	β_{ed} (Codes)	CM ⁽²⁾ (dB)	MPR ⁽²⁾⁽⁶⁾ (dB)	AG ⁽⁶⁾ Index	E-TFCI
1	11/15 ⁽³⁾	15/15 ⁽³⁾	64	11/15 ⁽³⁾	22/15	209/225	1309/225	4	1	1.0	0.0	20	75
2	6/15	15/15	64	6/15	12/15	12/15	94/75	4	1	3.0	2.0	12	67
3	15/15	9/15	64	15/9	30/15	30/15	$\beta_{ed1}: 47/15$ $\beta_{ed2}: 47/15$	4	2	2.0	1.0	15	92
4	2/15	15/15	64	2/15	4/15	2/15	56/75	4	1	3.0	2.0	17	71
5	15/15	0	-	-	5/15	5/15	47/15	4	1	1.0	0.0	12	67

Note 1: For sub-test 1 to 4, Δ_{ACK} , Δ_{NACK} and $\Delta_{CQI} = 30/15$ with $\beta_{HS} = 30/15 * \beta_c$. For sub-test 5, Δ_{ACK} , Δ_{NACK} and $\Delta_{CQI} = 5/15$ with $\beta_{HS} = 5/15 * \beta_c$.
 Note 2: CM = 1 for $\beta_c/\beta_d = 12/15$, $\beta_{HS}/\beta_c = 24/15$. For all other combinations of DPDCH, DPCCH, HS-DPCCH, E-DPDCH and E-DPCCH the MPR is based on the relative CM difference.
 Note 3: For subtest 1 the β_c/β_d ratio of 11/15 for the TFC during the measurement period (TF1, TF0) is achieved by setting the signalled gain factors for the reference TFC (TF1, TF1) to $\beta_c = 10/15$ and $\beta_d = 15/15$.
 Note 4: In case of testing by UE using E-DPDCH Physical Layer category 1, Sub-test 3 is omitted according to TS25.306 Table 5.1g.
 Note 5: β_{ed} can not be set directly; it is set by Absolute Grant Value.
 Note 6: For subtests 2, 3 and 4, UE may perform E-DPDCH power scaling at max power which could results in slightly smaller MPR values.

Unless otherwise stated the results shown in this test report refer only to the sample(s) tested and such sample(s) are retained for 90 days only.

除非另有說明，此報告結果僅對測試之樣品負責，同時此樣品僅保留90天。本報告未經本公司書面許可，不可部份複製。

This document is issued by the Company subject to its General Conditions of Service printed overleaf, available on request or accessible at www.sgs.com/terms_and_conditions.htm and for electronic format documents, subject to Terms and Conditions for Electronic Documents at www.sgs.com/terms_e-document.htm. Attention is drawn to the limitation of liability, indemnification and jurisdiction issues defined therein. Any holder of this document is advised that information contained hereon reflects the Company's findings at the time of its intervention only and within the limits of Client's instructions, if any. The Company's sole responsibility is to its Client and this document does not exonerate parties to a transaction from exercising all their rights and obligations under the transaction documents. This document cannot be reproduced except in full, without prior written approval of the Company. Any unauthorized alteration, forgery or falsification of the content or appearance of this document is unlawful and offenders may be prosecuted to the fullest extent of the law.

4. LTE modes test according to **KDB 941225D05v02r05**.
- a. Per Section 5.2.1, the largest channel bandwidth and measure SAR for QPSK with 1 RB allocation.
- Using the RB offset and required test channel combination with the highest maximum output power for RB offsets at the upper edge, middle and lower edge of each required test channel.
 - When the reported SAR is ≤ 0.8 W/kg, testing of the remaining RB offset configurations and required test channels is not required for 1 RB allocation; otherwise, SAR is required for the remaining required test channels and only for the RB offset configuration with the highest output power for that channel.
 - When the reported SAR of a required test channel is > 1.45 W/kg, SAR is required for all three RB offset configurations for that required test channel.
- b. Per Section 5.2.2, the largest channel bandwidth and measure SAR for QPSK with 50% RB allocation
- The procedures required for 1 RB allocation in 5.2.1 are applied to measure the SAR for QPSK with 50% RB allocation.
- c. Per Section 5.2.3, the largest channel bandwidth and measure SAR for QPSK with 100% RB allocation
- For QPSK with 100% RB allocation, SAR is not required when the highest maximum output power for 100 % RB allocation is less than the highest maximum output power in 50% and 1 RB allocations and the highest reported SAR for 1 RB and 50% RB allocation in 5.2.1 and 5.2.2 are ≤ 0.8 W/kg.
 - Otherwise, SAR is measured for the highest output power channel and if the reported SAR is > 1.45 W/kg, the remaining required test channels must also be tested.
- d. Per Section 5.2.4, Higher order modulations
- For each modulation besides QPSK; e.g., 16-QAM, 64-QAM, apply the QPSK procedures in sections 5.2.1, 5.2.2 and 5.2.3 to determine the QAM configurations that may need SAR measurement. For each configuration identified as required for testing, SAR is required only when the highest maximum output power for the configuration in the higher order modulation is $> \frac{1}{2}$ dB higher than the same configuration in QPSK or when the reported SAR for the QPSK configuration is > 1.45 W/kg.
- e. Per Section 5.3, other channel bandwidth standalone SAR test requirements

Unless otherwise stated the results shown in this test report refer only to the sample(s) tested and such sample(s) are retained for 90 days only.
除非另有說明，此報告結果僅對測試之樣品負責，同時此樣品僅保留90天。本報告未經本公司書面許可，不可部份複製。

This document is issued by the Company subject to its General Conditions of Service printed overleaf, available on request or accessible at www.sgs.com/terms_and_conditions.htm and for electronic format documents, subject to Terms and Conditions for Electronic Documents at www.sgs.com/terms_e-document.htm. Attention is drawn to the limitation of liability, indemnification and jurisdiction issues defined therein. Any holder of this document is advised that information contained hereon reflects the Company's findings at the time of its intervention only and within the limits of Client's instructions, if any. The Company's sole responsibility is to its Client and this document does not exonerate parties to a transaction from exercising all their rights and obligations under the transaction documents. This document cannot be reproduced except in full, without prior written approval of the Company. Any unauthorized alteration, forgery or falsification of the content or appearance of this document is unlawful and offenders may be prosecuted to the fullest extent of the law.

- For the other channel bandwidths used by the device in a frequency band, apply all the procedures required for the largest channel bandwidth in section 5.2 to determine the channels and RB configurations that need SAR testing and only measure SAR when the highest maximum output power of a configuration requiring testing in the smaller channel bandwidth is $> \frac{1}{2}$ dB higher than the equivalent channel configurations in the largest channel bandwidth configuration or the reported SAR of a configuration for the largest channel bandwidth is > 1.45 W/kg. The equivalent channel configuration for the RB allocation, RB offset and modulation etc. is determined for the smaller channel bandwidth according to the same number of RB allocated in the largest channel bandwidth.
- TDD LTE was tested at highest duty factor using UL-DL configuration 0 with 6 UL subframes and 2 S subframes using extended cyclic prefix only and special subframe configuration 7. SAR tests were performed at maximum output power and worst-case transmission duty factor in extended cyclic prefix. Per 3GPP 36.211 Section 4, the duty factor for special subframe configuration 6 using extended cyclic prefix is 0.633.

According to KDB 941225 D05, SAR testing for TDD LTE must be tested using a fixed periodic duty factor according to the highest transmission duty factor implemented for the device and supported by the defined 3GPP TDD LTE configurations. The TDD-LTE of this device supports frame structure type 2 defined in 3GPP TS 36.211 section 4.2, and the frame structure configuration can be tabulated as below.

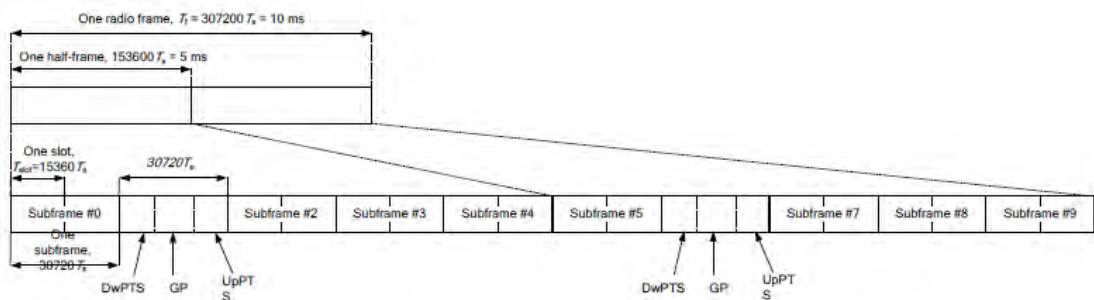

3GPP TS 36.211 Figure 4.2-1: Frame Structure Type 2

Unless otherwise stated the results shown in this test report refer only to the sample(s) tested and such sample(s) are retained for 90 days only.
除非另有說明，此報告結果僅對測試之樣品負責，同時此樣品僅保留90天。本報告未經本公司書面許可，不可部份複製。

This document is issued by the Company subject to its General Conditions of Service printed overleaf, available on request or accessible at www.sgs.com/terms_and_conditions.htm and for electronic format documents, subject to Terms and Conditions for Electronic Documents at www.sgs.com/terms_e-document.htm. Attention is drawn to the limitation of liability, indemnification and jurisdiction issues defined therein. Any holder of this document is advised that information contained hereon reflects the Company's findings at the time of its intervention only and within the limits of Client's instructions, if any. The Company's sole responsibility is to its Client and this document does not exonerate parties to a transaction from exercising all their rights and obligations under the transaction documents. This document cannot be reproduced except in full, without prior written approval of the Company. Any unauthorized alteration, forgery or falsification of the content or appearance of this document is unlawful and offenders may be prosecuted to the fullest extent of the law.

Special Subframe Configuration	Normal Cyclic Prefix in Downlink			Extended Cyclic Prefix in Downlink		
	DwPTS	UpPTS		DwPTS	UpPTS	
		Normal Cyclic Prefix in Uplink	Extended Cyclic Prefix in Uplink		Normal Cyclic Prefix in Uplink	Extended Cyclic Prefix in Uplink
0	6592 · Ts	2192 · Ts	2560 · Ts	7680 · Ts	2192 · Ts	2560 · Ts
1	19760 · Ts			20480 · Ts		
2	21952 · Ts			23040 · Ts		
3	24144 · Ts			25600 · Ts		
4	26336 · Ts	4384 · Ts	5120 · Ts	7680 · Ts	4384 · Ts	5120 · Ts
5	6592 · Ts			20480 · Ts		
6	19760 · Ts			23040 · Ts		
7	21952 · Ts			12800 · Ts		
8	24144 · Ts			-		
9	13168 · Ts	-	-	-	-	-

3GPP TS 36.211 Table 4.2-1: Configuration of Special Subframe

Uplink-Downlink Configuration	Downlink-to-Uplink Switch-Point Periodicity	Subframe Number										
		0	1	2	3	4	5	6	7	8	9	
0	5 ms	D	S	U	U	U	D	S	U	U	U	
1	5 ms	D	S	U	U	D	D	S	U	U	D	
2	5 ms	D	S	U	D	D	D	S	U	D	D	
3	10 ms	D	S	U	U	U	D	D	D	D	D	
4	10 ms	D	S	U	U	D	D	D	D	D	D	
5	10 ms	D	S	U	D	D	D	D	D	D	D	
6	5 ms	D	S	U	U	U	D	S	U	U	D	

3GPP TS 36.211 Table 4.2-2: Uplink-Downlink Configurations

The uplink duty cycle of these seven configurations can be computed as below.

UL-DL Configuration	0	1	2	3	4	5	6
Highest Duty-Cycle	63.33%	43.33%	23.33%	31.67%	21.67%	11.67%	53.33%

Considering the highest transmission duty cycle, TDD LTE was tested using Uplink-Downlink configuration 0 with 6 uplink subframe and 2 special subframe. The special subframe was set to special subframe configuration 7 using extended cyclic prefix uplink. Therefore, SAR testing for TDD LTE was measured at the maximum output power with highest transmission duty cycle of 63.33%.

LTE downlink CA (KDB942225 D05A)

- LTE downlink CA (KDB942225 D05A): The device supports a maximum of 3 carriers in the downlink. All uplink communications are identical to the Release 8 specifications. Uplink maximum output power is measured with downlink carrier aggregation active, only for the channel with highest measured maximum output power when downlink carrier aggregation is inactive, to confirm that when downlink carrier aggregation is active uplink maximum output power remains within the specified tune-up tolerance limits and not more than ¼ dB higher than the maximum output power measured when downlink carrier aggregation inactive.
- The downlink channels selected to perform the uplink power measurement must satisfy 3GPP channel spacing (5.4.1A of 3GPP TS 36.521 or equivalent) and

Unless otherwise stated the results shown in this test report refer only to the sample(s) tested and such sample(s) are retained for 90 days only.

除非另有說明，此報告結果僅對測試之樣品負責，同時此樣品僅保留90天。本報告未經本公司書面許可，不可部份複製。

This document is issued by the Company subject to its General Conditions of Service printed overleaf, available on request or accessible at www.sgs.com/terms_and_conditions.htm and for electronic format documents, subject to Terms and Conditions for Electronic Documents at www.sgs.com/terms_e-document.htm. Attention is drawn to the limitation of liability, indemnification and jurisdiction issues defined therein. Any holder of this document is advised that information contained hereon reflects the Company's findings at the time of its intervention only and within the limits of Client's instructions, if any. The Company's sole responsibility is to its Client and this document does not exonerate parties to a transaction from exercising all their rights and obligations under the transaction documents. This document cannot be reproduced except in full, without prior written approval of the Company. Any unauthorized alteration, forgery or falsification of the content or appearance of this document is unlawful and offenders may be prosecuted to the fullest extent of the law.

channel bandwidth (5.4.2A) requirements. The nominal channel spacing is determined by $[BW1 + BW2 - 0.1 \cdot |BW1 - BW2|] / 2$ MHz, where BW1 and BW2 are the channel bandwidths of the CC in a 2-CC aggregation configuration.

7. The downlink PCC channel should be paired with the uplink channel according to normal configurations, as if there is no carrier aggregation. The downlink SCC should be adjacent to the PCC and remain within the downlink transmission band for contiguous intra-band CA. For non-contiguous intra-band CA, the SCC should be selected to provide maximum separation from the PCC and must remain fully within the downlink transmission band. For inter-band CA, the SCC should be near the middle of its transmission band.
8. When downlink carrier aggregation is active uplink maximum output power remains within the specified tune-up tolerance limits and not more than $\frac{1}{4}$ dB higher than the maximum output power measured when downlink carrier aggregation inactive, so SAR evaluation is not required for downlink carrier aggregation.
9. 802.11b DSSS SAR Test Requirements: SAR is measured for 2.4 GHz 802.11b DSSS mode using the highest measured maximum output power channel, when the reported SAR of the highest measured maximum output power channel for the exposure configuration is ≤ 0.8 W/kg, no further SAR testing is required for 802.11b DSSS in that exposure configuration.
10. When the reported SAR is > 0.8 W/kg, SAR is required for that exposure configuration using the next highest measured output power channel. When any reported SAR is > 1.2 W/kg, SAR is required for the third channel; i.e., all channels require testing.

802.11g/n OFDM SAR Test Exclusion Requirements:

11. SAR is not required for 802.11g/n when the highest reported SAR for DSSS is adjusted by the ratio of OFDM to DSSS specified maximum output power and the adjusted SAR is ≤ 1.2 W/kg.

Unless otherwise stated the results shown in this test report refer only to the sample(s) tested and such sample(s) are retained for 90 days only.
除非另有說明，此報告結果僅對測試之樣品負責，同時此樣品僅保留90天。本報告未經本公司書面許可，不可部份複製。

This document is issued by the Company subject to its General Conditions of Service printed overleaf, available on request or accessible at www.sgs.com/terms_and_conditions.htm and for electronic format documents, subject to Terms and Conditions for Electronic Documents at www.sgs.com/terms_e-document.htm. Attention is drawn to the limitation of liability, indemnification and jurisdiction issues defined therein. Any holder of this document is advised that information contained hereon reflects the Company's findings at the time of its intervention only and within the limits of Client's instructions, if any. The Company's sole responsibility is to its Client and this document does not exonerate parties to a transaction from exercising all their rights and obligations under the transaction documents. This document cannot be reproduced except in full, without prior written approval of the Company. Any unauthorized alteration, forgery or falsification of the content or appearance of this document is unlawful and offenders may be prosecuted to the fullest extent of the law.

Initial Test Configuration:

12. An initial test configuration is determined for OFDM transmission modes according to the channel bandwidth, modulation and data rate combination(s) with the highest maximum output power specified for production units in each standalone and aggregated frequency band.
13. SAR is measured using the highest measured maximum output power channel. When the reported SAR of the initial test configuration is > 0.8 W/kg, SAR measurement is required for the subsequent next highest measured output power channel(s) in the initial test configuration until the reported SAR is ≤ 1.2 W/kg or all required channels are tested.
14. Since the highest reported SAR for the initial test configuration is adjusted by the ratio of the subsequent test configuration to initial test configuration specified maximum output power and the adjusted SAR is ≤ 1.2 W/kg, SAR is not required for subsequent test configuration.
15. BT and WLAN Tx2 use the same antenna path, but they can't transmit at the same time.
16. According to KDB447498 D01, testing of other required channels is not required when the reported 1-g SAR for the highest output channel is ≤ 0.8 W/kg, when the transmission band is ≤ 100 MHz.
17. According to KDB865664 D01, SAR measurement variability must be assessed for each frequency band. When the original highest measured SAR is ≥ 0.8 W/kg, repeated that measurement once. Perform a second repeated measurement only if the ratio of largest to smallest SAR for the original and first repeated measurements is > 1.20 or when the original or repeated measurement is ≥ 1.45 W/kg (~10% from the 1-g SAR limit)
18. Based on FCC guidance, general principles of KDB248227D01 can be applied to 802.11ax to determine initial test configuration with 802.11ax being considered as the highest 802.11 mode for the appropriate frequency band.
19. For 2.4/5GHz WLAN TX1 and TX2 antennas, the maximum output power of each antenna during simultaneous transmission (whatever full or reduced power) is the same with that used in standalone transmission, and we used the sum and/or SPLSR of standalone 1-g SAR provision in KDB447498D01 to exclude the simultaneous transmitted SAR measurement.
20. According to April 2015 TCB workshop, SAR test exclusion can be applied for testing overlapping LTE bands as follows:
 - a) The maximum output power, including tolerance, for the smaller band must be \leq the larger band to qualify for the SAR test exclusion.

Unless otherwise stated the results shown in this test report refer only to the sample(s) tested and such sample(s) are retained for 90 days only.
除非另有說明，此報告結果僅對測試之樣品負責，同時此樣品僅保留90天。本報告未經本公司書面許可，不可部份複製。

This document is issued by the Company subject to its General Conditions of Service printed overleaf, available on request or accessible at www.sgs.com/terms_and_conditions.htm and for electronic format documents, subject to Terms and Conditions for Electronic Documents at www.sgs.com/terms_e-document.htm. Attention is drawn to the limitation of liability, indemnification and jurisdiction issues defined therein. Any holder of this document is advised that information contained hereon reflects the Company's findings at the time of its intervention only and within the limits of Client's instructions, if any. The Company's sole responsibility is to its Client and this document does not exonerate parties to a transaction from exercising all their rights and obligations under the transaction documents. This document cannot be reproduced except in full, without prior written approval of the Company. Any unauthorized alteration, forgery or falsification of the content or appearance of this document is unlawful and offenders may be prosecuted to the fullest extent of the law.

b) The channel bandwidth and other operating parameters for the smaller band must be fully supported by the larger band.

LTE Band 2 (1850-1910 MHz) is covered by LTE Band 25 (1850-1915 MHz)

LTE Band 4 (1710-1755 MHz) is covered by LTE Band 66 (1710-1780 MHz)

LTE Band 38 (2570-2620 MHz) is covered by LTE Band 41 (2496-2690 MHz)

c) Hence, LTE Band 2/4/38 SAR can be excluded from testing.

Unless otherwise stated the results shown in this test report refer only to the sample(s) tested and such sample(s) are retained for 90 days only.

除非另有說明，此報告結果僅對測試之樣品負責，同時此樣品僅保留90天。本報告未經本公司書面許可，不可部份複製。

This document is issued by the Company subject to its General Conditions of Service printed overleaf, available on request or accessible at www.sgs.com/terms_and_conditions.htm and for electronic format documents, subject to Terms and Conditions for Electronic Documents at www.sgs.com/terms_e-document.htm. Attention is drawn to the limitation of liability, indemnification and jurisdiction issues defined therein. Any holder of this document is advised that information contained hereon reflects the Company's findings at the time of its intervention only and within the limits of Client's instructions, if any. The Company's sole responsibility is to its Client and this document does not exonerate parties to a transaction from exercising all their rights and obligations under the transaction documents. This document cannot be reproduced except in full, without prior written approval of the Company. Any unauthorized alteration, forgery or falsification of the content or appearance of this document is unlawful and offenders may be prosecuted to the fullest extent of the law.

1.6 Proximity sensor operation description

The P-sensor being used to reduce output power is capacitive in which when the object such as human body, metal or plastic is being approached, the sensing capacitance would be increased with the antenna pad. Once the capacitance is accumulated, and reached over the threshold as set in MCU of the microchip, the interruption signal is pulled low (High state without trigger) and further inform modem module of the transmitter to make power reduction.

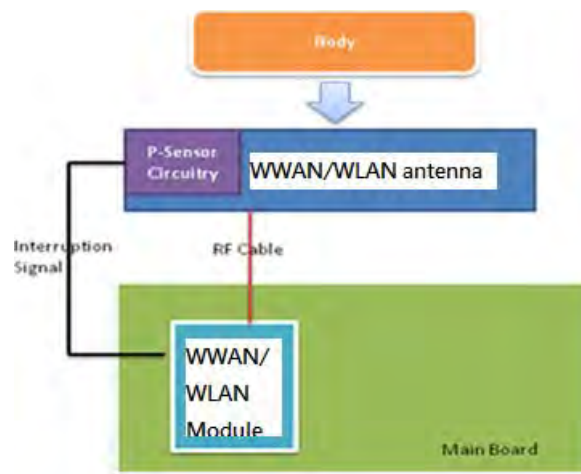

Unless otherwise stated the results shown in this test report refer only to the sample(s) tested and such sample(s) are retained for 90 days only.

除非另有說明，此報告結果僅對測試之樣品負責，同時此樣品僅保留90天。本報告未經本公司書面許可，不可部份複製。

This document is issued by the Company subject to its General Conditions of Service printed overleaf, available on request or accessible at www.sgs.com/terms_and_conditions.htm and for electronic format documents, subject to Terms and Conditions for Electronic Documents at www.sgs.com/terms_e-document.htm. Attention is drawn to the limitation of liability, indemnification and jurisdiction issues defined therein. Any holder of this document is advised that information contained hereon reflects the Company's findings at the time of its intervention only and within the limits of Client's instructions, if any. The Company's sole responsibility is to its Client and this document does not exonerate parties to a transaction from exercising all their rights and obligations under the transaction documents. This document cannot be reproduced except in full, without prior written approval of the Company. Any unauthorized alteration, forgery or falsification of the content or appearance of this document is unlawful and offenders may be prosecuted to the fullest extent of the law.

1.6.1 Proximity sensor measurement procedure

1. The proximity sensors are collocated with WWAN/WLAN antennas.
2. Output power is measured, and monitored by using the base station simulator and power sensor/power meter. A RF cables with sufficient length was being attached from the antenna port of the module, and used for the measurement. The appropriate loss attenuated from cable is compensated in the test setup.



Unless otherwise stated the results shown in this test report refer only to the sample(s) tested and such sample(s) are retained for 90 days only.
除非另有說明，此報告結果僅對測試之樣品負責，同時此樣品僅保留90天。本報告未經本公司書面許可，不可部份複製。

This document is issued by the Company subject to its General Conditions of Service printed overleaf, available on request or accessible at www.sgs.com/terms_and_conditions.htm and for electronic format documents, subject to Terms and Conditions for Electronic Documents at www.sgs.com/terms_e-document.htm. Attention is drawn to the limitation of liability, indemnification and jurisdiction issues defined therein. Any holder of this document is advised that information contained hereon reflects the Company's findings at the time of its intervention only and within the limits of Client's instructions, if any. The Company's sole responsibility is to its Client and this document does not exonerate parties to a transaction from exercising all their rights and obligations under the transaction documents. This document cannot be reproduced except in full, without prior written approval of the Company. Any unauthorized alteration, forgery or falsification of the content or appearance of this document is unlawful and offenders may be prosecuted to the fullest extent of the law.

1.6.2 Trigger distances for back/top side

Test procedure:

1. The entire back surface or edge of the tablet is positioned below a flat phantom filled with the required tissue equivalent medium and positioned at least 20 mm further than the distance that triggers power reduction.
2. The back surface or edge is moved toward the phantom in 3 mm steps until the sensor triggers.
3. The back surface or edge is again moved toward the phantom, but in 1 mm steps, until it is at least 5 mm past the triggering point or touching the phantom
4. If the tablet is not touching the phantom, it is moved in 3 mm steps until it touches the phantom to confirm that the sensor remains triggered and the maximum power stays reduced.
5. The back surface or edge is then moved back (further away) from the phantom until maximum output power is returned to the normal maximum level.
6. The process is then reversed by moving the tablet away from the phantom to determine triggering release, until it is at least 10 mm beyond the point that triggers the return of normal maximum power.
7. The measured output power within ± 5 mm of the triggering points, or until the tablet is touching the phantom, for movements to and from the phantom should be tabulated.

Unless otherwise stated the results shown in this test report refer only to the sample(s) tested and such sample(s) are retained for 90 days only.
除非另有說明，此報告結果僅對測試之樣品負責，同時此樣品僅保留90天。本報告未經本公司書面許可，不可部份複製。

This document is issued by the Company subject to its General Conditions of Service printed overleaf, available on request or accessible at www.sgs.com/terms_and_conditions.htm and for electronic format documents, subject to Terms and Conditions for Electronic Documents at www.sgs.com/terms_e-document.htm. Attention is drawn to the limitation of liability, indemnification and jurisdiction issues defined therein. Any holder of this document is advised that information contained hereon reflects the Company's findings at the time of its intervention only and within the limits of Client's instructions, if any. The Company's sole responsibility is to its Client and this document does not exonerate parties to a transaction from exercising all their rights and obligations under the transaction documents. This document cannot be reproduced except in full, without prior written approval of the Company. Any unauthorized alteration, forgery or falsification of the content or appearance of this document is unlawful and offenders may be prosecuted to the fullest extent of the law.

8. To ensure all production units are compliant, it is generally necessary to reduce the triggering distance determined from the triggering tests by 1 mm, or more if it is necessary, and use the smallest distance for movements to and from the phantom, minus 1 mm, as the sensor triggering distance for determining the SAR measurement distance.
9. For WLAN TX1_back side, the trigger distance of proximity sensor is 5mm. For WLAN TX2_back side, the trigger distance of proximity sensor is 7mm.
10. For WLAN TX1_top side, the trigger distance of proximity sensor is 10mm, For WLAN TX2_top side, the trigger distance of proximity sensor is 5mm and we perform the 1.6.3 tilt angle testing in next step.

Unless otherwise stated the results shown in this test report refer only to the sample(s) tested and such sample(s) are retained for 90 days only.
除非另有說明，此報告結果僅對測試之樣品負責，同時此樣品僅保留90天。本報告未經本公司書面許可，不可部份複製。

This document is issued by the Company subject to its General Conditions of Service printed overleaf, available on request or accessible at www.sgs.com/terms_and_conditions.htm and for electronic format documents, subject to Terms and Conditions for Electronic Documents at www.sgs.com/terms_e-document.htm. Attention is drawn to the limitation of liability, indemnification and jurisdiction issues defined therein. Any holder of this document is advised that information contained hereon reflects the Company's findings at the time of its intervention only and within the limits of Client's instructions, if any. The Company's sole responsibility is to its Client and this document does not exonerate parties to a transaction from exercising all their rights and obligations under the transaction documents. This document cannot be reproduced except in full, without prior written approval of the Company. Any unauthorized alteration, forgery or falsification of the content or appearance of this document is unlawful and offenders may be prosecuted to the fullest extent of the law.

1.6.3 Tilt angle testing

Test procedure:

1. The influence of table tilt angles to proximity sensor triggering is determined by positioning each tablet edge that contains a transmitting antenna, perpendicular to the flat phantom, at the smallest sensor triggering test distance determined in sections 1.6.2 by rotating the tablet around the edge next to the phantom in ≤ 10 deg increments until the tablet is ± 45 deg or more from the vertical position at 0 deg.
2. If sensor triggering is released and normal maximum output power is restored within the ± 45 deg range, the procedures in step 1) should be repeated by reducing the tablet to phantom separation distance by 1 mm until the proximity sensor no longer releases triggering, and maximum output power remains in the reduced mode.
3. The smallest separation distance determined in steps 1) and 2), minus 1 mm, is the sensor triggering distance for tablet tilt coverage. The smallest separation distance determined in sections 1.6.2, 1.6.3 minus 1 mm should be used in the SAR measurements.
4. The influence of tablet tilt angles to proximity sensor triggering is determined by positioning top and right sides, please refer to table 1.6.5 and 1.6.6.
5. After the tilt angle testing for top side on WLAN TX1 and WLAN TX2, the sensor is not released during ± 45 deg, so $10-1=9$ mm for WLAN TX1 and $5-1=4$ mm for WLAN TX2 are used in the SAR measurements of top side.

Unless otherwise stated the results shown in this test report refer only to the sample(s) tested and such sample(s) are retained for 90 days only.
除非另有說明，此報告結果僅對測試之樣品負責，同時此樣品僅保留90天。本報告未經本公司書面許可，不可部份複製。

This document is issued by the Company subject to its General Conditions of Service printed overleaf, available on request or accessible at www.sgs.com/terms_and_conditions.htm and for electronic format documents, subject to Terms and Conditions for Electronic Documents at www.sgs.com/terms_e-document.htm. Attention is drawn to the limitation of liability, indemnification and jurisdiction issues defined therein. Any holder of this document is advised that information contained hereon reflects the Company's findings at the time of its intervention only and within the limits of Client's instructions, if any. The Company's sole responsibility is to its Client and this document does not exonerate parties to a transaction from exercising all their rights and obligations under the transaction documents. This document cannot be reproduced except in full, without prior written approval of the Company. Any unauthorized alteration, forgery or falsification of the content or appearance of this document is unlawful and offenders may be prosecuted to the fullest extent of the law.

1.6.4 Proximity sensor coverage

The following procedures do not apply and are not required for configurations where the antenna and sensor are collocated and the peak SAR location is overlapping with the sensor.

Test procedure:

1. The back surface or edges of the tablet is positioned at a test separation distance less than or equal to the distance required for back surface or edge triggering, with both the antenna and sensor pad located at least 20 mm laterally outside the edge (boundary) of the phantom, along the direction of maximum antenna and sensor offset.
2. The similar sequence of steps applied to determine sensor triggering distance in section 1.6.2 are used to verify back surface and edge sensor coverage by moving the tablet (sensor and antenna) horizontally toward the phantom while maintaining the same vertical separation between the back surface or edge and the phantom.
3. After the exact location where triggering of power reduction is determined, with respect to the sensor and antenna, the tablet movement should be continued, in 3 mm increments, until both the sensor and antenna(s) are fully under the phantom and at least 20 mm inside the phantom edge.
4. The process is then repeated from the other direction, at the opposite end of maximum antenna and sensor offset, by rotating the tablet 180 degrees.

Unless otherwise stated the results shown in this test report refer only to the sample(s) tested and such sample(s) are retained for 90 days only.
除非另有說明，此報告結果僅對測試之樣品負責，同時此樣品僅保留90天。本報告未經本公司書面許可，不可部份複製。

This document is issued by the Company subject to its General Conditions of Service printed overleaf, available on request or accessible at www.sgs.com/terms_and_conditions.htm and for electronic format documents, subject to Terms and Conditions for Electronic Documents at www.sgs.com/terms_e-document.htm. Attention is drawn to the limitation of liability, indemnification and jurisdiction issues defined therein. Any holder of this document is advised that information contained hereon reflects the Company's findings at the time of its intervention only and within the limits of Client's instructions, if any. The Company's sole responsibility is to its Client and this document does not exonerate parties to a transaction from exercising all their rights and obligations under the transaction documents. This document cannot be reproduced except in full, without prior written approval of the Company. Any unauthorized alteration, forgery or falsification of the content or appearance of this document is unlawful and offenders may be prosecuted to the fullest extent of the law.

1.6.5 Results

The measured output power within ± 5 mm of the triggering points, or until the tablet is touching the phantom, for movements to and from the phantom is tabulated in the following.

Back side

Moving device toward the phantom

WWAN

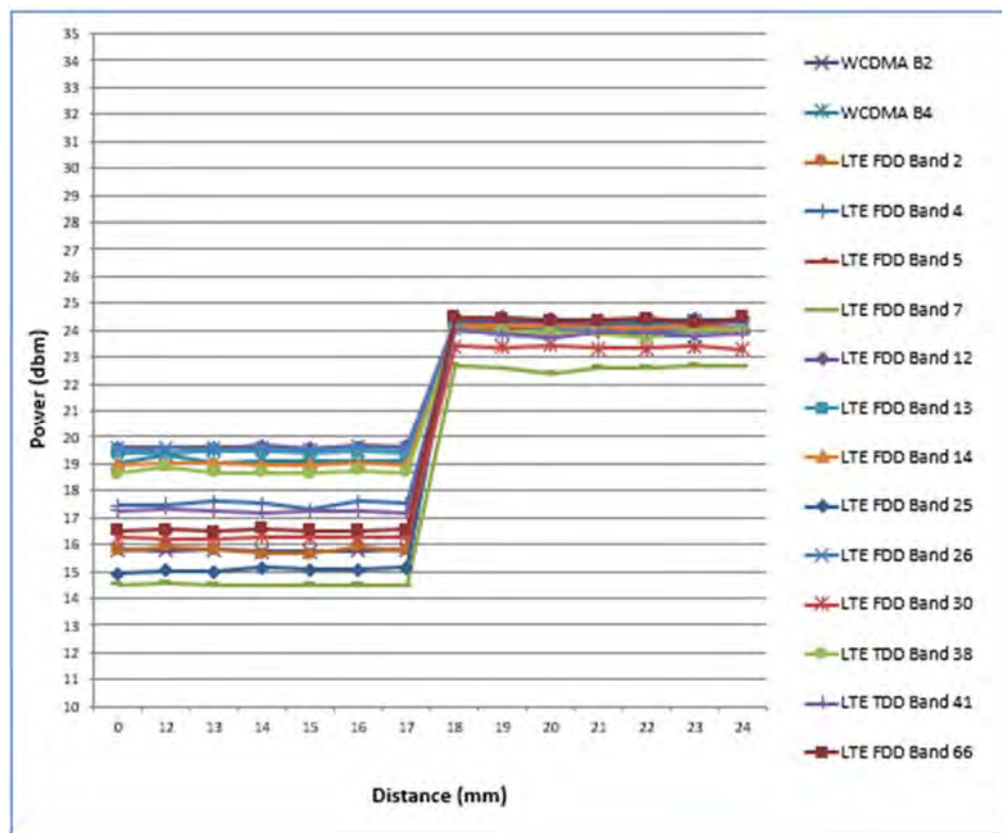

Unless otherwise stated the results shown in this test report refer only to the sample(s) tested and such sample(s) are retained for 90 days only.

除非另有說明，此報告結果僅對測試之樣品負責，同時此樣品僅保留90天。本報告未經本公司書面許可，不可部份複製。

This document is issued by the Company subject to its General Conditions of Service printed overleaf, available on request or accessible at www.sgs.com/terms_and_conditions.htm and for electronic format documents, subject to Terms and Conditions for Electronic Documents at www.sgs.com/terms_e-document.htm. Attention is drawn to the limitation of liability, indemnification and jurisdiction issues defined therein. Any holder of this document is advised that information contained hereon reflects the Company's findings at the time of its intervention only and within the limits of Client's instructions, if any. The Company's sole responsibility is to its Client and this document does not exonerate parties to a transaction from exercising all their rights and obligations under the transaction documents. This document cannot be reproduced except in full, without prior written approval of the Company. Any unauthorized alteration, forgery or falsification of the content or appearance of this document is unlawful and offenders may be prosecuted to the fullest extent of the law.

Tx2 (WLAN only)

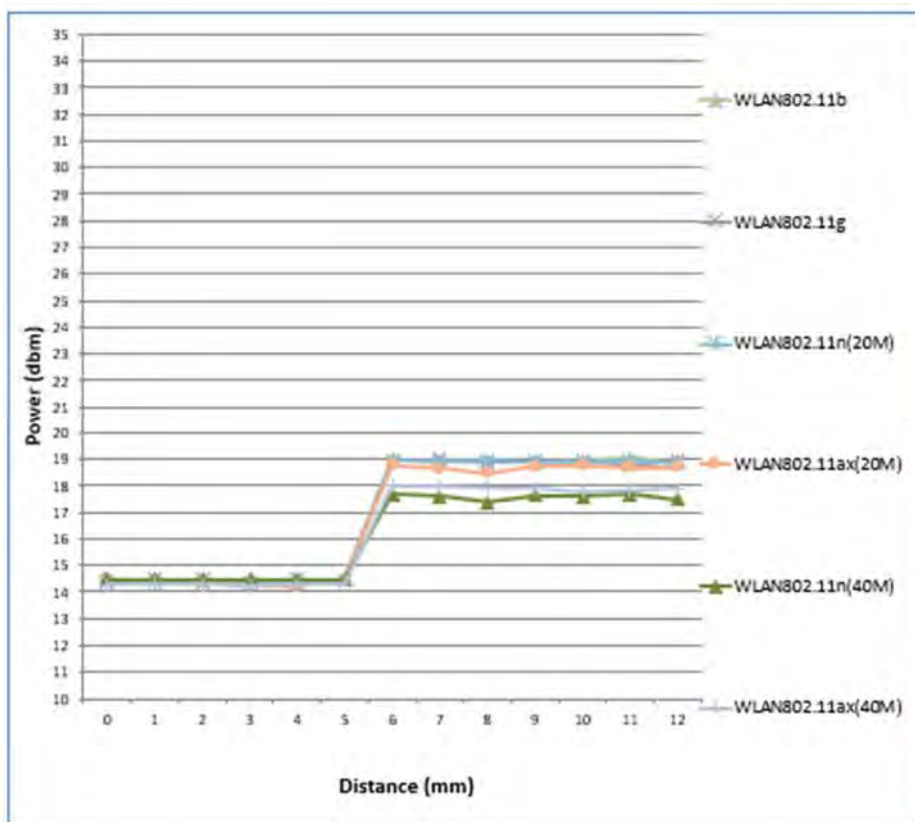

Unless otherwise stated the results shown in this test report refer only to the sample(s) tested and such sample(s) are retained for 90 days only.

除非另有說明，此報告結果僅對測試之樣品負責，同時此樣品僅保留90天。本報告未經本公司書面許可，不可部份複製。

This document is issued by the Company subject to its General Conditions of Service printed overleaf, available on request or accessible at www.sgs.com/terms_and_conditions.htm and for electronic format documents, subject to Terms and Conditions for Electronic Documents at www.sgs.com/terms_e-document.htm. Attention is drawn to the limitation of liability, indemnification and jurisdiction issues defined therein. Any holder of this document is advised that information contained hereon reflects the Company's findings at the time of its intervention only and within the limits of Client's instructions, if any. The Company's sole responsibility is to its Client and this document does not exonerate parties to a transaction from exercising all their rights and obligations under the transaction documents. This document cannot be reproduced except in full, without prior written approval of the Company. Any unauthorized alteration, forgery or falsification of the content or appearance of this document is unlawful and offenders may be prosecuted to the fullest extent of the law.

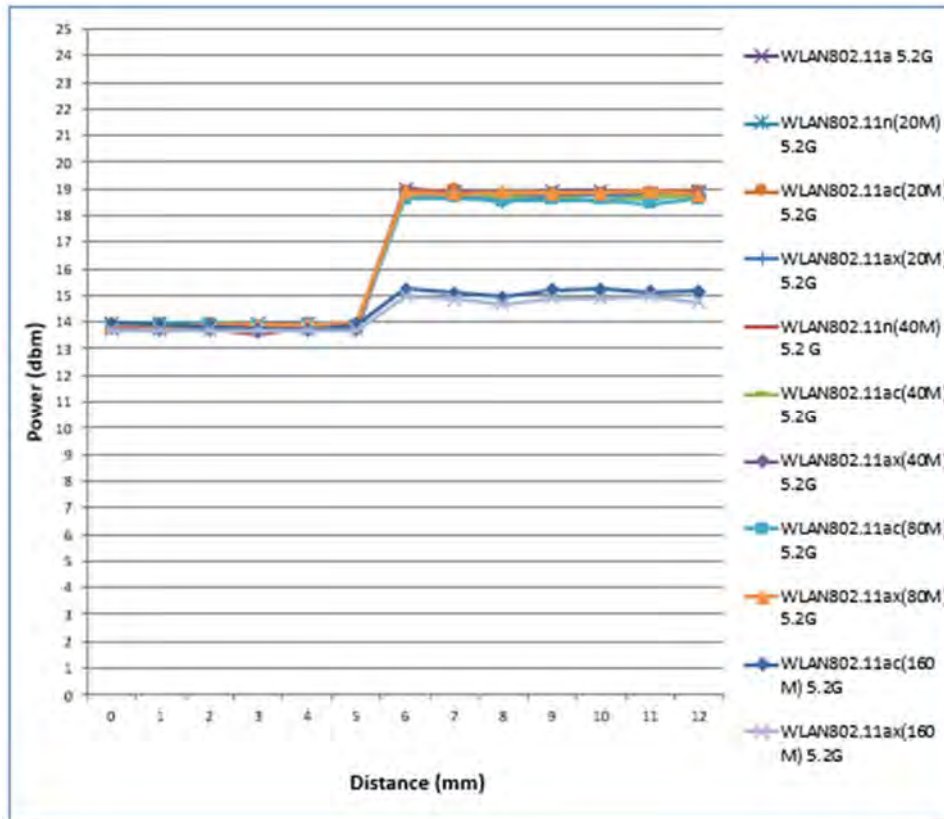

Unless otherwise stated the results shown in this test report refer only to the sample(s) tested and such sample(s) are retained for 90 days only.

除非另有說明，此報告結果僅對測試之樣品負責，同時此樣品僅保留90天。本報告未經本公司書面許可，不可部份複製。

This document is issued by the Company subject to its General Conditions of Service printed overleaf, available on request or accessible at www.sgs.com/terms_and_conditions.htm and for electronic format documents, subject to Terms and Conditions for Electronic Documents at www.sgs.com/terms_e-document.htm. Attention is drawn to the limitation of liability, indemnification and jurisdiction issues defined therein. Any holder of this document is advised that information contained hereon reflects the Company's findings at the time of its intervention only and within the limits of Client's instructions, if any. The Company's sole responsibility is to its Client and this document does not exonerate parties to a transaction from exercising all their rights and obligations under the transaction documents. This document cannot be reproduced except in full, without prior written approval of the Company. Any unauthorized alteration, forgery or falsification of the content or appearance of this document is unlawful and offenders may be prosecuted to the fullest extent of the law.

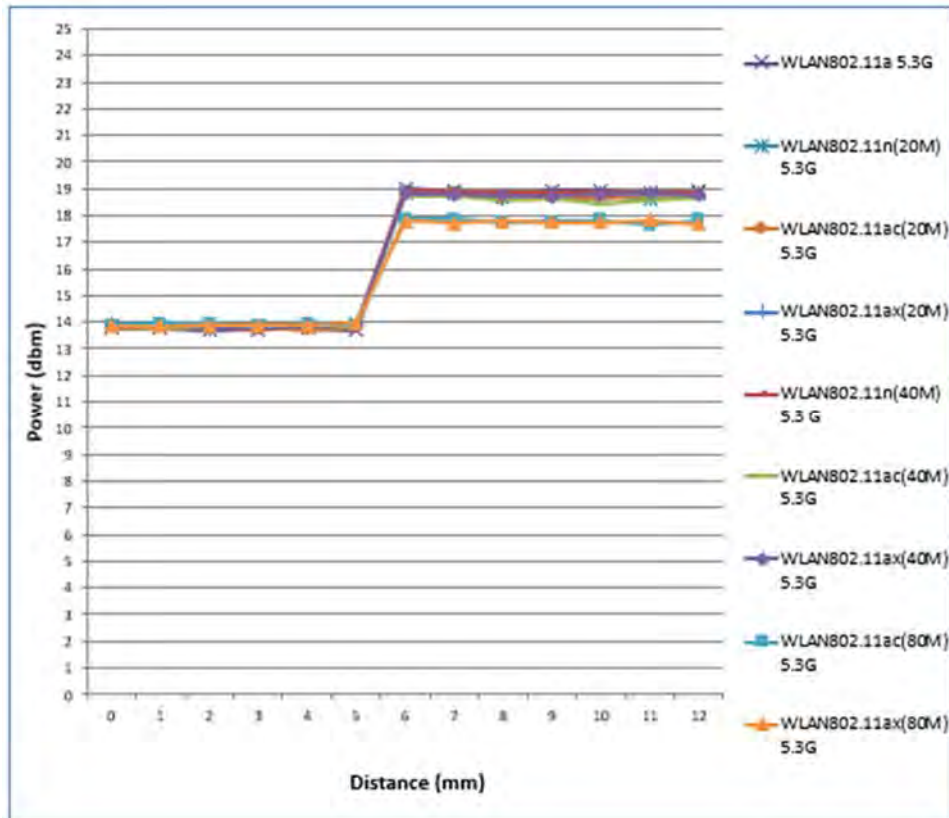

Unless otherwise stated the results shown in this test report refer only to the sample(s) tested and such sample(s) are retained for 90 days only.

除非另有說明，此報告結果僅對測試之樣品負責，同時此樣品僅保留90天。本報告未經本公司書面許可，不可部份複製。

This document is issued by the Company subject to its General Conditions of Service printed overleaf, available on request or accessible at www.sgs.com/terms_and_conditions.htm and for electronic format documents, subject to Terms and Conditions for Electronic Documents at www.sgs.com/terms_e-document.htm. Attention is drawn to the limitation of liability, indemnification and jurisdiction issues defined therein. Any holder of this document is advised that information contained hereon reflects the Company's findings at the time of its intervention only and within the limits of Client's instructions, if any. The Company's sole responsibility is to its Client and this document does not exonerate parties to a transaction from exercising all their rights and obligations under the transaction documents. This document cannot be reproduced except in full, without prior written approval of the Company. Any unauthorized alteration, forgery or falsification of the content or appearance of this document is unlawful and offenders may be prosecuted to the fullest extent of the law.

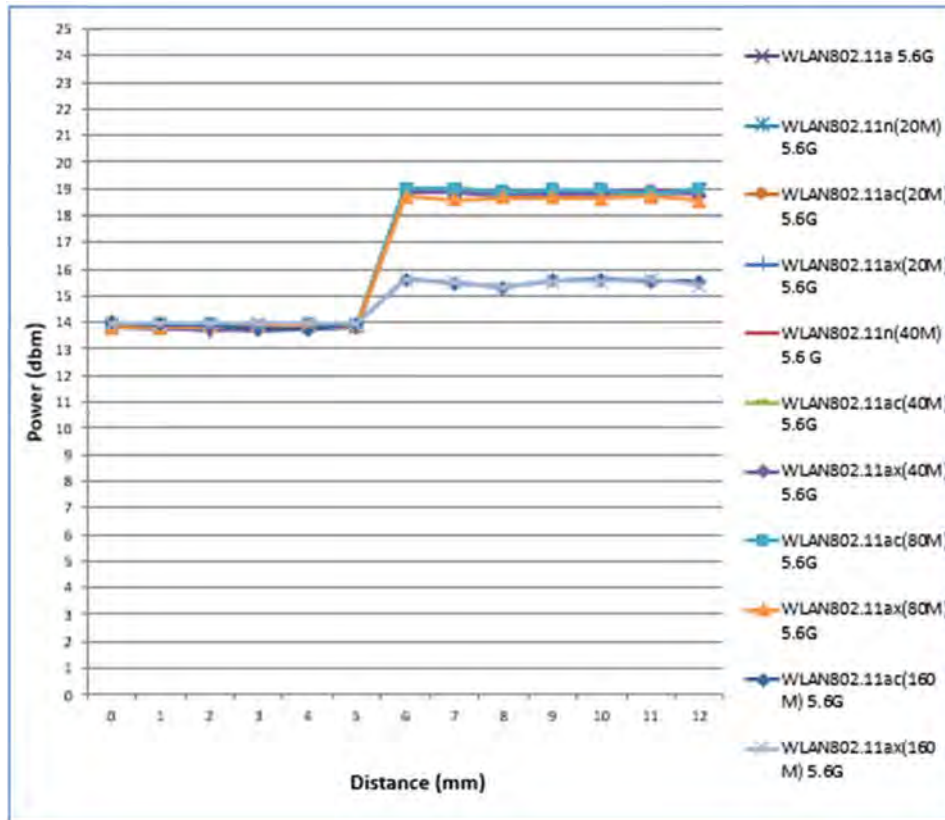

Unless otherwise stated the results shown in this test report refer only to the sample(s) tested and such sample(s) are retained for 90 days only.

除非另有說明，此報告結果僅對測試之樣品負責，同時此樣品僅保留90天。本報告未經本公司書面許可，不可部份複製。

This document is issued by the Company subject to its General Conditions of Service printed overleaf, available on request or accessible at www.sgs.com/terms_and_conditions.htm and for electronic format documents, subject to Terms and Conditions for Electronic Documents at www.sgs.com/terms_e-document.htm. Attention is drawn to the limitation of liability, indemnification and jurisdiction issues defined therein. Any holder of this document is advised that information contained hereon reflects the Company's findings at the time of its intervention only and within the limits of Client's instructions, if any. The Company's sole responsibility is to its Client and this document does not exonerate parties to a transaction from exercising all their rights and obligations under the transaction documents. This document cannot be reproduced except in full, without prior written approval of the Company. Any unauthorized alteration, forgery or falsification of the content or appearance of this document is unlawful and offenders may be prosecuted to the fullest extent of the law.

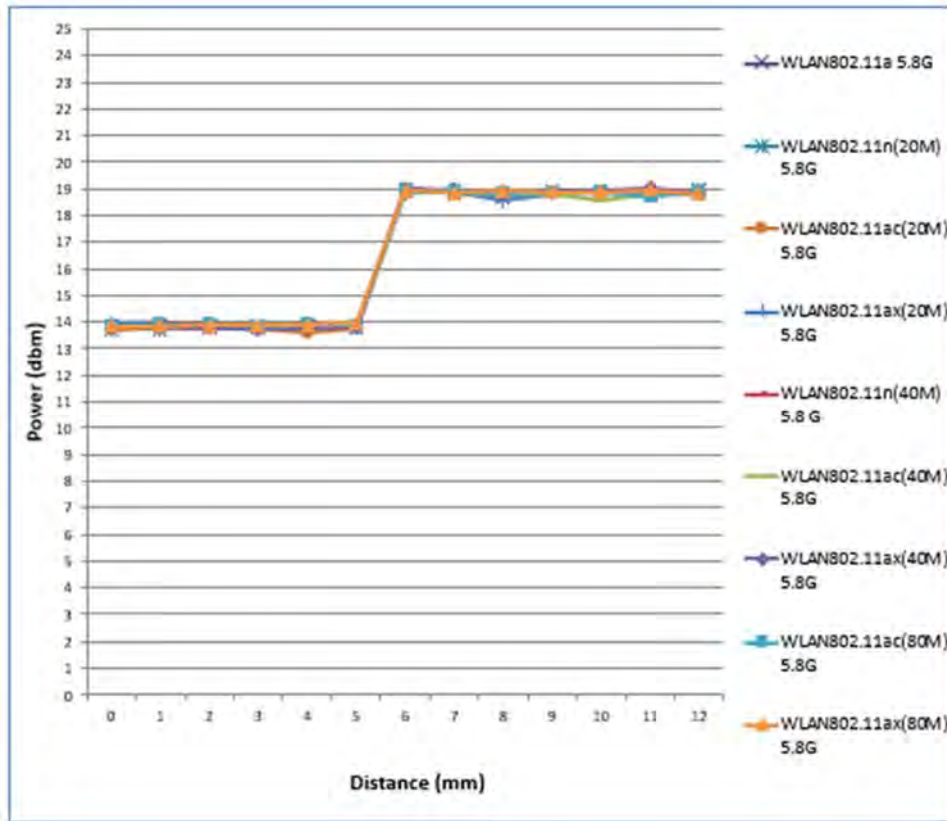

Unless otherwise stated the results shown in this test report refer only to the sample(s) tested and such sample(s) are retained for 90 days only.

除非另有說明，此報告結果僅對測試之樣品負責，同時此樣品僅保留90天。本報告未經本公司書面許可，不可部份複製。

This document is issued by the Company subject to its General Conditions of Service printed overleaf, available on request or accessible at www.sgs.com/terms_and_conditions.htm and for electronic format documents, subject to Terms and Conditions for Electronic Documents at www.sgs.com/terms_e-document.htm. Attention is drawn to the limitation of liability, indemnification and jurisdiction issues defined therein. Any holder of this document is advised that information contained hereon reflects the Company's findings at the time of its intervention only and within the limits of Client's instructions, if any. The Company's sole responsibility is to its Client and this document does not exonerate parties to a transaction from exercising all their rights and obligations under the transaction documents. This document cannot be reproduced except in full, without prior written approval of the Company. Any unauthorized alteration, forgery or falsification of the content or appearance of this document is unlawful and offenders may be prosecuted to the fullest extent of the law.

Tx2 (WWAN + WLAN)

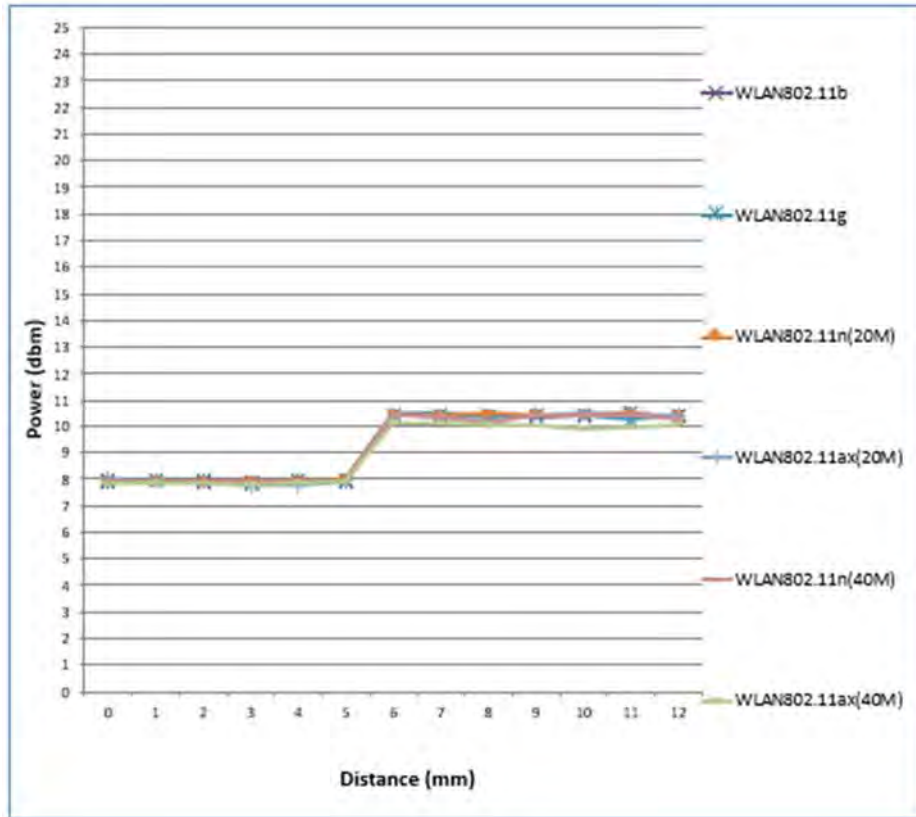

Unless otherwise stated the results shown in this test report refer only to the sample(s) tested and such sample(s) are retained for 90 days only.

除非另有說明，此報告結果僅對測試之樣品負責，同時此樣品僅保留90天。本報告未經本公司書面許可，不可部份複製。

This document is issued by the Company subject to its General Conditions of Service printed overleaf, available on request or accessible at www.sgs.com/terms_and_conditions.htm and for electronic format documents, subject to Terms and Conditions for Electronic Documents at www.sgs.com/terms_e-document.htm. Attention is drawn to the limitation of liability, indemnification and jurisdiction issues defined therein. Any holder of this document is advised that information contained hereon reflects the Company's findings at the time of its intervention only and within the limits of Client's instructions, if any. The Company's sole responsibility is to its Client and this document does not exonerate parties to a transaction from exercising all their rights and obligations under the transaction documents. This document cannot be reproduced except in full, without prior written approval of the Company. Any unauthorized alteration, forgery or falsification of the content or appearance of this document is unlawful and offenders may be prosecuted to the fullest extent of the law.

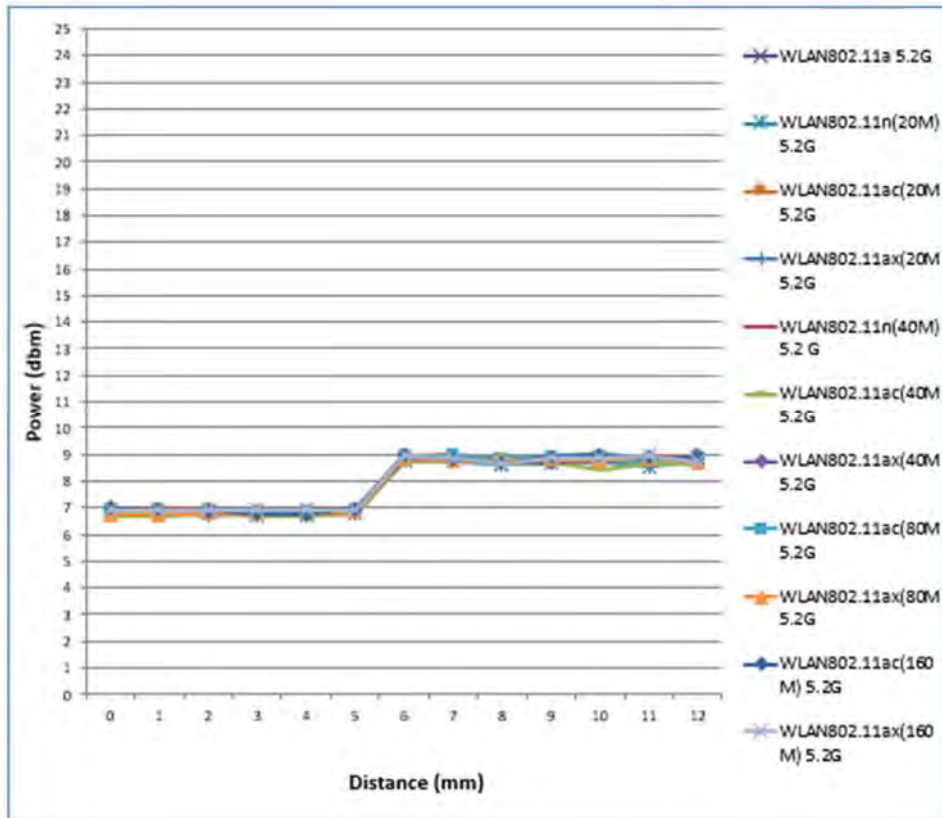

Unless otherwise stated the results shown in this test report refer only to the sample(s) tested and such sample(s) are retained for 90 days only.

除非另有說明，此報告結果僅對測試之樣品負責，同時此樣品僅保留90天。本報告未經本公司書面許可，不可部份複製。

This document is issued by the Company subject to its General Conditions of Service printed overleaf, available on request or accessible at www.sgs.com/terms_and_conditions.htm and for electronic format documents, subject to Terms and Conditions for Electronic Documents at www.sgs.com/terms_e-document.htm. Attention is drawn to the limitation of liability, indemnification and jurisdiction issues defined therein. Any holder of this document is advised that information contained hereon reflects the Company's findings at the time of its intervention only and within the limits of Client's instructions, if any. The Company's sole responsibility is to its Client and this document does not exonerate parties to a transaction from exercising all their rights and obligations under the transaction documents. This document cannot be reproduced except in full, without prior written approval of the Company. Any unauthorized alteration, forgery or falsification of the content or appearance of this document is unlawful and offenders may be prosecuted to the fullest extent of the law.

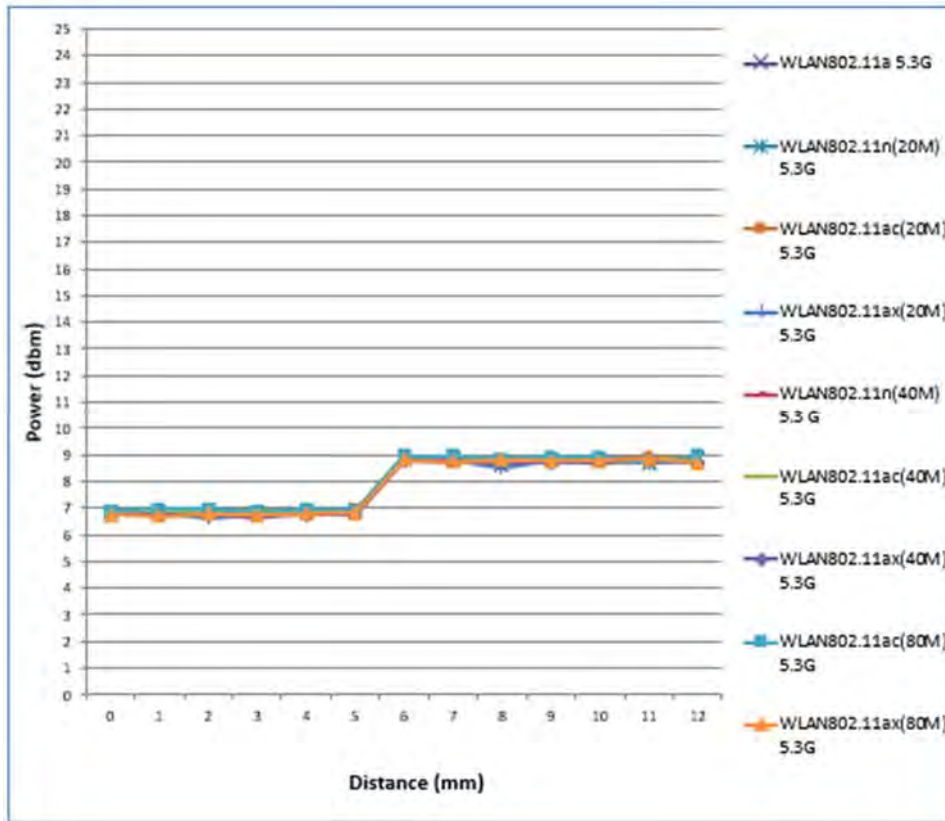

Unless otherwise stated the results shown in this test report refer only to the sample(s) tested and such sample(s) are retained for 90 days only.

除非另有說明，此報告結果僅對測試之樣品負責，同時此樣品僅保留90天。本報告未經本公司書面許可，不可部份複製。

This document is issued by the Company subject to its General Conditions of Service printed overleaf, available on request or accessible at www.sgs.com/terms_and_conditions.htm and for electronic format documents, subject to Terms and Conditions for Electronic Documents at www.sgs.com/terms_e-document.htm. Attention is drawn to the limitation of liability, indemnification and jurisdiction issues defined therein. Any holder of this document is advised that information contained hereon reflects the Company's findings at the time of its intervention only and within the limits of Client's instructions, if any. The Company's sole responsibility is to its Client and this document does not exonerate parties to a transaction from exercising all their rights and obligations under the transaction documents. This document cannot be reproduced except in full, without prior written approval of the Company. Any unauthorized alteration, forgery or falsification of the content or appearance of this document is unlawful and offenders may be prosecuted to the fullest extent of the law.

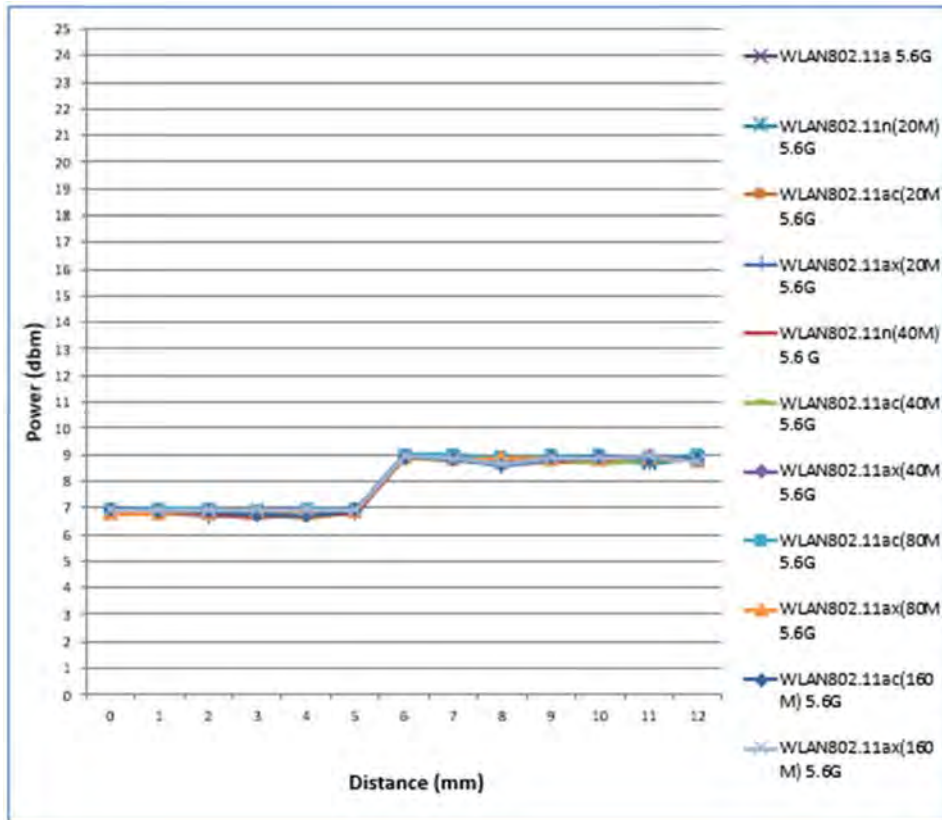

Unless otherwise stated the results shown in this test report refer only to the sample(s) tested and such sample(s) are retained for 90 days only.

除非另有說明，此報告結果僅對測試之樣品負責，同時此樣品僅保留90天。本報告未經本公司書面許可，不可部份複製。

This document is issued by the Company subject to its General Conditions of Service printed overleaf, available on request or accessible at www.sgs.com/terms_and_conditions.htm and for electronic format documents, subject to Terms and Conditions for Electronic Documents at www.sgs.com/terms_e-document.htm. Attention is drawn to the limitation of liability, indemnification and jurisdiction issues defined therein. Any holder of this document is advised that information contained hereon reflects the Company's findings at the time of its intervention only and within the limits of Client's instructions, if any. The Company's sole responsibility is to its Client and this document does not exonerate parties to a transaction from exercising all their rights and obligations under the transaction documents. This document cannot be reproduced except in full, without prior written approval of the Company. Any unauthorized alteration, forgery or falsification of the content or appearance of this document is unlawful and offenders may be prosecuted to the fullest extent of the law.

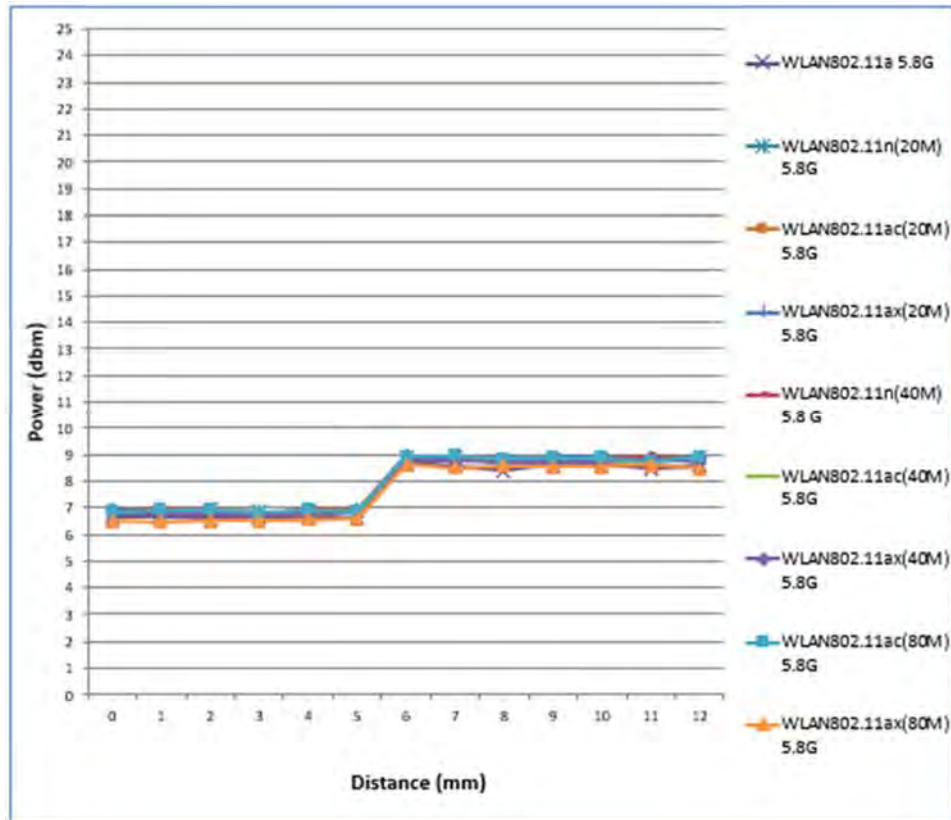

Unless otherwise stated the results shown in this test report refer only to the sample(s) tested and such sample(s) are retained for 90 days only.

除非另有說明，此報告結果僅對測試之樣品負責，同時此樣品僅保留90天。本報告未經本公司書面許可，不可部份複製。

This document is issued by the Company subject to its General Conditions of Service printed overleaf, available on request or accessible at www.sgs.com/terms_and_conditions.htm and for electronic format documents, subject to Terms and Conditions for Electronic Documents at www.sgs.com/terms_e-document.htm. Attention is drawn to the limitation of liability, indemnification and jurisdiction issues defined therein. Any holder of this document is advised that information contained hereon reflects the Company's findings at the time of its intervention only and within the limits of Client's instructions, if any. The Company's sole responsibility is to its Client and this document does not exonerate parties to a transaction from exercising all their rights and obligations under the transaction documents. This document cannot be reproduced except in full, without prior written approval of the Company. Any unauthorized alteration, forgery or falsification of the content or appearance of this document is unlawful and offenders may be prosecuted to the fullest extent of the law.

Moving device away from the phantom

WWAN

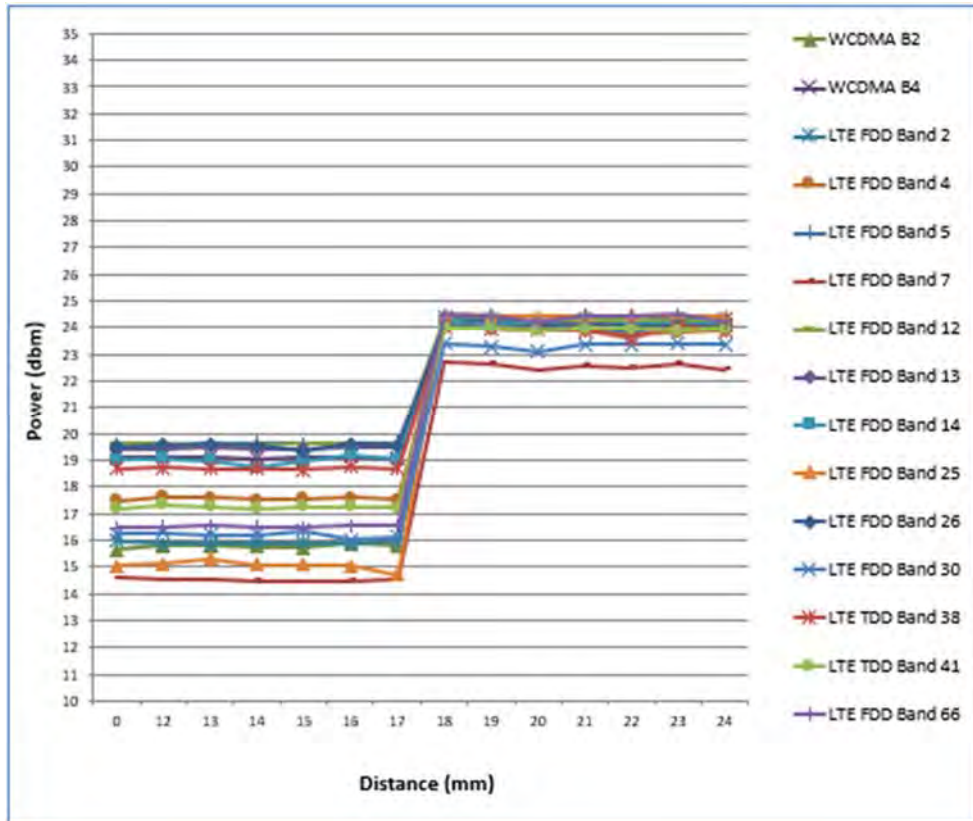

Unless otherwise stated the results shown in this test report refer only to the sample(s) tested and such sample(s) are retained for 90 days only.

除非另有說明，此報告結果僅對測試之樣品負責，同時此樣品僅保留90天。本報告未經本公司書面許可，不可部份複製。

This document is issued by the Company subject to its General Conditions of Service printed overleaf, available on request or accessible at www.sgs.com/terms_and_conditions.htm and for electronic format documents, subject to Terms and Conditions for Electronic Documents at www.sgs.com/terms_e-document.htm. Attention is drawn to the limitation of liability, indemnification and jurisdiction issues defined therein. Any holder of this document is advised that information contained hereon reflects the Company's findings at the time of its intervention only and within the limits of Client's instructions, if any. The Company's sole responsibility is to its Client and this document does not exonerate parties to a transaction from exercising all their rights and obligations under the transaction documents. This document cannot be reproduced except in full, without prior written approval of the Company. Any unauthorized alteration, forgery or falsification of the content or appearance of this document is unlawful and offenders may be prosecuted to the fullest extent of the law.

Tx2 (WLAN only)

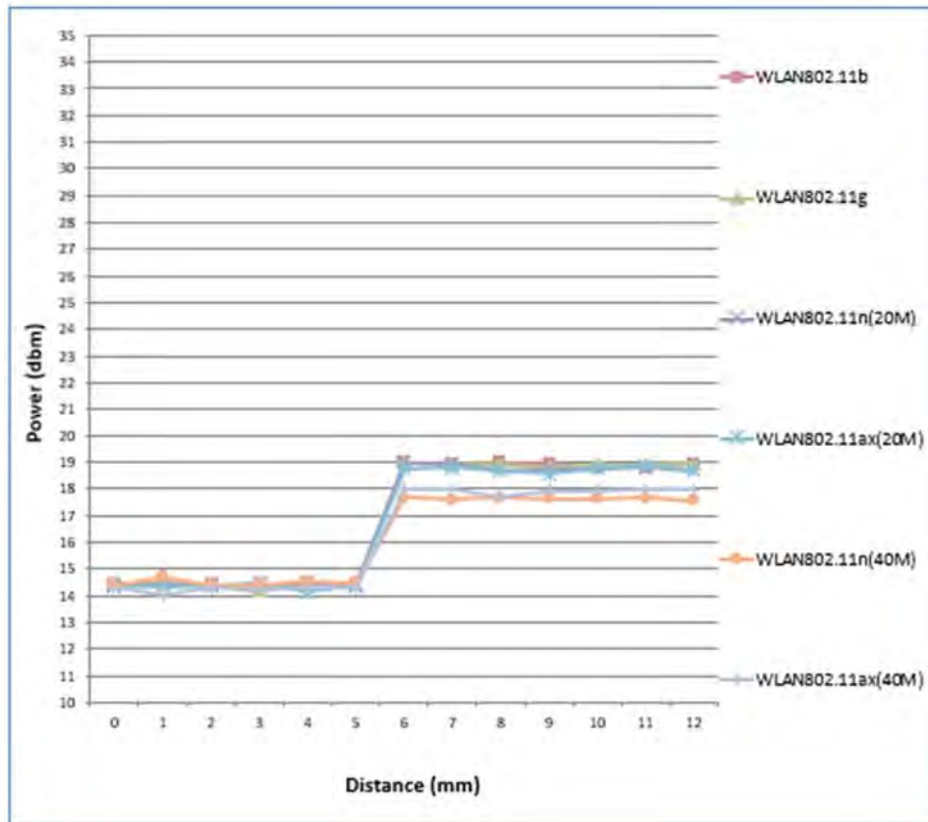

Unless otherwise stated the results shown in this test report refer only to the sample(s) tested and such sample(s) are retained for 90 days only.

除非另有說明，此報告結果僅對測試之樣品負責，同時此樣品僅保留90天。本報告未經本公司書面許可，不可部份複製。

This document is issued by the Company subject to its General Conditions of Service printed overleaf, available on request or accessible at www.sgs.com/terms_and_conditions.htm and for electronic format documents, subject to Terms and Conditions for Electronic Documents at www.sgs.com/terms_e-document.htm. Attention is drawn to the limitation of liability, indemnification and jurisdiction issues defined therein. Any holder of this document is advised that information contained hereon reflects the Company's findings at the time of its intervention only and within the limits of Client's instructions, if any. The Company's sole responsibility is to its Client and this document does not exonerate parties to a transaction from exercising all their rights and obligations under the transaction documents. This document cannot be reproduced except in full, without prior written approval of the Company. Any unauthorized alteration, forgery or falsification of the content or appearance of this document is unlawful and offenders may be prosecuted to the fullest extent of the law.

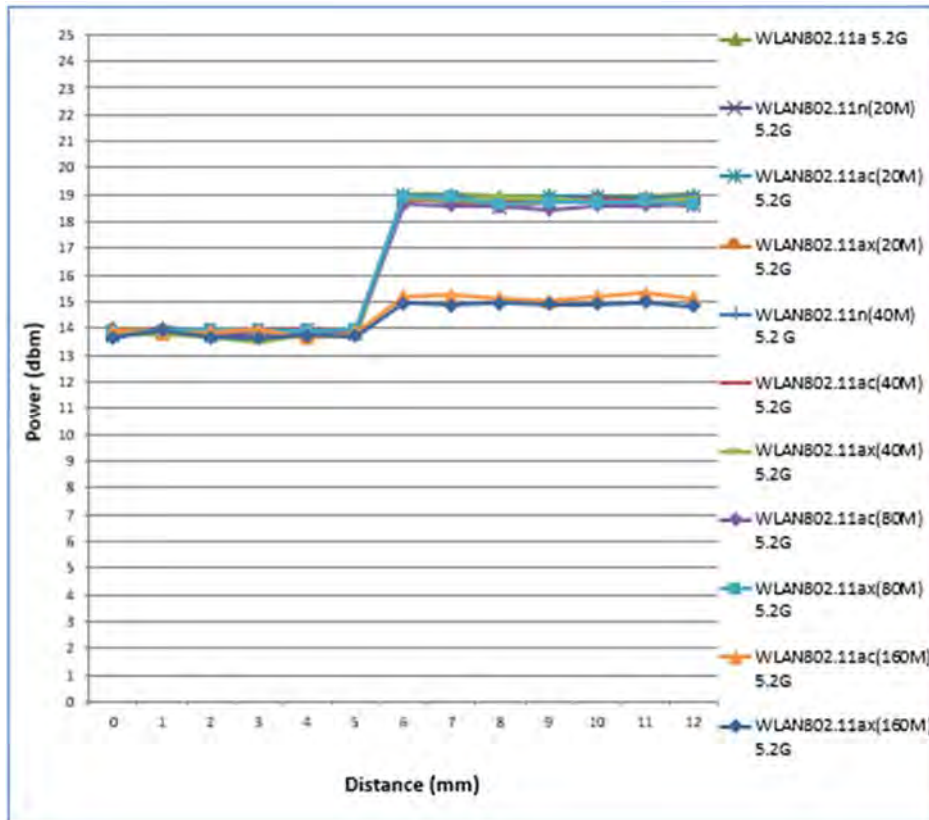

Unless otherwise stated the results shown in this test report refer only to the sample(s) tested and such sample(s) are retained for 90 days only.

除非另有說明，此報告結果僅對測試之樣品負責，同時此樣品僅保留90天。本報告未經本公司書面許可，不可部份複製。

This document is issued by the Company subject to its General Conditions of Service printed overleaf, available on request or accessible at www.sgs.com/terms_and_conditions.htm and for electronic format documents, subject to Terms and Conditions for Electronic Documents at www.sgs.com/terms_e-document.htm. Attention is drawn to the limitation of liability, indemnification and jurisdiction issues defined therein. Any holder of this document is advised that information contained hereon reflects the Company's findings at the time of its intervention only and within the limits of Client's instructions, if any. The Company's sole responsibility is to its Client and this document does not exonerate parties to a transaction from exercising all their rights and obligations under the transaction documents. This document cannot be reproduced except in full, without prior written approval of the Company. Any unauthorized alteration, forgery or falsification of the content or appearance of this document is unlawful and offenders may be prosecuted to the fullest extent of the law.

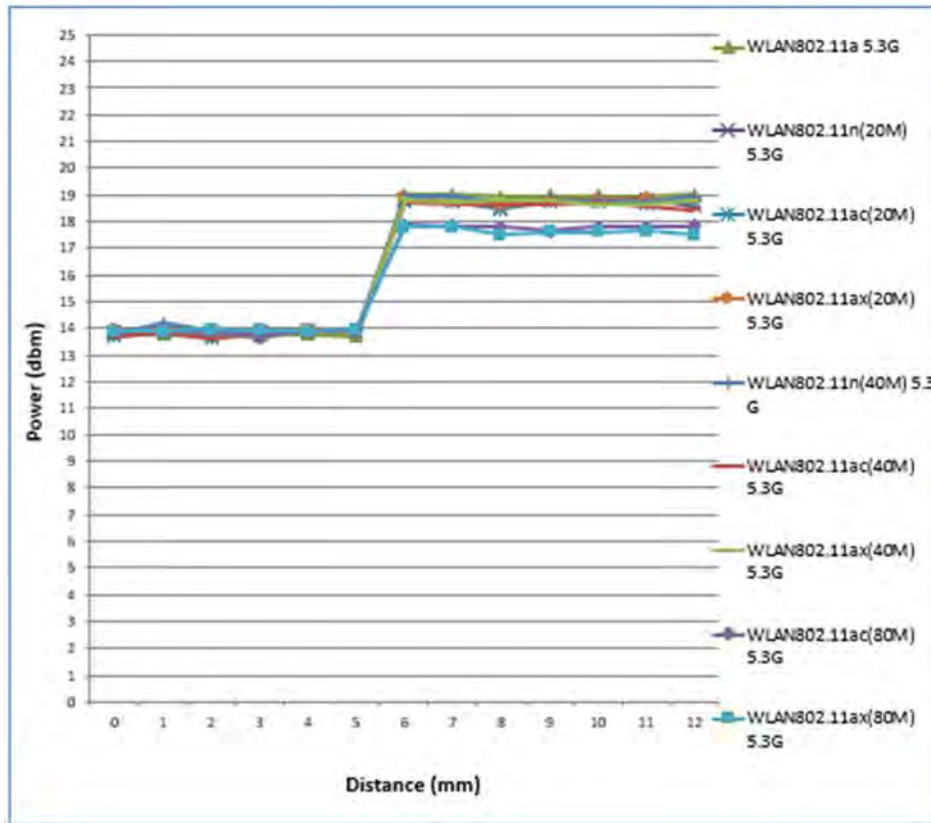

Unless otherwise stated the results shown in this test report refer only to the sample(s) tested and such sample(s) are retained for 90 days only.

除非另有說明，此報告結果僅對測試之樣品負責，同時此樣品僅保留90天。本報告未經本公司書面許可，不可部份複製。

This document is issued by the Company subject to its General Conditions of Service printed overleaf, available on request or accessible at www.sgs.com/terms_and_conditions.htm and for electronic format documents, subject to Terms and Conditions for Electronic Documents at www.sgs.com/terms_e-document.htm. Attention is drawn to the limitation of liability, indemnification and jurisdiction issues defined therein. Any holder of this document is advised that information contained hereon reflects the Company's findings at the time of its intervention only and within the limits of Client's instructions, if any. The Company's sole responsibility is to its Client and this document does not exonerate parties to a transaction from exercising all their rights and obligations under the transaction documents. This document cannot be reproduced except in full, without prior written approval of the Company. Any unauthorized alteration, forgery or falsification of the content or appearance of this document is unlawful and offenders may be prosecuted to the fullest extent of the law.

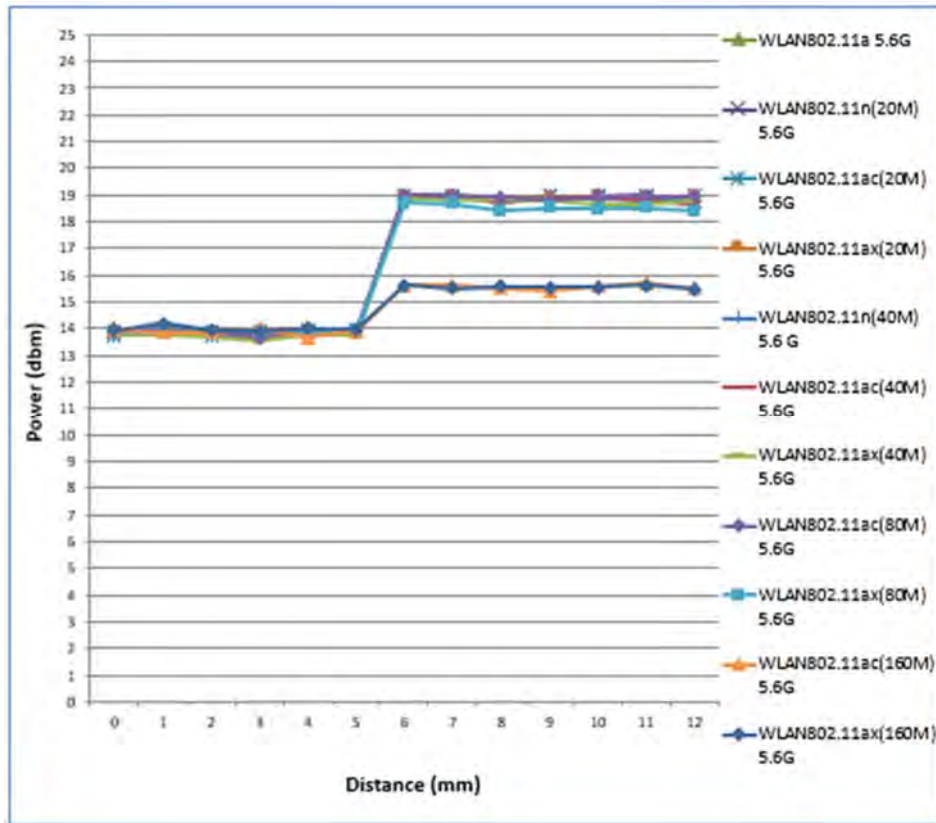

Unless otherwise stated the results shown in this test report refer only to the sample(s) tested and such sample(s) are retained for 90 days only.

除非另有說明，此報告結果僅對測試之樣品負責，同時此樣品僅保留90天。本報告未經本公司書面許可，不可部份複製。

This document is issued by the Company subject to its General Conditions of Service printed overleaf, available on request or accessible at www.sgs.com/terms_and_conditions.htm and for electronic format documents, subject to Terms and Conditions for Electronic Documents at www.sgs.com/terms_e-document.htm. Attention is drawn to the limitation of liability, indemnification and jurisdiction issues defined therein. Any holder of this document is advised that information contained hereon reflects the Company's findings at the time of its intervention only and within the limits of Client's instructions, if any. The Company's sole responsibility is to its Client and this document does not exonerate parties to a transaction from exercising all their rights and obligations under the transaction documents. This document cannot be reproduced except in full, without prior written approval of the Company. Any unauthorized alteration, forgery or falsification of the content or appearance of this document is unlawful and offenders may be prosecuted to the fullest extent of the law.

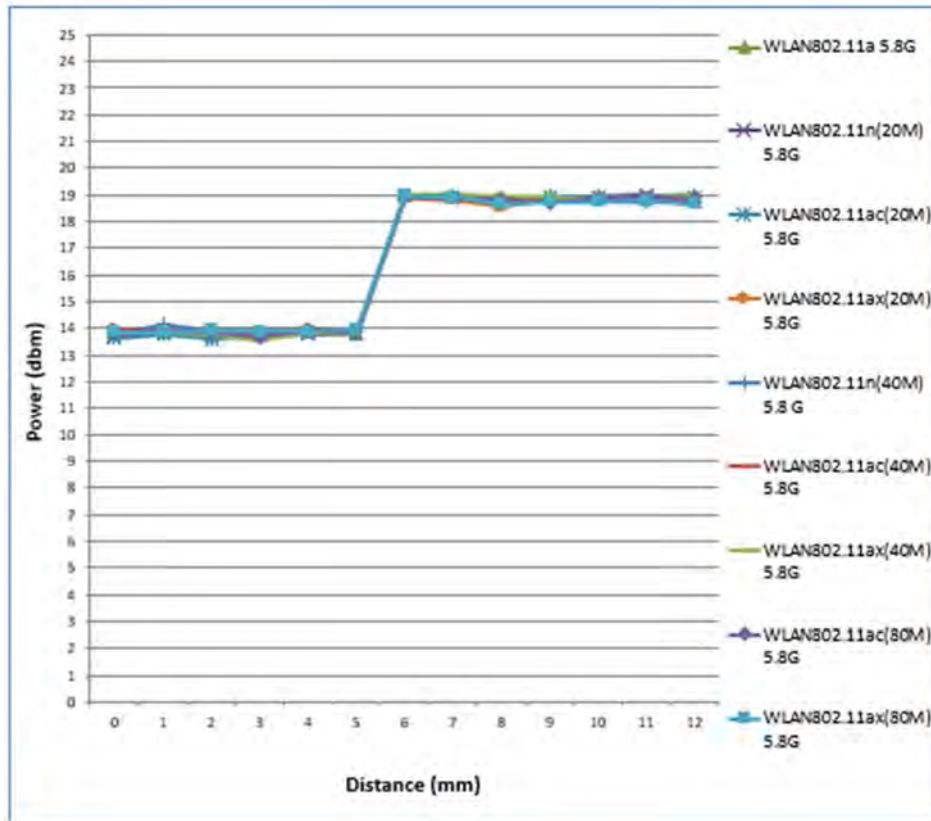

Unless otherwise stated the results shown in this test report refer only to the sample(s) tested and such sample(s) are retained for 90 days only.

除非另有說明，此報告結果僅對測試之樣品負責，同時此樣品僅保留90天。本報告未經本公司書面許可，不可部份複製。

This document is issued by the Company subject to its General Conditions of Service printed overleaf, available on request or accessible at www.sgs.com/terms_and_conditions.htm and for electronic format documents, subject to Terms and Conditions for Electronic Documents at www.sgs.com/terms_e-document.htm. Attention is drawn to the limitation of liability, indemnification and jurisdiction issues defined therein. Any holder of this document is advised that information contained hereon reflects the Company's findings at the time of its intervention only and within the limits of Client's instructions, if any. The Company's sole responsibility is to its Client and this document does not exonerate parties to a transaction from exercising all their rights and obligations under the transaction documents. This document cannot be reproduced except in full, without prior written approval of the Company. Any unauthorized alteration, forgery or falsification of the content or appearance of this document is unlawful and offenders may be prosecuted to the fullest extent of the law.

Tx2 (WWAN + WLAN)

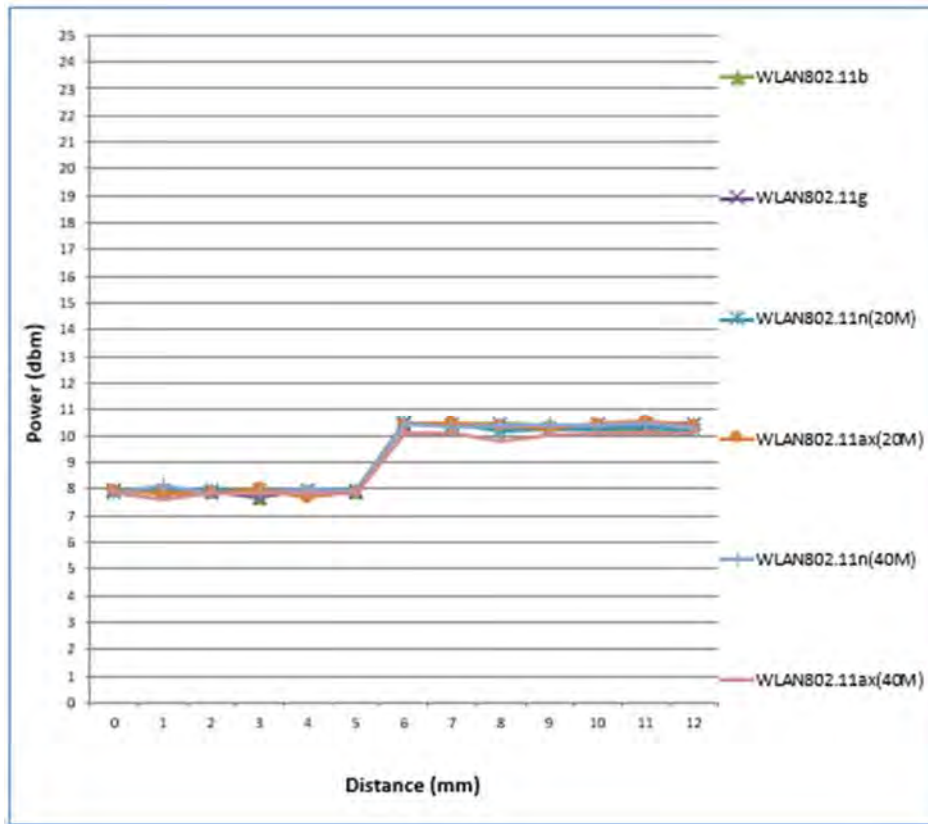

Unless otherwise stated the results shown in this test report refer only to the sample(s) tested and such sample(s) are retained for 90 days only.

除非另有說明，此報告結果僅對測試之樣品負責，同時此樣品僅保留90天。本報告未經本公司書面許可，不可部份複製。

This document is issued by the Company subject to its General Conditions of Service printed overleaf, available on request or accessible at www.sgs.com/terms_and_conditions.htm and for electronic format documents, subject to Terms and Conditions for Electronic Documents at www.sgs.com/terms_e-document.htm. Attention is drawn to the limitation of liability, indemnification and jurisdiction issues defined therein. Any holder of this document is advised that information contained hereon reflects the Company's findings at the time of its intervention only and within the limits of Client's instructions, if any. The Company's sole responsibility is to its Client and this document does not exonerate parties to a transaction from exercising all their rights and obligations under the transaction documents. This document cannot be reproduced except in full, without prior written approval of the Company. Any unauthorized alteration, forgery or falsification of the content or appearance of this document is unlawful and offenders may be prosecuted to the fullest extent of the law.

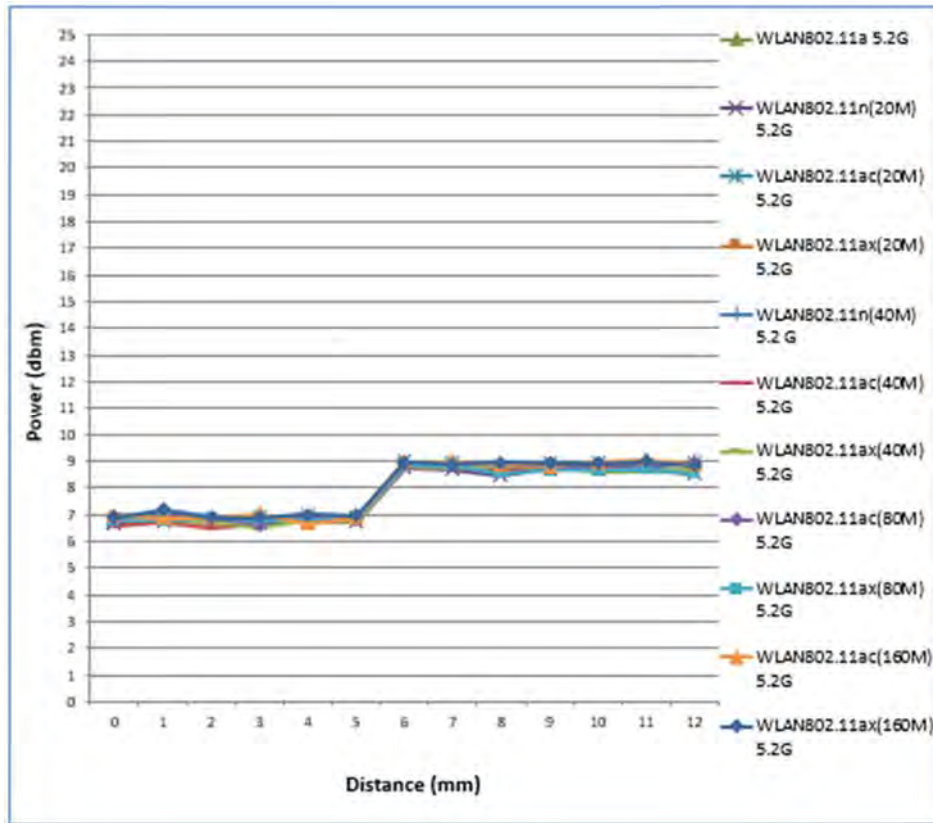

Unless otherwise stated the results shown in this test report refer only to the sample(s) tested and such sample(s) are retained for 90 days only.

除非另有說明，此報告結果僅對測試之樣品負責，同時此樣品僅保留90天。本報告未經本公司書面許可，不可部份複製。

This document is issued by the Company subject to its General Conditions of Service printed overleaf, available on request or accessible at www.sgs.com/terms_and_conditions.htm and for electronic format documents, subject to Terms and Conditions for Electronic Documents at www.sgs.com/terms_e-document.htm. Attention is drawn to the limitation of liability, indemnification and jurisdiction issues defined therein. Any holder of this document is advised that information contained hereon reflects the Company's findings at the time of its intervention only and within the limits of Client's instructions, if any. The Company's sole responsibility is to its Client and this document does not exonerate parties to a transaction from exercising all their rights and obligations under the transaction documents. This document cannot be reproduced except in full, without prior written approval of the Company. Any unauthorized alteration, forgery or falsification of the content or appearance of this document is unlawful and offenders may be prosecuted to the fullest extent of the law.

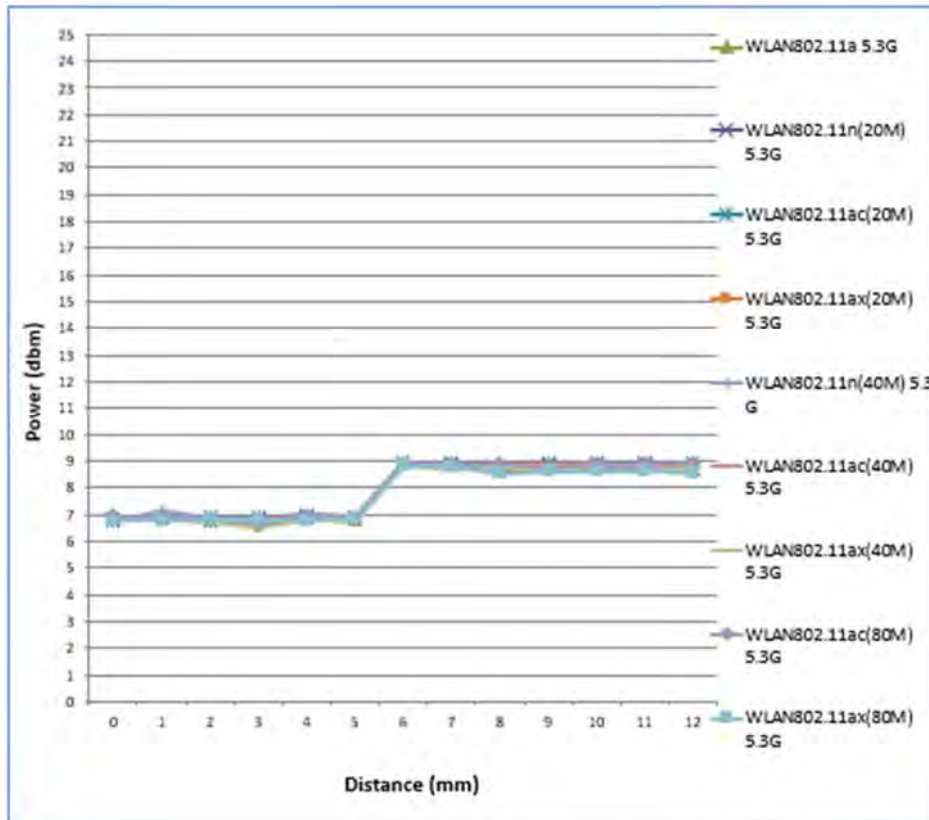

Unless otherwise stated the results shown in this test report refer only to the sample(s) tested and such sample(s) are retained for 90 days only.

除非另有說明，此報告結果僅對測試之樣品負責，同時此樣品僅保留90天。本報告未經本公司書面許可，不可部份複製。

This document is issued by the Company subject to its General Conditions of Service printed overleaf, available on request or accessible at www.sgs.com/terms_and_conditions.htm and for electronic format documents, subject to Terms and Conditions for Electronic Documents at www.sgs.com/terms_e-document.htm. Attention is drawn to the limitation of liability, indemnification and jurisdiction issues defined therein. Any holder of this document is advised that information contained hereon reflects the Company's findings at the time of its intervention only and within the limits of Client's instructions, if any. The Company's sole responsibility is to its Client and this document does not exonerate parties to a transaction from exercising all their rights and obligations under the transaction documents. This document cannot be reproduced except in full, without prior written approval of the Company. Any unauthorized alteration, forgery or falsification of the content or appearance of this document is unlawful and offenders may be prosecuted to the fullest extent of the law.

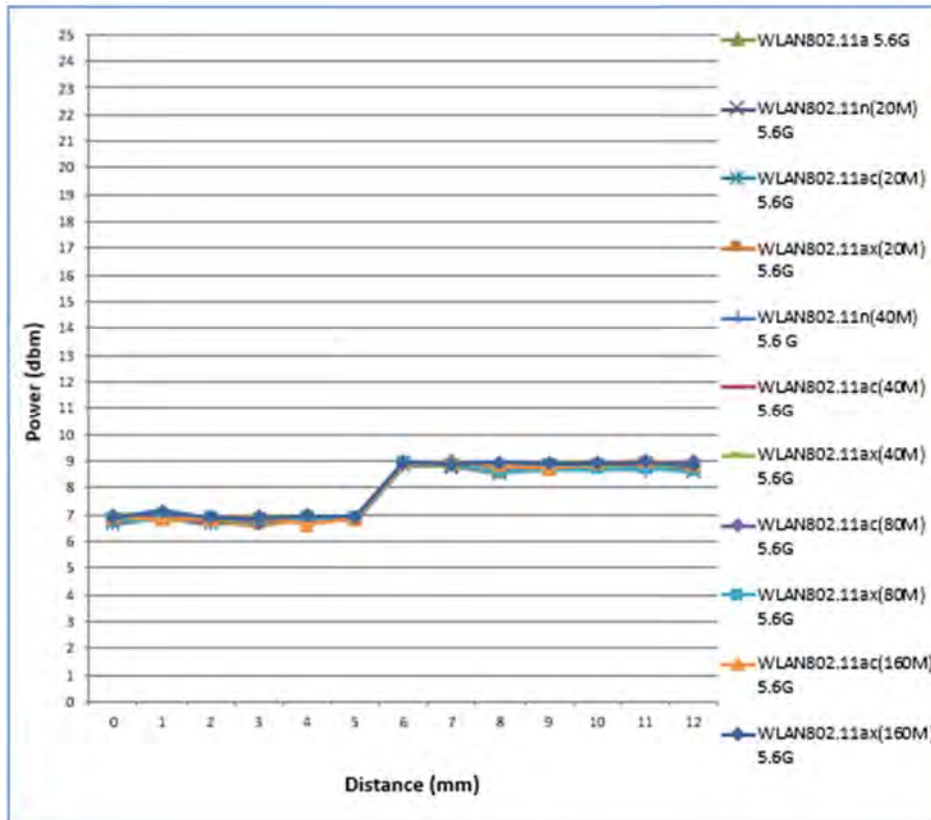

Unless otherwise stated the results shown in this test report refer only to the sample(s) tested and such sample(s) are retained for 90 days only.

除非另有說明，此報告結果僅對測試之樣品負責，同時此樣品僅保留90天。本報告未經本公司書面許可，不可部份複製。

This document is issued by the Company subject to its General Conditions of Service printed overleaf, available on request or accessible at www.sgs.com/terms_and_conditions.htm and for electronic format documents, subject to Terms and Conditions for Electronic Documents at www.sgs.com/terms_e-document.htm. Attention is drawn to the limitation of liability, indemnification and jurisdiction issues defined therein. Any holder of this document is advised that information contained hereon reflects the Company's findings at the time of its intervention only and within the limits of Client's instructions, if any. The Company's sole responsibility is to its Client and this document does not exonerate parties to a transaction from exercising all their rights and obligations under the transaction documents. This document cannot be reproduced except in full, without prior written approval of the Company. Any unauthorized alteration, forgery or falsification of the content or appearance of this document is unlawful and offenders may be prosecuted to the fullest extent of the law.

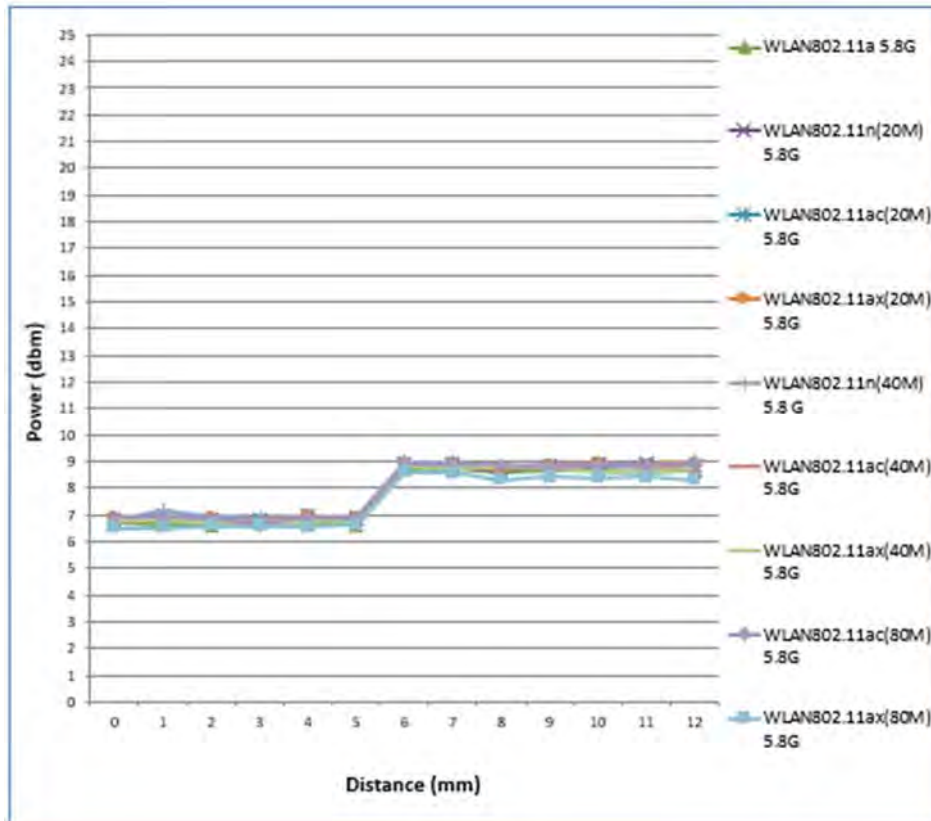

For WLAN TX1_back side, the worst trigger distance of proximity sensor is 5mm, and we test backside SAR in 4mm with full power and 0mm with reduced power. For WLAN TX2_back side, the worst trigger distance of proximity sensor is 7mm, and we test backside SAR in 6mm with full power and 0mm with reduced power.

Unless otherwise stated the results shown in this test report refer only to the sample(s) tested and such sample(s) are retained for 90 days only.
除非另有說明，此報告結果僅對測試之樣品負責，同時此樣品僅保留90天。本報告未經本公司書面許可，不可部份複製。

This document is issued by the Company subject to its General Conditions of Service printed overleaf, available on request or accessible at www.sgs.com/terms_and_conditions.htm and for electronic format documents, subject to Terms and Conditions for Electronic Documents at www.sgs.com/terms_e-document.htm. Attention is drawn to the limitation of liability, indemnification and jurisdiction issues defined therein. Any holder of this document is advised that information contained hereon reflects the Company's findings at the time of its intervention only and within the limits of Client's instructions, if any. The Company's sole responsibility is to its Client and this document does not exonerate parties to a transaction from exercising all their rights and obligations under the transaction documents. This document cannot be reproduced except in full, without prior written approval of the Company. Any unauthorized alteration, forgery or falsification of the content or appearance of this document is unlawful and offenders may be prosecuted to the fullest extent of the law.

Top side

Moving device toward the phantom

WWAN

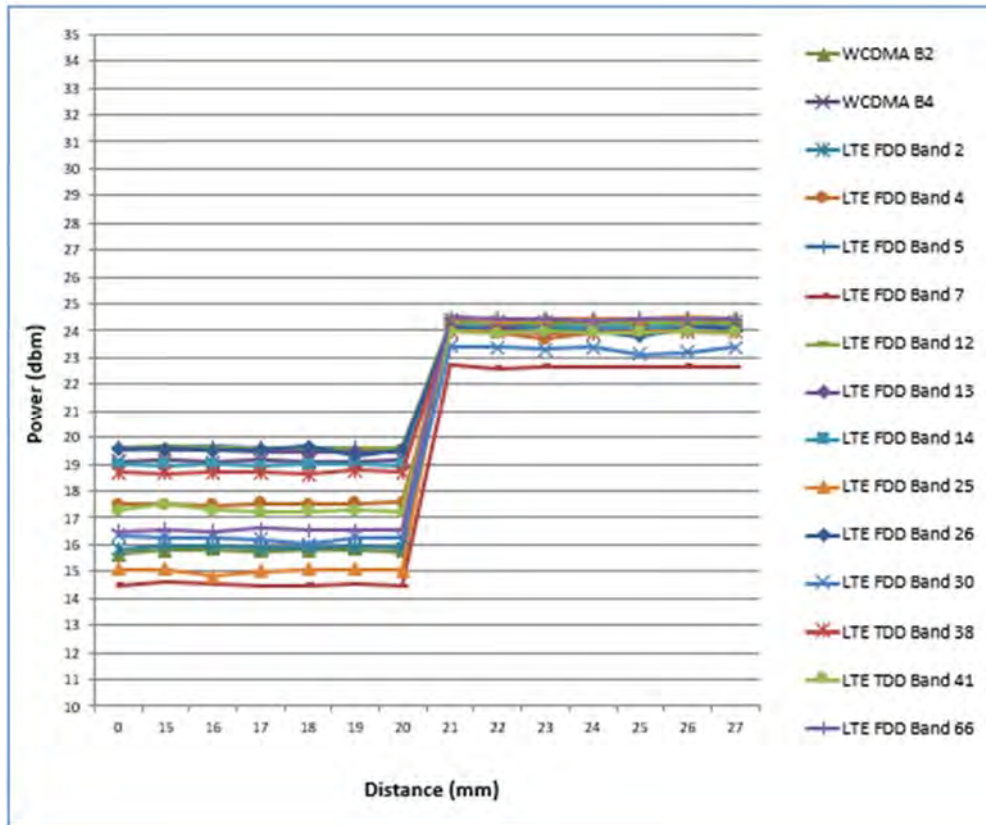

Unless otherwise stated the results shown in this test report refer only to the sample(s) tested and such sample(s) are retained for 90 days only.

除非另有說明，此報告結果僅對測試之樣品負責，同時此樣品僅保留90天。本報告未經本公司書面許可，不可部份複製。

This document is issued by the Company subject to its General Conditions of Service printed overleaf, available on request or accessible at www.sgs.com/terms_and_conditions.htm and for electronic format documents, subject to Terms and Conditions for Electronic Documents at www.sgs.com/terms_e-document.htm. Attention is drawn to the limitation of liability, indemnification and jurisdiction issues defined therein. Any holder of this document is advised that information contained hereon reflects the Company's findings at the time of its intervention only and within the limits of Client's instructions, if any. The Company's sole responsibility is to its Client and this document does not exonerate parties to a transaction from exercising all their rights and obligations under the transaction documents. This document cannot be reproduced except in full, without prior written approval of the Company. Any unauthorized alteration, forgery or falsification of the content or appearance of this document is unlawful and offenders may be prosecuted to the fullest extent of the law.

Tx1 (WLAN only)

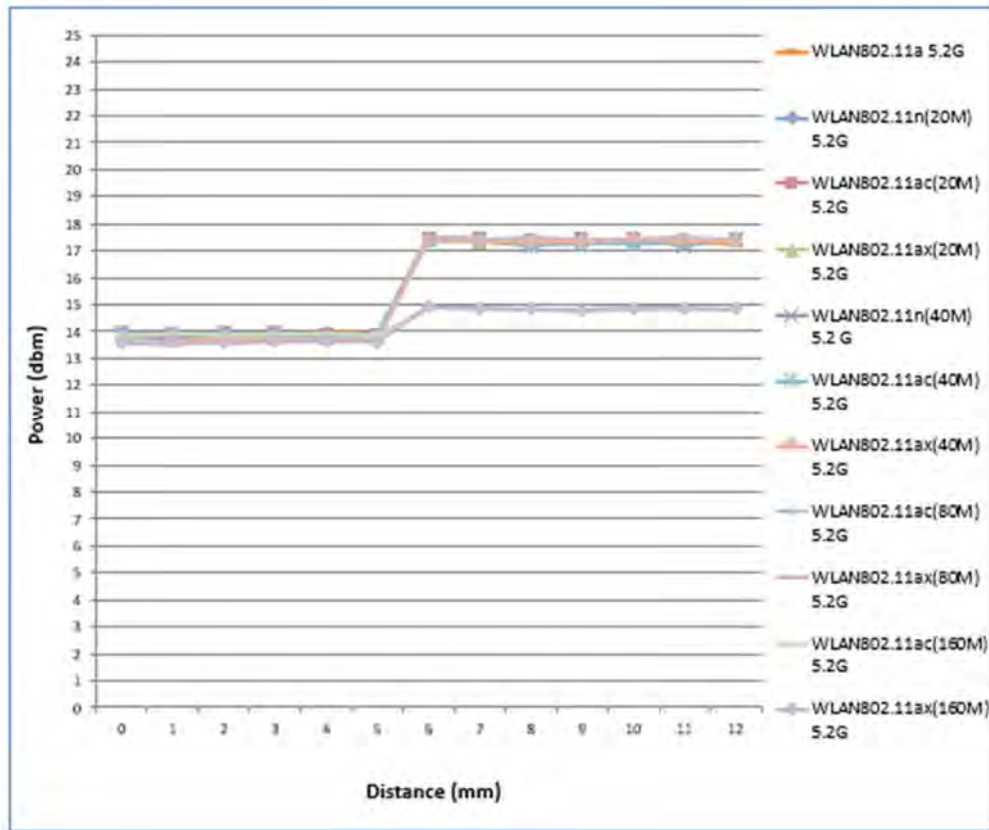

Unless otherwise stated the results shown in this test report refer only to the sample(s) tested and such sample(s) are retained for 90 days only.

除非另有說明，此報告結果僅對測試之樣品負責，同時此樣品僅保留90天。本報告未經本公司書面許可，不可部份複製。

This document is issued by the Company subject to its General Conditions of Service printed overleaf, available on request or accessible at www.sgs.com/terms_and_conditions.htm and for electronic format documents, subject to Terms and Conditions for Electronic Documents at www.sgs.com/terms_e-document.htm. Attention is drawn to the limitation of liability, indemnification and jurisdiction issues defined therein. Any holder of this document is advised that information contained hereon reflects the Company's findings at the time of its intervention only and within the limits of Client's instructions, if any. The Company's sole responsibility is to its Client and this document does not exonerate parties to a transaction from exercising all their rights and obligations under the transaction documents. This document cannot be reproduced except in full, without prior written approval of the Company. Any unauthorized alteration, forgery or falsification of the content or appearance of this document is unlawful and offenders may be prosecuted to the fullest extent of the law.

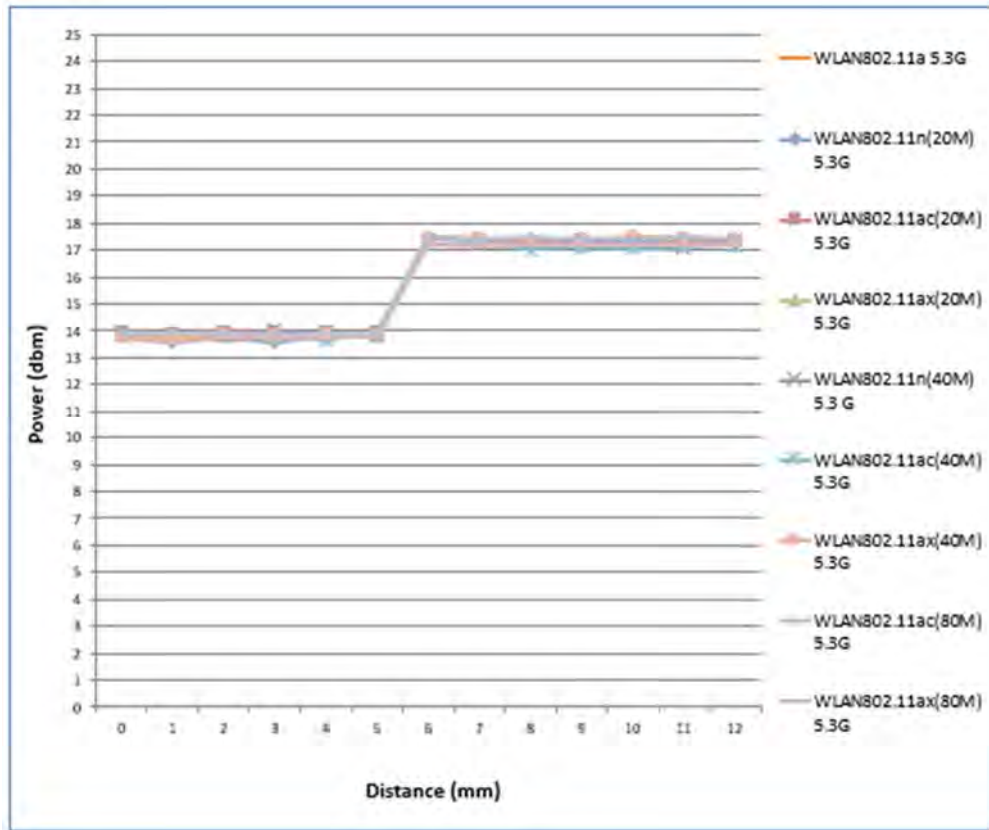

Unless otherwise stated the results shown in this test report refer only to the sample(s) tested and such sample(s) are retained for 90 days only.

除非另有說明，此報告結果僅對測試之樣品負責，同時此樣品僅保留90天。本報告未經本公司書面許可，不可部份複製。

This document is issued by the Company subject to its General Conditions of Service printed overleaf, available on request or accessible at www.sgs.com/terms_and_conditions.htm and for electronic format documents, subject to Terms and Conditions for Electronic Documents at www.sgs.com/terms_e-document.htm. Attention is drawn to the limitation of liability, indemnification and jurisdiction issues defined therein. Any holder of this document is advised that information contained hereon reflects the Company's findings at the time of its intervention only and within the limits of Client's instructions, if any. The Company's sole responsibility is to its Client and this document does not exonerate parties to a transaction from exercising all their rights and obligations under the transaction documents. This document cannot be reproduced except in full, without prior written approval of the Company. Any unauthorized alteration, forgery or falsification of the content or appearance of this document is unlawful and offenders may be prosecuted to the fullest extent of the law.

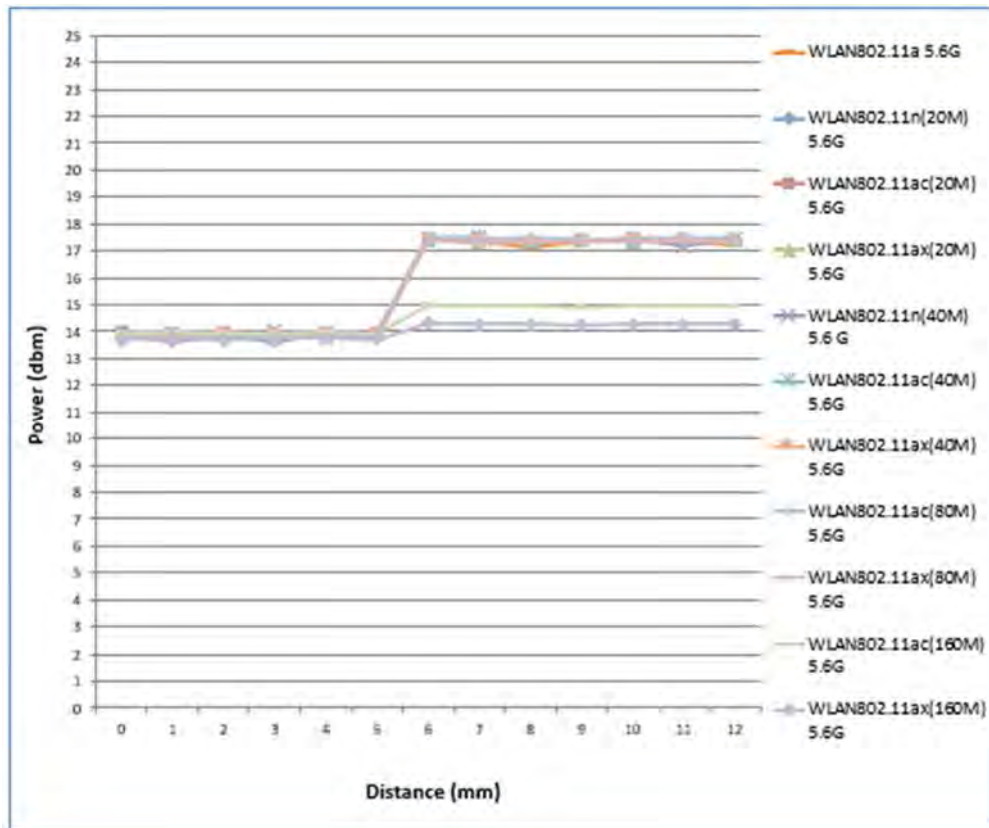

Unless otherwise stated the results shown in this test report refer only to the sample(s) tested and such sample(s) are retained for 90 days only.

除非另有說明，此報告結果僅對測試之樣品負責，同時此樣品僅保留90天。本報告未經本公司書面許可，不可部份複製。

This document is issued by the Company subject to its General Conditions of Service printed overleaf, available on request or accessible at www.sgs.com/terms_and_conditions.htm and for electronic format documents, subject to Terms and Conditions for Electronic Documents at www.sgs.com/terms_e-document.htm. Attention is drawn to the limitation of liability, indemnification and jurisdiction issues defined therein. Any holder of this document is advised that information contained hereon reflects the Company's findings at the time of its intervention only and within the limits of Client's instructions, if any. The Company's sole responsibility is to its Client and this document does not exonerate parties to a transaction from exercising all their rights and obligations under the transaction documents. This document cannot be reproduced except in full, without prior written approval of the Company. Any unauthorized alteration, forgery or falsification of the content or appearance of this document is unlawful and offenders may be prosecuted to the fullest extent of the law.

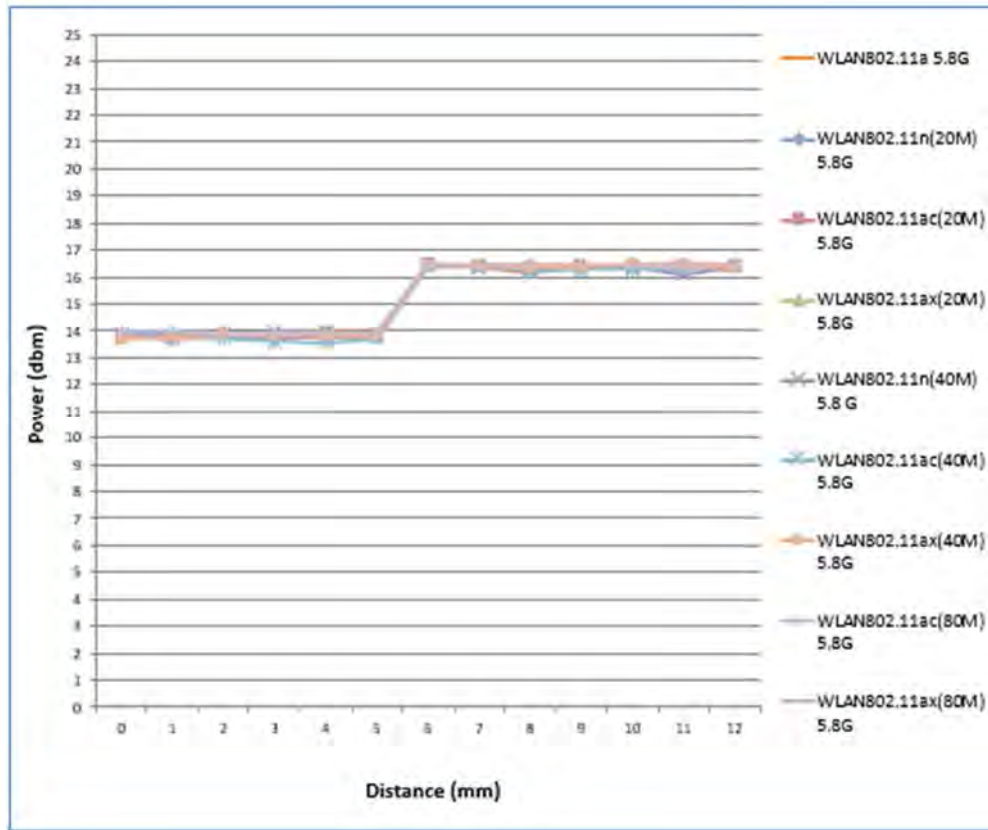

Unless otherwise stated the results shown in this test report refer only to the sample(s) tested and such sample(s) are retained for 90 days only.

除非另有說明，此報告結果僅對測試之樣品負責，同時此樣品僅保留90天。本報告未經本公司書面許可，不可部份複製。

This document is issued by the Company subject to its General Conditions of Service printed overleaf, available on request or accessible at www.sgs.com/terms_and_conditions.htm and for electronic format documents, subject to Terms and Conditions for Electronic Documents at www.sgs.com/terms_e-document.htm. Attention is drawn to the limitation of liability, indemnification and jurisdiction issues defined therein. Any holder of this document is advised that information contained hereon reflects the Company's findings at the time of its intervention only and within the limits of Client's instructions, if any. The Company's sole responsibility is to its Client and this document does not exonerate parties to a transaction from exercising all their rights and obligations under the transaction documents. This document cannot be reproduced except in full, without prior written approval of the Company. Any unauthorized alteration, forgery or falsification of the content or appearance of this document is unlawful and offenders may be prosecuted to the fullest extent of the law.

Tx2 (WLAN only)

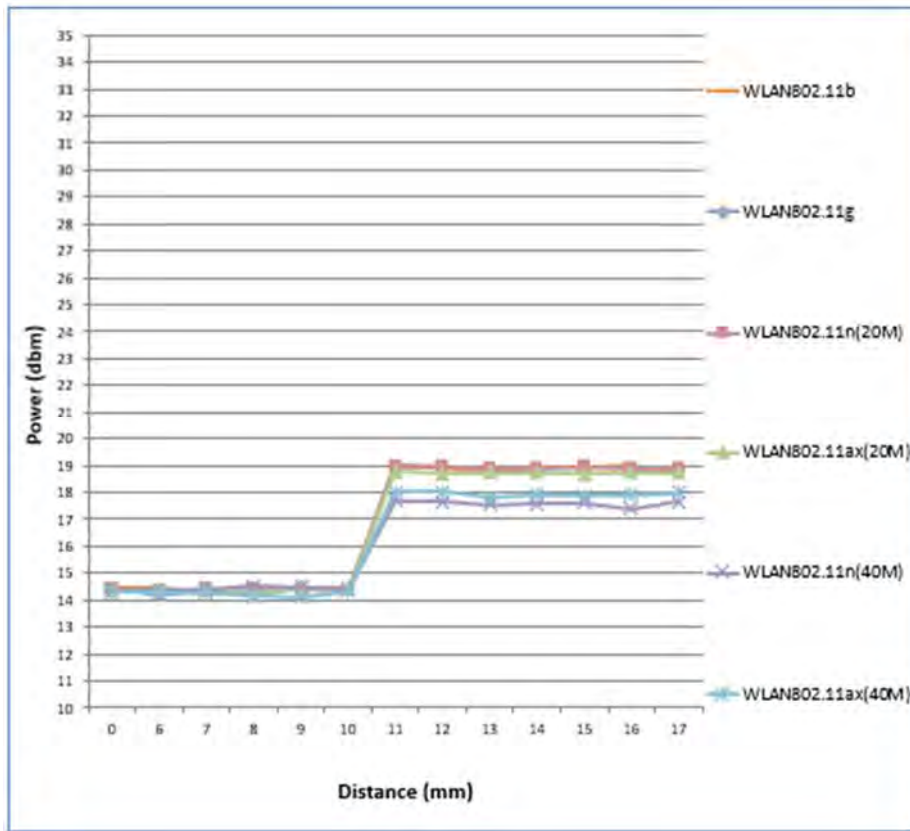

Unless otherwise stated the results shown in this test report refer only to the sample(s) tested and such sample(s) are retained for 90 days only.

除非另有說明，此報告結果僅對測試之樣品負責，同時此樣品僅保留90天。本報告未經本公司書面許可，不可部份複製。

This document is issued by the Company subject to its General Conditions of Service printed overleaf, available on request or accessible at www.sgs.com/terms_and_conditions.htm and for electronic format documents, subject to Terms and Conditions for Electronic Documents at www.sgs.com/terms_e-document.htm. Attention is drawn to the limitation of liability, indemnification and jurisdiction issues defined therein. Any holder of this document is advised that information contained hereon reflects the Company's findings at the time of its intervention only and within the limits of Client's instructions, if any. The Company's sole responsibility is to its Client and this document does not exonerate parties to a transaction from exercising all their rights and obligations under the transaction documents. This document cannot be reproduced except in full, without prior written approval of the Company. Any unauthorized alteration, forgery or falsification of the content or appearance of this document is unlawful and offenders may be prosecuted to the fullest extent of the law.

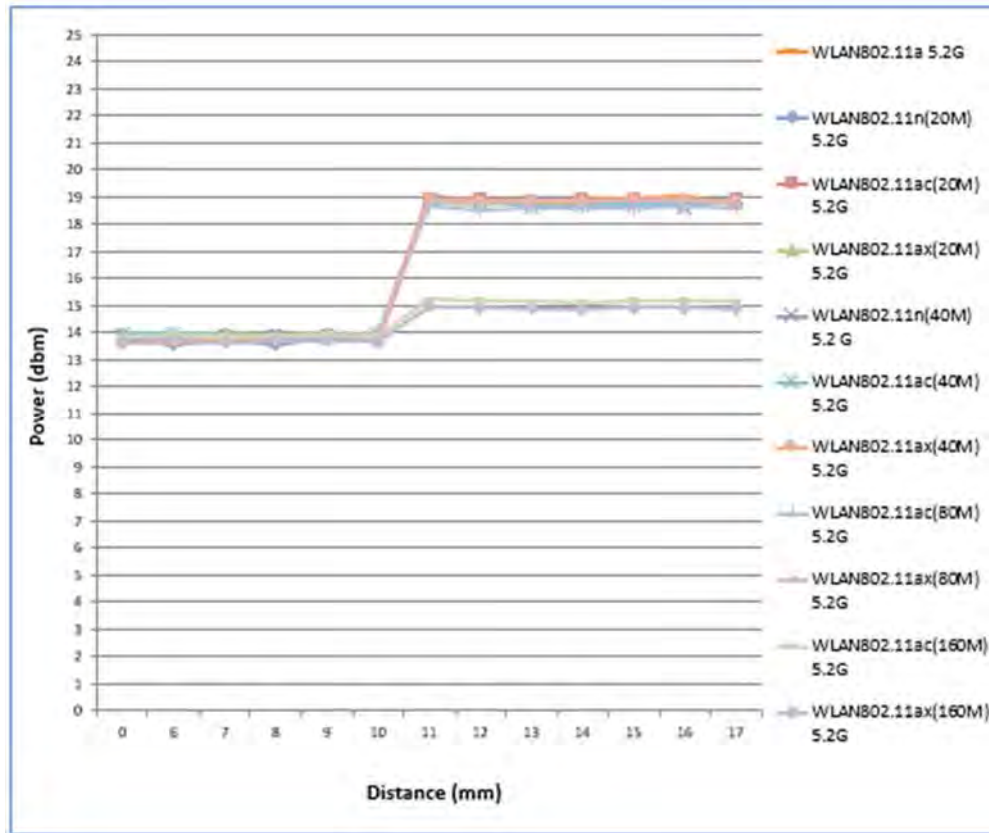

Unless otherwise stated the results shown in this test report refer only to the sample(s) tested and such sample(s) are retained for 90 days only.

除非另有說明，此報告結果僅對測試之樣品負責，同時此樣品僅保留90天。本報告未經本公司書面許可，不可部份複製。

This document is issued by the Company subject to its General Conditions of Service printed overleaf, available on request or accessible at www.sgs.com/terms_and_conditions.htm and for electronic format documents, subject to Terms and Conditions for Electronic Documents at www.sgs.com/terms_e-document.htm. Attention is drawn to the limitation of liability, indemnification and jurisdiction issues defined therein. Any holder of this document is advised that information contained hereon reflects the Company's findings at the time of its intervention only and within the limits of Client's instructions, if any. The Company's sole responsibility is to its Client and this document does not exonerate parties to a transaction from exercising all their rights and obligations under the transaction documents. This document cannot be reproduced except in full, without prior written approval of the Company. Any unauthorized alteration, forgery or falsification of the content or appearance of this document is unlawful and offenders may be prosecuted to the fullest extent of the law.

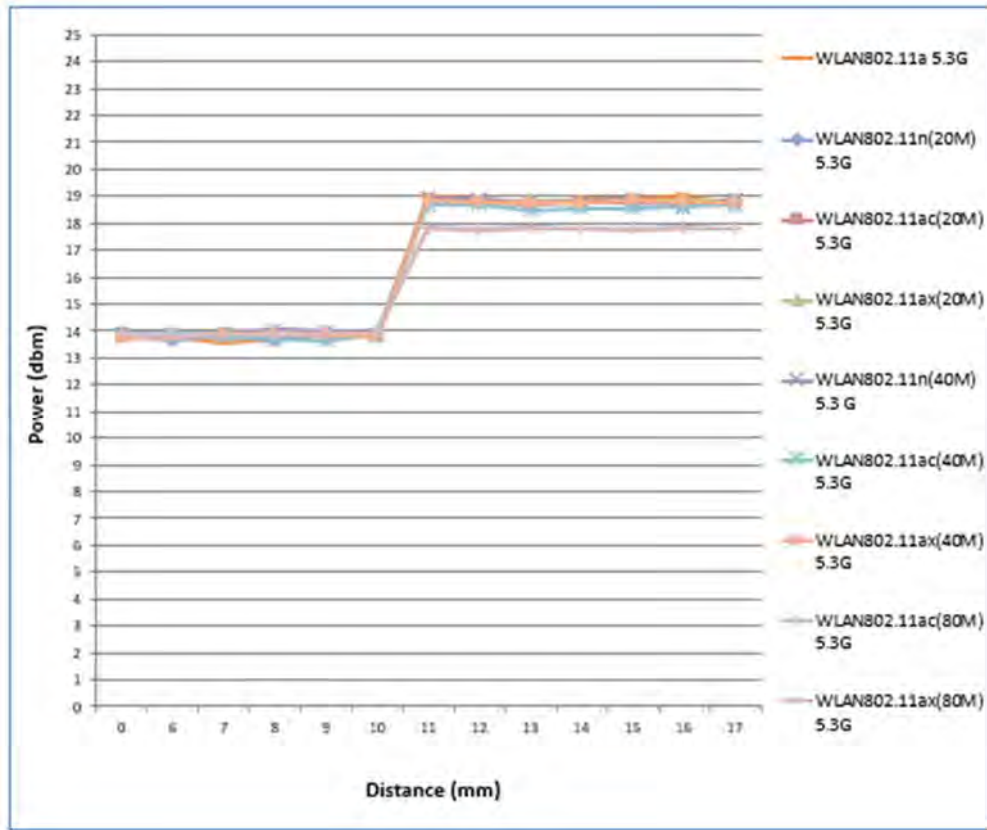

Unless otherwise stated the results shown in this test report refer only to the sample(s) tested and such sample(s) are retained for 90 days only.

除非另有說明，此報告結果僅對測試之樣品負責，同時此樣品僅保留90天。本報告未經本公司書面許可，不可部份複製。

This document is issued by the Company subject to its General Conditions of Service printed overleaf, available on request or accessible at www.sgs.com/terms_and_conditions.htm and for electronic format documents, subject to Terms and Conditions for Electronic Documents at www.sgs.com/terms_e-document.htm. Attention is drawn to the limitation of liability, indemnification and jurisdiction issues defined therein. Any holder of this document is advised that information contained hereon reflects the Company's findings at the time of its intervention only and within the limits of Client's instructions, if any. The Company's sole responsibility is to its Client and this document does not exonerate parties to a transaction from exercising all their rights and obligations under the transaction documents. This document cannot be reproduced except in full, without prior written approval of the Company. Any unauthorized alteration, forgery or falsification of the content or appearance of this document is unlawful and offenders may be prosecuted to the fullest extent of the law.

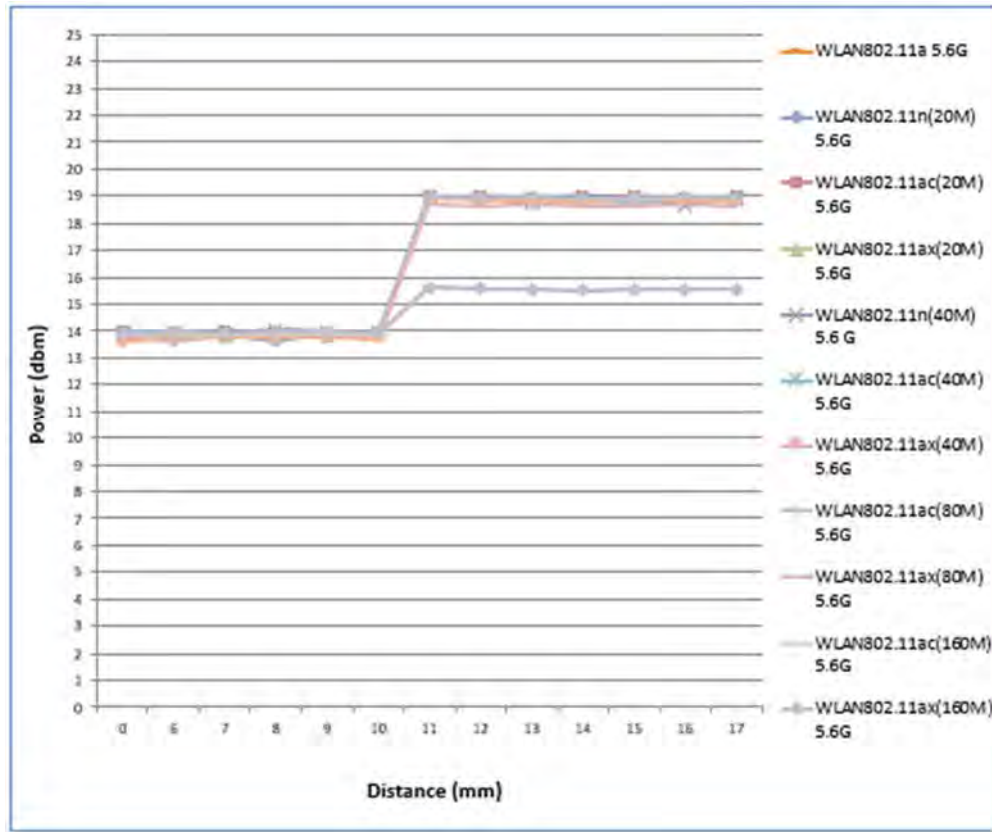

Unless otherwise stated the results shown in this test report refer only to the sample(s) tested and such sample(s) are retained for 90 days only.

除非另有說明，此報告結果僅對測試之樣品負責，同時此樣品僅保留90天。本報告未經本公司書面許可，不可部份複製。

This document is issued by the Company subject to its General Conditions of Service printed overleaf, available on request or accessible at www.sgs.com/terms_and_conditions.htm and for electronic format documents, subject to Terms and Conditions for Electronic Documents at www.sgs.com/terms_e-document.htm. Attention is drawn to the limitation of liability, indemnification and jurisdiction issues defined therein. Any holder of this document is advised that information contained hereon reflects the Company's findings at the time of its intervention only and within the limits of Client's instructions, if any. The Company's sole responsibility is to its Client and this document does not exonerate parties to a transaction from exercising all their rights and obligations under the transaction documents. This document cannot be reproduced except in full, without prior written approval of the Company. Any unauthorized alteration, forgery or falsification of the content or appearance of this document is unlawful and offenders may be prosecuted to the fullest extent of the law.

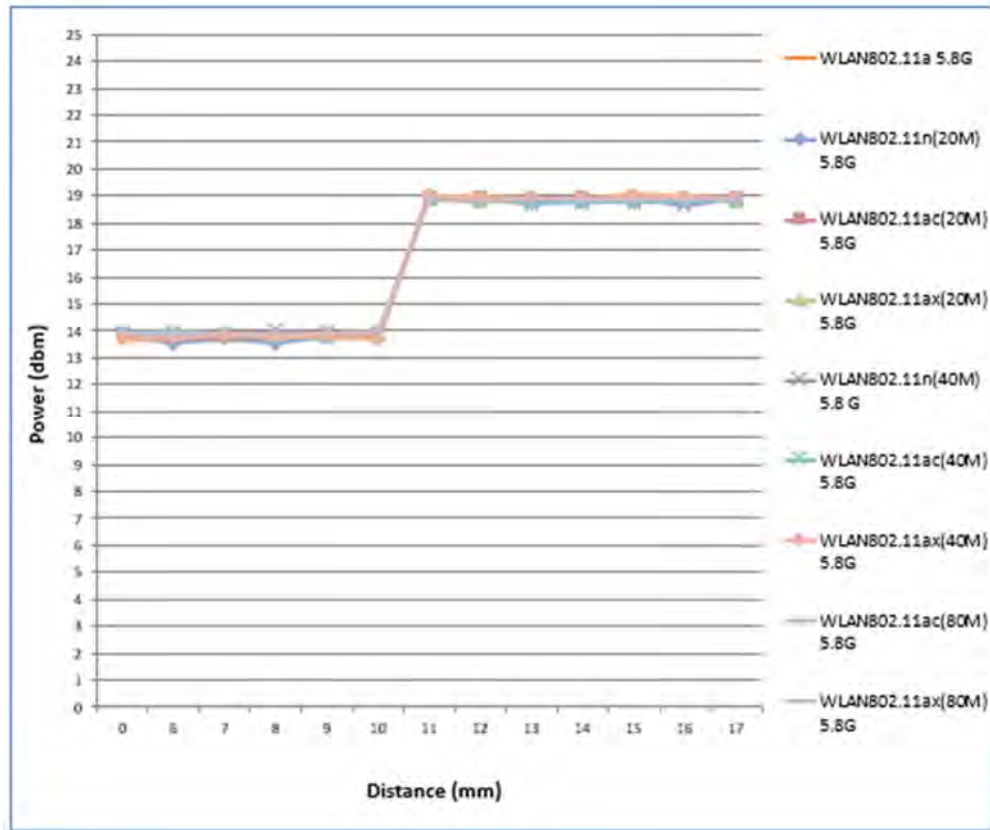

Unless otherwise stated the results shown in this test report refer only to the sample(s) tested and such sample(s) are retained for 90 days only.

除非另有說明，此報告結果僅對測試之樣品負責，同時此樣品僅保留90天。本報告未經本公司書面許可，不可部份複製。

This document is issued by the Company subject to its General Conditions of Service printed overleaf, available on request or accessible at www.sgs.com/terms_and_conditions.htm and for electronic format documents, subject to Terms and Conditions for Electronic Documents at www.sgs.com/terms_e-document.htm. Attention is drawn to the limitation of liability, indemnification and jurisdiction issues defined therein. Any holder of this document is advised that information contained hereon reflects the Company's findings at the time of its intervention only and within the limits of Client's instructions, if any. The Company's sole responsibility is to its Client and this document does not exonerate parties to a transaction from exercising all their rights and obligations under the transaction documents. This document cannot be reproduced except in full, without prior written approval of the Company. Any unauthorized alteration, forgery or falsification of the content or appearance of this document is unlawful and offenders may be prosecuted to the fullest extent of the law.

Tx1 (WWAN + WLAN)

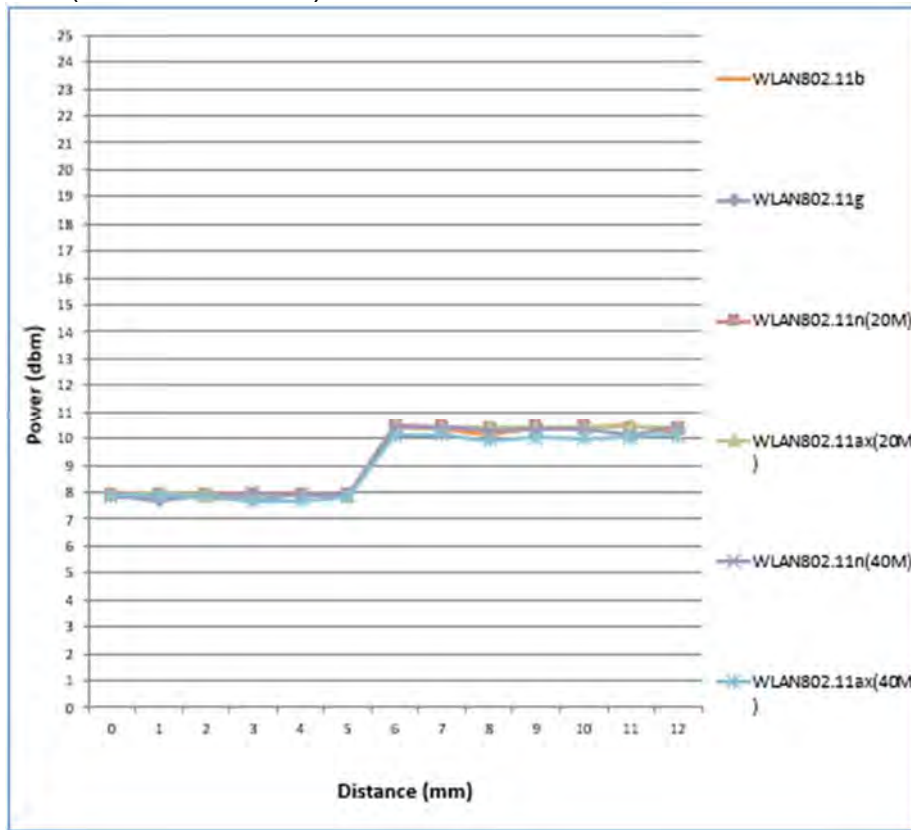

Unless otherwise stated the results shown in this test report refer only to the sample(s) tested and such sample(s) are retained for 90 days only.

除非另有說明，此報告結果僅對測試之樣品負責，同時此樣品僅保留90天。本報告未經本公司書面許可，不可部份複製。

This document is issued by the Company subject to its General Conditions of Service printed overleaf, available on request or accessible at www.sgs.com/terms_and_conditions.htm and for electronic format documents, subject to Terms and Conditions for Electronic Documents at www.sgs.com/terms_e-document.htm. Attention is drawn to the limitation of liability, indemnification and jurisdiction issues defined therein. Any holder of this document is advised that information contained hereon reflects the Company's findings at the time of its intervention only and within the limits of Client's instructions, if any. The Company's sole responsibility is to its Client and this document does not exonerate parties to a transaction from exercising all their rights and obligations under the transaction documents. This document cannot be reproduced except in full, without prior written approval of the Company. Any unauthorized alteration, forgery or falsification of the content or appearance of this document is unlawful and offenders may be prosecuted to the fullest extent of the law.

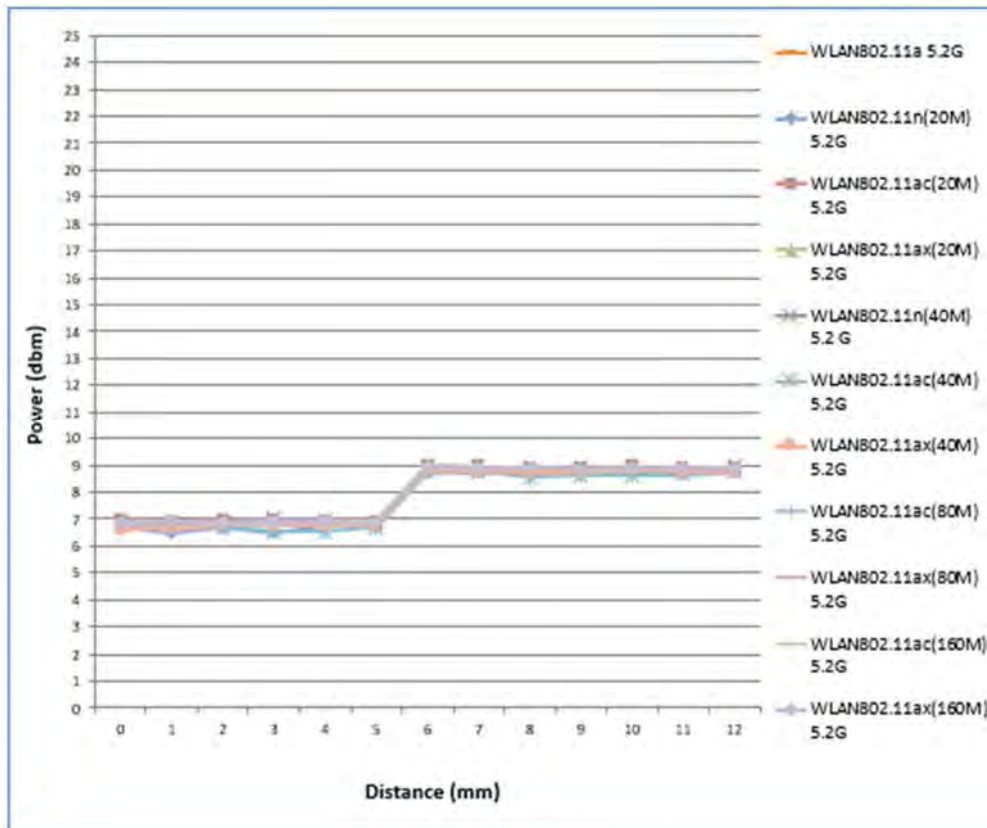

Unless otherwise stated the results shown in this test report refer only to the sample(s) tested and such sample(s) are retained for 90 days only.

除非另有說明，此報告結果僅對測試之樣品負責，同時此樣品僅保留90天。本報告未經本公司書面許可，不可部份複製。

This document is issued by the Company subject to its General Conditions of Service printed overleaf, available on request or accessible at www.sgs.com/terms_and_conditions.htm and for electronic format documents, subject to Terms and Conditions for Electronic Documents at www.sgs.com/terms_e-document.htm. Attention is drawn to the limitation of liability, indemnification and jurisdiction issues defined therein. Any holder of this document is advised that information contained hereon reflects the Company's findings at the time of its intervention only and within the limits of Client's instructions, if any. The Company's sole responsibility is to its Client and this document does not exonerate parties to a transaction from exercising all their rights and obligations under the transaction documents. This document cannot be reproduced except in full, without prior written approval of the Company. Any unauthorized alteration, forgery or falsification of the content or appearance of this document is unlawful and offenders may be prosecuted to the fullest extent of the law.

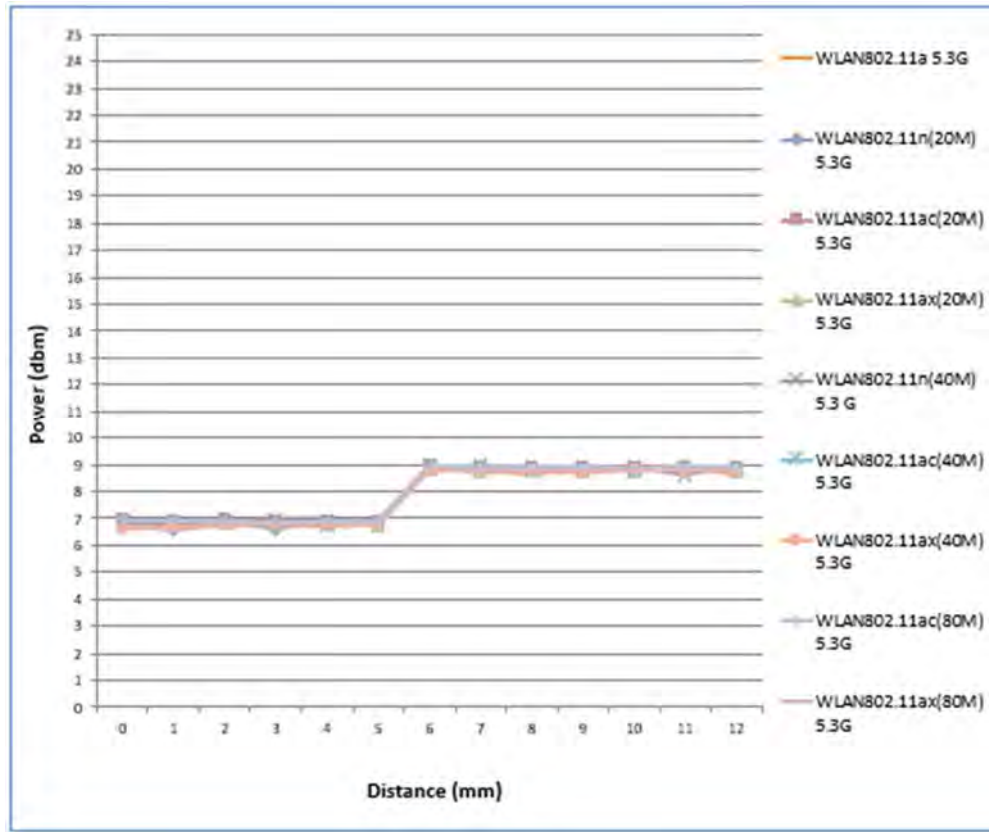

Unless otherwise stated the results shown in this test report refer only to the sample(s) tested and such sample(s) are retained for 90 days only.

除非另有說明，此報告結果僅對測試之樣品負責，同時此樣品僅保留90天。本報告未經本公司書面許可，不可部份複製。

This document is issued by the Company subject to its General Conditions of Service printed overleaf, available on request or accessible at www.sgs.com/terms_and_conditions.htm and for electronic format documents, subject to Terms and Conditions for Electronic Documents at www.sgs.com/terms_e-document.htm. Attention is drawn to the limitation of liability, indemnification and jurisdiction issues defined therein. Any holder of this document is advised that information contained hereon reflects the Company's findings at the time of its intervention only and within the limits of Client's instructions, if any. The Company's sole responsibility is to its Client and this document does not exonerate parties to a transaction from exercising all their rights and obligations under the transaction documents. This document cannot be reproduced except in full, without prior written approval of the Company. Any unauthorized alteration, forgery or falsification of the content or appearance of this document is unlawful and offenders may be prosecuted to the fullest extent of the law.

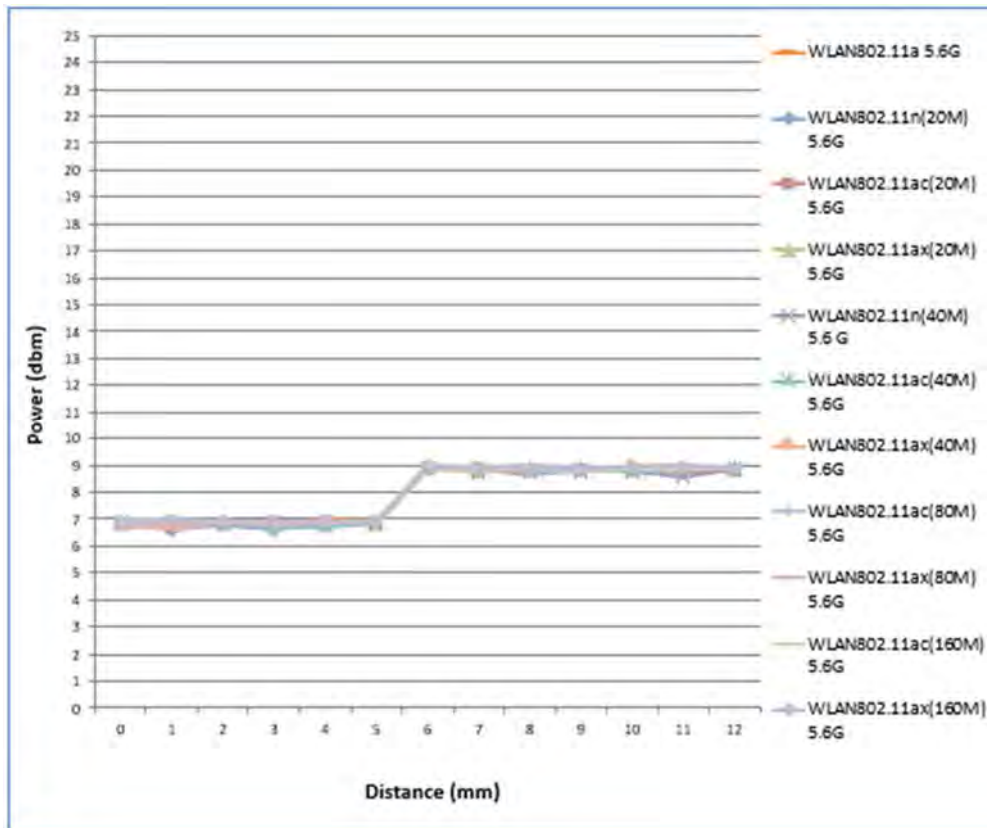

Unless otherwise stated the results shown in this test report refer only to the sample(s) tested and such sample(s) are retained for 90 days only.

除非另有說明，此報告結果僅對測試之樣品負責，同時此樣品僅保留90天。本報告未經本公司書面許可，不可部份複製。

This document is issued by the Company subject to its General Conditions of Service printed overleaf, available on request or accessible at www.sgs.com/terms_and_conditions.htm and for electronic format documents, subject to Terms and Conditions for Electronic Documents at www.sgs.com/terms_e-document.htm. Attention is drawn to the limitation of liability, indemnification and jurisdiction issues defined therein. Any holder of this document is advised that information contained hereon reflects the Company's findings at the time of its intervention only and within the limits of Client's instructions, if any. The Company's sole responsibility is to its Client and this document does not exonerate parties to a transaction from exercising all their rights and obligations under the transaction documents. This document cannot be reproduced except in full, without prior written approval of the Company. Any unauthorized alteration, forgery or falsification of the content or appearance of this document is unlawful and offenders may be prosecuted to the fullest extent of the law.

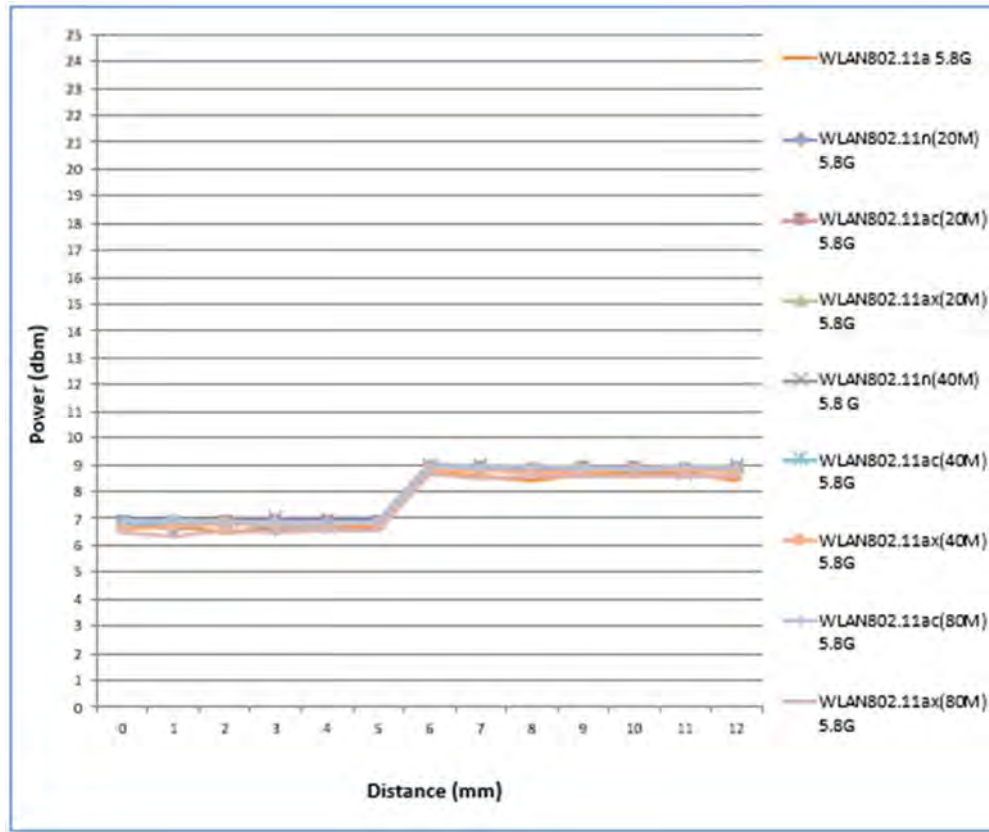

Unless otherwise stated the results shown in this test report refer only to the sample(s) tested and such sample(s) are retained for 90 days only.

除非另有說明，此報告結果僅對測試之樣品負責，同時此樣品僅保留90天。本報告未經本公司書面許可，不可部份複製。

This document is issued by the Company subject to its General Conditions of Service printed overleaf, available on request or accessible at www.sgs.com/terms_and_conditions.htm and for electronic format documents, subject to Terms and Conditions for Electronic Documents at www.sgs.com/terms_e-document.htm. Attention is drawn to the limitation of liability, indemnification and jurisdiction issues defined therein. Any holder of this document is advised that information contained hereon reflects the Company's findings at the time of its intervention only and within the limits of Client's instructions, if any. The Company's sole responsibility is to its Client and this document does not exonerate parties to a transaction from exercising all their rights and obligations under the transaction documents. This document cannot be reproduced except in full, without prior written approval of the Company. Any unauthorized alteration, forgery or falsification of the content or appearance of this document is unlawful and offenders may be prosecuted to the fullest extent of the law.

Tx2 (WWAN + WLAN)

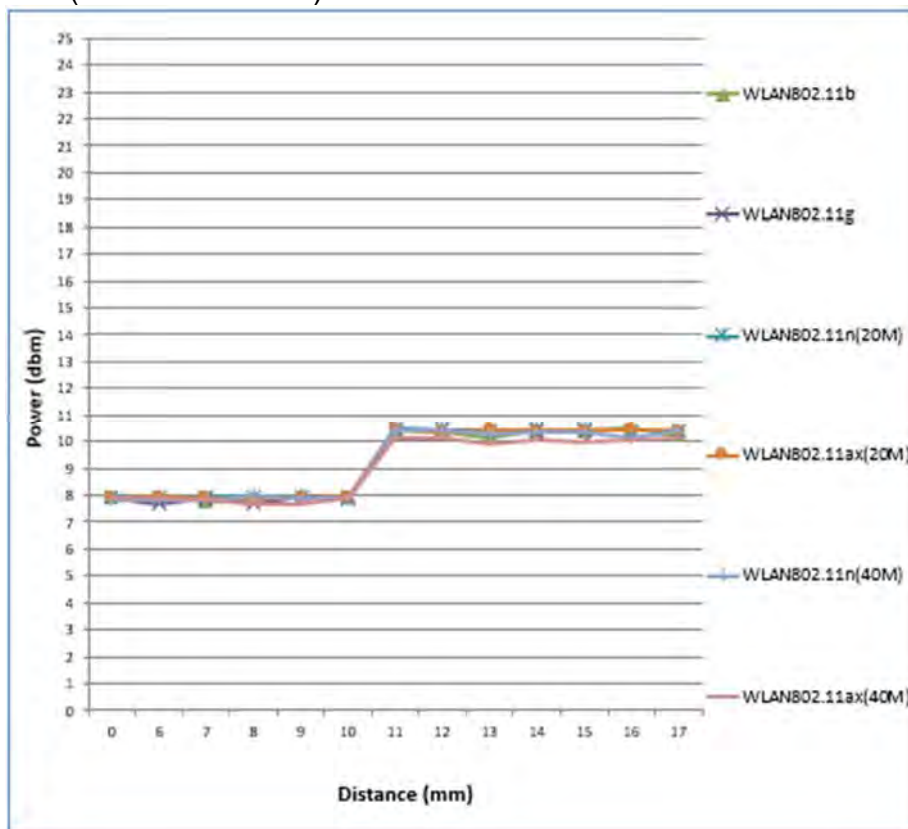

Unless otherwise stated the results shown in this test report refer only to the sample(s) tested and such sample(s) are retained for 90 days only.

除非另有說明，此報告結果僅對測試之樣品負責，同時此樣品僅保留90天。本報告未經本公司書面許可，不可部份複製。

This document is issued by the Company subject to its General Conditions of Service printed overleaf, available on request or accessible at www.sgs.com/terms_and_conditions.htm and for electronic format documents, subject to Terms and Conditions for Electronic Documents at www.sgs.com/terms_e-document.htm. Attention is drawn to the limitation of liability, indemnification and jurisdiction issues defined therein. Any holder of this document is advised that information contained hereon reflects the Company's findings at the time of its intervention only and within the limits of Client's instructions, if any. The Company's sole responsibility is to its Client and this document does not exonerate parties to a transaction from exercising all their rights and obligations under the transaction documents. This document cannot be reproduced except in full, without prior written approval of the Company. Any unauthorized alteration, forgery or falsification of the content or appearance of this document is unlawful and offenders may be prosecuted to the fullest extent of the law.

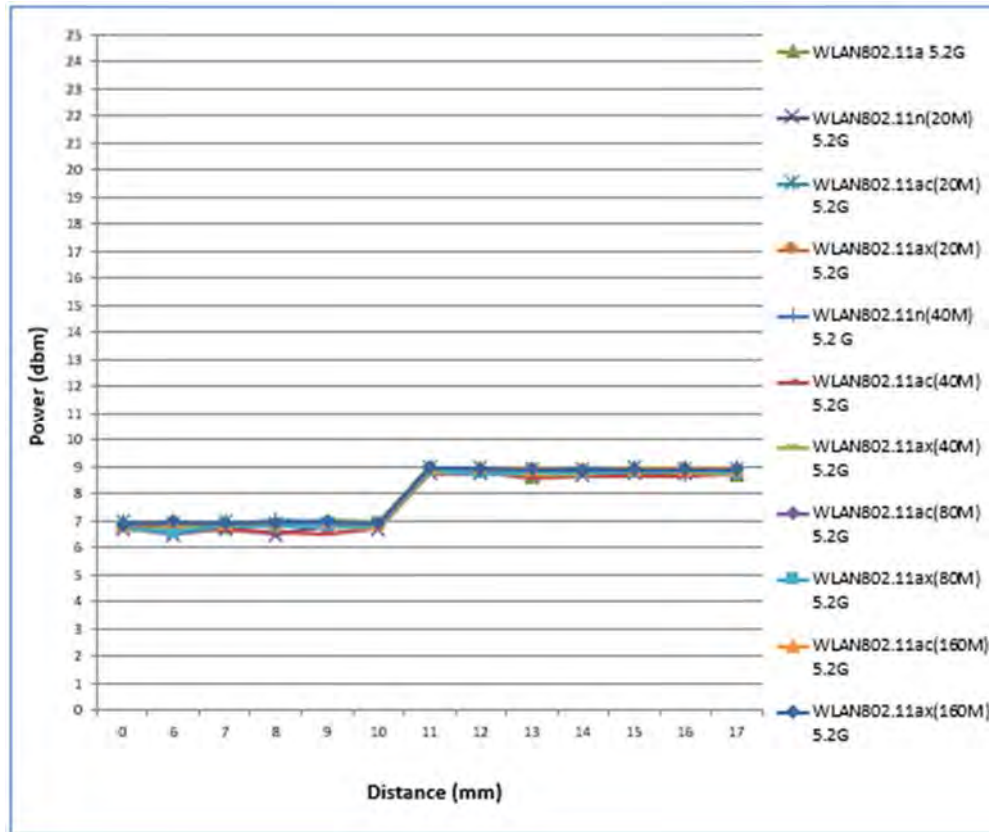

Unless otherwise stated the results shown in this test report refer only to the sample(s) tested and such sample(s) are retained for 90 days only.

除非另有說明，此報告結果僅對測試之樣品負責，同時此樣品僅保留90天。本報告未經本公司書面許可，不可部份複製。

This document is issued by the Company subject to its General Conditions of Service printed overleaf, available on request or accessible at www.sgs.com/terms_and_conditions.htm and for electronic format documents, subject to Terms and Conditions for Electronic Documents at www.sgs.com/terms_e-document.htm. Attention is drawn to the limitation of liability, indemnification and jurisdiction issues defined therein. Any holder of this document is advised that information contained hereon reflects the Company's findings at the time of its intervention only and within the limits of Client's instructions, if any. The Company's sole responsibility is to its Client and this document does not exonerate parties to a transaction from exercising all their rights and obligations under the transaction documents. This document cannot be reproduced except in full, without prior written approval of the Company. Any unauthorized alteration, forgery or falsification of the content or appearance of this document is unlawful and offenders may be prosecuted to the fullest extent of the law.

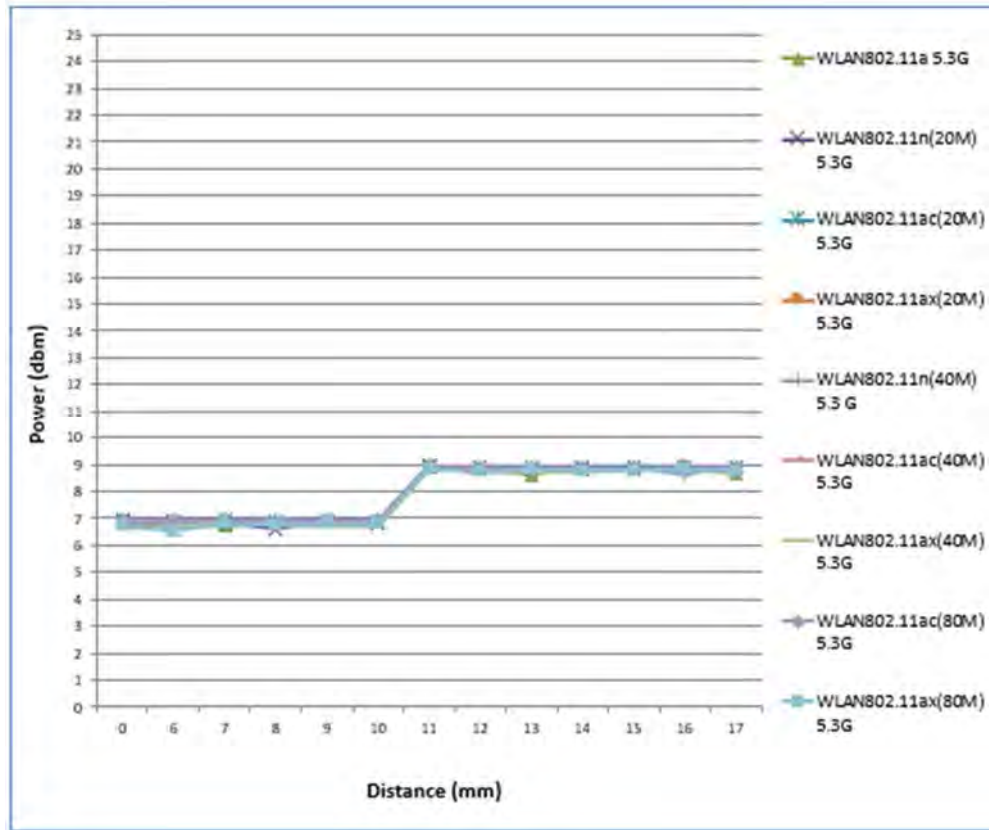

Unless otherwise stated the results shown in this test report refer only to the sample(s) tested and such sample(s) are retained for 90 days only.

除非另有說明，此報告結果僅對測試之樣品負責，同時此樣品僅保留90天。本報告未經本公司書面許可，不可部份複製。

This document is issued by the Company subject to its General Conditions of Service printed overleaf, available on request or accessible at www.sgs.com/terms_and_conditions.htm and for electronic format documents, subject to Terms and Conditions for Electronic Documents at www.sgs.com/terms_e-document.htm. Attention is drawn to the limitation of liability, indemnification and jurisdiction issues defined therein. Any holder of this document is advised that information contained hereon reflects the Company's findings at the time of its intervention only and within the limits of Client's instructions, if any. The Company's sole responsibility is to its Client and this document does not exonerate parties to a transaction from exercising all their rights and obligations under the transaction documents. This document cannot be reproduced except in full, without prior written approval of the Company. Any unauthorized alteration, forgery or falsification of the content or appearance of this document is unlawful and offenders may be prosecuted to the fullest extent of the law.

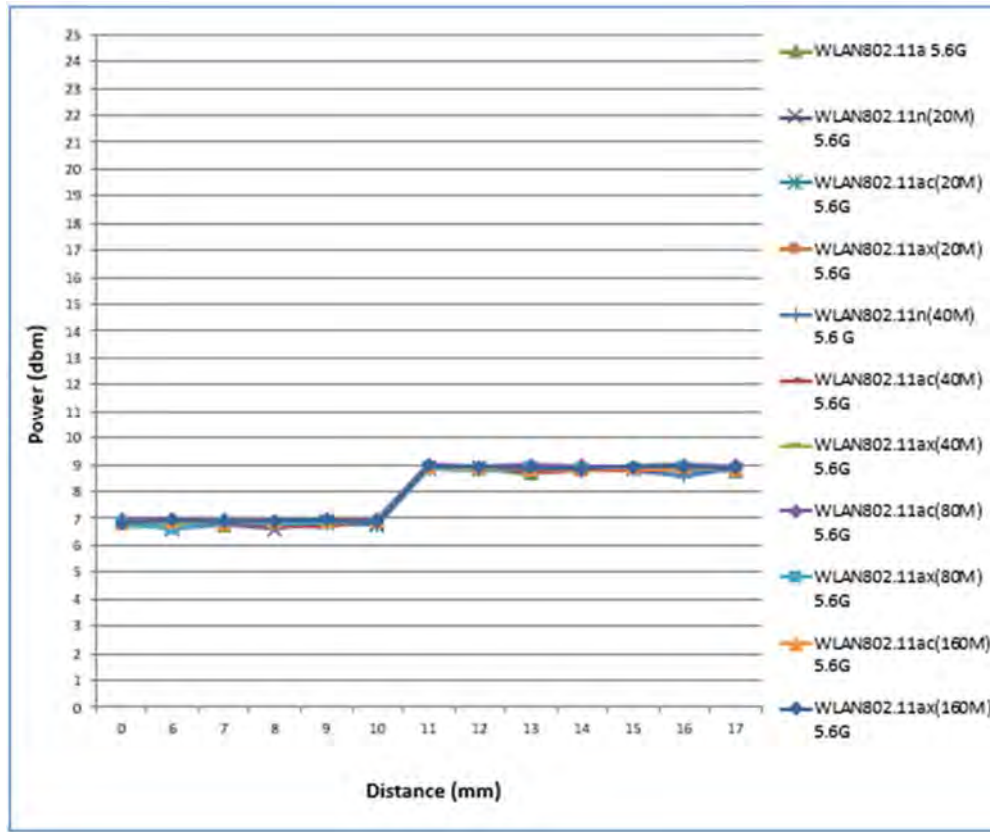

Unless otherwise stated the results shown in this test report refer only to the sample(s) tested and such sample(s) are retained for 90 days only.

除非另有說明，此報告結果僅對測試之樣品負責，同時此樣品僅保留90天。本報告未經本公司書面許可，不可部份複製。

This document is issued by the Company subject to its General Conditions of Service printed overleaf, available on request or accessible at www.sgs.com/terms_and_conditions.htm and for electronic format documents, subject to Terms and Conditions for Electronic Documents at www.sgs.com/terms_e-document.htm. Attention is drawn to the limitation of liability, indemnification and jurisdiction issues defined therein. Any holder of this document is advised that information contained hereon reflects the Company's findings at the time of its intervention only and within the limits of Client's instructions, if any. The Company's sole responsibility is to its Client and this document does not exonerate parties to a transaction from exercising all their rights and obligations under the transaction documents. This document cannot be reproduced except in full, without prior written approval of the Company. Any unauthorized alteration, forgery or falsification of the content or appearance of this document is unlawful and offenders may be prosecuted to the fullest extent of the law.

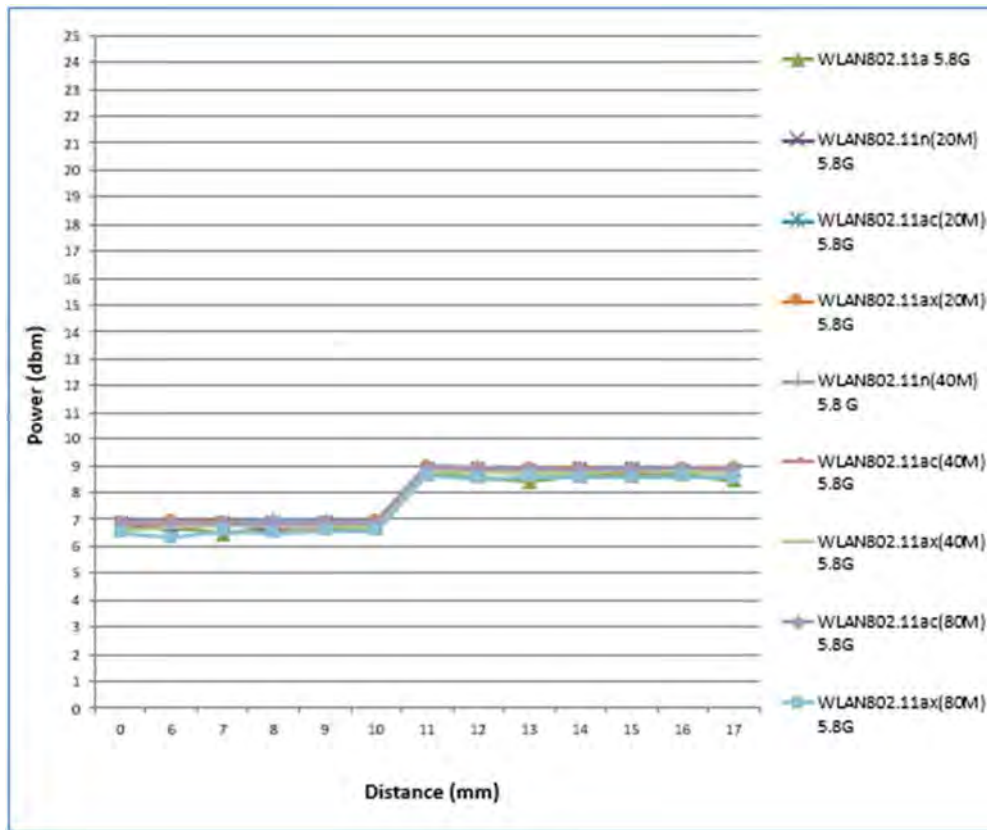

Unless otherwise stated the results shown in this test report refer only to the sample(s) tested and such sample(s) are retained for 90 days only.

除非另有說明，此報告結果僅對測試之樣品負責，同時此樣品僅保留90天。本報告未經本公司書面許可，不可部份複製。

This document is issued by the Company subject to its General Conditions of Service printed overleaf, available on request or accessible at www.sgs.com/terms_and_conditions.htm and for electronic format documents, subject to Terms and Conditions for Electronic Documents at www.sgs.com/terms_e-document.htm. Attention is drawn to the limitation of liability, indemnification and jurisdiction issues defined therein. Any holder of this document is advised that information contained hereon reflects the Company's findings at the time of its intervention only and within the limits of Client's instructions, if any. The Company's sole responsibility is to its Client and this document does not exonerate parties to a transaction from exercising all their rights and obligations under the transaction documents. This document cannot be reproduced except in full, without prior written approval of the Company. Any unauthorized alteration, forgery or falsification of the content or appearance of this document is unlawful and offenders may be prosecuted to the fullest extent of the law.

Moving device away from the phantom

WWAN

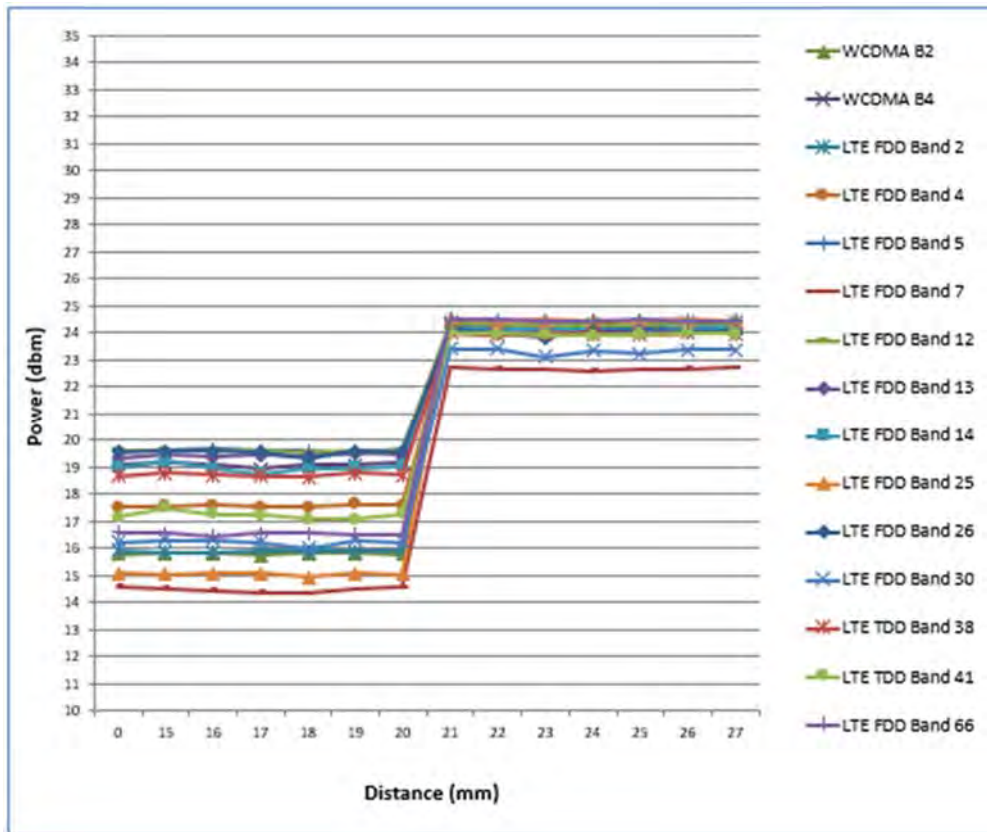

Unless otherwise stated the results shown in this test report refer only to the sample(s) tested and such sample(s) are retained for 90 days only.

除非另有說明，此報告結果僅對測試之樣品負責，同時此樣品僅保留90天。本報告未經本公司書面許可，不可部份複製。

This document is issued by the Company subject to its General Conditions of Service printed overleaf, available on request or accessible at www.sgs.com/terms_and_conditions.htm and for electronic format documents, subject to Terms and Conditions for Electronic Documents at www.sgs.com/terms_e-document.htm. Attention is drawn to the limitation of liability, indemnification and jurisdiction issues defined therein. Any holder of this document is advised that information contained hereon reflects the Company's findings at the time of its intervention only and within the limits of Client's instructions, if any. The Company's sole responsibility is to its Client and this document does not exonerate parties to a transaction from exercising all their rights and obligations under the transaction documents. This document cannot be reproduced except in full, without prior written approval of the Company. Any unauthorized alteration, forgery or falsification of the content or appearance of this document is unlawful and offenders may be prosecuted to the fullest extent of the law.

Tx1 (WLAN only)

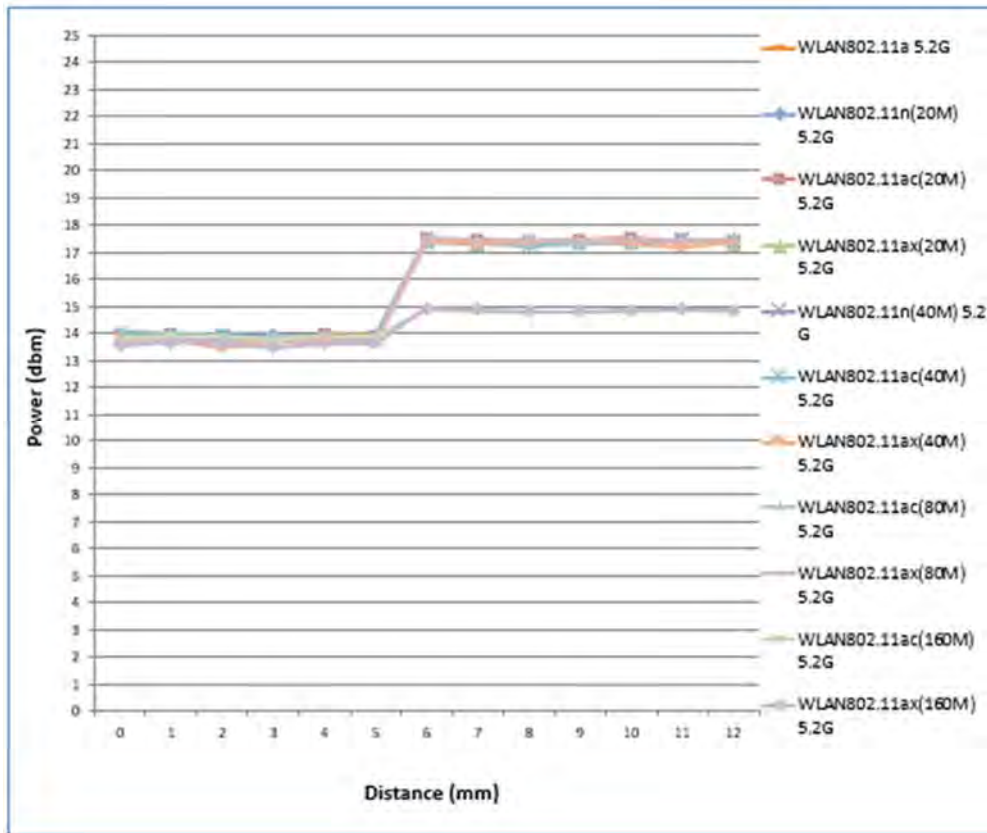

Unless otherwise stated the results shown in this test report refer only to the sample(s) tested and such sample(s) are retained for 90 days only.

除非另有說明，此報告結果僅對測試之樣品負責，同時此樣品僅保留90天。本報告未經本公司書面許可，不可部份複製。

This document is issued by the Company subject to its General Conditions of Service printed overleaf, available on request or accessible at www.sgs.com/terms_and_conditions.htm and for electronic format documents, subject to Terms and Conditions for Electronic Documents at www.sgs.com/terms_e-document.htm. Attention is drawn to the limitation of liability, indemnification and jurisdiction issues defined therein. Any holder of this document is advised that information contained hereon reflects the Company's findings at the time of its intervention only and within the limits of Client's instructions, if any. The Company's sole responsibility is to its Client and this document does not exonerate parties to a transaction from exercising all their rights and obligations under the transaction documents. This document cannot be reproduced except in full, without prior written approval of the Company. Any unauthorized alteration, forgery or falsification of the content or appearance of this document is unlawful and offenders may be prosecuted to the fullest extent of the law.

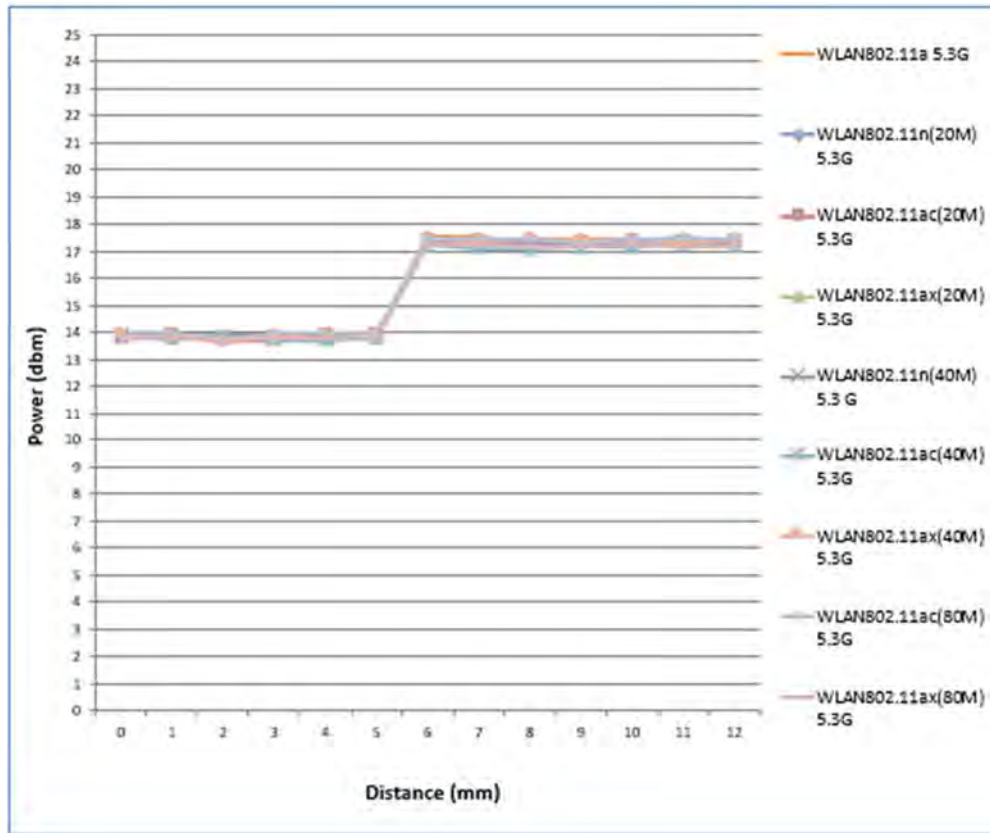

Unless otherwise stated the results shown in this test report refer only to the sample(s) tested and such sample(s) are retained for 90 days only.

除非另有說明，此報告結果僅對測試之樣品負責，同時此樣品僅保留90天。本報告未經本公司書面許可，不可部份複製。

This document is issued by the Company subject to its General Conditions of Service printed overleaf, available on request or accessible at www.sgs.com/terms_and_conditions.htm and for electronic format documents, subject to Terms and Conditions for Electronic Documents at www.sgs.com/terms_e-document.htm. Attention is drawn to the limitation of liability, indemnification and jurisdiction issues defined therein. Any holder of this document is advised that information contained hereon reflects the Company's findings at the time of its intervention only and within the limits of Client's instructions, if any. The Company's sole responsibility is to its Client and this document does not exonerate parties to a transaction from exercising all their rights and obligations under the transaction documents. This document cannot be reproduced except in full, without prior written approval of the Company. Any unauthorized alteration, forgery or falsification of the content or appearance of this document is unlawful and offenders may be prosecuted to the fullest extent of the law.

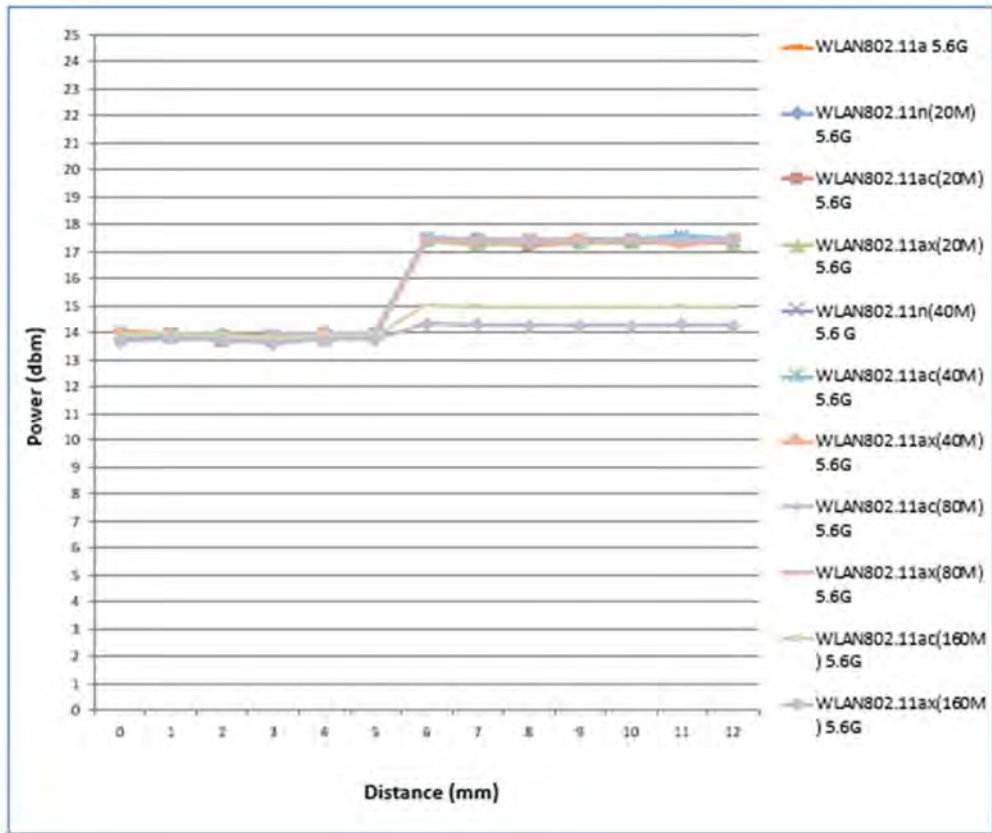

Unless otherwise stated the results shown in this test report refer only to the sample(s) tested and such sample(s) are retained for 90 days only.

除非另有說明，此報告結果僅對測試之樣品負責，同時此樣品僅保留90天。本報告未經本公司書面許可，不可部份複製。

This document is issued by the Company subject to its General Conditions of Service printed overleaf, available on request or accessible at www.sgs.com/terms_and_conditions.htm and for electronic format documents, subject to Terms and Conditions for Electronic Documents at www.sgs.com/terms_e-document.htm. Attention is drawn to the limitation of liability, indemnification and jurisdiction issues defined therein. Any holder of this document is advised that information contained hereon reflects the Company's findings at the time of its intervention only and within the limits of Client's instructions, if any. The Company's sole responsibility is to its Client and this document does not exonerate parties to a transaction from exercising all their rights and obligations under the transaction documents. This document cannot be reproduced except in full, without prior written approval of the Company. Any unauthorized alteration, forgery or falsification of the content or appearance of this document is unlawful and offenders may be prosecuted to the fullest extent of the law.

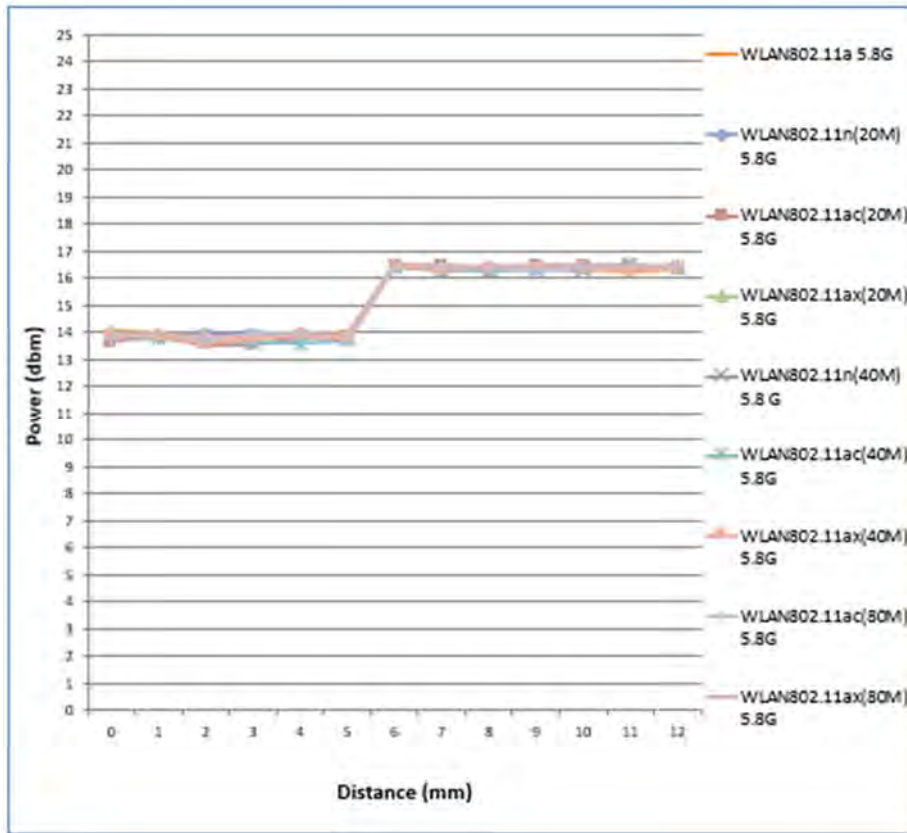

Unless otherwise stated the results shown in this test report refer only to the sample(s) tested and such sample(s) are retained for 90 days only.

除非另有說明，此報告結果僅對測試之樣品負責，同時此樣品僅保留90天。本報告未經本公司書面許可，不可部份複製。

This document is issued by the Company subject to its General Conditions of Service printed overleaf, available on request or accessible at www.sgs.com/terms_and_conditions.htm and for electronic format documents, subject to Terms and Conditions for Electronic Documents at www.sgs.com/terms_e-document.htm. Attention is drawn to the limitation of liability, indemnification and jurisdiction issues defined therein. Any holder of this document is advised that information contained hereon reflects the Company's findings at the time of its intervention only and within the limits of Client's instructions, if any. The Company's sole responsibility is to its Client and this document does not exonerate parties to a transaction from exercising all their rights and obligations under the transaction documents. This document cannot be reproduced except in full, without prior written approval of the Company. Any unauthorized alteration, forgery or falsification of the content or appearance of this document is unlawful and offenders may be prosecuted to the fullest extent of the law.

Tx2 (WLAN only)

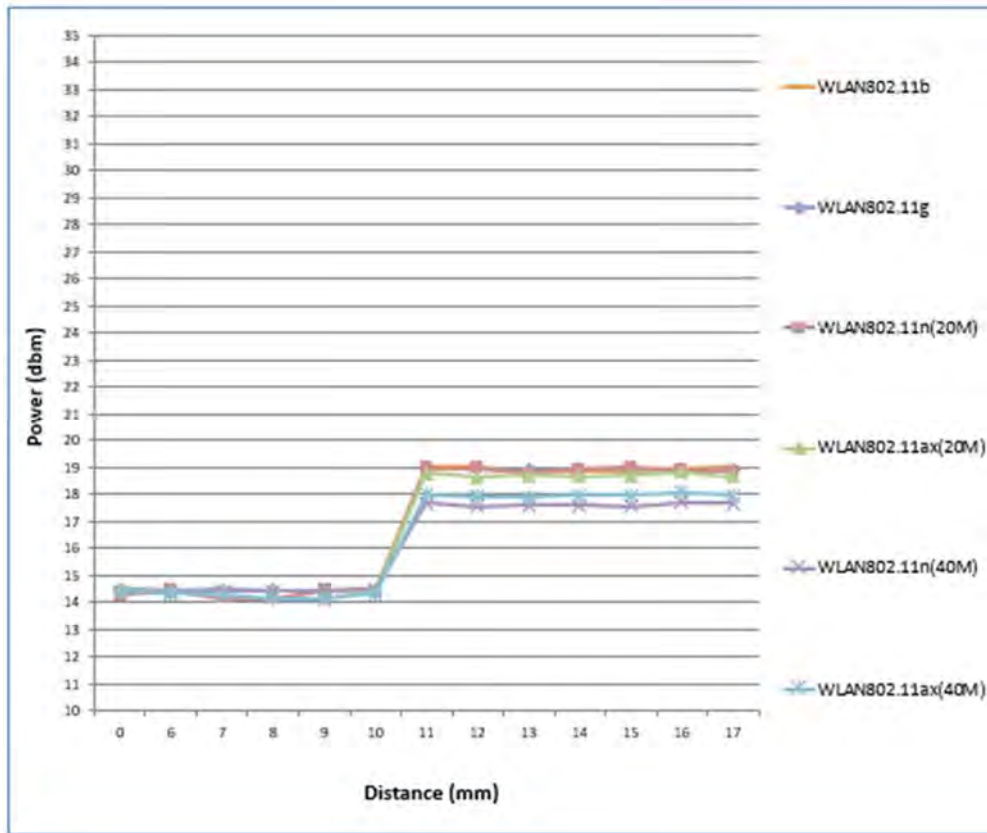

Unless otherwise stated the results shown in this test report refer only to the sample(s) tested and such sample(s) are retained for 90 days only.

除非另有說明，此報告結果僅對測試之樣品負責，同時此樣品僅保留90天。本報告未經本公司書面許可，不可部份複製。

This document is issued by the Company subject to its General Conditions of Service printed overleaf, available on request or accessible at www.sgs.com/terms_and_conditions.htm and for electronic format documents, subject to Terms and Conditions for Electronic Documents at www.sgs.com/terms_e-document.htm. Attention is drawn to the limitation of liability, indemnification and jurisdiction issues defined therein. Any holder of this document is advised that information contained hereon reflects the Company's findings at the time of its intervention only and within the limits of Client's instructions, if any. The Company's sole responsibility is to its Client and this document does not exonerate parties to a transaction from exercising all their rights and obligations under the transaction documents. This document cannot be reproduced except in full, without prior written approval of the Company. Any unauthorized alteration, forgery or falsification of the content or appearance of this document is unlawful and offenders may be prosecuted to the fullest extent of the law.

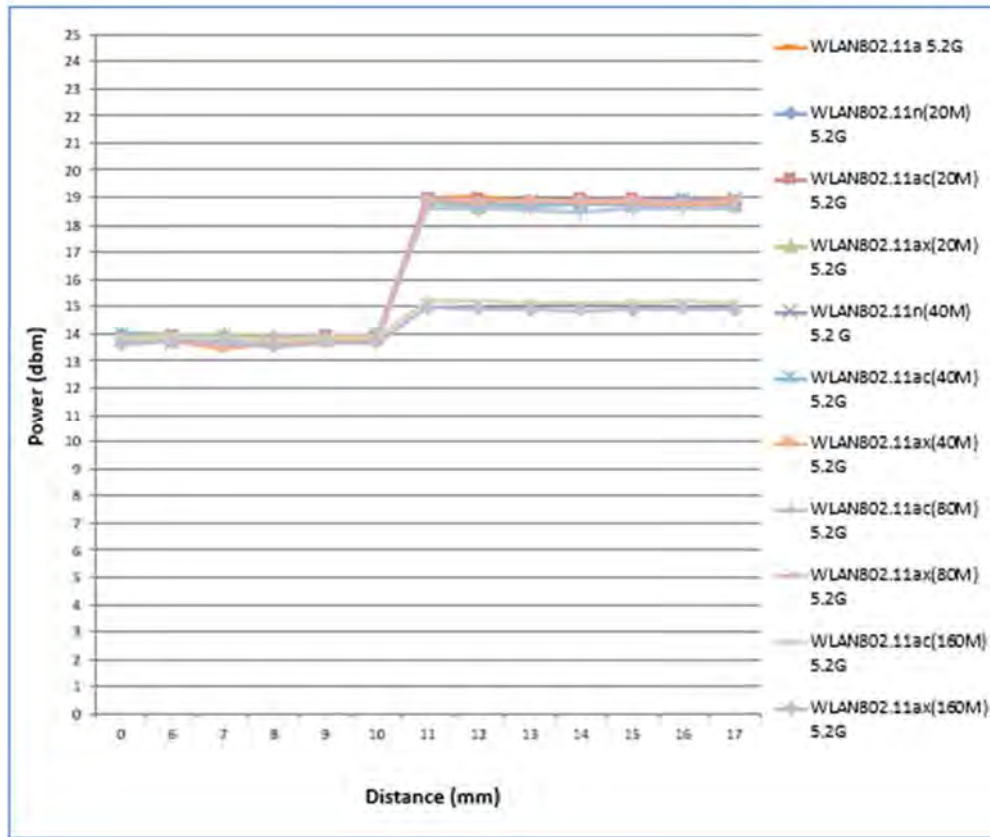

Unless otherwise stated the results shown in this test report refer only to the sample(s) tested and such sample(s) are retained for 90 days only.

除非另有說明，此報告結果僅對測試之樣品負責，同時此樣品僅保留90天。本報告未經本公司書面許可，不可部份複製。

This document is issued by the Company subject to its General Conditions of Service printed overleaf, available on request or accessible at www.sgs.com/terms_and_conditions.htm and for electronic format documents, subject to Terms and Conditions for Electronic Documents at www.sgs.com/terms_e-document.htm. Attention is drawn to the limitation of liability, indemnification and jurisdiction issues defined therein. Any holder of this document is advised that information contained hereon reflects the Company's findings at the time of its intervention only and within the limits of Client's instructions, if any. The Company's sole responsibility is to its Client and this document does not exonerate parties to a transaction from exercising all their rights and obligations under the transaction documents. This document cannot be reproduced except in full, without prior written approval of the Company. Any unauthorized alteration, forgery or falsification of the content or appearance of this document is unlawful and offenders may be prosecuted to the fullest extent of the law.

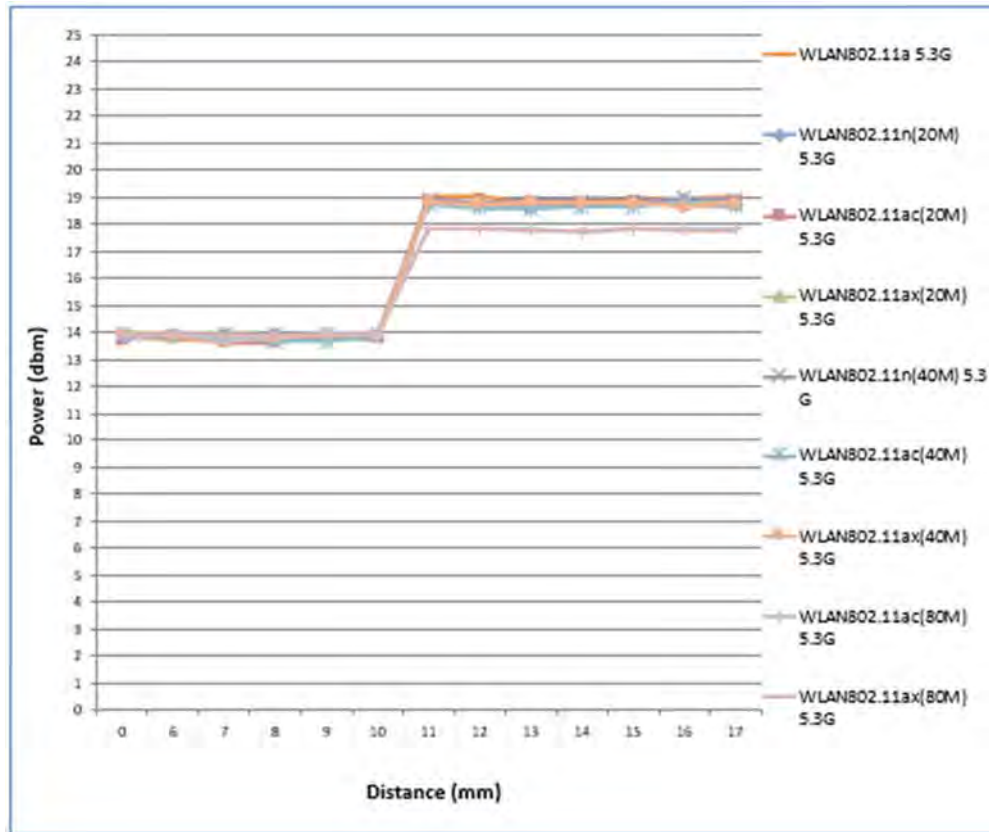

Unless otherwise stated the results shown in this test report refer only to the sample(s) tested and such sample(s) are retained for 90 days only.

除非另有說明，此報告結果僅對測試之樣品負責，同時此樣品僅保留90天。本報告未經本公司書面許可，不可部份複製。

This document is issued by the Company subject to its General Conditions of Service printed overleaf, available on request or accessible at www.sgs.com/terms_and_conditions.htm and for electronic format documents, subject to Terms and Conditions for Electronic Documents at www.sgs.com/terms_e-document.htm. Attention is drawn to the limitation of liability, indemnification and jurisdiction issues defined therein. Any holder of this document is advised that information contained hereon reflects the Company's findings at the time of its intervention only and within the limits of Client's instructions, if any. The Company's sole responsibility is to its Client and this document does not exonerate parties to a transaction from exercising all their rights and obligations under the transaction documents. This document cannot be reproduced except in full, without prior written approval of the Company. Any unauthorized alteration, forgery or falsification of the content or appearance of this document is unlawful and offenders may be prosecuted to the fullest extent of the law.

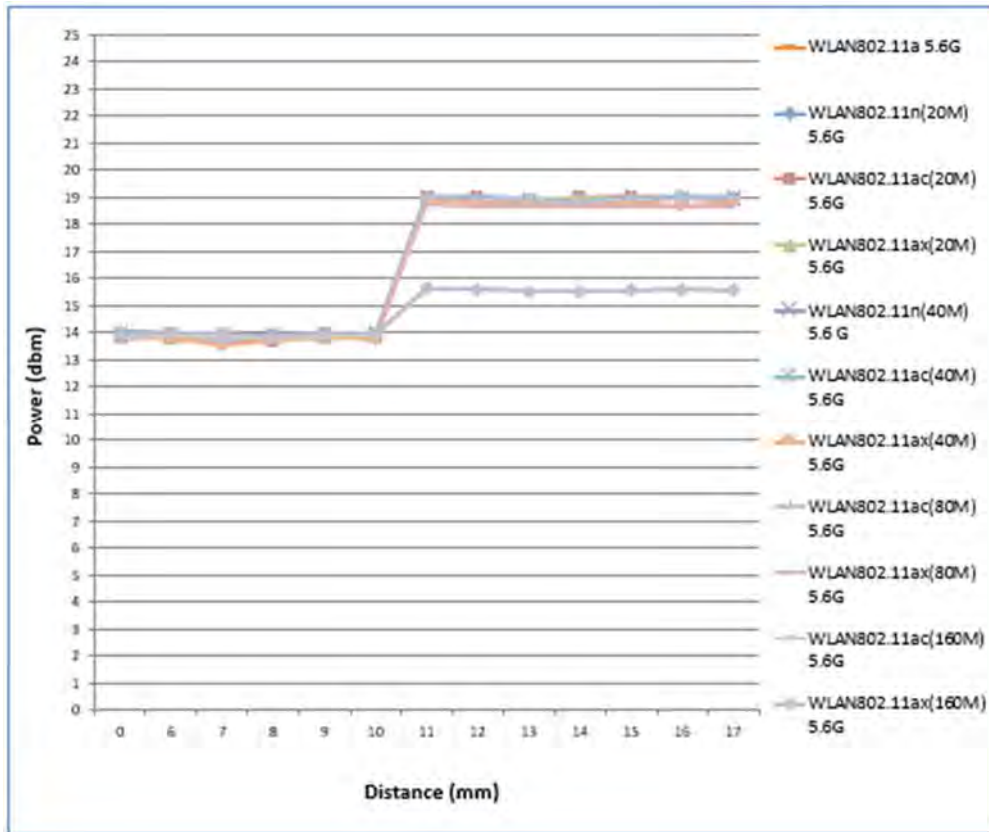

Unless otherwise stated the results shown in this test report refer only to the sample(s) tested and such sample(s) are retained for 90 days only.

除非另有說明，此報告結果僅對測試之樣品負責，同時此樣品僅保留90天。本報告未經本公司書面許可，不可部份複製。

This document is issued by the Company subject to its General Conditions of Service printed overleaf, available on request or accessible at www.sgs.com/terms_and_conditions.htm and for electronic format documents, subject to Terms and Conditions for Electronic Documents at www.sgs.com/terms_e-document.htm. Attention is drawn to the limitation of liability, indemnification and jurisdiction issues defined therein. Any holder of this document is advised that information contained hereon reflects the Company's findings at the time of its intervention only and within the limits of Client's instructions, if any. The Company's sole responsibility is to its Client and this document does not exonerate parties to a transaction from exercising all their rights and obligations under the transaction documents. This document cannot be reproduced except in full, without prior written approval of the Company. Any unauthorized alteration, forgery or falsification of the content or appearance of this document is unlawful and offenders may be prosecuted to the fullest extent of the law.

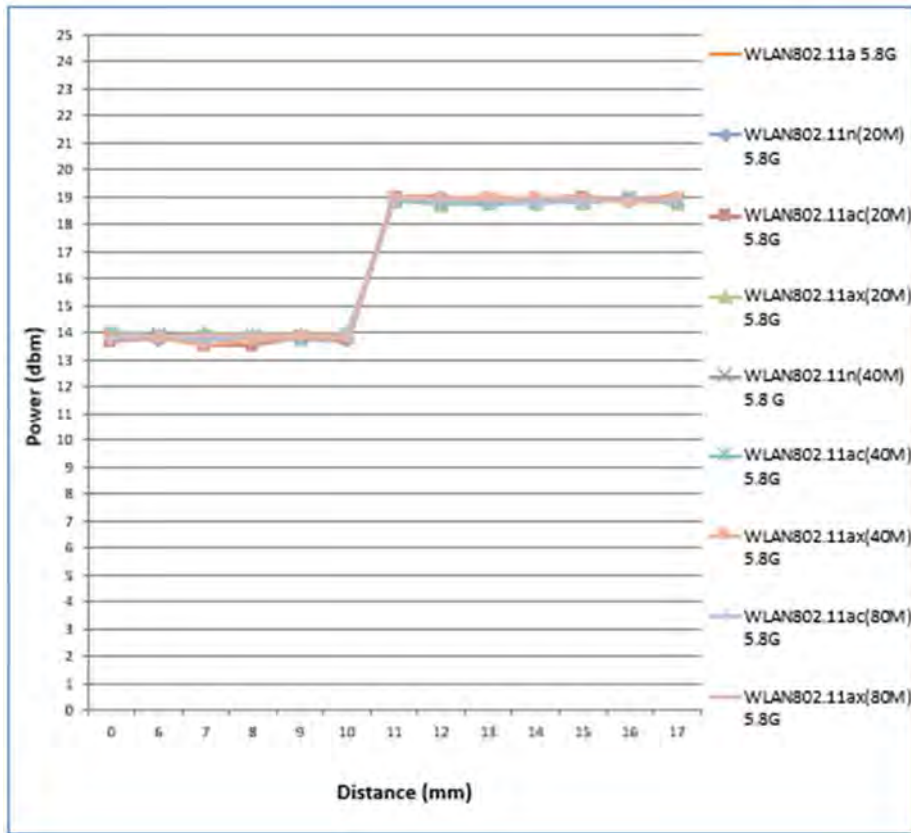

Unless otherwise stated the results shown in this test report refer only to the sample(s) tested and such sample(s) are retained for 90 days only.

除非另有說明，此報告結果僅對測試之樣品負責，同時此樣品僅保留90天。本報告未經本公司書面許可，不可部份複製。

This document is issued by the Company subject to its General Conditions of Service printed overleaf, available on request or accessible at www.sgs.com/terms_and_conditions.htm and for electronic format documents, subject to Terms and Conditions for Electronic Documents at www.sgs.com/terms_e-document.htm. Attention is drawn to the limitation of liability, indemnification and jurisdiction issues defined therein. Any holder of this document is advised that information contained hereon reflects the Company's findings at the time of its intervention only and within the limits of Client's instructions, if any. The Company's sole responsibility is to its Client and this document does not exonerate parties to a transaction from exercising all their rights and obligations under the transaction documents. This document cannot be reproduced except in full, without prior written approval of the Company. Any unauthorized alteration, forgery or falsification of the content or appearance of this document is unlawful and offenders may be prosecuted to the fullest extent of the law.

Tx1 (WWAN + WLAN)

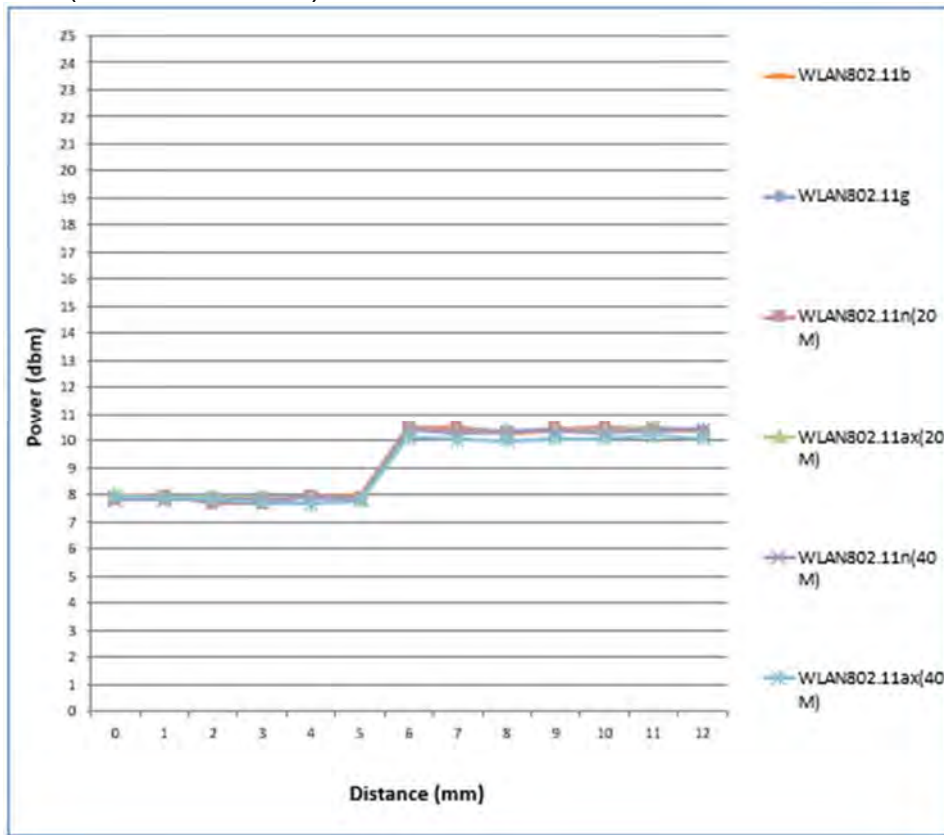

Unless otherwise stated the results shown in this test report refer only to the sample(s) tested and such sample(s) are retained for 90 days only.

除非另有說明，此報告結果僅對測試之樣品負責，同時此樣品僅保留90天。本報告未經本公司書面許可，不可部份複製。

This document is issued by the Company subject to its General Conditions of Service printed overleaf, available on request or accessible at www.sgs.com/terms_and_conditions.htm and for electronic format documents, subject to Terms and Conditions for Electronic Documents at www.sgs.com/terms_e-document.htm. Attention is drawn to the limitation of liability, indemnification and jurisdiction issues defined therein. Any holder of this document is advised that information contained hereon reflects the Company's findings at the time of its intervention only and within the limits of Client's instructions, if any. The Company's sole responsibility is to its Client and this document does not exonerate parties to a transaction from exercising all their rights and obligations under the transaction documents. This document cannot be reproduced except in full, without prior written approval of the Company. Any unauthorized alteration, forgery or falsification of the content or appearance of this document is unlawful and offenders may be prosecuted to the fullest extent of the law.

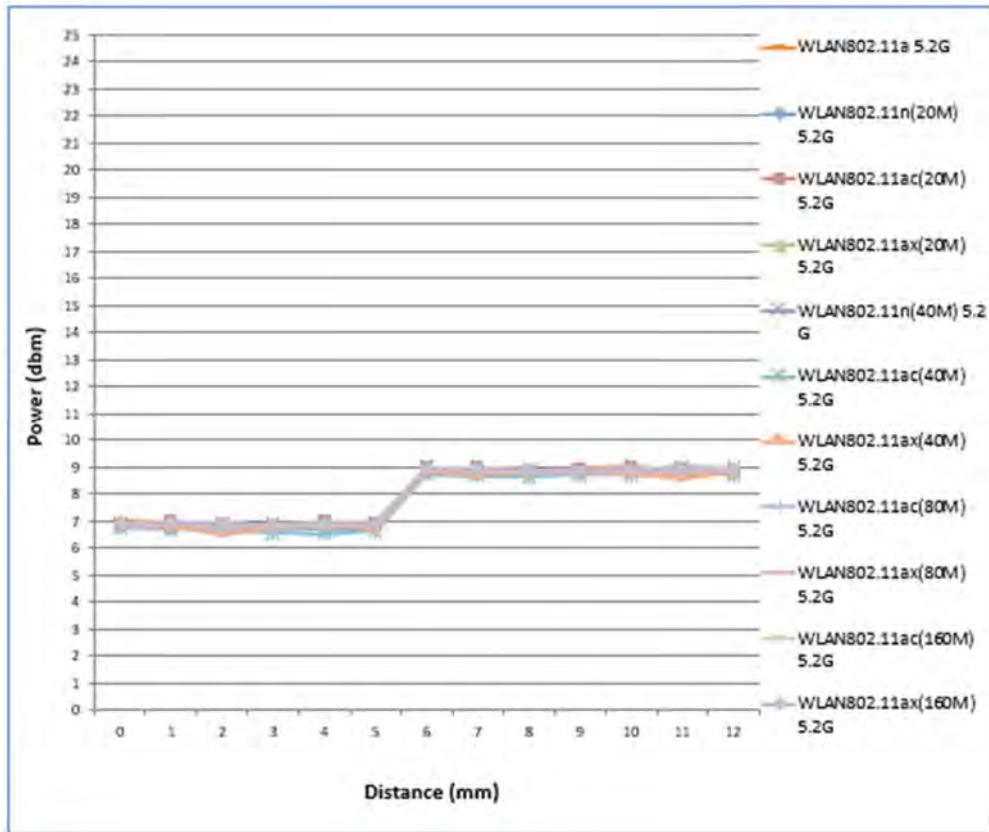

Unless otherwise stated the results shown in this test report refer only to the sample(s) tested and such sample(s) are retained for 90 days only.

除非另有說明，此報告結果僅對測試之樣品負責，同時此樣品僅保留90天。本報告未經本公司書面許可，不可部份複製。

This document is issued by the Company subject to its General Conditions of Service printed overleaf, available on request or accessible at www.sgs.com/terms_and_conditions.htm and for electronic format documents, subject to Terms and Conditions for Electronic Documents at www.sgs.com/terms_e-document.htm. Attention is drawn to the limitation of liability, indemnification and jurisdiction issues defined therein. Any holder of this document is advised that information contained hereon reflects the Company's findings at the time of its intervention only and within the limits of Client's instructions, if any. The Company's sole responsibility is to its Client and this document does not exonerate parties to a transaction from exercising all their rights and obligations under the transaction documents. This document cannot be reproduced except in full, without prior written approval of the Company. Any unauthorized alteration, forgery or falsification of the content or appearance of this document is unlawful and offenders may be prosecuted to the fullest extent of the law.

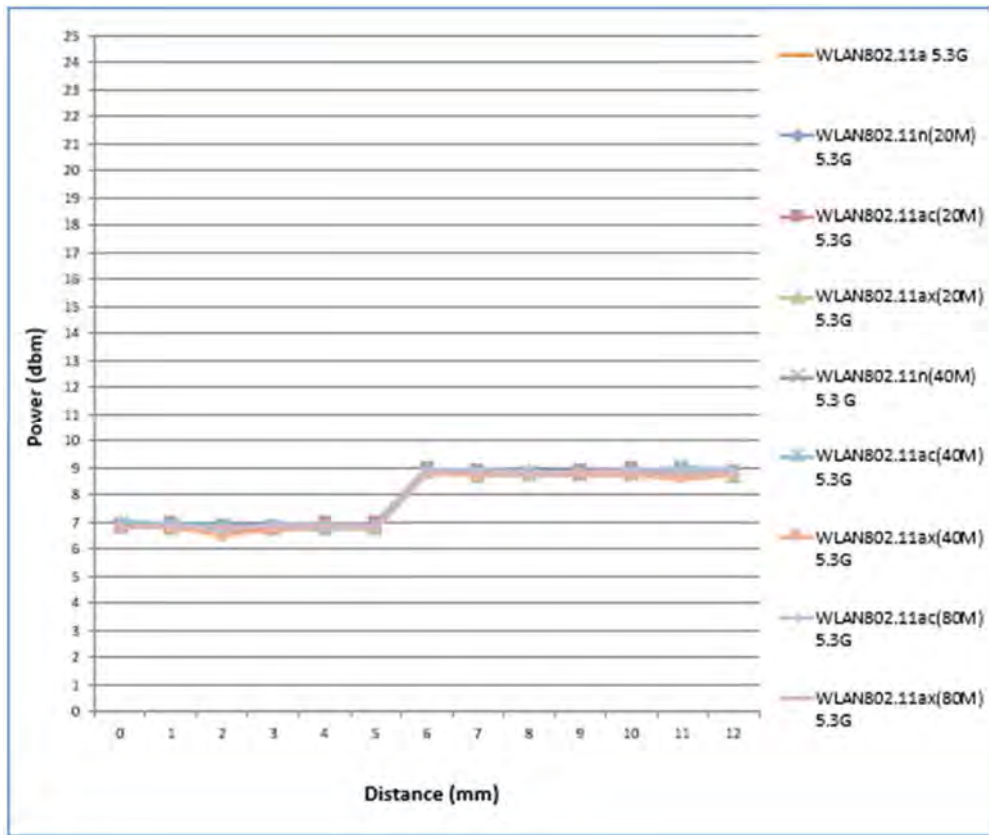

Unless otherwise stated the results shown in this test report refer only to the sample(s) tested and such sample(s) are retained for 90 days only.

除非另有說明，此報告結果僅對測試之樣品負責，同時此樣品僅保留90天。本報告未經本公司書面許可，不可部份複製。

This document is issued by the Company subject to its General Conditions of Service printed overleaf, available on request or accessible at www.sgs.com/terms_and_conditions.htm and for electronic format documents, subject to Terms and Conditions for Electronic Documents at www.sgs.com/terms_e-document.htm. Attention is drawn to the limitation of liability, indemnification and jurisdiction issues defined therein. Any holder of this document is advised that information contained hereon reflects the Company's findings at the time of its intervention only and within the limits of Client's instructions, if any. The Company's sole responsibility is to its Client and this document does not exonerate parties to a transaction from exercising all their rights and obligations under the transaction documents. This document cannot be reproduced except in full, without prior written approval of the Company. Any unauthorized alteration, forgery or falsification of the content or appearance of this document is unlawful and offenders may be prosecuted to the fullest extent of the law.

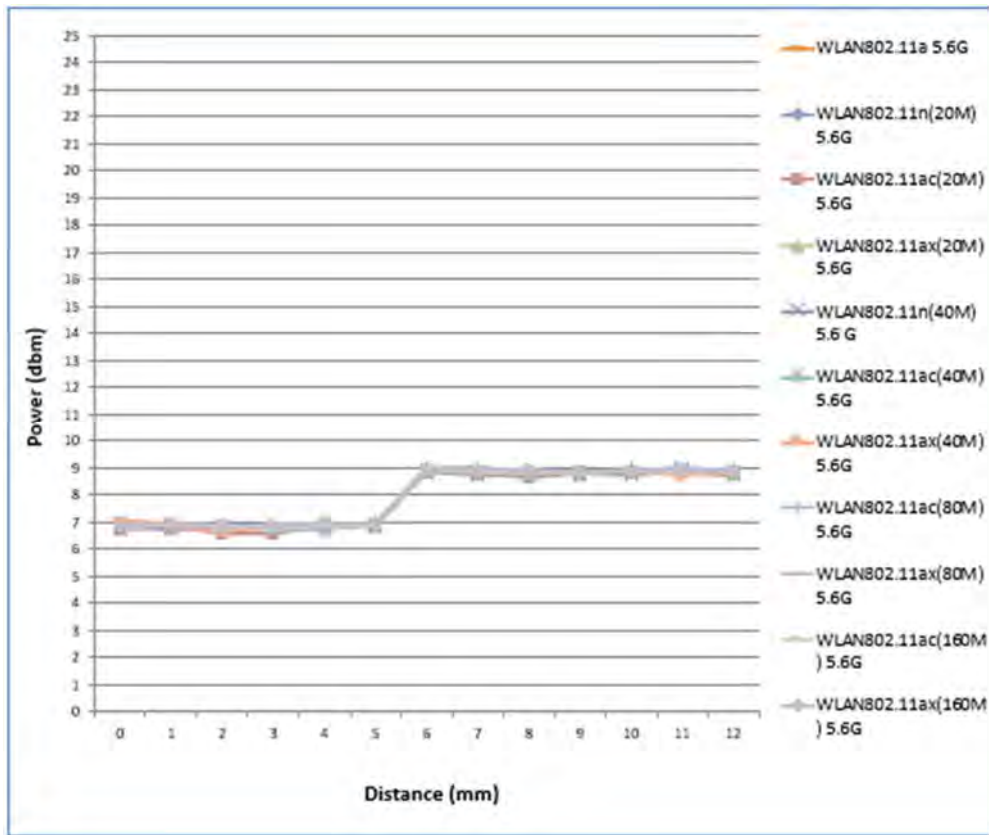

Unless otherwise stated the results shown in this test report refer only to the sample(s) tested and such sample(s) are retained for 90 days only.

除非另有說明，此報告結果僅對測試之樣品負責，同時此樣品僅保留90天。本報告未經本公司書面許可，不可部份複製。

This document is issued by the Company subject to its General Conditions of Service printed overleaf, available on request or accessible at www.sgs.com/terms_and_conditions.htm and for electronic format documents, subject to Terms and Conditions for Electronic Documents at www.sgs.com/terms_e-document.htm. Attention is drawn to the limitation of liability, indemnification and jurisdiction issues defined therein. Any holder of this document is advised that information contained hereon reflects the Company's findings at the time of its intervention only and within the limits of Client's instructions, if any. The Company's sole responsibility is to its Client and this document does not exonerate parties to a transaction from exercising all their rights and obligations under the transaction documents. This document cannot be reproduced except in full, without prior written approval of the Company. Any unauthorized alteration, forgery or falsification of the content or appearance of this document is unlawful and offenders may be prosecuted to the fullest extent of the law.

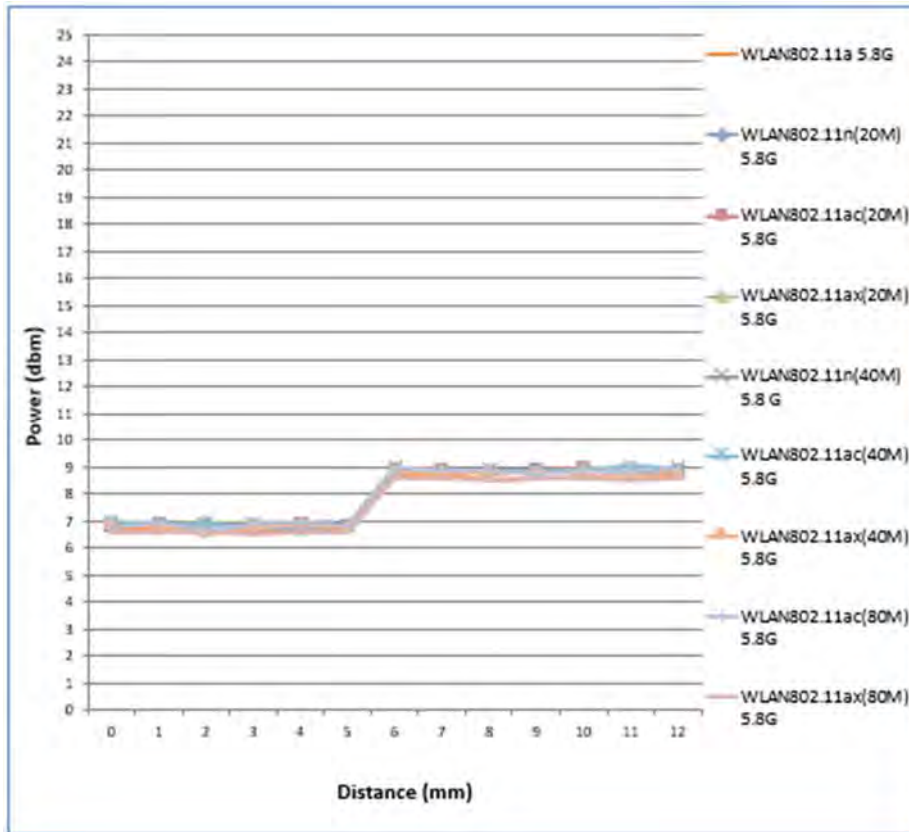

Unless otherwise stated the results shown in this test report refer only to the sample(s) tested and such sample(s) are retained for 90 days only.

除非另有說明，此報告結果僅對測試之樣品負責，同時此樣品僅保留90天。本報告未經本公司書面許可，不可部份複製。

This document is issued by the Company subject to its General Conditions of Service printed overleaf, available on request or accessible at www.sgs.com/terms_and_conditions.htm and for electronic format documents, subject to Terms and Conditions for Electronic Documents at www.sgs.com/terms_e-document.htm. Attention is drawn to the limitation of liability, indemnification and jurisdiction issues defined therein. Any holder of this document is advised that information contained hereon reflects the Company's findings at the time of its intervention only and within the limits of Client's instructions, if any. The Company's sole responsibility is to its Client and this document does not exonerate parties to a transaction from exercising all their rights and obligations under the transaction documents. This document cannot be reproduced except in full, without prior written approval of the Company. Any unauthorized alteration, forgery or falsification of the content or appearance of this document is unlawful and offenders may be prosecuted to the fullest extent of the law.

Tx2 (WWAN + WLAN)

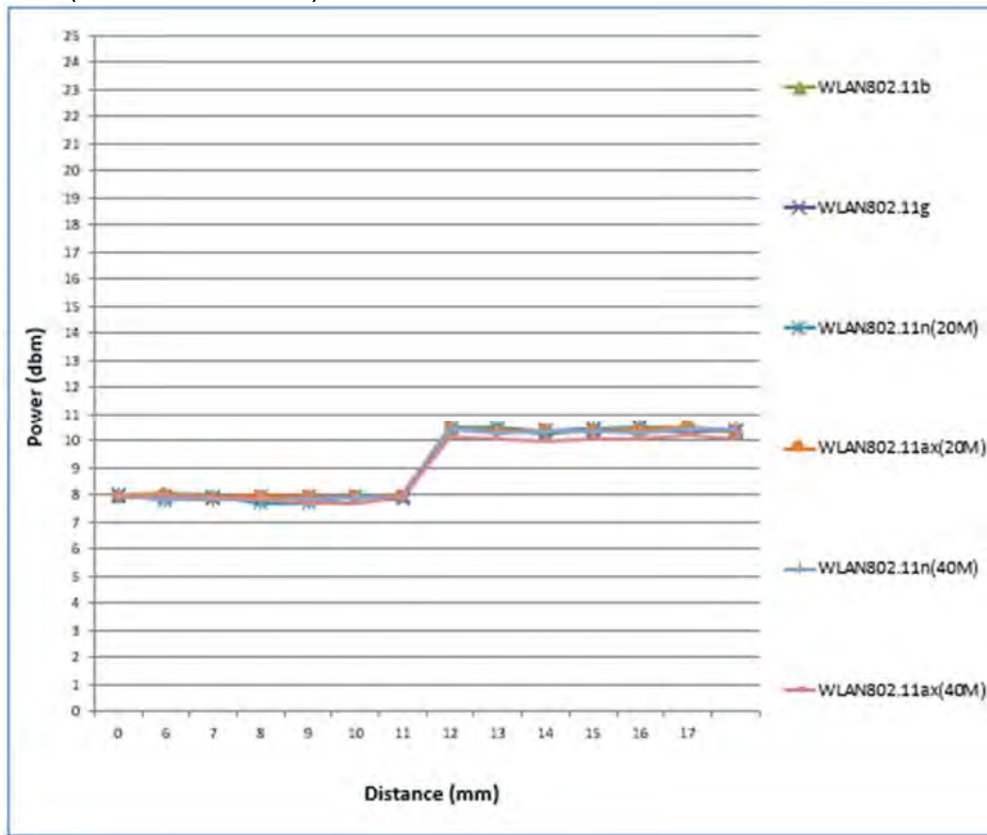

Unless otherwise stated the results shown in this test report refer only to the sample(s) tested and such sample(s) are retained for 90 days only.

除非另有說明，此報告結果僅對測試之樣品負責，同時此樣品僅保留90天。本報告未經本公司書面許可，不可部份複製。

This document is issued by the Company subject to its General Conditions of Service printed overleaf, available on request or accessible at www.sgs.com/terms_and_conditions.htm and for electronic format documents, subject to Terms and Conditions for Electronic Documents at www.sgs.com/terms_e-document.htm. Attention is drawn to the limitation of liability, indemnification and jurisdiction issues defined therein. Any holder of this document is advised that information contained hereon reflects the Company's findings at the time of its intervention only and within the limits of Client's instructions, if any. The Company's sole responsibility is to its Client and this document does not exonerate parties to a transaction from exercising all their rights and obligations under the transaction documents. This document cannot be reproduced except in full, without prior written approval of the Company. Any unauthorized alteration, forgery or falsification of the content or appearance of this document is unlawful and offenders may be prosecuted to the fullest extent of the law.

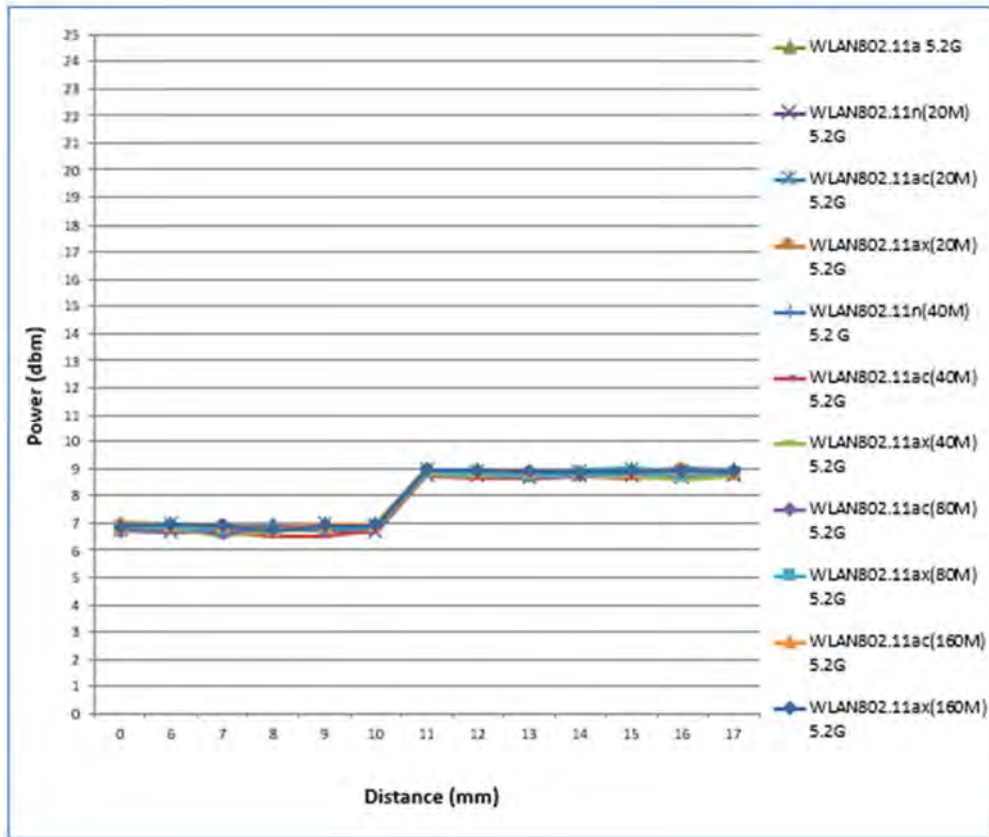

Unless otherwise stated the results shown in this test report refer only to the sample(s) tested and such sample(s) are retained for 90 days only.

除非另有說明，此報告結果僅對測試之樣品負責，同時此樣品僅保留90天。本報告未經本公司書面許可，不可部份複製。

This document is issued by the Company subject to its General Conditions of Service printed overleaf, available on request or accessible at www.sgs.com/terms_and_conditions.htm and for electronic format documents, subject to Terms and Conditions for Electronic Documents at www.sgs.com/terms_e-document.htm. Attention is drawn to the limitation of liability, indemnification and jurisdiction issues defined therein. Any holder of this document is advised that information contained hereon reflects the Company's findings at the time of its intervention only and within the limits of Client's instructions, if any. The Company's sole responsibility is to its Client and this document does not exonerate parties to a transaction from exercising all their rights and obligations under the transaction documents. This document cannot be reproduced except in full, without prior written approval of the Company. Any unauthorized alteration, forgery or falsification of the content or appearance of this document is unlawful and offenders may be prosecuted to the fullest extent of the law.

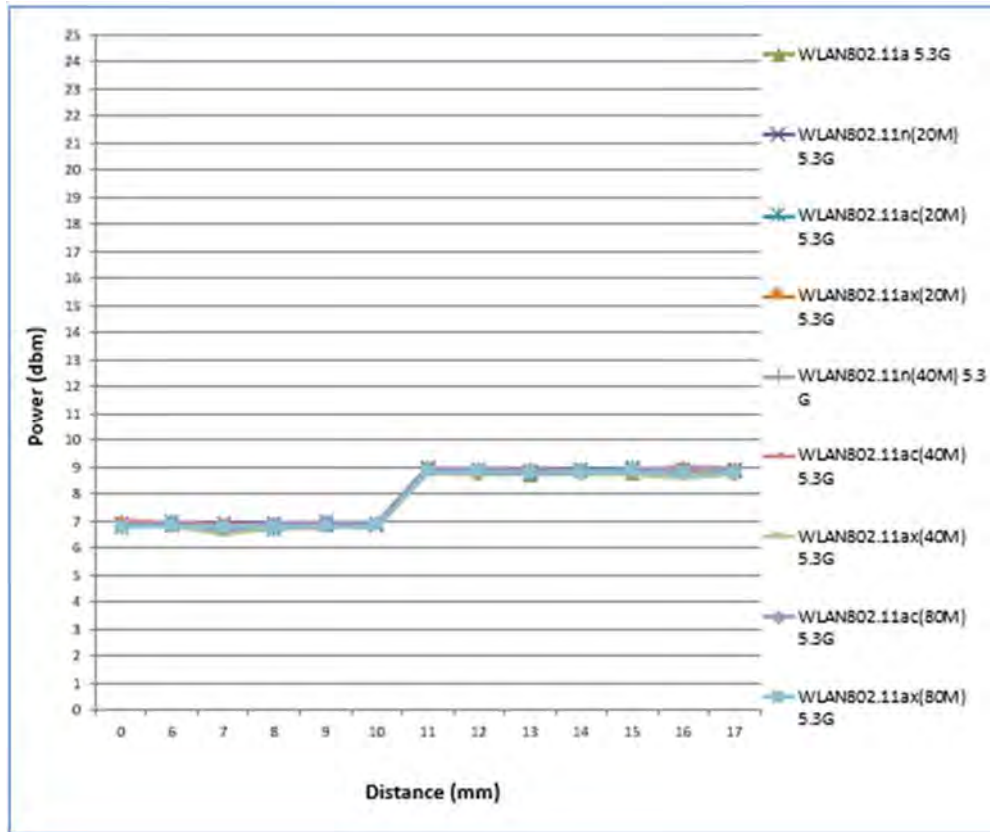

Unless otherwise stated the results shown in this test report refer only to the sample(s) tested and such sample(s) are retained for 90 days only.

除非另有說明，此報告結果僅對測試之樣品負責，同時此樣品僅保留90天。本報告未經本公司書面許可，不可部份複製。

This document is issued by the Company subject to its General Conditions of Service printed overleaf, available on request or accessible at www.sgs.com/terms_and_conditions.htm and for electronic format documents, subject to Terms and Conditions for Electronic Documents at www.sgs.com/terms_e-document.htm. Attention is drawn to the limitation of liability, indemnification and jurisdiction issues defined therein. Any holder of this document is advised that information contained hereon reflects the Company's findings at the time of its intervention only and within the limits of Client's instructions, if any. The Company's sole responsibility is to its Client and this document does not exonerate parties to a transaction from exercising all their rights and obligations under the transaction documents. This document cannot be reproduced except in full, without prior written approval of the Company. Any unauthorized alteration, forgery or falsification of the content or appearance of this document is unlawful and offenders may be prosecuted to the fullest extent of the law.

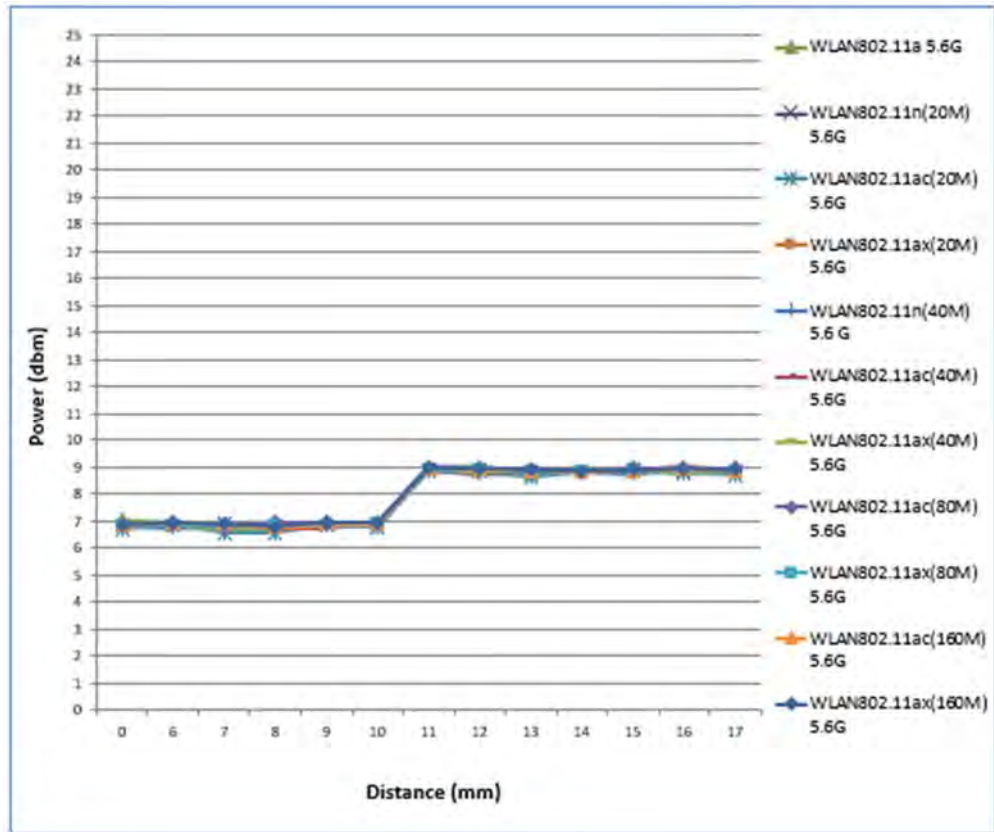

Unless otherwise stated the results shown in this test report refer only to the sample(s) tested and such sample(s) are retained for 90 days only.

除非另有說明，此報告結果僅對測試之樣品負責，同時此樣品僅保留90天。本報告未經本公司書面許可，不可部份複製。

This document is issued by the Company subject to its General Conditions of Service printed overleaf, available on request or accessible at www.sgs.com/terms_and_conditions.htm and for electronic format documents, subject to Terms and Conditions for Electronic Documents at www.sgs.com/terms_e-document.htm. Attention is drawn to the limitation of liability, indemnification and jurisdiction issues defined therein. Any holder of this document is advised that information contained hereon reflects the Company's findings at the time of its intervention only and within the limits of Client's instructions, if any. The Company's sole responsibility is to its Client and this document does not exonerate parties to a transaction from exercising all their rights and obligations under the transaction documents. This document cannot be reproduced except in full, without prior written approval of the Company. Any unauthorized alteration, forgery or falsification of the content or appearance of this document is unlawful and offenders may be prosecuted to the fullest extent of the law.

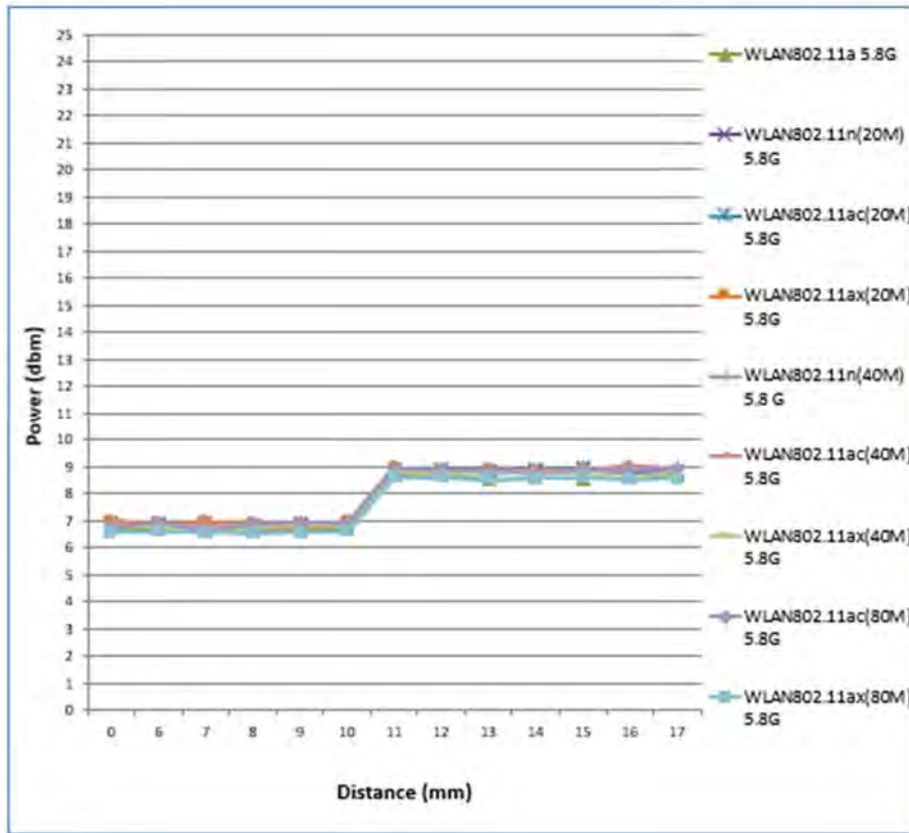

Table 1.6.5 Tilt angle test results for WLAN TX1_top side

P-sensor ON/OFF	-50 deg	-45 deg	-40 deg	-30 deg	-20 deg	-10 deg	0 deg	10 deg	20 deg	30 deg	40 deg	45 deg	50 deg
10mm	ON	ON	ON	ON	ON	ON	ON	ON	ON	ON	ON	ON	ON

Table 1.6.6 Tilt angle test results for WLAN TX2_top side

P-sensor ON/OFF	-50 deg	-45 deg	-40 deg	-30 deg	-20 deg	-10 deg	0 deg	10 deg	20 deg	30 deg	40 deg	45 deg	50 deg
5mm	ON	ON	ON	ON	ON	ON	ON	ON	ON	ON	ON	ON	ON

Table 1.6.7 Tilt angle test results for WWAN TX_top side

P-sensor ON/OFF	-50 deg	-45 deg	-40 deg	-30 deg	-20 deg	-10 deg	0 deg	10 deg	20 deg	30 deg	40 deg	45 deg	50 deg
20mm	ON	ON	ON	ON	ON	ON	ON	ON	ON	ON	ON	ON	ON

During the tilt angle testing for WLAN TX1_top side, the sensor is not released in 10mm, so 10-1=9mm is used in the SAR measurement.
During the tilt angle testing for WLAN TX2_top side, the sensor is not released in 5mm, so 5-1=4mm is used in the SAR measurement.

Unless otherwise stated the results shown in this test report refer only to the sample(s) tested and such sample(s) are retained for 90 days only.
除非另有說明，此報告結果僅對測試之樣品負責，同時此樣品僅保留90天。本報告未經本公司書面許可，不可部份複製。

This document is issued by the Company subject to its General Conditions of Service printed overleaf, available on request or accessible at www.sgs.com/terms_and_conditions.htm and for electronic format documents, subject to Terms and Conditions for Electronic Documents at www.sgs.com/terms_e-document.htm. Attention is drawn to the limitation of liability, indemnification and jurisdiction issues defined therein. Any holder of this document is advised that information contained hereon reflects the Company's findings at the time of its intervention only and within the limits of Client's instructions, if any. The Company's sole responsibility is to its Client and this document does not exonerate parties to a transaction from exercising all their rights and obligations under the transaction documents. This document cannot be reproduced except in full, without prior written approval of the Company. Any unauthorized alteration, forgery or falsification of the content or appearance of this document is unlawful and offenders may be prosecuted to the fullest extent of the law.

During the tilt angle testing for WWAN TX_top side, the sensor is not released in 20mm, so 20-1=19mm is used in the SAR measurement.

Note:

1. The triggering variations and hysteresis effect has been evaluated separately according to the tissue-equivalent medium required for each frequency band, and sensor triggering does not change with different tissue-equivalent media.
2. The default power level for sensor failure and malfunctioning, including all compliance concerns, has been addressed in 1.6.6 for the proximity sensor implementation to be acceptable.
3. Conducted power is monitored qualitatively to identify the general triggering characteristics and recorded quantitatively, versus spacing.

Unless otherwise stated the results shown in this test report refer only to the sample(s) tested and such sample(s) are retained for 90 days only.
除非另有說明，此報告結果僅對測試之樣品負責，同時此樣品僅保留90天。本報告未經本公司書面許可，不可部份複製。

This document is issued by the Company subject to its General Conditions of Service printed overleaf, available on request or accessible at www.sgs.com/terms_and_conditions.htm and for electronic format documents, subject to Terms and Conditions for Electronic Documents at www.sgs.com/terms_e-document.htm. Attention is drawn to the limitation of liability, indemnification and jurisdiction issues defined therein. Any holder of this document is advised that information contained hereon reflects the Company's findings at the time of its intervention only and within the limits of Client's instructions, if any. The Company's sole responsibility is to its Client and this document does not exonerate parties to a transaction from exercising all their rights and obligations under the transaction documents. This document cannot be reproduced except in full, without prior written approval of the Company. Any unauthorized alteration, forgery or falsification of the content or appearance of this document is unlawful and offenders may be prosecuted to the fullest extent of the law.

1.6.6 Operation description for P-sensor

Power Reduction Design Specification (for P-sensor)

The mechanism of power reduction is used for WWAN/WLAN. The reduced power for each technology/band is defined in Table1-1. With P-sensor mechanism, please refer to WWAN/WLAN reduced power table in section 1.3 to be the WWAN/WLAN default power when P-sensor failure or malfunction.

Table1-1 : The power reduction scenario table

Transmission mode	Band	Power Reduction
WWAN only, WWAN + WLAN	WWAN	YES
WLAN only, WWAN + WLAN	WLAN	YES
All	BT	NO

Unless otherwise stated the results shown in this test report refer only to the sample(s) tested and such sample(s) are retained for 90 days only.

除非另有說明，此報告結果僅對測試之樣品負責，同時此樣品僅保留90天。本報告未經本公司書面許可，不可部份複製。

This document is issued by the Company subject to its General Conditions of Service printed overleaf, available on request or accessible at www.sgs.com/terms_and_conditions.htm and for electronic format documents, subject to Terms and Conditions for Electronic Documents at www.sgs.com/terms_e-document.htm. Attention is drawn to the limitation of liability, indemnification and jurisdiction issues defined therein. Any holder of this document is advised that information contained hereon reflects the Company's findings at the time of its intervention only and within the limits of Client's instructions, if any. The Company's sole responsibility is to its Client and this document does not exonerate parties to a transaction from exercising all their rights and obligations under the transaction documents. This document cannot be reproduced except in full, without prior written approval of the Company. Any unauthorized alteration, forgery or falsification of the content or appearance of this document is unlawful and offenders may be prosecuted to the fullest extent of the law.

1.7 The SAR Measurement System

A block diagram of the SAR measurement System is given in Fig. a. This SAR Measurement System uses a Computer-controlled 3-D stepper motor system (SPEAG DASY 5 professional system). The model EX3DV4 field probe is used to determine the internal electric fields. The SAR can be obtained from the equation $SAR = \sigma (|E_i|^2) / \rho$ where σ and ρ are the conductivity and mass density of the tissue-simulant.

The DASY 5 system for performing compliance tests consists of the following items:

1. A standard high precision 6-axis robot (Staubli RX family) with controller, teach pendant and software. An arm extension is for accommodating the data acquisition electronics (DAE).
2. A dosimetric probe, i.e., an isotropic E-field probe optimized and calibrated for usage in tissue simulating liquid. The probe is equipped with an optical surface detector system.
3. A data acquisition electronics (DAE) which performs the signal amplification, signal multiplexing, AD-conversion, offset measurements, mechanical surface detection, collision detection, etc. The unit is battery powered with standard or rechargeable batteries. The signal is optically transmitted to the EOC.

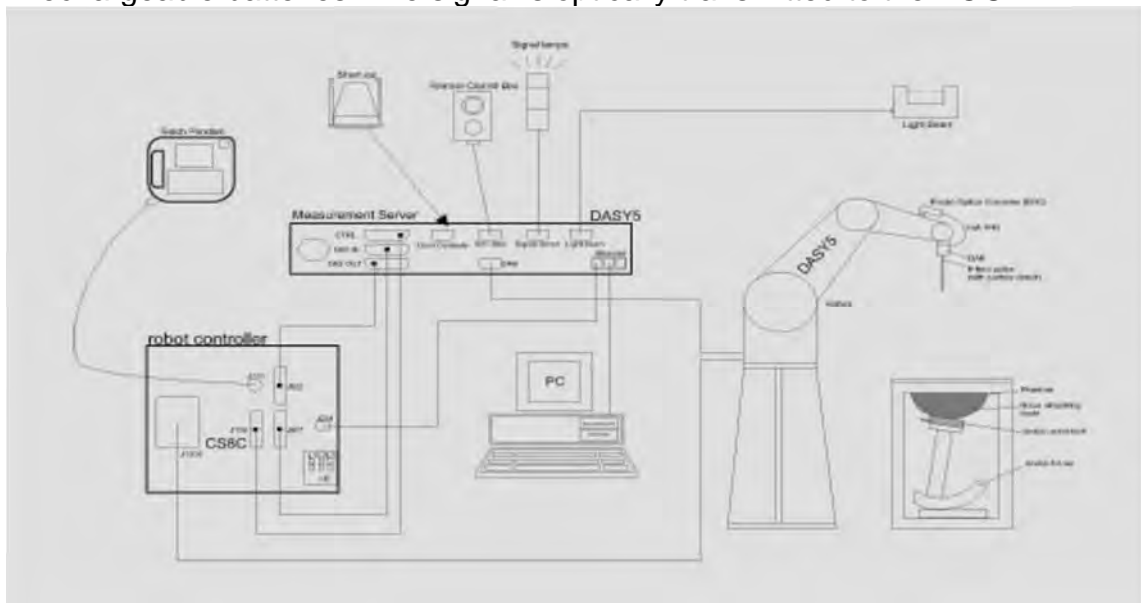

Fig. a The block diagram of SAR system

Unless otherwise stated the results shown in this test report refer only to the sample(s) tested and such sample(s) are retained for 90 days only.
除非另有說明，此報告結果僅對測試之樣品負責，同時此樣品僅保留90天。本報告未經本公司書面許可，不可部份複製。

This document is issued by the Company subject to its General Conditions of Service printed overleaf, available on request or accessible at www.sgs.com/terms_and_conditions.htm and for electronic format documents, subject to Terms and Conditions for Electronic Documents at www.sgs.com/terms_e-document.htm. Attention is drawn to the limitation of liability, indemnification and jurisdiction issues defined therein. Any holder of this document is advised that information contained hereon reflects the Company's findings at the time of its intervention only and within the limits of Client's instructions, if any. The Company's sole responsibility is to its Client and this document does not exonerate parties to a transaction from exercising all their rights and obligations under the transaction documents. This document cannot be reproduced except in full, without prior written approval of the Company. Any unauthorized alteration, forgery or falsification of the content or appearance of this document is unlawful and offenders may be prosecuted to the fullest extent of the law.

4. The Electro-optical converter (EOC) performs the conversion between optical and electrical of the signals for the digital communication to the DAE and for the analog signal from the optical surface detection. The EOC is connected to the measurement server.
5. The function of the measurement server is to perform the time critical tasks such as signal filtering, control of the robot operation and fast movement interrupts.
6. A probe alignment unit which improves the (absolute) accuracy of the probe positioning.
7. A computer operating Windows 7.
8. DASY 5 software.
9. Remote control with teach pendant and additional circuitry for robot safety such as warning lamps, etc.
10. Tissue simulating liquid mixed according to the given recipes.
11. Validation dipole kits allowing to validate the proper functioning of the system.

Unless otherwise stated the results shown in this test report refer only to the sample(s) tested and such sample(s) are retained for 90 days only.
除非另有說明，此報告結果僅對測試之樣品負責，同時此樣品僅保留90天。本報告未經本公司書面許可，不可部份複製。

This document is issued by the Company subject to its General Conditions of Service printed overleaf, available on request or accessible at www.sgs.com/terms_and_conditions.htm and for electronic format documents, subject to Terms and Conditions for Electronic Documents at www.sgs.com/terms_e-document.htm. Attention is drawn to the limitation of liability, indemnification and jurisdiction issues defined therein. Any holder of this document is advised that information contained hereon reflects the Company's findings at the time of its intervention only and within the limits of Client's instructions, if any. The Company's sole responsibility is to its Client and this document does not exonerate parties to a transaction from exercising all their rights and obligations under the transaction documents. This document cannot be reproduced except in full, without prior written approval of the Company. Any unauthorized alteration, forgery or falsification of the content or appearance of this document is unlawful and offenders may be prosecuted to the fullest extent of the law.

1.8 System Components

EX3DV4 E-Field Probe

Construction	Symmetrical design with triangular core Built-in shielding against static charges PEEK enclosure material (resistant to organic solvents, e.g., DGBE)	
Calibration	Basic Broad Band Calibration in air Conversion Factors (CF) for HSL 750/835/1750/1900/2300/2450/2600/ 5200/5300/5600/5800MHz MHz Additional CF for other liquids and frequencies upon request	
Frequency	10 MHz to > 6 GHz	
Directivity	± 0.3 dB in HSL (rotation around probe axis) ± 0.5 dB in tissue material (rotation normal to probe axis)	
Dynamic Range	10 µW/g to > 100 mW/g Linearity: ± 0.2 dB (noise: typically < 1 µW/g)	
Dimensions	Tip diameter: 2.5 mm	
Application	High precision dosimetric measurements in any exposure scenario (e.g., very strong gradient fields). Only probe which enables compliance testing for frequencies up to 6 GHz with precision of better 30%.	

Unless otherwise stated the results shown in this test report refer only to the sample(s) tested and such sample(s) are retained for 90 days only.

除非另有說明，此報告結果僅對測試之樣品負責，同時此樣品僅保留90天。本報告未經本公司書面許可，不可部份複製。

This document is issued by the Company subject to its General Conditions of Service printed overleaf, available on request or accessible at www.sgs.com/terms_and_conditions.htm and for electronic format documents, subject to Terms and Conditions for Electronic Documents at www.sgs.com/terms_e-document.htm. Attention is drawn to the limitation of liability, indemnification and jurisdiction issues defined therein. Any holder of this document is advised that information contained hereon reflects the Company's findings at the time of its intervention only and within the limits of Client's instructions, if any. The Company's sole responsibility is to its Client and this document does not exonerate parties to a transaction from exercising all their rights and obligations under the transaction documents. This document cannot be reproduced except in full, without prior written approval of the Company. Any unauthorized alteration, forgery or falsification of the content or appearance of this document is unlawful and offenders may be prosecuted to the fullest extent of the law.

PHANTOM

Model	ELI	
Construction	The ELI phantom is used for compliance testing of handheld and body-mounted wireless devices in the frequency range of 30 MHz to 6 GHz. ELI is fully compatible with the IEC 62209-2 standard and all known tissue simulating liquids. ELI has been optimized regarding its performance and can be integrated into our standard phantom tables. A cover prevents evaporation of the liquid. Reference markings on the phantom allow installation of the complete setup, including all predefined phantom positions and measurement grids, by teaching three points. The phantom is compatible with all SPEAG dosimetric probes and dipoles.	
Shell Thickness	2 ± 0.2 mm	
Filling Volume	Approx. 30 liters	
Dimensions	Major axis: 600 mm Minor axis: 400 mm	

DEVICE HOLDER

Construction	The device holder (Supporter) for Notebook is made by POM (polyoxymethylene resin) , which is non-metal and non-conductive. The height can be adjusted to fit varies kind of notebooks.	
		Device Holder

Unless otherwise stated the results shown in this test report refer only to the sample(s) tested and such sample(s) are retained for 90 days only.

除非另有說明，此報告結果僅對測試之樣品負責，同時此樣品僅保留90天。本報告未經本公司書面許可，不可部份複製。

This document is issued by the Company subject to its General Conditions of Service printed overleaf, available on request or accessible at www.sgs.com/terms_and_conditions.htm and for electronic format documents, subject to Terms and Conditions for Electronic Documents at www.sgs.com/terms_e-document.htm. Attention is drawn to the limitation of liability, indemnification and jurisdiction issues defined therein. Any holder of this document is advised that information contained hereon reflects the Company's findings at the time of its intervention only and within the limits of Client's instructions, if any. The Company's sole responsibility is to its Client and this document does not exonerate parties to a transaction from exercising all their rights and obligations under the transaction documents. This document cannot be reproduced except in full, without prior written approval of the Company. Any unauthorized alteration, forgery or falsification of the content or appearance of this document is unlawful and offenders may be prosecuted to the fullest extent of the law.

1.9 SAR System Verification

The microwave circuit arrangement for system verification is sketched in Fig. b. The daily system accuracy verification occurs within the flat section of the SAM phantom. A SAR measurement was performed to see if the measured SAR was within +/-10% from the target SAR values. These tests were done at 750/835/1750/1900/2300/2450/2600/5200/5300/5600/5800MHz. The tests were conducted on the same days as the measurement of the DUT. The obtained results from the system accuracy verification are displayed in the table 1 (SAR values are normalized to 1W forward power delivered to the dipole). During the tests, the liquid depth above the ear reference points was $\geq 15 \text{ cm} \pm 5 \text{ mm}$ (frequency $\leq 3 \text{ GHz}$) or $\geq 10 \text{ cm} \pm 5 \text{ mm}$ (frequency $> 3 \text{ GHz}$) in all the cases. It is seen that the system is operating within its specification, as the results are within acceptable tolerance of the reference values.

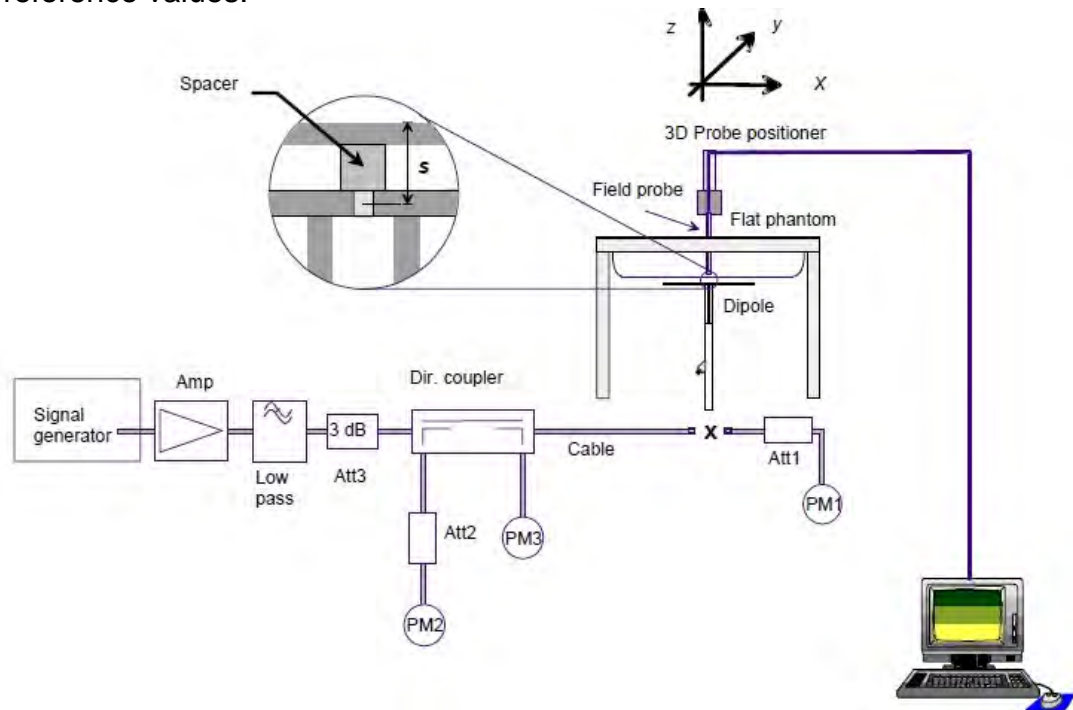

Fig. b The block diagram of system verification

Unless otherwise stated the results shown in this test report refer only to the sample(s) tested and such sample(s) are retained for 90 days only.
除非另有說明，此報告結果僅對測試之樣品負責，同時此樣品僅保留90天。本報告未經本公司書面許可，不可部份複製。

This document is issued by the Company subject to its General Conditions of Service printed overleaf, available on request or accessible at www.sgs.com/terms_and_conditions.htm and for electronic format documents, subject to Terms and Conditions for Electronic Documents at www.sgs.com/terms_e-document.htm. Attention is drawn to the limitation of liability, indemnification and jurisdiction issues defined therein. Any holder of this document is advised that information contained hereon reflects the Company's findings at the time of its intervention only and within the limits of Client's instructions, if any. The Company's sole responsibility is to its Client and this document does not exonerate parties to a transaction from exercising all their rights and obligations under the transaction documents. This document cannot be reproduced except in full, without prior written approval of the Company. Any unauthorized alteration, forgery or falsification of the content or appearance of this document is unlawful and offenders may be prosecuted to the fullest extent of the law.

Validation Kit	S/N	Frequency (MHz)		1W Target SAR-1g (mW/g)	pin=250mW Measured SAR-1g (mW/g)	Measured SAR-1g normalized to 1W (mW/g)	Deviation (%)	Measured Date
D750V3	1078	750	Body	8.64	2.14	8.56	-0.93%	Nov, 04, 2019
D835V2	4d092	835	Body	9.57	2.54	10.16	6.17%	Nov, 05, 2019
D1750V2	1023	1750	Body	37.5	9.12	36.48	-2.72%	Nov, 06, 2019
D1900V2	5d142	1900	Body	39.8	9.81	39.24	-1.41%	Nov, 07, 2019
D2300V2	1092	2300	Body	47.2	12.40	49.60	5.08%	Nov, 08, 2019
D2450V2	869	2450	Body	51.8	12.50	50.00	-3.47%	Nov, 09, 2019
D2600V2	1058	2600	Body	56	14.10	56.40	0.71%	Nov, 10, 2019
Validation Kit	S/N	Frequency (MHz)		1W Target SAR-1g (mW/g)	Pin=100mW Measured SAR-1g (mW/g)	Measured SAR-1g normalized to 1W (mW/g)	Deviation (%)	Measured Date
D5GHzV2	1040	5200	Body	73.4	7.37	73.7	0.41%	Nov, 11, 2019
		5300	Body	72.9	7.44	74.4	2.06%	Nov, 12, 2019
		5600	Body	80.5	7.92	79.2	-1.61%	Nov, 13, 2019
		5800	Body	75.5	7.47	74.7	-1.06%	Nov, 14, 2019

Validation Kit	S/N	Frequency (MHz)		1W Target SAR-1g (mW/g)	pin=250mW Measured SAR-1g (mW/g)	Measured SAR-1g normalized to 1W (mW/g)	Deviation (%)	Measured Date
D2450V2	869	2450	Body	51.8	13.50	54.00	4.25%	Nov, 15, 2019
				51.8	13.40	53.60	3.47%	Jan, 09, 2020
Validation Kit	S/N	Frequency (MHz)		1W Target SAR-1g (mW/g)	Pin=100mW Measured SAR-1g (mW/g)	Measured SAR-1g normalized to 1W (mW/g)	Deviation (%)	Measured Date
D5GHzV2	1040	5200	Body	73.4	7.36	73.6	0.27%	Nov, 16, 2019
		5300	Body	72.9	7.27	72.7	-0.27%	Nov, 17, 2019
		5600	Body	80.5	7.91	79.1	-1.74%	Nov, 18, 2019
		5800	Body	75.5	7.46	74.6	-1.19%	Nov, 19, 2019
		5800	Body	75.5	7.43	74.3	-1.59%	Jan, 09, 2020

Table 1. Results of system validation

Unless otherwise stated the results shown in this test report refer only to the sample(s) tested and such sample(s) are retained for 90 days only.

除非另有說明，此報告結果僅對測試之樣品負責，同時此樣品僅保留90天。本報告未經本公司書面許可，不可部份複製。

This document is issued by the Company subject to its General Conditions of Service printed overleaf, available on request or accessible at www.sgs.com/terms_and_conditions.htm and for electronic format documents, subject to Terms and Conditions for Electronic Documents at www.sgs.com/terms_e-document.htm. Attention is drawn to the limitation of liability, indemnification and jurisdiction issues defined therein. Any holder of this document is advised that information contained hereon reflects the Company's findings at the time of its intervention only and within the limits of Client's instructions, if any. The Company's sole responsibility is to its Client and this document does not exonerate parties to a transaction from exercising all their rights and obligations under the transaction documents. This document cannot be reproduced except in full, without prior written approval of the Company. Any unauthorized alteration, forgery or falsification of the content or appearance of this document is unlawful and offenders may be prosecuted to the fullest extent of the law.

1.10 Tissue Simulant Fluid for the Frequency Band

The dielectric properties for this Head-simulant fluid were measured by using the Agilent Model 85070E Dielectric Probe (rates frequency band 200 MHz to 20 GHz) in conjunction with Network Analyzer.

All dielectric parameters of tissue simulates were measured within 24 hours of SAR measurements. The measured conductivity and permittivity are all within $\pm 5\%$ of the target values.

The depth of the tissue simulant in the flat section of the phantom was $\geq 15 \text{ cm} \pm 5 \text{ mm}$ (Frequency $\leq 3\text{G}$) or $\geq 10 \text{ cm} \pm 5 \text{ mm}$ (Frequency $>3\text{G}$) during all tests. (Fig. 2)

Tissue Type	Measurement Date	Measured Frequency (MHz)	Target Dielectric Constant, ϵ_r	Target Conductivity, σ (S/m)	Measured Dielectric Constant, ϵ_r	Measured Conductivity, σ (S/m)	% dev ϵ_r	% dev σ
Body	Nov, 04, 2019	704	55.710	0.960	56.529	0.938	1.47%	-2.27%
		707.5	55.697	0.960	56.527	0.939	1.49%	-2.19%
		711	55.683	0.960	56.496	0.940	1.46%	-2.12%
		750	55.531	0.963	56.359	0.941	1.49%	-2.32%
		782	55.406	0.966	56.221	0.942	1.47%	-2.47%
		793	55.356	0.967	56.186	0.943	1.50%	-2.48%
	Nov, 05, 2019	821.5	55.306	0.968	55.610	0.944	0.55%	-2.48%
		826.4	55.234	0.969	55.488	0.948	0.46%	-2.20%
		829	55.223	0.970	55.483	0.949	0.47%	-2.12%
		831.5	55.214	0.970	55.471	0.950	0.47%	-2.03%
		835	55.200	0.970	55.462	0.951	0.47%	-1.96%
		836.5	55.195	0.972	55.448	0.952	0.46%	-2.04%
		836.6	55.195	0.972	55.445	0.953	0.45%	-1.95%
		841.5	55.180	0.978	55.444	0.955	0.48%	-2.35%
	Nov, 06, 2019	844	55.172	0.981	55.435	0.956	0.48%	-2.56%
		846.6	55.164	0.984	55.426	0.957	0.47%	-2.77%
		1720	53.511	1.469	54.244	1.498	1.37%	1.94%
		1732.5	53.478	1.477	54.215	1.507	1.38%	2.01%
		1745	53.445	1.485	54.191	1.515	1.40%	2.00%
	Nov, 07, 2019	1750	53.432	1.488	54.188	1.518	1.42%	1.99%
		1770	53.422	1.491	54.185	1.521	1.43%	2.01%
		1852.4	53.300	1.520	54.161	1.533	1.62%	0.86%
		1860	53.300	1.520	54.152	1.534	1.60%	0.92%
		1880	53.300	1.520	54.149	1.535	1.59%	0.99%
		1882.5	53.300	1.520	54.121	1.536	1.54%	1.05%
		1900	53.300	1.520	54.115	1.537	1.53%	1.12%
		1905	53.300	1.520	54.115	1.538	1.53%	1.18%
	Nov, 08, 2019	1907.6	53.300	1.520	54.110	1.540	1.52%	1.32%
		2300	52.900	1.807	54.089	1.759	2.25%	-2.64%
			2310	52.887	1.816	54.078	1.769	2.25%

Unless otherwise stated the results shown in this test report refer only to the sample(s) tested and such sample(s) are retained for 90 days only.

除非另有說明，此報告結果僅對測試之樣品負責，同時此樣品僅保留90天。本報告未經本公司書面許可，不可部份複製。

This document is issued by the Company subject to its General Conditions of Service printed overleaf, available on request or accessible at www.sgs.com/terms_and_conditions.htm and for electronic format documents, subject to Terms and Conditions for Electronic Documents at www.sgs.com/terms_e-document.htm. Attention is drawn to the limitation of liability, indemnification and jurisdiction issues defined therein. Any holder of this document is advised that information contained hereon reflects the Company's findings at the time of its intervention only and within the limits of Client's instructions, if any. The Company's sole responsibility is to its Client and this document does not exonerate parties to a transaction from exercising all their rights and obligations under the transaction documents. This document cannot be reproduced except in full, without prior written approval of the Company. Any unauthorized alteration, forgery or falsification of the content or appearance of this document is unlawful and offenders may be prosecuted to the fullest extent of the law.

Tissue Type	Measurement Date	Measured Frequency (MHz)	Target Dielectric Constant, ϵ_r	Target Conductivity, σ (S/m)	Measured Dielectric Constant, ϵ_r	Measured Conductivity, σ (S/m)	% dev ϵ_r	% dev σ
Body	Nov, 09, 2019	2402	52.764	1.904	54.077	1.859	2.49%	-2.37%
		2412	52.751	1.914	54.073	1.860	2.51%	-2.81%
		2422	52.737	1.923	52.908	1.870	0.32%	-2.77%
		2437	52.717	1.938	52.903	1.884	0.35%	-2.77%
		2441	52.712	1.941	52.894	1.895	0.35%	-2.39%
		2450	52.700	1.950	52.845	1.896	0.28%	-2.77%
		2452	52.697	1.953	52.844	1.898	0.28%	-2.81%
		2462	52.685	1.967	52.831	1.911	0.28%	-2.85%
	2480	52.662	1.993	52.828	1.992	0.32%	-0.03%	
	Nov, 10, 2019	2506	52.629	2.029	52.808	1.993	0.34%	-1.79%
		2510	52.624	2.035	52.780	1.998	0.30%	-1.82%
		2535	52.592	2.071	52.778	2.032	0.35%	-1.86%
		2549.5	52.573	2.091	52.761	2.055	0.36%	-1.73%
		2560	52.560	2.106	52.754	2.069	0.37%	-1.76%
		2580	52.535	2.134	52.730	2.096	0.37%	-1.80%
		2593	52.518	2.153	52.714	2.115	0.37%	-1.76%
		2595	52.515	2.156	52.685	2.117	0.32%	-1.79%
		2600	52.509	2.163	51.911	2.124	-1.14%	-1.79%
		2610	52.496	2.177	51.868	2.139	-1.20%	-1.74%
	2636.5	52.463	2.214	51.829	2.174	-1.21%	-1.83%	
	2680	52.407	2.276	51.803	2.236	-1.15%	-1.77%	
	2687.5	52.405	2.279	51.801	2.237	-1.15%	-1.84%	
	Nov, 11, 2019	5200	49.014	5.299	49.854	5.180	1.71%	-2.25%
		5210	49.001	5.311	49.811	5.193	1.65%	-2.22%
		5250	48.959	5.341	49.807	5.223	1.73%	-2.21%
	Nov, 12, 2019	5270	48.919	5.381	49.803	5.238	1.81%	-2.66%
		5290	48.892	5.404	49.799	5.263	1.85%	-2.62%
		5300	48.879	5.416	49.799	5.277	1.88%	-2.57%
		5310	48.865	5.428	49.723	5.286	1.76%	-2.61%
	Nov, 13, 2019	5530	48.566	5.685	49.221	5.803	1.35%	2.08%
		5570	48.666	5.725	49.199	5.830	1.10%	1.83%
		5600	48.471	5.766	49.174	5.844	1.45%	1.35%
		5610	48.458	5.778	49.147	5.850	1.42%	1.24%
		5690	48.349	5.872	48.335	5.871	-0.03%	-0.01%
	Nov, 14, 2019	5755	48.261	5.947	48.202	5.879	-0.12%	-1.15%
		5775	48.234	5.971	48.147	5.888	-0.18%	-1.39%
5795		48.207	5.994	48.143	5.898	-0.13%	-1.60%	
5800		48.200	6.000	48.021	5.995	-0.37%	-0.08%	

Unless otherwise stated the results shown in this test report refer only to the sample(s) tested and such sample(s) are retained for 90 days only.

除非另有說明，此報告結果僅對測試之樣品負責，同時此樣品僅保留90天。本報告未經本公司書面許可，不可部份複製。

This document is issued by the Company subject to its General Conditions of Service printed overleaf, available on request or accessible at www.sgs.com/terms_and_conditions.htm and for electronic format documents, subject to Terms and Conditions for Electronic Documents at www.sgs.com/terms_e-document.htm. Attention is drawn to the limitation of liability, indemnification and jurisdiction issues defined therein. Any holder of this document is advised that information contained hereon reflects the Company's findings at the time of its intervention only and within the limits of Client's instructions, if any. The Company's sole responsibility is to its Client and this document does not exonerate parties to a transaction from exercising all their rights and obligations under the transaction documents. This document cannot be reproduced except in full, without prior written approval of the Company. Any unauthorized alteration, forgery or falsification of the content or appearance of this document is unlawful and offenders may be prosecuted to the fullest extent of the law.

Tissue Type	Measurement Date	Measured Frequency (MHz)	Target Dielectric Constant, ϵ_r	Target Conductivity, σ (S/m)	Measured Dielectric Constant, ϵ_r	Measured Conductivity, σ (S/m)	% dev ϵ_r	% dev σ
Body	2019/11/15	2402	52.764	1.904	53.550	1.888	1.49%	-0.85%
		2412	52.751	1.914	53.531	1.896	1.48%	-0.92%
		2437	52.717	1.938	53.517	1.920	1.52%	-0.91%
		2441	52.712	1.941	53.513	1.923	1.52%	-0.95%
		2450	52.700	1.950	53.508	1.931	1.53%	-0.97%
		2457	52.691	1.960	53.473	1.941	1.48%	-0.97%
		2462	52.685	1.967	53.470	1.950	1.49%	-0.87%
	2020/1/9	2412	52.751	1.914	53.363	1.896	1.16%	-0.92%
		2437	52.717	1.938	53.350	1.920	1.20%	-0.91%
		2450	52.700	1.950	53.322	1.933	1.18%	-0.87%
		2462	52.685	1.967	53.343	1.950	1.25%	-0.87%
	2019/11/16	5190	49.028	5.288	49.941	5.232	1.86%	-1.05%
		5200	49.014	5.299	49.922	5.242	1.85%	-1.08%
		5210	49.001	5.311	49.914	5.251	1.86%	-1.13%
		5230	48.974	5.334	49.913	5.265	1.92%	-1.30%
		5250	48.954	5.349	49.906	5.276	1.94%	-1.36%
	2019/11/17	5260	48.933	5.369	49.901	5.278	1.98%	-1.70%
		5270	48.919	5.381	49.895	5.290	1.99%	-1.69%
		5280	48.906	5.393	49.887	5.293	2.01%	-1.85%
		5290	48.892	5.404	49.881	5.304	2.02%	-1.86%
		5300	48.879	5.416	49.870	5.313	2.03%	-1.90%
		5300	48.879	5.416	49.863	5.314	2.01%	-1.88%
		5310	48.865	5.428	49.853	5.322	2.02%	-1.95%
	2019/11/18	5320	48.851	5.439	49.811	5.335	1.96%	-1.92%
		5530	48.566	5.685	49.732	5.537	2.40%	-2.60%
		5550	48.539	5.708	49.714	5.557	2.42%	-2.65%
		5570	48.508	5.726	49.653	5.577	2.36%	-2.60%
		5590	48.485	5.755	49.648	5.603	2.40%	-2.64%
		5600	48.471	5.766	49.635	5.618	2.40%	-2.57%
		5610	48.458	5.778	49.620	5.627	2.40%	-2.62%
		5670	48.376	5.848	49.593	5.695	2.51%	-2.62%
		5690	48.349	5.872	49.575	5.718	2.54%	-2.61%
	2019/11/19	5710	48.322	5.895	49.545	5.741	2.53%	-2.61%
		5755	48.261	5.947	49.542	5.779	2.65%	-2.83%
		5775	48.234	5.971	49.537	5.806	2.70%	-2.76%
		5795	48.207	5.994	49.519	5.826	2.72%	-2.81%
		5800	48.200	6.000	49.482	5.833	2.66%	-2.78%
	2020/1/9	5775	48.234	5.971	49.276	5.817	2.16%	-2.58%
		5800	48.200	6.000	49.246	5.844	2.17%	-2.60%

Table 2. Dielectric Parameters of Tissue Simulant Fluid

Unless otherwise stated the results shown in this test report refer only to the sample(s) tested and such sample(s) are retained for 90 days only.

除非另有說明，此報告結果僅對測試之樣品負責，同時此樣品僅保留90天。本報告未經本公司書面許可，不可部份複製。

This document is issued by the Company subject to its General Conditions of Service printed overleaf, available on request or accessible at www.sgs.com/terms_and_conditions.htm and for electronic format documents, subject to Terms and Conditions for Electronic Documents at www.sgs.com/terms_e-document.htm. Attention is drawn to the limitation of liability, indemnification and jurisdiction issues defined therein. Any holder of this document is advised that information contained hereon reflects the Company's findings at the time of its intervention only and within the limits of Client's instructions, if any. The Company's sole responsibility is to its Client and this document does not exonerate parties to a transaction from exercising all their rights and obligations under the transaction documents. This document cannot be reproduced except in full, without prior written approval of the Company. Any unauthorized alteration, forgery or falsification of the content or appearance of this document is unlawful and offenders may be prosecuted to the fullest extent of the law.

The composition of the body tissue simulating liquid:

Frequency (MHz)	Mode	Ingredient						Total amount
		DGMBE	Water	Salt	Preventol D-7	Cellulose	Sugar	
750	Body	—	631.68 g	11.72 g	1.2 g	—	600 g	1.0L(Kg)
850	Body	—	631.68 g	11.72 g	1.2 g	—	600 g	1.0L(Kg)
1750	Body	300.67 g	716.56 g	4.0 g	—	—	—	1.0L(Kg)
1900	Body	300.67 g	716.56 g	4.0 g	—	—	—	1.0L(Kg)
2300	Body	301.7ml	698.3ml	—	—	—	—	1.0L(Kg)
2450	Body	301.7ml	698.3ml	—	—	—	—	1.0L(Kg)
2600	Body	301.7ml	698.3ml	—	—	—	—	1.0L(Kg)

Simulating Liquids for 5 GHz, Manufactured by SPEAG:

Ingredients	Water	Esters, Emulsifiers, Inhibitors	Sodium and Salt
(% by weight)	60-80	20-40	0-1.5

Table 3. Recipes for tissue simulating liquid

Unless otherwise stated the results shown in this test report refer only to the sample(s) tested and such sample(s) are retained for 90 days only.

除非另有說明，此報告結果僅對測試之樣品負責，同時此樣品僅保留90天。本報告未經本公司書面許可，不可部份複製。

This document is issued by the Company subject to its General Conditions of Service printed overleaf, available on request or accessible at www.sgs.com/terms_and_conditions.htm and for electronic format documents, subject to Terms and Conditions for Electronic Documents at www.sgs.com/terms_e-document.htm. Attention is drawn to the limitation of liability, indemnification and jurisdiction issues defined therein. Any holder of this document is advised that information contained hereon reflects the Company's findings at the time of its intervention only and within the limits of Client's instructions, if any. The Company's sole responsibility is to its Client and this document does not exonerate parties to a transaction from exercising all their rights and obligations under the transaction documents. This document cannot be reproduced except in full, without prior written approval of the Company. Any unauthorized alteration, forgery or falsification of the content or appearance of this document is unlawful and offenders may be prosecuted to the fullest extent of the law.

1.11 Evaluation Procedures

The entire evaluation of the spatial peak values is performed within the Post-processing engine (SEMCAD). The system always gives the maximum values for the 1 g and 10 g cubes. The algorithm to find the cube with highest averaged SAR is divided into the following stages:

1. The extraction of the measured data (grid and values) from the Zoom Scan.
2. The calculation of the SAR value at every measurement point based on all stored data (A/D values and measurement parameters)
3. The generation of a high-resolution mesh within the measured volume
4. The interpolation of all measured values from the measurement grid to the high-resolution grid
5. The extrapolation of the entire 3-D field distribution to the phantom surface over the distance from sensor to surface
6. The calculation of the averaged SAR within masses of 1g and 10g.

The probe is calibrated at the center of the dipole sensors that is located 1 to 2.7mm away from the probe tip. During measurements, the probe stops shortly above the phantom surface, depending on the probe and the surface detecting system. Both distances are included as parameters in the probe configuration file. The software always knows exactly how far away the measured point is from the surface. As the probe cannot directly measure at the surface, the values between the deepest measured point and the surface must be extrapolated. The angle between the probe axis and the surface normal line is less than 30 degree.

In the Area Scan, the gradient of the interpolation function is evaluated to find all the extreme of the SAR distribution. The uncertainty on the locations of the extreme is less than 1/20 of the grid size. Only local maximum within -2 dB of the global maximum are searched and passed for the Cube Scan measurement. In the Cube Scan, the interpolation function is used to extrapolate the Peak SAR from the lowest measurement points to the inner phantom surface (the extrapolation distance). The uncertainty increases with the extrapolation distance. To keep the uncertainty within 1% for the 1 g and 10 g cubes, the extrapolation distance should not be larger than 5mm.

The maximum search is automatically performed after each area scan measurement. It is based on splines in two or three dimensions. The procedure can find the maximum for most SAR distributions even with relatively large grid spacing. After the area scanning measurement, the probe is automatically moved to a position at the interpolated maximum. The following scan can directly use this position for reference, e.g., for a finer resolution grid or the cube evaluations. The 1g and 10g peak evaluations are only available for the predefined cube 7x7x7 scans. The routines are verified and optimized for the grid dimensions used in these cube measurements.

The measured volume of 30x30x30mm contains about 30g of tissue.

The first procedure is an extrapolation (incl. Boundary correction) to get the points between the lowest measured plane and the surface. The next step uses 3D

Unless otherwise stated the results shown in this test report refer only to the sample(s) tested and such sample(s) are retained for 90 days only.
除非另有說明，此報告結果僅對測試之樣品負責，同時此樣品僅保留90天。本報告未經本公司書面許可，不可部份複製。

This document is issued by the Company subject to its General Conditions of Service printed overleaf, available on request or accessible at www.sgs.com/terms_and_conditions.htm and for electronic format documents, subject to Terms and Conditions for Electronic Documents at www.sgs.com/terms_e-document.htm. Attention is drawn to the limitation of liability, indemnification and jurisdiction issues defined therein. Any holder of this document is advised that information contained hereon reflects the Company's findings at the time of its intervention only and within the limits of Client's instructions, if any. The Company's sole responsibility is to its Client and this document does not exonerate parties to a transaction from exercising all their rights and obligations under the transaction documents. This document cannot be reproduced except in full, without prior written approval of the Company. Any unauthorized alteration, forgery or falsification of the content or appearance of this document is unlawful and offenders may be prosecuted to the fullest extent of the law.

interpolation to get all points within the measured volume. In the last step, a 1g cube is placed numerically into the volume and its averaged SAR is calculated. This cube is moved around until the highest averaged SAR is found. If the highest SAR is found at the edge of the measured volume, the system will issue a warning: higher SAR values might be found outside of the measured volume. In that case the cube measurement can be repeated, using the new interpolated maximum as the center.

1.12 Probe Calibration Procedures

For the calibration of E-field probes in lossy liquids, an electric field with an accurately known field strength must be produced within the measured liquid. For standardization purposes it would be desirable if all measurements which are necessary to assess the correct field strength would be traceable to standardized measurement procedures. In the following two different calibration techniques are summarized:

1.12.1 Transfer Calibration with Temperature Probes

In lossy liquids the specific absorption rate (SAR) is related both to the electric field (E) and the temperature gradient ($\delta T / \delta t$) in the liquid.

$$SAR = C \frac{\delta T}{\delta t},$$

whereby σ is the conductivity, ρ the density and c the heat capacity of the liquid.

Hence, the electric field in lossy liquid can be measured indirectly by measuring the temperature gradient in the liquid. Non-disturbing temperature probes (optical probes or thermistor probes with resistive lines) with high spatial resolution (<1-2 mm) and fast reaction time (<1 s) are available and can be easily calibrated with high precision [1]. The setup and the exciting source have no influence on the calibration; only the relative positioning uncertainties of the standard temperature probe and the E-field probe to be calibrated must be considered. However, several problems limit the available accuracy of probe calibrations with temperature probes:

Unless otherwise stated the results shown in this test report refer only to the sample(s) tested and such sample(s) are retained for 90 days only.
除非另有說明，此報告結果僅對測試之樣品負責，同時此樣品僅保留90天。本報告未經本公司書面許可，不可部份複製。

This document is issued by the Company subject to its General Conditions of Service printed overleaf, available on request or accessible at www.sgs.com/terms_and_conditions.htm and for electronic format documents, subject to Terms and Conditions for Electronic Documents at www.sgs.com/terms_e-document.htm. Attention is drawn to the limitation of liability, indemnification and jurisdiction issues defined therein. Any holder of this document is advised that information contained hereon reflects the Company's findings at the time of its intervention only and within the limits of Client's instructions, if any. The Company's sole responsibility is to its Client and this document does not exonerate parties to a transaction from exercising all their rights and obligations under the transaction documents. This document cannot be reproduced except in full, without prior written approval of the Company. Any unauthorized alteration, forgery or falsification of the content or appearance of this document is unlawful and offenders may be prosecuted to the fullest extent of the law.

- The temperature gradient is not directly measurable but must be evaluated from temperature measurements at different time steps. Special precaution is necessary to avoid measurement errors caused by temperature gradients due to energy equalizing effects or convection currents in the liquid. Such effects cannot be completely avoided, as the measured field itself destroys the thermal equilibrium in the liquid. With a careful setup these errors can be kept small.
- The measured volume around the temperature probe is not well defined. It is difficult to calculate the energy transfer from a surrounding gradient temperature field into the probe. These effects must be considered, since temperature probes are calibrated in liquid with homogeneous temperatures. There is no traceable standard for temperature rise measurements.
- The calibration depends on the assessment of the specific density, the heat capacity and the conductivity of the medium. While the specific density and heat capacity can be measured accurately with standardized procedures ($\sim 2\%$ for c ; much better for ρ), there is no standard for the measurement of the conductivity. Depending on the method and liquid, the error can well exceed $\pm 5\%$.
- Temperature rise measurements are not very sensitive and therefore are often performed at a higher power level than the E-field measurements. The nonlinearities in the system (e.g., power measurements, different components, etc.) must be considered.

Considering these problems, the possible accuracy of the calibration of E-field probes with temperature gradient measurements in a carefully designed setup is about $\pm 10\%$ (RSS) [2]. Recently, a setup which is a combination of the waveguide techniques and the thermal measurements was presented in [3]. The estimated uncertainty of the setup is $\pm 5\%$ (RSS) when the same liquid is used for the calibration and for actual measurements and $\pm 7-9\%$ (RSS) when not, which is in good agreement with the estimates given in [2].

1.12.2 Calibration with Analytical Fields

In this method a technical setup is used in which the field can be calculated analytically from measurements of other physical magnitudes (e.g., input power). This corresponds to the standard field method for probe calibration in air; however, there is no standard defined for fields in lossy liquids.

When using calculated fields in lossy liquids for probe calibration, several points must be considered in the assessment of the uncertainty:

- The setup must enable accurate determination of the incident power.
- The accuracy of the calculated field strength will depend on the assessment of the dielectric parameters of the liquid.
- Due to the small wavelength in liquids with high permittivity, even small

Unless otherwise stated the results shown in this test report refer only to the sample(s) tested and such sample(s) are retained for 90 days only.
除非另有說明，此報告結果僅對測試之樣品負責，同時此樣品僅保留90天。本報告未經本公司書面許可，不可部份複製。

This document is issued by the Company subject to its General Conditions of Service printed overleaf, available on request or accessible at www.sgs.com/terms_and_conditions.htm and for electronic format documents, subject to Terms and Conditions for Electronic Documents at www.sgs.com/terms_e-document.htm. Attention is drawn to the limitation of liability, indemnification and jurisdiction issues defined therein. Any holder of this document is advised that information contained hereon reflects the Company's findings at the time of its intervention only and within the limits of Client's instructions, if any. The Company's sole responsibility is to its Client and this document does not exonerate parties to a transaction from exercising all their rights and obligations under the transaction documents. This document cannot be reproduced except in full, without prior written approval of the Company. Any unauthorized alteration, forgery or falsification of the content or appearance of this document is unlawful and offenders may be prosecuted to the fullest extent of the law.

setups might be above the resonant cutoff frequencies. The field distribution in the setup must be carefully checked for conformity with the theoretical field distribution.

References

1. N. Kuster, Q. Balzano, and J.C. Lin, Eds., *Mobile Communications Safety*, Chapman & Hall, London, 1997.
2. K. Meier, M. Burkhardt, T. Schmid, and N. Kuster, "Broadband calibration of E-field probes in lossy media", *IEEE Transactions on Microwave Theory and Techniques*, vol. 44, no. 10, pp. 1954-1962, Oct. 1996.
3. K. Jokela, P. Hyysalo, and L. Puranen, "Calibration of specific absorption rate (SAR) probes in waveguide at 900 MHz", *IEEE Transactions on Instrumentation and Measurements*, vol. 47, no. 2, pp. 432-438, Apr. 1998.

Unless otherwise stated the results shown in this test report refer only to the sample(s) tested and such sample(s) are retained for 90 days only.
除非另有說明，此報告結果僅對測試之樣品負責，同時此樣品僅保留90天。本報告未經本公司書面許可，不可部份複製。

This document is issued by the Company subject to its General Conditions of Service printed overleaf, available on request or accessible at www.sgs.com/terms_and_conditions.htm and for electronic format documents, subject to Terms and Conditions for Electronic Documents at www.sgs.com/terms_e-document.htm. Attention is drawn to the limitation of liability, indemnification and jurisdiction issues defined therein. Any holder of this document is advised that information contained hereon reflects the Company's findings at the time of its intervention only and within the limits of Client's instructions, if any. The Company's sole responsibility is to its Client and this document does not exonerate parties to a transaction from exercising all their rights and obligations under the transaction documents. This document cannot be reproduced except in full, without prior written approval of the Company. Any unauthorized alteration, forgery or falsification of the content or appearance of this document is unlawful and offenders may be prosecuted to the fullest extent of the law.

1.13 Test Standards and Limits

According to FCC 47CFR §2.1093(d) The limits to be used for evaluation are based generally on criteria published by the American National Standards Institute (ANSI) for localized specific absorption rate (“SAR”) in Section 4.2 of “IEEE Standard for Safety Levels with Respect to Human Exposure to Radio Frequency Electromagnetic Fields, 3 kHz to 300 GHz,” ANSI/IEEE C95.1, By the Institute of Electrical and Electronics Engineers, Inc., New York, New York 10017. These criteria for SAR evaluation are similar to those recommended by the National Council on Radiation Protection and Measurements (NCRP) in “Biological Effects and Exposure Criteria for Radio frequency Electromagnetic Fields,” NCRP Report No. 86, Section 17.4.5. Copyright NCRP, 1986, Bethesda, Maryland 20814. SAR is a measure of the rate of energy absorption due to exposure to an RF transmitting source. SAR values have been related to threshold levels for potential biological hazards. The criteria to be used are specified in paragraphs (d)(1) and (d)(2) of this section and shall apply for portable devices transmitting in the frequency range from 100 kHz to 6 GHz. Portable devices that transmit at frequencies above 6 GHz are to be evaluated in terms of the MPE limits specified in § 1.1310 of this chapter. Measurements and calculations to demonstrate compliance with MPE field strength or power density limits for devices operating above 6 GHz should be made at a minimum distance of 5 cm from the radiating source.

- (1) Limits for Occupational/Controlled exposure: 0.4 W/kg as averaged over the whole-body and spatial peak SAR not exceeding 8 W/kg as averaged over any 1 gram of tissue (defined as a tissue volume in the shape of a cube). Exceptions are the hands, wrists, feet and ankles where the spatial peak SAR shall not exceed 20 W/kg, as averaged over an 10 grams of tissue (defined as a tissue volume in the shape of a cube).
- (2) Occupational/Controlled limits apply when persons are exposed as a consequence of their employment provided these persons are fully aware of and exercise control over their exposure. Awareness of exposure can be accomplished by use of warning labels or by specific training or education through appropriate means, such as an RF safety program in a work environment.
- (3) Limits for General Population/Uncontrolled exposure: 0.08 W/kg as averaged over the whole-body and spatial peak SAR not exceeding 1.6 W/kg as averaged over any 1 gram of tissue (defined as a tissue volume in the shape of a cube). Exceptions are the hands, wrists, feet and ankles where the spatial peak SAR shall not exceed 4 W/kg, as averaged over any 10 grams of tissue (defined as a tissue volume in the shape of a cube). General Population/Uncontrolled limits apply when the general public may be exposed, or when persons that are exposed as a consequence of their employment may not be fully aware of the potential for exposure or do not exercise control over their exposure. Warning labels placed on consumer

Unless otherwise stated the results shown in this test report refer only to the sample(s) tested and such sample(s) are retained for 90 days only.

除非另有說明，此報告結果僅對測試之樣品負責，同時此樣品僅保留90天。本報告未經本公司書面許可，不可部份複製。

This document is issued by the Company subject to its General Conditions of Service printed overleaf, available on request or accessible at www.sgs.com/terms_and_conditions.htm and for electronic format documents, subject to Terms and Conditions for Electronic Documents at www.sgs.com/terms_e-document.htm. Attention is drawn to the limitation of liability, indemnification and jurisdiction issues defined therein. Any holder of this document is advised that information contained hereon reflects the Company's findings at the time of its intervention only and within the limits of Client's instructions, if any. The Company's sole responsibility is to its Client and this document does not exonerate parties to a transaction from exercising all their rights and obligations under the transaction documents. This document cannot be reproduced except in full, without prior written approval of the Company. Any unauthorized alteration, forgery or falsification of the content or appearance of this document is unlawful and offenders may be prosecuted to the fullest extent of the law.

devices such as cellular telephones will not be sufficient reason to allow these devices to be evaluated subject to limits for occupational/controlled exposure in paragraph (d)(1) of this section. (Table 4.)

Human Exposure	Uncontrolled Environment General Population	Controlled Environment Occupational
Spatial Peak SAR (Brain)	1.60 W/kg	8.00 W/kg
Spatial Average SAR (Whole Body)	0.08 W/kg	0.40 W/kg
Spatial Peak SAR (Hands/Feet/Ankle/Wrist)	4.00 W/kg	20.00 W/kg

Table 4. RF exposure limits

Notes:

1. Uncontrolled environments are defined as locations where there is potential exposure of individuals who have no knowledge or control of their potential exposure.
2. Controlled environments are defined as locations where there is potential exposure of individuals who have knowledge of their potential exposure and can exercise control over their exposure.

Unless otherwise stated the results shown in this test report refer only to the sample(s) tested and such sample(s) are retained for 90 days only.

除非另有說明，此報告結果僅對測試之樣品負責，同時此樣品僅保留90天。本報告未經本公司書面許可，不可部份複製。

This document is issued by the Company subject to its General Conditions of Service printed overleaf, available on request or accessible at www.sgs.com/terms_and_conditions.htm and for electronic format documents, subject to Terms and Conditions for Electronic Documents at www.sgs.com/terms_e-document.htm. Attention is drawn to the limitation of liability, indemnification and jurisdiction issues defined therein. Any holder of this document is advised that information contained hereon reflects the Company's findings at the time of its intervention only and within the limits of Client's instructions, if any. The Company's sole responsibility is to its Client and this document does not exonerate parties to a transaction from exercising all their rights and obligations under the transaction documents. This document cannot be reproduced except in full, without prior written approval of the Company. Any unauthorized alteration, forgery or falsification of the content or appearance of this document is unlawful and offenders may be prosecuted to the fullest extent of the law.

2. Summary of Results

2.1 Decision rules

Reported measurement data comply with IEEE 1528-2013:
Determining compliance shall be based on the results of the compliance measurement, not taking into account measurement instrumentation uncertainty.

2.2 Summary of Results

WWAN + WLAN

Full power

WCDMA Band II

Mode	Position	Distance (mm)	CH	Freq. (MHz)	Max. Rated Avg. Power + Max. Tolerance (dBm)	Measured Avg. Power (dBm)	Scaling	Averaged SAR over 1g (W/kg)		Plot page
								Measured	Reported	
WCDMA Band II	Back side	16	9262	1852.4	25.0	24.33	116.68%	0.511	0.596	-
	Top side	19	9262	1852.4	25.0	24.33	116.68%	0.566	0.660	537
	Top side	19	9400	1880	25.0	24.31	117.22%	0.531	0.622	-
	Top side	19	9538	1907.6	25.0	24.32	116.95%	0.542	0.634	-
	Bottom side	0	9262	1852.4	25.0	24.33	116.68%	0.032	0.037	-
	Right side	0	9262	1852.4	25.0	24.33	116.68%	0.076	0.089	-
	Left side	0	9262	1852.4	25.0	24.33	116.68%	0.200	0.233	-

WCDMA Band V

Mode	Position	Distance (mm)	CH	Freq. (MHz)	Max. Rated Avg. Power + Max. Tolerance (dBm)	Measured Avg. Power (dBm)	Scaling	Averaged SAR over 1g (W/kg)		Plot page
								Measured	Reported	
WCDMA Band V	Back side	16	4132	826.4	25.0	24.21	119.95%	0.177	0.212	-
	Top side	19	4132	826.4	25.0	24.21	119.95%	0.111	0.133	-
	Bottom side	0	4132	826.4	25.0	24.21	119.95%	0.030	0.036	-
	Right side	0	4132	826.4	25.0	24.21	119.95%	0.071	0.085	-
	Left side	0	4132	826.4	25.0	24.21	119.95%	0.244	0.293	538
	Left side	0	4183	836.6	25.0	24.13	122.18%	0.221	0.270	-
	Left side	0	4233	846.6	25.0	24.08	123.59%	0.216	0.267	-

Unless otherwise stated the results shown in this test report refer only to the sample(s) tested and such sample(s) are retained for 90 days only.

除非另有說明，此報告結果僅對測試之樣品負責，同時此樣品僅保留90天。本報告未經本公司書面許可，不可部份複製。

This document is issued by the Company subject to its General Conditions of Service printed overleaf, available on request or accessible at www.sgs.com/terms_and_conditions.htm and for electronic format documents, subject to Terms and Conditions for Electronic Documents at www.sgs.com/terms_e-document.htm. Attention is drawn to the limitation of liability, indemnification and jurisdiction issues defined therein. Any holder of this document is advised that information contained hereon reflects the Company's findings at the time of its intervention only and within the limits of Client's instructions, if any. The Company's sole responsibility is to its Client and this document does not exonerate parties to a transaction from exercising all their rights and obligations under the transaction documents. This document cannot be reproduced except in full, without prior written approval of the Company. Any unauthorized alteration, forgery or falsification of the content or appearance of this document is unlawful and offenders may be prosecuted to the fullest extent of the law.

LTE FDD Band 5

Mode	Bandwidth (MHz)	Modulation	RB Size	RB start	Position	Distance (mm)	CH	Freq. (MHz)	Max. Rated Avg. Power + Max. Tolerance (dBm)	Measured Avg. Power (dBm)	Scaling	Averaged SAR over 1g (W/kg)		Plot page	
												Measured	Reported		
LTE Band 5	10MHz	QPSK	1 RB	0	Back side	16	20450	829	25.0	24.13	122.18%	0.172	0.210	-	
					Top side	19	20450	829	25.0	24.13	122.18%	0.116	0.142	-	
					Bottom side	0	20450	829	25.0	24.13	122.18%	0.023	0.028	-	
					Right side	0	20450	829	25.0	24.13	122.18%	0.081	0.099	-	
					Left side	0	20450	829	25.0	24.13	122.18%	0.219	0.268	539	
					Left side	0	20525	836.5	25.0	24.04	124.74%	0.202	0.252	-	
				25	Left side	0	20600	844	25.0	24.09	123.31%	0.199	0.245	-	
				25 RB	0	Back side	16	20450	829	24.0	23.16	121.34%	0.129	0.157	-
						Top side	19	20450	829	24.0	23.16	121.34%	0.087	0.106	-
						Bottom side	0	20450	829	24.0	23.16	121.34%	0.017	0.021	-
					Right side	0	20450	829	24.0	23.16	121.34%	0.061	0.074	-	
					Left side	0	20450	829	24.0	23.16	121.34%	0.164	0.199	-	
			Left side		0	20450	829	24.0	23.08	123.59%	0.105	0.130	-		
			50 RB	0	Back side	16	20450	829	24.0	23.08	123.59%	0.071	0.088	-	
					Top side	19	20450	829	24.0	23.08	123.59%	0.014	0.017	-	
					Bottom side	0	20450	829	24.0	23.08	123.59%	0.050	0.061	-	
				Right side	0	20450	829	24.0	23.08	123.59%	0.050	0.061	-		
				Left side	0	20450	829	24.0	23.08	123.59%	0.134	0.166	-		
				Left side	0	20450	829	24.0	23.08	123.59%	0.134	0.166	-		

LTE FDD Band 7

Mode	Bandwidth (MHz)	Modulation	RB Size	RB start	Position	Distance (mm)	CH	Freq. (MHz)	Max. Rated Avg. Power + Max. Tolerance (dBm)	Measured Avg. Power (dBm)	Scaling	Averaged SAR over 1g (W/kg)		Plot page	
												Measured	Reported		
LTE Band 7	20MHz	QPSK	1 RB	0	Back side	16	21100	2535	22.8	22.69	102.57%	0.461	0.473	-	
					Top side	19	21100	2535	22.8	22.69	102.57%	0.274	0.281	-	
					Bottom side	0	21100	2535	22.8	22.69	102.57%	0.078	0.080	-	
					Right side	0	21100	2535	22.8	22.69	102.57%	0.074	0.076	-	
					Left side	0	20850	2510	22.8	22.65	103.51%	1.070	1.108	540	
					Left side*	0	20850	2510	22.8	22.65	103.51%	1.010	1.045	-	
				Left side	0	21100	2535	22.8	22.69	102.57%	0.959	0.984	-		
				Left side	0	21350	2560	22.8	22.68	102.80%	1.010	1.038	-		
				50 RB	25	Back side	16	21350	2560	21.8	21.63	103.99%	0.305	0.317	-
						Top side	19	21350	2560	21.8	21.63	103.99%	0.181	0.188	-
						Bottom side	0	21350	2560	21.8	21.63	103.99%	0.052	0.054	-
					Right side	0	21350	2560	21.8	21.63	103.99%	0.049	0.051	-	
			Left side		0	21350	2560	21.8	21.63	103.99%	0.634	0.659	-		
			Left side		0	21350	2560	21.8	21.63	103.99%	0.634	0.659	-		
			100 RB	0	Back side	16	21100	2535	21.8	21.57	105.44%	0.266	0.281	-	
					Top side	19	21100	2535	21.8	21.57	105.44%	0.158	0.167	-	
					Bottom side	0	21100	2535	21.8	21.57	105.44%	0.045	0.048	-	
				Right side	0	21100	2535	21.8	21.57	105.44%	0.043	0.045	-		
				Left side	0	21100	2535	21.8	21.57	105.44%	0.554	0.584	-		
				Left side	0	21100	2535	21.8	21.57	105.44%	0.554	0.584	-		

* - repeated at the highest SAR measurement according to the KDB 865664 D01

LTE FDD Band 12

Mode	Bandwidth (MHz)	Modulation	RB Size	RB start	Position	Distance (mm)	CH	Freq. (MHz)	Max. Rated Avg. Power + Max. Tolerance (dBm)	Measured Avg. Power (dBm)	Scaling	Averaged SAR over 1g (W/kg)		Plot page	
												Measured	Reported		
LTE Band 12	10MHz	QPSK	1 RB	0	Left side	0	23130	711	25.0	24.04	124.74%	0.174	0.217	-	
					Back side	16	23095	707.5	25.0	24.32	116.95%	0.181	0.212	-	
					Top side	19	23095	707.5	25.0	24.32	116.95%	0.108	0.126	-	
					Bottom side	0	23095	707.5	25.0	24.32	116.95%	0.021	0.025	-	
					Right side	0	23095	707.5	25.0	24.32	116.95%	0.075	0.088	-	
					Left side	0	23060	704	25.0	24.14	121.90%	0.171	0.208	-	
				25 RB	25	Left side	0	23095	707.5	25.0	24.32	116.95%	0.186	0.218	541
						Back side	16	23095	707.5	24.0	23.17	121.06%	0.111	0.135	-
						Top side	19	23095	707.5	24.0	23.17	121.06%	0.075	0.091	-
					Bottom side	0	23095	707.5	24.0	23.17	121.06%	0.015	0.018	-	
					Right side	0	23095	707.5	24.0	23.17	121.06%	0.052	0.063	-	
					Left side	0	23095	707.5	24.0	23.17	121.06%	0.142	0.171	-	
			50 RB	0	Back side	16	23060	704	24.0	23.20	120.23%	0.099	0.119	-	
					Top side	19	23060	704	24.0	23.20	120.23%	0.067	0.081	-	
					Bottom side	0	23060	704	24.0	23.20	120.23%	0.013	0.016	-	
				Right side	0	23060	704	24.0	23.20	120.23%	0.047	0.056	-		
				Left side	0	23060	704	24.0	23.20	120.23%	0.126	0.152	-		
				Left side	0	23060	704	24.0	23.20	120.23%	0.126	0.152	-		

Unless otherwise stated the results shown in this test report refer only to the sample(s) tested and such sample(s) are retained for 90 days only.

除非另有說明，此報告結果僅對測試之樣品負責，同時此樣品僅保留90天。本報告未經本公司書面許可，不可部份複製。

This document is issued by the Company subject to its General Conditions of Service printed overleaf, available on request or accessible at www.sgs.com/terms_and_conditions.htm and for electronic format documents, subject to Terms and Conditions for Electronic Documents at www.sgs.com/terms_e-document.htm. Attention is drawn to the limitation of liability, indemnification and jurisdiction issues defined therein. Any holder of this document is advised that information contained hereon reflects the Company's findings at the time of its intervention only and within the limits of Client's instructions, if any. The Company's sole responsibility is to its Client and this document does not exonerate parties to a transaction from exercising all their rights and obligations under the transaction documents. This document cannot be reproduced except in full, without prior written approval of the Company. Any unauthorized alteration, forgery or falsification of the content or appearance of this document is unlawful and offenders may be prosecuted to the fullest extent of the law.

LTE FDD Band 13

Mode	Bandwidth (MHz)	Modulation	RB Size	RB start	Position	Distance (mm)	CH	Freq. (MHz)	Max. Rated Avg. Power + Max. Tolerance (dBm)	Measured Avg. Power (dBm)	Scaling	Averaged SAR over 1g (W/kg)		Plot page
												Measured	Reported	
LTE Band 13	10MHz	QPSK	1 RB	0	Left side	0	23230	782	25.0	23.99	126.18%	0.181	0.228	-
					Left side	0	23230	782	25.0	24.12	122.46%	0.188	0.230	-
					Back side	16	23230	782	25.0	24.15	121.62%	0.159	0.193	-
					Top side	19	23230	782	25.0	24.15	121.62%	0.096	0.117	-
					Bottom side	0	23230	782	25.0	24.15	121.62%	0.019	0.023	-
					Right side	0	23230	782	25.0	24.15	121.62%	0.067	0.082	-
			25 RB	0	Left side	0	23230	782	25.0	24.15	121.62%	0.191	0.232	542
					Back side	16	23230	782	24.0	23.19	120.50%	0.111	0.134	-
					Top side	19	23230	782	24.0	23.19	120.50%	0.075	0.090	-
					Bottom side	0	23230	782	24.0	23.19	120.50%	0.015	0.018	-
					Right side	0	23230	782	24.0	23.19	120.50%	0.052	0.063	-
					Left side	0	23230	782	24.0	23.19	120.50%	0.142	0.171	-
			50 RB	0	Back side	16	23230	782	24.0	23.21	119.95%	0.122	0.146	-
					Top side	19	23230	782	24.0	23.21	119.95%	0.082	0.098	-
					Bottom side	0	23230	782	24.0	23.21	119.95%	0.016	0.020	-
					Right side	0	23230	782	24.0	23.21	119.95%	0.057	0.069	-
					Left side	0	23230	782	24.0	23.21	119.95%	0.155	0.186	-

LTE FDD Band 14

Mode	Bandwidth (MHz)	Modulation	RB Size	RB start	Position	Distance (mm)	CH	Freq. (MHz)	Max. Rated Avg. Power + Max. Tolerance (dBm)	Measured Avg. Power (dBm)	Scaling	Averaged SAR over 1g (W/kg)		Plot page
												Measured	Reported	
LTE Band 14	10MHz	QPSK	1 RB	0	Left side	0	23330	793	25.0	24.12	122.46%	0.176	0.216	-
					Left side	0	23330	793	25.0	24.10	123.03%	0.183	0.225	-
					Back side	16	23330	793	25.0	24.18	120.78%	0.157	0.190	-
					Top side	19	23330	793	25.0	24.18	120.78%	0.098	0.118	-
					Bottom side	0	23330	793	25.0	24.18	120.78%	0.019	0.023	-
					Right side	0	23330	793	25.0	24.18	120.78%	0.068	0.083	-
			25 RB	0	Left side	0	23330	793	25.0	24.18	120.78%	0.195	0.236	543
					Back side	16	23330	793	24.0	23.29	117.76%	0.105	0.124	-
					Top side	19	23330	793	24.0	23.29	117.76%	0.071	0.084	-
					Bottom side	0	23330	793	24.0	23.29	117.76%	0.014	0.017	-
					Right side	0	23330	793	24.0	23.29	117.76%	0.050	0.058	-
					Left side	0	23330	793	24.0	23.29	117.76%	0.134	0.158	-
			50 RB	0	Back side	16	23330	793	24.0	23.17	121.06%	0.098	0.118	-
					Top side	19	23330	793	24.0	23.17	121.06%	0.066	0.080	-
					Bottom side	0	23330	793	24.0	23.17	121.06%	0.013	0.016	-
					Right side	0	23330	793	24.0	23.17	121.06%	0.046	0.056	-
					Left side	0	23330	793	24.0	23.17	121.06%	0.125	0.151	-

LTE FDD Band 25

Mode	Bandwidth (MHz)	Modulation	RB Size	RB start	Position	Distance (mm)	CH	Freq. (MHz)	Max. Rated Avg. Power + Max. Tolerance (dBm)	Measured Avg. Power (dBm)	Scaling	Averaged SAR over 1g (W/kg)		Plot page
												Measured	Reported	
LTE Band 25	20MHz	QPSK	1 RB	0	Back side	16	26140	1860	25.0	24.49	112.46%	0.460	0.517	-
					Top side	19	26140	1860	25.0	24.49	112.46%	0.568	0.639	544
					Top side	19	26365	1882.5	25.0	24.14	121.90%	0.515	0.628	-
					Top side	19	26590	1905	25.0	24.48	112.72%	0.543	0.612	-
					Bottom side	0	26140	1860	25.0	24.49	112.46%	0.062	0.070	-
					Right side	0	26140	1860	25.0	24.49	112.46%	0.089	0.100	-
			50 RB	0	Left side	0	26140	1860	25.0	24.49	112.46%	0.083	0.093	-
					Back side	16	26590	1905	24.0	23.32	116.95%	0.305	0.357	-
					Top side	19	26590	1905	24.0	23.32	116.95%	0.507	0.593	-
					Bottom side	0	26590	1905	24.0	23.32	116.95%	0.056	0.065	-
					Right side	0	26590	1905	24.0	23.32	116.95%	0.080	0.094	-
					Left side	0	26590	1905	24.0	23.32	116.95%	0.074	0.087	-
			100 RB	0	Back side	16	26590	1905	24.0	23.16	121.34%	0.294	0.357	-
					Top side	19	26590	1905	24.0	23.16	121.34%	0.489	0.593	-
					Bottom side	0	26590	1905	24.0	23.16	121.34%	0.054	0.066	-
					Right side	0	26590	1905	24.0	23.16	121.34%	0.077	0.093	-
					Left side	0	26590	1905	24.0	23.16	121.34%	0.072	0.087	-

Unless otherwise stated the results shown in this test report refer only to the sample(s) tested and such sample(s) are retained for 90 days only.

除非另有說明，此報告結果僅對測試之樣品負責，同時此樣品僅保留90天。本報告未經本公司書面許可，不可部份複製。

This document is issued by the Company subject to its General Conditions of Service printed overleaf, available on request or accessible at www.sgs.com/terms_and_conditions.htm and for electronic format documents, subject to Terms and Conditions for Electronic Documents at www.sgs.com/terms_e-document.htm. Attention is drawn to the limitation of liability, indemnification and jurisdiction issues defined therein. Any holder of this document is advised that information contained hereon reflects the Company's findings at the time of its intervention only and within the limits of Client's instructions, if any. The Company's sole responsibility is to its Client and this document does not exonerate parties to a transaction from exercising all their rights and obligations under the transaction documents. This document cannot be reproduced except in full, without prior written approval of the Company. Any unauthorized alteration, forgery or falsification of the content or appearance of this document is unlawful and offenders may be prosecuted to the fullest extent of the law.

LTE FDD Band 26

Mode	Bandwidth (MHz)	Modulation	RB Size	RB start	Position	Distance (mm)	CH	Freq. (MHz)	Max. Rated Avg. Power + Max. Tolerance (dBm)	Measured Avg. Power (dBm)	Scaling	Averaged SAR over 1g (W/kg)		Plot page
												Measured	Reported	
LTE Band 26	15MHz	QPSK	1 RB	36	Back side	16	26865	831.5	25.0	24.09	123.31%	0.174	0.215	-
					Top side	19	26865	831.5	25.0	24.09	123.31%	0.131	0.162	-
					Bottom side	0	26865	831.5	25.0	24.09	123.31%	0.022	0.027	-
					Right side	0	26865	831.5	25.0	24.09	123.31%	0.076	0.094	-
					Left side	0	26765	821.5	25.0	24.07	123.88%	0.202	0.250	-
					Left side	0	26865	831.5	25.0	24.09	123.31%	0.216	0.266	545
			Left side	0	26965	841.5	25.0	24.04	124.74%	0.196	0.244	-		
			36 RB	18	Back side	16	26765	821.5	24.0	23.20	120.23%	0.142	0.171	-
					Top side	19	26765	821.5	24.0	23.20	120.23%	0.088	0.106	-
					Bottom side	0	26765	821.5	24.0	23.20	120.23%	0.018	0.022	-
					Right side	0	26765	821.5	24.0	23.20	120.23%	0.062	0.075	-
					Left side	0	26765	821.5	24.0	23.20	120.23%	0.176	0.212	-
					Back side	16	26765	821.5	24.0	23.09	123.31%	0.138	0.170	-
			75 RB		Top side	19	26765	821.5	24.0	23.09	123.31%	0.086	0.106	-
					Bottom side	0	26765	821.5	24.0	23.09	123.31%	0.017	0.021	-
					Right side	0	26765	821.5	24.0	23.09	123.31%	0.060	0.074	-
					Left side	0	26765	821.5	24.0	23.09	123.31%	0.171	0.211	-

LTE FDD Band 30

Mode	Bandwidth (MHz)	Modulation	RB Size	RB start	Position	Distance (mm)	CH	Freq. (MHz)	Max. Rated Avg. Power + Max. Tolerance (dBm)	Measured Avg. Power (dBm)	Scaling	Averaged SAR over 1g (W/kg)		Plot page		
												Measured	Reported			
LTE Band 30	10MHz	QPSK	1 RB	0	Back side	16	27710	2310	23.5	22.99	112.46%	0.354	0.398	-		
					Top side	19	27710	2310	23.5	22.99	112.46%	0.277	0.312	-		
					Bottom side	0	27710	2310	23.5	22.99	112.46%	0.083	0.093	-		
					Right side	0	27710	2310	23.5	22.99	112.46%	0.037	0.042	-		
					Left side	0	27710	2310	23.5	22.99	112.46%	0.818	0.920	546		
					Left side*	0	27710	2310	23.5	22.99	112.46%	0.805	0.905	-		
					Left side	0	27710	2310	23.5	22.98	112.72%	0.794	0.895	-		
					Left side	0	27710	2310	23.5	22.96	113.24%	0.782	0.886	-		
					25 RB	0	Back side	16	27710	2310	22.5	22.26	105.68%	0.302	0.319	-
							Top side	19	27710	2310	22.5	22.26	105.68%	0.148	0.156	-
							Bottom side	0	27710	2310	22.5	22.26	105.68%	0.070	0.074	-
							Right side	0	27710	2310	22.5	22.26	105.68%	0.031	0.033	-
			Left side	0			27710	2310	22.5	22.26	105.68%	0.691	0.730	-		
			Back side	16			27710	2310	22.5	22.23	106.41%	0.293	0.312	-		
			50 RB		Top side	19	27710	2310	22.5	22.23	106.41%	0.144	0.153	-		
					Bottom side	0	27710	2310	22.5	22.23	106.41%	0.069	0.073	-		
					Right side	0	27710	2310	22.5	22.23	106.41%	0.030	0.032	-		
					Left side	0	27710	2310	22.5	22.23	106.41%	0.672	0.715	-		

* - repeated at the highest SAR measurement according to the KDB 865664 D01

Unless otherwise stated the results shown in this test report refer only to the sample(s) tested and such sample(s) are retained for 90 days only.

除非另有說明，此報告結果僅對測試之樣品負責，同時此樣品僅保留90天。本報告未經本公司書面許可，不可部份複製。

This document is issued by the Company subject to its General Conditions of Service printed overleaf, available on request or accessible at www.sgs.com/terms_and_conditions.htm and for electronic format documents, subject to Terms and Conditions for Electronic Documents at www.sgs.com/terms_e-document.htm. Attention is drawn to the limitation of liability, indemnification and jurisdiction issues defined therein. Any holder of this document is advised that information contained hereon reflects the Company's findings at the time of its intervention only and within the limits of Client's instructions, if any. The Company's sole responsibility is to its Client and this document does not exonerate parties to a transaction from exercising all their rights and obligations under the transaction documents. This document cannot be reproduced except in full, without prior written approval of the Company. Any unauthorized alteration, forgery or falsification of the content or appearance of this document is unlawful and offenders may be prosecuted to the fullest extent of the law.

LTE TDD Band 41

Mode	Bandwidth (MHz)	Modulation	RB Size	RB start	Position	Distance (mm)	CH	Freq. (MHz)	Max. Rated Avg. Power + Max. Tolerance (dBm)	Measured Avg. Power (dBm)	Scaling	Averaged SAR over 1g (W/kg)		Plot page
												Measured	Reported	
LTE Band 41	20MHz	QPSK	1 RB	0	Back side	16	41490	2680	24.5	23.99	112.46%	0.188	0.211	-
					Top side	19	41490	2680	24.5	23.99	112.46%	0.069	0.077	-
					Bottom side	0	41490	2680	24.5	23.99	112.46%	0.066	0.074	-
					Right side	0	41490	2680	24.5	23.99	112.46%	0.029	0.033	-
					Left side	0	39750	2506	24.5	23.84	116.41%	0.584	0.680	-
					Left side	0	40185	2549.5	24.5	23.75	118.85%	0.598	0.711	-
					Left side	0	40620	2593	24.5	23.75	118.85%	0.612	0.727	-
					Left side	0	41055	2636.5	24.5	23.72	119.67%	0.601	0.719	-
					Left side	0	41490	2680	24.5	23.99	112.46%	0.650	0.731	547
					Back side	16	41490	2680	23.5	22.95	113.50%	0.223	0.253	-
					Top side	19	41490	2680	23.5	22.95	113.50%	0.110	0.125	-
					Bottom side	0	41490	2680	23.5	22.95	113.50%	0.052	0.059	-
			Right side	0	41490	2680	23.5	22.95	113.50%	0.023	0.026	-		
			Left side	0	41490	2680	23.5	22.95	113.50%	0.512	0.581	-		
			50 RB	0	Back side	16	41490	2680	23.5	22.98	112.72%	0.220	0.248	-
					Top side	19	41490	2680	23.5	22.98	112.72%	0.108	0.122	-
					Bottom side	0	41490	2680	23.5	22.98	112.72%	0.052	0.059	-
					Right side	0	41490	2680	23.5	22.98	112.72%	0.023	0.026	-
					Left side	0	41490	2680	23.5	22.98	112.72%	0.505	0.569	-
					Left side	0	41490	2680	23.5	22.98	112.72%	0.505	0.569	-
			100 RB	0	Back side	16	41490	2680	23.5	22.98	112.72%	0.220	0.248	-
					Top side	19	41490	2680	23.5	22.98	112.72%	0.108	0.122	-
					Bottom side	0	41490	2680	23.5	22.98	112.72%	0.052	0.059	-
					Right side	0	41490	2680	23.5	22.98	112.72%	0.023	0.026	-
Left side	0	41490			2680	23.5	22.98	112.72%	0.505	0.569	-			
Left side	0	41490			2680	23.5	22.98	112.72%	0.505	0.569	-			

LTE FDD Band 66

Mode	Bandwidth (MHz)	Modulation	RB Size	RB start	Position	Distance (mm)	CH	Freq. (MHz)	Max. Rated Avg. Power + Max. Tolerance (dBm)	Measured Avg. Power (dBm)	Scaling	Averaged SAR over 1g (W/kg)		Plot page		
												Measured	Reported			
LTE Band 66	20MHz	QPSK	1 RB	0	Back side	16	132072	1720	24.5	24.49	100.23%	0.489	0.490	-		
					Top side	19	132072	1720	24.5	24.49	100.23%	0.674	0.676	-		
					Top side	19	132322	1745	24.5	24.28	105.20%	0.803	0.845	548		
					Top side*	19	132322	1745	24.5	24.28	105.20%	0.803	0.845	-		
					Top side	19	132572	1770	24.5	24.47	100.69%	0.769	0.774	-		
					Bottom side	0	132072	1720	24.5	24.49	100.23%	0.074	0.074	-		
					Right side	0	132072	1720	24.5	24.49	100.23%	0.106	0.106	-		
					Left side	0	132072	1720	24.5	24.49	100.23%	0.099	0.099	-		
					50 RB	0	Back side	16	132322	1745	23.5	23.46	100.93%	0.472	0.476	-
							Top side	19	132322	1745	23.5	23.46	100.93%	0.608	0.614	-
							Bottom side	0	132322	1745	23.5	23.46	100.93%	0.066	0.067	-
							Right side	0	132322	1745	23.5	23.46	100.93%	0.095	0.096	-
			Left side	0			132322	1745	23.5	23.46	100.93%	0.089	0.090	-		
			Left side	0			132322	1745	23.5	23.46	100.93%	0.089	0.090	-		
			100 RB	0	Back side	16	132572	1770	23.5	23.12	109.14%	0.398	0.434	-		
					Top side	19	132572	1770	23.5	23.12	109.14%	0.492	0.537	-		
					Bottom side	0	132572	1770	23.5	23.12	109.14%	0.054	0.059	-		
					Right side	0	132572	1770	23.5	23.12	109.14%	0.077	0.084	-		
					Left side	0	132572	1770	23.5	23.12	109.14%	0.072	0.079	-		
					Left side	0	132572	1770	23.5	23.12	109.14%	0.072	0.079	-		

* - repeated at the highest SAR measurement according to the KDB 865664 D01

Unless otherwise stated the results shown in this test report refer only to the sample(s) tested and such sample(s) are retained for 90 days only.

除非另有說明，此報告結果僅對測試之樣品負責，同時此樣品僅保留90天。本報告未經本公司書面許可，不可部份複製。

This document is issued by the Company subject to its General Conditions of Service printed overleaf, available on request or accessible at www.sgs.com/terms_and_conditions.htm and for electronic format documents, subject to Terms and Conditions for Electronic Documents at www.sgs.com/terms_e-document.htm. Attention is drawn to the limitation of liability, indemnification and jurisdiction issues defined therein. Any holder of this document is advised that information contained hereon reflects the Company's findings at the time of its intervention only and within the limits of Client's instructions, if any. The Company's sole responsibility is to its Client and this document does not exonerate parties to a transaction from exercising all their rights and obligations under the transaction documents. This document cannot be reproduced except in full, without prior written approval of the Company. Any unauthorized alteration, forgery or falsification of the content or appearance of this document is unlawful and offenders may be prosecuted to the fullest extent of the law.

Reduced power

WCDMA Band II

Mode	Position	Distance (mm)	CH	Freq. (MHz)	Max. Rated Avg. Power + Max. Tolerance (dBm)	Measured Avg. Power (dBm)	Scaling	Averaged SAR over 1g (W/kg)		Plot page
								Measured	Reported	
WCDMA Band II	Back side	0	9262	1852.4	16.0	15.80	104.71%	0.830	0.869	-
	Back side	0	9400	1880	16.0	15.81	104.47%	0.801	0.837	-
	Back side	0	9538	1907.6	16.0	15.83	103.99%	0.868	0.903	549
	Back side*	0	9538	1907.6	16.0	15.83	103.99%	0.858	0.892	-
	Top side	0	9538	1907.6	16.0	15.83	103.99%	0.435	0.452	-

* - repeated at the highest SAR measurement according to the KDB 865664 D01

WCDMA Band V

Mode	Position	Distance (mm)	CH	Freq. (MHz)	Max. Rated Avg. Power + Max. Tolerance (dBm)	Measured Avg. Power (dBm)	Scaling	Averaged SAR over 1g (W/kg)		Plot page
								Measured	Reported	
WCDMA Band V	Back side	0	4233	846.6	19.5	19.14	108.64%	0.462	0.502	-
	Top side	0	4132	826.4	19.5	19.05	110.92%	0.800	0.887	550
	Top side*	0	4132	826.4	19.5	19.05	110.92%	0.798	0.885	-
	Top side	0	4183	836.6	19.5	19.08	110.15%	0.799	0.880	-
	Top side	0	4233	846.6	19.5	19.14	108.64%	0.789	0.857	-

* - repeated at the highest SAR measurement according to the KDB 865664 D01

Unless otherwise stated the results shown in this test report refer only to the sample(s) tested and such sample(s) are retained for 90 days only.

除非另有說明，此報告結果僅對測試之樣品負責，同時此樣品僅保留90天。本報告未經本公司書面許可，不可部份複製。

This document is issued by the Company subject to its General Conditions of Service printed overleaf, available on request or accessible at www.sgs.com/terms_and_conditions.htm and for electronic format documents, subject to Terms and Conditions for Electronic Documents at www.sgs.com/terms_e-document.htm. Attention is drawn to the limitation of liability, indemnification and jurisdiction issues defined therein. Any holder of this document is advised that information contained hereon reflects the Company's findings at the time of its intervention only and within the limits of Client's instructions, if any. The Company's sole responsibility is to its Client and this document does not exonerate parties to a transaction from exercising all their rights and obligations under the transaction documents. This document cannot be reproduced except in full, without prior written approval of the Company. Any unauthorized alteration, forgery or falsification of the content or appearance of this document is unlawful and offenders may be prosecuted to the fullest extent of the law.

LTE FDD Band 5

Mode	Bandwidth (MHz)	Modulation	RB Size	RB start	Position	Distance (mm)	CH	Freq. (MHz)	Max. Rated Avg. Power + Max. Tolerance (dBm)	Measured Avg. Power (dBm)	Scaling	Averaged SAR over 1g (W/kg)		Plot page
												Measured	Reported	
LTE Band 5	10MHz	QPSK	1 RB	0	Back side	0	20450	829	20.0	19.68	107.65%	0.532	0.573	-
					Top side	0	20450	829	20.0	19.68	107.65%	0.891	0.959	551
					Top side	0	20525	836.5	20.0	19.65	108.39%	0.866	0.939	-
					Top side	0	20600	844	20.0	19.60	109.65%	0.791	0.867	-
					Top side*	0	20450	829	20.0	19.68	107.65%	0.888	0.956	-
			25 RB	25	Back side	0	20450	829	19.0	18.74	106.17%	0.428	0.454	-
					Top side	0	20450	829	19.0	18.74	106.17%	0.718	0.762	-
					Back side	0	20525	836.5	19.0	18.69	107.40%	0.424	0.455	-
					Top side	0	20525	836.5	19.0	18.69	107.40%	0.709	0.761	-
					Top side	0	20525	836.5	19.0	18.69	107.40%	0.709	0.761	-

* - repeated at the highest SAR measurement according to the KDB 865664 D01

LTE FDD Band 7

Mode	Bandwidth (MHz)	Modulation	RB Size	RB start	Position	Distance (mm)	CH	Freq. (MHz)	Max. Rated Avg. Power + Max. Tolerance (dBm)	Measured Avg. Power (dBm)	Scaling	Averaged SAR over 1g (W/kg)		Plot page
												Measured	Reported	
LTE Band 7	20MHz	QPSK	1 RB	0	Back side	0	21350	2560	15.0	14.54	111.17%	0.855	0.951	552
					Back side*	0	21350	2560	15.0	14.54	111.17%	0.851	0.946	-
					Top side	0	21350	2560	15.0	14.54	111.17%	0.315	0.350	-
					Back side	0	20850	2510	15.0	14.50	112.20%	0.706	0.792	-
					Back side	0	21100	2535	15.0	14.52	111.69%	0.794	0.887	-
			50 RB	25	Back side	0	21350	2560	14.0	13.62	109.14%	0.692	0.755	-
					Top side	0	21350	2560	14.0	13.62	109.14%	0.255	0.278	-
					Back side	0	21350	2560	14.0	13.60	109.65%	0.689	0.755	-
					Top side	0	21350	2560	14.0	13.60	109.65%	0.254	0.279	-
					Top side	0	21350	2560	14.0	13.60	109.65%	0.254	0.279	-

* - repeated at the highest SAR measurement according to the KDB 865664 D01

LTE FDD Band 12

Mode	Bandwidth (MHz)	Modulation	RB Size	RB start	Position	Distance (mm)	CH	Freq. (MHz)	Max. Rated Avg. Power + Max. Tolerance (dBm)	Measured Avg. Power (dBm)	Scaling	Averaged SAR over 1g (W/kg)		Plot page
												Measured	Reported	
LTE Band 12	10MHz	QPSK	1 RB	0	Top side	0	23060	704	20.0	19.48	112.72%	0.655	0.738	-
					Back side	0	23095	707.5	20.0	19.65	108.39%	0.618	0.670	-
					Top side	0	23095	707.5	20.0	19.65	108.39%	0.703	0.762	553
					Top side	0	23130	711	20.0	19.58	110.15%	0.642	0.707	-
					Back side	0	23060	704	19.0	18.79	104.95%	0.508	0.533	-
			25 RB	25	Top side	0	23060	704	19.0	18.79	104.95%	0.581	0.610	-
					Back side	0	23060	704	19.0	18.77	105.44%	0.506	0.534	-
					Top side	0	23060	704	19.0	18.77	105.44%	0.571	0.602	-
					Back side	0	23060	704	19.0	18.77	105.44%	0.571	0.602	-
					Top side	0	23060	704	19.0	18.77	105.44%	0.571	0.602	-

Unless otherwise stated the results shown in this test report refer only to the sample(s) tested and such sample(s) are retained for 90 days only.

除非另有說明，此報告結果僅對測試之樣品負責，同時此樣品僅保留90天。本報告未經本公司書面許可，不可部份複製。

This document is issued by the Company subject to its General Conditions of Service printed overleaf, available on request or accessible at www.sgs.com/terms_and_conditions.htm and for electronic format documents, subject to Terms and Conditions for Electronic Documents at www.sgs.com/terms_e-document.htm. Attention is drawn to the limitation of liability, indemnification and jurisdiction issues defined therein. Any holder of this document is advised that information contained hereon reflects the Company's findings at the time of its intervention only and within the limits of Client's instructions, if any. The Company's sole responsibility is to its Client and this document does not exonerate parties to a transaction from exercising all their rights and obligations under the transaction documents. This document cannot be reproduced except in full, without prior written approval of the Company. Any unauthorized alteration, forgery or falsification of the content or appearance of this document is unlawful and offenders may be prosecuted to the fullest extent of the law.

LTE FDD Band 13

Mode	Bandwidth (MHz)	Modulation	RB Size	RB start	Position	Distance (mm)	CH	Freq. (MHz)	Max. Rated Avg. Power + Max. Tolerance (dBm)	Measured Avg. Power (dBm)	Scaling	Averaged SAR over 1g (W/kg)		Plot page
												Measured	Reported	
LTE Band 13	10MHz	QPSK	1 RB	0	Back side	0	23230	782	20.0	19.52	111.69%	0.560	0.625	-
					Top side	0	23230	782	20.0	19.52	111.69%	0.821	0.917	-
				25	Top side	0	23230	782	20.0	19.41	114.55%	0.814	0.932	-
				49	Top side	0	23230	782	20.0	19.44	113.76%	0.834	0.949	554
					Top side*	0	23230	782	20.0	19.44	113.76%	0.820	0.933	-
			25 RB	0	Back side	0	23230	782	19.0	18.54	111.17%	0.447	0.497	-
					Top side	0	23230	782	19.0	18.54	111.17%	0.655	0.728	-
				50 RB	Back side	0	23230	782	19.0	18.52	111.69%	0.446	0.498	-
					Top side	0	23230	782	19.0	18.52	111.69%	0.649	0.725	-

* - repeated at the highest SAR measurement according to the KDB 865664 D01

LTE FDD Band 14

Mode	Bandwidth (MHz)	Modulation	RB Size	RB start	Position	Distance (mm)	CH	Freq. (MHz)	Max. Rated Avg. Power + Max. Tolerance (dBm)	Measured Avg. Power (dBm)	Scaling	Averaged SAR over 1g (W/kg)		Plot page
												Measured	Reported	
LTE Band 14	10MHz	QPSK	1 RB	0	Back side	0	23330	793	19.5	19.02	111.69%	0.495	0.553	-
					Top side	0	23330	793	19.5	19.02	111.69%	0.754	0.842	-
				25	Top side	0	23330	793	19.5	18.95	113.50%	0.755	0.857	-
				49	Top side	0	23330	793	19.5	18.89	115.08%	0.766	0.882	555
					Top side*	0	23330	793	19.5	18.89	115.08%	0.766	0.882	555
			25 RB	0	Back side	0	23330	793	18.5	18.06	110.66%	0.395	0.437	-
					Top side	0	23330	793	18.5	18.06	110.66%	0.601	0.665	-
				50 RB	Back side	0	23330	793	18.5	18.03	111.43%	0.403	0.449	-
					Top side	0	23330	793	18.5	18.03	111.43%	0.651	0.725	-

LTE FDD Band 25

Mode	Bandwidth (MHz)	Modulation	RB Size	RB start	Position	Distance (mm)	CH	Freq. (MHz)	Max. Rated Avg. Power + Max. Tolerance (dBm)	Measured Avg. Power (dBm)	Scaling	Averaged SAR over 1g (W/kg)		Plot page
												Measured	Reported	
LTE Band 25	20MHz	QPSK	1 RB	0	Back side	0	26140	1860	15.6	15.11	111.94%	0.879	0.984	556
					Back side*	0	26140	1860	15.6	15.11	111.94%	0.869	0.973	-
					Back side	0	26365	1882.5	15.6	15.02	114.29%	0.840	0.960	-
					Back side	0	26590	1905	15.6	15.08	112.72%	0.788	0.888	-
					Top side	0	26140	1860	15.6	15.11	111.94%	0.421	0.471	-
			50 RB	0	Back side	0	26590	1905	15.6	14.09	141.58%	0.694	0.983	-
					Top side	0	26590	1905	15.6	14.09	141.58%	0.339	0.480	-
				100 RB	Back side	0	26590	1905	15.6	14.01	144.21%	0.682	0.984	-
					Top side	0	26590	1905	15.6	14.01	144.21%	0.327	0.472	-

* - repeated at the highest SAR measurement according to the KDB 865664 D01

Unless otherwise stated the results shown in this test report refer only to the sample(s) tested and such sample(s) are retained for 90 days only.

除非另有說明，此報告結果僅對測試之樣品負責，同時此樣品僅保留90天。本報告未經本公司書面許可，不可部份複製。

This document is issued by the Company subject to its General Conditions of Service printed overleaf, available on request or accessible at www.sgs.com/terms_and_conditions.htm and for electronic format documents, subject to Terms and Conditions for Electronic Documents at www.sgs.com/terms_e-document.htm. Attention is drawn to the limitation of liability, indemnification and jurisdiction issues defined therein. Any holder of this document is advised that information contained hereon reflects the Company's findings at the time of its intervention only and within the limits of Client's instructions, if any. The Company's sole responsibility is to its Client and this document does not exonerate parties to a transaction from exercising all their rights and obligations under the transaction documents. This document cannot be reproduced except in full, without prior written approval of the Company. Any unauthorized alteration, forgery or falsification of the content or appearance of this document is unlawful and offenders may be prosecuted to the fullest extent of the law.

LTE FDD Band 26

Mode	Bandwidth (MHz)	Modulation	RB Size	RB start	Position	Distance (mm)	CH	Freq. (MHz)	Max. Rated Avg. Power + Max. Tolerance (dBm)	Measured Avg. Power (dBm)	Scaling	Averaged SAR over 1g (W/kg)		Plot page
												Measured	Reported	
LTE Band 26	15MHz	QPSK	1 RB	36	Back side	0	26965	841.5	20.0	19.62	109.14%	0.494	0.539	-
					Top side	0	26765	821.5	20.0	19.57	110.41%	0.887	0.979	557
					Top side*	0	26765	821.5	20.0	19.57	110.41%	0.884	0.976	-
					Top side	0	26865	831.5	20.0	19.55	110.92%	0.824	0.914	-
					Top side	0	26965	841.5	20.0	19.62	109.14%	0.783	0.855	-
			36 RB	18	Back side	0	26765	821.5	19.0	18.70	107.15%	0.401	0.430	-
					Top side	0	26765	821.5	19.0	18.70	107.15%	0.635	0.680	-
					Back side	0	26965	841.5	19.0	18.71	106.91%	0.409	0.437	-
			75 RB		Back side	0	26965	841.5	19.0	18.71	106.91%	0.641	0.685	-
					Top side	0	26965	841.5	19.0	18.71	106.91%	0.641	0.685	-

* - repeated at the highest SAR measurement according to the KDB 865664 D01

LTE FDD Band 30

Mode	Bandwidth (MHz)	Modulation	RB Size	RB start	Position	Distance (mm)	CH	Freq. (MHz)	Max. Rated Avg. Power + Max. Tolerance (dBm)	Measured Avg. Power (dBm)	Scaling	Averaged SAR over 1g (W/kg)		Plot page
												Measured	Reported	
LTE Band 30	10MHz	QPSK	1 RB	0	Back side	0	27710	2310	16.5	16.30	104.71%	0.836	0.875	558
					Back side*	0	27710	2310	16.5	16.30	104.71%	0.831	0.870	-
					Top side	0	27710	2310	16.5	16.30	104.71%	0.518	0.542	-
					Back side	0	27710	2310	16.5	16.18	107.65%	0.793	0.854	-
					Back side	0	27710	2310	16.5	16.26	105.68%	0.783	0.827	-
			25 RB	12	Back side	0	27710	2310	15.5	15.28	105.20%	0.662	0.696	-
					Top side	0	27710	2310	15.5	15.28	105.20%	0.415	0.437	-
					Back side	0	27710	2310	15.5	15.24	106.17%	0.660	0.701	-
			50 RB		Back side	0	27710	2310	15.5	15.24	106.17%	0.402	0.427	-
					Top side	0	27710	2310	15.5	15.24	106.17%	0.402	0.427	-

* - repeated at the highest SAR measurement according to the KDB 865664 D01

LTE TDD Band 41

Mode	Bandwidth (MHz)	Modulation	RB Size	RB start	Position	Distance (mm)	CH	Freq. (MHz)	Max. Rated Avg. Power + Max. Tolerance (dBm)	Measured Avg. Power (dBm)	Scaling	Averaged SAR over 1g (W/kg)		Plot page
												Measured	Reported	
LTE Band 41	20MHz	QPSK	1 RB	0	Back side	0	39750	2506	17.3	17.10	104.71%	0.377	0.395	-
					Back side	0	40185	2549.5	17.3	17.14	103.75%	0.556	0.577	-
					Back side	0	40620	2593	17.3	17.15	103.51%	0.598	0.619	-
					Back side	0	41055	2636.5	17.3	17.17	103.04%	0.560	0.577	-
					Back side	0	41490	2680	17.3	17.28	100.46%	0.685	0.688	559
			50 RB	0	Top side	0	41490	2680	17.3	17.28	100.46%	0.114	0.115	-
					Back side	0	41490	2680	16.3	16.27	100.69%	0.394	0.397	-
					Top side	0	41490	2680	16.3	16.27	100.69%	0.066	0.066	-
			100 RB		Back side	0	41490	2680	16.3	16.25	101.16%	0.391	0.396	-
					Top side	0	41490	2680	16.3	16.25	101.16%	0.065	0.066	-

LTE FDD Band 66

Mode	Bandwidth (MHz)	Modulation	RB Size	RB start	Position	Distance (mm)	CH	Freq. (MHz)	Max. Rated Avg. Power + Max. Tolerance (dBm)	Measured Avg. Power (dBm)	Scaling	Averaged SAR over 1g (W/kg)		Plot page
												Measured	Reported	
LTE Band 66	20MHz	QPSK	1 RB	0	Back side	0	132072	1720	16.9	16.51	109.40%	0.683	0.747	-
					Back side	0	132572	1770	16.9	16.58	107.65%	0.894	0.962	560
					Back side*	0	132572	1770	16.9	16.58	107.65%	0.889	0.957	-
					Top side	0	132572	1770	16.9	16.58	107.65%	0.677	0.729	-
					Back side	0	132322	1745	16.9	16.37	112.98%	0.816	0.922	-
			50 RB	0	Back side	0	132322	1745	15.9	15.53	108.89%	0.702	0.764	-
					Top side	0	132322	1745	15.9	15.53	108.89%	0.532	0.579	-
					Back side	0	132322	1745	15.9	15.11	119.95%	0.653	0.783	-
			100 RB		Back side	0	132322	1745	15.9	15.11	119.95%	0.511	0.613	-
					Top side	0	132322	1745	15.9	15.11	119.95%	0.511	0.613	-

* - repeated at the highest SAR measurement according to the KDB 865664 D01

Unless otherwise stated the results shown in this test report refer only to the sample(s) tested and such sample(s) are retained for 90 days only.

除非另有說明，此報告結果僅對測試之樣品負責，同時此樣品僅保留90天。本報告未經本公司書面許可，不可部份複製。

This document is issued by the Company subject to its General Conditions of Service printed overleaf, available on request or accessible at www.sgs.com/terms_and_conditions.htm and for electronic format documents, subject to Terms and Conditions for Electronic Documents at www.sgs.com/terms_e-document.htm. Attention is drawn to the limitation of liability, indemnification and jurisdiction issues defined therein. Any holder of this document is advised that information contained hereon reflects the Company's findings at the time of its intervention only and within the limits of Client's instructions, if any. The Company's sole responsibility is to its Client and this document does not exonerate parties to a transaction from exercising all their rights and obligations under the transaction documents. This document cannot be reproduced except in full, without prior written approval of the Company. Any unauthorized alteration, forgery or falsification of the content or appearance of this document is unlawful and offenders may be prosecuted to the fullest extent of the law.

WWAN + WLAN Full Power with Wi-Fi 1 and Wi-Fi 2 SAR Sensors OFF

WLAN Tx1 Antenna

Antenna	Mode	Position	Distance (mm)	CH	Freq. (MHz)	Max. Rated Avg. Power + Max. Tolerance (dBm)	Measured Avg. Power (dBm)	Duty cycle scaling	Power scaling	Averaged SAR over 1g (W/kg)		Plot page
										Measured	Reported	
Tx1	WLAN 802.11b	Back side	0	1	2412	10.50	10.45	1.01	101.16%	0.204	0.209	-
		Back side	0	6	2437	10.50	10.44	1.01	101.39%	0.214	0.220	561
		Back side	0	11	2462	10.50	10.42	1.01	101.86%	0.193	0.199	-
		Top side	4	1	2412	10.50	10.45	1.01	101.16%	0.031	0.032	-
		Bottom side	0	1	2412	10.50	10.45	1.01	101.16%	0.006	0.007	-
		Right side	0	1	2412	10.50	10.45	1.01	101.16%	0.001	0.001	-
		Left side	0	1	2412	10.50	10.45	1.01	101.16%	0.002	0.002	-
	WLAN 802.11ac(160M) 5.2G	Back side	0	50	5250	9.00	8.97	1.02	100.69%	0.114	0.117	562
		Top side	4	50	5250	9.00	8.97	1.02	100.69%	0.108	0.110	-
		Bottom side	0	50	5250	9.00	8.97	1.02	100.69%	0.027	0.028	-
		Right side	0	50	5250	9.00	8.97	1.02	100.69%	0.016	0.016	-
		Left side	0	50	5250	9.00	8.97	1.02	100.69%	0.015	0.015	-
	WLAN 802.11ac(80M) 5.3G	Back side	0	58	5290	9.00	8.95	1.01	101.16%	0.207	0.212	563
		Top side	4	58	5290	9.00	8.95	1.01	101.16%	0.130	0.133	-
		Bottom side	0	58	5290	9.00	8.95	1.01	101.16%	0.049	0.050	-
		Right side	0	58	5290	9.00	8.95	1.01	101.16%	0.029	0.030	-
		Left side	0	58	5290	9.00	8.95	1.01	101.16%	0.027	0.028	-
	WLAN 802.11ac(160M) 5.6G	Back side	0	114	5570	9.00	8.91	1.02	102.09%	0.220	0.228	564
		Top side	4	114	5570	9.00	8.91	1.02	102.09%	0.150	0.155	-
		Bottom side	0	114	5570	9.00	8.91	1.02	102.09%	0.052	0.054	-
		Right side	0	114	5570	9.00	8.91	1.02	102.09%	0.031	0.032	-
		Left side	0	114	5570	9.00	8.91	1.02	102.09%	0.029	0.030	-
	WLAN 802.11ac(80M) 5.8G	Back side	0	155	5775	9.00	8.92	1.01	101.86%	0.201	0.207	565
		Top side	4	155	5775	9.00	8.92	1.01	101.86%	0.156	0.161	-
		Bottom side	0	155	5775	9.00	8.92	1.01	101.86%	0.048	0.049	-
		Right side	0	155	5775	9.00	8.92	1.01	101.86%	0.028	0.029	-
		Left side	0	155	5775	9.00	8.92	1.01	101.86%	0.026	0.027	-

Unless otherwise stated the results shown in this test report refer only to the sample(s) tested and such sample(s) are retained for 90 days only.

除非另有說明，此報告結果僅對測試之樣品負責，同時此樣品僅保留90天。本報告未經本公司書面許可，不可部份複製。

This document is issued by the Company subject to its General Conditions of Service printed overleaf, available on request or accessible at www.sgs.com/terms_and_conditions.htm and for electronic format documents, subject to Terms and Conditions for Electronic Documents at www.sgs.com/terms_e-document.htm. Attention is drawn to the limitation of liability, indemnification and jurisdiction issues defined therein. Any holder of this document is advised that information contained hereon reflects the Company's findings at the time of its intervention only and within the limits of Client's instructions, if any. The Company's sole responsibility is to its Client and this document does not exonerate parties to a transaction from exercising all their rights and obligations under the transaction documents. This document cannot be reproduced except in full, without prior written approval of the Company. Any unauthorized alteration, forgery or falsification of the content or appearance of this document is unlawful and offenders may be prosecuted to the fullest extent of the law.

WLAN Tx2 Antenna

Antenna	Mode	Position	Distance (mm)	CH	Freq. (MHz)	Max. Rated Avg. Power + Max. Tolerance (dBm)	Measured Avg. Power (dBm)	Duty cycle scaling	Power scaling	Averaged SAR over 1g (W/kg)		Plot page
										Measured	Reported	
Tx2	WLAN 802.11b	Back side	4	1	2412	10.50	10.45	1.01	101.16%	0.175	0.179	-
		Back side	4	6	2437	10.50	10.43	1.01	101.62%	0.187	0.192	566
		Back side	4	11	2462	10.50	10.45	1.01	101.16%	0.177	0.181	-
		Top side	9	11	2462	10.50	10.45	1.01	101.16%	0.026	0.027	-
		Bottom side	0	11	2462	10.50	10.45	1.01	101.16%	0.005	0.006	-
		Right side	0	11	2462	10.50	10.45	1.01	101.16%	0.004	0.004	-
	Bluetooth (GFSK)	Left side	0	11	2462	10.50	10.45	1.01	101.16%	0.007	0.007	-
		Back side	0	39	2441	11.50	10.09	1.30	138.23%	0.048	0.086	567
		Top side	0	39	2441	11.50	10.09	1.30	138.23%	0.033	0.059	-
		Bottom side	0	39	2441	11.50	10.09	1.30	138.23%	0.007	0.013	-
		Right side	0	39	2441	11.50	10.09	1.30	138.23%	0.027	0.049	-
		Left side	0	39	2441	11.50	10.09	1.30	138.23%	0.005	0.010	-
	WLAN 802.11ac(160M) 5.2G	Back side	4	50	5250	9.00	8.87	1.02	103.04%	0.183	0.191	568
		Top side	9	50	5250	9.00	8.87	1.02	103.04%	0.071	0.074	-
		Bottom side	0	50	5250	9.00	8.87	1.02	103.04%	0.023	0.024	-
		Right side	0	50	5250	9.00	8.87	1.02	103.04%	0.097	0.101	-
		Left side	0	50	5250	9.00	8.87	1.02	103.04%	0.015	0.016	-
		Back side	4	58	5290	9.00	8.89	1.01	102.57%	0.173	0.179	569
	WLAN 802.11ac(80M) 5.3G	Top side	9	58	5290	9.00	8.89	1.01	102.57%	0.069	0.071	-
		Bottom side	0	58	5290	9.00	8.89	1.01	102.57%	0.022	0.023	-
		Right side	0	58	5290	9.00	8.89	1.01	102.57%	0.092	0.095	-
		Left side	0	58	5290	9.00	8.89	1.01	102.57%	0.014	0.015	-
		Back side	4	114	5570	9.00	8.89	1.02	102.57%	0.101	0.105	570
		Top side	9	114	5570	9.00	8.89	1.02	102.57%	0.090	0.094	-
	WLAN 802.11ac(160M) 5.6G	Bottom side	0	114	5570	9.00	8.89	1.02	102.57%	0.013	0.014	-
		Right side	0	114	5570	9.00	8.89	1.02	102.57%	0.054	0.056	-
		Left side	0	114	5570	9.00	8.89	1.02	102.57%	0.009	0.009	-
		Back side	4	155	5775	9.00	8.92	1.01	101.86%	0.160	0.165	571
		Top side	9	155	5775	9.00	8.92	1.01	101.86%	0.103	0.106	-
		Bottom side	0	155	5775	9.00	8.92	1.01	101.86%	0.020	0.021	-
	WLAN 802.11ac(80M) 5.8G	Right side	0	155	5775	9.00	8.92	1.01	101.86%	0.085	0.087	-
		Left side	0	155	5775	9.00	8.92	1.01	101.86%	0.013	0.013	-

Unless otherwise stated the results shown in this test report refer only to the sample(s) tested and such sample(s) are retained for 90 days only.

除非另有說明，此報告結果僅對測試之樣品負責，同時此樣品僅保留90天。本報告未經本公司書面許可，不可部份複製。

This document is issued by the Company subject to its General Conditions of Service printed overleaf, available on request or accessible at www.sgs.com/terms_and_conditions.htm and for electronic format documents, subject to Terms and Conditions for Electronic Documents at www.sgs.com/terms_e-document.htm. Attention is drawn to the limitation of liability, indemnification and jurisdiction issues defined therein. Any holder of this document is advised that information contained hereon reflects the Company's findings at the time of its intervention only and within the limits of Client's instructions, if any. The Company's sole responsibility is to its Client and this document does not exonerate parties to a transaction from exercising all their rights and obligations under the transaction documents. This document cannot be reproduced except in full, without prior written approval of the Company. Any unauthorized alteration, forgery or falsification of the content or appearance of this document is unlawful and offenders may be prosecuted to the fullest extent of the law.

Reduced Power with Any Sensors is OFF

WLAN Tx1 Antenna

Antenna	Mode	Position	Distance (mm)	CH	Freq. (MHz)	Max. Rated Avg. Power + Max. Tolerance (dBm)	Measured Avg. Power (dBm)	Duty cycle scaling	Power scaling	Averaged SAR over 1g (W/kg)		Plot page
										Measured	Reported	
Tx1	WLAN 802.11b	Top side	0	1	2412	8.00	7.97	1.01	100.69%	0.061	0.062	572
	WLAN 802.11ac(160M) 5.2G	Top side	0	50	5250	7.00	6.97	1.02	100.69%	0.195	0.199	573
	WLAN 802.11ac(80M) 5.3G	Top side	0	58	5290	7.00	6.97	1.01	100.69%	0.179	0.182	574
	WLAN 802.11ac(160M) 5.6G	Top side	0	114	5570	7.00	6.93	1.02	101.62%	0.219	0.226	575
	WLAN 802.11ac(80M) 5.8G	Top side	0	155	5775	7.00	6.93	1.01	101.62%	0.205	0.210	576

WLAN Tx2 Antenna

Antenna	Mode	Position	Distance (mm)	CH	Freq. (MHz)	Max. Rated Avg. Power + Max. Tolerance (dBm)	Measured Avg. Power (dBm)	Duty cycle scaling	Power scaling	Averaged SAR over 1g (W/kg)		Plot page
										Measured	Reported	
Tx2	WLAN 802.11b	Back side	0	1	2412	8.00	7.95	1.01	101.16%	0.188	0.192	-
		Back side	0	6	2437	8.00	7.94	1.01	101.39%	0.196	0.201	-
		Back side	0	11	2462	8.00	7.96	1.01	100.93%	0.206	0.210	577
		Top side	0	11	2462	8.00	7.96	1.01	100.93%	0.058	0.059	-
	WLAN 802.11ac(160M) 5.2G	Back side	0	50	5250	7.00	6.88	1.02	102.80%	0.235	0.245	578
		Top side	0	50	5250	7.00	6.88	1.02	102.80%	0.135	0.141	-
	WLAN 802.11ac(80M) 5.3G	Back side	0	58	5290	7.00	6.90	1.01	102.33%	0.245	0.253	579
		Top side	0	58	5290	7.00	6.90	1.01	102.33%	0.124	0.128	-
	WLAN 802.11ac(160M) 5.6G	Back side	0	114	5570	7.00	6.90	1.02	102.33%	0.194	0.202	580
		Top side	0	114	5570	7.00	6.90	1.02	102.33%	0.133	0.138	-
	WLAN 802.11ac(80M) 5.8G	Back side	0	155	5775	7.00	6.94	1.01	101.39%	0.221	0.226	581
		Top side	0	155	5775	7.00	6.94	1.01	101.39%	0.155	0.159	-

Unless otherwise stated the results shown in this test report refer only to the sample(s) tested and such sample(s) are retained for 90 days only.

除非另有說明，此報告結果僅對測試之樣品負責，同時此樣品僅保留90天。本報告未經本公司書面許可，不可部份複製。

This document is issued by the Company subject to its General Conditions of Service printed overleaf, available on request or accessible at www.sgs.com/terms_and_conditions.htm and for electronic format documents, subject to Terms and Conditions for Electronic Documents at www.sgs.com/terms_e-document.htm. Attention is drawn to the limitation of liability, indemnification and jurisdiction issues defined therein. Any holder of this document is advised that information contained hereon reflects the Company's findings at the time of its intervention only and within the limits of Client's instructions, if any. The Company's sole responsibility is to its Client and this document does not exonerate parties to a transaction from exercising all their rights and obligations under the transaction documents. This document cannot be reproduced except in full, without prior written approval of the Company. Any unauthorized alteration, forgery or falsification of the content or appearance of this document is unlawful and offenders may be prosecuted to the fullest extent of the law.

**WLAN only
Full power**

WLAN Tx1 Antenna

Antenna	Mode	Position	Distance (mm)	CH	Freq. (MHz)	Max. Rated Avg. Power + Max. Tolerance (dBm)	Measured Avg. Power (dBm)	Duty cycle scaling	Power scaling	Averaged SAR over 1g (W/kg)		Plot page
										Measured	Reported	
Tx1	WLAN 802.11b	Back side	0	1	2412	16.50	16.49	1.01	100.23%	0.871	0.878	582
		Back side*	0	1	2412	16.50	16.49	1.01	100.23%	0.863	0.870	-
		Back side	0	6	2437	16.50	16.48	1.01	100.46%	0.750	0.757	-
		Top side	4	1	2412	16.50	16.49	1.01	100.23%	0.375	0.378	-
		Bottom side	0	1	2412	16.50	16.49	1.01	100.23%	0.006	0.006	-
		Right side	0	1	2412	16.50	16.49	1.01	100.23%	0.034	0.034	-
	WLAN 802.11ac(80M) 5.2G	Left side	0	1	2412	16.50	16.49	1.01	100.23%	0.047	0.047	-
		Back side	0	42	5210	17.50	17.49	1.01	100.23%	0.699	0.708	583
		Top side	4	42	5210	17.50	17.49	1.01	100.23%	0.668	0.676	-
		Bottom side	0	42	5210	17.50	17.49	1.01	100.23%	0.034	0.034	-
		Right side	0	42	5210	17.50	17.49	1.01	100.23%	0.154	0.156	-
		Left side	0	42	5210	17.50	17.49	1.01	100.23%	0.047	0.048	-
	WLAN 802.11ac(80M) 5.3G	Back side	0	58	5290	17.50	17.48	1.01	100.46%	0.739	0.750	584
		Top side	4	58	5290	17.50	17.48	1.01	100.46%	0.706	0.717	-
		Bottom side	0	58	5290	17.50	17.48	1.01	100.46%	0.036	0.037	-
		Right side	0	58	5290	17.50	17.48	1.01	100.46%	0.163	0.165	-
		Left side	0	58	5290	17.50	17.48	1.01	100.46%	0.050	0.051	-
		Back side	0	106	5530	17.50	17.49	1.01	100.23%	0.821	0.831	-
	WLAN 802.11ac(80M) 5.6G	Back side	0	122	5610	17.50	17.47	1.01	100.69%	0.900	0.915	585
		Back side*	0	122	5610	17.50	17.47	1.01	100.69%	0.884	0.899	-
		Back side	0	138	5690	17.50	17.42	1.01	101.86%	0.811	0.835	-
		Top side	4	106	5530	17.50	17.49	1.01	100.23%	0.785	0.795	-
		Bottom side	0	106	5530	17.50	17.49	1.01	100.23%	0.040	0.041	-
		Right side	0	106	5530	17.50	17.49	1.01	100.23%	0.181	0.183	-
		Left side	0	106	5530	17.50	17.49	1.01	100.23%	0.055	0.056	-
		Back side	0	155	5775	16.50	16.49	1.01	100.23%	0.545	0.552	586
	WLAN 802.11ac(80M) 5.8G	Top side	4	155	5775	16.50	16.49	1.01	100.23%	0.526	0.533	-
		Bottom side	0	155	5775	16.50	16.49	1.01	100.23%	0.027	0.027	-
		Right side	0	155	5775	16.50	16.49	1.01	100.23%	0.120	0.122	-
		Left side	0	155	5775	16.50	16.49	1.01	100.23%	0.037	0.037	-

* - repeated at the highest SAR measurement according to the KDB 865664 D01

Unless otherwise stated the results shown in this test report refer only to the sample(s) tested and such sample(s) are retained for 90 days only.

除非另有說明，此報告結果僅對測試之樣品負責，同時此樣品僅保留90天。本報告未經本公司書面許可，不可部份複製。

This document is issued by the Company subject to its General Conditions of Service printed overleaf, available on request or accessible at www.sgs.com/terms_and_conditions.htm and for electronic format documents, subject to Terms and Conditions for Electronic Documents at www.sgs.com/terms_e-document.htm. Attention is drawn to the limitation of liability, indemnification and jurisdiction issues defined therein. Any holder of this document is advised that information contained hereon reflects the Company's findings at the time of its intervention only and within the limits of Client's instructions, if any. The Company's sole responsibility is to its Client and this document does not exonerate parties to a transaction from exercising all their rights and obligations under the transaction documents. This document cannot be reproduced except in full, without prior written approval of the Company. Any unauthorized alteration, forgery or falsification of the content or appearance of this document is unlawful and offenders may be prosecuted to the fullest extent of the law.

WLAN Tx2 Antenna

Antenna	Mode	Position	Distance (mm)	CH	Freq. (MHz)	Max. Rated Avg. Power + Max. Tolerance (dBm)	Measured Avg. Power (dBm)	Duty cycle scaling	Power scaling	Averaged SAR over 1g (W/kg)		Plot page
										Measured	Reported	
Tx2	WLAN 802.11b	Back side	4	1	2412	19.00	18.97	1.01	100.69%	0.942	0.953	-
		Back side	4	6	2437	19.00	18.91	1.01	102.09%	0.885	0.908	-
		Back side	4	10	2457	19.00	18.99	1.01	100.23%	1.120	1.128	587
		Back side*	4	10	2457	19.00	18.99	1.01	100.23%	1.050	1.058	-
		Top side	9	10	2457	19.00	18.99	1.01	100.23%	0.110	0.111	-
		Bottom side	0	10	2457	19.00	18.99	1.01	100.23%	0.005	0.005	-
		Right side	0	10	2457	19.00	18.99	1.01	100.23%	0.127	0.128	-
		Left side	0	10	2457	19.00	18.99	1.01	100.23%	0.056	0.056	-
	WLAN 802.11n(40M) 5.2G	Back side	4	46	5230	19.00	18.93	1.01	101.62%	0.671	0.690	588
		Top side	9	46	5230	19.00	18.93	1.01	101.62%	0.147	0.151	-
		Bottom side	0	46	5230	19.00	18.93	1.01	101.62%	0.028	0.029	-
		Right side	0	46	5230	19.00	18.93	1.01	101.62%	0.228	0.234	-
		Left side	0	46	5230	19.00	18.93	1.01	101.62%	0.009	0.010	-
	WLAN 802.11ac(80M) 5.2G	Back side	4	42	5210	19.00	18.62	1.01	109.14%	0.887	0.978	589
		Back side*	4	42	5210	19.00	18.62	1.01	109.14%	0.864	0.953	-
		Top side	9	42	5210	19.00	18.62	1.01	109.14%	0.194	0.214	-
		Bottom side	0	42	5210	19.00	18.62	1.01	109.14%	0.037	0.041	-
		Right side	0	42	5210	19.00	18.62	1.01	109.14%	0.301	0.332	-
	WLAN 802.11n(40M) 5.3G	Left side	0	42	5210	19.00	18.62	1.01	109.14%	0.013	0.014	-
		Back side	4	54	5270	19.00	18.92	1.01	101.86%	1.100	1.133	590
		Back side*	4	54	5270	19.00	18.92	1.01	101.86%	1.010	1.041	-
		Back side	4	62	5310	18.00	17.73	1.01	106.41%	0.890	0.958	-
		Top side	9	54	5270	19.00	18.92	1.01	101.86%	0.232	0.239	-
		Bottom side	0	54	5270	19.00	18.92	1.01	101.86%	0.079	0.081	-
		Right side	0	54	5270	19.00	18.92	1.01	101.86%	0.129	0.133	-
	WLAN 802.11ac(80M) 5.6G	Left side	0	54	5270	19.00	18.92	1.01	101.86%	0.019	0.020	-
		Back side	4	106	5530	19.00	18.83	1.01	103.99%	1.010	1.061	-
		Back side	4	122	5610	19.00	18.97	1.01	100.69%	1.020	1.038	-
		Back side	4	138	5690	19.00	18.99	1.01	100.23%	1.090	1.104	591
		Back side*	4	138	5690	19.00	18.99	1.01	100.23%	1.040	1.053	-
		Top side	9	138	5690	19.00	18.99	1.01	100.23%	0.347	0.351	-
		Bottom side	0	138	5690	19.00	18.99	1.01	100.23%	0.045	0.046	-
	WLAN 802.11n(40M) 5.8G	Right side	0	138	5690	19.00	18.99	1.01	100.23%	0.371	0.376	-
		Left side	0	138	5690	19.00	18.99	1.01	100.23%	0.015	0.015	-
		Back side	4	151	5755	19.00	18.94	1.01	101.39%	0.945	0.969	-
		Back side	4	159	5795	19.00	18.91	1.01	102.09%	0.969	1.001	592
		Back side*	4	159	5795	19.00	18.91	1.01	102.09%	0.955	0.986	-
		Top side	9	151	5755	19.00	18.94	1.01	101.39%	0.417	0.428	-
	WLAN 802.11ac(80M) 5.8G	Bottom side	0	151	5755	19.00	18.94	1.01	101.39%	0.039	0.040	-
		Right side	0	151	5755	19.00	18.94	1.01	101.39%	0.322	0.330	-
		Left side	0	151	5755	19.00	18.94	1.01	101.39%	0.013	0.013	-
		Back side	4	155	5775	19.00	18.90	1.01	102.33%	0.983	1.016	593
		Back side*	4	155	5775	19.00	18.90	1.01	102.33%	0.962	0.994	-
		Top side	9	155	5775	19.00	18.90	1.01	102.33%	0.215	0.222	-
		Bottom side	0	155	5775	19.00	18.90	1.01	102.33%	0.041	0.042	-
		Right side	0	155	5775	19.00	18.90	1.01	102.33%	0.334	0.345	-
	Left side	0	155	5775	19.00	18.90	1.01	102.33%	0.014	0.014	-	

* - repeated at the highest SAR measurement according to the KDB 865664 D01

Unless otherwise stated the results shown in this test report refer only to the sample(s) tested and such sample(s) are retained for 90 days only.

除非另有說明，此報告結果僅對測試之樣品負責，同時此樣品僅保留90天。本報告未經本公司書面許可，不可部份複製。

This document is issued by the Company subject to its General Conditions of Service printed overleaf, available on request or accessible at www.sgs.com/terms_and_conditions.htm and for electronic format documents, subject to Terms and Conditions for Electronic Documents at www.sgs.com/terms_e-document.htm. Attention is drawn to the limitation of liability, indemnification and jurisdiction issues defined therein. Any holder of this document is advised that information contained hereon reflects the Company's findings at the time of its intervention only and within the limits of Client's instructions, if any. The Company's sole responsibility is to its Client and this document does not exonerate parties to a transaction from exercising all their rights and obligations under the transaction documents. This document cannot be reproduced except in full, without prior written approval of the Company. Any unauthorized alteration, forgery or falsification of the content or appearance of this document is unlawful and offenders may be prosecuted to the fullest extent of the law.

Reduced power

WLAN Tx1 Antenna

Antenna	Mode	Position	Distance (mm)	CH	Freq. (MHz)	Max. Rated Avg. Power + Max. Tolerance (dBm)	Measured Avg. Power (dBm)	Duty cycle scaling	power scaling	Averaged SAR over 1g (W/kg)		Plot page
										Measured	Reported	
Tx1	WLAN 802.11b	Top side	0	1	2412	16.50	16.49	1.01	100.23%	1.070	1.078	594
		Top side*	0	1	2412	16.50	16.49	1.01	100.23%	1.030	1.038	-
		Top side	0	6	2437	16.50	16.48	1.01	100.46%	0.985	0.995	-
		Top side	0	11	2462	16.50	16.44	1.01	101.39%	0.929	0.947	-
	WLAN 802.11ac(160M) 5.2G	Top side	0	50	5250	14.00	13.93	1.02	101.62%	0.756	0.780	595
	WLAN 802.11ac(80M) 5.3G	Top side	0	58	5290	14.00	13.98	1.01	100.46%	0.758	0.789	596
	WLAN 802.11ac(80M) 5.6G	Top side	0	122	5610	14.00	13.99	1.01	100.23%	0.825	0.835	-
		Top side	0	138	5690	14.00	13.97	1.01	100.69%	0.841	0.855	597
		Top side*	0	138	5690	14.00	13.97	1.01	100.69%	0.835	0.849	-
	WLAN 802.11ac(160M) 5.6G	Top side	0	114	5570	14.00	13.98	1.02	100.46%	0.878	0.896	598
		Top side*	0	114	5570	14.00	13.98	1.02	100.46%	0.866	0.883	-
	WLAN 802.11ac(80M) 5.8G	Top side	0	155	5775	14.00	13.99	1.01	100.23%	0.786	0.796	599

* - repeated at the highest SAR measurement according to the KDB 865664 D01

Unless otherwise stated the results shown in this test report refer only to the sample(s) tested and such sample(s) are retained for 90 days only.

除非另有說明，此報告結果僅對測試之樣品負責，同時此樣品僅保留90天。本報告未經本公司書面許可，不可部份複製。

This document is issued by the Company subject to its General Conditions of Service printed overleaf, available on request or accessible at www.sgs.com/terms_and_conditions.htm and for electronic format documents, subject to Terms and Conditions for Electronic Documents at www.sgs.com/terms_e-document.htm. Attention is drawn to the limitation of liability, indemnification and jurisdiction issues defined therein. Any holder of this document is advised that information contained hereon reflects the Company's findings at the time of its intervention only and within the limits of Client's instructions, if any. The Company's sole responsibility is to its Client and this document does not exonerate parties to a transaction from exercising all their rights and obligations under the transaction documents. This document cannot be reproduced except in full, without prior written approval of the Company. Any unauthorized alteration, forgery or falsification of the content or appearance of this document is unlawful and offenders may be prosecuted to the fullest extent of the law.

WLAN Tx2 Antenna

Antenna	Mode	Position	Distance (mm)	CH	Freq. (MHz)	Max. Rated Avg. Power + Max. Tolerance (dBm)	Measured Avg. Power (dBm)	Duty cycle scaling	power scaling	Averaged SAR over 1g (W/kg)		Plot page
										Measured	Reported	
Tx2	WLAN 802.11b	Back side	0	1	2412	14.50	14.41	1.01	102.09%	0.708	0.727	-
		Back side	0	6	2437	14.50	14.44	1.01	101.39%	0.709	0.723	-
		Back side	0	11	2462	14.50	14.48	1.01	100.46%	0.886	0.895	600
		Back side*	0	11	2462	14.50	14.48	1.01	100.46%	0.874	0.883	-
		Top side	0	11	2462	14.50	14.48	1.01	100.46%	0.203	0.205	-
	WLAN 802.11ac(160M) 5.2G	Back side	0	50	5250	14.00	13.93	1.02	101.62%	0.755	0.779	601
		Top side	0	50	5250	14.00	13.93	1.02	101.62%	0.495	0.511	-
	WLAN 802.11n(40M) 5.3G	Back side	0	54	5270	14.00	13.97	1.01	100.69%	0.820	0.835	-
		Back side	0	62	5310	14.00	13.99	1.01	100.23%	0.928	0.941	602
		Back side*	0	62	5310	14.00	13.99	1.01	100.23%	0.909	0.922	-
		Top side	0	62	5310	14.00	13.99	1.01	100.23%	0.514	0.521	-
	WLAN 802.11ac(80M) 5.3G	Back side	0	58	5290	14.00	13.96	1.01	100.93%	0.819	0.835	603
		Back side*	0	58	5290	14.00	13.96	1.01	100.93%	0.809	0.825	-
		Top side	0	58	5290	14.00	13.96	1.01	100.93%	0.454	0.463	-
	WLAN 802.11ac(80M) 5.6G	Back side	0	106	5530	14.00	13.93	1.01	101.62%	0.918	0.942	-
		Back side	0	122	5610	14.00	13.96	1.01	100.93%	0.953	0.972	604
		Back side*	0	122	5610	14.00	13.96	1.01	100.93%	0.951	0.970	-
		Back side	0	138	5690	14.00	13.95	1.01	101.16%	0.939	0.960	-
		Top side	0	122	5610	14.00	13.96	1.01	100.93%	0.528	0.538	-
	WLAN 802.11ac(160M) 5.6G	Back side	0	114	5570	14.00	13.96	1.02	100.93%	0.921	0.944	605
		Back side*	0	114	5570	14.00	13.96	1.02	100.93%	0.903	0.925	-
		Top side	0	114	5570	14.00	13.96	1.02	100.93%	0.529	0.542	-
	WLAN 802.11ac(80M) 5.8G	Back side	0	155	5775	14.00	13.95	1.01	101.16%	0.730	0.746	606
		Top side	0	155	5775	14.00	13.95	1.01	101.16%	0.527	0.539	-

* - repeated at the highest SAR measurement according to the KDB 865664 D01

Note:

$$\text{Scaling} = \frac{\text{reported SAR}}{\text{measured SAR}} = \frac{P2(\text{mW})}{P1(\text{mW})} = 10^{\left(\frac{P2-P1}{10}\right)}(\text{dBm})$$

$$\text{Reported SAR} = \text{measured SAR} * (\text{scaling})$$

Where P2 is maximum specified power, P1 is measured conducted power

2.3 Reporting statements of conformity

The conformity statement in this report is based solely on the test results, measurement uncertainty is excluded.

Unless otherwise stated the results shown in this test report refer only to the sample(s) tested and such sample(s) are retained for 90 days only.

除非另有說明，此報告結果僅對測試之樣品負責，同時此樣品僅保留90天。本報告未經本公司書面許可，不可部份複製。

This document is issued by the Company subject to its General Conditions of Service printed overleaf, available on request or accessible at www.sgs.com/terms_and_conditions.htm and for electronic format documents, subject to Terms and Conditions for Electronic Documents at www.sgs.com/terms_e-document.htm. Attention is drawn to the limitation of liability, indemnification and jurisdiction issues defined therein. Any holder of this document is advised that information contained hereon reflects the Company's findings at the time of its intervention only and within the limits of Client's instructions, if any. The Company's sole responsibility is to its Client and this document does not exonerate parties to a transaction from exercising all their rights and obligations under the transaction documents. This document cannot be reproduced except in full, without prior written approval of the Company. Any unauthorized alteration, forgery or falsification of the content or appearance of this document is unlawful and offenders may be prosecuted to the fullest extent of the law.

3. Simultaneous Transmission Analysis

Simultaneous Transmission Scenarios:

WLAN only

Simultaneous Transmit Configurations	TX1 power	TX2 power
2.4GHz WLAN TX1 + 2.4GHz WLAN TX2	Full-1	Full-1
2.4GHz WLAN TX1 + 2.4GHz WLAN TX2	Reduce-1	Reduce-1
5GHz WLAN TX1 + 5GHz WLAN TX2	Full-1	Full-1
5GHz WLAN TX1 + 5GHz WLAN TX2	Reduce-1	Reduce-1
2.4GHz WLAN TX1 + BT	Full-1	Full
2.4GHz WLAN TX1 + BT	Reduce-1	Full
5GHz WLAN TX1 + BT	Full-1	Full
5GHz WLAN TX1 + BT	Reduce-1	Full

Simultaneous Transmit Configurations	TX1 power	TX2 power	BT power
5GHz WLAN TX1 + 5GHz WLAN TX2 + BT	Full-1	Full-1	Full
5GHz WLAN TX1 + 5GHz WLAN TX2 + BT	Reduce-1	Reduce-1	Full

Unless otherwise stated the results shown in this test report refer only to the sample(s) tested and such sample(s) are retained for 90 days only.

除非另有說明，此報告結果僅對測試之樣品負責，同時此樣品僅保留90天。本報告未經本公司書面許可，不可部份複製。

This document is issued by the Company subject to its General Conditions of Service printed overleaf, available on request or accessible at www.sgs.com/terms_and_conditions.htm and for electronic format documents, subject to Terms and Conditions for Electronic Documents at www.sgs.com/terms_e-document.htm. Attention is drawn to the limitation of liability, indemnification and jurisdiction issues defined therein. Any holder of this document is advised that information contained hereon reflects the Company's findings at the time of its intervention only and within the limits of Client's instructions, if any. The Company's sole responsibility is to its Client and this document does not exonerate parties to a transaction from exercising all their rights and obligations under the transaction documents. This document cannot be reproduced except in full, without prior written approval of the Company. Any unauthorized alteration, forgery or falsification of the content or appearance of this document is unlawful and offenders may be prosecuted to the fullest extent of the law.

WWAN + WLAN

Simultaneous Transmit Configurations	WWAN power	TX1 power	TX2 power	
WWAN + 2.4GHz WLAN TX1 + 2.4GHz WLAN TX2	Full	Full-2	Full-2	
WWAN + 2.4GHz WLAN TX1 + 2.4GHz WLAN TX2	Full	Reduce-2	Reduce-2	
WWAN + 2.4GHz WLAN TX1 + 2.4GHz WLAN TX2	Reduced	Full-2	Full-2	
WWAN + 2.4GHz WLAN TX1 + 2.4GHz WLAN TX2	Reduced	Reduce-2	Reduce-2	
WWAN + 5GHz WLAN TX1 + 5GHz WLAN TX2	Full	Full-2	Full-2	
WWAN + 5GHz WLAN TX1 + 5GHz WLAN TX2	Full	Reduce-2	Reduce-2	
WWAN + 5GHz WLAN TX1 + 5GHz WLAN TX2	Reduced	Full-2	Full-2	
WWAN + 5GHz WLAN TX1 + 5GHz WLAN TX2	Reduced	Reduce-2	Reduce-2	
WWAN + 2.4GHz WLAN TX1 + BT	Full	Full-2	Full	
WWAN + 2.4GHz WLAN TX1 + BT	Full	Reduce-2	Full	
WWAN + 2.4GHz WLAN TX1 + BT	Reduced	Full-2	Full	
WWAN + 2.4GHz WLAN TX1 + BT	Reduced	Reduce-2	Full	
WWAN + 5GHz WLAN TX1 + BT	Full	Full-2	Full	
WWAN + 5GHz WLAN TX1 + BT	Full	Reduce-2	Full	
WWAN + 5GHz WLAN TX1 + BT	Reduced	Full-2	Full	
WWAN + 5GHz WLAN TX1 + BT	Reduced	Reduce-2	Full	
Simultaneous Transmit Configurations	WWAN power	TX1 power	TX2 power	BT power
WWAN + 5GHz WLAN TX1 + 5GHz WLAN T2 + BT	Full	Full-2	Full-2	Full
WWAN + 5GHz WLAN TX1 + 5GHz WLAN T2 + BT	Full	Reduce-2	Reduce-2	Full
WWAN + 5GHz WLAN TX1 + 5GHz WLAN T2 + BT	Reduced	Full-2	Full-2	Full
WWAN + 5GHz WLAN TX1 + 5GHz WLAN T2 + BT	Reduced	Reduce-2	Reduce-2	Full

Unless otherwise stated the results shown in this test report refer only to the sample(s) tested and such sample(s) are retained for 90 days only.

除非另有說明，此報告結果僅對測試之樣品負責，同時此樣品僅保留90天。本報告未經本公司書面許可，不可部份複製。

This document is issued by the Company subject to its General Conditions of Service printed overleaf, available on request or accessible at www.sgs.com/terms_and_conditions.htm and for electronic format documents, subject to Terms and Conditions for Electronic Documents at www.sgs.com/terms_e-document.htm. Attention is drawn to the limitation of liability, indemnification and jurisdiction issues defined therein. Any holder of this document is advised that information contained hereon reflects the Company's findings at the time of its intervention only and within the limits of Client's instructions, if any. The Company's sole responsibility is to its Client and this document does not exonerate parties to a transaction from exercising all their rights and obligations under the transaction documents. This document cannot be reproduced except in full, without prior written approval of the Company. Any unauthorized alteration, forgery or falsification of the content or appearance of this document is unlawful and offenders may be prosecuted to the fullest extent of the law.

3.1 Estimated SAR calculation

According to KDB447498 D01v06 – When standalone SAR test exclusion applies to an antenna that transmits simultaneously with other antennas, the standalone SAR must be estimated according to following to determine simultaneous transmission SAR test exclusion:

$$\text{Estimated SAR} = \frac{\text{Max. tune up power (mW)}}{\text{Min. test separation distance(mm)}} \times \frac{\sqrt{f(\text{GHz})}}{7.5}$$

If the minimum test separation distance is < 5mm, a distance of 5mm is used for estimated SAR calculation. When the test separation distance is >50mm, the 0.4W/kg is used for SAR-1g.

3.2 SPLSR evaluation and analysis

Per KDB447498D01, when the sum of SAR is larger than the limit, SAR test exclusion is determined by the SAR sum to peak location separation ratio(SPLSR).

The simultaneous transmitting antennas in each operating mode and exposure condition combination must be considered one pair at a time to determine the SAR to peak location separation ratio to qualify for test exclusion.

The ratio is determined by $(\text{SAR1} + \text{SAR2})^{1.5}/R_i$, rounded to two decimal digits, and must be ≤ 0.04 for all antenna pairs in the configuration to qualify for 1-g SAR test exclusion.

SAR1 and SAR2 are the highest reported or estimated SAR for each antenna in the pair, and R_i is the separation distance between the peak SAR locations for the antenna pair in mm.

When standalone test exclusion applies, SAR is estimated; the peak location is assumed to be at the feed-point or geometric center of the antenna.

Unless otherwise stated the results shown in this test report refer only to the sample(s) tested and such sample(s) are retained for 90 days only.

除非另有說明，此報告結果僅對測試之樣品負責，同時此樣品僅保留90天。本報告未經本公司書面許可，不可部份複製。

This document is issued by the Company subject to its General Conditions of Service printed overleaf, available on request or accessible at www.sgs.com/terms_and_conditions.htm and for electronic format documents, subject to Terms and Conditions for Electronic Documents at www.sgs.com/terms_e-document.htm. Attention is drawn to the limitation of liability, indemnification and jurisdiction issues defined therein. Any holder of this document is advised that information contained hereon reflects the Company's findings at the time of its intervention only and within the limits of Client's instructions, if any. The Company's sole responsibility is to its Client and this document does not exonerate parties to a transaction from exercising all their rights and obligations under the transaction documents. This document cannot be reproduced except in full, without prior written approval of the Company. Any unauthorized alteration, forgery or falsification of the content or appearance of this document is unlawful and offenders may be prosecuted to the fullest extent of the law.

WLAN only

2.4GHz WLAN TX1 Full + 2.4GHz WLAN TX2 Full

No.	Conditions	Position	Max. WLAN Tx1	Max. WLAN Tx2	SAR Sum	SPLSR
1	2.4 GHz WLAN Tx1 + WLAN Tx2	Back side	0.878	1.128	2.006	Analyzed as below
		Top side	0.378	0.111	0.489	Σ SAR<1.6, Not required
		Bottom side	0.006	0.005	0.011	Σ SAR<1.6, Not required
		Right side	0.034	0.128	0.162	Σ SAR<1.6, Not required
		Left side	0.047	0.056	0.103	Σ SAR<1.6, Not required

2.4 GHz WLAN MIMO

Conditions	Position	SAR Value (W/kg)	Coordinates (cm)			Σ SAR (W/kg)	Peak Location Separation Distance (mm)	SPLSR	Simultaneous Transmission SAR Test
			x	y	z				
WLAN Tx1	Back side	0.878	76.20	-33.60	-3.51	2.006	125.67	0.023	SPLSR<0.04, Not required
WLAN Tx2		1.128	72.00	92.00	-3.49				



Unless otherwise stated the results shown in this test report refer only to the sample(s) tested and such sample(s) are retained for 90 days only.

除非另有說明，此報告結果僅對測試之樣品負責，同時此樣品僅保留90天。本報告未經本公司書面許可，不可部份複製。

This document is issued by the Company subject to its General Conditions of Service printed overleaf, available on request or accessible at www.sgs.com/terms_and_conditions.htm and for electronic format documents, subject to Terms and Conditions for Electronic Documents at www.sgs.com/terms_e-document.htm. Attention is drawn to the limitation of liability, indemnification and jurisdiction issues defined therein. Any holder of this document is advised that information contained hereon reflects the Company's findings at the time of its intervention only and within the limits of Client's instructions, if any. The Company's sole responsibility is to its Client and this document does not exonerate parties to a transaction from exercising all their rights and obligations under the transaction documents. This document cannot be reproduced except in full, without prior written approval of the Company. Any unauthorized alteration, forgery or falsification of the content or appearance of this document is unlawful and offenders may be prosecuted to the fullest extent of the law.

5GHz WLAN TX1 Full + 5GHz WLAN TX2 Full

No.	Conditions	Position	Max. WLAN Tx1	Max. WLAN Tx2	SAR Sum	SPLSR
2	5 GHz WLAN Tx1 + WLAN Tx2	Back side	0.915	1.133	2.048	Analyzed as below
		Top side	0.795	0.428	1.223	Σ SAR<1.6, Not required
		Bottom side	0.041	0.081	0.122	Σ SAR<1.6, Not required
		Right side	0.183	0.376	0.559	Σ SAR<1.6, Not required
		Left side	0.056	0.020	0.076	Σ SAR<1.6, Not required

5 GHz WLAN MIMO

Conditions	Position	SAR Value (W/kg)	Coordinates (cm)			Σ SAR (W/kg)	Peak Location Separation Distance (mm)	SPLSR	Simultaneous Transmission SAR Test
			x	y	z				
WLAN Tx1	Back side	0.915	70.20	-30.20	-2.91	2.048	121.96	0.024	SPLSR<0.04, Not required
WLAN Tx2		1.133	83.80	91.00	-3.14				

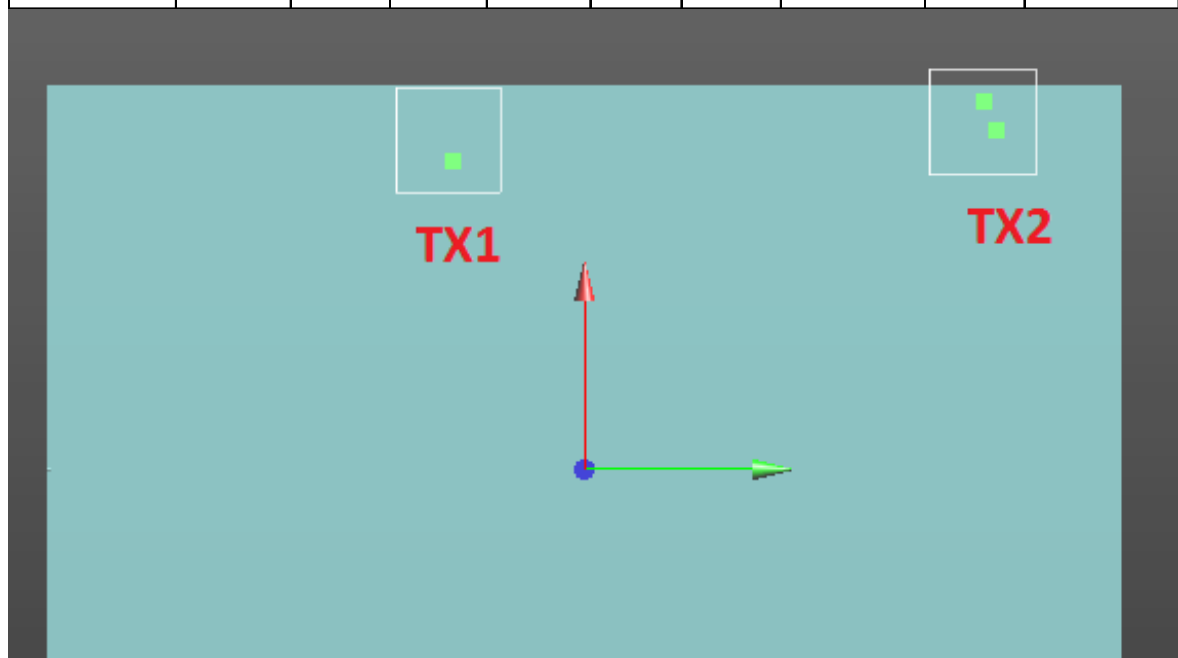

Unless otherwise stated the results shown in this test report refer only to the sample(s) tested and such sample(s) are retained for 90 days only.

除非另有說明，此報告結果僅對測試之樣品負責，同時此樣品僅保留90天。本報告未經本公司書面許可，不可部份複製。

This document is issued by the Company subject to its General Conditions of Service printed overleaf, available on request or accessible at www.sgs.com/terms_and_conditions.htm and for electronic format documents, subject to Terms and Conditions for Electronic Documents at www.sgs.com/terms_e-document.htm. Attention is drawn to the limitation of liability, indemnification and jurisdiction issues defined therein. Any holder of this document is advised that information contained hereon reflects the Company's findings at the time of its intervention only and within the limits of Client's instructions, if any. The Company's sole responsibility is to its Client and this document does not exonerate parties to a transaction from exercising all their rights and obligations under the transaction documents. This document cannot be reproduced except in full, without prior written approval of the Company. Any unauthorized alteration, forgery or falsification of the content or appearance of this document is unlawful and offenders may be prosecuted to the fullest extent of the law.

2.4GHz WLAN TX1 Full + BT Full

No.	Conditions	Position	Max. WLAN Tx1	BT	SAR Sum	SPLSR
3	2.4 GHz WLAN Tx1 + BT	Back side	0.878	0.086	0.964	Σ SAR<1.6, Not required
		Top side	0.378	0.059	0.437	Σ SAR<1.6, Not required
		Bottom side	0.006	0.013	0.019	Σ SAR<1.6, Not required
		Right side	0.034	0.049	0.083	Σ SAR<1.6, Not required
		Left side	0.047	0.010	0.057	Σ SAR<1.6, Not required

5GHz WLAN TX1 Full + BT Full

No.	Conditions	Position	Max. WLAN Tx1	BT	SAR Sum	SPLSR
4	5 GHz WLAN Tx1 + BT	Back side	0.915	0.086	1.001	Σ SAR<1.6, Not required
		Top side	0.795	0.059	0.854	Σ SAR<1.6, Not required
		Bottom side	0.041	0.013	0.054	Σ SAR<1.6, Not required
		Right side	0.183	0.049	0.232	Σ SAR<1.6, Not required
		Left side	0.056	0.010	0.066	Σ SAR<1.6, Not required

Unless otherwise stated the results shown in this test report refer only to the sample(s) tested and such sample(s) are retained for 90 days only.

除非另有說明，此報告結果僅對測試之樣品負責，同時此樣品僅保留90天。本報告未經本公司書面許可，不可部份複製。

This document is issued by the Company subject to its General Conditions of Service printed overleaf, available on request or accessible at www.sgs.com/terms_and_conditions.htm and for electronic format documents, subject to Terms and Conditions for Electronic Documents at www.sgs.com/terms_e-document.htm. Attention is drawn to the limitation of liability, indemnification and jurisdiction issues defined therein. Any holder of this document is advised that information contained hereon reflects the Company's findings at the time of its intervention only and within the limits of Client's instructions, if any. The Company's sole responsibility is to its Client and this document does not exonerate parties to a transaction from exercising all their rights and obligations under the transaction documents. This document cannot be reproduced except in full, without prior written approval of the Company. Any unauthorized alteration, forgery or falsification of the content or appearance of this document is unlawful and offenders may be prosecuted to the fullest extent of the law.

5GHZ WLAN TX1 Full + 5GHZ WLAN TX2 Full + BT

No.	Conditions	Position	Max. WLAN Tx1	Max. WLAN Tx2	BT	SAR Sum	SPLSR
5	5 GHz WLAN Tx1 + WLAN Tx2 +BT	Back side	0.915	1.133	0.086	2.134	Analyzed as below
		Top side	0.795	0.428	0.059	1.282	Σ SAR<1.6, Not required
		Bottom side	0.041	0.081	0.013	0.135	Σ SAR<1.6, Not required
		Right side	0.183	0.376	0.049	0.608	Σ SAR<1.6, Not required
		Left side	0.056	0.020	0.010	0.086	Σ SAR<1.6, Not required

5 GHz WLAN Tx1 + 5 GHz WLAN Tx2 + BT

Conditions	Position	SAR Value (W/kg)	Coordinates (cm)			Σ SAR (W/kg)	Peak Location Separation Distance (mm)	SPLSR	Simultaneous Transmission SAR Test
			x	y	z				
WLAN Tx1	Back side	0.915	70.20	-30.20	-2.91	2.134	121.79	0.026	SPLSR<0.04, Not required
WLAN Tx2 + BT		1.219	77.00	91.40	-3.69				

*For peak SAR location of WLAN Tx2 + BT, using the peak SAR location with smallest separation distance between WLAN TX1 - WLAN TX2 pair and WLAN TX1 - BT pair to be the worst case condition.

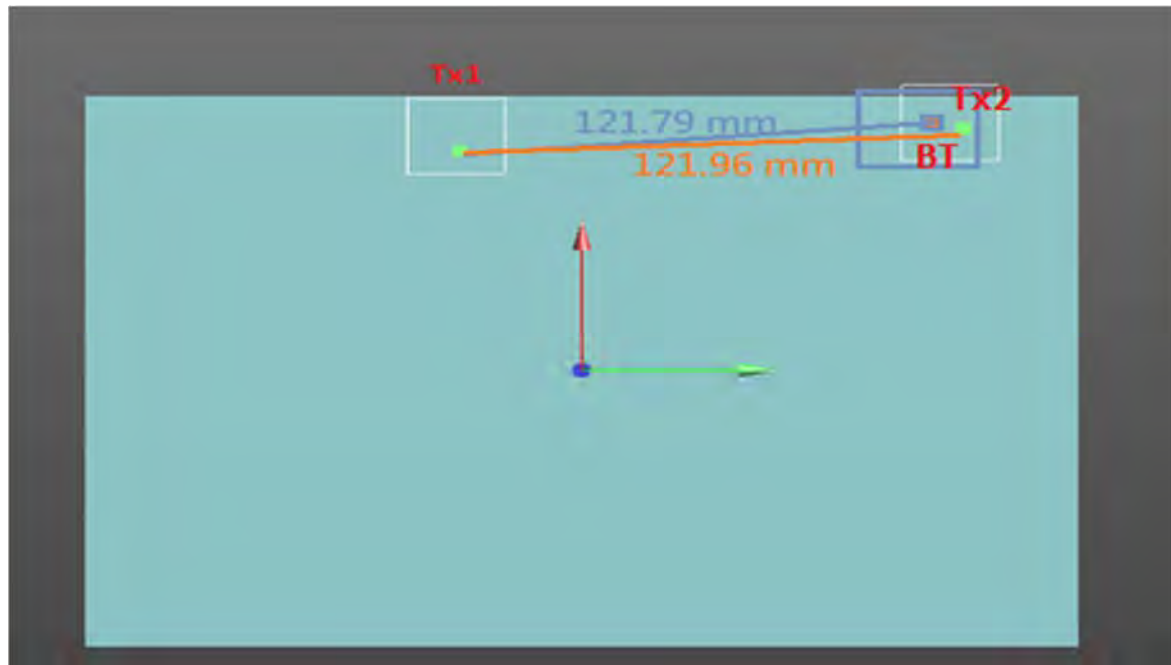

Unless otherwise stated the results shown in this test report refer only to the sample(s) tested and such sample(s) are retained for 90 days only.

除非另有說明，此報告結果僅對測試之樣品負責，同時此樣品僅保留90天。本報告未經本公司書面許可，不可部份複製。

This document is issued by the Company subject to its General Conditions of Service printed overleaf, available on request or accessible at www.sgs.com/terms_and_conditions.htm and for electronic format documents, subject to Terms and Conditions for Electronic Documents at www.sgs.com/terms_e-document.htm. Attention is drawn to the limitation of liability, indemnification and jurisdiction issues defined therein. Any holder of this document is advised that information contained hereon reflects the Company's findings at the time of its intervention only and within the limits of Client's instructions, if any. The Company's sole responsibility is to its Client and this document does not exonerate parties to a transaction from exercising all their rights and obligations under the transaction documents. This document cannot be reproduced except in full, without prior written approval of the Company. Any unauthorized alteration, forgery or falsification of the content or appearance of this document is unlawful and offenders may be prosecuted to the fullest extent of the law.

2.4GHz WLAN TX1 Reduced + 2.4GHz WLAN TX2 Reduced

No.	Conditions	Position	Max. WLAN Tx1 *	Max. WLAN Tx2	SAR Sum	SPLSR
6	2.4 GHz WLAN Tx1 + WLAN Tx2	Back side	0.878	0.895	1.773	Analyzed as below
		Top side	1.078	0.205	1.283	Σ SAR<1.6, Not required

*Using WLAN TX1 back side full power SAR value to evaluate the simultaneous SAR to be the conservative evaluation.

2.4 GHz WLAN MIMO

Conditions	Position	SAR Value (W/kg)	Coordinates (cm)			Σ SAR (W/kg)	Peak Location Separation Distance (mm)	SPLSR	Simultaneous Transmission SAR Test
			x	y	z				
WLAN Tx1	Back side	0.878	76.20	-33.60	-3.51	1.773	124.75	0.019	SPLSR<0.04, Not required
WLAN Tx2		0.895	70.00	91.00	3.14				

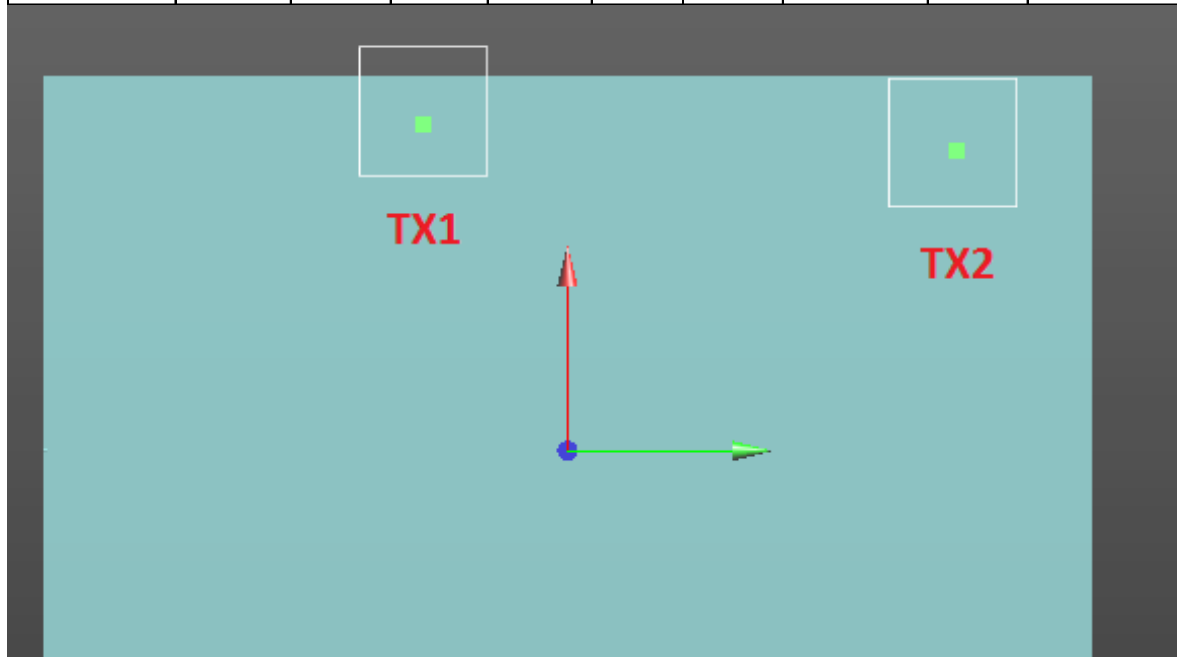

Unless otherwise stated the results shown in this test report refer only to the sample(s) tested and such sample(s) are retained for 90 days only.

除非另有說明，此報告結果僅對測試之樣品負責，同時此樣品僅保留90天。本報告未經本公司書面許可，不可部份複製。

This document is issued by the Company subject to its General Conditions of Service printed overleaf, available on request or accessible at www.sgs.com/terms_and_conditions.htm and for electronic format documents, subject to Terms and Conditions for Electronic Documents at www.sgs.com/terms_e-document.htm. Attention is drawn to the limitation of liability, indemnification and jurisdiction issues defined therein. Any holder of this document is advised that information contained hereon reflects the Company's findings at the time of its intervention only and within the limits of Client's instructions, if any. The Company's sole responsibility is to its Client and this document does not exonerate parties to a transaction from exercising all their rights and obligations under the transaction documents. This document cannot be reproduced except in full, without prior written approval of the Company. Any unauthorized alteration, forgery or falsification of the content or appearance of this document is unlawful and offenders may be prosecuted to the fullest extent of the law.

5GHz WLAN TX1 Reduced + 5GHz WLAN TX2 Reduced

No.	Conditions	Position	Max. WLAN Tx1 *	Max. WLAN Tx2	SAR Sum	SPLSR
7	5 GHz WLAN Tx1 + WLAN Tx2	Back side	0.915	0.972	1.887	Analyzed ax below
		Top side	0.896	0.542	1.438	Σ SAR<1.6, Not required

*Using WLAN TX1 back side full power SAR value to evaluate the simultaneous SAR to be the conservative evaluation.

5GHz WLAN MIMO

Conditions	Position	SAR Value (W/kg)	Coordinates (cm)			Σ SAR (W/kg)	Peak Location Separation Distance (mm)	SPLSR	Simultaneous Transmission SAR Test
			x	y	z				
WLAN Tx1	Back side	0.915	70.20	-30.20	-2.91	1.887	126.81	0.020	SPLSR<0.04, Not required
WLAN Tx2		0.972	82.60	96.00	-1.97				

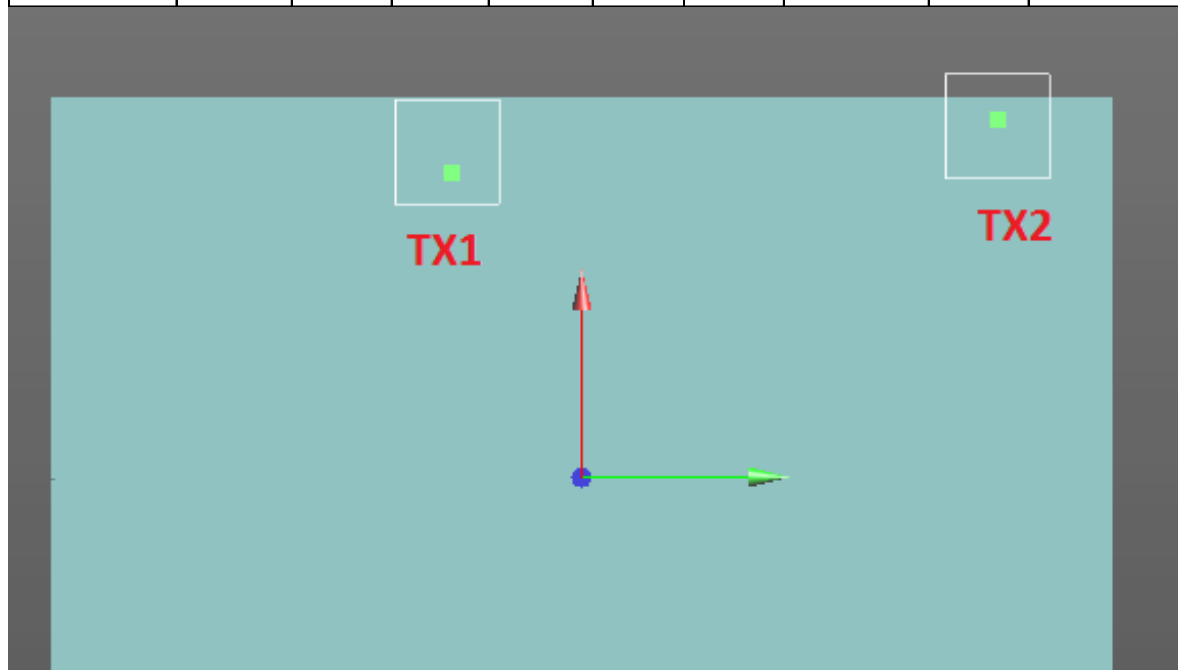

Unless otherwise stated the results shown in this test report refer only to the sample(s) tested and such sample(s) are retained for 90 days only.

除非另有說明，此報告結果僅對測試之樣品負責，同時此樣品僅保留90天。本報告未經本公司書面許可，不可部份複製。

This document is issued by the Company subject to its General Conditions of Service printed overleaf, available on request or accessible at www.sgs.com/terms_and_conditions.htm and for electronic format documents, subject to Terms and Conditions for Electronic Documents at www.sgs.com/terms_e-document.htm. Attention is drawn to the limitation of liability, indemnification and jurisdiction issues defined therein. Any holder of this document is advised that information contained hereon reflects the Company's findings at the time of its intervention only and within the limits of Client's instructions, if any. The Company's sole responsibility is to its Client and this document does not exonerate parties to a transaction from exercising all their rights and obligations under the transaction documents. This document cannot be reproduced except in full, without prior written approval of the Company. Any unauthorized alteration, forgery or falsification of the content or appearance of this document is unlawful and offenders may be prosecuted to the fullest extent of the law.

2.4GHz WLAN TX1 Reduced + BT Full

No.	Conditions	Position	Max. WLAN Tx1 *	BT	SAR Sum	SPLSR
8	2.4 GHz WLAN Tx1 + BT	Back side	0.878	0.086	0.964	Σ SAR<1.6, Not required
		Top side	1.078	0.059	1.137	Σ SAR<1.6, Not required

*Using WLAN TX1 back side full power SAR value to evaluate the simultaneous SAR to be the conservative evaluation.

5GHz WLAN TX1 Reduced + BT Full

No.	Conditions	Position	Max. WLAN Tx1 *	BT	SAR Sum	SPLSR
9	5 GHz WLAN Tx1 + BT	Back side	0.915	0.086	1.001	Σ SAR<1.6, Not required
		Top side	0.896	0.059	0.955	Σ SAR<1.6, Not required

*Using WLAN TX1 back side full power SAR value to evaluate the simultaneous SAR to be the conservative evaluation.

Unless otherwise stated the results shown in this test report refer only to the sample(s) tested and such sample(s) are retained for 90 days only.

除非另有說明，此報告結果僅對測試之樣品負責，同時此樣品僅保留90天。本報告未經本公司書面許可，不可部份複製。

This document is issued by the Company subject to its General Conditions of Service printed overleaf, available on request or accessible at www.sgs.com/terms_and_conditions.htm and for electronic format documents, subject to Terms and Conditions for Electronic Documents at www.sgs.com/terms_e-document.htm. Attention is drawn to the limitation of liability, indemnification and jurisdiction issues defined therein. Any holder of this document is advised that information contained hereon reflects the Company's findings at the time of its intervention only and within the limits of Client's instructions, if any. The Company's sole responsibility is to its Client and this document does not exonerate parties to a transaction from exercising all their rights and obligations under the transaction documents. This document cannot be reproduced except in full, without prior written approval of the Company. Any unauthorized alteration, forgery or falsification of the content or appearance of this document is unlawful and offenders may be prosecuted to the fullest extent of the law.

5GHz WLAN TX1 Reduced + 5GHz WLAN TX2 Reduced + BT

No.	Conditions	Position	Max. WLAN Tx1*	Max. WLAN Tx2	BT	SAR Sum	SPLSR
10	5 GHz WLAN Tx1 + WLAN Tx2 +BT	Back side	0.915	0.972	0.086	1.973	Analyzed ax below
		Top side	0.896	0.542	0.059	1.497	Σ SAR<1.6, Not required

*Using WLAN TX1 back side full power SAR value to evaluate the simultaneous SAR to be the conservative evaluation.

5GHz WLAN Tx1 + 5GHz WLAN Tx2 + BT

Conditions	Position	SAR Value (W/kg)	Coordinates (cm)			Σ SAR (W/kg)	Peak Location Separation Distance (mm)	SPLSR	Simultaneous Transmission SAR Test
			x	y	z				
WLAN Tx1	Back side	0.915	70.20	-30.20	-2.91	1.973	121.79	0.023	SPLSR<0.04, Not required
WLAN Tx2 + BT		1.058	77.00	91.40	-3.69				

*For peak SAR location of WLANTx2 + BT, using the peak SAR location with smallest separation distance between WLAN TX1 - WLAN TX2 pair and WLAN TX1 - BT pair to be the worst case condition.

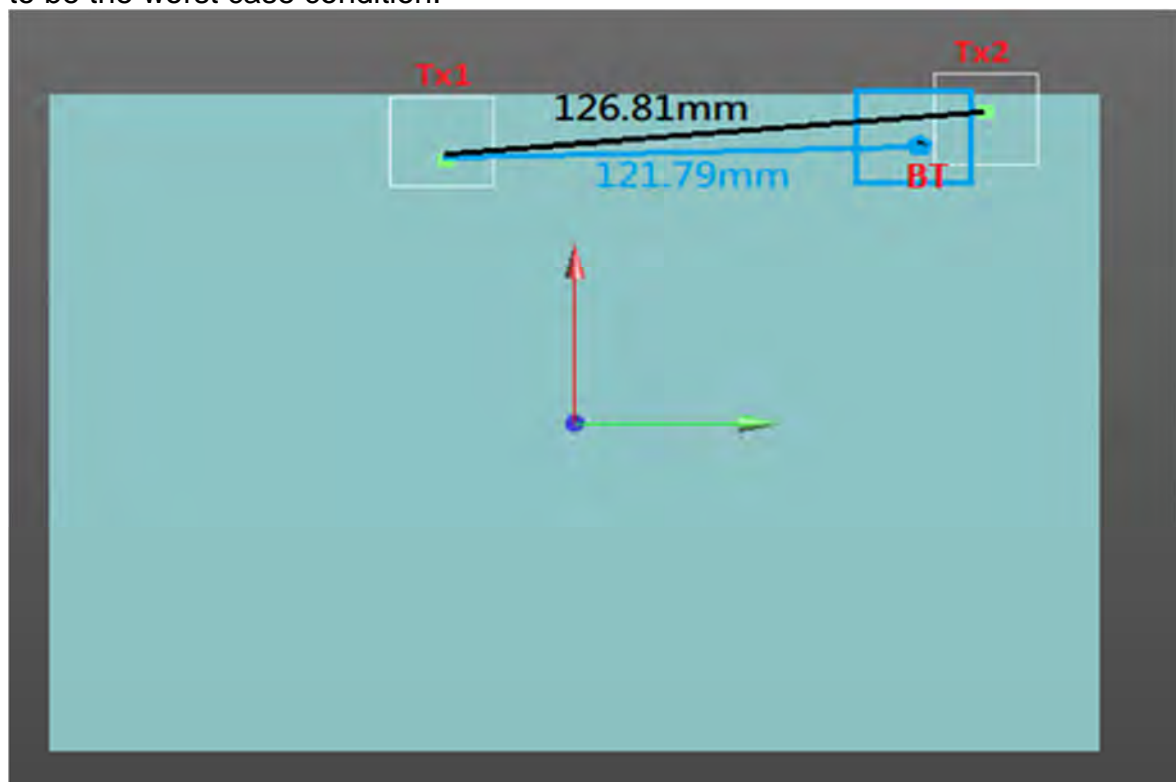

Unless otherwise stated the results shown in this test report refer only to the sample(s) tested and such sample(s) are retained for 90 days only.

除非另有說明，此報告結果僅對測試之樣品負責，同時此樣品僅保留90天。本報告未經本公司書面許可，不可部份複製。

This document is issued by the Company subject to its General Conditions of Service printed overleaf, available on request or accessible at www.sgs.com/terms_and_conditions.htm and for electronic format documents, subject to Terms and Conditions for Electronic Documents at www.sgs.com/terms_e-document.htm. Attention is drawn to the limitation of liability, indemnification and jurisdiction issues defined therein. Any holder of this document is advised that information contained hereon reflects the Company's findings at the time of its intervention only and within the limits of Client's instructions, if any. The Company's sole responsibility is to its Client and this document does not exonerate parties to a transaction from exercising all their rights and obligations under the transaction documents. This document cannot be reproduced except in full, without prior written approval of the Company. Any unauthorized alteration, forgery or falsification of the content or appearance of this document is unlawful and offenders may be prosecuted to the fullest extent of the law.

WWAN + WLAN
WWAN Full + WLAN Full

Back side WWAN + 2.4G WLAN TX1 + 2.4G WLAN TX2

No.	Position	Conditions	Max. WWAN	Max. WLAN Tx1	Max. WLAN Tx2	SAR Sum	SPLSR
1	Back side	WCDMA Band II	0.596	0.220	0.192	1.008	ΣSAR<1.6, Not required
		WCDMA Band V	0.212	0.220	0.192	0.624	ΣSAR<1.6, Not required
		LTE Band 5	0.210	0.220	0.192	0.622	ΣSAR<1.6, Not required
		LTE Band 7	0.473	0.220	0.192	0.885	ΣSAR<1.6, Not required
		LTE Band 12	0.212	0.220	0.192	0.624	ΣSAR<1.6, Not required
		LTE Band 13	0.193	0.220	0.192	0.605	ΣSAR<1.6, Not required
		LTE Band 14	0.190	0.220	0.192	0.602	ΣSAR<1.6, Not required
		LTE Band 25	0.517	0.220	0.192	0.929	ΣSAR<1.6, Not required
		LTE Band 26	0.215	0.220	0.192	0.627	ΣSAR<1.6, Not required
		LTE Band 30	0.398	0.220	0.192	0.810	ΣSAR<1.6, Not required
		LTE Band 41	0.253	0.220	0.192	0.665	ΣSAR<1.6, Not required
		LTE Band 66	0.490	0.220	0.192	0.902	ΣSAR<1.6, Not required

Unless otherwise stated the results shown in this test report refer only to the sample(s) tested and such sample(s) are retained for 90 days only.

除非另有說明，此報告結果僅對測試之樣品負責，同時此樣品僅保留90天。本報告未經本公司書面許可，不可部份複製。

This document is issued by the Company subject to its General Conditions of Service printed overleaf, available on request or accessible at www.sgs.com/terms_and_conditions.htm and for electronic format documents, subject to Terms and Conditions for Electronic Documents at www.sgs.com/terms_e-document.htm. Attention is drawn to the limitation of liability, indemnification and jurisdiction issues defined therein. Any holder of this document is advised that information contained hereon reflects the Company's findings at the time of its intervention only and within the limits of Client's instructions, if any. The Company's sole responsibility is to its Client and this document does not exonerate parties to a transaction from exercising all their rights and obligations under the transaction documents. This document cannot be reproduced except in full, without prior written approval of the Company. Any unauthorized alteration, forgery or falsification of the content or appearance of this document is unlawful and offenders may be prosecuted to the fullest extent of the law.

Back side WWAN + 5G WLAN TX1 + 5G WLAN TX2

No.	Position	Conditions	Max. WWAN	Max. WLAN Tx1	Max. WLAN Tx2	SAR Sum	SPLSR
2	Back side	WCDMA Band II	0.596	0.228	0.191	1.015	ΣSAR<1.6, Not required
		WCDMA Band V	0.212	0.228	0.191	0.631	ΣSAR<1.6, Not required
		LTE Band 5	0.210	0.228	0.191	0.629	ΣSAR<1.6, Not required
		LTE Band 7	0.473	0.228	0.191	0.892	ΣSAR<1.6, Not required
		LTE Band 12	0.212	0.228	0.191	0.631	ΣSAR<1.6, Not required
		LTE Band 13	0.193	0.228	0.191	0.612	ΣSAR<1.6, Not required
		LTE Band 14	0.190	0.228	0.191	0.609	ΣSAR<1.6, Not required
		LTE Band 25	0.517	0.228	0.191	0.936	ΣSAR<1.6, Not required
		LTE Band 26	0.215	0.228	0.191	0.634	ΣSAR<1.6, Not required
		LTE Band 30	0.398	0.228	0.191	0.817	ΣSAR<1.6, Not required
		LTE Band 41	0.253	0.228	0.191	0.672	ΣSAR<1.6, Not required
		LTE Band 66	0.490	0.228	0.191	0.909	ΣSAR<1.6, Not required

Unless otherwise stated the results shown in this test report refer only to the sample(s) tested and such sample(s) are retained for 90 days only.

除非另有說明，此報告結果僅對測試之樣品負責，同時此樣品僅保留90天。本報告未經本公司書面許可，不可部份複製。

This document is issued by the Company subject to its General Conditions of Service printed overleaf, available on request or accessible at www.sgs.com/terms_and_conditions.htm and for electronic format documents, subject to Terms and Conditions for Electronic Documents at www.sgs.com/terms_e-document.htm. Attention is drawn to the limitation of liability, indemnification and jurisdiction issues defined therein. Any holder of this document is advised that information contained hereon reflects the Company's findings at the time of its intervention only and within the limits of Client's instructions, if any. The Company's sole responsibility is to its Client and this document does not exonerate parties to a transaction from exercising all their rights and obligations under the transaction documents. This document cannot be reproduced except in full, without prior written approval of the Company. Any unauthorized alteration, forgery or falsification of the content or appearance of this document is unlawful and offenders may be prosecuted to the fullest extent of the law.

Back side WWAN + 2.4G WLAN Tx1 + BT

No.	Position	Conditions	Max. WWAN	Max. WLAN Tx1	BT	SAR Sum	SPLSR
3	Back side	WCDMA Band II	0.596	0.220	0.086	0.902	ΣSAR<1.6, Not required
		WCDMA Band V	0.212	0.220	0.086	0.518	ΣSAR<1.6, Not required
		LTE Band 5	0.210	0.220	0.086	0.516	ΣSAR<1.6, Not required
		LTE Band 7	0.473	0.220	0.086	0.779	ΣSAR<1.6, Not required
		LTE Band 12	0.212	0.220	0.086	0.518	ΣSAR<1.6, Not required
		LTE Band 13	0.193	0.220	0.086	0.499	ΣSAR<1.6, Not required
		LTE Band 14	0.190	0.220	0.086	0.496	ΣSAR<1.6, Not required
		LTE Band 25	0.517	0.220	0.086	0.823	ΣSAR<1.6, Not required
		LTE Band 26	0.215	0.220	0.086	0.521	ΣSAR<1.6, Not required
		LTE Band 30	0.398	0.220	0.086	0.704	ΣSAR<1.6, Not required
		LTE Band 41	0.253	0.220	0.086	0.559	ΣSAR<1.6, Not required
		LTE Band 66	0.490	0.220	0.086	0.796	ΣSAR<1.6, Not required

Unless otherwise stated the results shown in this test report refer only to the sample(s) tested and such sample(s) are retained for 90 days only.

除非另有說明，此報告結果僅對測試之樣品負責，同時此樣品僅保留90天。本報告未經本公司書面許可，不可部份複製。

This document is issued by the Company subject to its General Conditions of Service printed overleaf, available on request or accessible at www.sgs.com/terms_and_conditions.htm and for electronic format documents, subject to Terms and Conditions for Electronic Documents at www.sgs.com/terms_e-document.htm. Attention is drawn to the limitation of liability, indemnification and jurisdiction issues defined therein. Any holder of this document is advised that information contained hereon reflects the Company's findings at the time of its intervention only and within the limits of Client's instructions, if any. The Company's sole responsibility is to its Client and this document does not exonerate parties to a transaction from exercising all their rights and obligations under the transaction documents. This document cannot be reproduced except in full, without prior written approval of the Company. Any unauthorized alteration, forgery or falsification of the content or appearance of this document is unlawful and offenders may be prosecuted to the fullest extent of the law.

Back side WWAN + 5G WLAN TX1 + BT

No.	Position	Conditions	Max. WWAN	Max. WLAN Tx1	BT	SAR Sum	SPLSR
4	Back side	WCDMA Band II	0.596	0.228	0.086	0.910	ΣSAR<1.6, Not required
		WCDMA Band V	0.212	0.228	0.086	0.526	ΣSAR<1.6, Not required
		LTE Band 5	0.210	0.228	0.086	0.524	ΣSAR<1.6, Not required
		LTE Band 7	0.473	0.228	0.086	0.787	ΣSAR<1.6, Not required
		LTE Band 12	0.212	0.228	0.086	0.526	ΣSAR<1.6, Not required
		LTE Band 13	0.193	0.228	0.086	0.507	ΣSAR<1.6, Not required
		LTE Band 14	0.190	0.228	0.086	0.504	ΣSAR<1.6, Not required
		LTE Band 25	0.517	0.228	0.086	0.831	ΣSAR<1.6, Not required
		LTE Band 26	0.215	0.228	0.086	0.529	ΣSAR<1.6, Not required
		LTE Band 30	0.398	0.228	0.086	0.712	ΣSAR<1.6, Not required
		LTE Band 41	0.253	0.228	0.086	0.567	ΣSAR<1.6, Not required
		LTE Band 66	0.490	0.228	0.086	0.804	ΣSAR<1.6, Not required

Unless otherwise stated the results shown in this test report refer only to the sample(s) tested and such sample(s) are retained for 90 days only.

除非另有說明，此報告結果僅對測試之樣品負責，同時此樣品僅保留90天。本報告未經本公司書面許可，不可部份複製。

This document is issued by the Company subject to its General Conditions of Service printed overleaf, available on request or accessible at www.sgs.com/terms_and_conditions.htm and for electronic format documents, subject to Terms and Conditions for Electronic Documents at www.sgs.com/terms_e-document.htm. Attention is drawn to the limitation of liability, indemnification and jurisdiction issues defined therein. Any holder of this document is advised that information contained hereon reflects the Company's findings at the time of its intervention only and within the limits of Client's instructions, if any. The Company's sole responsibility is to its Client and this document does not exonerate parties to a transaction from exercising all their rights and obligations under the transaction documents. This document cannot be reproduced except in full, without prior written approval of the Company. Any unauthorized alteration, forgery or falsification of the content or appearance of this document is unlawful and offenders may be prosecuted to the fullest extent of the law.

Back side WWAN + 5G WLAN TX1 + 5G WLAN TX2 + BT

No.	Position	Conditions	Max. WWAN	Max. WLAN Tx1	Max. WLAN Tx2	BT	SAR Sum	SPLSR
5	Back side	WCDMA Band II	0.596	0.228	0.191	0.086	1.101	ΣSAR<1.6, Not required
		WCDMA Band V	0.212	0.228	0.191	0.086	0.717	ΣSAR<1.6, Not required
		LTE Band 5	0.210	0.228	0.191	0.086	0.715	ΣSAR<1.6, Not required
		LTE Band 7	0.473	0.228	0.191	0.086	0.978	ΣSAR<1.6, Not required
		LTE Band 12	0.212	0.228	0.191	0.086	0.717	ΣSAR<1.6, Not required
		LTE Band 13	0.193	0.228	0.191	0.086	0.698	ΣSAR<1.6, Not required
		LTE Band 14	0.190	0.228	0.191	0.086	0.695	ΣSAR<1.6, Not required
		LTE Band 25	0.517	0.228	0.191	0.086	1.022	ΣSAR<1.6, Not required
		LTE Band 26	0.215	0.228	0.191	0.086	0.720	ΣSAR<1.6, Not required
		LTE Band 30	0.398	0.228	0.191	0.086	0.903	ΣSAR<1.6, Not required
		LTE Band 41	0.253	0.228	0.191	0.086	0.758	ΣSAR<1.6, Not required
		LTE Band 66	0.490	0.228	0.191	0.086	0.995	ΣSAR<1.6, Not required

Unless otherwise stated the results shown in this test report refer only to the sample(s) tested and such sample(s) are retained for 90 days only.

除非另有說明，此報告結果僅對測試之樣品負責，同時此樣品僅保留90天。本報告未經本公司書面許可，不可部份複製。

This document is issued by the Company subject to its General Conditions of Service printed overleaf, available on request or accessible at www.sgs.com/terms_and_conditions.htm and for electronic format documents, subject to Terms and Conditions for Electronic Documents at www.sgs.com/terms_e-document.htm. Attention is drawn to the limitation of liability, indemnification and jurisdiction issues defined therein. Any holder of this document is advised that information contained hereon reflects the Company's findings at the time of its intervention only and within the limits of Client's instructions, if any. The Company's sole responsibility is to its Client and this document does not exonerate parties to a transaction from exercising all their rights and obligations under the transaction documents. This document cannot be reproduced except in full, without prior written approval of the Company. Any unauthorized alteration, forgery or falsification of the content or appearance of this document is unlawful and offenders may be prosecuted to the fullest extent of the law.

Top side WWAN + 2.4G WLAN TX1 + 2.4G WLAN TX2

No.	Position	Conditions	Max. WWAN	Max. WLAN Tx1	Max. WLAN Tx2	SAR Sum	SPLSR
6	Top side	WCDMA Band II	0.660	0.032	0.027	0.719	ΣSAR<1.6, Not required
		WCDMA Band V	0.133	0.032	0.027	0.192	ΣSAR<1.6, Not required
		LTE Band 5	0.142	0.032	0.027	0.201	ΣSAR<1.6, Not required
		LTE Band 7	0.281	0.032	0.027	0.340	ΣSAR<1.6, Not required
		LTE Band 12	0.126	0.032	0.027	0.185	ΣSAR<1.6, Not required
		LTE Band 13	0.117	0.032	0.027	0.176	ΣSAR<1.6, Not required
		LTE Band 14	0.118	0.032	0.027	0.177	ΣSAR<1.6, Not required
		LTE Band 25	0.639	0.032	0.027	0.698	ΣSAR<1.6, Not required
		LTE Band 26	0.162	0.032	0.027	0.221	ΣSAR<1.6, Not required
		LTE Band 30	0.312	0.032	0.027	0.371	ΣSAR<1.6, Not required
		LTE Band 41	0.125	0.032	0.027	0.184	ΣSAR<1.6, Not required
		LTE Band 66	0.845	0.032	0.027	0.904	ΣSAR<1.6, Not required

Unless otherwise stated the results shown in this test report refer only to the sample(s) tested and such sample(s) are retained for 90 days only.

除非另有說明，此報告結果僅對測試之樣品負責，同時此樣品僅保留90天。本報告未經本公司書面許可，不可部份複製。

This document is issued by the Company subject to its General Conditions of Service printed overleaf, available on request or accessible at www.sgs.com/terms_and_conditions.htm and for electronic format documents, subject to Terms and Conditions for Electronic Documents at www.sgs.com/terms_e-document.htm. Attention is drawn to the limitation of liability, indemnification and jurisdiction issues defined therein. Any holder of this document is advised that information contained hereon reflects the Company's findings at the time of its intervention only and within the limits of Client's instructions, if any. The Company's sole responsibility is to its Client and this document does not exonerate parties to a transaction from exercising all their rights and obligations under the transaction documents. This document cannot be reproduced except in full, without prior written approval of the Company. Any unauthorized alteration, forgery or falsification of the content or appearance of this document is unlawful and offenders may be prosecuted to the fullest extent of the law.

Top side WWAN + 5G WLAN TX1 + 5G WLAN TX2

No.	Position	Conditions	Max. WWAN	Max. WLAN Tx1	Max. WLAN Tx2	SAR Sum	SPLSR
7	Top side	WCDMA Band II	0.660	0.161	0.106	0.927	ΣSAR<1.6, Not required
		WCDMA Band V	0.133	0.161	0.106	0.400	ΣSAR<1.6, Not required
		LTE Band 5	0.142	0.161	0.106	0.409	ΣSAR<1.6, Not required
		LTE Band 7	0.281	0.161	0.106	0.548	ΣSAR<1.6, Not required
		LTE Band 12	0.126	0.161	0.106	0.393	ΣSAR<1.6, Not required
		LTE Band 13	0.117	0.161	0.106	0.384	ΣSAR<1.6, Not required
		LTE Band 14	0.118	0.161	0.106	0.385	ΣSAR<1.6, Not required
		LTE Band 25	0.639	0.161	0.106	0.906	ΣSAR<1.6, Not required
		LTE Band 26	0.162	0.161	0.106	0.429	ΣSAR<1.6, Not required
		LTE Band 30	0.312	0.161	0.106	0.579	ΣSAR<1.6, Not required
		LTE Band 41	0.125	0.161	0.106	0.392	ΣSAR<1.6, Not required
		LTE Band 66	0.845	0.161	0.106	1.112	ΣSAR<1.6, Not required

Unless otherwise stated the results shown in this test report refer only to the sample(s) tested and such sample(s) are retained for 90 days only.

除非另有說明，此報告結果僅對測試之樣品負責，同時此樣品僅保留90天。本報告未經本公司書面許可，不可部份複製。

This document is issued by the Company subject to its General Conditions of Service printed overleaf, available on request or accessible at www.sgs.com/terms_and_conditions.htm and for electronic format documents, subject to Terms and Conditions for Electronic Documents at www.sgs.com/terms_e-document.htm. Attention is drawn to the limitation of liability, indemnification and jurisdiction issues defined therein. Any holder of this document is advised that information contained hereon reflects the Company's findings at the time of its intervention only and within the limits of Client's instructions, if any. The Company's sole responsibility is to its Client and this document does not exonerate parties to a transaction from exercising all their rights and obligations under the transaction documents. This document cannot be reproduced except in full, without prior written approval of the Company. Any unauthorized alteration, forgery or falsification of the content or appearance of this document is unlawful and offenders may be prosecuted to the fullest extent of the law.

Top side WWAN + 2.4G WLAN Tx1 + BT

No.	Position	Conditions	Max. WWAN	Max. WLAN Tx1	BT	SAR Sum	SPLSR
8	Top side	WCDMA Band II	0.660	0.032	0.059	0.751	Σ SAR<1.6, Not required
		WCDMA Band V	0.133	0.032	0.059	0.224	Σ SAR<1.6, Not required
		LTE Band 5	0.142	0.032	0.059	0.233	Σ SAR<1.6, Not required
		LTE Band 7	0.281	0.032	0.059	0.372	Σ SAR<1.6, Not required
		LTE Band 12	0.126	0.032	0.059	0.217	Σ SAR<1.6, Not required
		LTE Band 13	0.117	0.032	0.059	0.208	Σ SAR<1.6, Not required
		LTE Band 14	0.118	0.032	0.059	0.209	Σ SAR<1.6, Not required
		LTE Band 25	0.639	0.032	0.059	0.730	Σ SAR<1.6, Not required
		LTE Band 26	0.162	0.032	0.059	0.253	Σ SAR<1.6, Not required
		LTE Band 30	0.312	0.032	0.059	0.403	Σ SAR<1.6, Not required
		LTE Band 41	0.125	0.032	0.059	0.216	Σ SAR<1.6, Not required
		LTE Band 66	0.845	0.032	0.059	0.936	Σ SAR<1.6, Not required

Unless otherwise stated the results shown in this test report refer only to the sample(s) tested and such sample(s) are retained for 90 days only.

除非另有說明，此報告結果僅對測試之樣品負責，同時此樣品僅保留90天。本報告未經本公司書面許可，不可部份複製。

This document is issued by the Company subject to its General Conditions of Service printed overleaf, available on request or accessible at www.sgs.com/terms_and_conditions.htm and for electronic format documents, subject to Terms and Conditions for Electronic Documents at www.sgs.com/terms_e-document.htm. Attention is drawn to the limitation of liability, indemnification and jurisdiction issues defined therein. Any holder of this document is advised that information contained hereon reflects the Company's findings at the time of its intervention only and within the limits of Client's instructions, if any. The Company's sole responsibility is to its Client and this document does not exonerate parties to a transaction from exercising all their rights and obligations under the transaction documents. This document cannot be reproduced except in full, without prior written approval of the Company. Any unauthorized alteration, forgery or falsification of the content or appearance of this document is unlawful and offenders may be prosecuted to the fullest extent of the law.

Top side WWAN + 5G WLAN Tx1 + BT

No.	Position	Conditions	Max. WWAN	Max. WLAN Tx1	BT	SAR Sum	SPLSR
9	Top side	WCDMA Band II	0.660	0.161	0.059	0.880	ΣSAR<1.6, Not required
		WCDMA Band V	0.133	0.161	0.059	0.353	ΣSAR<1.6, Not required
		LTE Band 5	0.142	0.161	0.059	0.362	ΣSAR<1.6, Not required
		LTE Band 7	0.281	0.161	0.059	0.501	ΣSAR<1.6, Not required
		LTE Band 12	0.126	0.161	0.059	0.346	ΣSAR<1.6, Not required
		LTE Band 13	0.117	0.161	0.059	0.337	ΣSAR<1.6, Not required
		LTE Band 14	0.118	0.161	0.059	0.338	ΣSAR<1.6, Not required
		LTE Band 25	0.639	0.161	0.059	0.859	ΣSAR<1.6, Not required
		LTE Band 26	0.162	0.161	0.059	0.382	ΣSAR<1.6, Not required
		LTE Band 30	0.312	0.161	0.059	0.532	ΣSAR<1.6, Not required
		LTE Band 41	0.125	0.161	0.059	0.345	ΣSAR<1.6, Not required
		LTE Band 66	0.845	0.161	0.059	1.065	ΣSAR<1.6, Not required

Unless otherwise stated the results shown in this test report refer only to the sample(s) tested and such sample(s) are retained for 90 days only.

除非另有說明，此報告結果僅對測試之樣品負責，同時此樣品僅保留90天。本報告未經本公司書面許可，不可部份複製。

This document is issued by the Company subject to its General Conditions of Service printed overleaf, available on request or accessible at www.sgs.com/terms_and_conditions.htm and for electronic format documents, subject to Terms and Conditions for Electronic Documents at www.sgs.com/terms_e-document.htm. Attention is drawn to the limitation of liability, indemnification and jurisdiction issues defined therein. Any holder of this document is advised that information contained hereon reflects the Company's findings at the time of its intervention only and within the limits of Client's instructions, if any. The Company's sole responsibility is to its Client and this document does not exonerate parties to a transaction from exercising all their rights and obligations under the transaction documents. This document cannot be reproduced except in full, without prior written approval of the Company. Any unauthorized alteration, forgery or falsification of the content or appearance of this document is unlawful and offenders may be prosecuted to the fullest extent of the law.

Top side WWAN + 5G WLAN TX1 + 5G WLAN TX2 + BT

No.	Position	Conditions	Max. WWAN	Max. WLAN Tx1	Max. WLAN Tx2	BT	SAR Sum	SPLSR
10	Top side	WCDMA Band II	0.660	0.161	0.106	0.059	0.986	ΣSAR<1.6, Not required
		WCDMA Band V	0.133	0.161	0.106	0.059	0.459	ΣSAR<1.6, Not required
		LTE Band 5	0.142	0.161	0.106	0.059	0.468	ΣSAR<1.6, Not required
		LTE Band 7	0.281	0.161	0.106	0.059	0.607	ΣSAR<1.6, Not required
		LTE Band 12	0.126	0.161	0.106	0.059	0.452	ΣSAR<1.6, Not required
		LTE Band 13	0.117	0.161	0.106	0.059	0.443	ΣSAR<1.6, Not required
		LTE Band 14	0.118	0.161	0.106	0.059	0.444	ΣSAR<1.6, Not required
		LTE Band 25	0.639	0.161	0.106	0.059	0.965	ΣSAR<1.6, Not required
		LTE Band 26	0.162	0.161	0.106	0.059	0.488	ΣSAR<1.6, Not required
		LTE Band 30	0.312	0.161	0.106	0.059	0.638	ΣSAR<1.6, Not required
		LTE Band 41	0.125	0.161	0.106	0.059	0.451	ΣSAR<1.6, Not required
		LTE Band 66	0.845	0.161	0.106	0.059	1.171	ΣSAR<1.6, Not required

Unless otherwise stated the results shown in this test report refer only to the sample(s) tested and such sample(s) are retained for 90 days only.

除非另有說明，此報告結果僅對測試之樣品負責，同時此樣品僅保留90天。本報告未經本公司書面許可，不可部份複製。

This document is issued by the Company subject to its General Conditions of Service printed overleaf, available on request or accessible at www.sgs.com/terms_and_conditions.htm and for electronic format documents, subject to Terms and Conditions for Electronic Documents at www.sgs.com/terms_e-document.htm. Attention is drawn to the limitation of liability, indemnification and jurisdiction issues defined therein. Any holder of this document is advised that information contained hereon reflects the Company's findings at the time of its intervention only and within the limits of Client's instructions, if any. The Company's sole responsibility is to its Client and this document does not exonerate parties to a transaction from exercising all their rights and obligations under the transaction documents. This document cannot be reproduced except in full, without prior written approval of the Company. Any unauthorized alteration, forgery or falsification of the content or appearance of this document is unlawful and offenders may be prosecuted to the fullest extent of the law.

Bottom side WWAN + 2.4G WLAN TX1 + 2.4G WLAN TX2

No.	Position	Conditions	Max. WWAN	Max. WLAN Tx1	Max. WLAN Tx2	SAR Sum	SPLSR
11	Bottom side	WCDMA Band II	0.037	0.007	0.006	0.050	ΣSAR<1.6, Not required
		WCDMA Band V	0.036	0.007	0.006	0.049	ΣSAR<1.6, Not required
		LTE Band 5	0.028	0.007	0.006	0.041	ΣSAR<1.6, Not required
		LTE Band 7	0.080	0.007	0.006	0.093	ΣSAR<1.6, Not required
		LTE Band 12	0.025	0.007	0.006	0.038	ΣSAR<1.6, Not required
		LTE Band 13	0.023	0.007	0.006	0.036	ΣSAR<1.6, Not required
		LTE Band 14	0.023	0.007	0.006	0.036	ΣSAR<1.6, Not required
		LTE Band 25	0.070	0.007	0.006	0.083	ΣSAR<1.6, Not required
		LTE Band 26	0.027	0.007	0.006	0.040	ΣSAR<1.6, Not required
		LTE Band 30	0.093	0.007	0.006	0.106	ΣSAR<1.6, Not required
		LTE Band 41	0.074	0.007	0.006	0.087	ΣSAR<1.6, Not required
		LTE Band 66	0.074	0.007	0.006	0.087	ΣSAR<1.6, Not required

Unless otherwise stated the results shown in this test report refer only to the sample(s) tested and such sample(s) are retained for 90 days only.

除非另有說明，此報告結果僅對測試之樣品負責，同時此樣品僅保留90天。本報告未經本公司書面許可，不可部份複製。

This document is issued by the Company subject to its General Conditions of Service printed overleaf, available on request or accessible at www.sgs.com/terms_and_conditions.htm and for electronic format documents, subject to Terms and Conditions for Electronic Documents at www.sgs.com/terms_e-document.htm. Attention is drawn to the limitation of liability, indemnification and jurisdiction issues defined therein. Any holder of this document is advised that information contained hereon reflects the Company's findings at the time of its intervention only and within the limits of Client's instructions, if any. The Company's sole responsibility is to its Client and this document does not exonerate parties to a transaction from exercising all their rights and obligations under the transaction documents. This document cannot be reproduced except in full, without prior written approval of the Company. Any unauthorized alteration, forgery or falsification of the content or appearance of this document is unlawful and offenders may be prosecuted to the fullest extent of the law.

Bottom side WWAN + 5G WLAN TX1 + 5G WLAN TX2

No.	Position	Conditions	Max. WWAN	Max. WLAN Tx1	Max. WLAN Tx2	SAR Sum	SPLSR
12	Bottom side	WCDMA Band II	0.037	0.054	0.024	0.115	ΣSAR<1.6, Not required
		WCDMA Band V	0.036	0.054	0.024	0.114	ΣSAR<1.6, Not required
		LTE Band 5	0.028	0.054	0.024	0.106	ΣSAR<1.6, Not required
		LTE Band 7	0.080	0.054	0.024	0.158	ΣSAR<1.6, Not required
		LTE Band 12	0.025	0.054	0.024	0.103	ΣSAR<1.6, Not required
		LTE Band 13	0.023	0.054	0.024	0.101	ΣSAR<1.6, Not required
		LTE Band 14	0.023	0.054	0.024	0.101	ΣSAR<1.6, Not required
		LTE Band 25	0.070	0.054	0.024	0.148	ΣSAR<1.6, Not required
		LTE Band 26	0.027	0.054	0.024	0.105	ΣSAR<1.6, Not required
		LTE Band 30	0.093	0.054	0.024	0.171	ΣSAR<1.6, Not required
		LTE Band 41	0.074	0.054	0.024	0.152	ΣSAR<1.6, Not required
		LTE Band 66	0.074	0.054	0.024	0.152	ΣSAR<1.6, Not required

Unless otherwise stated the results shown in this test report refer only to the sample(s) tested and such sample(s) are retained for 90 days only.

除非另有說明，此報告結果僅對測試之樣品負責，同時此樣品僅保留90天。本報告未經本公司書面許可，不可部份複製。

This document is issued by the Company subject to its General Conditions of Service printed overleaf, available on request or accessible at www.sgs.com/terms_and_conditions.htm and for electronic format documents, subject to Terms and Conditions for Electronic Documents at www.sgs.com/terms_e-document.htm. Attention is drawn to the limitation of liability, indemnification and jurisdiction issues defined therein. Any holder of this document is advised that information contained hereon reflects the Company's findings at the time of its intervention only and within the limits of Client's instructions, if any. The Company's sole responsibility is to its Client and this document does not exonerate parties to a transaction from exercising all their rights and obligations under the transaction documents. This document cannot be reproduced except in full, without prior written approval of the Company. Any unauthorized alteration, forgery or falsification of the content or appearance of this document is unlawful and offenders may be prosecuted to the fullest extent of the law.

Bottom side WWAN + 2.4G WLAN Tx1 + BT

No.	Position	Conditions	Max. WWAN	Max. WLAN Tx1	BT	SAR Sum	SPLSR
13	Bottom side	WCDMA Band II	0.037	0.007	0.013	0.057	ΣSAR<1.6, Not required
		WCDMA Band V	0.036	0.007	0.013	0.056	ΣSAR<1.6, Not required
		LTE Band 5	0.028	0.007	0.013	0.048	ΣSAR<1.6, Not required
		LTE Band 7	0.080	0.007	0.013	0.100	ΣSAR<1.6, Not required
		LTE Band 12	0.025	0.007	0.013	0.045	ΣSAR<1.6, Not required
		LTE Band 13	0.023	0.007	0.013	0.043	ΣSAR<1.6, Not required
		LTE Band 14	0.023	0.007	0.013	0.043	ΣSAR<1.6, Not required
		LTE Band 25	0.070	0.007	0.013	0.090	ΣSAR<1.6, Not required
		LTE Band 26	0.027	0.007	0.013	0.047	ΣSAR<1.6, Not required
		LTE Band 30	0.093	0.007	0.013	0.113	ΣSAR<1.6, Not required
		LTE Band 41	0.074	0.007	0.013	0.094	ΣSAR<1.6, Not required
		LTE Band 66	0.074	0.007	0.013	0.094	ΣSAR<1.6, Not required

Unless otherwise stated the results shown in this test report refer only to the sample(s) tested and such sample(s) are retained for 90 days only.

除非另有說明，此報告結果僅對測試之樣品負責，同時此樣品僅保留90天。本報告未經本公司書面許可，不可部份複製。

This document is issued by the Company subject to its General Conditions of Service printed overleaf, available on request or accessible at www.sgs.com/terms_and_conditions.htm and for electronic format documents, subject to Terms and Conditions for Electronic Documents at www.sgs.com/terms_e-document.htm. Attention is drawn to the limitation of liability, indemnification and jurisdiction issues defined therein. Any holder of this document is advised that information contained hereon reflects the Company's findings at the time of its intervention only and within the limits of Client's instructions, if any. The Company's sole responsibility is to its Client and this document does not exonerate parties to a transaction from exercising all their rights and obligations under the transaction documents. This document cannot be reproduced except in full, without prior written approval of the Company. Any unauthorized alteration, forgery or falsification of the content or appearance of this document is unlawful and offenders may be prosecuted to the fullest extent of the law.

Bottom side WWAN + 5G WLAN Tx1 + BT

No.	Position	Conditions	Max. WWAN	Max. WLAN Tx1	BT	SAR Sum	SPLSR
14	Bottom side	WCDMA Band II	0.037	0.054	0.013	0.104	ΣSAR<1.6, Not required
		WCDMA Band V	0.036	0.054	0.013	0.103	ΣSAR<1.6, Not required
		LTE Band 5	0.028	0.054	0.013	0.095	ΣSAR<1.6, Not required
		LTE Band 7	0.080	0.054	0.013	0.147	ΣSAR<1.6, Not required
		LTE Band 12	0.025	0.054	0.013	0.092	ΣSAR<1.6, Not required
		LTE Band 13	0.023	0.054	0.013	0.090	ΣSAR<1.6, Not required
		LTE Band 14	0.023	0.054	0.013	0.090	ΣSAR<1.6, Not required
		LTE Band 25	0.070	0.054	0.013	0.137	ΣSAR<1.6, Not required
		LTE Band 26	0.027	0.054	0.013	0.094	ΣSAR<1.6, Not required
		LTE Band 30	0.093	0.054	0.013	0.160	ΣSAR<1.6, Not required
		LTE Band 41	0.074	0.054	0.013	0.141	ΣSAR<1.6, Not required
		LTE Band 66	0.074	0.054	0.013	0.141	ΣSAR<1.6, Not required

Unless otherwise stated the results shown in this test report refer only to the sample(s) tested and such sample(s) are retained for 90 days only.

除非另有說明，此報告結果僅對測試之樣品負責，同時此樣品僅保留90天。本報告未經本公司書面許可，不可部份複製。

This document is issued by the Company subject to its General Conditions of Service printed overleaf, available on request or accessible at www.sgs.com/terms_and_conditions.htm and for electronic format documents, subject to Terms and Conditions for Electronic Documents at www.sgs.com/terms_e-document.htm. Attention is drawn to the limitation of liability, indemnification and jurisdiction issues defined therein. Any holder of this document is advised that information contained hereon reflects the Company's findings at the time of its intervention only and within the limits of Client's instructions, if any. The Company's sole responsibility is to its Client and this document does not exonerate parties to a transaction from exercising all their rights and obligations under the transaction documents. This document cannot be reproduced except in full, without prior written approval of the Company. Any unauthorized alteration, forgery or falsification of the content or appearance of this document is unlawful and offenders may be prosecuted to the fullest extent of the law.

Bottom side WWAN + 5G WLAN TX1 + 5G WLAN TX2 + BT

No.	Position	Conditions	Max. WWAN	Max. WLAN Tx1	Max. WLAN Tx2	BT	SAR Sum	SPLSR
15	Bottom side	WCDMA Band II	0.037	0.054	0.024	0.013	0.128	ΣSAR<1.6, Not required
		WCDMA Band V	0.036	0.054	0.024	0.013	0.127	ΣSAR<1.6, Not required
		LTE Band 5	0.028	0.054	0.024	0.013	0.119	ΣSAR<1.6, Not required
		LTE Band 7	0.080	0.054	0.024	0.013	0.171	ΣSAR<1.6, Not required
		LTE Band 12	0.025	0.054	0.024	0.013	0.116	ΣSAR<1.6, Not required
		LTE Band 13	0.023	0.054	0.024	0.013	0.114	ΣSAR<1.6, Not required
		LTE Band 14	0.023	0.054	0.024	0.013	0.114	ΣSAR<1.6, Not required
		LTE Band 25	0.070	0.054	0.024	0.013	0.161	ΣSAR<1.6, Not required
		LTE Band 26	0.027	0.054	0.024	0.013	0.118	ΣSAR<1.6, Not required
		LTE Band 30	0.093	0.054	0.024	0.013	0.184	ΣSAR<1.6, Not required
		LTE Band 41	0.074	0.054	0.024	0.013	0.165	ΣSAR<1.6, Not required
		LTE Band 66	0.074	0.054	0.024	0.013	0.165	ΣSAR<1.6, Not required

Unless otherwise stated the results shown in this test report refer only to the sample(s) tested and such sample(s) are retained for 90 days only.

除非另有說明，此報告結果僅對測試之樣品負責，同時此樣品僅保留90天。本報告未經本公司書面許可，不可部份複製。

This document is issued by the Company subject to its General Conditions of Service printed overleaf, available on request or accessible at www.sgs.com/terms_and_conditions.htm and for electronic format documents, subject to Terms and Conditions for Electronic Documents at www.sgs.com/terms_e-document.htm. Attention is drawn to the limitation of liability, indemnification and jurisdiction issues defined therein. Any holder of this document is advised that information contained hereon reflects the Company's findings at the time of its intervention only and within the limits of Client's instructions, if any. The Company's sole responsibility is to its Client and this document does not exonerate parties to a transaction from exercising all their rights and obligations under the transaction documents. This document cannot be reproduced except in full, without prior written approval of the Company. Any unauthorized alteration, forgery or falsification of the content or appearance of this document is unlawful and offenders may be prosecuted to the fullest extent of the law.

Right side WWAN + 2.4G WLAN TX1 + 2.4G WLAN TX2

No.	Position	Conditions	Max. WWAN	Max. WLAN Tx1	Max. WLAN Tx2	SAR Sum	SPLSR
16	Right side	WCDMA Band II	0.089	0.001	0.004	0.094	Σ SAR<1.6, Not required
		WCDMA Band V	0.085	0.001	0.004	0.090	Σ SAR<1.6, Not required
		LTE Band 5	0.099	0.001	0.004	0.104	Σ SAR<1.6, Not required
		LTE Band 7	0.076	0.001	0.004	0.081	Σ SAR<1.6, Not required
		LTE Band 12	0.088	0.001	0.004	0.093	Σ SAR<1.6, Not required
		LTE Band 13	0.082	0.001	0.004	0.087	Σ SAR<1.6, Not required
		LTE Band 14	0.083	0.001	0.004	0.088	Σ SAR<1.6, Not required
		LTE Band 25	0.100	0.001	0.004	0.105	Σ SAR<1.6, Not required
		LTE Band 26	0.094	0.001	0.004	0.099	Σ SAR<1.6, Not required
		LTE Band 30	0.042	0.001	0.004	0.047	Σ SAR<1.6, Not required
		LTE Band 41	0.033	0.001	0.004	0.038	Σ SAR<1.6, Not required
		LTE Band 66	0.106	0.001	0.004	0.111	Σ SAR<1.6, Not required

Unless otherwise stated the results shown in this test report refer only to the sample(s) tested and such sample(s) are retained for 90 days only.

除非另有說明，此報告結果僅對測試之樣品負責，同時此樣品僅保留90天。本報告未經本公司書面許可，不可部份複製。

This document is issued by the Company subject to its General Conditions of Service printed overleaf, available on request or accessible at www.sgs.com/terms_and_conditions.htm and for electronic format documents, subject to Terms and Conditions for Electronic Documents at www.sgs.com/terms_e-document.htm. Attention is drawn to the limitation of liability, indemnification and jurisdiction issues defined therein. Any holder of this document is advised that information contained hereon reflects the Company's findings at the time of its intervention only and within the limits of Client's instructions, if any. The Company's sole responsibility is to its Client and this document does not exonerate parties to a transaction from exercising all their rights and obligations under the transaction documents. This document cannot be reproduced except in full, without prior written approval of the Company. Any unauthorized alteration, forgery or falsification of the content or appearance of this document is unlawful and offenders may be prosecuted to the fullest extent of the law.

Right side WWAN + 5G WLAN TX1 + 5G WLAN TX2

No.	Position	Conditions	Max. WWAN	Max. WLAN Tx1	Max. WLAN Tx2	SAR Sum	SPLSR
17	Right side	WCDMA Band II	0.089	0.032	0.101	0.222	Σ SAR<1.6, Not required
		WCDMA Band V	0.085	0.032	0.101	0.218	Σ SAR<1.6, Not required
		LTE Band 5	0.099	0.032	0.101	0.232	Σ SAR<1.6, Not required
		LTE Band 7	0.076	0.032	0.101	0.209	Σ SAR<1.6, Not required
		LTE Band 12	0.088	0.032	0.101	0.221	Σ SAR<1.6, Not required
		LTE Band 13	0.082	0.032	0.101	0.215	Σ SAR<1.6, Not required
		LTE Band 14	0.083	0.032	0.101	0.216	Σ SAR<1.6, Not required
		LTE Band 25	0.100	0.032	0.101	0.233	Σ SAR<1.6, Not required
		LTE Band 26	0.094	0.032	0.101	0.227	Σ SAR<1.6, Not required
		LTE Band 30	0.042	0.032	0.101	0.175	Σ SAR<1.6, Not required
		LTE Band 41	0.033	0.032	0.101	0.166	Σ SAR<1.6, Not required
		LTE Band 66	0.106	0.032	0.101	0.239	Σ SAR<1.6, Not required

Unless otherwise stated the results shown in this test report refer only to the sample(s) tested and such sample(s) are retained for 90 days only.

除非另有說明，此報告結果僅對測試之樣品負責，同時此樣品僅保留90天。本報告未經本公司書面許可，不可部份複製。

This document is issued by the Company subject to its General Conditions of Service printed overleaf, available on request or accessible at www.sgs.com/terms_and_conditions.htm and for electronic format documents, subject to Terms and Conditions for Electronic Documents at www.sgs.com/terms_e-document.htm. Attention is drawn to the limitation of liability, indemnification and jurisdiction issues defined therein. Any holder of this document is advised that information contained hereon reflects the Company's findings at the time of its intervention only and within the limits of Client's instructions, if any. The Company's sole responsibility is to its Client and this document does not exonerate parties to a transaction from exercising all their rights and obligations under the transaction documents. This document cannot be reproduced except in full, without prior written approval of the Company. Any unauthorized alteration, forgery or falsification of the content or appearance of this document is unlawful and offenders may be prosecuted to the fullest extent of the law.

Right side WWAN + 2.4G WLAN Tx1 + BT

No.	Position	Conditions	Max. WWAN	Max. WLAN Tx1	BT	SAR Sum	SPLSR
18	Right side	WCDMA Band II	0.089	0.001	0.049	0.139	ΣSAR<1.6, Not required
		WCDMA Band V	0.085	0.001	0.049	0.135	ΣSAR<1.6, Not required
		LTE Band 5	0.099	0.001	0.049	0.149	ΣSAR<1.6, Not required
		LTE Band 7	0.076	0.001	0.049	0.126	ΣSAR<1.6, Not required
		LTE Band 12	0.088	0.001	0.049	0.138	ΣSAR<1.6, Not required
		LTE Band 13	0.082	0.001	0.049	0.132	ΣSAR<1.6, Not required
		LTE Band 14	0.083	0.001	0.049	0.133	ΣSAR<1.6, Not required
		LTE Band 25	0.100	0.001	0.049	0.150	ΣSAR<1.6, Not required
		LTE Band 26	0.094	0.001	0.049	0.144	ΣSAR<1.6, Not required
		LTE Band 30	0.042	0.001	0.049	0.092	ΣSAR<1.6, Not required
		LTE Band 41	0.033	0.001	0.049	0.083	ΣSAR<1.6, Not required
		LTE Band 66	0.106	0.001	0.049	0.156	ΣSAR<1.6, Not required

Unless otherwise stated the results shown in this test report refer only to the sample(s) tested and such sample(s) are retained for 90 days only.

除非另有說明，此報告結果僅對測試之樣品負責，同時此樣品僅保留90天。本報告未經本公司書面許可，不可部份複製。

This document is issued by the Company subject to its General Conditions of Service printed overleaf, available on request or accessible at www.sgs.com/terms_and_conditions.htm and for electronic format documents, subject to Terms and Conditions for Electronic Documents at www.sgs.com/terms_e-document.htm. Attention is drawn to the limitation of liability, indemnification and jurisdiction issues defined therein. Any holder of this document is advised that information contained hereon reflects the Company's findings at the time of its intervention only and within the limits of Client's instructions, if any. The Company's sole responsibility is to its Client and this document does not exonerate parties to a transaction from exercising all their rights and obligations under the transaction documents. This document cannot be reproduced except in full, without prior written approval of the Company. Any unauthorized alteration, forgery or falsification of the content or appearance of this document is unlawful and offenders may be prosecuted to the fullest extent of the law.

Right side WWAN + 5G WLAN Tx1 + BT

No.	Position	Conditions	Max. WWAN	Max. WLAN Tx1	BT	SAR Sum	SPLSR
19	Right side	WCDMA Band II	0.089	0.032	0.049	0.170	ΣSAR<1.6, Not required
		WCDMA Band V	0.085	0.032	0.049	0.166	ΣSAR<1.6, Not required
		LTE Band 5	0.099	0.032	0.049	0.180	ΣSAR<1.6, Not required
		LTE Band 7	0.076	0.032	0.049	0.157	ΣSAR<1.6, Not required
		LTE Band 12	0.088	0.032	0.049	0.169	ΣSAR<1.6, Not required
		LTE Band 13	0.082	0.032	0.049	0.163	ΣSAR<1.6, Not required
		LTE Band 14	0.083	0.032	0.049	0.164	ΣSAR<1.6, Not required
		LTE Band 25	0.100	0.032	0.049	0.181	ΣSAR<1.6, Not required
		LTE Band 26	0.094	0.032	0.049	0.175	ΣSAR<1.6, Not required
		LTE Band 30	0.042	0.032	0.049	0.123	ΣSAR<1.6, Not required
		LTE Band 41	0.033	0.032	0.049	0.114	ΣSAR<1.6, Not required
		LTE Band 66	0.106	0.032	0.049	0.187	ΣSAR<1.6, Not required

Unless otherwise stated the results shown in this test report refer only to the sample(s) tested and such sample(s) are retained for 90 days only.

除非另有說明，此報告結果僅對測試之樣品負責，同時此樣品僅保留90天。本報告未經本公司書面許可，不可部份複製。

This document is issued by the Company subject to its General Conditions of Service printed overleaf, available on request or accessible at www.sgs.com/terms_and_conditions.htm and for electronic format documents, subject to Terms and Conditions for Electronic Documents at www.sgs.com/terms_e-document.htm. Attention is drawn to the limitation of liability, indemnification and jurisdiction issues defined therein. Any holder of this document is advised that information contained hereon reflects the Company's findings at the time of its intervention only and within the limits of Client's instructions, if any. The Company's sole responsibility is to its Client and this document does not exonerate parties to a transaction from exercising all their rights and obligations under the transaction documents. This document cannot be reproduced except in full, without prior written approval of the Company. Any unauthorized alteration, forgery or falsification of the content or appearance of this document is unlawful and offenders may be prosecuted to the fullest extent of the law.

Right side WWAN + 5G WLAN TX1 + 5G WLAN TX2 + BT

No.	Position	Conditions	Max. WWAN	Max. WLAN Tx1	Max. WLAN Tx2	BT	SAR Sum	SPLSR
20	Right side	WCDMA Band II	0.089	0.032	0.101	0.049	0.271	ΣSAR<1.6, Not required
		WCDMA Band V	0.085	0.032	0.101	0.049	0.267	ΣSAR<1.6, Not required
		LTE Band 5	0.099	0.032	0.101	0.049	0.281	ΣSAR<1.6, Not required
		LTE Band 7	0.076	0.032	0.101	0.049	0.258	ΣSAR<1.6, Not required
		LTE Band 12	0.088	0.032	0.101	0.049	0.270	ΣSAR<1.6, Not required
		LTE Band 13	0.082	0.032	0.101	0.049	0.264	ΣSAR<1.6, Not required
		LTE Band 14	0.083	0.032	0.101	0.049	0.265	ΣSAR<1.6, Not required
		LTE Band 25	0.100	0.032	0.101	0.049	0.282	ΣSAR<1.6, Not required
		LTE Band 26	0.094	0.032	0.101	0.049	0.276	ΣSAR<1.6, Not required
		LTE Band 30	0.042	0.032	0.101	0.049	0.224	ΣSAR<1.6, Not required
		LTE Band 41	0.033	0.032	0.101	0.049	0.215	ΣSAR<1.6, Not required
		LTE Band 66	0.106	0.032	0.101	0.049	0.288	ΣSAR<1.6, Not required

Unless otherwise stated the results shown in this test report refer only to the sample(s) tested and such sample(s) are retained for 90 days only.
除非另有說明，此報告結果僅對測試之樣品負責，同時此樣品僅保留90天。本報告未經本公司書面許可，不可部份複製。

This document is issued by the Company subject to its General Conditions of Service printed overleaf, available on request or accessible at www.sgs.com/terms_and_conditions.htm and for electronic format documents, subject to Terms and Conditions for Electronic Documents at www.sgs.com/terms_e-document.htm. Attention is drawn to the limitation of liability, indemnification and jurisdiction issues defined therein. Any holder of this document is advised that information contained hereon reflects the Company's findings at the time of its intervention only and within the limits of Client's instructions, if any. The Company's sole responsibility is to its Client and this document does not exonerate parties to a transaction from exercising all their rights and obligations under the transaction documents. This document cannot be reproduced except in full, without prior written approval of the Company. Any unauthorized alteration, forgery or falsification of the content or appearance of this document is unlawful and offenders may be prosecuted to the fullest extent of the law.

Left side WWAN + 2.4G WLAN TX1 + 2.4G WLAN TX2

No.	Position	Conditions	Max. WWAN	Max. WLAN Tx1	Max. WLAN Tx2	SAR Sum	SPLSR
21	Left side	WCDMA Band II	0.233	0.002	0.007	0.242	ΣSAR<1.6, Not required
		WCDMA Band V	0.293	0.002	0.007	0.302	ΣSAR<1.6, Not required
		LTE Band 5	0.268	0.002	0.007	0.277	ΣSAR<1.6, Not required
		LTE Band 7	1.108	0.002	0.007	1.117	ΣSAR<1.6, Not required
		LTE Band 12	0.218	0.002	0.007	0.227	ΣSAR<1.6, Not required
		LTE Band 13	0.232	0.002	0.007	0.241	ΣSAR<1.6, Not required
		LTE Band 14	0.236	0.002	0.007	0.245	ΣSAR<1.6, Not required
		LTE Band 25	0.093	0.002	0.007	0.102	ΣSAR<1.6, Not required
		LTE Band 26	0.266	0.002	0.007	0.275	ΣSAR<1.6, Not required
		LTE Band 30	0.920	0.002	0.007	0.929	ΣSAR<1.6, Not required
		LTE Band 41	0.731	0.002	0.007	0.740	ΣSAR<1.6, Not required
		LTE Band 66	0.099	0.002	0.007	0.108	ΣSAR<1.6, Not required

Unless otherwise stated the results shown in this test report refer only to the sample(s) tested and such sample(s) are retained for 90 days only.

除非另有說明，此報告結果僅對測試之樣品負責，同時此樣品僅保留90天。本報告未經本公司書面許可，不可部份複製。

This document is issued by the Company subject to its General Conditions of Service printed overleaf, available on request or accessible at www.sgs.com/terms_and_conditions.htm and for electronic format documents, subject to Terms and Conditions for Electronic Documents at www.sgs.com/terms_e-document.htm. Attention is drawn to the limitation of liability, indemnification and jurisdiction issues defined therein. Any holder of this document is advised that information contained hereon reflects the Company's findings at the time of its intervention only and within the limits of Client's instructions, if any. The Company's sole responsibility is to its Client and this document does not exonerate parties to a transaction from exercising all their rights and obligations under the transaction documents. This document cannot be reproduced except in full, without prior written approval of the Company. Any unauthorized alteration, forgery or falsification of the content or appearance of this document is unlawful and offenders may be prosecuted to the fullest extent of the law.

Left side WWAN + 5G WLAN TX1 + 5G WLAN TX2

No.	Position	Conditions	Max. WWAN	Max. WLAN Tx1	Max. WLAN Tx2	SAR Sum	SPLSR
22	Left side	WCDMA Band II	0.233	0.030	0.016	0.279	ΣSAR<1.6, Not required
		WCDMA Band V	0.293	0.030	0.016	0.339	ΣSAR<1.6, Not required
		LTE Band 5	0.268	0.030	0.016	0.314	ΣSAR<1.6, Not required
		LTE Band 7	1.108	0.030	0.016	1.154	ΣSAR<1.6, Not required
		LTE Band 12	0.218	0.030	0.016	0.264	ΣSAR<1.6, Not required
		LTE Band 13	0.232	0.030	0.016	0.278	ΣSAR<1.6, Not required
		LTE Band 14	0.236	0.030	0.016	0.282	ΣSAR<1.6, Not required
		LTE Band 25	0.093	0.030	0.016	0.139	ΣSAR<1.6, Not required
		LTE Band 26	0.266	0.030	0.016	0.312	ΣSAR<1.6, Not required
		LTE Band 30	0.920	0.030	0.016	0.966	ΣSAR<1.6, Not required
		LTE Band 41	0.731	0.030	0.016	0.777	ΣSAR<1.6, Not required
		LTE Band 66	0.099	0.030	0.016	0.145	ΣSAR<1.6, Not required

Unless otherwise stated the results shown in this test report refer only to the sample(s) tested and such sample(s) are retained for 90 days only.

除非另有說明，此報告結果僅對測試之樣品負責，同時此樣品僅保留90天。本報告未經本公司書面許可，不可部份複製。

This document is issued by the Company subject to its General Conditions of Service printed overleaf, available on request or accessible at www.sgs.com/terms_and_conditions.htm and for electronic format documents, subject to Terms and Conditions for Electronic Documents at www.sgs.com/terms_e-document.htm. Attention is drawn to the limitation of liability, indemnification and jurisdiction issues defined therein. Any holder of this document is advised that information contained hereon reflects the Company's findings at the time of its intervention only and within the limits of Client's instructions, if any. The Company's sole responsibility is to its Client and this document does not exonerate parties to a transaction from exercising all their rights and obligations under the transaction documents. This document cannot be reproduced except in full, without prior written approval of the Company. Any unauthorized alteration, forgery or falsification of the content or appearance of this document is unlawful and offenders may be prosecuted to the fullest extent of the law.

Left side WWAN + 2.4G WLAN Tx1 + BT

No.	Position	Conditions	Max. WWAN	Max. WLAN Tx1	BT	SAR Sum	SPLSR
23	Left side	WCDMA Band II	0.233	0.002	0.010	0.245	ΣSAR<1.6, Not required
		WCDMA Band V	0.293	0.002	0.010	0.305	ΣSAR<1.6, Not required
		LTE Band 5	0.268	0.002	0.010	0.280	ΣSAR<1.6, Not required
		LTE Band 7	1.108	0.002	0.010	1.120	ΣSAR<1.6, Not required
		LTE Band 12	0.218	0.002	0.010	0.230	ΣSAR<1.6, Not required
		LTE Band 13	0.232	0.002	0.010	0.244	ΣSAR<1.6, Not required
		LTE Band 14	0.236	0.002	0.010	0.248	ΣSAR<1.6, Not required
		LTE Band 25	0.093	0.002	0.010	0.105	ΣSAR<1.6, Not required
		LTE Band 26	0.266	0.002	0.010	0.278	ΣSAR<1.6, Not required
		LTE Band 30	0.920	0.002	0.010	0.932	ΣSAR<1.6, Not required
		LTE Band 41	0.731	0.002	0.010	0.743	ΣSAR<1.6, Not required
		LTE Band 66	0.099	0.002	0.010	0.111	ΣSAR<1.6, Not required

Unless otherwise stated the results shown in this test report refer only to the sample(s) tested and such sample(s) are retained for 90 days only.

除非另有說明，此報告結果僅對測試之樣品負責，同時此樣品僅保留90天。本報告未經本公司書面許可，不可部份複製。

This document is issued by the Company subject to its General Conditions of Service printed overleaf, available on request or accessible at www.sgs.com/terms_and_conditions.htm and for electronic format documents, subject to Terms and Conditions for Electronic Documents at www.sgs.com/terms_e-document.htm. Attention is drawn to the limitation of liability, indemnification and jurisdiction issues defined therein. Any holder of this document is advised that information contained hereon reflects the Company's findings at the time of its intervention only and within the limits of Client's instructions, if any. The Company's sole responsibility is to its Client and this document does not exonerate parties to a transaction from exercising all their rights and obligations under the transaction documents. This document cannot be reproduced except in full, without prior written approval of the Company. Any unauthorized alteration, forgery or falsification of the content or appearance of this document is unlawful and offenders may be prosecuted to the fullest extent of the law.

Left side WWAN + 5G WLAN Tx1 + BT

No.	Position	Conditions	Max. WWAN	Max. WLAN Tx1	BT	SAR Sum	SPLSR
24	Left side	WCDMA Band II	0.233	0.030	0.010	0.273	ΣSAR<1.6, Not required
		WCDMA Band V	0.293	0.030	0.010	0.333	ΣSAR<1.6, Not required
		LTE Band 5	0.268	0.030	0.010	0.308	ΣSAR<1.6, Not required
		LTE Band 7	1.108	0.030	0.010	1.148	ΣSAR<1.6, Not required
		LTE Band 12	0.218	0.030	0.010	0.258	ΣSAR<1.6, Not required
		LTE Band 13	0.232	0.030	0.010	0.272	ΣSAR<1.6, Not required
		LTE Band 14	0.236	0.030	0.010	0.276	ΣSAR<1.6, Not required
		LTE Band 25	0.093	0.030	0.010	0.133	ΣSAR<1.6, Not required
		LTE Band 26	0.266	0.030	0.010	0.306	ΣSAR<1.6, Not required
		LTE Band 30	0.920	0.030	0.010	0.960	ΣSAR<1.6, Not required
		LTE Band 41	0.731	0.030	0.010	0.771	ΣSAR<1.6, Not required
		LTE Band 66	0.099	0.030	0.010	0.139	ΣSAR<1.6, Not required

Unless otherwise stated the results shown in this test report refer only to the sample(s) tested and such sample(s) are retained for 90 days only.

除非另有說明，此報告結果僅對測試之樣品負責，同時此樣品僅保留90天。本報告未經本公司書面許可，不可部份複製。

This document is issued by the Company subject to its General Conditions of Service printed overleaf, available on request or accessible at www.sgs.com/terms_and_conditions.htm and for electronic format documents, subject to Terms and Conditions for Electronic Documents at www.sgs.com/terms_e-document.htm. Attention is drawn to the limitation of liability, indemnification and jurisdiction issues defined therein. Any holder of this document is advised that information contained hereon reflects the Company's findings at the time of its intervention only and within the limits of Client's instructions, if any. The Company's sole responsibility is to its Client and this document does not exonerate parties to a transaction from exercising all their rights and obligations under the transaction documents. This document cannot be reproduced except in full, without prior written approval of the Company. Any unauthorized alteration, forgery or falsification of the content or appearance of this document is unlawful and offenders may be prosecuted to the fullest extent of the law.

Left side WWAN + 5G WLAN TX1 + 5G WLAN TX2 + BT

No.	Position	Conditions	Max. WWAN	Max. WLAN Tx1	Max. WLAN Tx2	BT	SAR Sum	SPLSR
25	Left side	WCDMA Band II	0.233	0.030	0.016	0.010	0.289	ΣSAR<1.6, Not required
		WCDMA Band V	0.293	0.030	0.016	0.010	0.349	ΣSAR<1.6, Not required
		LTE Band 5	0.268	0.030	0.016	0.010	0.324	ΣSAR<1.6, Not required
		LTE Band 7	1.108	0.030	0.016	0.010	1.164	ΣSAR<1.6, Not required
		LTE Band 12	0.218	0.030	0.016	0.010	0.274	ΣSAR<1.6, Not required
		LTE Band 13	0.232	0.030	0.016	0.010	0.288	ΣSAR<1.6, Not required
		LTE Band 14	0.236	0.030	0.016	0.010	0.292	ΣSAR<1.6, Not required
		LTE Band 25	0.093	0.030	0.016	0.010	0.149	ΣSAR<1.6, Not required
		LTE Band 26	0.266	0.030	0.016	0.010	0.322	ΣSAR<1.6, Not required
		LTE Band 30	0.920	0.030	0.016	0.010	0.976	ΣSAR<1.6, Not required
		LTE Band 41	0.731	0.030	0.016	0.010	0.787	ΣSAR<1.6, Not required
		LTE Band 66	0.099	0.030	0.016	0.010	0.155	ΣSAR<1.6, Not required

Unless otherwise stated the results shown in this test report refer only to the sample(s) tested and such sample(s) are retained for 90 days only.

除非另有說明，此報告結果僅對測試之樣品負責，同時此樣品僅保留90天。本報告未經本公司書面許可，不可部份複製。

This document is issued by the Company subject to its General Conditions of Service printed overleaf, available on request or accessible at www.sgs.com/terms_and_conditions.htm and for electronic format documents, subject to Terms and Conditions for Electronic Documents at www.sgs.com/terms_e-document.htm. Attention is drawn to the limitation of liability, indemnification and jurisdiction issues defined therein. Any holder of this document is advised that information contained hereon reflects the Company's findings at the time of its intervention only and within the limits of Client's instructions, if any. The Company's sole responsibility is to its Client and this document does not exonerate parties to a transaction from exercising all their rights and obligations under the transaction documents. This document cannot be reproduced except in full, without prior written approval of the Company. Any unauthorized alteration, forgery or falsification of the content or appearance of this document is unlawful and offenders may be prosecuted to the fullest extent of the law.

WWAN reduced + WLAN Full

Back side WWAN + 2.4G WLAN TX1 + 2.4G WLAN TX2

No.	Position	Conditions	Max. WWAN	Max. WLAN Tx1	Max. WLAN Tx2	SAR Sum	SPLSR
1	Back side	WCDMA Band II	0.903	0.220	0.192	1.315	Σ SAR<1.6, Not required
		WCDMA Band V	0.502	0.220	0.192	0.914	Σ SAR<1.6, Not required
		LTE Band 5	0.573	0.220	0.192	0.985	Σ SAR<1.6, Not required
		LTE Band 7	0.951	0.220	0.192	1.363	Σ SAR<1.6, Not required
		LTE Band 12	0.670	0.220	0.192	1.082	Σ SAR<1.6, Not required
		LTE Band 13	0.625	0.220	0.192	1.037	Σ SAR<1.6, Not required
		LTE Band 14	0.553	0.220	0.192	0.965	Σ SAR<1.6, Not required
		LTE Band 25	0.984	0.220	0.192	1.396	Σ SAR<1.6, Not required
		LTE Band 26	0.539	0.220	0.192	0.951	Σ SAR<1.6, Not required
		LTE Band 30	0.875	0.220	0.192	1.287	Σ SAR<1.6, Not required
		LTE Band 41	0.688	0.220	0.192	1.100	Σ SAR<1.6, Not required
		LTE Band 66	0.962	0.220	0.192	1.374	Σ SAR<1.6, Not required

Unless otherwise stated the results shown in this test report refer only to the sample(s) tested and such sample(s) are retained for 90 days only.

除非另有說明，此報告結果僅對測試之樣品負責，同時此樣品僅保留90天。本報告未經本公司書面許可，不可部份複製。

This document is issued by the Company subject to its General Conditions of Service printed overleaf, available on request or accessible at www.sgs.com/terms_and_conditions.htm and for electronic format documents, subject to Terms and Conditions for Electronic Documents at www.sgs.com/terms_e-document.htm. Attention is drawn to the limitation of liability, indemnification and jurisdiction issues defined therein. Any holder of this document is advised that information contained hereon reflects the Company's findings at the time of its intervention only and within the limits of Client's instructions, if any. The Company's sole responsibility is to its Client and this document does not exonerate parties to a transaction from exercising all their rights and obligations under the transaction documents. This document cannot be reproduced except in full, without prior written approval of the Company. Any unauthorized alteration, forgery or falsification of the content or appearance of this document is unlawful and offenders may be prosecuted to the fullest extent of the law.

Back side WWAN + 5G WLAN TX1 + 5G WLAN TX2

No.	Position	Conditions	Max. WWAN	Max. WLAN Tx1	Max. WLAN Tx2	SAR Sum	SPLSR
2	Back side	WCDMA Band II	0.903	0.228	0.191	1.322	Σ SAR<1.6, Not required
		WCDMA Band V	0.502	0.228	0.191	0.921	Σ SAR<1.6, Not required
		LTE Band 5	0.573	0.228	0.191	0.992	Σ SAR<1.6, Not required
		LTE Band 7	0.951	0.228	0.191	1.370	Σ SAR<1.6, Not required
		LTE Band 12	0.670	0.228	0.191	1.089	Σ SAR<1.6, Not required
		LTE Band 13	0.625	0.228	0.191	1.044	Σ SAR<1.6, Not required
		LTE Band 14	0.553	0.228	0.191	0.972	Σ SAR<1.6, Not required
		LTE Band 25	0.984	0.228	0.191	1.403	Σ SAR<1.6, Not required
		LTE Band 26	0.539	0.228	0.191	0.958	Σ SAR<1.6, Not required
		LTE Band 30	0.875	0.228	0.191	1.294	Σ SAR<1.6, Not required
		LTE Band 41	0.688	0.228	0.191	1.107	Σ SAR<1.6, Not required
		LTE Band 66	0.962	0.228	0.191	1.381	Σ SAR<1.6, Not required

Unless otherwise stated the results shown in this test report refer only to the sample(s) tested and such sample(s) are retained for 90 days only.

除非另有說明，此報告結果僅對測試之樣品負責，同時此樣品僅保留90天。本報告未經本公司書面許可，不可部份複製。

This document is issued by the Company subject to its General Conditions of Service printed overleaf, available on request or accessible at www.sgs.com/terms_and_conditions.htm and for electronic format documents, subject to Terms and Conditions for Electronic Documents at www.sgs.com/terms_e-document.htm. Attention is drawn to the limitation of liability, indemnification and jurisdiction issues defined therein. Any holder of this document is advised that information contained hereon reflects the Company's findings at the time of its intervention only and within the limits of Client's instructions, if any. The Company's sole responsibility is to its Client and this document does not exonerate parties to a transaction from exercising all their rights and obligations under the transaction documents. This document cannot be reproduced except in full, without prior written approval of the Company. Any unauthorized alteration, forgery or falsification of the content or appearance of this document is unlawful and offenders may be prosecuted to the fullest extent of the law.

Back side WWAN + 2.4G WLAN Tx1 + BT

No.	Position	Conditions	Max. WWAN	Max. WLAN Tx1	BT	SAR Sum	SPLSR
3	Back side	WCDMA Band II	0.903	0.220	0.086	1.209	ΣSAR<1.6, Not required
		WCDMA Band V	0.502	0.220	0.086	0.808	ΣSAR<1.6, Not required
		LTE Band 5	0.573	0.220	0.086	0.879	ΣSAR<1.6, Not required
		LTE Band 7	0.951	0.220	0.086	1.257	ΣSAR<1.6, Not required
		LTE Band 12	0.670	0.220	0.086	0.976	ΣSAR<1.6, Not required
		LTE Band 13	0.625	0.220	0.086	0.931	ΣSAR<1.6, Not required
		LTE Band 14	0.553	0.220	0.086	0.859	ΣSAR<1.6, Not required
		LTE Band 25	0.984	0.220	0.086	1.290	ΣSAR<1.6, Not required
		LTE Band 26	0.539	0.220	0.086	0.845	ΣSAR<1.6, Not required
		LTE Band 30	0.875	0.220	0.086	1.181	ΣSAR<1.6, Not required
		LTE Band 41	0.688	0.220	0.086	0.994	ΣSAR<1.6, Not required
		LTE Band 66	0.962	0.220	0.086	1.268	ΣSAR<1.6, Not required

Unless otherwise stated the results shown in this test report refer only to the sample(s) tested and such sample(s) are retained for 90 days only.

除非另有說明，此報告結果僅對測試之樣品負責，同時此樣品僅保留90天。本報告未經本公司書面許可，不可部份複製。

This document is issued by the Company subject to its General Conditions of Service printed overleaf, available on request or accessible at www.sgs.com/terms_and_conditions.htm and for electronic format documents, subject to Terms and Conditions for Electronic Documents at www.sgs.com/terms_e-document.htm. Attention is drawn to the limitation of liability, indemnification and jurisdiction issues defined therein. Any holder of this document is advised that information contained hereon reflects the Company's findings at the time of its intervention only and within the limits of Client's instructions, if any. The Company's sole responsibility is to its Client and this document does not exonerate parties to a transaction from exercising all their rights and obligations under the transaction documents. This document cannot be reproduced except in full, without prior written approval of the Company. Any unauthorized alteration, forgery or falsification of the content or appearance of this document is unlawful and offenders may be prosecuted to the fullest extent of the law.

Back side WWAN + 5G WLAN Tx1 + BT

No.	Position	Conditions	Max. WWAN	Max. WLAN Tx1	BT	SAR Sum	SPLSR
4	Back side	WCDMA Band II	0.903	0.228	0.086	1.217	ΣSAR<1.6, Not required
		WCDMA Band V	0.502	0.228	0.086	0.816	ΣSAR<1.6, Not required
		LTE Band 5	0.573	0.228	0.086	0.887	ΣSAR<1.6, Not required
		LTE Band 7	0.951	0.228	0.086	1.265	ΣSAR<1.6, Not required
		LTE Band 12	0.670	0.228	0.086	0.984	ΣSAR<1.6, Not required
		LTE Band 13	0.625	0.228	0.086	0.939	ΣSAR<1.6, Not required
		LTE Band 14	0.553	0.228	0.086	0.867	ΣSAR<1.6, Not required
		LTE Band 25	0.984	0.228	0.086	1.298	ΣSAR<1.6, Not required
		LTE Band 26	0.539	0.228	0.086	0.853	ΣSAR<1.6, Not required
		LTE Band 30	0.875	0.228	0.086	1.189	ΣSAR<1.6, Not required
		LTE Band 41	0.688	0.228	0.086	1.002	ΣSAR<1.6, Not required
		LTE Band 66	0.962	0.228	0.086	1.276	ΣSAR<1.6, Not required

Unless otherwise stated the results shown in this test report refer only to the sample(s) tested and such sample(s) are retained for 90 days only.

除非另有說明，此報告結果僅對測試之樣品負責，同時此樣品僅保留90天。本報告未經本公司書面許可，不可部份複製。

This document is issued by the Company subject to its General Conditions of Service printed overleaf, available on request or accessible at www.sgs.com/terms_and_conditions.htm and for electronic format documents, subject to Terms and Conditions for Electronic Documents at www.sgs.com/terms_e-document.htm. Attention is drawn to the limitation of liability, indemnification and jurisdiction issues defined therein. Any holder of this document is advised that information contained hereon reflects the Company's findings at the time of its intervention only and within the limits of Client's instructions, if any. The Company's sole responsibility is to its Client and this document does not exonerate parties to a transaction from exercising all their rights and obligations under the transaction documents. This document cannot be reproduced except in full, without prior written approval of the Company. Any unauthorized alteration, forgery or falsification of the content or appearance of this document is unlawful and offenders may be prosecuted to the fullest extent of the law.

Back side WWAN + 5G WLAN TX1 + 5G WLAN TX2 + BT

No.	Position	Conditions	Max. WWAN	Max. WLAN Tx1	Max. WLAN Tx2	BT	SAR Sum	SPLSR
5	Back side	WCDMA Band II	0.903	0.228	0.191	0.086	1.408	ΣSAR<1.6, Not required
		WCDMA Band V	0.502	0.228	0.191	0.086	1.007	ΣSAR<1.6, Not required
		LTE Band 5	0.573	0.228	0.191	0.086	1.078	ΣSAR<1.6, Not required
		LTE Band 7	0.951	0.228	0.191	0.086	1.456	ΣSAR<1.6, Not required
		LTE Band 12	0.670	0.228	0.191	0.086	1.175	ΣSAR<1.6, Not required
		LTE Band 13	0.625	0.228	0.191	0.086	1.130	ΣSAR<1.6, Not required
		LTE Band 14	0.553	0.228	0.191	0.086	1.058	ΣSAR<1.6, Not required
		LTE Band 25	0.984	0.228	0.191	0.086	1.489	ΣSAR<1.6, Not required
		LTE Band 26	0.539	0.228	0.191	0.086	1.044	ΣSAR<1.6, Not required
		LTE Band 30	0.875	0.228	0.191	0.086	1.380	ΣSAR<1.6, Not required
		LTE Band 41	0.688	0.228	0.191	0.086	1.193	ΣSAR<1.6, Not required
		LTE Band 66	0.962	0.228	0.191	0.086	1.467	ΣSAR<1.6, Not required

Unless otherwise stated the results shown in this test report refer only to the sample(s) tested and such sample(s) are retained for 90 days only.

除非另有說明，此報告結果僅對測試之樣品負責，同時此樣品僅保留90天。本報告未經本公司書面許可，不可部份複製。

This document is issued by the Company subject to its General Conditions of Service printed overleaf, available on request or accessible at www.sgs.com/terms_and_conditions.htm and for electronic format documents, subject to Terms and Conditions for Electronic Documents at www.sgs.com/terms_e-document.htm. Attention is drawn to the limitation of liability, indemnification and jurisdiction issues defined therein. Any holder of this document is advised that information contained hereon reflects the Company's findings at the time of its intervention only and within the limits of Client's instructions, if any. The Company's sole responsibility is to its Client and this document does not exonerate parties to a transaction from exercising all their rights and obligations under the transaction documents. This document cannot be reproduced except in full, without prior written approval of the Company. Any unauthorized alteration, forgery or falsification of the content or appearance of this document is unlawful and offenders may be prosecuted to the fullest extent of the law.

Top side WWAN + 2.4G WLAN TX1 + 2.4G WLAN TX2

No.	Position	Conditions	Max. WWAN	Max. WLAN Tx1	Max. WLAN Tx2	SAR Sum	SPLSR
6	Top side	WCDMA Band II	0.452	0.032	0.027	0.511	ΣSAR<1.6, Not required
		WCDMA Band V	0.887	0.032	0.027	0.946	ΣSAR<1.6, Not required
		LTE Band 5	0.959	0.032	0.027	1.018	ΣSAR<1.6, Not required
		LTE Band 7	0.350	0.032	0.027	0.409	ΣSAR<1.6, Not required
		LTE Band 12	0.762	0.032	0.027	0.821	ΣSAR<1.6, Not required
		LTE Band 13	0.949	0.032	0.027	1.008	ΣSAR<1.6, Not required
		LTE Band 14	0.882	0.032	0.027	0.941	ΣSAR<1.6, Not required
		LTE Band 25	0.480	0.032	0.027	0.539	ΣSAR<1.6, Not required
		LTE Band 26	0.979	0.032	0.027	1.038	ΣSAR<1.6, Not required
		LTE Band 30	0.542	0.032	0.027	0.601	ΣSAR<1.6, Not required
		LTE Band 41	0.115	0.032	0.027	0.174	ΣSAR<1.6, Not required
		LTE Band 66	0.729	0.032	0.027	0.788	ΣSAR<1.6, Not required

Unless otherwise stated the results shown in this test report refer only to the sample(s) tested and such sample(s) are retained for 90 days only.

除非另有說明，此報告結果僅對測試之樣品負責，同時此樣品僅保留90天。本報告未經本公司書面許可，不可部份複製。

This document is issued by the Company subject to its General Conditions of Service printed overleaf, available on request or accessible at www.sgs.com/terms_and_conditions.htm and for electronic format documents, subject to Terms and Conditions for Electronic Documents at www.sgs.com/terms_e-document.htm. Attention is drawn to the limitation of liability, indemnification and jurisdiction issues defined therein. Any holder of this document is advised that information contained hereon reflects the Company's findings at the time of its intervention only and within the limits of Client's instructions, if any. The Company's sole responsibility is to its Client and this document does not exonerate parties to a transaction from exercising all their rights and obligations under the transaction documents. This document cannot be reproduced except in full, without prior written approval of the Company. Any unauthorized alteration, forgery or falsification of the content or appearance of this document is unlawful and offenders may be prosecuted to the fullest extent of the law.

Top side WWAN + 5G WLAN TX1 + 5G WLAN TX2

No.	Position	Conditions	Max. WWAN	Max. WLAN Tx1	Max. WLAN Tx2	SAR Sum	SPLSR
7	Top side	WCDMA Band II	0.452	0.161	0.106	0.719	ΣSAR<1.6, Not required
		WCDMA Band V	0.887	0.161	0.106	1.154	ΣSAR<1.6, Not required
		LTE Band 5	0.959	0.161	0.106	1.226	ΣSAR<1.6, Not required
		LTE Band 7	0.350	0.161	0.106	0.617	ΣSAR<1.6, Not required
		LTE Band 12	0.762	0.161	0.106	1.029	ΣSAR<1.6, Not required
		LTE Band 13	0.949	0.161	0.106	1.216	ΣSAR<1.6, Not required
		LTE Band 14	0.882	0.161	0.106	1.149	ΣSAR<1.6, Not required
		LTE Band 25	0.480	0.161	0.106	0.747	ΣSAR<1.6, Not required
		LTE Band 26	0.979	0.161	0.106	1.246	ΣSAR<1.6, Not required
		LTE Band 30	0.542	0.161	0.106	0.809	ΣSAR<1.6, Not required
		LTE Band 41	0.115	0.161	0.106	0.382	ΣSAR<1.6, Not required
		LTE Band 66	0.729	0.161	0.106	0.996	ΣSAR<1.6, Not required

Unless otherwise stated the results shown in this test report refer only to the sample(s) tested and such sample(s) are retained for 90 days only.
除非另有說明，此報告結果僅對測試之樣品負責，同時此樣品僅保留90天。本報告未經本公司書面許可，不可部份複製。

This document is issued by the Company subject to its General Conditions of Service printed overleaf, available on request or accessible at www.sgs.com/terms_and_conditions.htm and for electronic format documents, subject to Terms and Conditions for Electronic Documents at www.sgs.com/terms_e-document.htm. Attention is drawn to the limitation of liability, indemnification and jurisdiction issues defined therein. Any holder of this document is advised that information contained hereon reflects the Company's findings at the time of its intervention only and within the limits of Client's instructions, if any. The Company's sole responsibility is to its Client and this document does not exonerate parties to a transaction from exercising all their rights and obligations under the transaction documents. This document cannot be reproduced except in full, without prior written approval of the Company. Any unauthorized alteration, forgery or falsification of the content or appearance of this document is unlawful and offenders may be prosecuted to the fullest extent of the law.

Top side WWAN + 2.4G WLAN Tx1 + BT

No.	Position	Conditions	Max. WWAN	Max. WLAN Tx1	BT	SAR Sum	SPLSR
8	Top side	WCDMA Band II	0.452	0.032	0.059	0.543	Σ SAR<1.6, Not required
		WCDMA Band V	0.887	0.032	0.059	0.978	Σ SAR<1.6, Not required
		LTE Band 5	0.959	0.032	0.059	1.050	Σ SAR<1.6, Not required
		LTE Band 7	0.350	0.032	0.059	0.441	Σ SAR<1.6, Not required
		LTE Band 12	0.762	0.032	0.059	0.853	Σ SAR<1.6, Not required
		LTE Band 13	0.949	0.032	0.059	1.040	Σ SAR<1.6, Not required
		LTE Band 14	0.882	0.032	0.059	0.973	Σ SAR<1.6, Not required
		LTE Band 25	0.480	0.032	0.059	0.571	Σ SAR<1.6, Not required
		LTE Band 26	0.979	0.032	0.059	1.070	Σ SAR<1.6, Not required
		LTE Band 30	0.542	0.032	0.059	0.633	Σ SAR<1.6, Not required
		LTE Band 41	0.115	0.032	0.059	0.206	Σ SAR<1.6, Not required
		LTE Band 66	0.729	0.032	0.059	0.820	Σ SAR<1.6, Not required

Unless otherwise stated the results shown in this test report refer only to the sample(s) tested and such sample(s) are retained for 90 days only.

除非另有說明，此報告結果僅對測試之樣品負責，同時此樣品僅保留90天。本報告未經本公司書面許可，不可部份複製。

This document is issued by the Company subject to its General Conditions of Service printed overleaf, available on request or accessible at www.sgs.com/terms_and_conditions.htm and for electronic format documents, subject to Terms and Conditions for Electronic Documents at www.sgs.com/terms_e-document.htm. Attention is drawn to the limitation of liability, indemnification and jurisdiction issues defined therein. Any holder of this document is advised that information contained hereon reflects the Company's findings at the time of its intervention only and within the limits of Client's instructions, if any. The Company's sole responsibility is to its Client and this document does not exonerate parties to a transaction from exercising all their rights and obligations under the transaction documents. This document cannot be reproduced except in full, without prior written approval of the Company. Any unauthorized alteration, forgery or falsification of the content or appearance of this document is unlawful and offenders may be prosecuted to the fullest extent of the law.

Top side WWAN + 5G WLAN Tx1 + BT

No.	Position	Conditions	Max. WWAN	Max. WLAN Tx1	BT	SAR Sum	SPLSR
9	Top side	WCDMA Band II	0.452	0.161	0.059	0.672	ΣSAR<1.6, Not required
		WCDMA Band V	0.887	0.161	0.059	1.107	ΣSAR<1.6, Not required
		LTE Band 5	0.959	0.161	0.059	1.179	ΣSAR<1.6, Not required
		LTE Band 7	0.350	0.161	0.059	0.570	ΣSAR<1.6, Not required
		LTE Band 12	0.762	0.161	0.059	0.982	ΣSAR<1.6, Not required
		LTE Band 13	0.949	0.161	0.059	1.169	ΣSAR<1.6, Not required
		LTE Band 14	0.882	0.161	0.059	1.102	ΣSAR<1.6, Not required
		LTE Band 25	0.480	0.161	0.059	0.700	ΣSAR<1.6, Not required
		LTE Band 26	0.979	0.161	0.059	1.199	ΣSAR<1.6, Not required
		LTE Band 30	0.542	0.161	0.059	0.762	ΣSAR<1.6, Not required
		LTE Band 41	0.115	0.161	0.059	0.335	ΣSAR<1.6, Not required
		LTE Band 66	0.729	0.161	0.059	0.949	ΣSAR<1.6, Not required

Unless otherwise stated the results shown in this test report refer only to the sample(s) tested and such sample(s) are retained for 90 days only.

除非另有說明，此報告結果僅對測試之樣品負責，同時此樣品僅保留90天。本報告未經本公司書面許可，不可部份複製。

This document is issued by the Company subject to its General Conditions of Service printed overleaf, available on request or accessible at www.sgs.com/terms_and_conditions.htm and for electronic format documents, subject to Terms and Conditions for Electronic Documents at www.sgs.com/terms_e-document.htm. Attention is drawn to the limitation of liability, indemnification and jurisdiction issues defined therein. Any holder of this document is advised that information contained hereon reflects the Company's findings at the time of its intervention only and within the limits of Client's instructions, if any. The Company's sole responsibility is to its Client and this document does not exonerate parties to a transaction from exercising all their rights and obligations under the transaction documents. This document cannot be reproduced except in full, without prior written approval of the Company. Any unauthorized alteration, forgery or falsification of the content or appearance of this document is unlawful and offenders may be prosecuted to the fullest extent of the law.

Top side WWAN + 5G WLAN TX1 + 5G WLAN TX2 + BT

No.	Position	Conditions	Max. WWAN	Max. WLAN Tx1	Max. WLAN Tx2	BT	SAR Sum	SPLSR
10	Top side	WCDMA Band II	0.452	0.161	0.106	0.059	0.778	ΣSAR<1.6, Not required
		WCDMA Band V	0.887	0.161	0.106	0.059	1.213	ΣSAR<1.6, Not required
		LTE Band 5	0.959	0.161	0.106	0.059	1.285	ΣSAR<1.6, Not required
		LTE Band 7	0.350	0.161	0.106	0.059	0.676	ΣSAR<1.6, Not required
		LTE Band 12	0.762	0.161	0.106	0.059	1.088	ΣSAR<1.6, Not required
		LTE Band 13	0.949	0.161	0.106	0.059	1.275	ΣSAR<1.6, Not required
		LTE Band 14	0.882	0.161	0.106	0.059	1.208	ΣSAR<1.6, Not required
		LTE Band 25	0.480	0.161	0.106	0.059	0.806	ΣSAR<1.6, Not required
		LTE Band 26	0.979	0.161	0.106	0.059	1.305	ΣSAR<1.6, Not required
		LTE Band 30	0.542	0.161	0.106	0.059	0.868	ΣSAR<1.6, Not required
		LTE Band 41	0.115	0.161	0.106	0.059	0.441	ΣSAR<1.6, Not required
		LTE Band 66	0.729	0.161	0.106	0.059	1.055	ΣSAR<1.6, Not required

Unless otherwise stated the results shown in this test report refer only to the sample(s) tested and such sample(s) are retained for 90 days only.

除非另有說明，此報告結果僅對測試之樣品負責，同時此樣品僅保留90天。本報告未經本公司書面許可，不可部份複製。

This document is issued by the Company subject to its General Conditions of Service printed overleaf, available on request or accessible at www.sgs.com/terms_and_conditions.htm and for electronic format documents, subject to Terms and Conditions for Electronic Documents at www.sgs.com/terms_e-document.htm. Attention is drawn to the limitation of liability, indemnification and jurisdiction issues defined therein. Any holder of this document is advised that information contained hereon reflects the Company's findings at the time of its intervention only and within the limits of Client's instructions, if any. The Company's sole responsibility is to its Client and this document does not exonerate parties to a transaction from exercising all their rights and obligations under the transaction documents. This document cannot be reproduced except in full, without prior written approval of the Company. Any unauthorized alteration, forgery or falsification of the content or appearance of this document is unlawful and offenders may be prosecuted to the fullest extent of the law.

WWAN Full + WLAN reduced
Back side WWAN + 2.4G WLAN TX1 + 2.4G WLAN TX2

No.	Position	Conditions	Max. WWAN	Max. WLAN Tx1*	Max. WLAN Tx2	SAR Sum	SPLSR
1	Back side	WCDMA Band II	0.596	0.220	0.210	1.026	Σ SAR<1.6, Not required
		WCDMA Band V	0.212	0.220	0.210	0.642	Σ SAR<1.6, Not required
		LTE Band 5	0.210	0.220	0.210	0.640	Σ SAR<1.6, Not required
		LTE Band 7	0.473	0.220	0.210	0.903	Σ SAR<1.6, Not required
		LTE Band 12	0.212	0.220	0.210	0.642	Σ SAR<1.6, Not required
		LTE Band 13	0.193	0.220	0.210	0.623	Σ SAR<1.6, Not required
		LTE Band 14	0.190	0.220	0.210	0.620	Σ SAR<1.6, Not required
		LTE Band 25	0.517	0.220	0.210	0.947	Σ SAR<1.6, Not required
		LTE Band 26	0.215	0.220	0.210	0.645	Σ SAR<1.6, Not required
		LTE Band 30	0.398	0.220	0.210	0.828	Σ SAR<1.6, Not required
		LTE Band 41	0.253	0.220	0.210	0.683	Σ SAR<1.6, Not required
LTE Band 66	0.490	0.220	0.210	0.920	Σ SAR<1.6, Not required		

*Using WLAN TX1 back side full power SAR value to evaluate the simultaneous SAR to be the conservative evaluation.

Unless otherwise stated the results shown in this test report refer only to the sample(s) tested and such sample(s) are retained for 90 days only.

除非另有說明，此報告結果僅對測試之樣品負責，同時此樣品僅保留90天。本報告未經本公司書面許可，不可部份複製。

This document is issued by the Company subject to its General Conditions of Service printed overleaf, available on request or accessible at www.sgs.com/terms_and_conditions.htm and for electronic format documents, subject to Terms and Conditions for Electronic Documents at www.sgs.com/terms_e-document.htm. Attention is drawn to the limitation of liability, indemnification and jurisdiction issues defined therein. Any holder of this document is advised that information contained hereon reflects the Company's findings at the time of its intervention only and within the limits of Client's instructions, if any. The Company's sole responsibility is to its Client and this document does not exonerate parties to a transaction from exercising all their rights and obligations under the transaction documents. This document cannot be reproduced except in full, without prior written approval of the Company. Any unauthorized alteration, forgery or falsification of the content or appearance of this document is unlawful and offenders may be prosecuted to the fullest extent of the law.

Back side WWAN + 5G WLAN TX1 + 5G WLAN TX2

No.	Position	Conditions	Max. WWAN	Max. WLAN Tx1*	Max. WLAN Tx2	SAR Sum	SPLSR
2	Back side	WCDMA Band II	0.596	0.228	0.253	1.077	ΣSAR<1.6, Not required
		WCDMA Band V	0.212	0.228	0.253	0.693	ΣSAR<1.6, Not required
		LTE Band 5	0.210	0.228	0.253	0.691	ΣSAR<1.6, Not required
		LTE Band 7	0.473	0.228	0.253	0.954	ΣSAR<1.6, Not required
		LTE Band 12	0.212	0.228	0.253	0.693	ΣSAR<1.6, Not required
		LTE Band 13	0.193	0.228	0.253	0.674	ΣSAR<1.6, Not required
		LTE Band 14	0.190	0.228	0.253	0.671	ΣSAR<1.6, Not required
		LTE Band 25	0.517	0.228	0.253	0.998	ΣSAR<1.6, Not required
		LTE Band 26	0.215	0.228	0.253	0.696	ΣSAR<1.6, Not required
		LTE Band 30	0.398	0.228	0.253	0.879	ΣSAR<1.6, Not required
		LTE Band 41	0.253	0.228	0.253	0.734	ΣSAR<1.6, Not required
		LTE Band 66	0.490	0.228	0.253	0.971	ΣSAR<1.6, Not required

*Using WLAN TX1 back side full power SAR value to evaluate the simultaneous SAR to be the conservative evaluation.

Unless otherwise stated the results shown in this test report refer only to the sample(s) tested and such sample(s) are retained for 90 days only.
除非另有說明，此報告結果僅對測試之樣品負責，同時此樣品僅保留90天。本報告未經本公司書面許可，不可部份複製。

This document is issued by the Company subject to its General Conditions of Service printed overleaf, available on request or accessible at www.sgs.com/terms_and_conditions.htm and for electronic format documents, subject to Terms and Conditions for Electronic Documents at www.sgs.com/terms_e-document.htm. Attention is drawn to the limitation of liability, indemnification and jurisdiction issues defined therein. Any holder of this document is advised that information contained hereon reflects the Company's findings at the time of its intervention only and within the limits of Client's instructions, if any. The Company's sole responsibility is to its Client and this document does not exonerate parties to a transaction from exercising all their rights and obligations under the transaction documents. This document cannot be reproduced except in full, without prior written approval of the Company. Any unauthorized alteration, forgery or falsification of the content or appearance of this document is unlawful and offenders may be prosecuted to the fullest extent of the law.

Back side WWAN + 2.4G WLAN Tx1 + BT

No.	Position	Conditions	Max. WWAN	Max. WLAN Tx1*	BT	SAR Sum	SPLSR
3	Back side	WCDMA Band II	0.596	0.220	0.086	0.902	ΣSAR<1.6, Not required
		WCDMA Band V	0.212	0.220	0.086	0.518	ΣSAR<1.6, Not required
		LTE Band 5	0.210	0.220	0.086	0.516	ΣSAR<1.6, Not required
		LTE Band 7	0.473	0.220	0.086	0.779	ΣSAR<1.6, Not required
		LTE Band 12	0.212	0.220	0.086	0.518	ΣSAR<1.6, Not required
		LTE Band 13	0.193	0.220	0.086	0.499	ΣSAR<1.6, Not required
		LTE Band 14	0.190	0.220	0.086	0.496	ΣSAR<1.6, Not required
		LTE Band 25	0.517	0.220	0.086	0.823	ΣSAR<1.6, Not required
		LTE Band 26	0.215	0.220	0.086	0.521	ΣSAR<1.6, Not required
		LTE Band 30	0.398	0.220	0.086	0.704	ΣSAR<1.6, Not required
		LTE Band 41	0.253	0.220	0.086	0.559	ΣSAR<1.6, Not required
		LTE Band 66	0.490	0.220	0.086	0.796	ΣSAR<1.6, Not required

*Using WLAN TX1 back side full power SAR value to evaluate the simultaneous SAR to be the conservative evaluation.

Unless otherwise stated the results shown in this test report refer only to the sample(s) tested and such sample(s) are retained for 90 days only.
除非另有說明，此報告結果僅對測試之樣品負責，同時此樣品僅保留90天。本報告未經本公司書面許可，不可部份複製。

This document is issued by the Company subject to its General Conditions of Service printed overleaf, available on request or accessible at www.sgs.com/terms_and_conditions.htm and for electronic format documents, subject to Terms and Conditions for Electronic Documents at www.sgs.com/terms_e-document.htm. Attention is drawn to the limitation of liability, indemnification and jurisdiction issues defined therein. Any holder of this document is advised that information contained hereon reflects the Company's findings at the time of its intervention only and within the limits of Client's instructions, if any. The Company's sole responsibility is to its Client and this document does not exonerate parties to a transaction from exercising all their rights and obligations under the transaction documents. This document cannot be reproduced except in full, without prior written approval of the Company. Any unauthorized alteration, forgery or falsification of the content or appearance of this document is unlawful and offenders may be prosecuted to the fullest extent of the law.

Back side WWAN + 5G WLAN TX1 + BT

No.	Position	Conditions	Max. WWAN	Max. WLAN Tx1*	BT	SAR Sum	SPLSR
4	Back side	WCDMA Band II	0.596	0.228	0.086	0.910	ΣSAR<1.6, Not required
		WCDMA Band V	0.212	0.228	0.086	0.526	ΣSAR<1.6, Not required
		LTE Band 5	0.210	0.228	0.086	0.524	ΣSAR<1.6, Not required
		LTE Band 7	0.473	0.228	0.086	0.787	ΣSAR<1.6, Not required
		LTE Band 12	0.212	0.228	0.086	0.526	ΣSAR<1.6, Not required
		LTE Band 13	0.193	0.228	0.086	0.507	ΣSAR<1.6, Not required
		LTE Band 14	0.190	0.228	0.086	0.504	ΣSAR<1.6, Not required
		LTE Band 25	0.517	0.228	0.086	0.831	ΣSAR<1.6, Not required
		LTE Band 26	0.215	0.228	0.086	0.529	ΣSAR<1.6, Not required
		LTE Band 30	0.398	0.228	0.086	0.712	ΣSAR<1.6, Not required
		LTE Band 41	0.253	0.228	0.086	0.567	ΣSAR<1.6, Not required
		LTE Band 66	0.490	0.228	0.086	0.804	ΣSAR<1.6, Not required

*Using WLAN TX1 back side full power SAR value to evaluate the simultaneous SAR to be the conservative evaluation.

Unless otherwise stated the results shown in this test report refer only to the sample(s) tested and such sample(s) are retained for 90 days only.
除非另有說明，此報告結果僅對測試之樣品負責，同時此樣品僅保留90天。本報告未經本公司書面許可，不可部份複製。

This document is issued by the Company subject to its General Conditions of Service printed overleaf, available on request or accessible at www.sgs.com/terms_and_conditions.htm and for electronic format documents, subject to Terms and Conditions for Electronic Documents at www.sgs.com/terms_e-document.htm. Attention is drawn to the limitation of liability, indemnification and jurisdiction issues defined therein. Any holder of this document is advised that information contained hereon reflects the Company's findings at the time of its intervention only and within the limits of Client's instructions, if any. The Company's sole responsibility is to its Client and this document does not exonerate parties to a transaction from exercising all their rights and obligations under the transaction documents. This document cannot be reproduced except in full, without prior written approval of the Company. Any unauthorized alteration, forgery or falsification of the content or appearance of this document is unlawful and offenders may be prosecuted to the fullest extent of the law.

Back side WWAN + 5G WLAN TX1 + 5G WLAN TX2 + BT

No.	Position	Conditions	Max. WWAN	Max. WLAN Tx1*	Max. WLAN Tx2	BT	SAR Sum	SPLSR
5	Back side	WCDMA Band II	0.596	0.228	0.253	0.086	1.163	ΣSAR<1.6, Not required
		WCDMA Band V	0.212	0.228	0.253	0.086	0.779	ΣSAR<1.6, Not required
		LTE Band 5	0.210	0.228	0.253	0.086	0.777	ΣSAR<1.6, Not required
		LTE Band 7	0.473	0.228	0.253	0.086	1.040	ΣSAR<1.6, Not required
		LTE Band 12	0.212	0.228	0.253	0.086	0.779	ΣSAR<1.6, Not required
		LTE Band 13	0.193	0.228	0.253	0.086	0.760	ΣSAR<1.6, Not required
		LTE Band 14	0.190	0.228	0.253	0.086	0.757	ΣSAR<1.6, Not required
		LTE Band 25	0.517	0.228	0.253	0.086	1.084	ΣSAR<1.6, Not required
		LTE Band 26	0.215	0.228	0.253	0.086	0.782	ΣSAR<1.6, Not required
		LTE Band 30	0.398	0.228	0.253	0.086	0.965	ΣSAR<1.6, Not required
		LTE Band 41	0.253	0.228	0.253	0.086	0.820	ΣSAR<1.6, Not required
		LTE Band 66	0.490	0.228	0.253	0.086	1.057	ΣSAR<1.6, Not required

*Using WLAN TX1 back side full power SAR value to evaluate the simultaneous SAR to be the conservative evaluation.

Unless otherwise stated the results shown in this test report refer only to the sample(s) tested and such sample(s) are retained for 90 days only.

除非另有說明，此報告結果僅對測試之樣品負責，同時此樣品僅保留90天。本報告未經本公司書面許可，不可部份複製。

This document is issued by the Company subject to its General Conditions of Service printed overleaf, available on request or accessible at www.sgs.com/terms_and_conditions.htm and for electronic format documents, subject to Terms and Conditions for Electronic Documents at www.sgs.com/terms_e-document.htm. Attention is drawn to the limitation of liability, indemnification and jurisdiction issues defined therein. Any holder of this document is advised that information contained hereon reflects the Company's findings at the time of its intervention only and within the limits of Client's instructions, if any. The Company's sole responsibility is to its Client and this document does not exonerate parties to a transaction from exercising all their rights and obligations under the transaction documents. This document cannot be reproduced except in full, without prior written approval of the Company. Any unauthorized alteration, forgery or falsification of the content or appearance of this document is unlawful and offenders may be prosecuted to the fullest extent of the law.

Top side WWAN + 2.4G WLAN TX1 + 2.4G WLAN TX2

No.	Position	Conditions	Max. WWAN	Max. WLAN Tx1	Max. WLAN Tx2	SAR Sum	SPLSR
6	Top side	WCDMA Band II	0.660	0.062	0.059	0.781	ΣSAR<1.6, Not required
		WCDMA Band V	0.133	0.062	0.059	0.254	ΣSAR<1.6, Not required
		LTE Band 5	0.142	0.062	0.059	0.263	ΣSAR<1.6, Not required
		LTE Band 7	0.281	0.062	0.059	0.402	ΣSAR<1.6, Not required
		LTE Band 12	0.126	0.062	0.059	0.247	ΣSAR<1.6, Not required
		LTE Band 13	0.117	0.062	0.059	0.238	ΣSAR<1.6, Not required
		LTE Band 14	0.118	0.062	0.059	0.239	ΣSAR<1.6, Not required
		LTE Band 25	0.639	0.062	0.059	0.760	ΣSAR<1.6, Not required
		LTE Band 26	0.162	0.062	0.059	0.283	ΣSAR<1.6, Not required
		LTE Band 30	0.312	0.062	0.059	0.433	ΣSAR<1.6, Not required
		LTE Band 41	0.125	0.062	0.059	0.246	ΣSAR<1.6, Not required
		LTE Band 66	0.845	0.062	0.059	0.966	ΣSAR<1.6, Not required

Unless otherwise stated the results shown in this test report refer only to the sample(s) tested and such sample(s) are retained for 90 days only.

除非另有說明，此報告結果僅對測試之樣品負責，同時此樣品僅保留90天。本報告未經本公司書面許可，不可部份複製。

This document is issued by the Company subject to its General Conditions of Service printed overleaf, available on request or accessible at www.sgs.com/terms_and_conditions.htm and for electronic format documents, subject to Terms and Conditions for Electronic Documents at www.sgs.com/terms_e-document.htm. Attention is drawn to the limitation of liability, indemnification and jurisdiction issues defined therein. Any holder of this document is advised that information contained hereon reflects the Company's findings at the time of its intervention only and within the limits of Client's instructions, if any. The Company's sole responsibility is to its Client and this document does not exonerate parties to a transaction from exercising all their rights and obligations under the transaction documents. This document cannot be reproduced except in full, without prior written approval of the Company. Any unauthorized alteration, forgery or falsification of the content or appearance of this document is unlawful and offenders may be prosecuted to the fullest extent of the law.

Top side WWAN + 5G WLAN TX1 + 5G WLAN TX2

No.	Position	Conditions	Max. WWAN	Max. WLAN Tx1	Max. WLAN Tx2	SAR Sum	SPLSR
7	Top side	WCDMA Band II	0.660	0.226	0.159	1.045	ΣSAR<1.6, Not required
		WCDMA Band V	0.133	0.226	0.159	0.518	ΣSAR<1.6, Not required
		LTE Band 5	0.142	0.226	0.159	0.527	ΣSAR<1.6, Not required
		LTE Band 7	0.281	0.226	0.159	0.666	ΣSAR<1.6, Not required
		LTE Band 12	0.126	0.226	0.159	0.511	ΣSAR<1.6, Not required
		LTE Band 13	0.117	0.226	0.159	0.502	ΣSAR<1.6, Not required
		LTE Band 14	0.118	0.226	0.159	0.503	ΣSAR<1.6, Not required
		LTE Band 25	0.639	0.226	0.159	1.024	ΣSAR<1.6, Not required
		LTE Band 26	0.162	0.226	0.159	0.547	ΣSAR<1.6, Not required
		LTE Band 30	0.312	0.226	0.159	0.697	ΣSAR<1.6, Not required
		LTE Band 41	0.125	0.226	0.159	0.510	ΣSAR<1.6, Not required
		LTE Band 66	0.845	0.226	0.159	1.230	ΣSAR<1.6, Not required

Unless otherwise stated the results shown in this test report refer only to the sample(s) tested and such sample(s) are retained for 90 days only.

除非另有說明，此報告結果僅對測試之樣品負責，同時此樣品僅保留90天。本報告未經本公司書面許可，不可部份複製。

This document is issued by the Company subject to its General Conditions of Service printed overleaf, available on request or accessible at www.sgs.com/terms_and_conditions.htm and for electronic format documents, subject to Terms and Conditions for Electronic Documents at www.sgs.com/terms_e-document.htm. Attention is drawn to the limitation of liability, indemnification and jurisdiction issues defined therein. Any holder of this document is advised that information contained hereon reflects the Company's findings at the time of its intervention only and within the limits of Client's instructions, if any. The Company's sole responsibility is to its Client and this document does not exonerate parties to a transaction from exercising all their rights and obligations under the transaction documents. This document cannot be reproduced except in full, without prior written approval of the Company. Any unauthorized alteration, forgery or falsification of the content or appearance of this document is unlawful and offenders may be prosecuted to the fullest extent of the law.

Top side WWAN + 2.4G WLAN Tx1 + BT

No.	Position	Conditions	Max. WWAN	Max. WLAN Tx1	BT	SAR Sum	SPLSR
8	Top side	WCDMA Band II	0.660	0.062	0.059	0.781	ΣSAR<1.6, Not required
		WCDMA Band V	0.133	0.062	0.059	0.254	ΣSAR<1.6, Not required
		LTE Band 5	0.142	0.062	0.059	0.263	ΣSAR<1.6, Not required
		LTE Band 7	0.281	0.062	0.059	0.402	ΣSAR<1.6, Not required
		LTE Band 12	0.126	0.062	0.059	0.247	ΣSAR<1.6, Not required
		LTE Band 13	0.117	0.062	0.059	0.238	ΣSAR<1.6, Not required
		LTE Band 14	0.118	0.062	0.059	0.239	ΣSAR<1.6, Not required
		LTE Band 25	0.639	0.062	0.059	0.760	ΣSAR<1.6, Not required
		LTE Band 26	0.162	0.062	0.059	0.283	ΣSAR<1.6, Not required
		LTE Band 30	0.312	0.062	0.059	0.433	ΣSAR<1.6, Not required
		LTE Band 41	0.125	0.062	0.059	0.246	ΣSAR<1.6, Not required
		LTE Band 66	0.845	0.062	0.059	0.966	ΣSAR<1.6, Not required

Unless otherwise stated the results shown in this test report refer only to the sample(s) tested and such sample(s) are retained for 90 days only.

除非另有說明，此報告結果僅對測試之樣品負責，同時此樣品僅保留90天。本報告未經本公司書面許可，不可部份複製。

This document is issued by the Company subject to its General Conditions of Service printed overleaf, available on request or accessible at www.sgs.com/terms_and_conditions.htm and for electronic format documents, subject to Terms and Conditions for Electronic Documents at www.sgs.com/terms_e-document.htm. Attention is drawn to the limitation of liability, indemnification and jurisdiction issues defined therein. Any holder of this document is advised that information contained hereon reflects the Company's findings at the time of its intervention only and within the limits of Client's instructions, if any. The Company's sole responsibility is to its Client and this document does not exonerate parties to a transaction from exercising all their rights and obligations under the transaction documents. This document cannot be reproduced except in full, without prior written approval of the Company. Any unauthorized alteration, forgery or falsification of the content or appearance of this document is unlawful and offenders may be prosecuted to the fullest extent of the law.

Top side WWAN + 5G WLAN Tx1 + BT

No.	Position	Conditions	Max. WWAN	Max. WLAN Tx1	BT	SAR Sum	SPLSR
9	Top side	WCDMA Band II	0.660	0.226	0.059	0.945	ΣSAR<1.6, Not required
		WCDMA Band V	0.133	0.226	0.059	0.418	ΣSAR<1.6, Not required
		LTE Band 5	0.142	0.226	0.059	0.427	ΣSAR<1.6, Not required
		LTE Band 7	0.281	0.226	0.059	0.566	ΣSAR<1.6, Not required
		LTE Band 12	0.126	0.226	0.059	0.411	ΣSAR<1.6, Not required
		LTE Band 13	0.117	0.226	0.059	0.402	ΣSAR<1.6, Not required
		LTE Band 14	0.118	0.226	0.059	0.403	ΣSAR<1.6, Not required
		LTE Band 25	0.639	0.226	0.059	0.924	ΣSAR<1.6, Not required
		LTE Band 26	0.162	0.226	0.059	0.447	ΣSAR<1.6, Not required
		LTE Band 30	0.312	0.226	0.059	0.597	ΣSAR<1.6, Not required
		LTE Band 41	0.125	0.226	0.059	0.410	ΣSAR<1.6, Not required
		LTE Band 66	0.845	0.226	0.059	1.130	ΣSAR<1.6, Not required

Unless otherwise stated the results shown in this test report refer only to the sample(s) tested and such sample(s) are retained for 90 days only.

除非另有說明，此報告結果僅對測試之樣品負責，同時此樣品僅保留90天。本報告未經本公司書面許可，不可部份複製。

This document is issued by the Company subject to its General Conditions of Service printed overleaf, available on request or accessible at www.sgs.com/terms_and_conditions.htm and for electronic format documents, subject to Terms and Conditions for Electronic Documents at www.sgs.com/terms_e-document.htm. Attention is drawn to the limitation of liability, indemnification and jurisdiction issues defined therein. Any holder of this document is advised that information contained hereon reflects the Company's findings at the time of its intervention only and within the limits of Client's instructions, if any. The Company's sole responsibility is to its Client and this document does not exonerate parties to a transaction from exercising all their rights and obligations under the transaction documents. This document cannot be reproduced except in full, without prior written approval of the Company. Any unauthorized alteration, forgery or falsification of the content or appearance of this document is unlawful and offenders may be prosecuted to the fullest extent of the law.

Top side WWAN + 5G WLAN TX1 + 5G WLAN TX2 + BT

No.	Position	Conditions	Max. WWAN	Max. WLAN Tx1	Max. WLAN Tx2	BT	SAR Sum	SPLSR
10	Top side	WCDMA Band II	0.660	0.226	0.159	0.059	1.104	ΣSAR<1.6, Not required
		WCDMA Band V	0.133	0.226	0.159	0.059	0.577	ΣSAR<1.6, Not required
		LTE Band 5	0.142	0.226	0.159	0.059	0.586	ΣSAR<1.6, Not required
		LTE Band 7	0.281	0.226	0.159	0.059	0.725	ΣSAR<1.6, Not required
		LTE Band 12	0.126	0.226	0.159	0.059	0.570	ΣSAR<1.6, Not required
		LTE Band 13	0.117	0.226	0.159	0.059	0.561	ΣSAR<1.6, Not required
		LTE Band 14	0.118	0.226	0.159	0.059	0.562	ΣSAR<1.6, Not required
		LTE Band 25	0.639	0.226	0.159	0.059	1.083	ΣSAR<1.6, Not required
		LTE Band 26	0.162	0.226	0.159	0.059	0.606	ΣSAR<1.6, Not required
		LTE Band 30	0.312	0.226	0.159	0.059	0.756	ΣSAR<1.6, Not required
		LTE Band 41	0.125	0.226	0.159	0.059	0.569	ΣSAR<1.6, Not required
		LTE Band 66	0.845	0.226	0.159	0.059	1.289	ΣSAR<1.6, Not required

Unless otherwise stated the results shown in this test report refer only to the sample(s) tested and such sample(s) are retained for 90 days only.

除非另有說明，此報告結果僅對測試之樣品負責，同時此樣品僅保留90天。本報告未經本公司書面許可，不可部份複製。

This document is issued by the Company subject to its General Conditions of Service printed overleaf, available on request or accessible at www.sgs.com/terms_and_conditions.htm and for electronic format documents, subject to Terms and Conditions for Electronic Documents at www.sgs.com/terms_e-document.htm. Attention is drawn to the limitation of liability, indemnification and jurisdiction issues defined therein. Any holder of this document is advised that information contained hereon reflects the Company's findings at the time of its intervention only and within the limits of Client's instructions, if any. The Company's sole responsibility is to its Client and this document does not exonerate parties to a transaction from exercising all their rights and obligations under the transaction documents. This document cannot be reproduced except in full, without prior written approval of the Company. Any unauthorized alteration, forgery or falsification of the content or appearance of this document is unlawful and offenders may be prosecuted to the fullest extent of the law.

WWAN reduced + WLAN reduced

Back side WWAN + 2.4G WLAN TX1 + 2.4G WLAN TX2

No.	Position	Conditions	Max. WWAN	Max. WLAN Tx1*	Max. WLAN Tx2	SAR Sum	SPLSR
1	Back side	WCDMA Band II	0.903	0.220	0.210	1.333	ΣSAR<1.6, Not required
		WCDMA Band V	0.502	0.220	0.210	0.932	ΣSAR<1.6, Not required
		LTE Band 5	0.573	0.220	0.210	1.003	ΣSAR<1.6, Not required
		LTE Band 7	0.951	0.220	0.210	1.381	ΣSAR<1.6, Not required
		LTE Band 12	0.670	0.220	0.210	1.100	ΣSAR<1.6, Not required
		LTE Band 13	0.625	0.220	0.210	1.055	ΣSAR<1.6, Not required
		LTE Band 14	0.553	0.220	0.210	0.983	ΣSAR<1.6, Not required
		LTE Band 25	0.984	0.220	0.210	1.414	ΣSAR<1.6, Not required
		LTE Band 26	0.539	0.220	0.210	0.969	ΣSAR<1.6, Not required
		LTE Band 30	0.875	0.220	0.210	1.305	ΣSAR<1.6, Not required
		LTE Band 41	0.688	0.220	0.210	1.118	ΣSAR<1.6, Not required
		LTE Band 66	0.962	0.220	0.210	1.392	ΣSAR<1.6, Not required

*Using WLAN TX1 back side full power SAR value to evaluate the simultaneous SAR to be the conservative evaluation.

Unless otherwise stated the results shown in this test report refer only to the sample(s) tested and such sample(s) are retained for 90 days only.

除非另有說明，此報告結果僅對測試之樣品負責，同時此樣品僅保留90天。本報告未經本公司書面許可，不可部份複製。

This document is issued by the Company subject to its General Conditions of Service printed overleaf, available on request or accessible at www.sgs.com/terms_and_conditions.htm and for electronic format documents, subject to Terms and Conditions for Electronic Documents at www.sgs.com/terms_e-document.htm. Attention is drawn to the limitation of liability, indemnification and jurisdiction issues defined therein. Any holder of this document is advised that information contained hereon reflects the Company's findings at the time of its intervention only and within the limits of Client's instructions, if any. The Company's sole responsibility is to its Client and this document does not exonerate parties to a transaction from exercising all their rights and obligations under the transaction documents. This document cannot be reproduced except in full, without prior written approval of the Company. Any unauthorized alteration, forgery or falsification of the content or appearance of this document is unlawful and offenders may be prosecuted to the fullest extent of the law.

Back side WWAN + 5G WLAN TX1 + 5G WLAN TX2

No.	Position	Conditions	Max. WWAN	Max. WLAN Tx1*	Max. WLAN Tx2	SAR Sum	SPLSR
2	Back side	WCDMA Band II	0.903	0.228	0.253	1.384	ΣSAR<1.6, Not required
		WCDMA Band V	0.502	0.228	0.253	0.983	ΣSAR<1.6, Not required
		LTE Band 5	0.573	0.228	0.253	1.054	ΣSAR<1.6, Not required
		LTE Band 7	0.951	0.228	0.253	1.432	ΣSAR<1.6, Not required
		LTE Band 12	0.670	0.228	0.253	1.151	ΣSAR<1.6, Not required
		LTE Band 13	0.625	0.228	0.253	1.106	ΣSAR<1.6, Not required
		LTE Band 14	0.553	0.228	0.253	1.034	ΣSAR<1.6, Not required
		LTE Band 25	0.984	0.228	0.253	1.465	ΣSAR<1.6, Not required
		LTE Band 26	0.539	0.228	0.253	1.020	ΣSAR<1.6, Not required
		LTE Band 30	0.875	0.228	0.253	1.356	ΣSAR<1.6, Not required
		LTE Band 41	0.688	0.228	0.253	1.169	ΣSAR<1.6, Not required
		LTE Band 66	0.962	0.228	0.253	1.443	ΣSAR<1.6, Not required

*Using WLAN TX1 back side full power SAR value to evaluate the simultaneous SAR to be the conservative evaluation.

Unless otherwise stated the results shown in this test report refer only to the sample(s) tested and such sample(s) are retained for 90 days only.

除非另有說明，此報告結果僅對測試之樣品負責，同時此樣品僅保留90天。本報告未經本公司書面許可，不可部份複製。

This document is issued by the Company subject to its General Conditions of Service printed overleaf, available on request or accessible at www.sgs.com/terms_and_conditions.htm and for electronic format documents, subject to Terms and Conditions for Electronic Documents at www.sgs.com/terms_e-document.htm. Attention is drawn to the limitation of liability, indemnification and jurisdiction issues defined therein. Any holder of this document is advised that information contained hereon reflects the Company's findings at the time of its intervention only and within the limits of Client's instructions, if any. The Company's sole responsibility is to its Client and this document does not exonerate parties to a transaction from exercising all their rights and obligations under the transaction documents. This document cannot be reproduced except in full, without prior written approval of the Company. Any unauthorized alteration, forgery or falsification of the content or appearance of this document is unlawful and offenders may be prosecuted to the fullest extent of the law.

Back side WWAN + 2.4G WLAN Tx1 + BT

No.	Position	Conditions	Max. WWAN	Max. WLAN Tx1*	BT	SAR Sum	SPLSR
3	Back side	WCDMA Band II	0.903	0.220	0.086	1.209	Σ SAR<1.6, Not required
		WCDMA Band V	0.502	0.220	0.086	0.808	Σ SAR<1.6, Not required
		LTE Band 5	0.573	0.220	0.086	0.879	Σ SAR<1.6, Not required
		LTE Band 7	0.951	0.220	0.086	1.257	Σ SAR<1.6, Not required
		LTE Band 12	0.670	0.220	0.086	0.976	Σ SAR<1.6, Not required
		LTE Band 13	0.625	0.220	0.086	0.931	Σ SAR<1.6, Not required
		LTE Band 14	0.553	0.220	0.086	0.859	Σ SAR<1.6, Not required
		LTE Band 25	0.984	0.220	0.086	1.290	Σ SAR<1.6, Not required
		LTE Band 26	0.539	0.220	0.086	0.845	Σ SAR<1.6, Not required
		LTE Band 30	0.875	0.220	0.086	1.181	Σ SAR<1.6, Not required
		LTE Band 41	0.688	0.220	0.086	0.994	Σ SAR<1.6, Not required
		LTE Band 66	0.962	0.220	0.086	1.268	Σ SAR<1.6, Not required

*Using WLAN TX1 back side full power SAR value to evaluate the simultaneous SAR to be the conservative evaluation.

Unless otherwise stated the results shown in this test report refer only to the sample(s) tested and such sample(s) are retained for 90 days only.

除非另有說明，此報告結果僅對測試之樣品負責，同時此樣品僅保留90天。本報告未經本公司書面許可，不可部份複製。

This document is issued by the Company subject to its General Conditions of Service printed overleaf, available on request or accessible at www.sgs.com/terms_and_conditions.htm and for electronic format documents, subject to Terms and Conditions for Electronic Documents at www.sgs.com/terms_e-document.htm. Attention is drawn to the limitation of liability, indemnification and jurisdiction issues defined therein. Any holder of this document is advised that information contained hereon reflects the Company's findings at the time of its intervention only and within the limits of Client's instructions, if any. The Company's sole responsibility is to its Client and this document does not exonerate parties to a transaction from exercising all their rights and obligations under the transaction documents. This document cannot be reproduced except in full, without prior written approval of the Company. Any unauthorized alteration, forgery or falsification of the content or appearance of this document is unlawful and offenders may be prosecuted to the fullest extent of the law.

Back side WWAN + 5G WLAN Tx1 + BT

No.	Position	Conditions	Max. WWAN	Max. WLAN Tx1*	BT	SAR Sum	SPLSR
4	Back side	WCDMA Band II	0.903	0.228	0.086	1.217	ΣSAR<1.6, Not required
		WCDMA Band V	0.502	0.228	0.086	0.816	ΣSAR<1.6, Not required
		LTE Band 5	0.573	0.228	0.086	0.887	ΣSAR<1.6, Not required
		LTE Band 7	0.951	0.228	0.086	1.265	ΣSAR<1.6, Not required
		LTE Band 12	0.670	0.228	0.086	0.984	ΣSAR<1.6, Not required
		LTE Band 13	0.625	0.228	0.086	0.939	ΣSAR<1.6, Not required
		LTE Band 14	0.553	0.228	0.086	0.867	ΣSAR<1.6, Not required
		LTE Band 25	0.984	0.228	0.086	1.298	ΣSAR<1.6, Not required
		LTE Band 26	0.539	0.228	0.086	0.853	ΣSAR<1.6, Not required
		LTE Band 30	0.875	0.228	0.086	1.189	ΣSAR<1.6, Not required
		LTE Band 41	0.688	0.228	0.086	1.002	ΣSAR<1.6, Not required
		LTE Band 66	0.962	0.228	0.086	1.276	ΣSAR<1.6, Not required

*Using WLAN TX1 back side full power SAR value to evaluate the simultaneous SAR to be the conservative evaluation.

Unless otherwise stated the results shown in this test report refer only to the sample(s) tested and such sample(s) are retained for 90 days only.
除非另有說明，此報告結果僅對測試之樣品負責，同時此樣品僅保留90天。本報告未經本公司書面許可，不可部份複製。

This document is issued by the Company subject to its General Conditions of Service printed overleaf, available on request or accessible at www.sgs.com/terms_and_conditions.htm and for electronic format documents, subject to Terms and Conditions for Electronic Documents at www.sgs.com/terms_e-document.htm. Attention is drawn to the limitation of liability, indemnification and jurisdiction issues defined therein. Any holder of this document is advised that information contained hereon reflects the Company's findings at the time of its intervention only and within the limits of Client's instructions, if any. The Company's sole responsibility is to its Client and this document does not exonerate parties to a transaction from exercising all their rights and obligations under the transaction documents. This document cannot be reproduced except in full, without prior written approval of the Company. Any unauthorized alteration, forgery or falsification of the content or appearance of this document is unlawful and offenders may be prosecuted to the fullest extent of the law.

Back side WWAN + 5G WLAN TX1 + 5G WLAN TX2 + BT

No.	Position	Conditions	Max. WWAN	Max. WLAN Tx1*	Max. WLAN Tx2	BT	SAR Sum	SPLSR
5	Back side	WCDMA Band II	0.903	0.228	0.253	0.086	1.470	ΣSAR<1.6, Not required
		WCDMA Band V	0.502	0.228	0.253	0.086	1.069	ΣSAR<1.6, Not required
		LTE Band 5	0.573	0.228	0.253	0.086	1.140	ΣSAR<1.6, Not required
		LTE Band 7	0.951	0.228	0.253	0.086	1.518	ΣSAR<1.6, Not required
		LTE Band 12	0.670	0.228	0.253	0.086	1.237	ΣSAR<1.6, Not required
		LTE Band 13	0.625	0.228	0.253	0.086	1.192	ΣSAR<1.6, Not required
		LTE Band 14	0.553	0.228	0.253	0.086	1.120	ΣSAR<1.6, Not required
		LTE Band 25	0.984	0.228	0.253	0.086	1.551	ΣSAR<1.6, Not required
		LTE Band 26	0.539	0.228	0.253	0.086	1.106	ΣSAR<1.6, Not required
		LTE Band 30	0.875	0.228	0.253	0.086	1.442	ΣSAR<1.6, Not required
		LTE Band 41	0.688	0.228	0.253	0.086	1.255	ΣSAR<1.6, Not required
		LTE Band 66	0.962	0.228	0.253	0.086	1.529	ΣSAR<1.6, Not required

*Using WLAN TX1 back side full power SAR value to evaluate the simultaneous SAR to be the conservative evaluation.

Unless otherwise stated the results shown in this test report refer only to the sample(s) tested and such sample(s) are retained for 90 days only.

除非另有說明，此報告結果僅對測試之樣品負責，同時此樣品僅保留90天。本報告未經本公司書面許可，不可部份複製。

This document is issued by the Company subject to its General Conditions of Service printed overleaf, available on request or accessible at www.sgs.com/terms_and_conditions.htm and for electronic format documents, subject to Terms and Conditions for Electronic Documents at www.sgs.com/terms_e-document.htm. Attention is drawn to the limitation of liability, indemnification and jurisdiction issues defined therein. Any holder of this document is advised that information contained hereon reflects the Company's findings at the time of its intervention only and within the limits of Client's instructions, if any. The Company's sole responsibility is to its Client and this document does not exonerate parties to a transaction from exercising all their rights and obligations under the transaction documents. This document cannot be reproduced except in full, without prior written approval of the Company. Any unauthorized alteration, forgery or falsification of the content or appearance of this document is unlawful and offenders may be prosecuted to the fullest extent of the law.

Top side WWAN + 2.4G WLAN TX1 + 2.4G WLAN TX2

No.	Position	Conditions	Max. WWAN	Max. WLAN Tx1	Max. WLAN Tx2	SAR Sum	SPLSR
6	Top side	WCDMA Band II	0.452	0.062	0.059	0.573	ΣSAR<1.6, Not required
		WCDMA Band V	0.887	0.062	0.059	1.008	ΣSAR<1.6, Not required
		LTE Band 5	0.959	0.062	0.059	1.080	ΣSAR<1.6, Not required
		LTE Band 7	0.350	0.062	0.059	0.471	ΣSAR<1.6, Not required
		LTE Band 12	0.762	0.062	0.059	0.883	ΣSAR<1.6, Not required
		LTE Band 13	0.949	0.062	0.059	1.070	ΣSAR<1.6, Not required
		LTE Band 14	0.882	0.062	0.059	1.003	ΣSAR<1.6, Not required
		LTE Band 25	0.480	0.062	0.059	0.601	ΣSAR<1.6, Not required
		LTE Band 26	0.979	0.062	0.059	1.100	ΣSAR<1.6, Not required
		LTE Band 30	0.542	0.062	0.059	0.663	ΣSAR<1.6, Not required
		LTE Band 41	0.115	0.062	0.059	0.236	ΣSAR<1.6, Not required
		LTE Band 66	0.729	0.062	0.059	0.850	ΣSAR<1.6, Not required

Unless otherwise stated the results shown in this test report refer only to the sample(s) tested and such sample(s) are retained for 90 days only.

除非另有說明，此報告結果僅對測試之樣品負責，同時此樣品僅保留90天。本報告未經本公司書面許可，不可部份複製。

This document is issued by the Company subject to its General Conditions of Service printed overleaf, available on request or accessible at www.sgs.com/terms_and_conditions.htm and for electronic format documents, subject to Terms and Conditions for Electronic Documents at www.sgs.com/terms_e-document.htm. Attention is drawn to the limitation of liability, indemnification and jurisdiction issues defined therein. Any holder of this document is advised that information contained hereon reflects the Company's findings at the time of its intervention only and within the limits of Client's instructions, if any. The Company's sole responsibility is to its Client and this document does not exonerate parties to a transaction from exercising all their rights and obligations under the transaction documents. This document cannot be reproduced except in full, without prior written approval of the Company. Any unauthorized alteration, forgery or falsification of the content or appearance of this document is unlawful and offenders may be prosecuted to the fullest extent of the law.

Top side WWAN + 5G WLAN TX1 + 5G WLAN TX2

No.	Position	Conditions	Max. WWAN	Max. WLAN Tx1	Max. WLAN Tx2	SAR Sum	SPLSR
7	Top side	WCDMA Band II	0.452	0.226	0.159	0.837	ΣSAR<1.6, Not required
		WCDMA Band V	0.887	0.226	0.159	1.272	ΣSAR<1.6, Not required
		LTE Band 5	0.959	0.226	0.159	1.344	ΣSAR<1.6, Not required
		LTE Band 7	0.350	0.226	0.159	0.735	ΣSAR<1.6, Not required
		LTE Band 12	0.762	0.226	0.159	1.147	ΣSAR<1.6, Not required
		LTE Band 13	0.949	0.226	0.159	1.334	ΣSAR<1.6, Not required
		LTE Band 14	0.882	0.226	0.159	1.267	ΣSAR<1.6, Not required
		LTE Band 25	0.480	0.226	0.159	0.865	ΣSAR<1.6, Not required
		LTE Band 26	0.979	0.226	0.159	1.364	ΣSAR<1.6, Not required
		LTE Band 30	0.542	0.226	0.159	0.927	ΣSAR<1.6, Not required
		LTE Band 41	0.115	0.226	0.159	0.500	ΣSAR<1.6, Not required
		LTE Band 66	0.729	0.226	0.159	1.114	ΣSAR<1.6, Not required

Unless otherwise stated the results shown in this test report refer only to the sample(s) tested and such sample(s) are retained for 90 days only.

除非另有說明，此報告結果僅對測試之樣品負責，同時此樣品僅保留90天。本報告未經本公司書面許可，不可部份複製。

This document is issued by the Company subject to its General Conditions of Service printed overleaf, available on request or accessible at www.sgs.com/terms_and_conditions.htm and for electronic format documents, subject to Terms and Conditions for Electronic Documents at www.sgs.com/terms_e-document.htm. Attention is drawn to the limitation of liability, indemnification and jurisdiction issues defined therein. Any holder of this document is advised that information contained hereon reflects the Company's findings at the time of its intervention only and within the limits of Client's instructions, if any. The Company's sole responsibility is to its Client and this document does not exonerate parties to a transaction from exercising all their rights and obligations under the transaction documents. This document cannot be reproduced except in full, without prior written approval of the Company. Any unauthorized alteration, forgery or falsification of the content or appearance of this document is unlawful and offenders may be prosecuted to the fullest extent of the law.

Top side WWAN + 2.4G WLAN Tx1 + BT

No.	Position	Conditions	Max. WWAN	Max. WLAN Tx1	BT	SAR Sum	SPLSR
8	Top side	WCDMA Band II	0.452	0.062	0.059	0.573	ΣSAR<1.6, Not required
		WCDMA Band V	0.887	0.062	0.059	1.008	ΣSAR<1.6, Not required
		LTE Band 5	0.959	0.062	0.059	1.080	ΣSAR<1.6, Not required
		LTE Band 7	0.350	0.062	0.059	0.471	ΣSAR<1.6, Not required
		LTE Band 12	0.762	0.062	0.059	0.883	ΣSAR<1.6, Not required
		LTE Band 13	0.949	0.062	0.059	1.070	ΣSAR<1.6, Not required
		LTE Band 14	0.882	0.062	0.059	1.003	ΣSAR<1.6, Not required
		LTE Band 25	0.480	0.062	0.059	0.601	ΣSAR<1.6, Not required
		LTE Band 26	0.979	0.062	0.059	1.100	ΣSAR<1.6, Not required
		LTE Band 30	0.542	0.062	0.059	0.663	ΣSAR<1.6, Not required
		LTE Band 41	0.115	0.062	0.059	0.236	ΣSAR<1.6, Not required
		LTE Band 66	0.729	0.062	0.059	0.850	ΣSAR<1.6, Not required

Unless otherwise stated the results shown in this test report refer only to the sample(s) tested and such sample(s) are retained for 90 days only.

除非另有說明，此報告結果僅對測試之樣品負責，同時此樣品僅保留90天。本報告未經本公司書面許可，不可部份複製。

This document is issued by the Company subject to its General Conditions of Service printed overleaf, available on request or accessible at www.sgs.com/terms_and_conditions.htm and for electronic format documents, subject to Terms and Conditions for Electronic Documents at www.sgs.com/terms_e-document.htm. Attention is drawn to the limitation of liability, indemnification and jurisdiction issues defined therein. Any holder of this document is advised that information contained hereon reflects the Company's findings at the time of its intervention only and within the limits of Client's instructions, if any. The Company's sole responsibility is to its Client and this document does not exonerate parties to a transaction from exercising all their rights and obligations under the transaction documents. This document cannot be reproduced except in full, without prior written approval of the Company. Any unauthorized alteration, forgery or falsification of the content or appearance of this document is unlawful and offenders may be prosecuted to the fullest extent of the law.

Top side WWAN + 5G WLAN Tx1 + BT

No.	Position	Conditions	Max. WWAN	Max. WLAN Tx1	BT	SAR Sum	SPLSR
9	Top side	WCDMA Band II	0.452	0.226	0.059	0.737	ΣSAR<1.6, Not required
		WCDMA Band V	0.887	0.226	0.059	1.172	ΣSAR<1.6, Not required
		LTE Band 5	0.959	0.226	0.059	1.244	ΣSAR<1.6, Not required
		LTE Band 7	0.350	0.226	0.059	0.635	ΣSAR<1.6, Not required
		LTE Band 12	0.762	0.226	0.059	1.047	ΣSAR<1.6, Not required
		LTE Band 13	0.949	0.226	0.059	1.234	ΣSAR<1.6, Not required
		LTE Band 14	0.882	0.226	0.059	1.167	ΣSAR<1.6, Not required
		LTE Band 25	0.480	0.226	0.059	0.765	ΣSAR<1.6, Not required
		LTE Band 26	0.979	0.226	0.059	1.264	ΣSAR<1.6, Not required
		LTE Band 30	0.542	0.226	0.059	0.827	ΣSAR<1.6, Not required
		LTE Band 41	0.115	0.226	0.059	0.400	ΣSAR<1.6, Not required
		LTE Band 66	0.729	0.226	0.059	1.014	ΣSAR<1.6, Not required

Unless otherwise stated the results shown in this test report refer only to the sample(s) tested and such sample(s) are retained for 90 days only.

除非另有說明，此報告結果僅對測試之樣品負責，同時此樣品僅保留90天。本報告未經本公司書面許可，不可部份複製。

This document is issued by the Company subject to its General Conditions of Service printed overleaf, available on request or accessible at www.sgs.com/terms_and_conditions.htm and for electronic format documents, subject to Terms and Conditions for Electronic Documents at www.sgs.com/terms_e-document.htm. Attention is drawn to the limitation of liability, indemnification and jurisdiction issues defined therein. Any holder of this document is advised that information contained hereon reflects the Company's findings at the time of its intervention only and within the limits of Client's instructions, if any. The Company's sole responsibility is to its Client and this document does not exonerate parties to a transaction from exercising all their rights and obligations under the transaction documents. This document cannot be reproduced except in full, without prior written approval of the Company. Any unauthorized alteration, forgery or falsification of the content or appearance of this document is unlawful and offenders may be prosecuted to the fullest extent of the law.

Top side WWAN + 5G WLAN TX1 + 5G WLAN TX2 + BT

No.	Position	Conditions	Max. WWAN	Max. WLAN Tx1	Max. WLAN Tx2	BT	SAR Sum	SPLSR
10	Top side	WCDMA Band II	0.452	0.226	0.159	0.059	0.896	ΣSAR<1.6, Not required
		WCDMA Band V	0.887	0.226	0.159	0.059	1.331	ΣSAR<1.6, Not required
		LTE Band 5	0.959	0.226	0.159	0.059	1.403	ΣSAR<1.6, Not required
		LTE Band 7	0.350	0.226	0.159	0.059	0.794	ΣSAR<1.6, Not required
		LTE Band 12	0.762	0.226	0.159	0.059	1.206	ΣSAR<1.6, Not required
		LTE Band 13	0.949	0.226	0.159	0.059	1.393	ΣSAR<1.6, Not required
		LTE Band 14	0.882	0.226	0.159	0.059	1.326	ΣSAR<1.6, Not required
		LTE Band 25	0.480	0.226	0.159	0.059	0.924	ΣSAR<1.6, Not required
		LTE Band 26	0.979	0.226	0.159	0.059	1.423	ΣSAR<1.6, Not required
		LTE Band 30	0.542	0.226	0.159	0.059	0.986	ΣSAR<1.6, Not required
		LTE Band 41	0.115	0.226	0.159	0.059	0.559	ΣSAR<1.6, Not required
		LTE Band 66	0.729	0.226	0.159	0.059	1.173	ΣSAR<1.6, Not required

Unless otherwise stated the results shown in this test report refer only to the sample(s) tested and such sample(s) are retained for 90 days only.

除非另有說明，此報告結果僅對測試之樣品負責，同時此樣品僅保留90天。本報告未經本公司書面許可，不可部份複製。

This document is issued by the Company subject to its General Conditions of Service printed overleaf, available on request or accessible at www.sgs.com/terms_and_conditions.htm and for electronic format documents, subject to Terms and Conditions for Electronic Documents at www.sgs.com/terms_e-document.htm. Attention is drawn to the limitation of liability, indemnification and jurisdiction issues defined therein. Any holder of this document is advised that information contained hereon reflects the Company's findings at the time of its intervention only and within the limits of Client's instructions, if any. The Company's sole responsibility is to its Client and this document does not exonerate parties to a transaction from exercising all their rights and obligations under the transaction documents. This document cannot be reproduced except in full, without prior written approval of the Company. Any unauthorized alteration, forgery or falsification of the content or appearance of this document is unlawful and offenders may be prosecuted to the fullest extent of the law.

4. Instruments List

Manufacturer	Device	Type	Serial number	Date of last calibration	Date of next calibration
SPEAG	Dosimetric E-Field Probe	EX3DV4	7466	Feb.04,2019	Feb.03,2020
SPEAG	System Validation Dipole	D750V3	1078	Jun.27,2019	Jun.26,2020
		D835V2	4d092	Jun.20,2019	Jun.19,2020
		D1750V2	1023	Jun.20,2019	Jun.19,2020
		D1900V2	5d142	Jul.26,2019	Jul.25,2020
		D2300V2	1092	Dec.04,2018	Dec.03,2019
		D2450V2	869	Jun.27,2019	Jun.26,2020
		D2600V2	1058	Jun.27,2019	Jun.26,2020
		D5GHzV2	1040	Jun.24,2019	Jun.23,2020
SPEAG	Data acquisition Electronics	DAE4	1336	Aug.27,2019	Aug.26,2020
			877	Mar.22,2019	Mar.21,2020
SPEAG	Software	DASY 52 52.10.1	N/A	Calibration not required	Calibration not required
SPEAG	Phantom	ELI	N/A	Calibration not required	Calibration not required
Agilent	Network Analyzer	E5071C	MY46107530	Feb.23,2019	Feb.22,2020
Agilent	Dielectric Probe Kit	85070E	MY44300677	Calibration not required	Calibration not required
Agilent	Dual-directional coupler	772D	MY46151242	Jul.30,2019	Jul.29,2020
		778D	MY48220468	Jul.30,2019	Jul.29,2020
Agilent	Signal Generator	N5181A	MY50141235	Apr.22,2019	Apr.21,2020

Unless otherwise stated the results shown in this test report refer only to the sample(s) tested and such sample(s) are retained for 90 days only.

除非另有說明，此報告結果僅對測試之樣品負責，同時此樣品僅保留90天。本報告未經本公司書面許可，不可部份複製。

This document is issued by the Company subject to its General Conditions of Service printed overleaf, available on request or accessible at www.sgs.com/terms_and_conditions.htm and for electronic format documents, subject to Terms and Conditions for Electronic Documents at www.sgs.com/terms_e-document.htm. Attention is drawn to the limitation of liability, indemnification and jurisdiction issues defined therein. Any holder of this document is advised that information contained hereon reflects the Company's findings at the time of its intervention only and within the limits of Client's instructions, if any. The Company's sole responsibility is to its Client and this document does not exonerate parties to a transaction from exercising all their rights and obligations under the transaction documents. This document cannot be reproduced except in full, without prior written approval of the Company. Any unauthorized alteration, forgery or falsification of the content or appearance of this document is unlawful and offenders may be prosecuted to the fullest extent of the law.

Manufacturer	Device	Type	Serial number	Date of last calibration	Date of next calibration
Agilent	Power Meter	E4417A	MY51410006	Feb.19,2019	Feb.18,2020
Agilent	Power Sensor	E9301H	MY51470001	Feb.19,2019	Feb.18,2020
			MY51470002	Feb.19,2019	Feb.18,2020
TECPEL	Digital thermometer	DTM-303A	TP130074	Mar.26,2019	Mar.25,2020
Anritsu	Radio Communication Test	MT8820C	6201061049	Dec.27,2018	Dec.26,2019
			6201061014	Dec.08,2019	Dec.07,2020
Agilent	EXA Signal Analyzer	N9019A	MY50060104	Nov.11,2019	Nov.10,2020
Anritsu	Radio Communication Test	MT8821C	6261786084	Sep.01,2019	Aug.01,2020

Unless otherwise stated the results shown in this test report refer only to the sample(s) tested and such sample(s) are retained for 90 days only.

除非另有說明，此報告結果僅對測試之樣品負責，同時此樣品僅保留90天。本報告未經本公司書面許可，不可部份複製。

This document is issued by the Company subject to its General Conditions of Service printed overleaf, available on request or accessible at www.sgs.com/terms_and_conditions.htm and for electronic format documents, subject to Terms and Conditions for Electronic Documents at www.sgs.com/terms_e-document.htm. Attention is drawn to the limitation of liability, indemnification and jurisdiction issues defined therein. Any holder of this document is advised that information contained hereon reflects the Company's findings at the time of its intervention only and within the limits of Client's instructions, if any. The Company's sole responsibility is to its Client and this document does not exonerate parties to a transaction from exercising all their rights and obligations under the transaction documents. This document cannot be reproduced except in full, without prior written approval of the Company. Any unauthorized alteration, forgery or falsification of the content or appearance of this document is unlawful and offenders may be prosecuted to the fullest extent of the law.

5. Measurements

Date: 2019/11/7

WCDMA Band II_Body_Top side_CH 9262_19mm

Communication System: WCDMA; Frequency: 1852.4 MHz; Duty Cycle: 1:1
Medium parameters used: $f = 1852.4$ MHz; $\sigma = 1.533$ S/m; $\epsilon_r = 54.161$; $\rho = 1000$ kg/m³
Phantom section: Flat Section
Ambient temperature: 22.1°C; Liquid temperature: 21.9°C

DASY5 Configuration:

- Probe: EX3DV4 - SN7466; ConvF(8.04, 8.04, 8.04); Calibrated: 2019/2/4
- Sensor-Surface: 2mm (Mechanical Surface Detection)
- Electronics: DAE4 Sn1336; Calibrated: 2019/8/27
- Phantom: ELI
- DASY52 52.10.1(1476); SEMCAD X 14.6.11(7439)

Area Scan (51x81x1): Interpolated grid: dx=15 mm, dy=15 mm

Maximum value of SAR (interpolated) = 0.781 W/kg

Zoom Scan (5x5x7)/Cube 0: Measurement grid: dx=8mm, dy=8mm, dz=5mm

Reference Value = 10.52 V/m; Power Drift = -0.03 dB

Peak SAR (extrapolated) = 0.670 W/kg

SAR(1 g) = 0.566 W/kg; SAR(10 g) = 0.398 W/kg

Maximum value of SAR (measured) = 0.644 W/kg

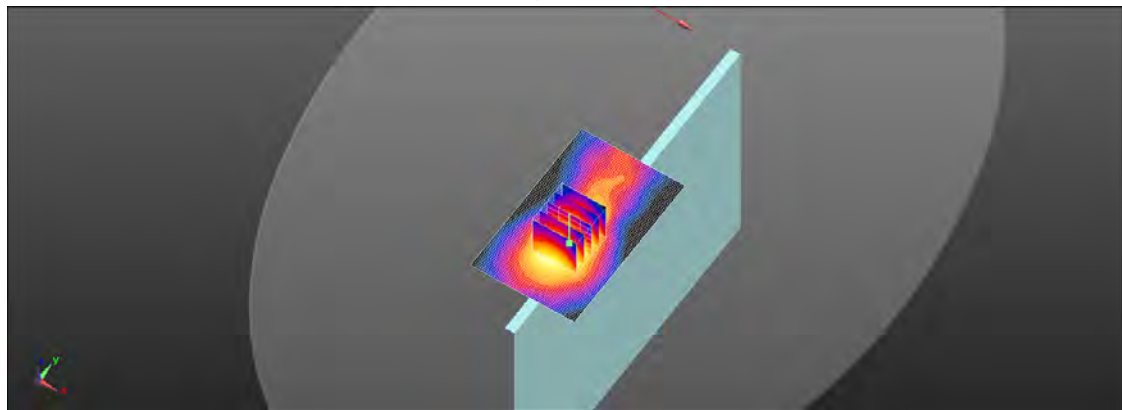
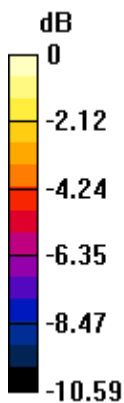

0 dB = 0.644 W/kg = -1.91 dBW/kg

Unless otherwise stated the results shown in this test report refer only to the sample(s) tested and such sample(s) are retained for 90 days only.

除非另有說明，此報告結果僅對測試之樣品負責，同時此樣品僅保留90天。本報告未經本公司書面許可，不可部份複製。

This document is issued by the Company subject to its General Conditions of Service printed overleaf, available on request or accessible at www.sgs.com/terms_and_conditions.htm and for electronic format documents, subject to Terms and Conditions for Electronic Documents at www.sgs.com/terms_e-document.htm. Attention is drawn to the limitation of liability, indemnification and jurisdiction issues defined therein. Any holder of this document is advised that information contained hereon reflects the Company's findings at the time of its intervention only and within the limits of Client's instructions, if any. The Company's sole responsibility is to its Client and this document does not exonerate parties to a transaction from exercising all their rights and obligations under the transaction documents. This document cannot be reproduced except in full, without prior written approval of the Company. Any unauthorized alteration, forgery or falsification of the content or appearance of this document is unlawful and offenders may be prosecuted to the fullest extent of the law.

Date: 2019/11/5

WCDMA Band V_Body_Left side_CH 4132_0mm

Communication System: WCDMA; Frequency: 826.4 MHz; Duty Cycle: 1:1

Medium parameters used: $f = 826.4$ MHz; $\sigma = 0.948$ S/m; $\epsilon_r = 55.488$; $\rho = 1000$ kg/m³

Phantom section: Flat Section

Ambient temperature: 22.1°C; Liquid temperature: 21.8°C

DASY5 Configuration:

- Probe: EX3DV4 - SN7466; ConvF(10.04, 10.04, 10.04); Calibrated: 2019/2/4
- Sensor-Surface: 2mm (Mechanical Surface Detection)
- Electronics: DAE4 Sn1336; Calibrated: 2019/8/27
- Phantom: ELI
- DASY52 52.10.1(1476); SEMCAD X 14.6.11(7439)

Area Scan (41x81x1): Interpolated grid: dx=15 mm, dy=15 mm

Maximum value of SAR (interpolated) = 0.410 W/kg

Zoom Scan (5x5x7)/Cube 0: Measurement grid: dx=8mm, dy=8mm, dz=5mm

Reference Value = 9.478 V/m; Power Drift = -0.06 dB

Peak SAR (extrapolated) = 0.402 W/kg

SAR(1 g) = 0.244 W/kg; SAR(10 g) = 0.146 W/kg

Maximum value of SAR (measured) = 0.350 W/kg

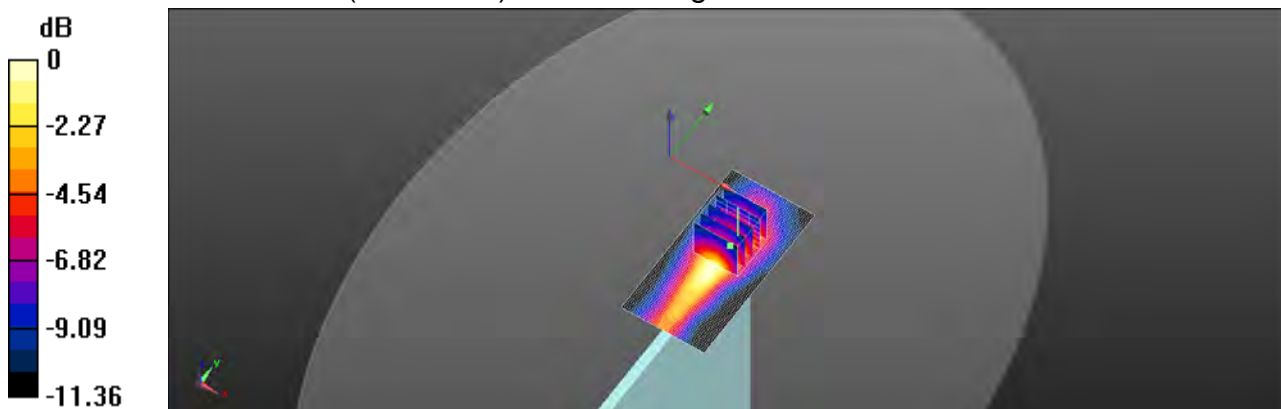

0 dB = 0.350 W/kg = -4.56 dBW/kg

Unless otherwise stated the results shown in this test report refer only to the sample(s) tested and such sample(s) are retained for 90 days only.

除非另有說明，此報告結果僅對測試之樣品負責，同時此樣品僅保留90天。本報告未經本公司書面許可，不可部份複製。

This document is issued by the Company subject to its General Conditions of Service printed overleaf, available on request or accessible at www.sgs.com/terms_and_conditions.htm and for electronic format documents, subject to Terms and Conditions for Electronic Documents at www.sgs.com/terms_e-document.htm. Attention is drawn to the limitation of liability, indemnification and jurisdiction issues defined therein. Any holder of this document is advised that information contained hereon reflects the Company's findings at the time of its intervention only and within the limits of Client's instructions, if any. The Company's sole responsibility is to its Client and this document does not exonerate parties to a transaction from exercising all their rights and obligations under the transaction documents. This document cannot be reproduced except in full, without prior written approval of the Company. Any unauthorized alteration, forgery or falsification of the content or appearance of this document is unlawful and offenders may be prosecuted to the fullest extent of the law.

Date: 2019/11/5

LTE Band 5 (10MHz)_Body_Left side_CH 20450_QPSK_1-0_0mm

Communication System: LTE; Frequency: 829 MHz; Duty Cycle: 1:1

Medium parameters used: $f = 829 \text{ MHz}$; $\sigma = 0.949 \text{ S/m}$; $\epsilon_r = 55.483$; $\rho = 1000 \text{ kg/m}^3$

Phantom section: Flat Section

Ambient temperature: 22.1°C ; Liquid temperature: 21.8°C

DASY5 Configuration:

- Probe: EX3DV4 - SN7466; ConvF(10.04, 10.04, 10.04); Calibrated: 2019/2/4
- Sensor-Surface: 2mm (Mechanical Surface Detection)
- Electronics: DAE4 Sn1336; Calibrated: 2019/8/27
- Phantom: ELI
- DASY52 52.10.1(1476); SEMCAD X 14.6.11(7439)

Area Scan (51x71x1): Interpolated grid: $dx=15 \text{ mm}$, $dy=15 \text{ mm}$

Maximum value of SAR (interpolated) = 0.280 W/kg

Zoom Scan (5x5x7)/Cube 0: Measurement grid: $dx=8\text{mm}$, $dy=8\text{mm}$, $dz=5\text{mm}$

Reference Value = 9.334 V/m ; Power Drift = -0.04 dB

Peak SAR (extrapolated) = 0.317 W/kg

SAR(1 g) = 0.219 W/kg ; SAR(10 g) = 0.141 W/kg

Maximum value of SAR (measured) = 0.276 W/kg

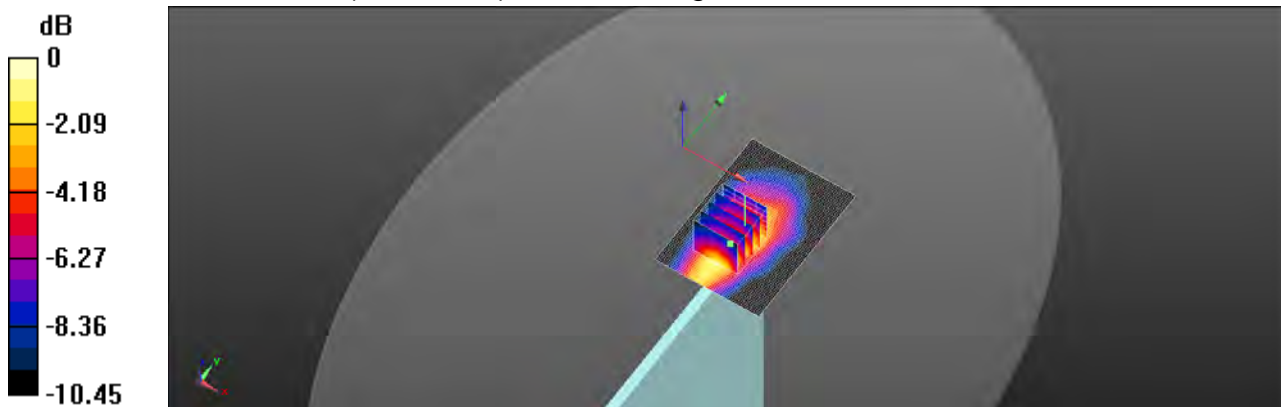

0 dB = 0.276 W/kg = -5.60 dBW/kg

Unless otherwise stated the results shown in this test report refer only to the sample(s) tested and such sample(s) are retained for 90 days only.
除非另有說明，此報告結果僅對測試之樣品負責，同時此樣品僅保留90天。本報告未經本公司書面許可，不可部份複製。

This document is issued by the Company subject to its General Conditions of Service printed overleaf, available on request or accessible at www.sgs.com/terms_and_conditions.htm and for electronic format documents, subject to Terms and Conditions for Electronic Documents at www.sgs.com/terms_e-document.htm. Attention is drawn to the limitation of liability, indemnification and jurisdiction issues defined therein. Any holder of this document is advised that information contained hereon reflects the Company's findings at the time of its intervention only and within the limits of Client's instructions, if any. The Company's sole responsibility is to its Client and this document does not exonerate parties to a transaction from exercising all their rights and obligations under the transaction documents. This document cannot be reproduced except in full, without prior written approval of the Company. Any unauthorized alteration, forgery or falsification of the content or appearance of this document is unlawful and offenders may be prosecuted to the fullest extent of the law.

Date: 2019/11/10

LTE Band 7 (20MHz)_Body_Left side_CH 20850_QPSK_1-0_0mm

Communication System: LTE; Frequency: 2510 MHz; Duty Cycle: 1:1

Medium parameters used: $f = 2510$ MHz; $\sigma = 1.998$ S/m; $\epsilon_r = 52.78$; $\rho = 1400$ kg/m³

Phantom section: Flat Section

Ambient temperature: 22.5°C; Liquid temperature: 21.8°C

DASY5 Configuration:

- Probe: EX3DV4 - SN7466; ConvF(7.47, 7.47, 7.47); Calibrated: 2019/2/4
- Sensor-Surface: 2mm (Mechanical Surface Detection)
- Electronics: DAE4 Sn1336; Calibrated: 2019/8/27
- Phantom: ELI
- DASY52 52.10.1(1476); SEMCAD X 14.6.11(7439)

Area Scan (61x81x1): Interpolated grid: dx=12 mm, dy=12 mm

Maximum value of SAR (interpolated) = 1.40 W/kg

Zoom Scan (7x7x7)/Cube 0: Measurement grid: dx=5mm, dy=5mm, dz=5mm

Reference Value = 7.578 V/m; Power Drift = 0.06 dB

Peak SAR (extrapolated) = 2.03 W/kg

SAR(1 g) = 1.07 W/kg; SAR(10 g) = 0.522 W/kg

Maximum value of SAR (measured) = 1.56 W/kg

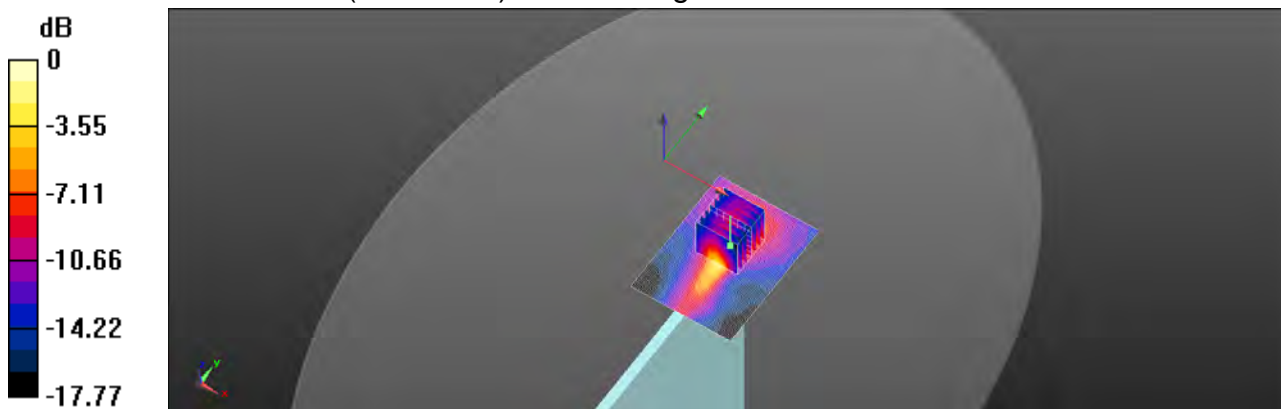

0 dB = 1.56 W/kg = 1.93 dBW/kg

Unless otherwise stated the results shown in this test report refer only to the sample(s) tested and such sample(s) are retained for 90 days only.
除非另有說明，此報告結果僅對測試之樣品負責，同時此樣品僅保留90天。本報告未經本公司書面許可，不可部份複製。

This document is issued by the Company subject to its General Conditions of Service printed overleaf, available on request or accessible at www.sgs.com/terms_and_conditions.htm and for electronic format documents, subject to Terms and Conditions for Electronic Documents at www.sgs.com/terms_e-document.htm. Attention is drawn to the limitation of liability, indemnification and jurisdiction issues defined therein. Any holder of this document is advised that information contained hereon reflects the Company's findings at the time of its intervention only and within the limits of Client's instructions, if any. The Company's sole responsibility is to its Client and this document does not exonerate parties to a transaction from exercising all their rights and obligations under the transaction documents. This document cannot be reproduced except in full, without prior written approval of the Company. Any unauthorized alteration, forgery or falsification of the content or appearance of this document is unlawful and offenders may be prosecuted to the fullest extent of the law.

Date: 2019/11/4

LTE Band 12 (10MHz)_Body_Left side_CH 23095_QPSK_1-49_0mm

Communication System: LTE; Frequency: 707.5 MHz; Duty Cycle: 1:1
Medium parameters used: $f = 707.5 \text{ MHz}$; $\sigma = 0.939 \text{ S/m}$; $\epsilon_r = 56.527$; $\rho = 930 \text{ kg/m}^3$
Phantom section: Flat Section
Ambient temperature: 22.2°C; Liquid temperature: 21.8°C

DASY5 Configuration:

- Probe: EX3DV4 - SN7466; ConvF(10.49, 10.49, 10.49); Calibrated: 2019/2/4
- Sensor-Surface: 2mm (Mechanical Surface Detection)
- Electronics: DAE4 Sn1336; Calibrated: 2019/8/27
- Phantom: ELI
- DASY52 52.10.1(1476); SEMCAD X 14.6.11(7439)

Area Scan (51x71x1): Interpolated grid: dx=15 mm, dy=15 mm

Maximum value of SAR (interpolated) = 0.208 W/kg

Zoom Scan (5x5x7)/Cube 0: Measurement grid: dx=8mm, dy=8mm, dz=5mm

Reference Value = 8.446 V/m; Power Drift = -0.02 dB

Peak SAR (extrapolated) = 0.330 W/kg

SAR(1 g) = 0.186 W/kg; SAR(10 g) = 0.106 W/kg

Maximum value of SAR (measured) = 0.287 W/kg

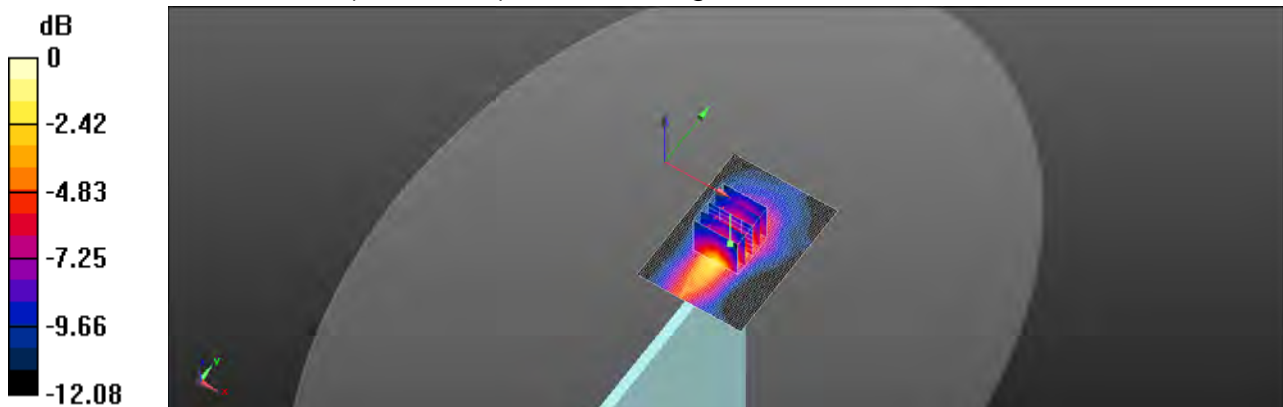

0 dB = 0.287 W/kg = -5.42 dBW/kg

Unless otherwise stated the results shown in this test report refer only to the sample(s) tested and such sample(s) are retained for 90 days only.

除非另有說明，此報告結果僅對測試之樣品負責，同時此樣品僅保留90天。本報告未經本公司書面許可，不可部份複製。

This document is issued by the Company subject to its General Conditions of Service printed overleaf, available on request or accessible at www.sgs.com/terms_and_conditions.htm and for electronic format documents, subject to Terms and Conditions for Electronic Documents at www.sgs.com/terms_e-document.htm. Attention is drawn to the limitation of liability, indemnification and jurisdiction issues defined therein. Any holder of this document is advised that information contained hereon reflects the Company's findings at the time of its intervention only and within the limits of Client's instructions, if any. The Company's sole responsibility is to its Client and this document does not exonerate parties to a transaction from exercising all their rights and obligations under the transaction documents. This document cannot be reproduced except in full, without prior written approval of the Company. Any unauthorized alteration, forgery or falsification of the content or appearance of this document is unlawful and offenders may be prosecuted to the fullest extent of the law.

Date: 2019/11/4

LTE Band 13 (10MHz)_Body_Left side_CH 23230_QPSK_1-49_0mm

Communication System: LTE; Frequency: 782 MHz; Duty Cycle: 1:1
Medium parameters used: $f = 782 \text{ MHz}$; $\sigma = 0.942 \text{ S/m}$; $\epsilon_r = 56.221$; $\rho = 1000 \text{ kg/m}^3$
Phantom section: Flat Section
Ambient temperature: 22.2°C ; Liquid temperature: 21.8°C

DASY5 Configuration:

- Probe: EX3DV4 - SN7466; ConvF(10.49, 10.49, 10.49); Calibrated: 2019/2/4
- Sensor-Surface: 2mm (Mechanical Surface Detection)
- Electronics: DAE4 Sn1336; Calibrated: 2019/8/27
- Phantom: ELI
- DASY52 52.10.1(1476); SEMCAD X 14.6.11(7439)

Area Scan (51x71x1): Interpolated grid: $dx=15 \text{ mm}$, $dy=15 \text{ mm}$

Maximum value of SAR (interpolated) = 0.203 W/kg

Zoom Scan (5x5x7)/Cube 0: Measurement grid: $dx=8\text{mm}$, $dy=8\text{mm}$, $dz=5\text{mm}$

Reference Value = 9.172 V/m ; Power Drift = -0.05 dB

Peak SAR (extrapolated) = 0.315 W/kg

SAR(1 g) = 0.191 W/kg ; SAR(10 g) = 0.114 W/kg

Maximum value of SAR (measured) = 0.282 W/kg

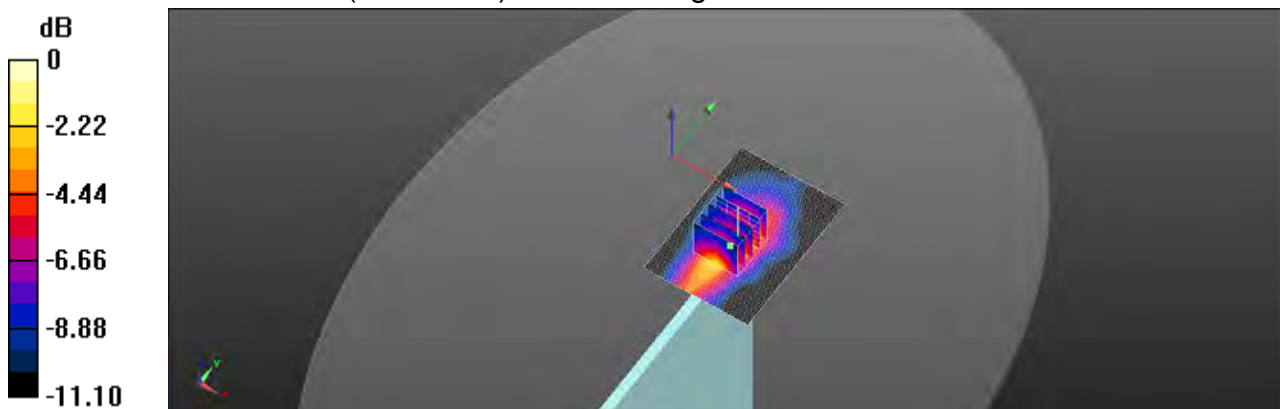

0 dB = 0.282 W/kg = -5.50 dBW/kg

Unless otherwise stated the results shown in this test report refer only to the sample(s) tested and such sample(s) are retained for 90 days only.
除非另有說明，此報告結果僅對測試之樣品負責，同時此樣品僅保留90天。本報告未經本公司書面許可，不可部份複製。

This document is issued by the Company subject to its General Conditions of Service printed overleaf, available on request or accessible at www.sgs.com/terms_and_conditions.htm and for electronic format documents, subject to Terms and Conditions for Electronic Documents at www.sgs.com/terms_e-document.htm. Attention is drawn to the limitation of liability, indemnification and jurisdiction issues defined therein. Any holder of this document is advised that information contained hereon reflects the Company's findings at the time of its intervention only and within the limits of Client's instructions, if any. The Company's sole responsibility is to its Client and this document does not exonerate parties to a transaction from exercising all their rights and obligations under the transaction documents. This document cannot be reproduced except in full, without prior written approval of the Company. Any unauthorized alteration, forgery or falsification of the content or appearance of this document is unlawful and offenders may be prosecuted to the fullest extent of the law.

Date: 2019/11/4

LTE Band 14 (10MHz)_Body_Left side_CH 23330_QPSK_1-49_0mm

Communication System: LTE; Frequency: 793 MHz; Duty Cycle: 1:1
Medium parameters used: $f = 793 \text{ MHz}$; $\sigma = 0.943 \text{ S/m}$; $\epsilon_r = 56.186$; $\rho = 1000 \text{ kg/m}^3$
Phantom section: Flat Section
Ambient temperature: 22.2°C ; Liquid temperature: 21.8°C

DASY5 Configuration:

- Probe: EX3DV4 - SN7466; ConvF(10.49, 10.49, 10.49); Calibrated: 2019/2/4
- Sensor-Surface: 2mm (Mechanical Surface Detection)
- Electronics: DAE4 Sn1336; Calibrated: 2019/8/27
- Phantom: ELI
- DASY52 52.10.1(1476); SEMCAD X 14.6.11(7439)

Area Scan (51x71x1): Interpolated grid: dx=15 mm, dy=15 mm

Maximum value of SAR (interpolated) = 0.207 W/kg

Zoom Scan (5x5x7)/Cube 0: Measurement grid: dx=8mm, dy=8mm, dz=5mm

Reference Value = 9.711 V/m; Power Drift = -0.09 dB

Peak SAR (extrapolated) = 0.319 W/kg

SAR(1 g) = 0.195 W/kg; SAR(10 g) = 0.117 W/kg

Maximum value of SAR (measured) = 0.279 W/kg

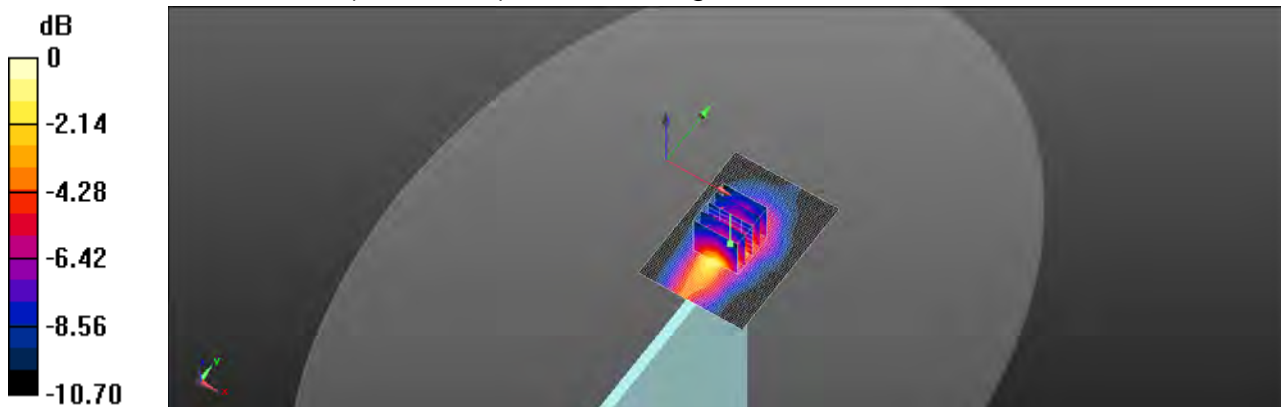

0 dB = 0.279 W/kg = -5.55 dBW/kg

Unless otherwise stated the results shown in this test report refer only to the sample(s) tested and such sample(s) are retained for 90 days only.
除非另有說明，此報告結果僅對測試之樣品負責，同時此樣品僅保留90天。本報告未經本公司書面許可，不可部份複製。

This document is issued by the Company subject to its General Conditions of Service printed overleaf, available on request or accessible at www.sgs.com/terms_and_conditions.htm and for electronic format documents, subject to Terms and Conditions for Electronic Documents at www.sgs.com/terms_e-document.htm. Attention is drawn to the limitation of liability, indemnification and jurisdiction issues defined therein. Any holder of this document is advised that information contained hereon reflects the Company's findings at the time of its intervention only and within the limits of Client's instructions, if any. The Company's sole responsibility is to its Client and this document does not exonerate parties to a transaction from exercising all their rights and obligations under the transaction documents. This document cannot be reproduced except in full, without prior written approval of the Company. Any unauthorized alteration, forgery or falsification of the content or appearance of this document is unlawful and offenders may be prosecuted to the fullest extent of the law.

Date: 2019/11/7

LTE Band 25 (20MHz)_Body_Top side_CH 26140_QPSK_1-0_19mm

Communication System: LTE; Frequency: 1860 MHz; Duty Cycle: 1:1

Medium parameters used: $f = 1860 \text{ MHz}$; $\sigma = 1.534 \text{ S/m}$; $\epsilon_r = 54.152$; $\rho = 1000 \text{ kg/m}^3$

Phantom section: Flat Section

Ambient temperature: 22.1°C ; Liquid temperature: 21.9°C

DASY5 Configuration:

- Probe: EX3DV4 - SN7466; ConvF(8.04, 8.04, 8.04); Calibrated: 2019/2/4
- Sensor-Surface: 2mm (Mechanical Surface Detection)
- Electronics: DAE4 Sn1336; Calibrated: 2019/8/27
- Phantom: ELI
- DASY52 52.10.1(1476); SEMCAD X 14.6.11(7439)

Area Scan (51x91x1): Interpolated grid: $dx=15 \text{ mm}$, $dy=15 \text{ mm}$

Maximum value of SAR (interpolated) = 0.764 W/kg

Zoom Scan (5x5x7)/Cube 0: Measurement grid: $dx=8\text{mm}$, $dy=8\text{mm}$, $dz=5\text{mm}$

Reference Value = 9.973 V/m ; Power Drift = -0.07 dB

Peak SAR (extrapolated) = 0.672 W/kg

SAR(1 g) = 0.568 W/kg ; SAR(10 g) = 0.400 W/kg

Maximum value of SAR (measured) = 0.640 W/kg

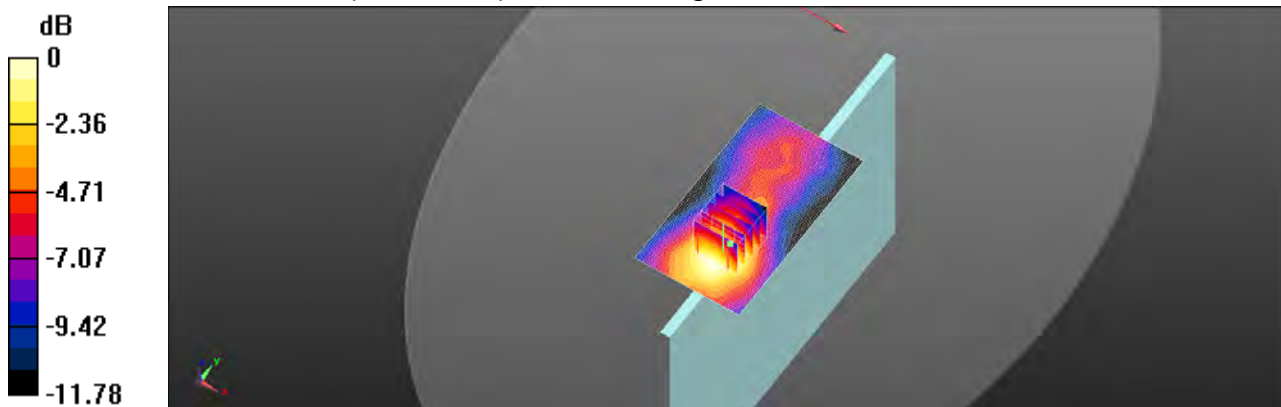

0 dB = 0.640 W/kg = -1.94 dBW/kg

Unless otherwise stated the results shown in this test report refer only to the sample(s) tested and such sample(s) are retained for 90 days only.
除非另有說明，此報告結果僅對測試之樣品負責，同時此樣品僅保留90天。本報告未經本公司書面許可，不可部份複製。

This document is issued by the Company subject to its General Conditions of Service printed overleaf, available on request or accessible at www.sgs.com/terms_and_conditions.htm and for electronic format documents, subject to Terms and Conditions for Electronic Documents at www.sgs.com/terms_e-document.htm. Attention is drawn to the limitation of liability, indemnification and jurisdiction issues defined therein. Any holder of this document is advised that information contained hereon reflects the Company's findings at the time of its intervention only and within the limits of Client's instructions, if any. The Company's sole responsibility is to its Client and this document does not exonerate parties to a transaction from exercising all their rights and obligations under the transaction documents. This document cannot be reproduced except in full, without prior written approval of the Company. Any unauthorized alteration, forgery or falsification of the content or appearance of this document is unlawful and offenders may be prosecuted to the fullest extent of the law.

Date: 2019/11/5

LTE Band 26 (15MHz)_Body_Left side_CH 26865_QPSK_1-36_0mm

Communication System: LTE; Frequency: 831.5 MHz; Duty Cycle: 1:1

Medium parameters used: $f = 831.5 \text{ MHz}$; $\sigma = 0.95 \text{ S/m}$; $\epsilon_r = 55.471$; $\rho = 1000 \text{ kg/m}^3$

Phantom section: Flat Section

Ambient temperature: 22.1°C; Liquid temperature: 21.8°C

DASY5 Configuration:

- Probe: EX3DV4 - SN7466; ConvF(10.04, 10.04, 10.04); Calibrated: 2019/2/4
- Sensor-Surface: 2mm (Mechanical Surface Detection)
- Electronics: DAE4 Sn1336; Calibrated: 2019/8/27
- Phantom: ELI
- DASY52 52.10.1(1476); SEMCAD X 14.6.11(7439)

Area Scan (51x71x1): Interpolated grid: dx=15 mm, dy=15 mm

Maximum value of SAR (interpolated) = 0.230 W/kg

Zoom Scan (5x5x7)/Cube 0: Measurement grid: dx=8mm, dy=8mm, dz=5mm

Reference Value = 10.33 V/m; Power Drift = -0.06 dB

Peak SAR (extrapolated) = 0.345 W/kg

SAR(1 g) = 0.216 W/kg; SAR(10 g) = 0.133 W/kg

Maximum value of SAR (measured) = 0.312 W/kg

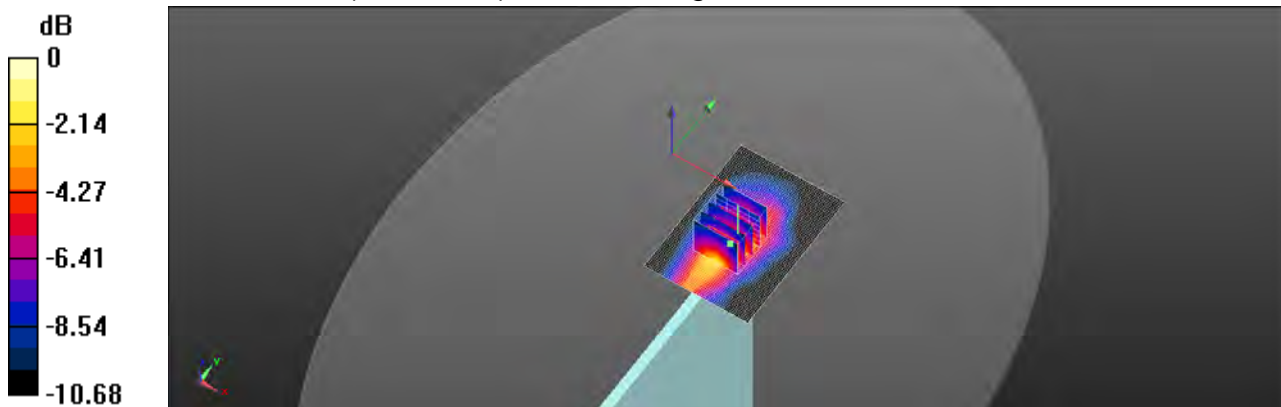

0 dB = 0.312 W/kg = -5.06 dBW/kg

Unless otherwise stated the results shown in this test report refer only to the sample(s) tested and such sample(s) are retained for 90 days only.

除非另有說明，此報告結果僅對測試之樣品負責，同時此樣品僅保留90天。本報告未經本公司書面許可，不可部份複製。

This document is issued by the Company subject to its General Conditions of Service printed overleaf, available on request or accessible at www.sgs.com/terms_and_conditions.htm and for electronic format documents, subject to Terms and Conditions for Electronic Documents at www.sgs.com/terms_e-document.htm. Attention is drawn to the limitation of liability, indemnification and jurisdiction issues defined therein. Any holder of this document is advised that information contained hereon reflects the Company's findings at the time of its intervention only and within the limits of Client's instructions, if any. The Company's sole responsibility is to its Client and this document does not exonerate parties to a transaction from exercising all their rights and obligations under the transaction documents. This document cannot be reproduced except in full, without prior written approval of the Company. Any unauthorized alteration, forgery or falsification of the content or appearance of this document is unlawful and offenders may be prosecuted to the fullest extent of the law.

Date: 2019/11/8

LTE Band 30 (10MHz)_Body_Left side_CH 27710_QPSK_1-0_0mm

Communication System: LTE; Frequency: 2310 MHz; Duty Cycle: 1:1

Medium parameters used: $f = 2310$ MHz; $\sigma = 1.769$ S/m; $\epsilon_r = 54.078$; $\rho = 1000$ kg/m³

Phantom section: Flat Section

Ambient temperature: 22.4°C; Liquid temperature: 21.8°C

DASY5 Configuration:

- Probe: EX3DV4 - SN7466; ConvF(7.84, 7.84, 7.84); Calibrated: 2019/2/4
- Sensor-Surface: 2mm (Mechanical Surface Detection)
- Electronics: DAE4 Sn1336; Calibrated: 2019/8/27
- Phantom: ELI
- DASY52 52.10.1(1476); SEMCAD X 14.6.11(7439)

Area Scan (61x91x1): Interpolated grid: dx=12 mm, dy=12 mm

Maximum value of SAR (interpolated) = 1.03 W/kg

Zoom Scan (7x7x7)/Cube 0: Measurement grid: dx=5mm, dy=5mm, dz=5mm

Reference Value = 5.088 V/m; Power Drift = -0.08 dB

Peak SAR (extrapolated) = 1.58 W/kg

SAR(1 g) = 0.818 W/kg; SAR(10 g) = 0.407 W/kg

Maximum value of SAR (measured) = 1.26 W/kg

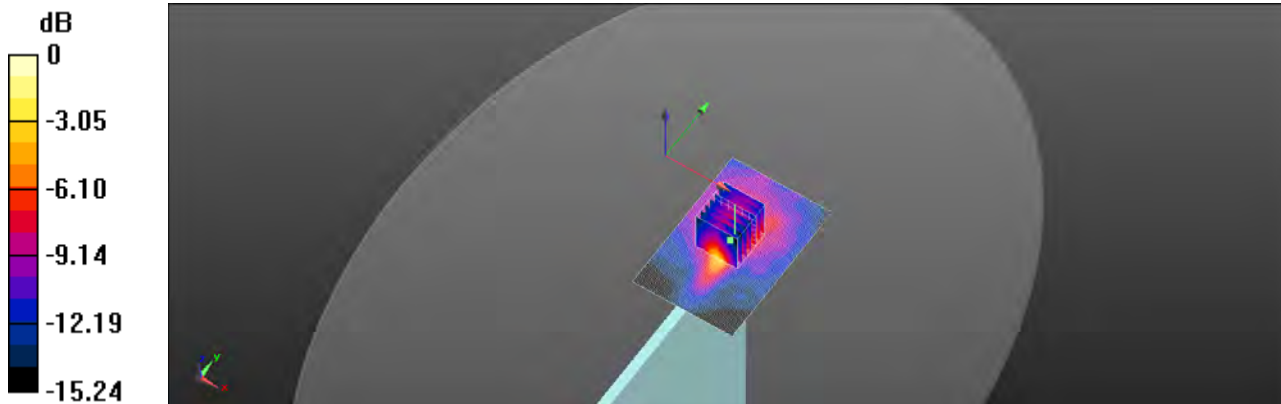

0 dB = 1.26 W/kg = 1.02 dBW/kg

Unless otherwise stated the results shown in this test report refer only to the sample(s) tested and such sample(s) are retained for 90 days only.

除非另有說明，此報告結果僅對測試之樣品負責，同時此樣品僅保留90天。本報告未經本公司書面許可，不可部份複製。

This document is issued by the Company subject to its General Conditions of Service printed overleaf, available on request or accessible at www.sgs.com/terms_and_conditions.htm and for electronic format documents, subject to Terms and Conditions for Electronic Documents at www.sgs.com/terms_e-document.htm. Attention is drawn to the limitation of liability, indemnification and jurisdiction issues defined therein. Any holder of this document is advised that information contained hereon reflects the Company's findings at the time of its intervention only and within the limits of Client's instructions, if any. The Company's sole responsibility is to its Client and this document does not exonerate parties to a transaction from exercising all their rights and obligations under the transaction documents. This document cannot be reproduced except in full, without prior written approval of the Company. Any unauthorized alteration, forgery or falsification of the content or appearance of this document is unlawful and offenders may be prosecuted to the fullest extent of the law.

Date: 2019/11/10

LTE Band 41 (20MHz)_Body_Left side_CH 41490_QPSK_1-0_0mm

Communication System: LTE; Frequency: 2680 MHz; Duty Cycle: 1:1.59956
Medium parameters used: $f = 2680$ MHz; $\sigma = 2.237$ S/m; $\epsilon_r = 51.801$; $\rho = 1000$ kg/m³
Phantom section: Flat Section
Ambient temperature: 22.5°C; Liquid temperature: 21.8°C

DASY5 Configuration:

- Probe: EX3DV4 - SN7466; ConvF(7.47, 7.47, 7.47); Calibrated: 2019/2/4
- Sensor-Surface: 2mm (Mechanical Surface Detection)
- Electronics: DAE4 Sn1336; Calibrated: 2019/8/27
- Phantom: ELI
- DASY52 52.10.1(1476); SEMCAD X 14.6.11(7439)

Area Scan (61x81x1): Interpolated grid: dx=12 mm, dy=12 mm

Maximum value of SAR (interpolated) = 0.794 W/kg

Zoom Scan (7x7x7)/Cube 0: Measurement grid: dx=5mm, dy=5mm, dz=5mm

Reference Value = 6.202 V/m; Power Drift = -0.04 dB

Peak SAR (extrapolated) = 1.43 W/kg

SAR(1 g) = 0.650 W/kg; SAR(10 g) = 0.283 W/kg

Maximum value of SAR (measured) = 1.09 W/kg

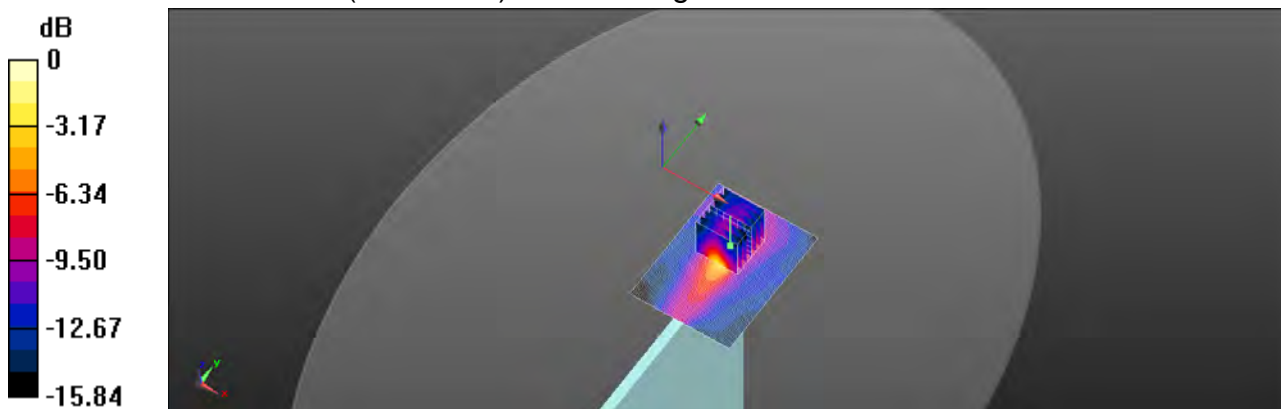

0 dB = 1.09 W/kg = 0.37 dBW/kg

Unless otherwise stated the results shown in this test report refer only to the sample(s) tested and such sample(s) are retained for 90 days only.
除非另有說明，此報告結果僅對測試之樣品負責，同時此樣品僅保留90天。本報告未經本公司書面許可，不可部份複製。

This document is issued by the Company subject to its General Conditions of Service printed overleaf, available on request or accessible at www.sgs.com/terms_and_conditions.htm and for electronic format documents, subject to Terms and Conditions for Electronic Documents at www.sgs.com/terms_e-document.htm. Attention is drawn to the limitation of liability, indemnification and jurisdiction issues defined therein. Any holder of this document is advised that information contained hereon reflects the Company's findings at the time of its intervention only and within the limits of Client's instructions, if any. The Company's sole responsibility is to its Client and this document does not exonerate parties to a transaction from exercising all their rights and obligations under the transaction documents. This document cannot be reproduced except in full, without prior written approval of the Company. Any unauthorized alteration, forgery or falsification of the content or appearance of this document is unlawful and offenders may be prosecuted to the fullest extent of the law.

Date: 2019/11/6

LTE Band 66 (20MHz)_Body_Top side_CH 132322_QPSK_1-0_19mm

Communication System: LTE; Frequency: 1745 MHz; Duty Cycle: 1:1

Medium parameters used: $f = 1745 \text{ MHz}$; $\sigma = 1.515 \text{ S/m}$; $\epsilon_r = 54.191$; $\rho = 1000 \text{ kg/m}^3$

Phantom section: Flat Section

Ambient temperature: 22.3°C; Liquid temperature: 21.8°C

DASY5 Configuration:

- Probe: EX3DV4 - SN7466; ConvF(8.48, 8.48, 8.48); Calibrated: 2019/2/4
- Sensor-Surface: 2mm (Mechanical Surface Detection)
- Electronics: DAE4 Sn1336; Calibrated: 2019/8/27
- Phantom: ELI
- DASY52 52.10.1(1476); SEMCAD X 14.6.11(7439)

Area Scan (61x101x1): Interpolated grid: dx=15 mm, dy=15 mm

Maximum value of SAR (interpolated) = 1.01 W/kg

Zoom Scan (5x5x7)/Cube 0: Measurement grid: dx=8mm, dy=8mm, dz=5mm

Reference Value = 11.53 V/m; Power Drift = -0.04 dB

Peak SAR (extrapolated) = 0.928 W/kg

SAR(1 g) = 0.803 W/kg; SAR(10 g) = 0.569 W/kg

Maximum value of SAR (measured) = 0.902 W/kg

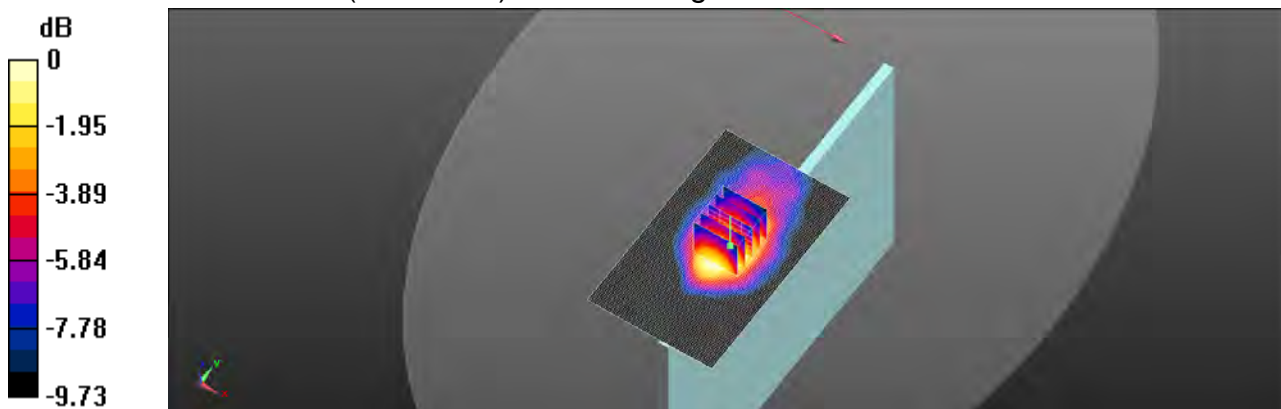

0 dB = 0.902 W/kg = -0.45 dBW/kg

Unless otherwise stated the results shown in this test report refer only to the sample(s) tested and such sample(s) are retained for 90 days only.

除非另有說明，此報告結果僅對測試之樣品負責，同時此樣品僅保留90天。本報告未經本公司書面許可，不可部份複製。

This document is issued by the Company subject to its General Conditions of Service printed overleaf, available on request or accessible at www.sgs.com/terms_and_conditions.htm and for electronic format documents, subject to Terms and Conditions for Electronic Documents at www.sgs.com/terms_e-document.htm. Attention is drawn to the limitation of liability, indemnification and jurisdiction issues defined therein. Any holder of this document is advised that information contained hereon reflects the Company's findings at the time of its intervention only and within the limits of Client's instructions, if any. The Company's sole responsibility is to its Client and this document does not exonerate parties to a transaction from exercising all their rights and obligations under the transaction documents. This document cannot be reproduced except in full, without prior written approval of the Company. Any unauthorized alteration, forgery or falsification of the content or appearance of this document is unlawful and offenders may be prosecuted to the fullest extent of the law.

Date: 2019/11/7

WCDMA Band II_Body_Back side_CH 9538_0mm

Communication System: WCDMA; Frequency: 1907.6 MHz; Duty Cycle: 1:1
Medium parameters used: $f = 1908$ MHz; $\sigma = 1.54$ S/m; $\epsilon_r = 54.11$; $\rho = 1000$ kg/m³
Phantom section: Flat Section
Ambient temperature: 22.1°C; Liquid temperature: 21.9°C

DASY5 Configuration:

- Probe: EX3DV4 - SN7466; ConvF(8.04, 8.04, 8.04); Calibrated: 2019/2/4
- Sensor-Surface: 2mm (Mechanical Surface Detection)
- Electronics: DAE4 Sn1336; Calibrated: 2019/8/27
- Phantom: ELI
- DASY52 52.10.1(1476); SEMCAD X 14.6.11(7439)

Area Scan (71x81x1): Interpolated grid: dx=15 mm, dy=15 mm

Maximum value of SAR (interpolated) = 1.35 W/kg

Zoom Scan (5x5x7)/Cube 0: Measurement grid: dx=8mm, dy=8mm, dz=5mm

Reference Value = 3.380 V/m; Power Drift = 0.06 dB

Peak SAR (extrapolated) = 1.23 W/kg

SAR(1 g) = 0.868 W/kg; SAR(10 g) = 0.502 W/kg

Maximum value of SAR (measured) = 1.06 W/kg

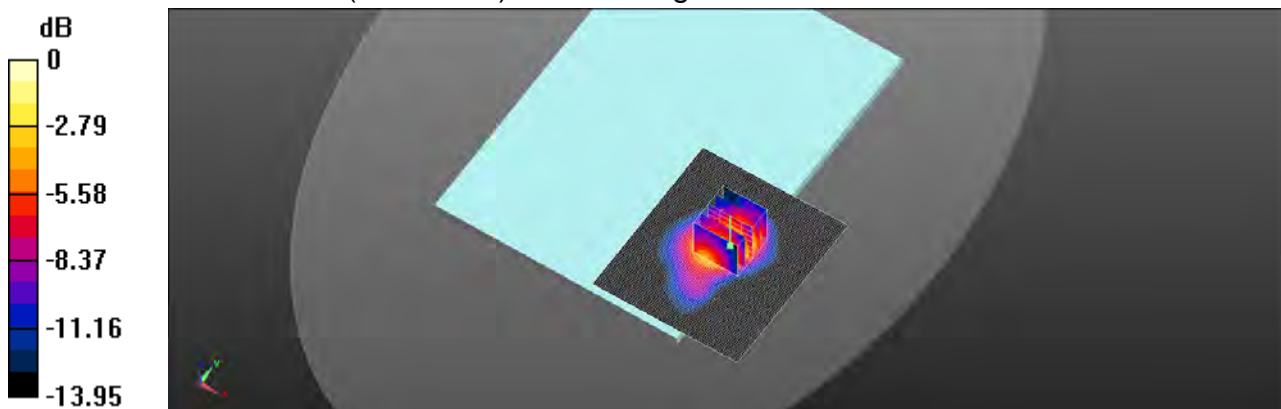

0 dB = 1.06 W/kg = 0.25 dBW/kg

Unless otherwise stated the results shown in this test report refer only to the sample(s) tested and such sample(s) are retained for 90 days only.

除非另有說明，此報告結果僅對測試之樣品負責，同時此樣品僅保留90天。本報告未經本公司書面許可，不可部份複製。

This document is issued by the Company subject to its General Conditions of Service printed overleaf, available on request or accessible at www.sgs.com/terms_and_conditions.htm and for electronic format documents, subject to Terms and Conditions for Electronic Documents at www.sgs.com/terms_e-document.htm. Attention is drawn to the limitation of liability, indemnification and jurisdiction issues defined therein. Any holder of this document is advised that information contained hereon reflects the Company's findings at the time of its intervention only and within the limits of Client's instructions, if any. The Company's sole responsibility is to its Client and this document does not exonerate parties to a transaction from exercising all their rights and obligations under the transaction documents. This document cannot be reproduced except in full, without prior written approval of the Company. Any unauthorized alteration, forgery or falsification of the content or appearance of this document is unlawful and offenders may be prosecuted to the fullest extent of the law.

Date: 2019/11/5

WCDMA Band V_Body_Top side_CH 4132_0mm

Communication System: WCDMA; Frequency: 826.4 MHz; Duty Cycle: 1:1
Medium parameters used: $f = 826.4$ MHz; $\sigma = 0.948$ S/m; $\epsilon_r = 55.488$; $\rho = 1000$ kg/m³
Phantom section: Flat Section
Ambient temperature: 22.1°C; Liquid temperature: 21.8°C

DASY5 Configuration:

- Probe: EX3DV4 - SN7466; ConvF(10.04, 10.04, 10.04); Calibrated: 2019/2/4
- Sensor-Surface: 2mm (Mechanical Surface Detection)
- Electronics: DAE4 Sn1336; Calibrated: 2019/8/27
- Phantom: ELI
- DASY52 52.10.1(1476); SEMCAD X 14.6.11(7439)

Area Scan (51x91x1): Interpolated grid: dx=15 mm, dy=15 mm

Maximum value of SAR (interpolated) = 0.893 W/kg

Zoom Scan (5x5x7)/Cube 0: Measurement grid: dx=8mm, dy=8mm, dz=5mm

Reference Value = 11.99 V/m; Power Drift = -0.07 dB

Peak SAR (extrapolated) = 1.30 W/kg

SAR(1 g) = 0.800 W/kg; SAR(10 g) = 0.460 W/kg

Maximum value of SAR (measured) = 1.15 W/kg

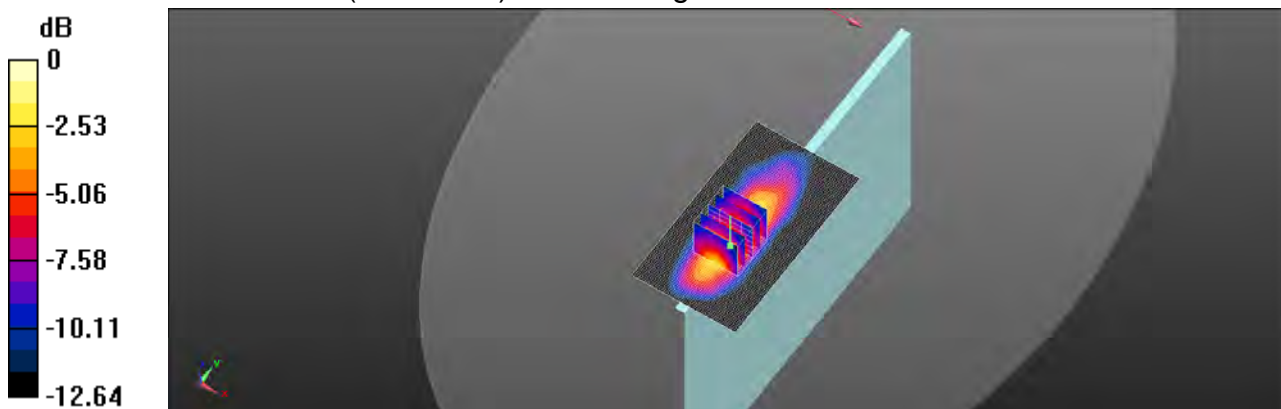

0 dB = 1.15 W/kg = 0.59 dBW/kg

Unless otherwise stated the results shown in this test report refer only to the sample(s) tested and such sample(s) are retained for 90 days only.

除非另有說明，此報告結果僅對測試之樣品負責，同時此樣品僅保留90天。本報告未經本公司書面許可，不可部份複製。

This document is issued by the Company subject to its General Conditions of Service printed overleaf, available on request or accessible at www.sgs.com/terms_and_conditions.htm and for electronic format documents, subject to Terms and Conditions for Electronic Documents at www.sgs.com/terms_e-document.htm. Attention is drawn to the limitation of liability, indemnification and jurisdiction issues defined therein. Any holder of this document is advised that information contained hereon reflects the Company's findings at the time of its intervention only and within the limits of Client's instructions, if any. The Company's sole responsibility is to its Client and this document does not exonerate parties to a transaction from exercising all their rights and obligations under the transaction documents. This document cannot be reproduced except in full, without prior written approval of the Company. Any unauthorized alteration, forgery or falsification of the content or appearance of this document is unlawful and offenders may be prosecuted to the fullest extent of the law.

Date: 2019/11/5

LTE Band 5 (10MHz)_Body_Top side_CH 20450_QPSK_1-0_0mm

Communication System: LTE; Frequency: 829 MHz; Duty Cycle: 1:1

Medium parameters used: $f = 829 \text{ MHz}$; $\sigma = 0.949 \text{ S/m}$; $\epsilon_r = 55.483$; $\rho = 1000 \text{ kg/m}^3$

Phantom section: Flat Section

Ambient temperature: 22.1°C; Liquid temperature: 21.8°C

DASY5 Configuration:

- Probe: EX3DV4 - SN7466; ConvF(10.04, 10.04, 10.04); Calibrated: 2019/2/4
- Sensor-Surface: 2mm (Mechanical Surface Detection)
- Electronics: DAE4 Sn1336; Calibrated: 2019/8/27
- Phantom: ELI
- DASY52 52.10.1(1476); SEMCAD X 14.6.11(7439)

Area Scan (51x81x1): Interpolated grid: dx=15 mm, dy=15 mm

Maximum value of SAR (interpolated) = 1.36 W/kg

Zoom Scan (5x5x7)/Cube 0: Measurement grid: dx=8mm, dy=8mm, dz=5mm

Reference Value = 12.33 V/m; Power Drift = -0.08 dB

Peak SAR (extrapolated) = 1.44 W/kg

SAR(1 g) = 0.891 W/kg; SAR(10 g) = 0.508 W/kg

Maximum value of SAR (measured) = 1.27 W/kg

Zoom Scan (5x5x7)/Cube 1: Measurement grid: dx=8mm, dy=8mm, dz=5mm

Reference Value = 12.33 V/m; Power Drift = -0.08 dB

Peak SAR (extrapolated) = 1.16 W/kg

SAR(1 g) = 0.677 W/kg; SAR(10 g) = 0.374 W/kg

Maximum value of SAR (measured) = 1.05 W/kg

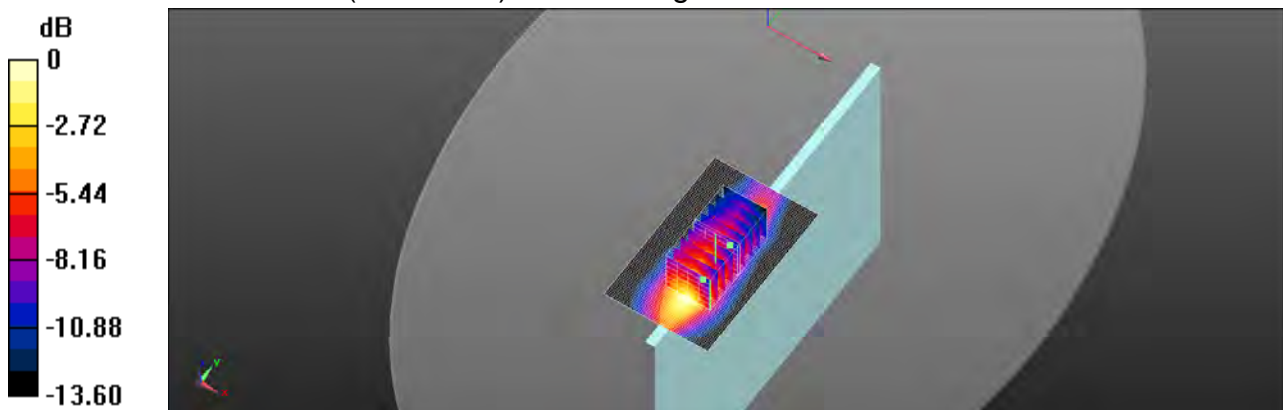

0 dB = 1.05 W/kg = 0.21 dBW/kg

Unless otherwise stated the results shown in this test report refer only to the sample(s) tested and such sample(s) are retained for 90 days only.

除非另有說明，此報告結果僅對測試之樣品負責，同時此樣品僅保留90天。本報告未經本公司書面許可，不可部份複製。

This document is issued by the Company subject to its General Conditions of Service printed overleaf, available on request or accessible at www.sgs.com/terms_and_conditions.htm and for electronic format documents, subject to Terms and Conditions for Electronic Documents at www.sgs.com/terms_e-document.htm. Attention is drawn to the limitation of liability, indemnification and jurisdiction issues defined therein. Any holder of this document is advised that information contained hereon reflects the Company's findings at the time of its intervention only and within the limits of Client's instructions, if any. The Company's sole responsibility is to its Client and this document does not exonerate parties to a transaction from exercising all their rights and obligations under the transaction documents. This document cannot be reproduced except in full, without prior written approval of the Company. Any unauthorized alteration, forgery or falsification of the content or appearance of this document is unlawful and offenders may be prosecuted to the fullest extent of the law.

Date: 2019/11/10

LTE Band 7 (20MHz)_Body_Back side_CH 21350_QPSK_1-0_0mm

Communication System: LTE; Frequency: 2560 MHz; Duty Cycle: 1:1

Medium parameters used: $f = 2560$ MHz; $\sigma = 2.069$ S/m; $\epsilon_r = 52.754$; $\rho = 1000$ kg/m³

Phantom section: Flat Section

Ambient temperature: 22.5°C; Liquid temperature: 21.8°C

DASY5 Configuration:

- Probe: EX3DV4 - SN7466; ConvF(7.47, 7.47, 7.47); Calibrated: 2019/2/4
- Sensor-Surface: 2mm (Mechanical Surface Detection)
- Electronics: DAE4 Sn1336; Calibrated: 2019/8/27
- Phantom: ELI
- DASY52 52.10.1(1476); SEMCAD X 14.6.11(7439)

Area Scan (81x101x1): Interpolated grid: dx=12 mm, dy=12 mm

Maximum value of SAR (interpolated) = 1.25 W/kg

Zoom Scan (7x7x7)/Cube 0: Measurement grid: dx=5mm, dy=5mm, dz=5mm

Reference Value = 4.611 V/m; Power Drift = 0.07 dB

Peak SAR (extrapolated) = 1.34 W/kg

SAR(1 g) = 0.855 W/kg; SAR(10 g) = 0.448 W/kg

Maximum value of SAR (measured) = 1.11 W/kg

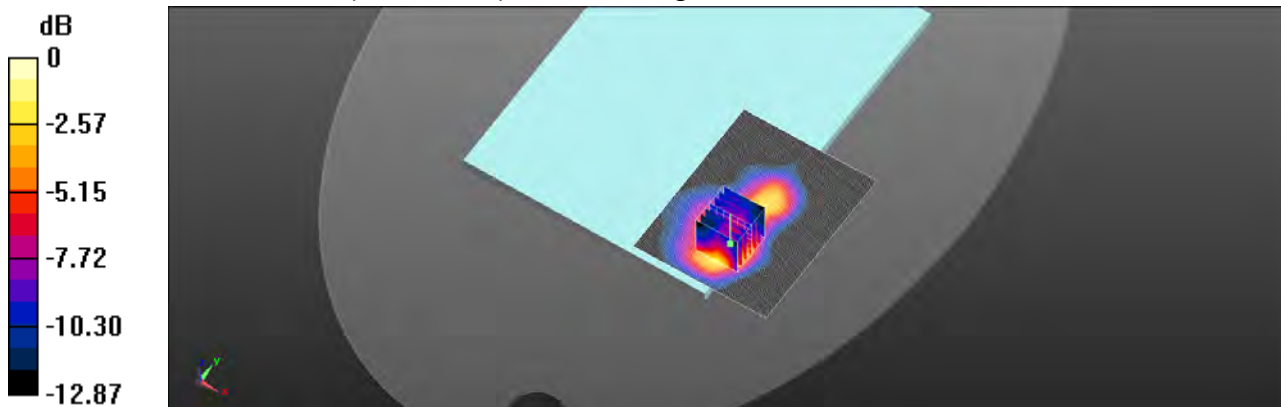

0 dB = 1.11 W/kg = 0.45 dBW/kg

Unless otherwise stated the results shown in this test report refer only to the sample(s) tested and such sample(s) are retained for 90 days only.

除非另有說明，此報告結果僅對測試之樣品負責，同時此樣品僅保留90天。本報告未經本公司書面許可，不可部份複製。

This document is issued by the Company subject to its General Conditions of Service printed overleaf, available on request or accessible at www.sgs.com/terms_and_conditions.htm and for electronic format documents, subject to Terms and Conditions for Electronic Documents at www.sgs.com/terms_e-document.htm. Attention is drawn to the limitation of liability, indemnification and jurisdiction issues defined therein. Any holder of this document is advised that information contained hereon reflects the Company's findings at the time of its intervention only and within the limits of Client's instructions, if any. The Company's sole responsibility is to its Client and this document does not exonerate parties to a transaction from exercising all their rights and obligations under the transaction documents. This document cannot be reproduced except in full, without prior written approval of the Company. Any unauthorized alteration, forgery or falsification of the content or appearance of this document is unlawful and offenders may be prosecuted to the fullest extent of the law.

Date: 2019/11/4

LTE Band 12 (10MHz)_Body_Top side_CH 23095_QPSK_1-25_0mm

Communication System: LTE; Frequency: 707.5 MHz; Duty Cycle: 1:1

Medium parameters used: $f = 707.5$ MHz; $\sigma = 0.939$ S/m; $\epsilon_r = 56.527$; $\rho = 1000$ kg/m³

Phantom section: Flat Section

Ambient temperature: 22.2°C; Liquid temperature: 21.8°C

DASY5 Configuration:

- Probe: EX3DV4 - SN7466; ConvF(10.49, 10.49, 10.49); Calibrated: 2019/2/4
- Sensor-Surface: 2mm (Mechanical Surface Detection)
- Electronics: DAE4 Sn1336; Calibrated: 2019/8/27
- Phantom: ELI
- DASY52 52.10.1(1476); SEMCAD X 14.6.11(7439)

Area Scan (51x81x1): Interpolated grid: dx=15 mm, dy=15 mm

Maximum value of SAR (interpolated) = 1.03 W/kg

Zoom Scan (5x5x7)/Cube 0: Measurement grid: dx=8mm, dy=8mm, dz=5mm

Reference Value = 14.01 V/m; Power Drift = -0.02 dB

Peak SAR (extrapolated) = 1.13 W/kg

SAR(1 g) = 0.703 W/kg; SAR(10 g) = 0.389 W/kg

Maximum value of SAR (measured) = 0.998 W/kg

Zoom Scan (5x5x7)/Cube 1: Measurement grid: dx=8mm, dy=8mm, dz=5mm

Reference Value = 14.01 V/m; Power Drift = -0.02 dB

Peak SAR (extrapolated) = 0.815 W/kg

SAR(1 g) = 0.489 W/kg; SAR(10 g) = 0.288 W/kg

Maximum value of SAR (measured) = 0.740 W/kg

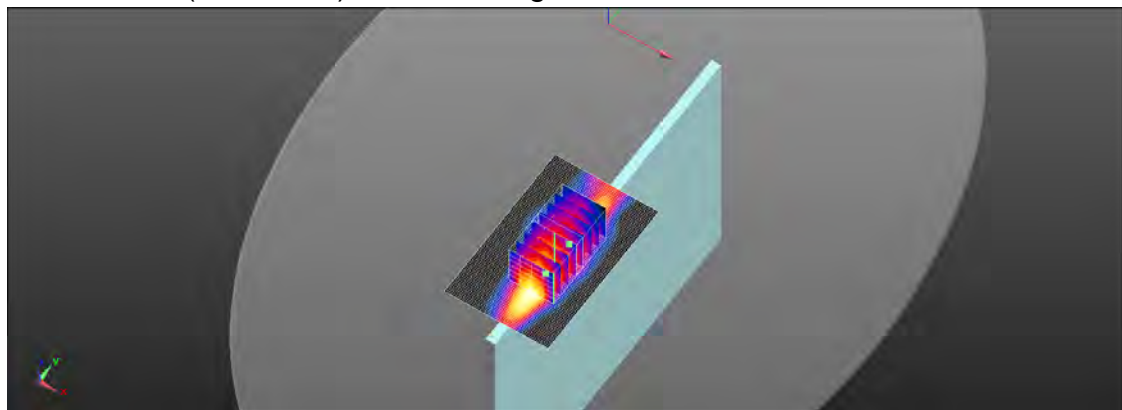
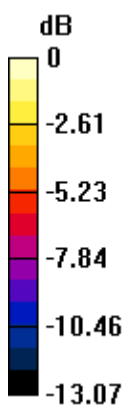

0 dB = 0.740 W/kg = -1.31 dBW/kg

Unless otherwise stated the results shown in this test report refer only to the sample(s) tested and such sample(s) are retained for 90 days only.

除非另有說明，此報告結果僅對測試之樣品負責，同時此樣品僅保留90天。本報告未經本公司書面許可，不可部份複製。

This document is issued by the Company subject to its General Conditions of Service printed overleaf, available on request or accessible at www.sgs.com/terms_and_conditions.htm and for electronic format documents, subject to Terms and Conditions for Electronic Documents at www.sgs.com/terms_e-document.htm. Attention is drawn to the limitation of liability, indemnification and jurisdiction issues defined therein. Any holder of this document is advised that information contained hereon reflects the Company's findings at the time of its intervention only and within the limits of Client's instructions, if any. The Company's sole responsibility is to its Client and this document does not exonerate parties to a transaction from exercising all their rights and obligations under the transaction documents. This document cannot be reproduced except in full, without prior written approval of the Company. Any unauthorized alteration, forgery or falsification of the content or appearance of this document is unlawful and offenders may be prosecuted to the fullest extent of the law.

Date: 2019/11/4

LTE Band 13 (10MHz)_Body_Top side_CH 23230_QPSK_1-49_0mm

Communication System: LTE; Frequency: 782 MHz; Duty Cycle: 1:1

Medium parameters used: $f = 782 \text{ MHz}$; $\sigma = 0.942 \text{ S/m}$; $\epsilon_r = 56.221$; $\rho = 1000 \text{ kg/m}^3$

Phantom section: Flat Section

Ambient temperature: 22.2°C ; Liquid temperature: 21.8°C

DASY5 Configuration:

- Probe: EX3DV4 - SN7466; ConvF(10.49, 10.49, 10.49); Calibrated: 2019/2/4
- Sensor-Surface: 2mm (Mechanical Surface Detection)
- Electronics: DAE4 Sn1336; Calibrated: 2019/8/27
- Phantom: ELI
- DASY52 52.10.1(1476); SEMCAD X 14.6.11(7439)

Area Scan (51x91x1): Interpolated grid: $dx=15 \text{ mm}$, $dy=15 \text{ mm}$

Maximum value of SAR (interpolated) = 0.935 W/kg

Zoom Scan (5x5x7)/Cube 0: Measurement grid: $dx=8\text{mm}$, $dy=8\text{mm}$, $dz=5\text{mm}$

Reference Value = 13.22 V/m ; Power Drift = -0.01 dB

Peak SAR (extrapolated) = 1.33 W/kg

SAR(1 g) = 0.834 W/kg ; SAR(10 g) = 0.482 W/kg

Maximum value of SAR (measured) = 1.17 W/kg

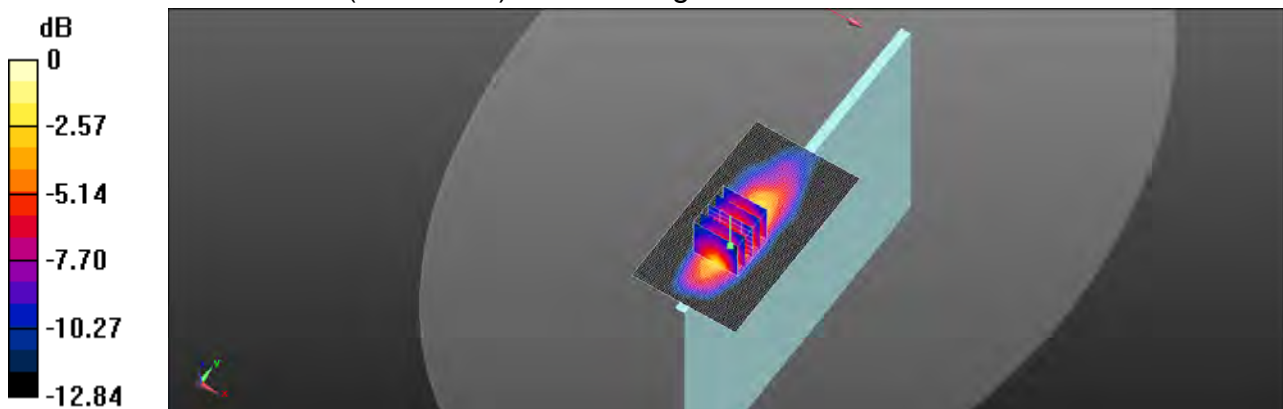

0 dB = 1.17 W/kg = 0.69 dBW/kg

Unless otherwise stated the results shown in this test report refer only to the sample(s) tested and such sample(s) are retained for 90 days only.

除非另有說明，此報告結果僅對測試之樣品負責，同時此樣品僅保留90天。本報告未經本公司書面許可，不可部份複製。

This document is issued by the Company subject to its General Conditions of Service printed overleaf, available on request or accessible at www.sgs.com/terms_and_conditions.htm and for electronic format documents, subject to Terms and Conditions for Electronic Documents at www.sgs.com/terms_e-document.htm. Attention is drawn to the limitation of liability, indemnification and jurisdiction issues defined therein. Any holder of this document is advised that information contained hereon reflects the Company's findings at the time of its intervention only and within the limits of Client's instructions, if any. The Company's sole responsibility is to its Client and this document does not exonerate parties to a transaction from exercising all their rights and obligations under the transaction documents. This document cannot be reproduced except in full, without prior written approval of the Company. Any unauthorized alteration, forgery or falsification of the content or appearance of this document is unlawful and offenders may be prosecuted to the fullest extent of the law.

Date: 2019/11/4

LTE Band 14 (10MHz)_Body_Top side_CH 23330_QPSK_1-49_0mm

Communication System: LTE; Frequency: 793 MHz; Duty Cycle: 1:1

Medium parameters used: $f = 793 \text{ MHz}$; $\sigma = 0.943 \text{ S/m}$; $\epsilon_r = 56.186$; $\rho = 1000 \text{ kg/m}^3$

Phantom section: Flat Section

Ambient temperature: 22.2°C; Liquid temperature: 21.8°C

DASY5 Configuration:

- Probe: EX3DV4 - SN7466; ConvF(10.49, 10.49, 10.49); Calibrated: 2019/2/4
- Sensor-Surface: 2mm (Mechanical Surface Detection)
- Electronics: DAE4 Sn1336; Calibrated: 2019/8/27
- Phantom: ELI
- DASY52 52.10.1(1476); SEMCAD X 14.6.11(7439)

Area Scan (51x91x1): Interpolated grid: dx=15 mm, dy=15 mm

Maximum value of SAR (interpolated) = 0.885 W/kg

Zoom Scan (5x5x7)/Cube 0: Measurement grid: dx=8mm, dy=8mm, dz=5mm

Reference Value = 12.56 V/m; Power Drift = -0.04 dB

Peak SAR (extrapolated) = 1.25 W/kg

SAR(1 g) = 0.766 W/kg; SAR(10 g) = 0.441 W/kg

Maximum value of SAR (measured) = 1.10 W/kg

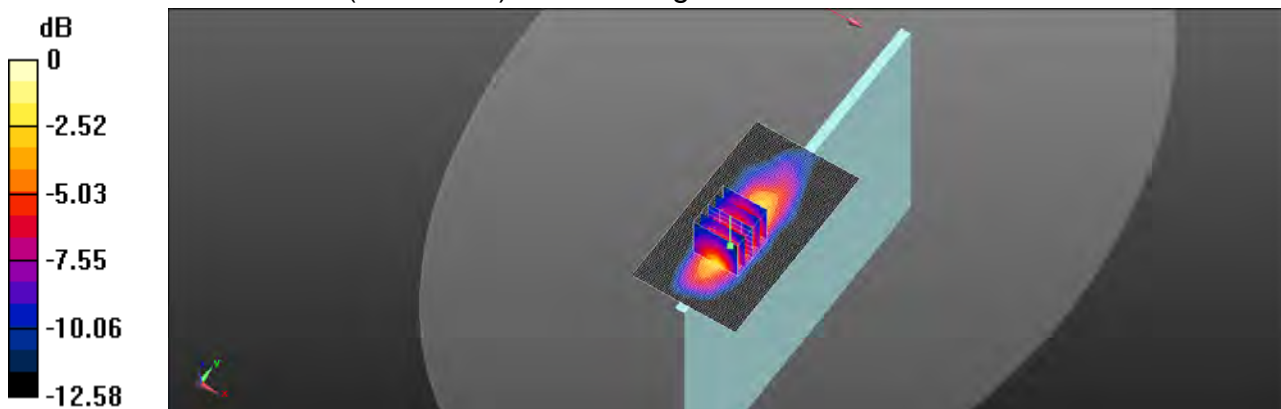

0 dB = 1.10 W/kg = 0.41 dBW/kg

Unless otherwise stated the results shown in this test report refer only to the sample(s) tested and such sample(s) are retained for 90 days only.
除非另有說明，此報告結果僅對測試之樣品負責，同時此樣品僅保留90天。本報告未經本公司書面許可，不可部份複製。

This document is issued by the Company subject to its General Conditions of Service printed overleaf, available on request or accessible at www.sgs.com/terms_and_conditions.htm and for electronic format documents, subject to Terms and Conditions for Electronic Documents at www.sgs.com/terms_e-document.htm. Attention is drawn to the limitation of liability, indemnification and jurisdiction issues defined therein. Any holder of this document is advised that information contained hereon reflects the Company's findings at the time of its intervention only and within the limits of Client's instructions, if any. The Company's sole responsibility is to its Client and this document does not exonerate parties to a transaction from exercising all their rights and obligations under the transaction documents. This document cannot be reproduced except in full, without prior written approval of the Company. Any unauthorized alteration, forgery or falsification of the content or appearance of this document is unlawful and offenders may be prosecuted to the fullest extent of the law.

Date: 2019/11/7

LTE Band 25 (20MHz)_Body_Back side_CH 26140_QPSK_1-0_0mm

Communication System: LTE; Frequency: 1860 MHz; Duty Cycle: 1:1

Medium parameters used: $f = 1860$ MHz; $\sigma = 1.534$ S/m; $\epsilon_r = 54.152$; $\rho = 1000$ kg/m³

Phantom section: Flat Section

Ambient temperature: 22.1°C; Liquid temperature: 21.9°C

DASY5 Configuration:

- Probe: EX3DV4 - SN7466; ConvF(8.04, 8.04, 8.04); Calibrated: 2019/2/4
- Sensor-Surface: 2mm (Mechanical Surface Detection)
- Electronics: DAE4 Sn1336; Calibrated: 2019/8/27
- Phantom: ELI
- DASY52 52.10.1(1476); SEMCAD X 14.6.11(7439)

Area Scan (71x81x1): Interpolated grid: dx=15 mm, dy=15 mm

Maximum value of SAR (interpolated) = 1.27 W/kg

Zoom Scan (5x5x7)/Cube 0: Measurement grid: dx=8mm, dy=8mm, dz=5mm

Reference Value = 4.208 V/m; Power Drift = 0.02 dB

Peak SAR (extrapolated) = 1.20 W/kg

SAR(1 g) = 0.879 W/kg; SAR(10 g) = 0.516 W/kg

Maximum value of SAR (measured) = 1.06 W/kg

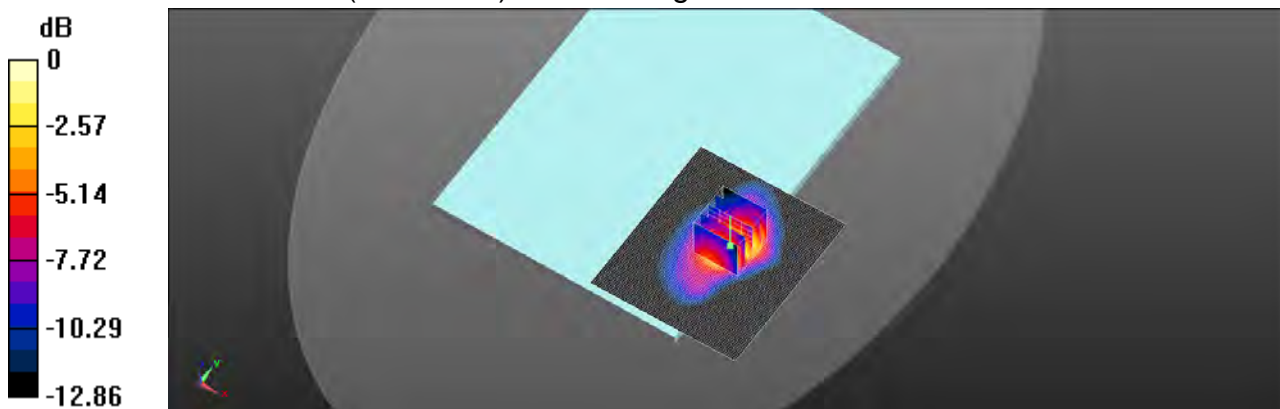

0 dB = 1.06 W/kg = 0.24 dBW/kg

Unless otherwise stated the results shown in this test report refer only to the sample(s) tested and such sample(s) are retained for 90 days only.

除非另有說明，此報告結果僅對測試之樣品負責，同時此樣品僅保留90天。本報告未經本公司書面許可，不可部份複製。

This document is issued by the Company subject to its General Conditions of Service printed overleaf, available on request or accessible at www.sgs.com/terms_and_conditions.htm and for electronic format documents, subject to Terms and Conditions for Electronic Documents at www.sgs.com/terms_e-document.htm. Attention is drawn to the limitation of liability, indemnification and jurisdiction issues defined therein. Any holder of this document is advised that information contained hereon reflects the Company's findings at the time of its intervention only and within the limits of Client's instructions, if any. The Company's sole responsibility is to its Client and this document does not exonerate parties to a transaction from exercising all their rights and obligations under the transaction documents. This document cannot be reproduced except in full, without prior written approval of the Company. Any unauthorized alteration, forgery or falsification of the content or appearance of this document is unlawful and offenders may be prosecuted to the fullest extent of the law.

Date: 2019/11/5

LTE Band 26 (15MHz)_Body_Top side_CH 26765_QPSK_1-36_0mm

Communication System: LTE; Frequency: 821.5 MHz; Duty Cycle: 1:1

Medium parameters used: $f = 821.5 \text{ MHz}$; $\sigma = 0.944 \text{ S/m}$; $\epsilon_r = 55.61$; $\rho = 1000 \text{ kg/m}^3$

Phantom section: Flat Section

Ambient temperature: 22.1°C; Liquid temperature: 21.8°C

DASY5 Configuration:

- Probe: EX3DV4 - SN7466; ConvF(10.04, 10.04, 10.04); Calibrated: 2019/2/4
- Sensor-Surface: 2mm (Mechanical Surface Detection)
- Electronics: DAE4 Sn1336; Calibrated: 2019/8/27
- Phantom: ELI
- DASY52 52.10.1(1476); SEMCAD X 14.6.11(7439)

Area Scan (51x91x1): Interpolated grid: dx=15 mm, dy=15 mm

Maximum value of SAR (interpolated) = 0.952 W/kg

Zoom Scan (5x5x7)/Cube 0: Measurement grid: dx=8mm, dy=8mm, dz=5mm

Reference Value = 11.61 V/m; Power Drift = -0.03 dB

Peak SAR (extrapolated) = 1.42 W/kg

SAR(1 g) = 0.887 W/kg; SAR(10 g) = 0.509 W/kg

Maximum value of SAR (measured) = 1.27 W/kg

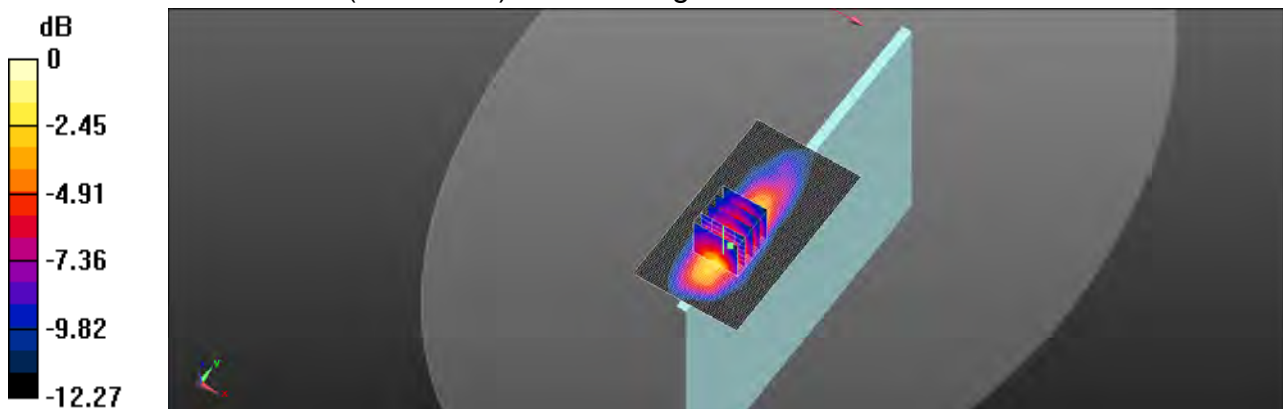

0 dB = 1.27 W/kg = 1.05 dBW/kg

Unless otherwise stated the results shown in this test report refer only to the sample(s) tested and such sample(s) are retained for 90 days only.

除非另有說明，此報告結果僅對測試之樣品負責，同時此樣品僅保留90天。本報告未經本公司書面許可，不可部份複製。

This document is issued by the Company subject to its General Conditions of Service printed overleaf, available on request or accessible at www.sgs.com/terms_and_conditions.htm and for electronic format documents, subject to Terms and Conditions for Electronic Documents at www.sgs.com/terms_e-document.htm. Attention is drawn to the limitation of liability, indemnification and jurisdiction issues defined therein. Any holder of this document is advised that information contained hereon reflects the Company's findings at the time of its intervention only and within the limits of Client's instructions, if any. The Company's sole responsibility is to its Client and this document does not exonerate parties to a transaction from exercising all their rights and obligations under the transaction documents. This document cannot be reproduced except in full, without prior written approval of the Company. Any unauthorized alteration, forgery or falsification of the content or appearance of this document is unlawful and offenders may be prosecuted to the fullest extent of the law.

Date: 2019/11/8

LTE Band 30 (10MHz)_Body_Back side_CH 27710_QPSK_1-0_0mm

Communication System: LTE; Frequency: 2310 MHz; Duty Cycle: 1:1

Medium parameters used: $f = 2310$ MHz; $\sigma = 1.769$ S/m; $\epsilon_r = 54.078$; $\rho = 1000$ kg/m³

Phantom section: Flat Section

Ambient temperature: 22.4°C; Liquid temperature: 21.8°C

DASY5 Configuration:

- Probe: EX3DV4 - SN7466; ConvF(7.84, 7.84, 7.84); Calibrated: 2019/2/4
- Sensor-Surface: 2mm (Mechanical Surface Detection)
- Electronics: DAE4 Sn1336; Calibrated: 2019/8/27
- Phantom: ELI
- DASY52 52.10.1(1476); SEMCAD X 14.6.11(7439)

Area Scan (81x101x1): Interpolated grid: dx=12 mm, dy=12 mm

Maximum value of SAR (interpolated) = 1.21 W/kg

Zoom Scan (7x7x7)/Cube 0: Measurement grid: dx=5mm, dy=5mm, dz=5mm

Reference Value = 2.849 V/m; Power Drift = 0.03 dB

Peak SAR (extrapolated) = 1.18 W/kg

SAR(1 g) = 0.836 W/kg; SAR(10 g) = 0.498 W/kg

Maximum value of SAR (measured) = 1.04 W/kg

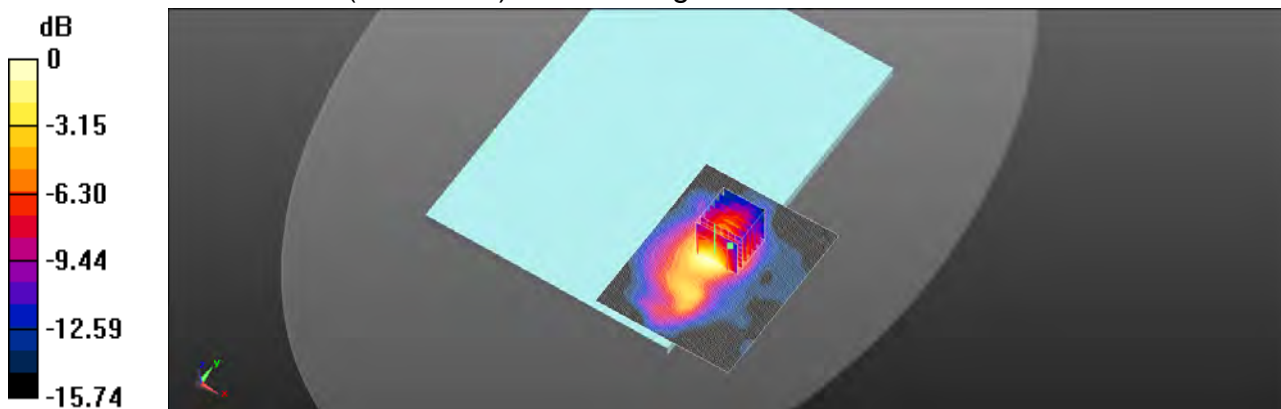

0 dB = 1.04 W/kg = 0.19 dBW/kg

Unless otherwise stated the results shown in this test report refer only to the sample(s) tested and such sample(s) are retained for 90 days only.
除非另有說明，此報告結果僅對測試之樣品負責，同時此樣品僅保留90天。本報告未經本公司書面許可，不可部份複製。

This document is issued by the Company subject to its General Conditions of Service printed overleaf, available on request or accessible at www.sgs.com/terms_and_conditions.htm and for electronic format documents, subject to Terms and Conditions for Electronic Documents at www.sgs.com/terms_e-document.htm. Attention is drawn to the limitation of liability, indemnification and jurisdiction issues defined therein. Any holder of this document is advised that information contained hereon reflects the Company's findings at the time of its intervention only and within the limits of Client's instructions, if any. The Company's sole responsibility is to its Client and this document does not exonerate parties to a transaction from exercising all their rights and obligations under the transaction documents. This document cannot be reproduced except in full, without prior written approval of the Company. Any unauthorized alteration, forgery or falsification of the content or appearance of this document is unlawful and offenders may be prosecuted to the fullest extent of the law.

Date: 2019/11/10

LTE Band 41 (20MHz)_Body_Back side_CH 41490_QPSK_1-0_0mm

Communication System: LTE; Frequency: 2680 MHz; Duty Cycle: 1:1.59956
Medium parameters used: $f = 2680$ MHz; $\sigma = 2.237$ S/m; $\epsilon_r = 51.801$; $\rho = 1000$ kg/m³
Phantom section: Flat Section
Ambient temperature: 22.5°C; Liquid temperature: 21.8°C

DASY5 Configuration:

- Probe: EX3DV4 - SN7466; ConvF(7.47, 7.47, 7.47); Calibrated: 2019/2/4
- Sensor-Surface: 2mm (Mechanical Surface Detection)
- Electronics: DAE4 Sn1336; Calibrated: 2019/8/27
- Phantom: ELI
- DASY52 52.10.1(1476); SEMCAD X 14.6.11(7439)

Area Scan (81x101x1): Interpolated grid: dx=12 mm, dy=12 mm
Maximum value of SAR (interpolated) = 1.00 W/kg

Zoom Scan (7x7x7)/Cube 0: Measurement grid: dx=5mm, dy=5mm, dz=5mm
Reference Value = 4.299 V/m; Power Drift = 0.05 dB
Peak SAR (extrapolated) = 1.04 W/kg
SAR(1 g) = 0.685 W/kg; SAR(10 g) = 0.369 W/kg
Maximum value of SAR (measured) = 0.906 W/kg

Zoom Scan (7x7x7)/Cube 1: Measurement grid: dx=5mm, dy=5mm, dz=5mm
Reference Value = 4.299 V/m; Power Drift = 0.05 dB
Peak SAR (extrapolated) = 1.09 W/kg
SAR(1 g) = 0.494 W/kg; SAR(10 g) = 0.253 W/kg
Maximum value of SAR (measured) = 0.758 W/kg

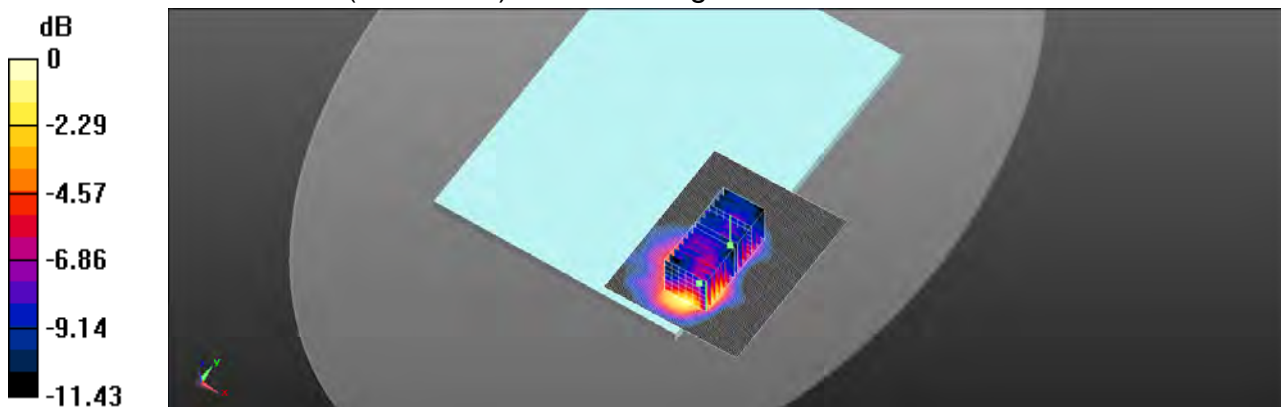

0 dB = 0.758 W/kg = -1.21 dBW/kg

Unless otherwise stated the results shown in this test report refer only to the sample(s) tested and such sample(s) are retained for 90 days only.
除非另有說明，此報告結果僅對測試之樣品負責，同時此樣品僅保留90天。本報告未經本公司書面許可，不可部份複製。

This document is issued by the Company subject to its General Conditions of Service printed overleaf, available on request or accessible at www.sgs.com/terms_and_conditions.htm and for electronic format documents, subject to Terms and Conditions for Electronic Documents at www.sgs.com/terms_e-document.htm. Attention is drawn to the limitation of liability, indemnification and jurisdiction issues defined therein. Any holder of this document is advised that information contained hereon reflects the Company's findings at the time of its intervention only and within the limits of Client's instructions, if any. The Company's sole responsibility is to its Client and this document does not exonerate parties to a transaction from exercising all their rights and obligations under the transaction documents. This document cannot be reproduced except in full, without prior written approval of the Company. Any unauthorized alteration, forgery or falsification of the content or appearance of this document is unlawful and offenders may be prosecuted to the fullest extent of the law.

Date: 2019/11/6

LTE Band 66 (20MHz)_Body_Back side_CH 132572_QPSK_1-0_0mm

Communication System: LTE; Frequency: 1770 MHz; Duty Cycle: 1:1

Medium parameters used: $f = 1770$ MHz; $\sigma = 1.521$ S/m; $\epsilon_r = 54.185$; $\rho = 1000$ kg/m³

Phantom section: Flat Section

Ambient temperature: 22.3°C; Liquid temperature: 21.8°C

DASY5 Configuration:

- Probe: EX3DV4 - SN7466; ConvF(8.48, 8.48, 8.48); Calibrated: 2019/2/4
- Sensor-Surface: 2mm (Mechanical Surface Detection)
- Electronics: DAE4 Sn1336; Calibrated: 2019/8/27
- Phantom: ELI
- DASY52 52.10.1(1476); SEMCAD X 14.6.11(7439)

Area Scan (71x81x1): Interpolated grid: dx=15 mm, dy=15 mm

Maximum value of SAR (interpolated) = 1.13 W/kg

Zoom Scan (5x5x7)/Cube 0: Measurement grid: dx=8mm, dy=8mm, dz=5mm

Reference Value = 3.414 V/m; Power Drift = 0.07 dB

Peak SAR (extrapolated) = 1.22 W/kg

SAR(1 g) = 0.894 W/kg; SAR(10 g) = 0.504 W/kg

Maximum value of SAR (measured) = 1.13 W/kg

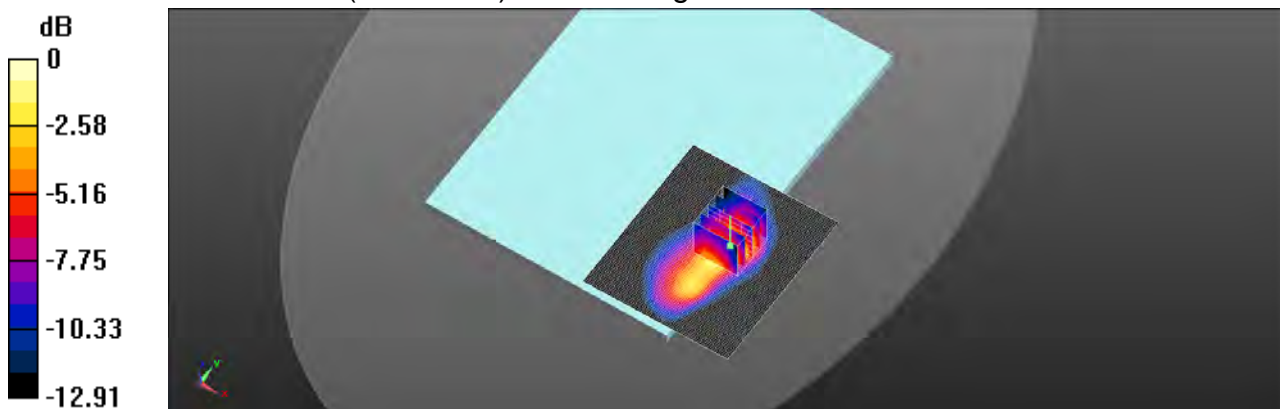

0 dB = 1.13 W/kg = 0.53 dBW/kg

Unless otherwise stated the results shown in this test report refer only to the sample(s) tested and such sample(s) are retained for 90 days only.

除非另有說明，此報告結果僅對測試之樣品負責，同時此樣品僅保留90天。本報告未經本公司書面許可，不可部份複製。

This document is issued by the Company subject to its General Conditions of Service printed overleaf, available on request or accessible at www.sgs.com/terms_and_conditions.htm and for electronic format documents, subject to Terms and Conditions for Electronic Documents at www.sgs.com/terms_e-document.htm. Attention is drawn to the limitation of liability, indemnification and jurisdiction issues defined therein. Any holder of this document is advised that information contained hereon reflects the Company's findings at the time of its intervention only and within the limits of Client's instructions, if any. The Company's sole responsibility is to its Client and this document does not exonerate parties to a transaction from exercising all their rights and obligations under the transaction documents. This document cannot be reproduced except in full, without prior written approval of the Company. Any unauthorized alteration, forgery or falsification of the content or appearance of this document is unlawful and offenders may be prosecuted to the fullest extent of the law.

Date: 2019/11/9

WLAN 802.11b Body Back side CH 6 0mm Tx1

Communication System: WLAN 2.45G; Frequency: 2437 MHz; Duty Cycle: 1:0.989
Medium parameters used: $f = 2437$ MHz; $\sigma = 1.884$ S/m; $\epsilon_r = 52.903$; $\rho = 1000$ kg/m³
Phantom section: Flat Section
Ambient temperature: 22.1°C; Liquid temperature: 21.1°C

DASY5 Configuration:

- Probe: EX3DV4 - SN7466; ConvF(7.71, 7.71, 7.71); Calibrated: 2019/2/4
- Sensor-Surface: 2mm (Mechanical Surface Detection)
- Electronics: DAE4 Sn1336; Calibrated: 2019/8/27
- Phantom: ELI
- DASY52 52.10.1(1476); SEMCAD X 14.6.11(7439)

Area Scan (51x71x1): Interpolated grid: dx=12 mm, dy=12 mm

Maximum value of SAR (interpolated) = 0.326 W/kg

Zoom Scan (7x7x7)/Cube 0: Measurement grid: dx=5mm, dy=5mm, dz=5mm

Reference Value = 4.889 V/m; Power Drift = -0.05 dB

Peak SAR (extrapolated) = 0.484 W/kg

SAR(1 g) = 0.214 W/kg; SAR(10 g) = 0.120 W/kg

Maximum value of SAR (measured) = 0.311 W/kg

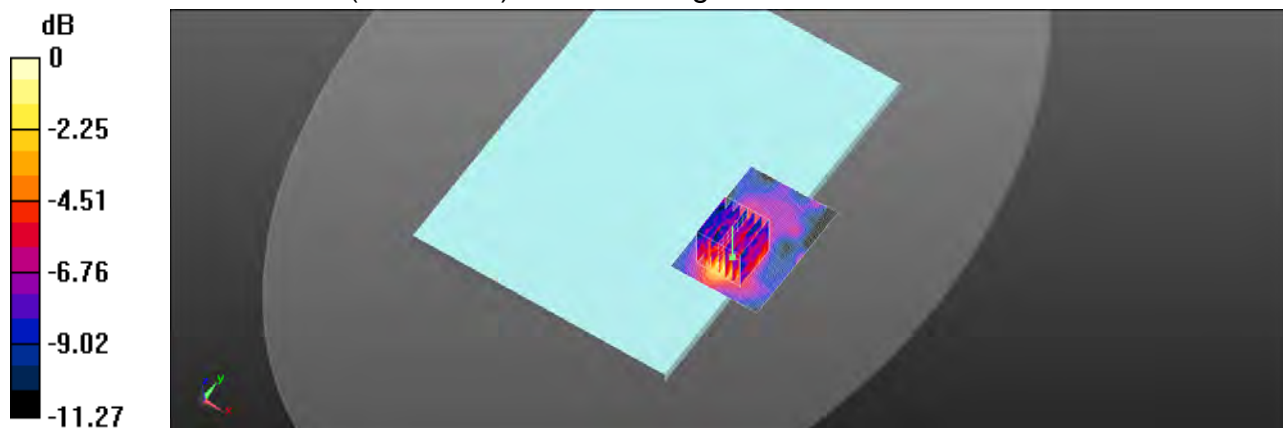

0 dB = 0.311 W/kg = -5.08 dBW/kg

Unless otherwise stated the results shown in this test report refer only to the sample(s) tested and such sample(s) are retained for 90 days only.
除非另有說明，此報告結果僅對測試之樣品負責，同時此樣品僅保留90天。本報告未經本公司書面許可，不可部份複製。

This document is issued by the Company subject to its General Conditions of Service printed overleaf, available on request or accessible at www.sgs.com/terms_and_conditions.htm and for electronic format documents, subject to Terms and Conditions for Electronic Documents at www.sgs.com/terms_e-document.htm. Attention is drawn to the limitation of liability, indemnification and jurisdiction issues defined therein. Any holder of this document is advised that information contained hereon reflects the Company's findings at the time of its intervention only and within the limits of Client's instructions, if any. The Company's sole responsibility is to its Client and this document does not exonerate parties to a transaction from exercising all their rights and obligations under the transaction documents. This document cannot be reproduced except in full, without prior written approval of the Company. Any unauthorized alteration, forgery or falsification of the content or appearance of this document is unlawful and offenders may be prosecuted to the fullest extent of the law.

Date: 2019/11/11

WLAN 802.11ac(160M) 5.2G Body Back side CH 50_0mm Tx1

Communication System: WLAN 5G; Frequency: 5250 MHz; Duty Cycle: 1:0.985
Medium parameters used: $f = 5250$ MHz; $\sigma = 5.223$ S/m; $\epsilon_r = 49.807$; $\rho = 1000$ kg/m³
Phantom section: Flat Section
Ambient temperature: 22.1°C; Liquid temperature: 21.2°C

DASY5 Configuration:

- Probe: EX3DV4 - SN7466; ConvF(4.95, 4.95, 4.95); Calibrated: 2019/2/4
- Sensor-Surface: 2mm (Mechanical Surface Detection)
- Electronics: DAE4 Sn1336; Calibrated: 2019/8/27
- Phantom: ELI
- DASY52 52.10.1(1476); SEMCAD X 14.6.11(7439)

Area Scan (71x121x1): Interpolated grid: dx=10 mm, dy=10 mm
Maximum value of SAR (interpolated) = 0.114 W/kg

Zoom Scan (7x7x12)/Cube 0: Measurement grid: dx=4mm, dy=4mm, dz=2mm
Reference Value = 3.163 V/m; Power Drift = 0.02 dB
Peak SAR (extrapolated) = 0.276 W/kg
SAR(1 g) = 0.114 W/kg; SAR(10 g) = 0.095 W/kg
Maximum value of SAR (measured) = 0.153 W/kg

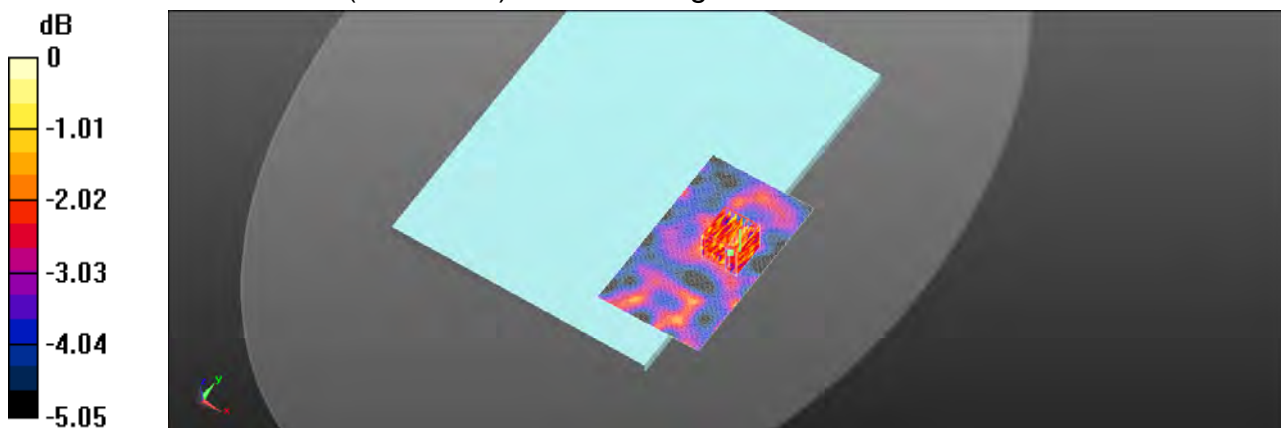

0 dB = 0.153 W/kg = -8.16 dBW/kg

Unless otherwise stated the results shown in this test report refer only to the sample(s) tested and such sample(s) are retained for 90 days only.
除非另有說明，此報告結果僅對測試之樣品負責，同時此樣品僅保留90天。本報告未經本公司書面許可，不可部份複製。

This document is issued by the Company subject to its General Conditions of Service printed overleaf, available on request or accessible at www.sgs.com/terms_and_conditions.htm and for electronic format documents, subject to Terms and Conditions for Electronic Documents at www.sgs.com/terms_e-document.htm. Attention is drawn to the limitation of liability, indemnification and jurisdiction issues defined therein. Any holder of this document is advised that information contained hereon reflects the Company's findings at the time of its intervention only and within the limits of Client's instructions, if any. The Company's sole responsibility is to its Client and this document does not exonerate parties to a transaction from exercising all their rights and obligations under the transaction documents. This document cannot be reproduced except in full, without prior written approval of the Company. Any unauthorized alteration, forgery or falsification of the content or appearance of this document is unlawful and offenders may be prosecuted to the fullest extent of the law.

Date: 2019/11/12

WLAN 802.11ac(80M) 5.3G Body Back side_CH 58_0mm_Tx1

Communication System: IEEE 802.11ac; Frequency: 5290 MHz; Duty Cycle: 1:0.99
Medium parameters used: $f = 5290$ MHz; $\sigma = 5.263$ S/m; $\epsilon_r = 49.799$; $\rho = 1000$ kg/m³
Phantom section: Flat Section
Ambient temperature: 22.6°C; Liquid temperature: 21.8°C

DASY5 Configuration:

- Probe: EX3DV4 - SN7466; ConvF(4.8, 4.8, 4.8); Calibrated: 2019/2/4
- Sensor-Surface: 2mm (Mechanical Surface Detection)
- Electronics: DAE4 Sn1336; Calibrated: 2019/8/27
- Phantom: ELI
- DASY52 52.10.1(1476); SEMCAD X 14.6.11(7439)

Wifi g/Area Scan (71x111x1): Interpolated grid: dx=10 mm, dy=10 mm
Maximum value of SAR (interpolated) = 0.235 W/kg

Wifi g/Zoom Scan (7x7x12)/Cube 0: Measurement grid: dx=4mm, dy=4mm, dz=2mm

Reference Value = 4.320 V/m; Power Drift = 0.02 dB

Peak SAR (extrapolated) = 1.25 W/kg

SAR(1 g) = 0.207 W/kg; SAR(10 g) = 0.159 W/kg

Maximum value of SAR (measured) = 0.294 W/kg

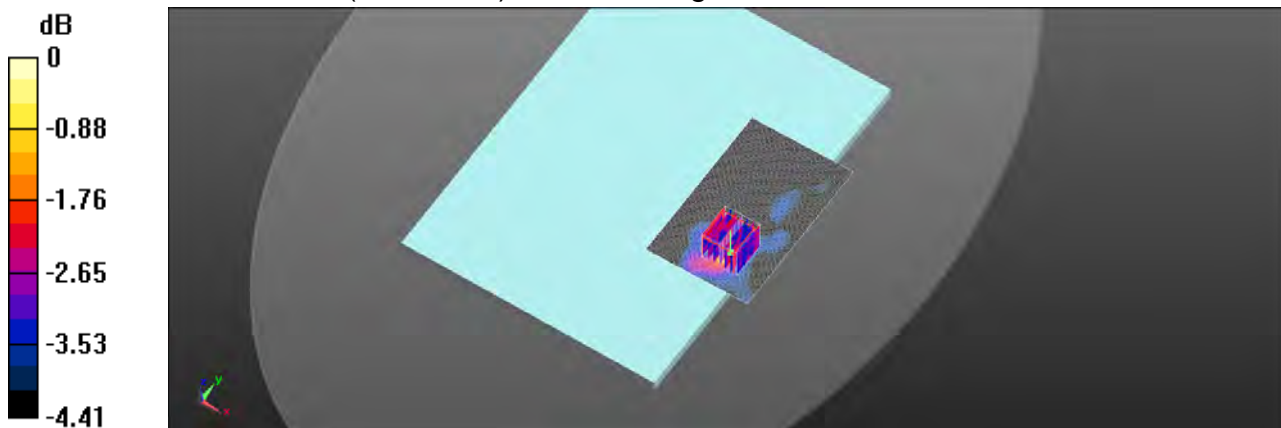

0 dB = 0.294 W/kg = -5.32 dBW/kg

Unless otherwise stated the results shown in this test report refer only to the sample(s) tested and such sample(s) are retained for 90 days only.

除非另有說明，此報告結果僅對測試之樣品負責，同時此樣品僅保留90天。本報告未經本公司書面許可，不可部份複製。

This document is issued by the Company subject to its General Conditions of Service printed overleaf, available on request or accessible at www.sgs.com/terms_and_conditions.htm and for electronic format documents, subject to Terms and Conditions for Electronic Documents at www.sgs.com/terms_e-document.htm. Attention is drawn to the limitation of liability, indemnification and jurisdiction issues defined therein. Any holder of this document is advised that information contained hereon reflects the Company's findings at the time of its intervention only and within the limits of Client's instructions, if any. The Company's sole responsibility is to its Client and this document does not exonerate parties to a transaction from exercising all their rights and obligations under the transaction documents. This document cannot be reproduced except in full, without prior written approval of the Company. Any unauthorized alteration, forgery or falsification of the content or appearance of this document is unlawful and offenders may be prosecuted to the fullest extent of the law.

Date: 2019/11/13

WLAN 802.11ac(160M) 5.6G Body Back side CH 114 0mm Tx1

Communication System: WLAN 5G; Frequency: 5570 MHz; Duty Cycle: 1: 0.985
Medium parameters used: $f = 5570 \text{ MHz}$; $\sigma = 5.83 \text{ S/m}$; $\epsilon_r = 49.199$; $\rho = 1000 \text{ kg/m}^3$
Phantom section: Flat Section
Ambient temperature: 22.1°C; Liquid temperature: 21.3°C

DASY5 Configuration:

- Probe: EX3DV4 - SN7466; ConvF(4.22, 4.22, 4.22); Calibrated: 2019/2/4
- Sensor-Surface: 2mm (Mechanical Surface Detection)
- Electronics: DAE4 Sn1336; Calibrated: 2019/8/27
- Phantom: ELI
- DASY52 52.10.1(1476); SEMCAD X 14.6.11(7439)

Area Scan (71x111x1): Interpolated grid: dx=10 mm, dy=10 mm
Maximum value of SAR (interpolated) = 0.281 W/kg

Zoom Scan (7x7x12)/Cube 0: Measurement grid: dx=4mm, dy=4mm, dz=2mm
Reference Value = 4.957 V/m; Power Drift = 0.06 dB
Peak SAR (extrapolated) = 1.34 W/kg
SAR(1 g) = 0.220 W/kg; SAR(10 g) = 0.173 W/kg
Maximum value of SAR (measured) = 0.339 W/kg

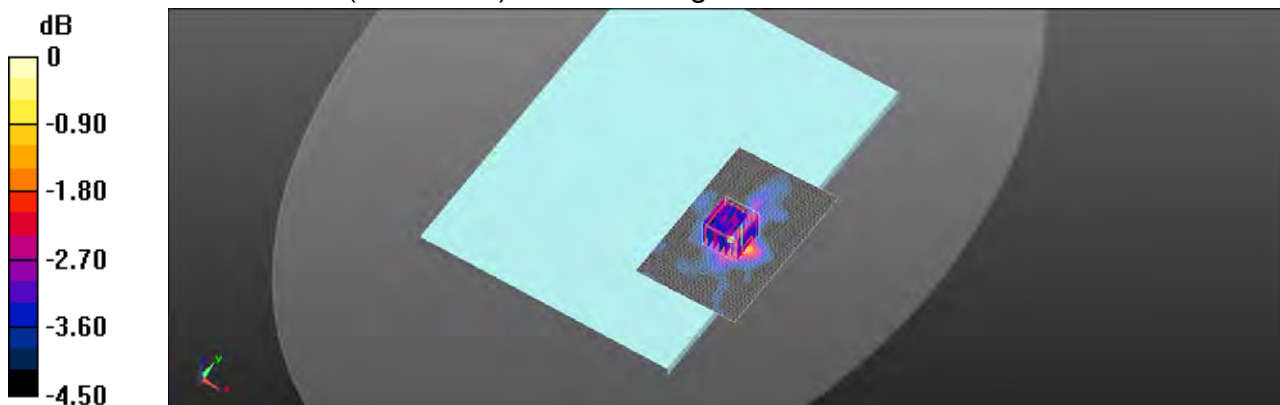

0 dB = 0.339 W/kg = -4.70 dBW/kg

Unless otherwise stated the results shown in this test report refer only to the sample(s) tested and such sample(s) are retained for 90 days only.
除非另有說明，此報告結果僅對測試之樣品負責，同時此樣品僅保留90天。本報告未經本公司書面許可，不可部份複製。

This document is issued by the Company subject to its General Conditions of Service printed overleaf, available on request or accessible at www.sgs.com/terms_and_conditions.htm and for electronic format documents, subject to Terms and Conditions for Electronic Documents at www.sgs.com/terms_e-document.htm. Attention is drawn to the limitation of liability, indemnification and jurisdiction issues defined therein. Any holder of this document is advised that information contained hereon reflects the Company's findings at the time of its intervention only and within the limits of Client's instructions, if any. The Company's sole responsibility is to its Client and this document does not exonerate parties to a transaction from exercising all their rights and obligations under the transaction documents. This document cannot be reproduced except in full, without prior written approval of the Company. Any unauthorized alteration, forgery or falsification of the content or appearance of this document is unlawful and offenders may be prosecuted to the fullest extent of the law.

Date: 2019/11/14

WLAN 802.11ac(80M) 5.8G Body Back side CH 155_0mm Tx1

Communication System: WLAN 5G; Frequency: 5775 MHz; Duty Cycle: 1: 0.99
Medium parameters used: $f = 5775$ MHz; $\sigma = 5.888$ S/m; $\epsilon_r = 48.147$; $\rho = 1000$ kg/m³
Phantom section: Flat Section
Ambient temperature: 22.7°C; Liquid temperature: 21.8°C

DASY5 Configuration:

- Probe: EX3DV4 - SN7466; ConvF(4.38, 4.38, 4.38); Calibrated: 2019/2/4
- Sensor-Surface: 2mm (Mechanical Surface Detection)
- Electronics: DAE4 Sn1336; Calibrated: 2019/8/27
- Phantom: ELI
- DASY52 52.10.1(1476); SEMCAD X 14.6.11(7439)

Area Scan (71x111x1): Interpolated grid: dx=10 mm, dy=10 mm

Maximum value of SAR (interpolated) = 0.155 W/kg

Zoom Scan (7x7x12)/Cube 0: Measurement grid: dx=4mm, dy=4mm, dz=2mm

Reference Value = 5.064 V/m; Power Drift = 0.04 dB

Peak SAR (extrapolated) = 0.238 W/kg

SAR(1 g) = 0.201 W/kg; SAR(10 g) = 0.179 W/kg

Maximum value of SAR (measured) = 0.238 W/kg

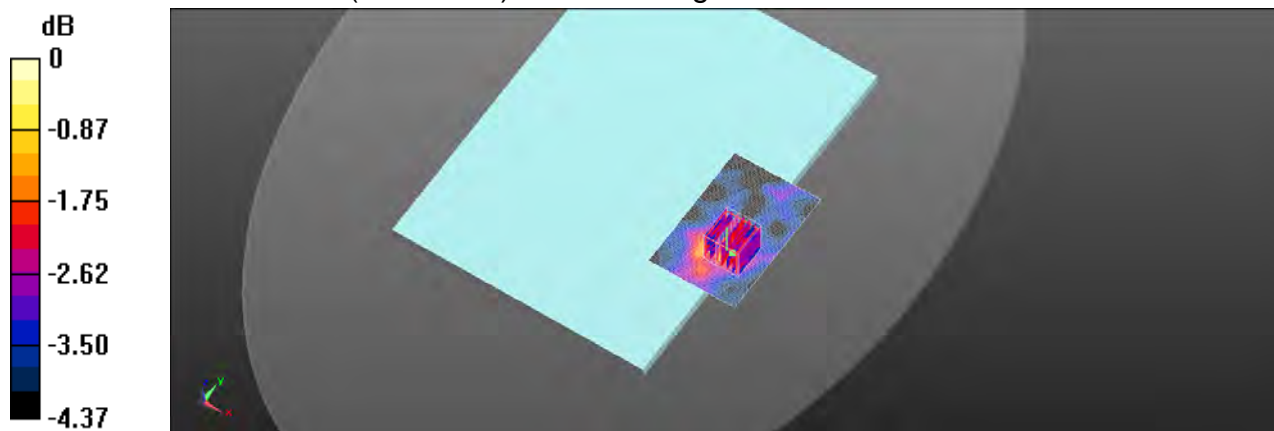

0 dB = 0.238 W/kg = -6.24 dBW/kg

Unless otherwise stated the results shown in this test report refer only to the sample(s) tested and such sample(s) are retained for 90 days only.

除非另有說明，此報告結果僅對測試之樣品負責，同時此樣品僅保留90天。本報告未經本公司書面許可，不可部份複製。

This document is issued by the Company subject to its General Conditions of Service printed overleaf, available on request or accessible at www.sgs.com/terms_and_conditions.htm and for electronic format documents, subject to Terms and Conditions for Electronic Documents at www.sgs.com/terms_e-document.htm. Attention is drawn to the limitation of liability, indemnification and jurisdiction issues defined therein. Any holder of this document is advised that information contained hereon reflects the Company's findings at the time of its intervention only and within the limits of Client's instructions, if any. The Company's sole responsibility is to its Client and this document does not exonerate parties to a transaction from exercising all their rights and obligations under the transaction documents. This document cannot be reproduced except in full, without prior written approval of the Company. Any unauthorized alteration, forgery or falsification of the content or appearance of this document is unlawful and offenders may be prosecuted to the fullest extent of the law.

Date: 2019/11/9

WLAN 802.11b Body Back side CH 6 4mm Tx2

Communication System: WLAN 2.45G; Frequency: 2437 MHz; Duty Cycle: 1: 0.989
Medium parameters used: $f = 2437 \text{ MHz}$; $\sigma = 1.884 \text{ S/m}$; $\epsilon_r = 52.903$; $\rho = 1000 \text{ kg/m}^3$
Phantom section: Flat Section
Ambient temperature: 22.1°C ; Liquid temperature: 21.1°C

DASY5 Configuration:

- Probe: EX3DV4 - SN7466; ConvF(7.71, 7.71, 7.71); Calibrated: 2019/2/4
- Sensor-Surface: 2mm (Mechanical Surface Detection)
- Electronics: DAE4 Sn1336; Calibrated: 2019/8/27
- Phantom: ELI
- DASY52 52.10.1(1476); SEMCAD X 14.6.11(7439)

Area Scan (71x91x1): Interpolated grid: $dx=12 \text{ mm}$, $dy=12 \text{ mm}$

Maximum value of SAR (interpolated) = 0.234 W/kg

Zoom Scan (7x7x7)/Cube 0: Measurement grid: $dx=5\text{mm}$, $dy=5\text{mm}$, $dz=5\text{mm}$

Reference Value = 4.295 V/m ; Power Drift = -0.01 dB

Peak SAR (extrapolated) = 0.278 W/kg

SAR(1 g) = 0.187 W/kg ; SAR(10 g) = 0.111 W/kg

Maximum value of SAR (measured) = 0.231 W/kg

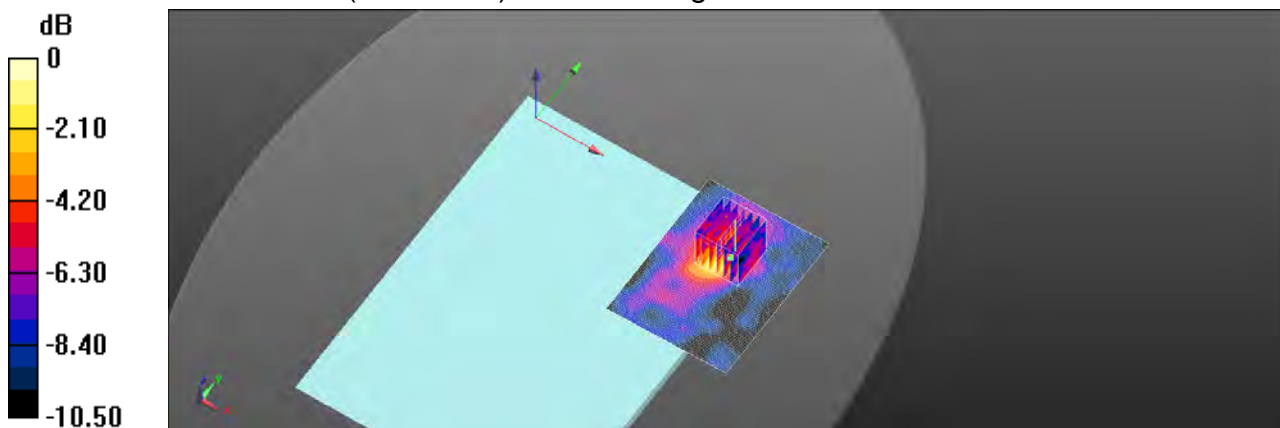

0 dB = 0.231 W/kg = -6.37 dBW/kg

Unless otherwise stated the results shown in this test report refer only to the sample(s) tested and such sample(s) are retained for 90 days only.
除非另有說明，此報告結果僅對測試之樣品負責，同時此樣品僅保留90天。本報告未經本公司書面許可，不可部份複製。

This document is issued by the Company subject to its General Conditions of Service printed overleaf, available on request or accessible at www.sgs.com/terms_and_conditions.htm and for electronic format documents, subject to Terms and Conditions for Electronic Documents at www.sgs.com/terms_e-document.htm. Attention is drawn to the limitation of liability, indemnification and jurisdiction issues defined therein. Any holder of this document is advised that information contained hereon reflects the Company's findings at the time of its intervention only and within the limits of Client's instructions, if any. The Company's sole responsibility is to its Client and this document does not exonerate parties to a transaction from exercising all their rights and obligations under the transaction documents. This document cannot be reproduced except in full, without prior written approval of the Company. Any unauthorized alteration, forgery or falsification of the content or appearance of this document is unlawful and offenders may be prosecuted to the fullest extent of the law.

Date: 2019/11/9

Bluetooth(GFSK)_Body_Back side_CH 39_0mm_Tx2

Communication System: Bluetooth; Frequency: 2441 MHz; Duty Cycle: 1:0.768
Medium parameters used: $f = 2441$ MHz; $\sigma = 1.895$ S/m; $\epsilon_r = 52.894$; $\rho = 1000$ kg/m³
Phantom section: Flat Section
Ambient temperature: 22.1°C; Liquid temperature: 21.1°C

DASY5 Configuration:

- Probe: EX3DV4 - SN7466; ConvF(7.71, 7.71, 7.71); Calibrated: 2019/2/4
- Sensor-Surface: 2mm (Mechanical Surface Detection)
- Electronics: DAE4 Sn1336; Calibrated: 2019/8/27
- Phantom: ELI
- DASY52 52.10.1(1476); SEMCAD X 14.6.11(7439)

Area Scan (61x91x1): Interpolated grid: dx=12 mm, dy=12 mm

Maximum value of SAR (interpolated) = 0.128 W/kg

Zoom Scan (7x7x7)/Cube 0: Measurement grid: dx=5mm, dy=5mm, dz=5mm

Reference Value = 1.071 V/m; Power Drift = 0.06 dB

Peak SAR (extrapolated) = 0.179 W/kg

SAR(1 g) = 0.048 W/kg; SAR(10 g) = 0.024 W/kg

Maximum value of SAR (measured) = 0.111 W/kg

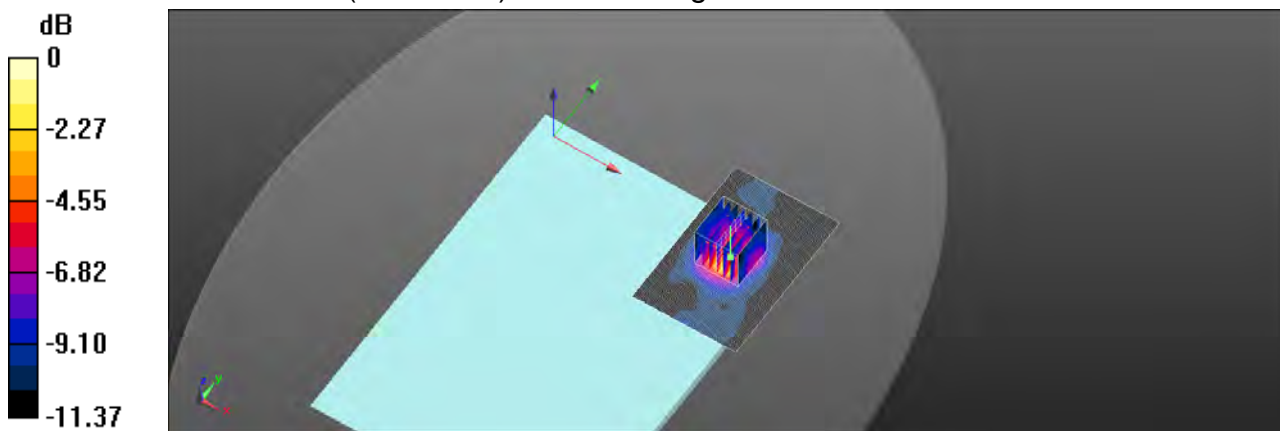

0 dB = 0.111 W/kg = -8.22 dBW/kg

Unless otherwise stated the results shown in this test report refer only to the sample(s) tested and such sample(s) are retained for 90 days only.

除非另有說明，此報告結果僅對測試之樣品負責，同時此樣品僅保留90天。本報告未經本公司書面許可，不可部份複製。

This document is issued by the Company subject to its General Conditions of Service printed overleaf, available on request or accessible at www.sgs.com/terms_and_conditions.htm and for electronic format documents, subject to Terms and Conditions for Electronic Documents at www.sgs.com/terms_e-document.htm. Attention is drawn to the limitation of liability, indemnification and jurisdiction issues defined therein. Any holder of this document is advised that information contained hereon reflects the Company's findings at the time of its intervention only and within the limits of Client's instructions, if any. The Company's sole responsibility is to its Client and this document does not exonerate parties to a transaction from exercising all their rights and obligations under the transaction documents. This document cannot be reproduced except in full, without prior written approval of the Company. Any unauthorized alteration, forgery or falsification of the content or appearance of this document is unlawful and offenders may be prosecuted to the fullest extent of the law.

Date: 2019/11/11

WLAN 802.11ac(80M) 5.2G_Body_Back side_CH 50_4mm_Tx2

Communication System: WLAN 5G; Frequency: 5250 MHz; Duty Cycle: 1: 0.99
Medium parameters used: $f = 5250$ MHz; $\sigma = 5.223$ S/m; $\epsilon_r = 49.807$; $\rho = 1000$ kg/m³
Phantom section: Flat Section
Ambient temperature: 22.1°C; Liquid temperature: 21.2°C

DASY5 Configuration:

- Probe: EX3DV4 - SN7466; ConvF(4.95, 4.95, 4.95); Calibrated: 2019/2/4
- Sensor-Surface: 2mm (Mechanical Surface Detection)
- Electronics: DAE4 Sn1336; Calibrated: 2019/8/27
- Phantom: ELI
- DASY52 52.10.1(1476); SEMCAD X 14.6.11(7439)

Area Scan (71x121x1): Interpolated grid: dx=10 mm, dy=10 mm
Maximum value of SAR (interpolated) = 0.252 W/kg

Zoom Scan (7x7x12)/Cube 0: Measurement grid: dx=4mm, dy=4mm, dz=2mm
Reference Value = 3.722 V/m; Power Drift = 0.02 dB
Peak SAR (extrapolated) = 0.683 W/kg
SAR(1 g) = 0.183 W/kg; SAR(10 g) = 0.134 W/kg
Maximum value of SAR (measured) = 0.243 W/kg

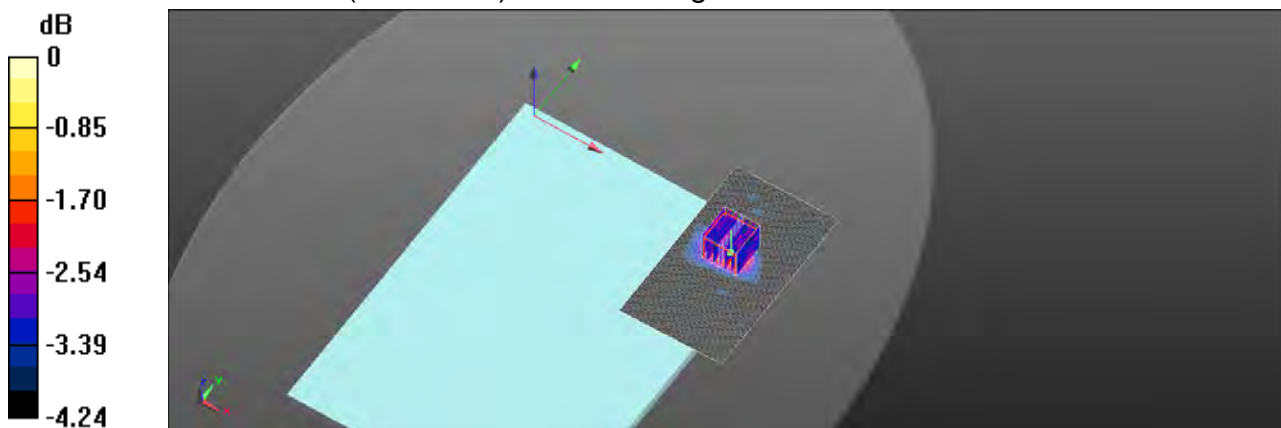

0 dB = 0.243 W/kg = -6.14 dBW/kg

Unless otherwise stated the results shown in this test report refer only to the sample(s) tested and such sample(s) are retained for 90 days only.
除非另有說明，此報告結果僅對測試之樣品負責，同時此樣品僅保留90天。本報告未經本公司書面許可，不可部份複製。

This document is issued by the Company subject to its General Conditions of Service printed overleaf, available on request or accessible at www.sgs.com/terms_and_conditions.htm and for electronic format documents, subject to Terms and Conditions for Electronic Documents at www.sgs.com/terms_e-document.htm. Attention is drawn to the limitation of liability, indemnification and jurisdiction issues defined therein. Any holder of this document is advised that information contained hereon reflects the Company's findings at the time of its intervention only and within the limits of Client's instructions, if any. The Company's sole responsibility is to its Client and this document does not exonerate parties to a transaction from exercising all their rights and obligations under the transaction documents. This document cannot be reproduced except in full, without prior written approval of the Company. Any unauthorized alteration, forgery or falsification of the content or appearance of this document is unlawful and offenders may be prosecuted to the fullest extent of the law.

Date: 2019/11/12

WLAN 802.11ac(80M) 5.3G_Body_Back side_CH 58_4mm_Tx2

Communication System: WLAN 5G; Frequency: 5290 MHz; Duty Cycle: 1: 0.99
Medium parameters used: $f = 5290$ MHz; $\sigma = 5.263$ S/m; $\epsilon_r = 49.799$; $\rho = 1000$ kg/m³
Phantom section: Flat Section
Ambient temperature: 22.6°C; Liquid temperature: 21.8°C

DASY5 Configuration:

- Probe: EX3DV4 - SN7466; ConvF(4.8, 4.8, 4.8); Calibrated: 2019/2/4
- Sensor-Surface: 2mm (Mechanical Surface Detection)
- Electronics: DAE4 Sn1336; Calibrated: 2019/8/27
- Phantom: ELI
- DASY52 52.10.1(1476); SEMCAD X 14.6.11(7439)

Area Scan (71x121x1): Interpolated grid: dx=10 mm, dy=10 mm
Maximum value of SAR (interpolated) = 0.228 W/kg

Zoom Scan (7x7x12)/Cube 0: Measurement grid: dx=4mm, dy=4mm, dz=2mm
Reference Value = 3.143 V/m; Power Drift = 0.02 dB
Peak SAR (extrapolated) = 0.442 W/kg
SAR(1 g) = 0.173 W/kg; SAR(10 g) = 0.127 W/kg
Maximum value of SAR (measured) = 0.243 W/kg

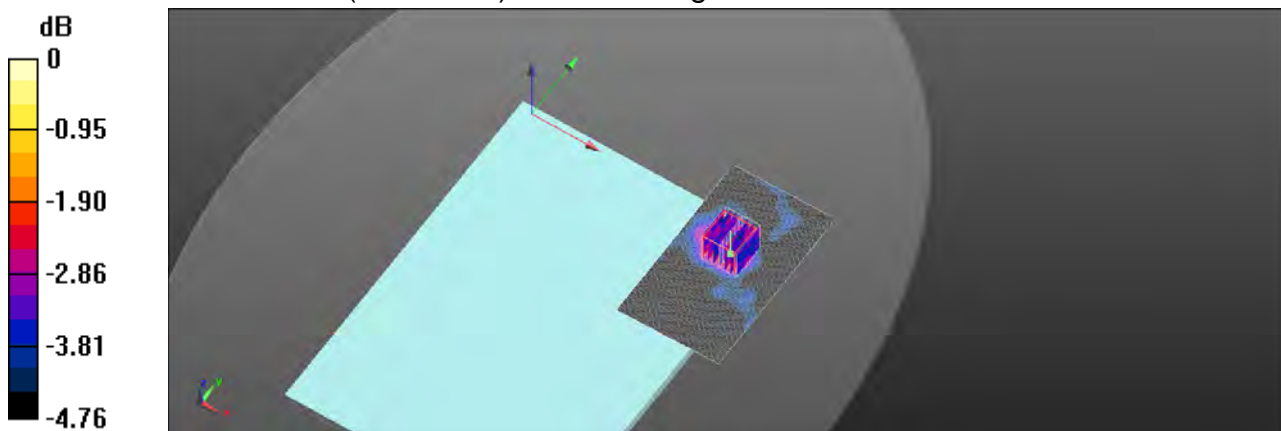

0 dB = 0.243 W/kg = -6.14 dBW/kg

Unless otherwise stated the results shown in this test report refer only to the sample(s) tested and such sample(s) are retained for 90 days only.
除非另有說明，此報告結果僅對測試之樣品負責，同時此樣品僅保留90天。本報告未經本公司書面許可，不可部份複製。

This document is issued by the Company subject to its General Conditions of Service printed overleaf, available on request or accessible at www.sgs.com/terms_and_conditions.htm and for electronic format documents, subject to Terms and Conditions for Electronic Documents at www.sgs.com/terms_e-document.htm. Attention is drawn to the limitation of liability, indemnification and jurisdiction issues defined therein. Any holder of this document is advised that information contained hereon reflects the Company's findings at the time of its intervention only and within the limits of Client's instructions, if any. The Company's sole responsibility is to its Client and this document does not exonerate parties to a transaction from exercising all their rights and obligations under the transaction documents. This document cannot be reproduced except in full, without prior written approval of the Company. Any unauthorized alteration, forgery or falsification of the content or appearance of this document is unlawful and offenders may be prosecuted to the fullest extent of the law.

Date: 2019/11/13

WLAN 802.11ac(160M) 5.6G Body Back side CH 114 4mm Tx2

Communication System: WLAN 5G; Frequency: 5570 MHz; Duty Cycle: 1: 0.985
Medium parameters used: $f = 5570$ MHz; $\sigma = 5.83$ S/m; $\epsilon_r = 49.199$; $\rho = 1000$ kg/m³
Phantom section: Flat Section
Ambient temperature: 22.1°C; Liquid temperature: 21.3°C

DASY5 Configuration:

- Probe: EX3DV4 - SN7466; ConvF(4.22, 4.22, 4.22); Calibrated: 2019/2/4
- Sensor-Surface: 2mm (Mechanical Surface Detection)
- Electronics: DAE4 Sn1336; Calibrated: 2019/8/27
- Phantom: ELI
- DASY52 52.10.1(1476); SEMCAD X 14.6.11(7439)

Area Scan (71x121x1): Interpolated grid: dx=10 mm, dy=10 mm
Maximum value of SAR (interpolated) = 0.251 W/kg

Zoom Scan (7x7x12)/Cube 0: Measurement grid: dx=4mm, dy=4mm, dz=2mm
Reference Value = 3.842 V/m; Power Drift = -0.04 dB
Peak SAR (extrapolated) = 0.262 W/kg
SAR(1 g) = 0.101 W/kg; SAR(10 g) = 0.086 W/kg
Maximum value of SAR (measured) = 0.136 W/kg

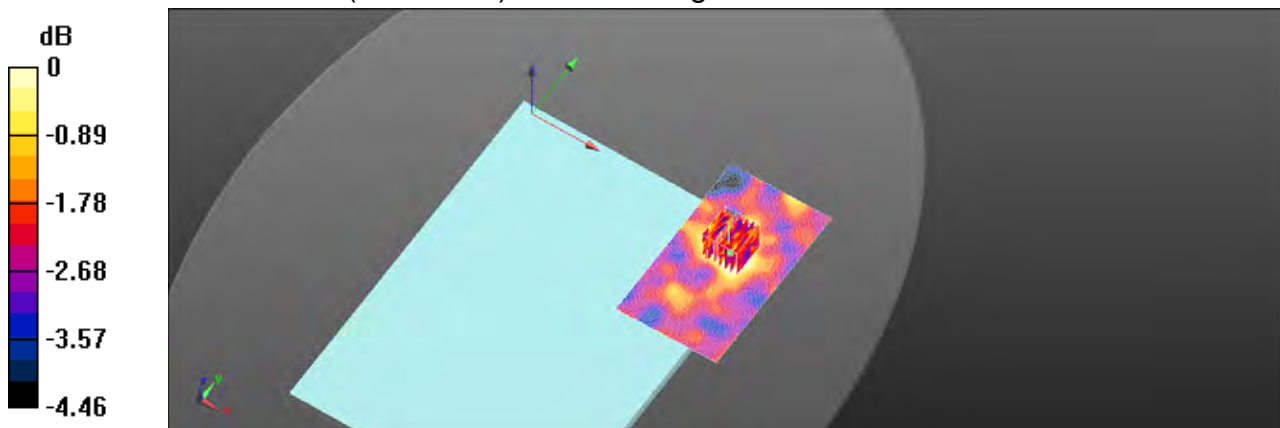

0 dB = 0.136 W/kg = -8.67 dBW/kg

Unless otherwise stated the results shown in this test report refer only to the sample(s) tested and such sample(s) are retained for 90 days only.
除非另有說明，此報告結果僅對測試之樣品負責，同時此樣品僅保留90天。本報告未經本公司書面許可，不可部份複製。

This document is issued by the Company subject to its General Conditions of Service printed overleaf, available on request or accessible at www.sgs.com/terms_and_conditions.htm and for electronic format documents, subject to Terms and Conditions for Electronic Documents at www.sgs.com/terms_e-document.htm. Attention is drawn to the limitation of liability, indemnification and jurisdiction issues defined therein. Any holder of this document is advised that information contained hereon reflects the Company's findings at the time of its intervention only and within the limits of Client's instructions, if any. The Company's sole responsibility is to its Client and this document does not exonerate parties to a transaction from exercising all their rights and obligations under the transaction documents. This document cannot be reproduced except in full, without prior written approval of the Company. Any unauthorized alteration, forgery or falsification of the content or appearance of this document is unlawful and offenders may be prosecuted to the fullest extent of the law.

Date: 2019/11/14

WLAN 802.11ac(80M) 5.8G_Body_Back side_CH 155_4mm_Tx2

Communication System: WLAN 5G; Frequency: 5775 MHz; Duty Cycle: 1: 0.99
Medium parameters used: $f = 5775$ MHz; $\sigma = 5.888$ S/m; $\epsilon_r = 48.147$; $\rho = 1000$ kg/m³
Phantom section: Flat Section
Ambient temperature: 22.7°C; Liquid temperature: 21.8°C

DASY5 Configuration:

- Probe: EX3DV4 - SN7466; ConvF(4.38, 4.38, 4.38); Calibrated: 2019/2/4
- Sensor-Surface: 2mm (Mechanical Surface Detection)
- Electronics: DAE4 Sn1336; Calibrated: 2019/8/27
- Phantom: ELI
- DASY52 52.10.1(1476); SEMCAD X 14.6.11(7439)

Area Scan (71x121x1): Interpolated grid: dx=10 mm, dy=10 mm
Maximum value of SAR (interpolated) = 0.179 W/kg

Zoom Scan (7x7x12)/Cube 0: Measurement grid: dx=4mm, dy=4mm, dz=2mm
Reference Value = 4.204 V/m; Power Drift = 0.05 dB
Peak SAR (extrapolated) = 0.199 W/kg
SAR(1 g) = 0.160 W/kg; SAR(10 g) = 0.146 W/kg
Maximum value of SAR (measured) = 0.199 W/kg

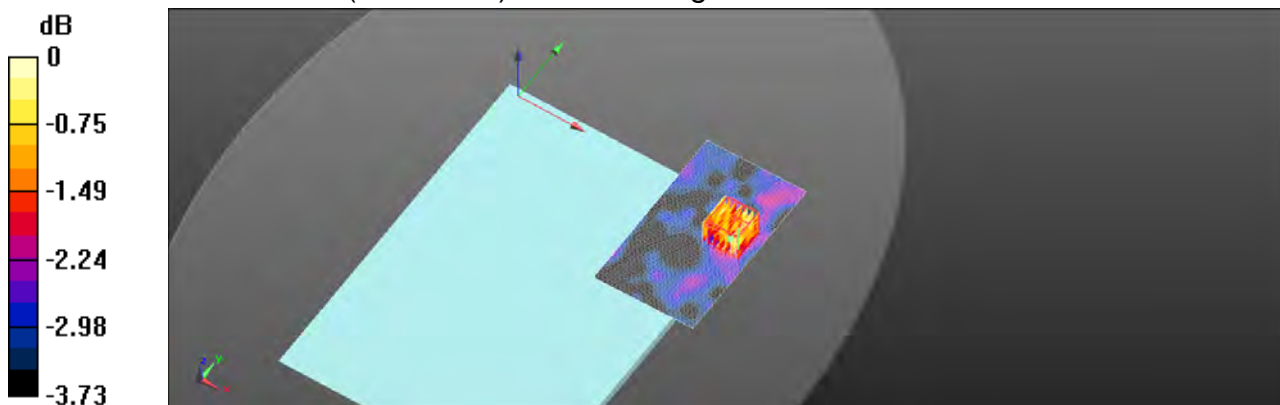

0 dB = 0.199 W/kg = -7.01 dBW/kg

Unless otherwise stated the results shown in this test report refer only to the sample(s) tested and such sample(s) are retained for 90 days only.
除非另有說明，此報告結果僅對測試之樣品負責，同時此樣品僅保留90天。本報告未經本公司書面許可，不可部份複製。

This document is issued by the Company subject to its General Conditions of Service printed overleaf, available on request or accessible at www.sgs.com/terms_and_conditions.htm and for electronic format documents, subject to Terms and Conditions for Electronic Documents at www.sgs.com/terms_e-document.htm. Attention is drawn to the limitation of liability, indemnification and jurisdiction issues defined therein. Any holder of this document is advised that information contained hereon reflects the Company's findings at the time of its intervention only and within the limits of Client's instructions, if any. The Company's sole responsibility is to its Client and this document does not exonerate parties to a transaction from exercising all their rights and obligations under the transaction documents. This document cannot be reproduced except in full, without prior written approval of the Company. Any unauthorized alteration, forgery or falsification of the content or appearance of this document is unlawful and offenders may be prosecuted to the fullest extent of the law.

Date: 2019/11/9

WLAN 802.11b_Body_Top side_CH 1_0mm_Tx1

Communication System: WLAN 2.45G; Frequency: 2412 MHz; Duty Cycle: 1:0.989
Medium parameters used: $f = 2412$ MHz; $\sigma = 1.86$ S/m; $\epsilon_r = 54.073$; $\rho = 1000$ kg/m³
Phantom section: Flat Section
Ambient temperature: 22.1°C; Liquid temperature: 21.1°C

DASY5 Configuration:

- Probe: EX3DV4 - SN7466; ConvF(7.71, 7.71, 7.71); Calibrated: 2019/2/4
- Sensor-Surface: 2mm (Mechanical Surface Detection)
- Electronics: DAE4 Sn1336; Calibrated: 2019/8/27
- Phantom: ELI
- DASY52 52.10.1(1476); SEMCAD X 14.6.11(7439)

Area Scan (71x101x1): Interpolated grid: dx=12 mm, dy=12 mm
Maximum value of SAR (interpolated) = 0.106 W/kg

Zoom Scan (7x7x7)/Cube 0: Measurement grid: dx=5mm, dy=5mm, dz=5mm
Reference Value = 2.346 V/m; Power Drift = 0.05 dB
Peak SAR (extrapolated) = 0.117 W/kg
SAR(1 g) = 0.061 W/kg; SAR(10 g) = 0.039 W/kg
Maximum value of SAR (measured) = 0.087 W/kg

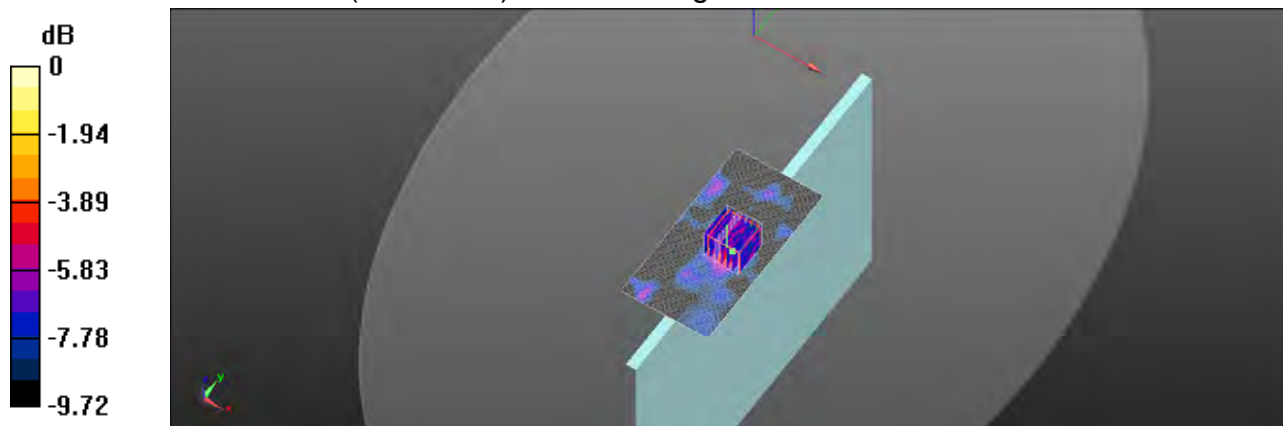

0 dB = 0.087 W/kg = -10.70 dBW/kg

Unless otherwise stated the results shown in this test report refer only to the sample(s) tested and such sample(s) are retained for 90 days only.
除非另有說明，此報告結果僅對測試之樣品負責，同時此樣品僅保留90天。本報告未經本公司書面許可，不可部份複製。

This document is issued by the Company subject to its General Conditions of Service printed overleaf, available on request or accessible at www.sgs.com/terms_and_conditions.htm and for electronic format documents, subject to Terms and Conditions for Electronic Documents at www.sgs.com/terms_e-document.htm. Attention is drawn to the limitation of liability, indemnification and jurisdiction issues defined therein. Any holder of this document is advised that information contained hereon reflects the Company's findings at the time of its intervention only and within the limits of Client's instructions, if any. The Company's sole responsibility is to its Client and this document does not exonerate parties to a transaction from exercising all their rights and obligations under the transaction documents. This document cannot be reproduced except in full, without prior written approval of the Company. Any unauthorized alteration, forgery or falsification of the content or appearance of this document is unlawful and offenders may be prosecuted to the fullest extent of the law.

Date: 2019/11/11

WLAN 802.11ac(160M) 5.2G_Body_Top side_CH 50_0mm_Tx1

Communication System: WLAN 5G; Frequency: 5250 MHz; Duty Cycle: 1:0.985
Medium parameters used: $f = 5250$ MHz; $\sigma = 5.223$ S/m; $\epsilon_r = 49.807$; $\rho = 1000$ kg/m³
Phantom section: Flat Section
Ambient temperature: 22.1°C; Liquid temperature: 21.2°C

DASY5 Configuration:

- Probe: EX3DV4 - SN7466; ConvF(4.95, 4.95, 4.95); Calibrated: 2019/2/4
- Sensor-Surface: 2mm (Mechanical Surface Detection)
- Electronics: DAE4 Sn1336; Calibrated: 2019/8/27
- Phantom: ELI
- DASY52 52.10.1(1476); SEMCAD X 14.6.11(7439)

Area Scan (61x121x1): Interpolated grid: dx=10 mm, dy=10 mm
Maximum value of SAR (interpolated) = 0.238 W/kg

Zoom Scan (7x7x12)/Cube 0: Measurement grid: dx=4mm, dy=4mm, dz=2mm
Reference Value = 3.935 V/m; Power Drift = 0.01 dB
Peak SAR (extrapolated) = 0.369 W/kg
SAR(1 g) = 0.195 W/kg; SAR(10 g) = 0.097 W/kg
Maximum value of SAR (measured) = 0.318 W/kg

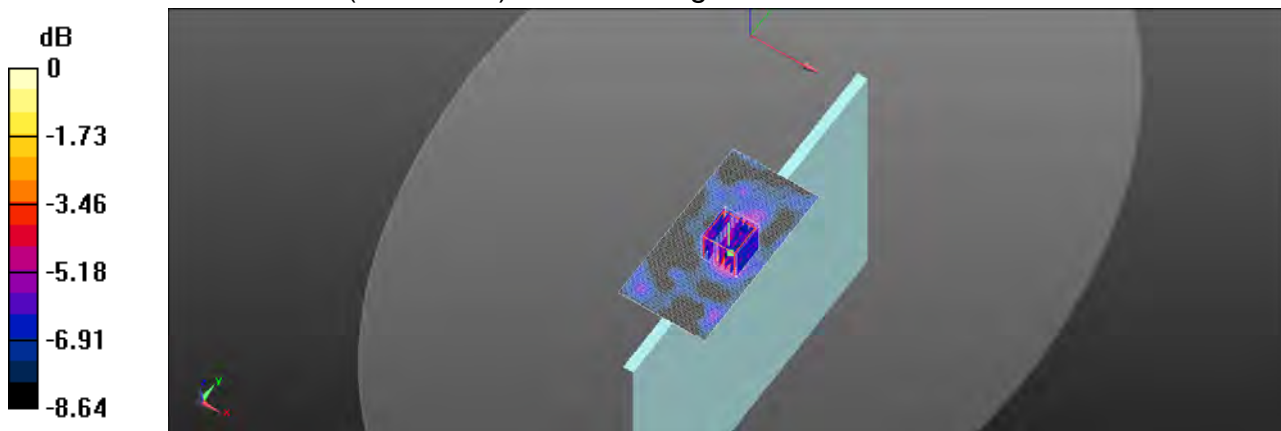

0 dB = 0.318 W/kg = -4.97 dBW/kg

Unless otherwise stated the results shown in this test report refer only to the sample(s) tested and such sample(s) are retained for 90 days only.
除非另有說明，此報告結果僅對測試之樣品負責，同時此樣品僅保留90天。本報告未經本公司書面許可，不可部份複製。

This document is issued by the Company subject to its General Conditions of Service printed overleaf, available on request or accessible at www.sgs.com/terms_and_conditions.htm and for electronic format documents, subject to Terms and Conditions for Electronic Documents at www.sgs.com/terms_e-document.htm. Attention is drawn to the limitation of liability, indemnification and jurisdiction issues defined therein. Any holder of this document is advised that information contained hereon reflects the Company's findings at the time of its intervention only and within the limits of Client's instructions, if any. The Company's sole responsibility is to its Client and this document does not exonerate parties to a transaction from exercising all their rights and obligations under the transaction documents. This document cannot be reproduced except in full, without prior written approval of the Company. Any unauthorized alteration, forgery or falsification of the content or appearance of this document is unlawful and offenders may be prosecuted to the fullest extent of the law.

Date: 2019/11/12

WLAN 802.11ac(80M) 5.3G_Body_Top side_CH 58_0mm_Tx1

Communication System: WLAN 5G; Frequency: 5290 MHz; Duty Cycle: 1: 0.99
Medium parameters used: $f = 5290$ MHz; $\sigma = 5.263$ S/m; $\epsilon_r = 49.799$; $\rho = 1000$ kg/m³
Phantom section: Flat Section
Ambient temperature: 22.6°C; Liquid temperature: 21.8°C

DASY5 Configuration:

- Probe: EX3DV4 - SN7466; ConvF(4.8, 4.8, 4.8); Calibrated: 2019/2/4
- Sensor-Surface: 2mm (Mechanical Surface Detection)
- Electronics: DAE4 Sn1336; Calibrated: 2019/8/27
- Phantom: ELI
- DASY52 52.10.1(1476); SEMCAD X 14.6.11(7439)

Area Scan (61x121x1): Interpolated grid: dx=10 mm, dy=10 mm
Maximum value of SAR (interpolated) = 0.227 W/kg

Zoom Scan (7x7x12)/Cube 0: Measurement grid: dx=4mm, dy=4mm, dz=2mm
Reference Value = 4.248 V/m; Power Drift = -0.06 dB
Peak SAR (extrapolated) = 0.508 W/kg
SAR(1 g) = 0.179 W/kg; SAR(10 g) = 0.093 W/kg
Maximum value of SAR (measured) = 0.308 W/kg

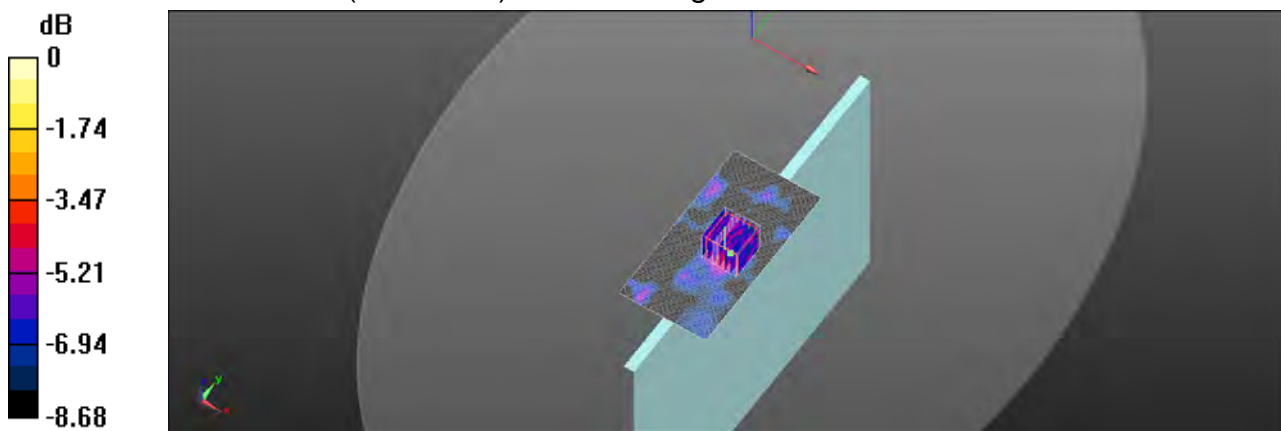

0 dB = 0.308 W/kg = -5.11 dBW/kg

Unless otherwise stated the results shown in this test report refer only to the sample(s) tested and such sample(s) are retained for 90 days only.
除非另有說明，此報告結果僅對測試之樣品負責，同時此樣品僅保留90天。本報告未經本公司書面許可，不可部份複製。

This document is issued by the Company subject to its General Conditions of Service printed overleaf, available on request or accessible at www.sgs.com/terms_and_conditions.htm and for electronic format documents, subject to Terms and Conditions for Electronic Documents at www.sgs.com/terms_e-document.htm. Attention is drawn to the limitation of liability, indemnification and jurisdiction issues defined therein. Any holder of this document is advised that information contained hereon reflects the Company's findings at the time of its intervention only and within the limits of Client's instructions, if any. The Company's sole responsibility is to its Client and this document does not exonerate parties to a transaction from exercising all their rights and obligations under the transaction documents. This document cannot be reproduced except in full, without prior written approval of the Company. Any unauthorized alteration, forgery or falsification of the content or appearance of this document is unlawful and offenders may be prosecuted to the fullest extent of the law.

Date: 2019/11/13

WLAN 802.11ac(160M) 5.6G_Body_Top side_CH 114_0mm_Tx1

Communication System: WLAN 5G; Frequency: 5570 MHz; Duty Cycle: 1: 0.985
Medium parameters used: $f = 5570$ MHz; $\sigma = 5.83$ S/m; $\epsilon_r = 49.199$; $\rho = 1000$ kg/m³
Phantom section: Flat Section
Ambient temperature: 22.1°C; Liquid temperature: 21.3°C

DASY5 Configuration:

- Probe: EX3DV4 - SN7466; ConvF(4.22, 4.22, 4.22); Calibrated: 2019/2/4
- Sensor-Surface: 2mm (Mechanical Surface Detection)
- Electronics: DAE4 Sn1336; Calibrated: 2019/8/27
- Phantom: ELI
- DASY52 52.10.1(1476); SEMCAD X 14.6.11(7439)

Area Scan (61x121x1): Interpolated grid: dx=10 mm, dy=10 mm
Maximum value of SAR (interpolated) = 0.256 W/kg

Zoom Scan (7x7x12)/Cube 0: Measurement grid: dx=4mm, dy=4mm, dz=2mm
Reference Value = 4.739 V/m; Power Drift = -0.03 dB
Peak SAR (extrapolated) = 0.580 W/kg
SAR(1 g) = 0.219 W/kg; SAR(10 g) = 0.118 W/kg
Maximum value of SAR (measured) = 0.388 W/kg

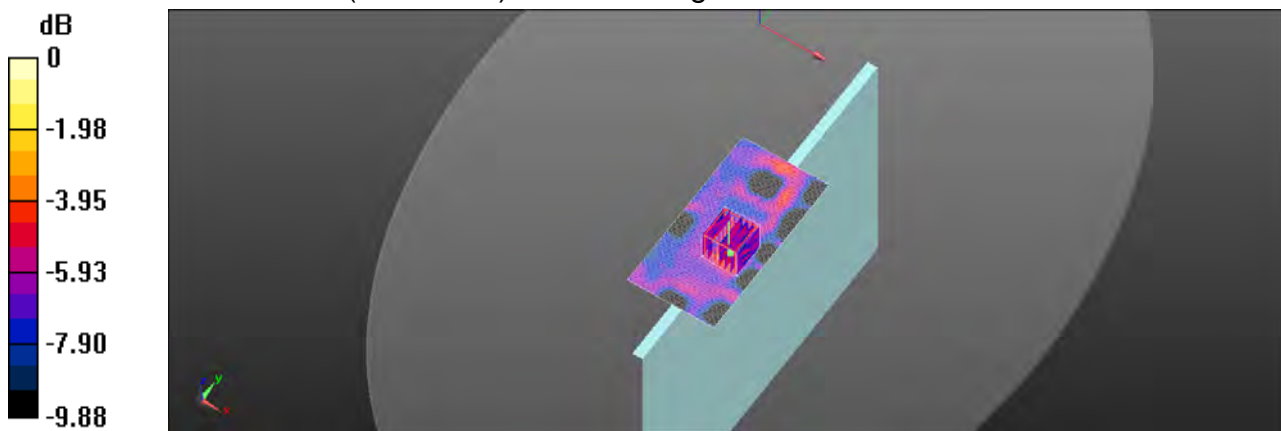

0 dB = 0.388 W/kg = -4.11 dBW/kg

Unless otherwise stated the results shown in this test report refer only to the sample(s) tested and such sample(s) are retained for 90 days only.
除非另有說明，此報告結果僅對測試之樣品負責，同時此樣品僅保留90天。本報告未經本公司書面許可，不可部份複製。

This document is issued by the Company subject to its General Conditions of Service printed overleaf, available on request or accessible at www.sgs.com/terms_and_conditions.htm and for electronic format documents, subject to Terms and Conditions for Electronic Documents at www.sgs.com/terms_e-document.htm. Attention is drawn to the limitation of liability, indemnification and jurisdiction issues defined therein. Any holder of this document is advised that information contained hereon reflects the Company's findings at the time of its intervention only and within the limits of Client's instructions, if any. The Company's sole responsibility is to its Client and this document does not exonerate parties to a transaction from exercising all their rights and obligations under the transaction documents. This document cannot be reproduced except in full, without prior written approval of the Company. Any unauthorized alteration, forgery or falsification of the content or appearance of this document is unlawful and offenders may be prosecuted to the fullest extent of the law.

Date: 2019/11/14

WLAN 802.11ac(80M) 5.8G_Body_Top side_CH 155_0mm_Tx1

Communication System: WLAN 5G; Frequency: 5775 MHz; Duty Cycle: 1: 0.99
Medium parameters used: $f = 5775$ MHz; $\sigma = 5.888$ S/m; $\epsilon_r = 48.147$; $\rho = 1000$ kg/m³
Phantom section: Flat Section
Ambient temperature: 22.7°C; Liquid temperature: 21.8°C

DASY5 Configuration:

- Probe: EX3DV4 - SN7466; ConvF(4.38, 4.38, 4.38); Calibrated: 2019/2/4
- Sensor-Surface: 2mm (Mechanical Surface Detection)
- Electronics: DAE4 Sn1336; Calibrated: 2019/8/27
- Phantom: ELI
- DASY52 52.10.1(1476); SEMCAD X 14.6.11(7439)

Area Scan (61x121x1): Interpolated grid: dx=10 mm, dy=10 mm

Maximum value of SAR (interpolated) = 0.228 W/kg

Zoom Scan (7x7x12)/Cube 0: Measurement grid: dx=4mm, dy=4mm, dz=2mm

Reference Value = 3.857 V/m; Power Drift = 0.02 dB

Peak SAR (extrapolated) = 0.478 W/kg

SAR(1 g) = 0.205 W/kg; SAR(10 g) = 0.117 W/kg

Maximum value of SAR (measured) = 0.398 W/kg

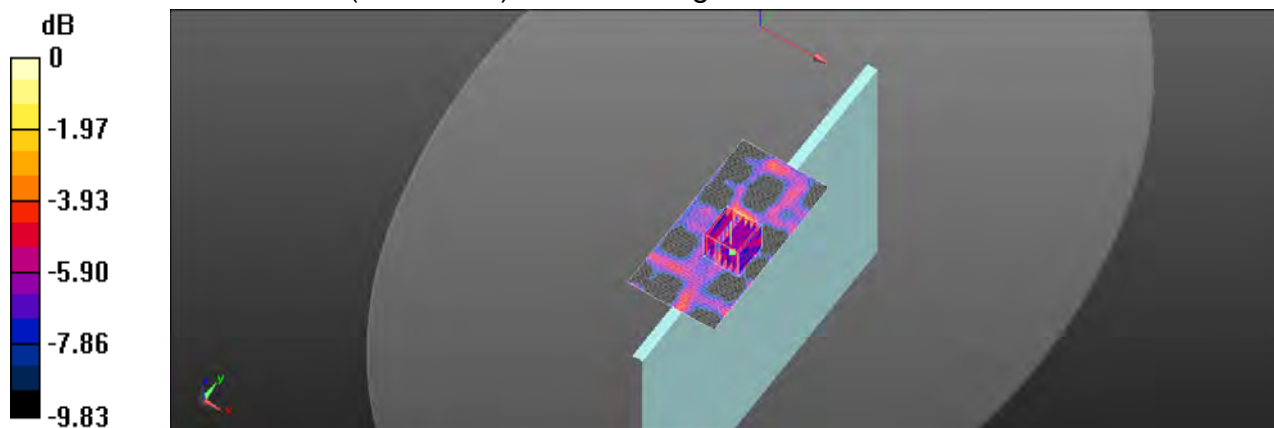

0 dB = 0.398 W/kg = -4.00 dBW/kg

Unless otherwise stated the results shown in this test report refer only to the sample(s) tested and such sample(s) are retained for 90 days only.

除非另有說明，此報告結果僅對測試之樣品負責，同時此樣品僅保留90天。本報告未經本公司書面許可，不可部份複製。

This document is issued by the Company subject to its General Conditions of Service printed overleaf, available on request or accessible at www.sgs.com/terms_and_conditions.htm and for electronic format documents, subject to Terms and Conditions for Electronic Documents at www.sgs.com/terms_e-document.htm. Attention is drawn to the limitation of liability, indemnification and jurisdiction issues defined therein. Any holder of this document is advised that information contained hereon reflects the Company's findings at the time of its intervention only and within the limits of Client's instructions, if any. The Company's sole responsibility is to its Client and this document does not exonerate parties to a transaction from exercising all their rights and obligations under the transaction documents. This document cannot be reproduced except in full, without prior written approval of the Company. Any unauthorized alteration, forgery or falsification of the content or appearance of this document is unlawful and offenders may be prosecuted to the fullest extent of the law.

Date: 2019/11/9

WLAN 802.11b Body Back side CH 11_0mm_Tx2

Communication System: WLAN 2.45G; Frequency: 2462 MHz; Duty Cycle: 1: 0.989
Medium parameters used: $f = 2462$ MHz; $\sigma = 1.911$ S/m; $\epsilon_r = 52.831$; $\rho = 1000$ kg/m³
Phantom section: Flat Section
Ambient temperature: 22.1°C; Liquid temperature: 21.1°C

DASY5 Configuration:

- Probe: EX3DV4 - SN7466; ConvF(7.71, 7.71, 7.71); Calibrated: 2019/2/4
- Sensor-Surface: 2mm (Mechanical Surface Detection)
- Electronics: DAE4 Sn1336; Calibrated: 2019/8/27
- Phantom: ELI
- DASY52 52.10.1(1476); SEMCAD X 14.6.11(7439)

Area Scan (71x91x1): Interpolated grid: dx=12 mm, dy=12 mm

Maximum value of SAR (interpolated) = 0.286 W/kg

Zoom Scan (7x7x7)/Cube 0: Measurement grid: dx=5mm, dy=5mm, dz=5mm

Reference Value = 4.331 V/m; Power Drift = 0.06 dB

Peak SAR (extrapolated) = 0.337 W/kg

SAR(1 g) = 0.206 W/kg; SAR(10 g) = 0.119 W/kg

Maximum value of SAR (measured) = 0.282 W/kg

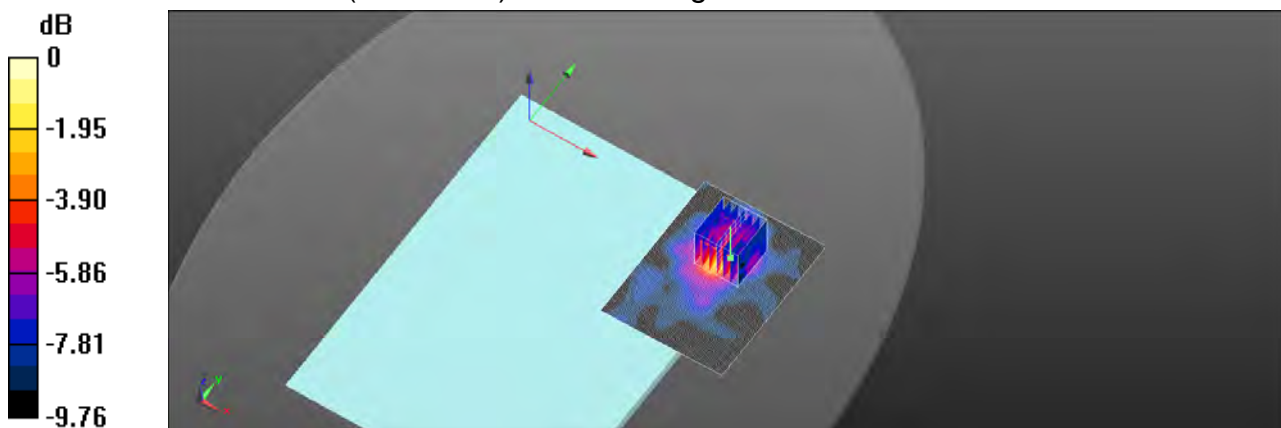

0 dB = 0.282 W/kg = -5.50 dBW/kg

Unless otherwise stated the results shown in this test report refer only to the sample(s) tested and such sample(s) are retained for 90 days only.

除非另有說明，此報告結果僅對測試之樣品負責，同時此樣品僅保留90天。本報告未經本公司書面許可，不可部份複製。

This document is issued by the Company subject to its General Conditions of Service printed overleaf, available on request or accessible at www.sgs.com/terms_and_conditions.htm and for electronic format documents, subject to Terms and Conditions for Electronic Documents at www.sgs.com/terms_e-document.htm. Attention is drawn to the limitation of liability, indemnification and jurisdiction issues defined therein. Any holder of this document is advised that information contained hereon reflects the Company's findings at the time of its intervention only and within the limits of Client's instructions, if any. The Company's sole responsibility is to its Client and this document does not exonerate parties to a transaction from exercising all their rights and obligations under the transaction documents. This document cannot be reproduced except in full, without prior written approval of the Company. Any unauthorized alteration, forgery or falsification of the content or appearance of this document is unlawful and offenders may be prosecuted to the fullest extent of the law.

Date: 2019/11/11

WLAN 802.11ac(160M) 5.2G_Body_Back side_CH 50_0mm_Tx2

Communication System: WLAN 5G; Frequency: 5250 MHz; Duty Cycle: 1: 0.985
Medium parameters used: $f = 5250$ MHz; $\sigma = 5.223$ S/m; $\epsilon_r = 49.807$; $\rho = 1000$ kg/m³
Phantom section: Flat Section
Ambient temperature: 22.1°C; Liquid temperature: 21.2°C

DASY5 Configuration:

- Probe: EX3DV4 - SN7466; ConvF(4.95, 4.95, 4.95); Calibrated: 2019/2/4
- Sensor-Surface: 2mm (Mechanical Surface Detection)
- Electronics: DAE4 Sn1336; Calibrated: 2019/8/27
- Phantom: ELI
- DASY52 52.10.1(1476); SEMCAD X 14.6.11(7439)

Area Scan (71x121x1): Interpolated grid: dx=10 mm, dy=10 mm

Maximum value of SAR (interpolated) = 0.325 W/kg

Zoom Scan (7x7x12)/Cube 0: Measurement grid: dx=4mm, dy=4mm, dz=2mm

Reference Value = 4.098 V/m; Power Drift = 0.03 dB

Peak SAR (extrapolated) = 0.881 W/kg

SAR(1 g) = 0.235 W/kg; SAR(10 g) = 0.144 W/kg

Maximum value of SAR (measured) = 0.354 W/kg

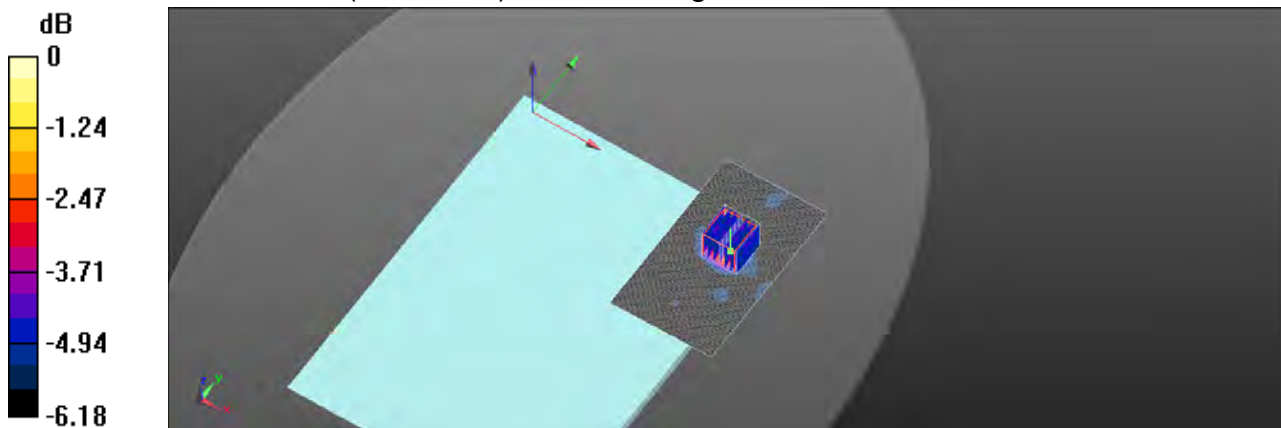

0 dB = 0.354 W/kg = -4.51 dBW/kg

Unless otherwise stated the results shown in this test report refer only to the sample(s) tested and such sample(s) are retained for 90 days only.

除非另有說明，此報告結果僅對測試之樣品負責，同時此樣品僅保留90天。本報告未經本公司書面許可，不可部份複製。

This document is issued by the Company subject to its General Conditions of Service printed overleaf, available on request or accessible at www.sgs.com/terms_and_conditions.htm and for electronic format documents, subject to Terms and Conditions for Electronic Documents at www.sgs.com/terms_e-document.htm. Attention is drawn to the limitation of liability, indemnification and jurisdiction issues defined therein. Any holder of this document is advised that information contained hereon reflects the Company's findings at the time of its intervention only and within the limits of Client's instructions, if any. The Company's sole responsibility is to its Client and this document does not exonerate parties to a transaction from exercising all their rights and obligations under the transaction documents. This document cannot be reproduced except in full, without prior written approval of the Company. Any unauthorized alteration, forgery or falsification of the content or appearance of this document is unlawful and offenders may be prosecuted to the fullest extent of the law.

Date: 2019/11/12

WLAN 802.11ac(80M) 5.3G_Body_Back side_CH 58_0mm_Tx2

Communication System: WLAN 5G; Frequency: 5290 MHz; Duty Cycle: 1: 0.99
Medium parameters used: $f = 5290 \text{ MHz}$; $\sigma = 5.263 \text{ S/m}$; $\epsilon_r = 49.799$; $\rho = 1000 \text{ kg/m}^3$
Phantom section: Flat Section
Ambient temperature: 22.6°C ; Liquid temperature: 21.8°C

DASY5 Configuration:

- Probe: EX3DV4 - SN7466; ConvF(4.8, 4.8, 4.8); Calibrated: 2019/2/4
- Sensor-Surface: 2mm (Mechanical Surface Detection)
- Electronics: DAE4 Sn1336; Calibrated: 2019/8/27
- Phantom: ELI
- DASY52 52.10.1(1476); SEMCAD X 14.6.11(7439)

Area Scan (71x121x1): Interpolated grid: $dx=10 \text{ mm}$, $dy=10 \text{ mm}$
Maximum value of SAR (interpolated) = 0.418 W/kg

Zoom Scan (7x7x12)/Cube 0: Measurement grid: $dx=4\text{mm}$, $dy=4\text{mm}$, $dz=2\text{mm}$
Reference Value = 4.111 V/m ; Power Drift = 0.04 dB
Peak SAR (extrapolated) = 0.880 W/kg
SAR(1 g) = 0.245 W/kg ; SAR(10 g) = 0.147 W/kg
Maximum value of SAR (measured) = 0.416 W/kg

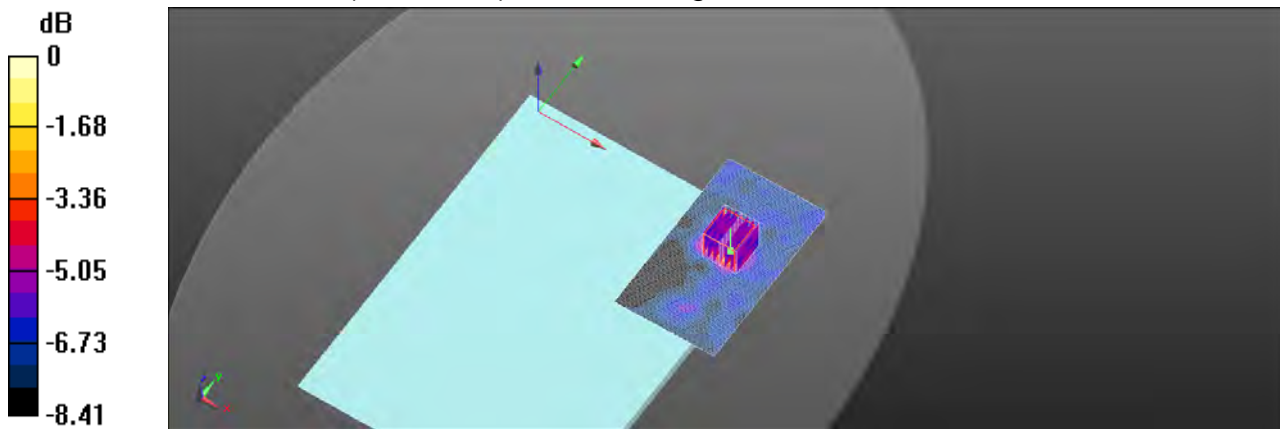

0 dB = 0.416 W/kg = -3.81 dBW/kg

Unless otherwise stated the results shown in this test report refer only to the sample(s) tested and such sample(s) are retained for 90 days only.
除非另有說明，此報告結果僅對測試之樣品負責，同時此樣品僅保留90天。本報告未經本公司書面許可，不可部份複製。

This document is issued by the Company subject to its General Conditions of Service printed overleaf, available on request or accessible at www.sgs.com/terms_and_conditions.htm and for electronic format documents, subject to Terms and Conditions for Electronic Documents at www.sgs.com/terms_e-document.htm. Attention is drawn to the limitation of liability, indemnification and jurisdiction issues defined therein. Any holder of this document is advised that information contained hereon reflects the Company's findings at the time of its intervention only and within the limits of Client's instructions, if any. The Company's sole responsibility is to its Client and this document does not exonerate parties to a transaction from exercising all their rights and obligations under the transaction documents. This document cannot be reproduced except in full, without prior written approval of the Company. Any unauthorized alteration, forgery or falsification of the content or appearance of this document is unlawful and offenders may be prosecuted to the fullest extent of the law.

Date: 2019/11/13

WLAN 802.11ac(160M) 5.6G Body Back side CH 114 0mm Tx2

Communication System: WLAN 5G; Frequency: 5570 MHz; Duty Cycle: 1: 0.985
Medium parameters used: $f = 5570$ MHz; $\sigma = 5.83$ S/m; $\epsilon_r = 49.199$; $\rho = 1000$ kg/m³
Phantom section: Flat Section
Ambient temperature: 22.1°C; Liquid temperature: 21.3°C

DASY5 Configuration:

- Probe: EX3DV4 - SN7466; ConvF(4.22, 4.22, 4.22); Calibrated: 2019/2/4
- Sensor-Surface: 2mm (Mechanical Surface Detection)
- Electronics: DAE4 Sn1336; Calibrated: 2019/8/27
- Phantom: ELI
- DASY52 52.10.1(1476); SEMCAD X 14.6.11(7439)

Area Scan (71x121x1): Interpolated grid: dx=10 mm, dy=10 mm
Maximum value of SAR (interpolated) = 0.377 W/kg

Zoom Scan (7x7x12)/Cube 0: Measurement grid: dx=4mm, dy=4mm, dz=2mm
Reference Value = 4.447 V/m; Power Drift = 0.05 dB
Peak SAR (extrapolated) = 0.835 W/kg
SAR(1 g) = 0.194 W/kg; SAR(10 g) = 0.143 W/kg
Maximum value of SAR (measured) = 0.272 W/kg

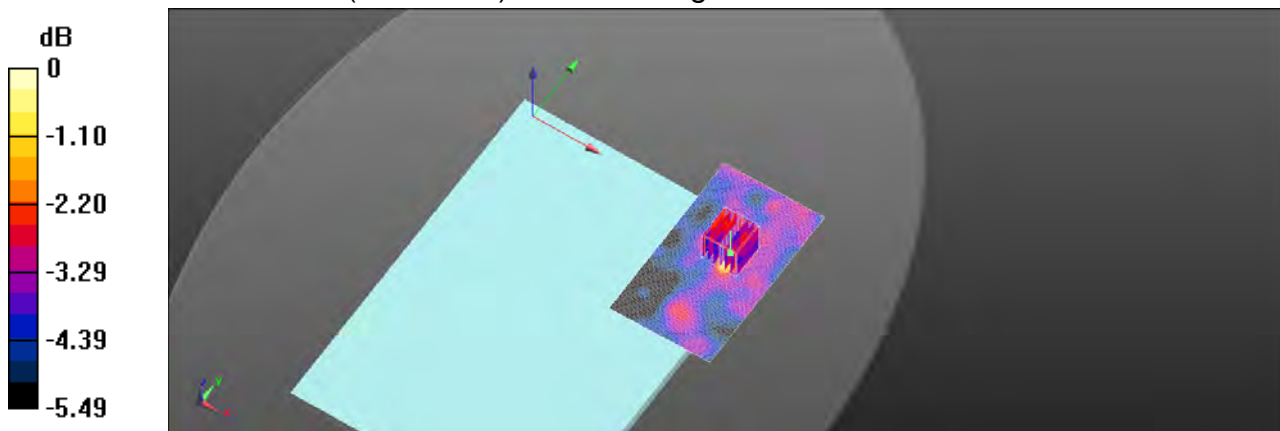

0 dB = 0.272 W/kg = -5.65 dBW/kg

Unless otherwise stated the results shown in this test report refer only to the sample(s) tested and such sample(s) are retained for 90 days only.
除非另有說明，此報告結果僅對測試之樣品負責，同時此樣品僅保留90天。本報告未經本公司書面許可，不可部份複製。

This document is issued by the Company subject to its General Conditions of Service printed overleaf, available on request or accessible at www.sgs.com/terms_and_conditions.htm and for electronic format documents, subject to Terms and Conditions for Electronic Documents at www.sgs.com/terms_e-document.htm. Attention is drawn to the limitation of liability, indemnification and jurisdiction issues defined therein. Any holder of this document is advised that information contained hereon reflects the Company's findings at the time of its intervention only and within the limits of Client's instructions, if any. The Company's sole responsibility is to its Client and this document does not exonerate parties to a transaction from exercising all their rights and obligations under the transaction documents. This document cannot be reproduced except in full, without prior written approval of the Company. Any unauthorized alteration, forgery or falsification of the content or appearance of this document is unlawful and offenders may be prosecuted to the fullest extent of the law.

Date: 2019/11/14

WLAN 802.11ac(80M) 5.8G Body Back side CH 155_0mm Tx2

Communication System: WLAN 5G; Frequency: 5775 MHz; Duty Cycle: 1:0.99
Medium parameters used: $f = 5775 \text{ MHz}$; $\sigma = 5.888 \text{ S/m}$; $\epsilon_r = 48.147$; $\rho = 1000 \text{ kg/m}^3$
Phantom section: Flat Section
Ambient temperature: 22.7°C ; Liquid temperature: 21.8°C

DASY5 Configuration:

- Probe: EX3DV4 - SN7466; ConvF(4.38, 4.38, 4.38); Calibrated: 2019/2/4
- Sensor-Surface: 2mm (Mechanical Surface Detection)
- Electronics: DAE4 Sn1336; Calibrated: 2019/8/27
- Phantom: ELI
- DASY52 52.10.1(1476); SEMCAD X 14.6.11(7439)

Area Scan (71x121x1): Interpolated grid: $dx=10 \text{ mm}$, $dy=10 \text{ mm}$
Maximum value of SAR (interpolated) = 0.294 W/kg

Zoom Scan (7x7x12)/Cube 0: Measurement grid: $dx=4\text{mm}$, $dy=4\text{mm}$, $dz=2\text{mm}$
Reference Value = 3.911 V/m ; Power Drift = 0.04 dB
Peak SAR (extrapolated) = 1.44 W/kg
SAR(1 g) = 0.221 W/kg ; SAR(10 g) = 0.150 W/kg
Maximum value of SAR (measured) = 0.317 W/kg

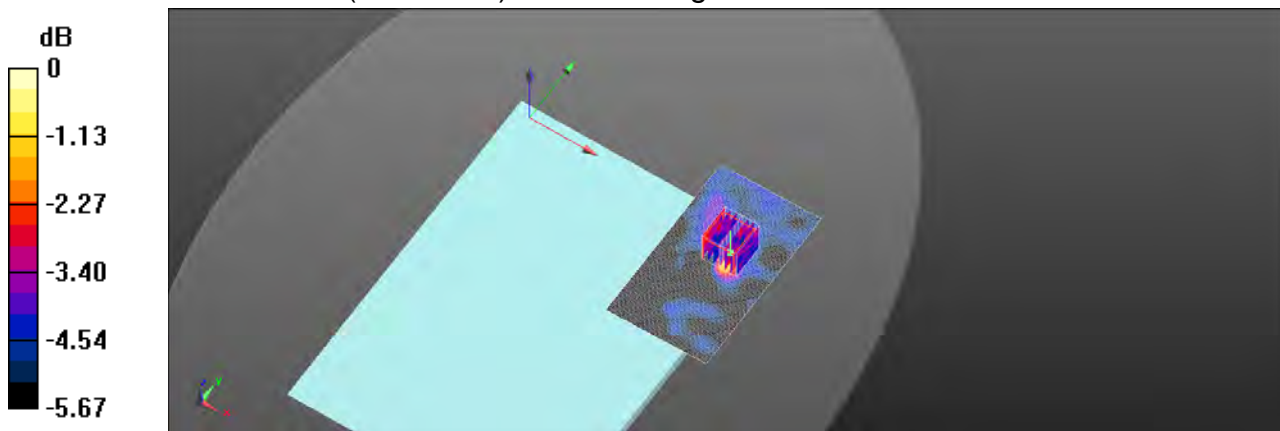

0 dB = 0.317 W/kg = -4.98 dBW/kg

Unless otherwise stated the results shown in this test report refer only to the sample(s) tested and such sample(s) are retained for 90 days only.
除非另有說明，此報告結果僅對測試之樣品負責，同時此樣品僅保留90天。本報告未經本公司書面許可，不可部份複製。

This document is issued by the Company subject to its General Conditions of Service printed overleaf, available on request or accessible at www.sgs.com/terms_and_conditions.htm and for electronic format documents, subject to Terms and Conditions for Electronic Documents at www.sgs.com/terms_e-document.htm. Attention is drawn to the limitation of liability, indemnification and jurisdiction issues defined therein. Any holder of this document is advised that information contained hereon reflects the Company's findings at the time of its intervention only and within the limits of Client's instructions, if any. The Company's sole responsibility is to its Client and this document does not exonerate parties to a transaction from exercising all their rights and obligations under the transaction documents. This document cannot be reproduced except in full, without prior written approval of the Company. Any unauthorized alteration, forgery or falsification of the content or appearance of this document is unlawful and offenders may be prosecuted to the fullest extent of the law.

Date: 2020/1/9

WLAN 802.11b_Body_Back side_CH 1_0mm_TX1

Communication System: WLAN 2.45G; Frequency: 2412 MHz; Duty Cycle: 1:0.995
Medium parameters used: $f = 2412$ MHz; $\sigma = 1.896$ S/m; $\epsilon_r = 53.363$; $\rho = 1000$ kg/m³
Phantom section: Flat Section
Ambient temperature: 22.2°C; Liquid temperature: 21.7°C

DASY5 Configuration:

- Probe: EX3DV4 - SN7466; ConvF(7.71, 7.71, 7.71); Calibrated: 2019/2/4
- Sensor-Surface: 2mm (Mechanical Surface Detection)
- Electronics: DAE4 Sn877; Calibrated: 2019/3/22
- Phantom: ELI
- DASY52 52.10.1(1476); SEMCAD X 14.6.11(7439)

Area Scan (71x91x1): Interpolated grid: dx=12 mm, dy=12 mm

Maximum value of SAR (interpolated) = 1.51 W/kg

Zoom Scan (7x7x7)/Cube 0: Measurement grid: dx=5mm, dy=5mm, dz=5mm

Reference Value = 1.363 V/m; Power Drift = 0.04 dB

Peak SAR (extrapolated) = 2.31 W/kg

SAR(1 g) = 0.871 W/kg; SAR(10 g) = 0.372 W/kg

Maximum value of SAR (measured) = 1.57 W/kg

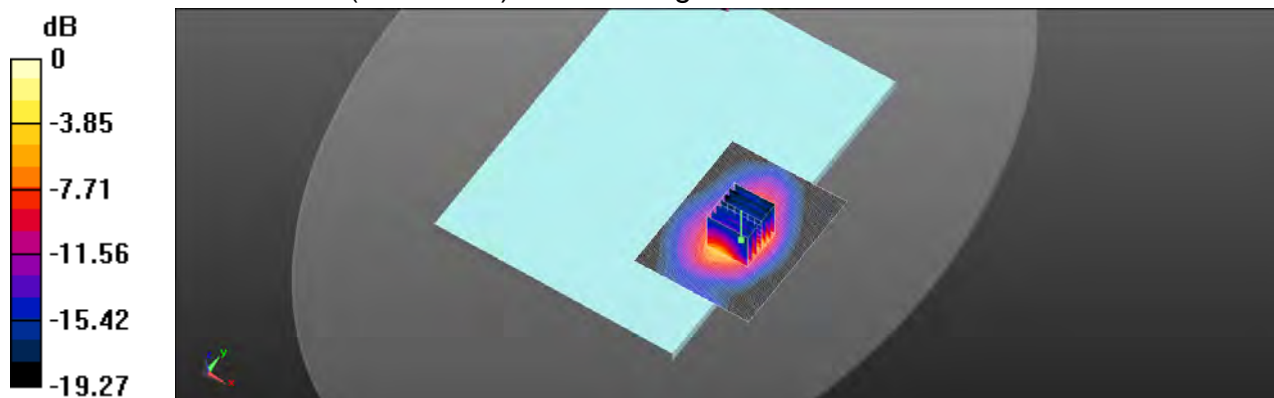

0 dB = 1.57 W/kg = 1.97 dBW/kg

Unless otherwise stated the results shown in this test report refer only to the sample(s) tested and such sample(s) are retained for 90 days only.

除非另有說明，此報告結果僅對測試之樣品負責，同時此樣品僅保留90天。本報告未經本公司書面許可，不可部份複製。

This document is issued by the Company subject to its General Conditions of Service printed overleaf, available on request or accessible at www.sgs.com/terms_and_conditions.htm and for electronic format documents, subject to Terms and Conditions for Electronic Documents at www.sgs.com/terms_e-document.htm. Attention is drawn to the limitation of liability, indemnification and jurisdiction issues defined therein. Any holder of this document is advised that information contained hereon reflects the Company's findings at the time of its intervention only and within the limits of Client's instructions, if any. The Company's sole responsibility is to its Client and this document does not exonerate parties to a transaction from exercising all their rights and obligations under the transaction documents. This document cannot be reproduced except in full, without prior written approval of the Company. Any unauthorized alteration, forgery or falsification of the content or appearance of this document is unlawful and offenders may be prosecuted to the fullest extent of the law.

Date: 2019/11/16

WLAN 802.11ac(80M) 5.2G_Body_Back side_CH 42_0mm_Tx1

Communication System: WLAN 5G; Frequency: 5210 MHz; Duty Cycle: 1:0.99
Medium parameters used: $f = 5210$ MHz; $\sigma = 5.251$ S/m; $\epsilon_r = 49.914$; $\rho = 1000$ kg/m³
Phantom section: Flat Section
Ambient temperature: 22.6°C; Liquid temperature: 21.8°C

DASY5 Configuration:

- Probe: EX3DV4 - SN7466; ConvF(4.95, 4.95, 4.95); Calibrated: 2019/2/4
- Sensor-Surface: 2mm (Mechanical Surface Detection)
- Electronics: DAE4 Sn1336; Calibrated: 2019/8/27
- Phantom: ELI
- DASY52 52.10.1(1476); SEMCAD X 14.6.11(7439)

Area Scan (71x101x1): Interpolated grid: dx=10 mm, dy=10 mm
Maximum value of SAR (interpolated) = 1.15 W/kg

Zoom Scan (7x7x12)/Cube 0: Measurement grid: dx=4mm, dy=4mm, dz=2mm
Reference Value = 4.337 V/m; Power Drift = 0.02 dB
Peak SAR (extrapolated) = 1.64 W/kg
SAR(1 g) = 0.699 W/kg; SAR(10 g) = 0.328 W/kg
Maximum value of SAR (measured) = 1.21 W/kg

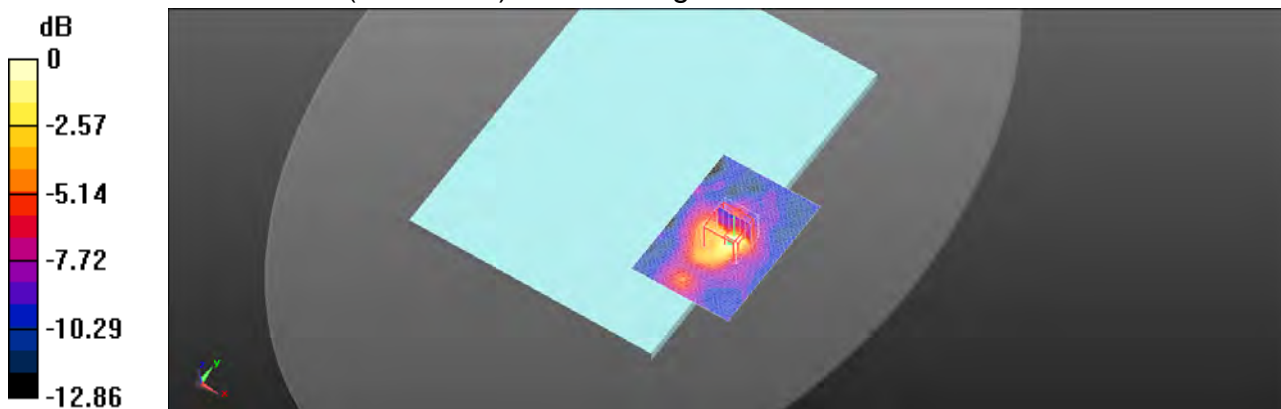

0 dB = 1.21 W/kg = 0.85 dBW/kg

Unless otherwise stated the results shown in this test report refer only to the sample(s) tested and such sample(s) are retained for 90 days only.
除非另有說明，此報告結果僅對測試之樣品負責，同時此樣品僅保留90天。本報告未經本公司書面許可，不可部份複製。

This document is issued by the Company subject to its General Conditions of Service printed overleaf, available on request or accessible at www.sgs.com/terms_and_conditions.htm and for electronic format documents, subject to Terms and Conditions for Electronic Documents at www.sgs.com/terms_e-document.htm. Attention is drawn to the limitation of liability, indemnification and jurisdiction issues defined therein. Any holder of this document is advised that information contained hereon reflects the Company's findings at the time of its intervention only and within the limits of Client's instructions, if any. The Company's sole responsibility is to its Client and this document does not exonerate parties to a transaction from exercising all their rights and obligations under the transaction documents. This document cannot be reproduced except in full, without prior written approval of the Company. Any unauthorized alteration, forgery or falsification of the content or appearance of this document is unlawful and offenders may be prosecuted to the fullest extent of the law.

Date: 2019/11/17

WLAN 802.11ac(80M) 5.3G_Body_Back side_CH 58_0mm_Tx1

Communication System: WLAN 5G; Frequency: 5290 MHz; Duty Cycle: 1: 0.99
Medium parameters used: $f = 5290$ MHz; $\sigma = 5.304$ S/m; $\epsilon_r = 49.881$; $\rho = 1000$ kg/m³
Phantom section: Flat Section
Ambient temperature: 22.1°C; Liquid temperature: 21.5°C

DASY5 Configuration:

- Probe: EX3DV4 - SN7466; ConvF(4.8, 4.8, 4.8); Calibrated: 2019/2/4
- Sensor-Surface: 2mm (Mechanical Surface Detection)
- Electronics: DAE4 Sn1336; Calibrated: 2019/8/27
- Phantom: ELI
- DASY52 52.10.1(1476); SEMCAD X 14.6.11(7439)

Area Scan (71x101x1): Interpolated grid: dx=10 mm, dy=10 mm

Maximum value of SAR (interpolated) = 1.25 W/kg

Zoom Scan (7x7x12)/Cube 0: Measurement grid: dx=4mm, dy=4mm, dz=2mm

Reference Value = 4.743 V/m; Power Drift = 0.06 dB

Peak SAR (extrapolated) = 1.62 W/kg

SAR(1 g) = 0.739 W/kg; SAR(10 g) = 0.351 W/kg

Maximum value of SAR (measured) = 1.29 W/kg

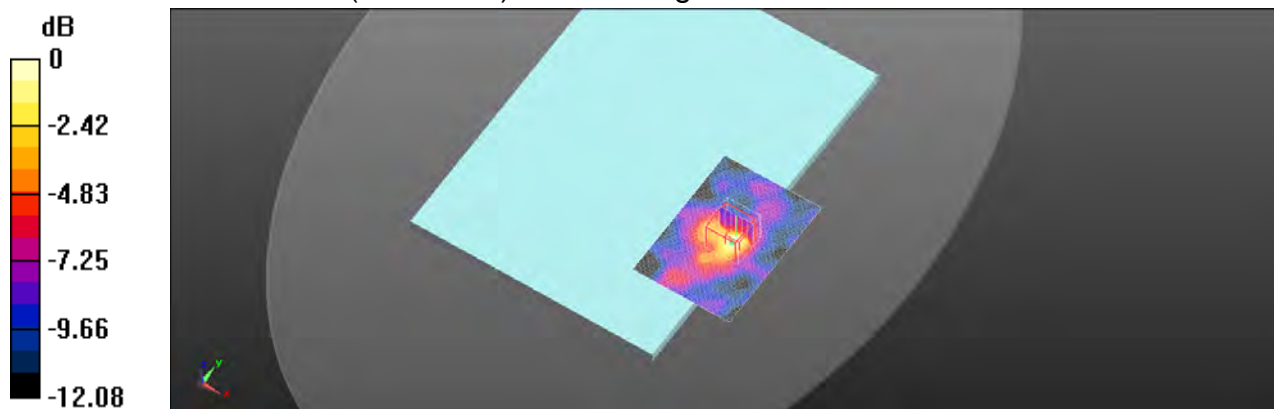

0 dB = 1.29 W/kg = 1.10 dBW/kg

Unless otherwise stated the results shown in this test report refer only to the sample(s) tested and such sample(s) are retained for 90 days only.

除非另有說明，此報告結果僅對測試之樣品負責，同時此樣品僅保留90天。本報告未經本公司書面許可，不可部份複製。

This document is issued by the Company subject to its General Conditions of Service printed overleaf, available on request or accessible at www.sgs.com/terms_and_conditions.htm and for electronic format documents, subject to Terms and Conditions for Electronic Documents at www.sgs.com/terms_e-document.htm. Attention is drawn to the limitation of liability, indemnification and jurisdiction issues defined therein. Any holder of this document is advised that information contained hereon reflects the Company's findings at the time of its intervention only and within the limits of Client's instructions, if any. The Company's sole responsibility is to its Client and this document does not exonerate parties to a transaction from exercising all their rights and obligations under the transaction documents. This document cannot be reproduced except in full, without prior written approval of the Company. Any unauthorized alteration, forgery or falsification of the content or appearance of this document is unlawful and offenders may be prosecuted to the fullest extent of the law.

Date: 2019/11/18

WLAN 802.11ac(80M) 5.6G Body Back side CH 122_0mm Tx1

Communication System: WLAN 5G; Frequency: 5610 MHz; Duty Cycle: 1: 0.99
Medium parameters used: $f = 5610$ MHz; $\sigma = 5.627$ S/m; $\epsilon_r = 49.62$; $\rho = 1000$ kg/m³
Phantom section: Flat Section
Ambient temperature: 22.7°C; Liquid temperature: 21.8°C

DASY5 Configuration:

- Probe: EX3DV4 - SN7466; ConvF(4.22, 4.22, 4.22); Calibrated: 2019/2/4
- Sensor-Surface: 2mm (Mechanical Surface Detection)
- Electronics: DAE4 Sn1336; Calibrated: 2019/8/27
- Phantom: ELI
- DASY52 52.10.1(1476); SEMCAD X 14.6.11(7439)

Area Scan (71x101x1): Interpolated grid: dx=10 mm, dy=10 mm
Maximum value of SAR (interpolated) = 1.68 W/kg

Zoom Scan (7x7x12)/Cube 0: Measurement grid: dx=4mm, dy=4mm, dz=2mm
Reference Value = 4.942 V/m; Power Drift = 0.06 dB
Peak SAR (extrapolated) = 3.48 W/kg
SAR(1 g) = 0.900 W/kg; SAR(10 g) = 0.412 W/kg
Maximum value of SAR (measured) = 1.64 W/kg

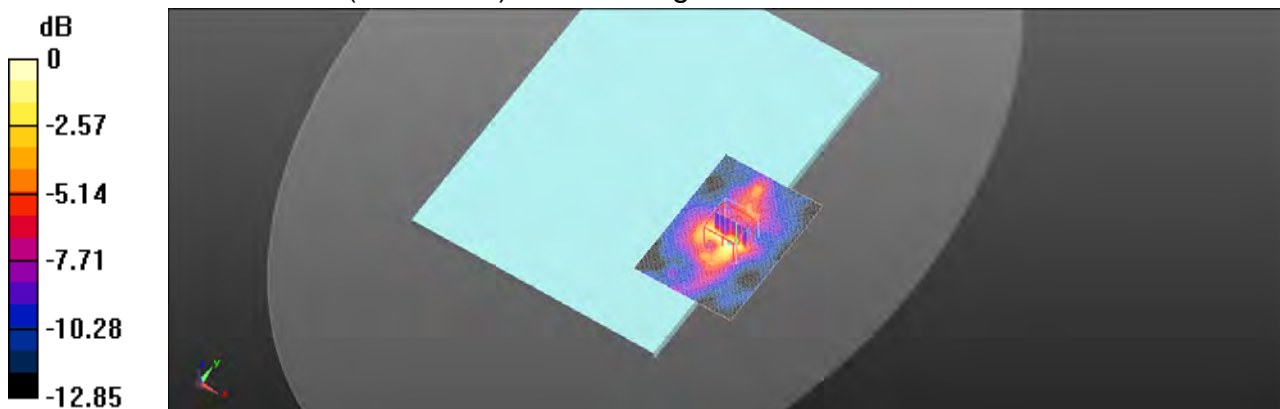

0 dB = 1.64 W/kg = 2.15 dBW/kg

Unless otherwise stated the results shown in this test report refer only to the sample(s) tested and such sample(s) are retained for 90 days only.
除非另有說明，此報告結果僅對測試之樣品負責，同時此樣品僅保留90天。本報告未經本公司書面許可，不可部份複製。

This document is issued by the Company subject to its General Conditions of Service printed overleaf, available on request or accessible at www.sgs.com/terms_and_conditions.htm and for electronic format documents, subject to Terms and Conditions for Electronic Documents at www.sgs.com/terms_e-document.htm. Attention is drawn to the limitation of liability, indemnification and jurisdiction issues defined therein. Any holder of this document is advised that information contained hereon reflects the Company's findings at the time of its intervention only and within the limits of Client's instructions, if any. The Company's sole responsibility is to its Client and this document does not exonerate parties to a transaction from exercising all their rights and obligations under the transaction documents. This document cannot be reproduced except in full, without prior written approval of the Company. Any unauthorized alteration, forgery or falsification of the content or appearance of this document is unlawful and offenders may be prosecuted to the fullest extent of the law.

Date: 2020/1/9

WLAN 802.11ac(80M) 5.8G Body Back side CH 155_0mm_TX1

Communication System: WLAN 5G; Frequency: 5775 MHz; Duty Cycle: 1:0.99
Medium parameters used: $f = 5775$ MHz; $\sigma = 5.817$ S/m; $\epsilon_r = 49.276$; $\rho = 1000$ kg/m³
Phantom section: Flat Section
Ambient temperature: 22.3°C; Liquid temperature: 21.8°C

DASY5 Configuration:

- Probe: EX3DV4 - SN7466; ConvF(4.38, 4.38, 4.38); Calibrated: 2019/2/4
- Sensor-Surface: 2mm (Mechanical Surface Detection)
- Electronics: DAE4 Sn877; Calibrated: 2019/3/22
- Phantom: ELI
- DASY52 52.10.1(1476); SEMCAD X 14.6.11(7439)

Area Scan (81x111x1): Interpolated grid: dx=10 mm, dy=10 mm
Maximum value of SAR (interpolated) = 1.16 W/kg

Zoom Scan (7x7x12)/Cube 0: Measurement grid: dx=4mm, dy=4mm, dz=2mm
Reference Value = 2.088 V/m; Power Drift = 0.08 dB
Peak SAR (extrapolated) = 5.75 W/kg
SAR(1 g) = 0.545 W/kg; SAR(10 g) = 0.217 W/kg
Maximum value of SAR (measured) = 1.58 W/kg

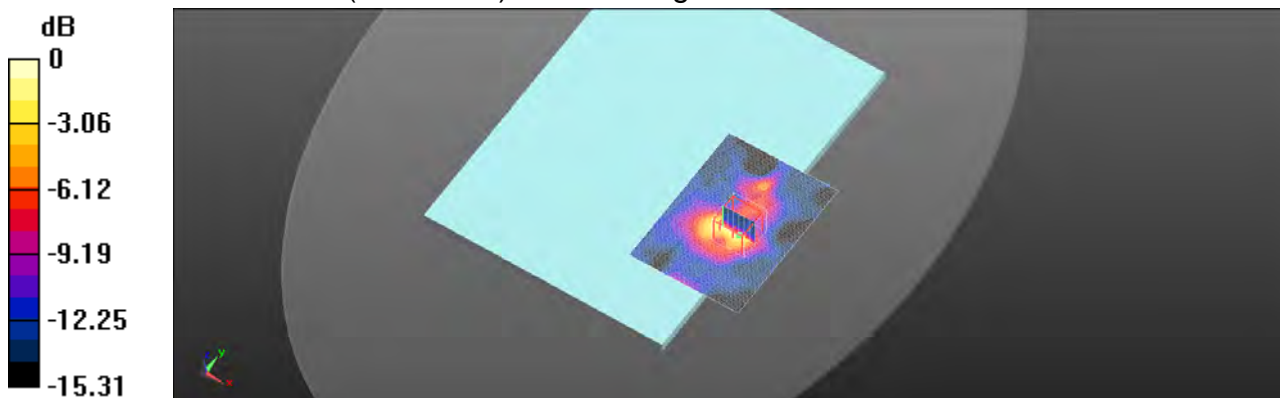

0 dB = 1.58 W/kg = 2.00 dBW/kg

Unless otherwise stated the results shown in this test report refer only to the sample(s) tested and such sample(s) are retained for 90 days only.
除非另有說明，此報告結果僅對測試之樣品負責，同時此樣品僅保留90天。本報告未經本公司書面許可，不可部份複製。

This document is issued by the Company subject to its General Conditions of Service printed overleaf, available on request or accessible at www.sgs.com/terms_and_conditions.htm and for electronic format documents, subject to Terms and Conditions for Electronic Documents at www.sgs.com/terms_e-document.htm. Attention is drawn to the limitation of liability, indemnification and jurisdiction issues defined therein. Any holder of this document is advised that information contained hereon reflects the Company's findings at the time of its intervention only and within the limits of Client's instructions, if any. The Company's sole responsibility is to its Client and this document does not exonerate parties to a transaction from exercising all their rights and obligations under the transaction documents. This document cannot be reproduced except in full, without prior written approval of the Company. Any unauthorized alteration, forgery or falsification of the content or appearance of this document is unlawful and offenders may be prosecuted to the fullest extent of the law.

Date: 2019/11/15

WLAN 802.11b Body Back side CH 10 4mm Tx2

Communication System: WLAN 2.45G; Frequency: 2457 MHz; Duty Cycle: 1: 0.995
Medium parameters used: $f = 2457$ MHz; $\sigma = 1.941$ S/m; $\epsilon_r = 53.473$; $\rho = 1100$ kg/m³
Phantom section: Flat Section
Ambient temperature: 22.1°C; Liquid temperature: 21.2°C

DASY5 Configuration:

- Probe: EX3DV4 - SN7466; ConvF(7.71, 7.71, 7.71); Calibrated: 2019/2/4
- Sensor-Surface: 2mm (Mechanical Surface Detection)
- Electronics: DAE4 Sn1336; Calibrated: 2019/8/27
- Phantom: ELI
- DASY52 52.10.1(1476); SEMCAD X 14.6.11(7439)

Area Scan (51x81x1): Interpolated grid: dx=12 mm, dy=12 mm

Maximum value of SAR (interpolated) = 1.59 W/kg

Zoom Scan (7x7x7)/Cube 0: Measurement grid: dx=5mm, dy=5mm, dz=5mm

Reference Value = 2.653 V/m; Power Drift = 0.03 dB

Peak SAR (extrapolated) = 1.80 W/kg

SAR(1 g) = 1.12 W/kg; SAR(10 g) = 0.602 W/kg

Maximum value of SAR (measured) = 1.50 W/kg

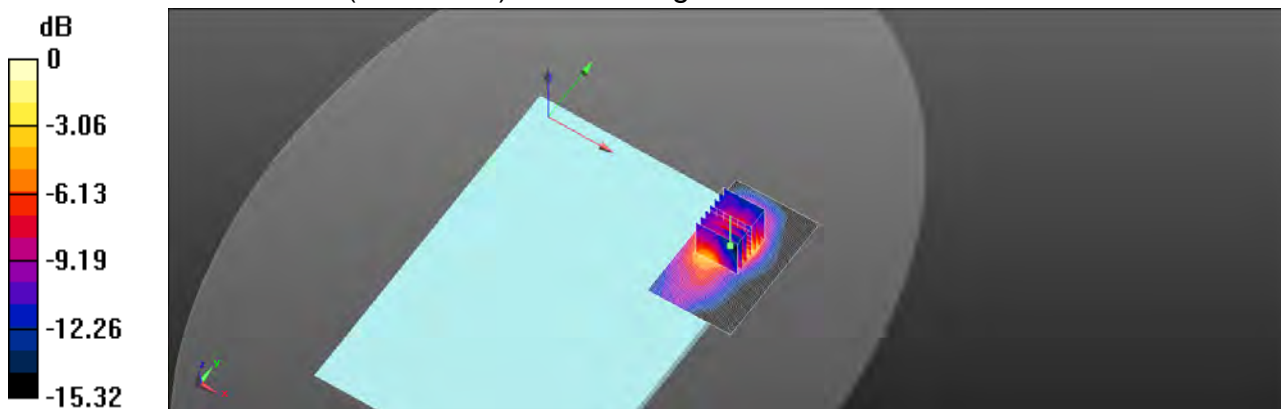

0 dB = 1.50 W/kg = 1.77 dBW/kg

Unless otherwise stated the results shown in this test report refer only to the sample(s) tested and such sample(s) are retained for 90 days only.
除非另有說明，此報告結果僅對測試之樣品負責，同時此樣品僅保留90天。本報告未經本公司書面許可，不可部份複製。

This document is issued by the Company subject to its General Conditions of Service printed overleaf, available on request or accessible at www.sgs.com/terms_and_conditions.htm and for electronic format documents, subject to Terms and Conditions for Electronic Documents at www.sgs.com/terms_e-document.htm. Attention is drawn to the limitation of liability, indemnification and jurisdiction issues defined therein. Any holder of this document is advised that information contained hereon reflects the Company's findings at the time of its intervention only and within the limits of Client's instructions, if any. The Company's sole responsibility is to its Client and this document does not exonerate parties to a transaction from exercising all their rights and obligations under the transaction documents. This document cannot be reproduced except in full, without prior written approval of the Company. Any unauthorized alteration, forgery or falsification of the content or appearance of this document is unlawful and offenders may be prosecuted to the fullest extent of the law.

Date: 2019/11/16

WLAN 802.11n(40M) 5.2G Body Back side CH 46 4mm Tx2

Communication System: WLAN 5G; Frequency: 5230 MHz; Duty Cycle: 1: 0.989
Medium parameters used: $f = 5230 \text{ MHz}$; $\sigma = 5.265 \text{ S/m}$; $\epsilon_r = 49.913$; $\rho = 1000 \text{ kg/m}^3$
Phantom section: Flat Section
Ambient temperature: 22.6°C ; Liquid temperature: 21.8°C

DASY5 Configuration:

- Probe: EX3DV4 - SN7466; ConvF(4.95, 4.95, 4.95); Calibrated: 2019/2/4
- Sensor-Surface: 2mm (Mechanical Surface Detection)
- Electronics: DAE4 Sn1336; Calibrated: 2019/8/27
- Phantom: ELI
- DASY52 52.10.1(1476); SEMCAD X 14.6.11(7439)

Area Scan (61x101x1): Interpolated grid: $dx=10 \text{ mm}$, $dy=10 \text{ mm}$
Maximum value of SAR (interpolated) = 1.13 W/kg

Zoom Scan (7x7x12)/Cube 0: Measurement grid: $dx=4\text{mm}$, $dy=4\text{mm}$, $dz=2\text{mm}$
Reference Value = 4.276 V/m ; Power Drift = 0.01 dB
Peak SAR (extrapolated) = 1.57 W/kg
SAR(1 g) = 0.671 W/kg ; SAR(10 g) = 0.318 W/kg
Maximum value of SAR (measured) = 1.18 W/kg

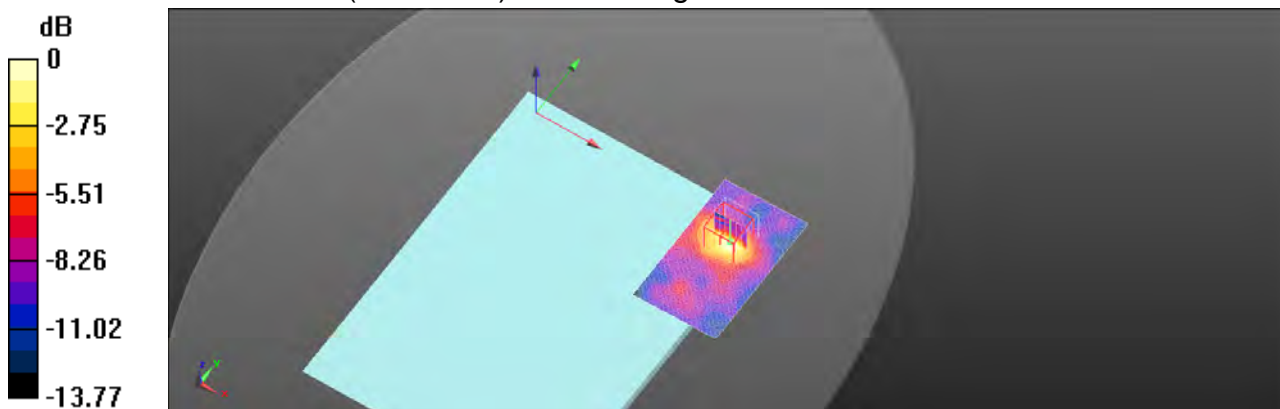

0 dB = 1.18 W/kg = 0.72 dBW/kg

Unless otherwise stated the results shown in this test report refer only to the sample(s) tested and such sample(s) are retained for 90 days only.
除非另有說明，此報告結果僅對測試之樣品負責，同時此樣品僅保留90天。本報告未經本公司書面許可，不可部份複製。

This document is issued by the Company subject to its General Conditions of Service printed overleaf, available on request or accessible at www.sgs.com/terms_and_conditions.htm and for electronic format documents, subject to Terms and Conditions for Electronic Documents at www.sgs.com/terms_e-document.htm. Attention is drawn to the limitation of liability, indemnification and jurisdiction issues defined therein. Any holder of this document is advised that information contained hereon reflects the Company's findings at the time of its intervention only and within the limits of Client's instructions, if any. The Company's sole responsibility is to its Client and this document does not exonerate parties to a transaction from exercising all their rights and obligations under the transaction documents. This document cannot be reproduced except in full, without prior written approval of the Company. Any unauthorized alteration, forgery or falsification of the content or appearance of this document is unlawful and offenders may be prosecuted to the fullest extent of the law.

Date: 2019/11/16

WLAN 802.11ac(80M) 5.2G Body Back side_CH 42_4mm_Tx2

Communication System: WLAN 5G; Frequency: 5210 MHz; Duty Cycle: 1: 0.99
Medium parameters used: $f = 5210 \text{ MHz}$; $\sigma = 5.251 \text{ S/m}$; $\epsilon_r = 49.914$; $\rho = 1000 \text{ kg/m}^3$
Phantom section: Flat Section
Ambient temperature: 22.6°C ; Liquid temperature: 21.8°C

DASY5 Configuration:

- Probe: EX3DV4 - SN7466; ConvF(4.95, 4.95, 4.95); Calibrated: 2019/2/4
- Sensor-Surface: 2mm (Mechanical Surface Detection)
- Electronics: DAE4 Sn1336; Calibrated: 2019/8/27
- Phantom: ELI
- DASY52 52.10.1(1476); SEMCAD X 14.6.11(7439)

Area Scan (71x111x1): Interpolated grid: $dx=10 \text{ mm}$, $dy=10 \text{ mm}$
Maximum value of SAR (interpolated) = 1.42 W/kg

Zoom Scan (7x7x12)/Cube 0: Measurement grid: $dx=4\text{mm}$, $dy=4\text{mm}$, $dz=2\text{mm}$
Reference Value = 4.645 V/m ; Power Drift = -0.01 dB
Peak SAR (extrapolated) = 1.69 W/kg
SAR(1 g) = 0.887 W/kg; SAR(10 g) = 0.408 W/kg
Maximum value of SAR (measured) = 1.52 W/kg

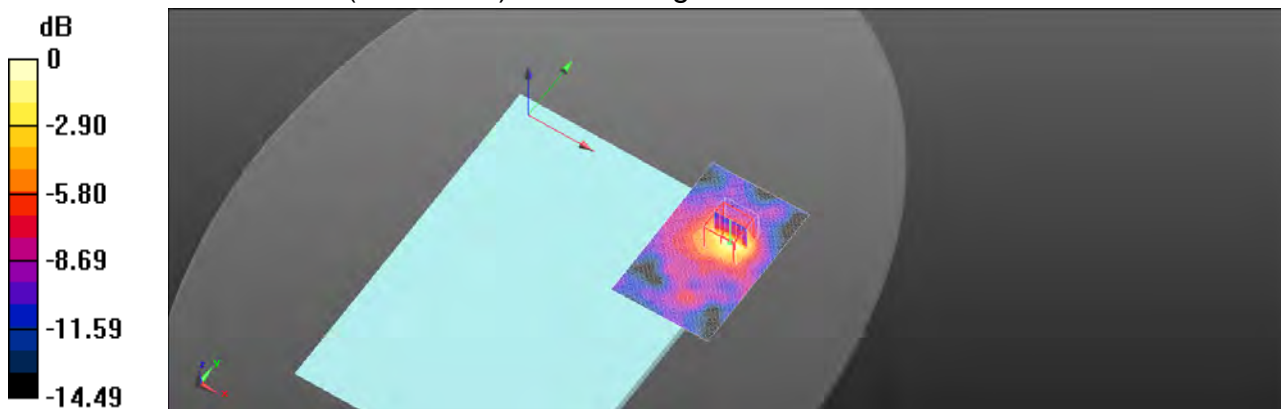

0 dB = 1.52 W/kg = 1.82 dBW/kg

Unless otherwise stated the results shown in this test report refer only to the sample(s) tested and such sample(s) are retained for 90 days only.
除非另有說明，此報告結果僅對測試之樣品負責，同時此樣品僅保留90天。本報告未經本公司書面許可，不可部份複製。

This document is issued by the Company subject to its General Conditions of Service printed overleaf, available on request or accessible at www.sgs.com/terms_and_conditions.htm and for electronic format documents, subject to Terms and Conditions for Electronic Documents at www.sgs.com/terms_e-document.htm. Attention is drawn to the limitation of liability, indemnification and jurisdiction issues defined therein. Any holder of this document is advised that information contained hereon reflects the Company's findings at the time of its intervention only and within the limits of Client's instructions, if any. The Company's sole responsibility is to its Client and this document does not exonerate parties to a transaction from exercising all their rights and obligations under the transaction documents. This document cannot be reproduced except in full, without prior written approval of the Company. Any unauthorized alteration, forgery or falsification of the content or appearance of this document is unlawful and offenders may be prosecuted to the fullest extent of the law.

Date: 2019/11/17

WLAN 802.11n(40M) 5.3G Body Back side CH 54 4mm Tx2

Communication System: WLAN 5G; Frequency: 5270 MHz; Duty Cycle: 1: 0.989
Medium parameters used: $f = 5270$ MHz; $\sigma = 5.29$ S/m; $\epsilon_r = 49.895$; $\rho = 1000$ kg/m³
Phantom section: Flat Section
Ambient temperature: 22.1°C; Liquid temperature: 21.5°C

DASY5 Configuration:

- Probe: EX3DV4 - SN7466; ConvF(4.8, 4.8, 4.8); Calibrated: 2019/2/4
- Sensor-Surface: 2mm (Mechanical Surface Detection)
- Electronics: DAE4 Sn1336; Calibrated: 2019/8/27
- Phantom: ELI
- DASY52 52.10.1(1476); SEMCAD X 14.6.11(7439)

Area Scan (61x101x1): Interpolated grid: dx=10 mm, dy=10 mm
Maximum value of SAR (interpolated) = 1.82 W/kg

Zoom Scan (7x7x12)/Cube 0: Measurement grid: dx=4mm, dy=4mm, dz=2mm
Reference Value = 4.783 V/m; Power Drift = 0.01 dB
Peak SAR (extrapolated) = 3.18 W/kg
SAR(1 g) = 1.1 W/kg; SAR(10 g) = 0.456 W/kg
Maximum value of SAR (measured) = 1.83 W/kg

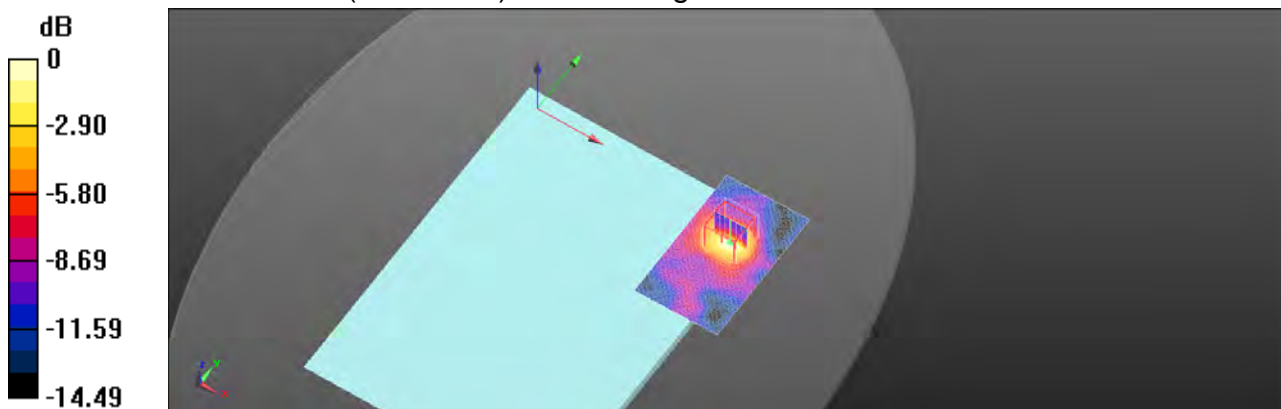

0 dB = 1.83 W/kg = 2.63 dBW/kg

Unless otherwise stated the results shown in this test report refer only to the sample(s) tested and such sample(s) are retained for 90 days only.
除非另有說明，此報告結果僅對測試之樣品負責，同時此樣品僅保留90天。本報告未經本公司書面許可，不可部份複製。

This document is issued by the Company subject to its General Conditions of Service printed overleaf, available on request or accessible at www.sgs.com/terms_and_conditions.htm and for electronic format documents, subject to Terms and Conditions for Electronic Documents at www.sgs.com/terms_e-document.htm. Attention is drawn to the limitation of liability, indemnification and jurisdiction issues defined therein. Any holder of this document is advised that information contained hereon reflects the Company's findings at the time of its intervention only and within the limits of Client's instructions, if any. The Company's sole responsibility is to its Client and this document does not exonerate parties to a transaction from exercising all their rights and obligations under the transaction documents. This document cannot be reproduced except in full, without prior written approval of the Company. Any unauthorized alteration, forgery or falsification of the content or appearance of this document is unlawful and offenders may be prosecuted to the fullest extent of the law.

Date: 2019/11/18

WLAN 802.11ac(80M) 5.6G Body Back side CH 138 4mm Tx2

Communication System: WLAN 5G; Frequency: 5690 MHz; Duty Cycle: 1: 0.99

Medium parameters used: $f = 5690$ MHz; $\sigma = 5.718$ S/m; $\epsilon_r = 49.575$; $\rho = 1000$ kg/m³

Phantom section: Flat Section

Ambient temperature: 22.7°C; Liquid temperature: 21.8°C

DASY5 Configuration:

- Probe: EX3DV4 - SN7466; ConvF(4.22, 4.22, 4.22); Calibrated: 2019/2/4
- Sensor-Surface: 2mm (Mechanical Surface Detection)
- Electronics: DAE4 Sn1336; Calibrated: 2019/8/27
- Phantom: ELI
- DASY52 52.10.1(1476); SEMCAD X 14.6.11(7439)

Area Scan (61x101x1): Interpolated grid: dx=10 mm, dy=10 mm

Maximum value of SAR (interpolated) = 1.73 W/kg

Zoom Scan (7x7x12)/Cube 0: Measurement grid: dx=4mm, dy=4mm, dz=2mm

Reference Value = 5.414 V/m; Power Drift = 0.05 dB

Peak SAR (extrapolated) = 3.63 W/kg

SAR(1 g) = 1.09 W/kg; SAR(10 g) = 0.483 W/kg

Maximum value of SAR (measured) = 2.02 W/kg

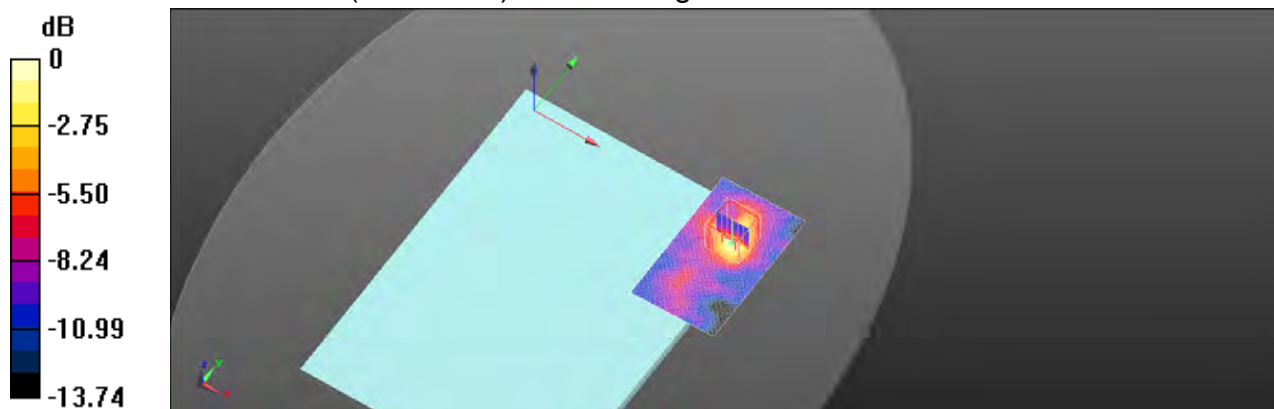

0 dB = 2.02 W/kg = 3.06 dBW/kg

Unless otherwise stated the results shown in this test report refer only to the sample(s) tested and such sample(s) are retained for 90 days only.

除非另有說明，此報告結果僅對測試之樣品負責，同時此樣品僅保留90天。本報告未經本公司書面許可，不可部份複製。

This document is issued by the Company subject to its General Conditions of Service printed overleaf, available on request or accessible at www.sgs.com/terms_and_conditions.htm and for electronic format documents, subject to Terms and Conditions for Electronic Documents at www.sgs.com/terms_e-document.htm. Attention is drawn to the limitation of liability, indemnification and jurisdiction issues defined therein. Any holder of this document is advised that information contained hereon reflects the Company's findings at the time of its intervention only and within the limits of Client's instructions, if any. The Company's sole responsibility is to its Client and this document does not exonerate parties to a transaction from exercising all their rights and obligations under the transaction documents. This document cannot be reproduced except in full, without prior written approval of the Company. Any unauthorized alteration, forgery or falsification of the content or appearance of this document is unlawful and offenders may be prosecuted to the fullest extent of the law.

Date: 2019/11/19

WLAN 802.11n(40M) 5.8G Body Back side CH 159 4mm Tx2

Communication System: WLAN 5G; Frequency: 5795 MHz; Duty Cycle: 1: 0.989
Medium parameters used: $f = 5795 \text{ MHz}$; $\sigma = 5.826 \text{ S/m}$; $\epsilon_r = 49.519$; $\rho = 1000 \text{ kg/m}^3$
Phantom section: Flat Section
Ambient temperature: 22.1°C ; Liquid temperature: 21.3°C

DASY5 Configuration:

- Probe: EX3DV4 - SN7466; ConvF(4.38, 4.38, 4.38); Calibrated: 2019/2/4
- Sensor-Surface: 2mm (Mechanical Surface Detection)
- Electronics: DAE4 Sn1336; Calibrated: 2019/8/27
- Phantom: ELI
- DASY52 52.10.1(1476); SEMCAD X 14.6.11(7439)

Area Scan (71x111x1): Interpolated grid: $dx=10 \text{ mm}$, $dy=10 \text{ mm}$
Maximum value of SAR (interpolated) = 1.58 W/kg

Zoom Scan (7x7x12)/Cube 0: Measurement grid: $dx=4\text{mm}$, $dy=4\text{mm}$, $dz=2\text{mm}$
Reference Value = 4.167 V/m ; Power Drift = 0.04 dB
Peak SAR (extrapolated) = 2.20 W/kg
SAR(1 g) = 0.969 W/kg ; SAR(10 g) = 0.442 W/kg
Maximum value of SAR (measured) = 1.76 W/kg

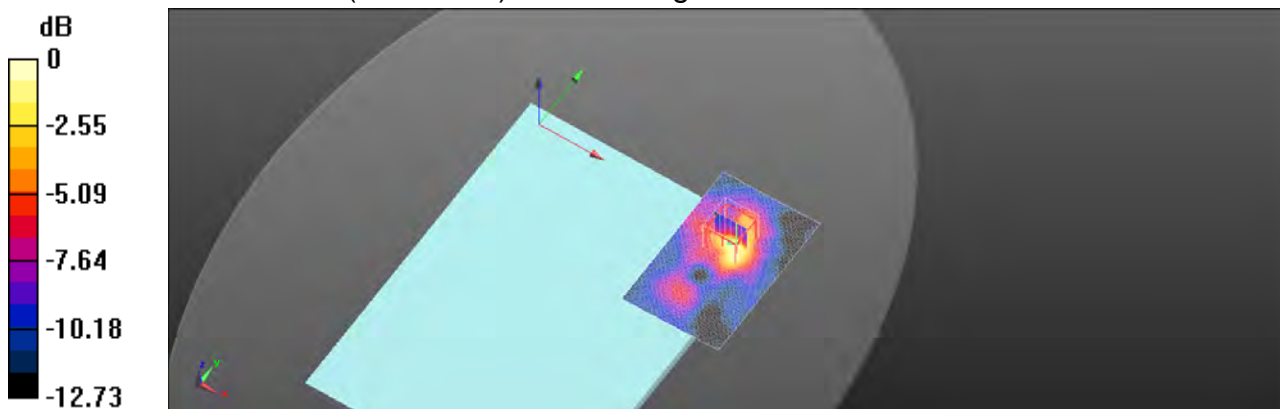

0 dB = $1.76 \text{ W/kg} = 2.45 \text{ dBW/kg}$

Unless otherwise stated the results shown in this test report refer only to the sample(s) tested and such sample(s) are retained for 90 days only.
除非另有說明，此報告結果僅對測試之樣品負責，同時此樣品僅保留90天。本報告未經本公司書面許可，不可部份複製。

This document is issued by the Company subject to its General Conditions of Service printed overleaf, available on request or accessible at www.sgs.com/terms_and_conditions.htm and for electronic format documents, subject to Terms and Conditions for Electronic Documents at www.sgs.com/terms_e-document.htm. Attention is drawn to the limitation of liability, indemnification and jurisdiction issues defined therein. Any holder of this document is advised that information contained hereon reflects the Company's findings at the time of its intervention only and within the limits of Client's instructions, if any. The Company's sole responsibility is to its Client and this document does not exonerate parties to a transaction from exercising all their rights and obligations under the transaction documents. This document cannot be reproduced except in full, without prior written approval of the Company. Any unauthorized alteration, forgery or falsification of the content or appearance of this document is unlawful and offenders may be prosecuted to the fullest extent of the law.

Date: 2019/11/19

WLAN 802.11ac(80M) 5.8G Body Back side CH 155_4mm_Tx2

Communication System: WLAN 5G; Frequency: 5775 MHz; Duty Cycle: 1: 0.99
Medium parameters used: $f = 5775 \text{ MHz}$; $\sigma = 5.806 \text{ S/m}$; $\epsilon_r = 49.537$; $\rho = 1000 \text{ kg/m}^3$
Phantom section: Flat Section
Ambient temperature: 22.1°C ; Liquid temperature: 21.3°C

DASY5 Configuration:

- Probe: EX3DV4 - SN7466; ConvF(4.38, 4.38, 4.38); Calibrated: 2019/2/4
- Sensor-Surface: 2mm (Mechanical Surface Detection)
- Electronics: DAE4 Sn1336; Calibrated: 2019/8/27
- Phantom: ELI
- DASY52 52.10.1(1476); SEMCAD X 14.6.11(7439)

Area Scan (61x101x1): Interpolated grid: $dx=10 \text{ mm}$, $dy=10 \text{ mm}$
Maximum value of SAR (interpolated) = 1.70 W/kg

Zoom Scan (7x7x12)/Cube 0: Measurement grid: $dx=4\text{mm}$, $dy=4\text{mm}$, $dz=2\text{mm}$
Reference Value = 4.088 V/m ; Power Drift = 0.03 dB
Peak SAR (extrapolated) = 2.53 W/kg
SAR(1 g) = 0.983 W/kg ; SAR(10 g) = 0.444 W/kg
Maximum value of SAR (measured) = 1.71 W/kg

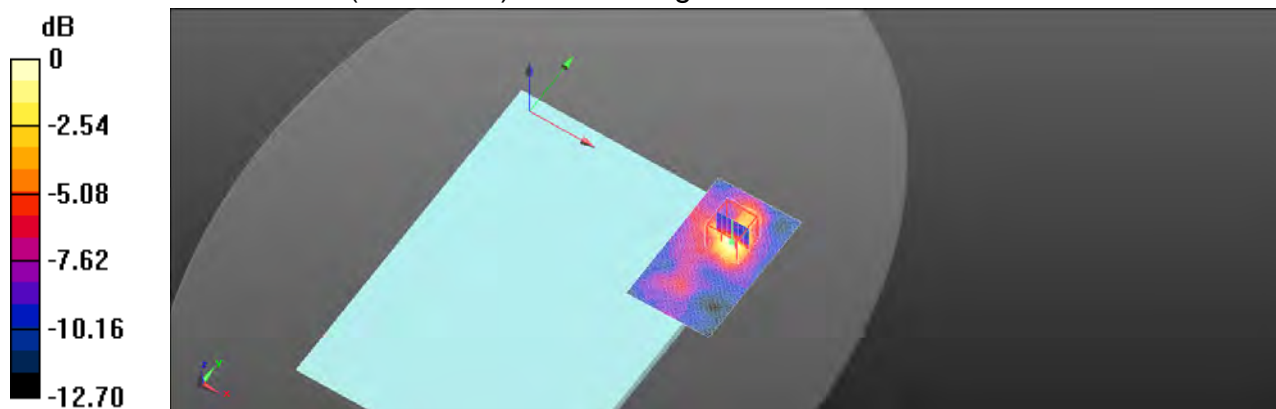

0 dB = 1.71 W/kg = 2.32 dBW/kg

Unless otherwise stated the results shown in this test report refer only to the sample(s) tested and such sample(s) are retained for 90 days only.
除非另有說明，此報告結果僅對測試之樣品負責，同時此樣品僅保留90天。本報告未經本公司書面許可，不可部份複製。

This document is issued by the Company subject to its General Conditions of Service printed overleaf, available on request or accessible at www.sgs.com/terms_and_conditions.htm and for electronic format documents, subject to Terms and Conditions for Electronic Documents at www.sgs.com/terms_e-document.htm. Attention is drawn to the limitation of liability, indemnification and jurisdiction issues defined therein. Any holder of this document is advised that information contained hereon reflects the Company's findings at the time of its intervention only and within the limits of Client's instructions, if any. The Company's sole responsibility is to its Client and this document does not exonerate parties to a transaction from exercising all their rights and obligations under the transaction documents. This document cannot be reproduced except in full, without prior written approval of the Company. Any unauthorized alteration, forgery or falsification of the content or appearance of this document is unlawful and offenders may be prosecuted to the fullest extent of the law.

Date: 2020/1/9

WLAN 802.11b_Body_Top side_CH 1_0mm_TX1

Communication System: WLAN 2.45G; Frequency: 2412 MHz; Duty Cycle: 1:0.995
Medium parameters used: $f = 2412$ MHz; $\sigma = 1.896$ S/m; $\epsilon_r = 53.363$; $\rho = 1000$ kg/m³
Phantom section: Flat Section
Ambient temperature: 22.2°C; Liquid temperature: 21.7°C

DASY5 Configuration:

- Probe: EX3DV4 - SN7466; ConvF(7.71, 7.71, 7.71); Calibrated: 2019/2/4
- Sensor-Surface: 2mm (Mechanical Surface Detection)
- Electronics: DAE4 Sn877; Calibrated: 2019/3/22
- Phantom: ELI
- DASY52 52.10.1(1476); SEMCAD X 14.6.11(7439)

Area Scan (51x101x1): Interpolated grid: dx=12 mm, dy=12 mm
Maximum value of SAR (interpolated) = 1.44 W/kg

Zoom Scan (7x7x7)/Cube 0: Measurement grid: dx=5mm, dy=5mm, dz=5mm
Reference Value = 26.39 V/m; Power Drift = -0.04 dB
Peak SAR (extrapolated) = 2.33 W/kg
SAR(1 g) = 1.07 W/kg; SAR(10 g) = 0.495 W/kg
Maximum value of SAR (measured) = 1.66 W/kg

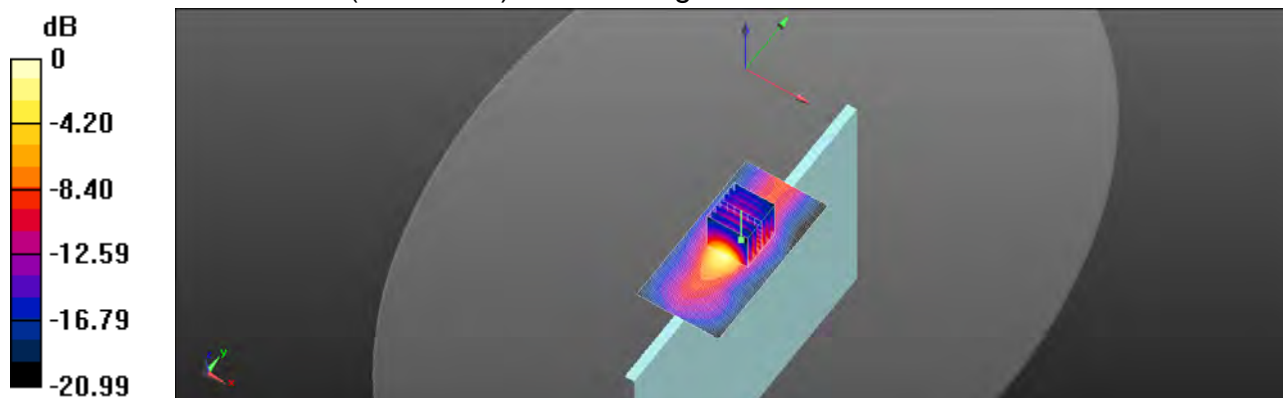

0 dB = 1.66 W/kg = 2.19 dBW/kg

Unless otherwise stated the results shown in this test report refer only to the sample(s) tested and such sample(s) are retained for 90 days only.
除非另有說明，此報告結果僅對測試之樣品負責，同時此樣品僅保留90天。本報告未經本公司書面許可，不可部份複製。

This document is issued by the Company subject to its General Conditions of Service printed overleaf, available on request or accessible at www.sgs.com/terms_and_conditions.htm and for electronic format documents, subject to Terms and Conditions for Electronic Documents at www.sgs.com/terms_e-document.htm. Attention is drawn to the limitation of liability, indemnification and jurisdiction issues defined therein. Any holder of this document is advised that information contained hereon reflects the Company's findings at the time of its intervention only and within the limits of Client's instructions, if any. The Company's sole responsibility is to its Client and this document does not exonerate parties to a transaction from exercising all their rights and obligations under the transaction documents. This document cannot be reproduced except in full, without prior written approval of the Company. Any unauthorized alteration, forgery or falsification of the content or appearance of this document is unlawful and offenders may be prosecuted to the fullest extent of the law.

Date: 2019/11/16

WLAN 802.11ac(160M) 5.2G_Body_Top side_CH 50_0mm_Tx1

Communication System: WLAN 5G; Frequency: 5250 MHz; Duty Cycle: 1:0.985

Medium parameters used: $f = 5250$ MHz; $\sigma = 5.276$ S/m; $\epsilon_r = 49.906$; $\rho = 1000$ kg/m³

Phantom section: Flat Section

Ambient temperature: 22.6°C; Liquid temperature: 21.8°C

DASY5 Configuration:

- Probe: EX3DV4 - SN7466; ConvF(4.95, 4.95, 4.95); Calibrated: 2019/2/4
- Sensor-Surface: 2mm (Mechanical Surface Detection)
- Electronics: DAE4 Sn1336; Calibrated: 2019/8/27
- Phantom: ELI
- DASY52 52.10.1(1476); SEMCAD X 14.6.11(7439)

Area Scan (61x101x1): Interpolated grid: dx=10 mm, dy=10 mm

Maximum value of SAR (interpolated) = 1.45 W/kg

Zoom Scan (7x7x12)/Cube 0: Measurement grid: dx=4mm, dy=4mm, dz=2mm

Reference Value = 7.644 V/m; Power Drift = -0.01 dB

Peak SAR (extrapolated) = 2.03 W/kg

SAR(1 g) = 0.756 W/kg; SAR(10 g) = 0.160 W/kg

Maximum value of SAR (measured) = 1.70 W/kg

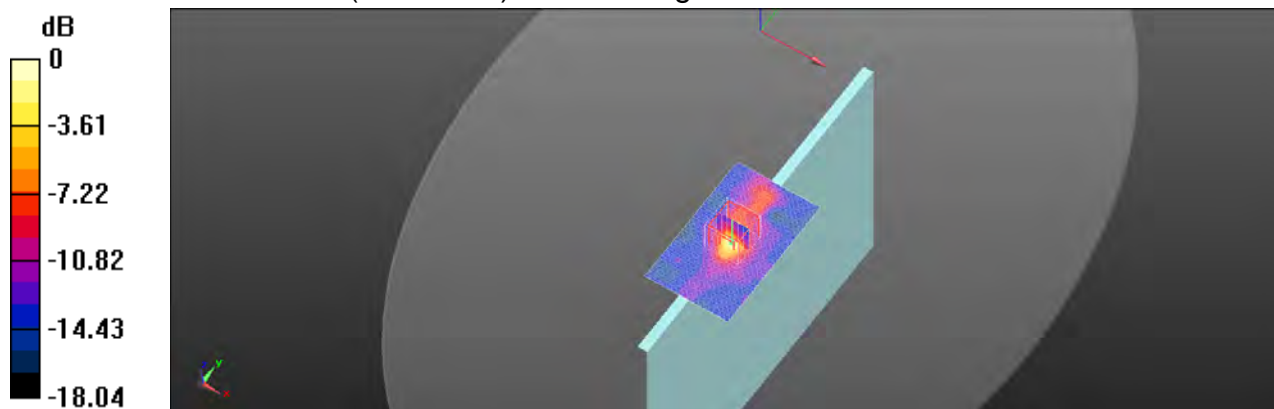

0 dB = 1.70 W/kg = 2.31 dBW/kg

Unless otherwise stated the results shown in this test report refer only to the sample(s) tested and such sample(s) are retained for 90 days only.

除非另有說明，此報告結果僅對測試之樣品負責，同時此樣品僅保留90天。本報告未經本公司書面許可，不可部份複製。

This document is issued by the Company subject to its General Conditions of Service printed overleaf, available on request or accessible at www.sgs.com/terms_and_conditions.htm and for electronic format documents, subject to Terms and Conditions for Electronic Documents at www.sgs.com/terms_e-document.htm. Attention is drawn to the limitation of liability, indemnification and jurisdiction issues defined therein. Any holder of this document is advised that information contained hereon reflects the Company's findings at the time of its intervention only and within the limits of Client's instructions, if any. The Company's sole responsibility is to its Client and this document does not exonerate parties to a transaction from exercising all their rights and obligations under the transaction documents. This document cannot be reproduced except in full, without prior written approval of the Company. Any unauthorized alteration, forgery or falsification of the content or appearance of this document is unlawful and offenders may be prosecuted to the fullest extent of the law.

Date: 2019/11/17

WLAN 802.11ac(80M) 5.3G_Body_Top side_CH 58_0mm_Tx1

Communication System: WLAN 5G; Frequency: 5290 MHz; Duty Cycle: 1:0.99
Medium parameters used: $f = 5290$ MHz; $\sigma = 5.304$ S/m; $\epsilon_r = 49.881$; $\rho = 1000$ kg/m³
Phantom section: Flat Section
Ambient temperature: 22.1°C; Liquid temperature: 21.5°C

DASY5 Configuration:

- Probe: EX3DV4 - SN7466; ConvF(4.8, 4.8, 4.8); Calibrated: 2019/2/4
- Sensor-Surface: 2mm (Mechanical Surface Detection)
- Electronics: DAE4 Sn1336; Calibrated: 2019/8/27
- Phantom: ELI
- DASY52 52.10.1(1476); SEMCAD X 14.6.11(7439)

Area Scan (61x101x1): Interpolated grid: dx=10 mm, dy=10 mm
Maximum value of SAR (interpolated) = 1.40 W/kg

Zoom Scan (7x7x12)/Cube 0: Measurement grid: dx=4mm, dy=4mm, dz=2mm
Reference Value = 6.515 V/m; Power Drift = 0.07 dB
Peak SAR (extrapolated) = 2.43 W/kg
SAR(1 g) = 0.758 W/kg; SAR(10 g) = 0.239 W/kg
Maximum value of SAR (measured) = 1.41 W/kg

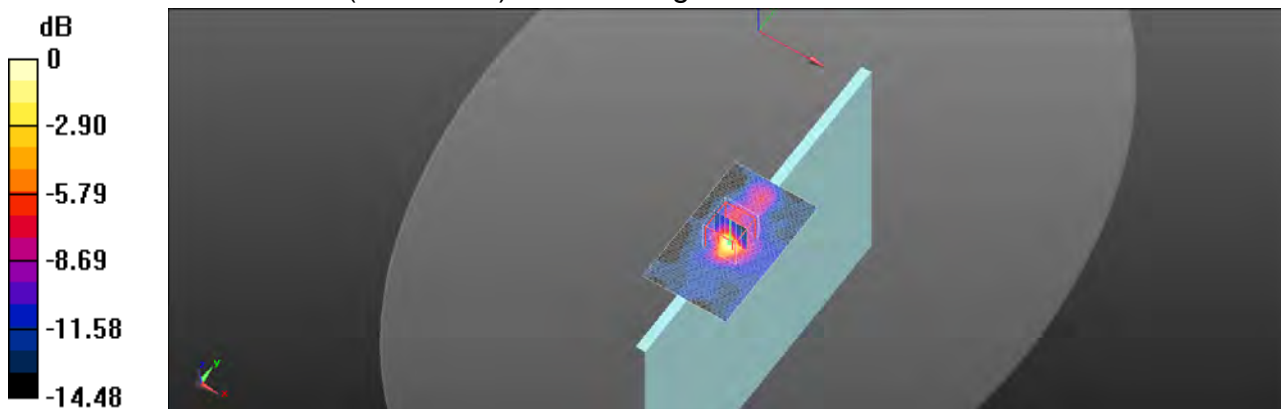

0 dB = 1.41 W/kg = 1.49 dBW/kg

Unless otherwise stated the results shown in this test report refer only to the sample(s) tested and such sample(s) are retained for 90 days only.
除非另有說明，此報告結果僅對測試之樣品負責，同時此樣品僅保留90天。本報告未經本公司書面許可，不可部份複製。

This document is issued by the Company subject to its General Conditions of Service printed overleaf, available on request or accessible at www.sgs.com/terms_and_conditions.htm and for electronic format documents, subject to Terms and Conditions for Electronic Documents at www.sgs.com/terms_e-document.htm. Attention is drawn to the limitation of liability, indemnification and jurisdiction issues defined therein. Any holder of this document is advised that information contained hereon reflects the Company's findings at the time of its intervention only and within the limits of Client's instructions, if any. The Company's sole responsibility is to its Client and this document does not exonerate parties to a transaction from exercising all their rights and obligations under the transaction documents. This document cannot be reproduced except in full, without prior written approval of the Company. Any unauthorized alteration, forgery or falsification of the content or appearance of this document is unlawful and offenders may be prosecuted to the fullest extent of the law.

Date: 2019/11/18

WLAN 802.11ac(80M) 5.6G_Body_Top side_CH 138_0mm_Tx1

Communication System: WLAN 5G; Frequency: 5690 MHz; Duty Cycle: 1: 0.99
Medium parameters used: $f = 5690$ MHz; $\sigma = 5.718$ S/m; $\epsilon_r = 49.575$; $\rho = 1000$ kg/m³
Phantom section: Flat Section
Ambient temperature: 22.7°C; Liquid temperature: 21.8°C

DASY5 Configuration:

- Probe: EX3DV4 - SN7466; ConvF(4.22, 4.22, 4.22); Calibrated: 2019/2/4
- Sensor-Surface: 2mm (Mechanical Surface Detection)
- Electronics: DAE4 Sn1336; Calibrated: 2019/8/27
- Phantom: ELI
- DASY52 52.10.1(1476); SEMCAD X 14.6.11(7439)

Area Scan (71x121x1): Interpolated grid: dx=10 mm, dy=10 mm
Maximum value of SAR (interpolated) = 1.39 W/kg

Zoom Scan (7x7x12)/Cube 0: Measurement grid: dx=4mm, dy=4mm, dz=2mm
Reference Value = 7.254 V/m; Power Drift = -0.07 dB
Peak SAR (extrapolated) = 2.31 W/kg
SAR(1 g) = 0.841 W/kg; SAR(10 g) = 0.299 W/kg
Maximum value of SAR (measured) = 1.75 W/kg

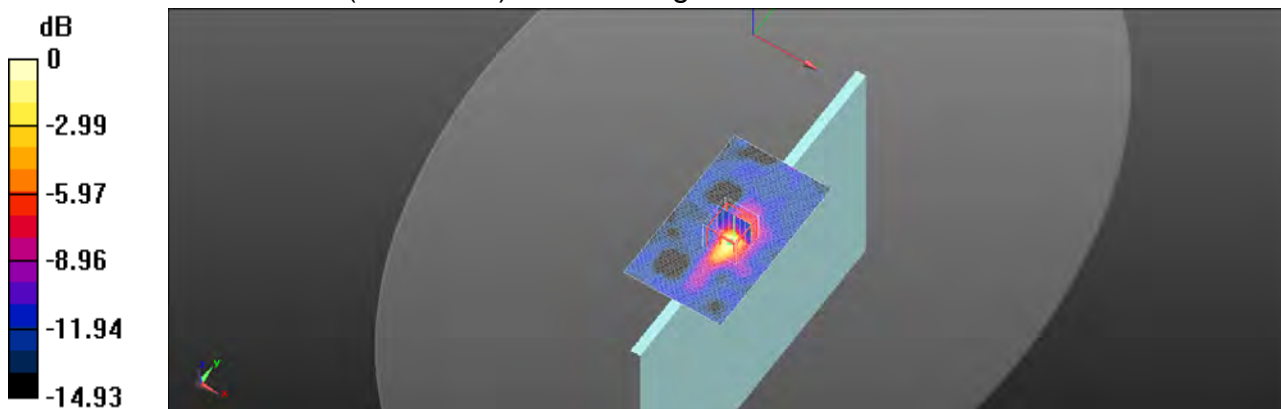

0 dB = 1.75 W/kg = 2.42 dBW/kg

Unless otherwise stated the results shown in this test report refer only to the sample(s) tested and such sample(s) are retained for 90 days only.
除非另有說明，此報告結果僅對測試之樣品負責，同時此樣品僅保留90天。本報告未經本公司書面許可，不可部份複製。

This document is issued by the Company subject to its General Conditions of Service printed overleaf, available on request or accessible at www.sgs.com/terms_and_conditions.htm and for electronic format documents, subject to Terms and Conditions for Electronic Documents at www.sgs.com/terms_e-document.htm. Attention is drawn to the limitation of liability, indemnification and jurisdiction issues defined therein. Any holder of this document is advised that information contained hereon reflects the Company's findings at the time of its intervention only and within the limits of Client's instructions, if any. The Company's sole responsibility is to its Client and this document does not exonerate parties to a transaction from exercising all their rights and obligations under the transaction documents. This document cannot be reproduced except in full, without prior written approval of the Company. Any unauthorized alteration, forgery or falsification of the content or appearance of this document is unlawful and offenders may be prosecuted to the fullest extent of the law.

Date: 2019/11/18

WLAN 802.11ac(160M) 5.6G Body_Top side_CH 114_0mm_Tx1

Communication System: WLAN 5G; Frequency: 5570 MHz; Duty Cycle: 1: 0.985

Medium parameters used: $f = 5570$ MHz; $\sigma = 5.577$ S/m; $\epsilon_r = 49.653$; $\rho = 1000$ kg/m³

Phantom section: Flat Section

Ambient temperature: 22.7°C; Liquid temperature: 21.8°C

DASY5 Configuration:

- Probe: EX3DV4 - SN7466; ConvF(4.22, 4.22, 4.22); Calibrated: 2019/2/4
- Sensor-Surface: 2mm (Mechanical Surface Detection)
- Electronics: DAE4 Sn1336; Calibrated: 2019/8/27
- Phantom: ELI
- DASY52 52.10.1(1476); SEMCAD X 14.6.11(7439)

Area Scan (61x101x1): Interpolated grid: dx=10 mm, dy=10 mm

Maximum value of SAR (interpolated) = 1.76 W/kg

Zoom Scan (7x7x12)/Cube 0: Measurement grid: dx=4mm, dy=4mm, dz=2mm

Reference Value = 6.701 V/m; Power Drift = -0.06 dB

Peak SAR (extrapolated) = 2.39 W/kg

SAR(1 g) = 0.878 W/kg; SAR(10 g) = 0.287 W/kg

Maximum value of SAR (measured) = 1.88 W/kg

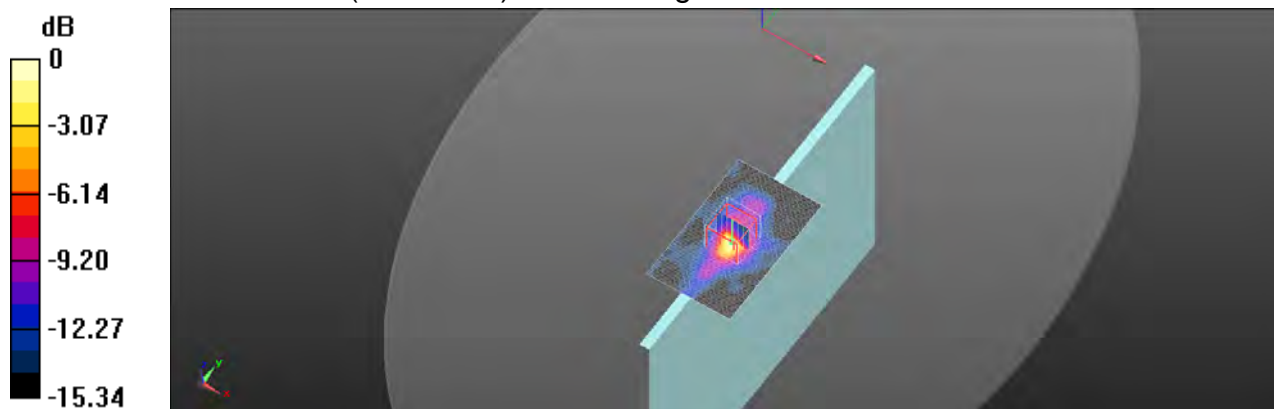

0 dB = 1.88 W/kg = 2.75 dBW/kg

Unless otherwise stated the results shown in this test report refer only to the sample(s) tested and such sample(s) are retained for 90 days only.

除非另有說明，此報告結果僅對測試之樣品負責，同時此樣品僅保留90天。本報告未經本公司書面許可，不可部份複製。

This document is issued by the Company subject to its General Conditions of Service printed overleaf, available on request or accessible at www.sgs.com/terms_and_conditions.htm and for electronic format documents, subject to Terms and Conditions for Electronic Documents at www.sgs.com/terms_e-document.htm. Attention is drawn to the limitation of liability, indemnification and jurisdiction issues defined therein. Any holder of this document is advised that information contained hereon reflects the Company's findings at the time of its intervention only and within the limits of Client's instructions, if any. The Company's sole responsibility is to its Client and this document does not exonerate parties to a transaction from exercising all their rights and obligations under the transaction documents. This document cannot be reproduced except in full, without prior written approval of the Company. Any unauthorized alteration, forgery or falsification of the content or appearance of this document is unlawful and offenders may be prosecuted to the fullest extent of the law.

Date: 2019/11/19

WLAN 802.11ac(80M) 5.8G_Body_Top side_CH 155_0mm_Tx1

Communication System: WLAN 5G; Frequency: 5775 MHz; Duty Cycle: 1: 0.99
Medium parameters used: $f = 5775 \text{ MHz}$; $\sigma = 5.806 \text{ S/m}$; $\epsilon_r = 49.537$; $\rho = 1000 \text{ kg/m}^3$
Phantom section: Flat Section
Ambient temperature: 22.1°C ; Liquid temperature: 21.3°C

DASY5 Configuration:

- Probe: EX3DV4 - SN7466; ConvF(4.38, 4.38, 4.38); Calibrated: 2019/2/4
- Sensor-Surface: 2mm (Mechanical Surface Detection)
- Electronics: DAE4 Sn1336; Calibrated: 2019/8/27
- Phantom: ELI
- DASY52 52.10.1(1476); SEMCAD X 14.6.11(7439)

Area Scan (61x101x1): Interpolated grid: $dx=10 \text{ mm}$, $dy=10 \text{ mm}$
Maximum value of SAR (interpolated) = 1.59 W/kg

Zoom Scan (7x7x12)/Cube 0: Measurement grid: $dx=4\text{mm}$, $dy=4\text{mm}$, $dz=2\text{mm}$
Reference Value = 4.991 V/m ; Power Drift = 0.02 dB
Peak SAR (extrapolated) = 2.79 W/kg
SAR(1 g) = 0.786 W/kg ; SAR(10 g) = 0.275 W/kg
Maximum value of SAR (measured) = 1.56 W/kg

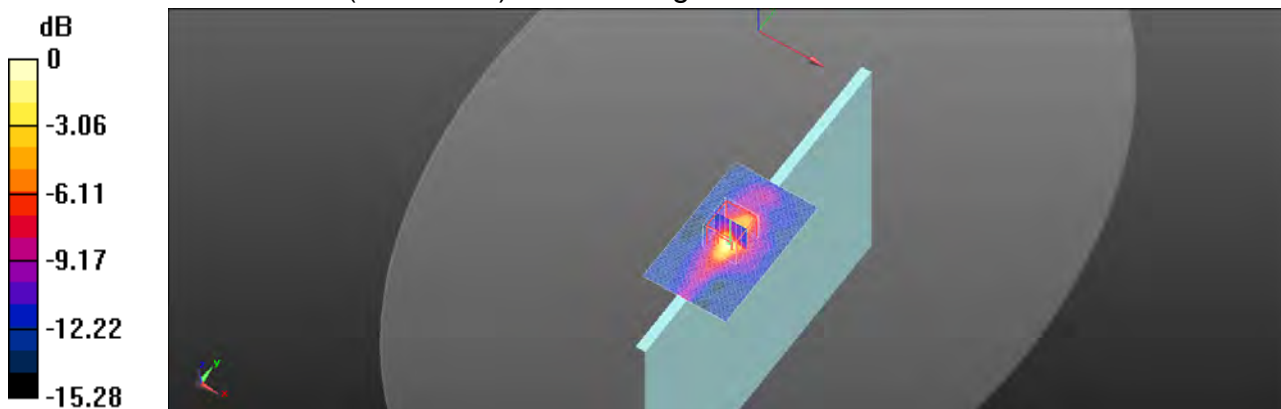

0 dB = 1.56 W/kg = 1.93 dBW/kg

Unless otherwise stated the results shown in this test report refer only to the sample(s) tested and such sample(s) are retained for 90 days only.
除非另有說明，此報告結果僅對測試之樣品負責，同時此樣品僅保留90天。本報告未經本公司書面許可，不可部份複製。

This document is issued by the Company subject to its General Conditions of Service printed overleaf, available on request or accessible at www.sgs.com/terms_and_conditions.htm and for electronic format documents, subject to Terms and Conditions for Electronic Documents at www.sgs.com/terms_e-document.htm. Attention is drawn to the limitation of liability, indemnification and jurisdiction issues defined therein. Any holder of this document is advised that information contained hereon reflects the Company's findings at the time of its intervention only and within the limits of Client's instructions, if any. The Company's sole responsibility is to its Client and this document does not exonerate parties to a transaction from exercising all their rights and obligations under the transaction documents. This document cannot be reproduced except in full, without prior written approval of the Company. Any unauthorized alteration, forgery or falsification of the content or appearance of this document is unlawful and offenders may be prosecuted to the fullest extent of the law.

Date: 2019/11/15

WLAN 802.11b Body Back side CH 11_0mm_Tx2

Communication System: WLAN 2.45G; Frequency: 2462 MHz; Duty Cycle: 1: 0.995
Medium parameters used: $f = 2462$ MHz; $\sigma = 1.95$ S/m; $\epsilon_r = 53.47$; $\rho = 1100$ kg/m³
Phantom section: Flat Section
Ambient temperature: 22.1°C; Liquid temperature: 21.2°C

DASY5 Configuration:

- Probe: EX3DV4 - SN7466; ConvF(7.71, 7.71, 7.71); Calibrated: 2019/2/4
- Sensor-Surface: 2mm (Mechanical Surface Detection)
- Electronics: DAE4 Sn1336; Calibrated: 2019/8/27
- Phantom: ELI
- DASY52 52.10.1(1476); SEMCAD X 14.6.11(7439)

Area Scan (51x81x1): Interpolated grid: dx=12 mm, dy=12 mm

Maximum value of SAR (interpolated) = 1.48 W/kg

Zoom Scan (7x7x7)/Cube 0: Measurement grid: dx=5mm, dy=5mm, dz=5mm

Reference Value = 3.282 V/m; Power Drift = 0.02 dB

Peak SAR (extrapolated) = 1.49 W/kg

SAR(1 g) = 0.886 W/kg; SAR(10 g) = 0.444 W/kg

Maximum value of SAR (measured) = 1.17 W/kg

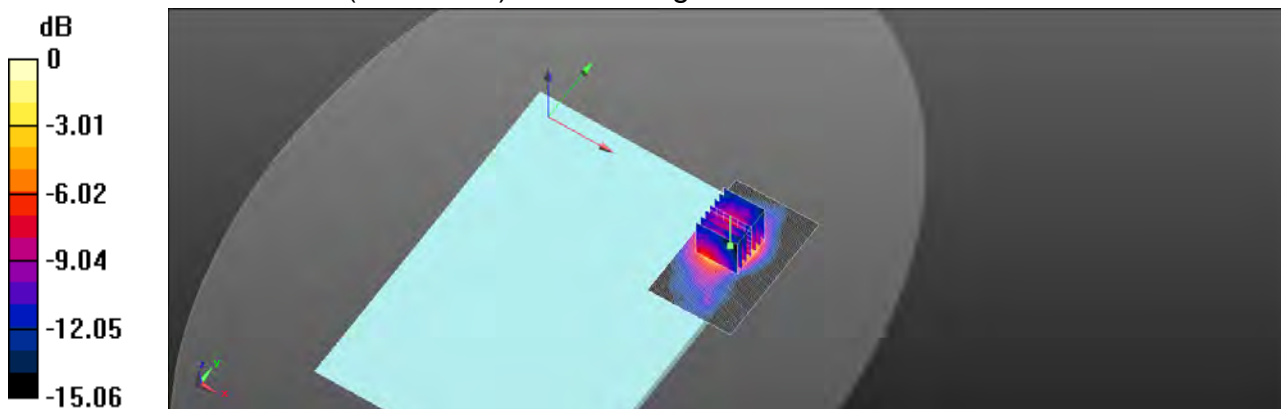

0 dB = 1.17 W/kg = 0.67 dBW/kg

Unless otherwise stated the results shown in this test report refer only to the sample(s) tested and such sample(s) are retained for 90 days only.

除非另有說明，此報告結果僅對測試之樣品負責，同時此樣品僅保留90天。本報告未經本公司書面許可，不可部份複製。

This document is issued by the Company subject to its General Conditions of Service printed overleaf, available on request or accessible at www.sgs.com/terms_and_conditions.htm and for electronic format documents, subject to Terms and Conditions for Electronic Documents at www.sgs.com/terms_e-document.htm. Attention is drawn to the limitation of liability, indemnification and jurisdiction issues defined therein. Any holder of this document is advised that information contained hereon reflects the Company's findings at the time of its intervention only and within the limits of Client's instructions, if any. The Company's sole responsibility is to its Client and this document does not exonerate parties to a transaction from exercising all their rights and obligations under the transaction documents. This document cannot be reproduced except in full, without prior written approval of the Company. Any unauthorized alteration, forgery or falsification of the content or appearance of this document is unlawful and offenders may be prosecuted to the fullest extent of the law.

Date: 2019/11/16

WLAN 802.11ac(160M) 5.2G_Body_Back side_CH 50_0mm_Tx2

Communication System: WLAN 5G; Frequency: 5250 MHz; Duty Cycle: 1: 0.985
Medium parameters used: $f = 5250$ MHz; $\sigma = 5.276$ S/m; $\epsilon_r = 49.906$; $\rho = 1000$ kg/m³
Phantom section: Flat Section
Ambient temperature: 22.6°C; Liquid temperature: 21.8°C

DASY5 Configuration:

- Probe: EX3DV4 - SN7466; ConvF(4.95, 4.95, 4.95); Calibrated: 2019/2/4
- Sensor-Surface: 2mm (Mechanical Surface Detection)
- Electronics: DAE4 Sn1336; Calibrated: 2019/8/27
- Phantom: ELI
- DASY52 52.10.1(1476); SEMCAD X 14.6.11(7439)

Area Scan (61x101x1): Interpolated grid: dx=10 mm, dy=10 mm

Maximum value of SAR (interpolated) = 1.34 W/kg

Zoom Scan (7x7x12)/Cube 0: Measurement grid: dx=4mm, dy=4mm, dz=2mm

Reference Value = 4.865 V/m; Power Drift = -0.01 dB

Peak SAR (extrapolated) = 2.34 W/kg

SAR(1 g) = 0.755 W/kg; SAR(10 g) = 0.320 W/kg

Maximum value of SAR (measured) = 1.37 W/kg

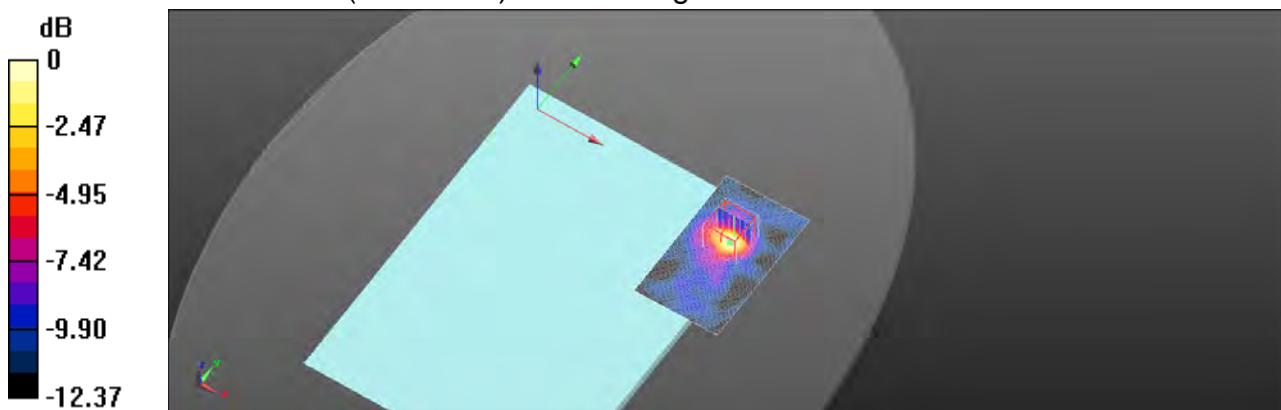

0 dB = 1.37 W/kg = 1.36 dBW/kg

Unless otherwise stated the results shown in this test report refer only to the sample(s) tested and such sample(s) are retained for 90 days only.

除非另有說明，此報告結果僅對測試之樣品負責，同時此樣品僅保留90天。本報告未經本公司書面許可，不可部份複製。

This document is issued by the Company subject to its General Conditions of Service printed overleaf, available on request or accessible at www.sgs.com/terms_and_conditions.htm and for electronic format documents, subject to Terms and Conditions for Electronic Documents at www.sgs.com/terms_e-document.htm. Attention is drawn to the limitation of liability, indemnification and jurisdiction issues defined therein. Any holder of this document is advised that information contained hereon reflects the Company's findings at the time of its intervention only and within the limits of Client's instructions, if any. The Company's sole responsibility is to its Client and this document does not exonerate parties to a transaction from exercising all their rights and obligations under the transaction documents. This document cannot be reproduced except in full, without prior written approval of the Company. Any unauthorized alteration, forgery or falsification of the content or appearance of this document is unlawful and offenders may be prosecuted to the fullest extent of the law.

Date: 2019/11/16

WLAN 802.11n(40M) 5.3G Body Back side CH 62_0mm Tx2

Communication System: WLAN 5G; Frequency: 5310 MHz; Duty Cycle: 1:0.989
Medium parameters used: $f = 5310 \text{ MHz}$; $\sigma = 5.322 \text{ S/m}$; $\epsilon_r = 49.853$; $\rho = 1000 \text{ kg/m}^3$
Phantom section: Flat Section
Ambient temperature: 22.1°C ; Liquid temperature: 21.5°C

DASY5 Configuration:

- Probe: EX3DV4 - SN7466; ConvF(4.8, 4.8, 4.8); Calibrated: 2019/2/4
- Sensor-Surface: 2mm (Mechanical Surface Detection)
- Electronics: DAE4 Sn1336; Calibrated: 2019/8/27
- Phantom: ELI
- DASY52 52.10.1(1476); SEMCAD X 14.6.11(7439)

Area Scan (61x111x1): Interpolated grid: $dx=10 \text{ mm}$, $dy=10 \text{ mm}$
Maximum value of SAR (interpolated) = 1.50 W/kg

Zoom Scan (7x7x12)/Cube 0: Measurement grid: $dx=4\text{mm}$, $dy=4\text{mm}$, $dz=2\text{mm}$
Reference Value = 5.507 V/m ; Power Drift = -0.07 dB
Peak SAR (extrapolated) = 2.09 W/kg
SAR(1 g) = 0.928 W/kg ; SAR(10 g) = 0.399 W/kg
Maximum value of SAR (measured) = 1.64 W/kg

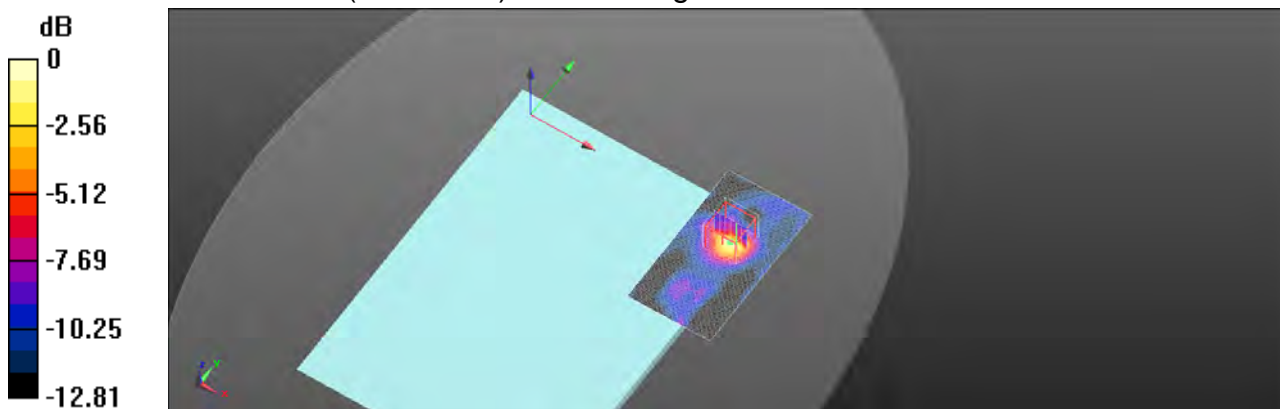

0 dB = $1.64 \text{ W/kg} = 2.14 \text{ dBW/kg}$

Unless otherwise stated the results shown in this test report refer only to the sample(s) tested and such sample(s) are retained for 90 days only.
除非另有說明，此報告結果僅對測試之樣品負責，同時此樣品僅保留90天。本報告未經本公司書面許可，不可部份複製。

This document is issued by the Company subject to its General Conditions of Service printed overleaf, available on request or accessible at www.sgs.com/terms_and_conditions.htm and for electronic format documents, subject to Terms and Conditions for Electronic Documents at www.sgs.com/terms_e-document.htm. Attention is drawn to the limitation of liability, indemnification and jurisdiction issues defined therein. Any holder of this document is advised that information contained hereon reflects the Company's findings at the time of its intervention only and within the limits of Client's instructions, if any. The Company's sole responsibility is to its Client and this document does not exonerate parties to a transaction from exercising all their rights and obligations under the transaction documents. This document cannot be reproduced except in full, without prior written approval of the Company. Any unauthorized alteration, forgery or falsification of the content or appearance of this document is unlawful and offenders may be prosecuted to the fullest extent of the law.

Date: 2019/11/17

WLAN 802.11ac(80M) 5.3G_Body_Back side_CH 58_0mm_Tx2

Communication System: WLAN 5G; Frequency: 5290 MHz; Duty Cycle: 1: 0.99
Medium parameters used: $f = 5290 \text{ MHz}$; $\sigma = 5.304 \text{ S/m}$; $\epsilon_r = 49.881$; $\rho = 1000 \text{ kg/m}^3$
Phantom section: Flat Section
Ambient temperature: 22.1°C ; Liquid temperature: 21.5°C

DASY5 Configuration:

- Probe: EX3DV4 - SN7466; ConvF(4.8, 4.8, 4.8); Calibrated: 2019/2/4
- Sensor-Surface: 2mm (Mechanical Surface Detection)
- Electronics: DAE4 Sn1336; Calibrated: 2019/8/27
- Phantom: ELI
- DASY52 52.10.1(1476); SEMCAD X 14.6.11(7439)

Area Scan (61x101x1): Interpolated grid: $dx=10 \text{ mm}$, $dy=10 \text{ mm}$
Maximum value of SAR (interpolated) = 1.55 W/kg

Zoom Scan (7x7x12)/Cube 0: Measurement grid: $dx=4\text{mm}$, $dy=4\text{mm}$, $dz=2\text{mm}$
Reference Value = 4.345 V/m ; Power Drift = 0.05 dB
Peak SAR (extrapolated) = 2.20 W/kg
SAR(1 g) = 0.819 W/kg ; SAR(10 g) = 0.341 W/kg
Maximum value of SAR (measured) = 1.46 W/kg

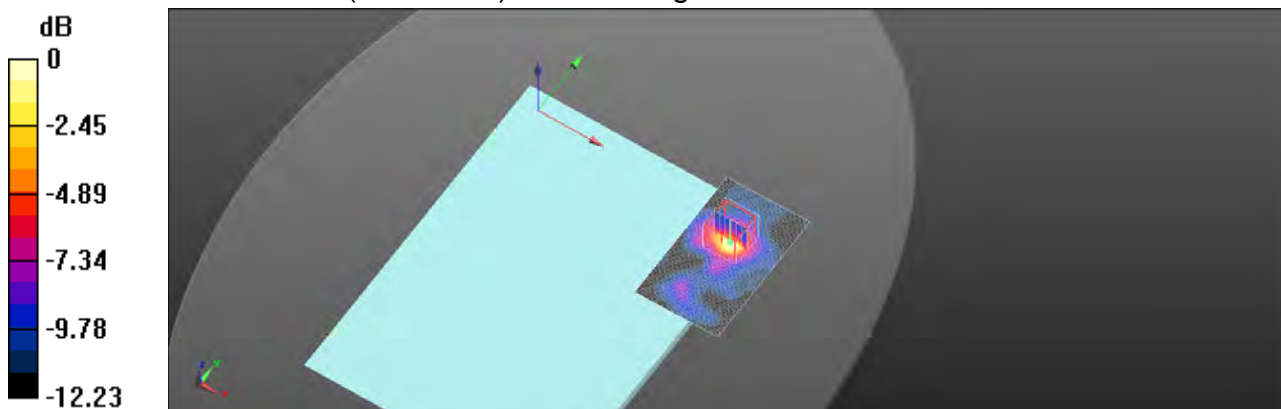

0 dB = 1.46 W/kg = 1.65 dBW/kg

Unless otherwise stated the results shown in this test report refer only to the sample(s) tested and such sample(s) are retained for 90 days only.
除非另有說明，此報告結果僅對測試之樣品負責，同時此樣品僅保留90天。本報告未經本公司書面許可，不可部份複製。

This document is issued by the Company subject to its General Conditions of Service printed overleaf, available on request or accessible at www.sgs.com/terms_and_conditions.htm and for electronic format documents, subject to Terms and Conditions for Electronic Documents at www.sgs.com/terms_e-document.htm. Attention is drawn to the limitation of liability, indemnification and jurisdiction issues defined therein. Any holder of this document is advised that information contained hereon reflects the Company's findings at the time of its intervention only and within the limits of Client's instructions, if any. The Company's sole responsibility is to its Client and this document does not exonerate parties to a transaction from exercising all their rights and obligations under the transaction documents. This document cannot be reproduced except in full, without prior written approval of the Company. Any unauthorized alteration, forgery or falsification of the content or appearance of this document is unlawful and offenders may be prosecuted to the fullest extent of the law.

Date: 2019/11/18

WLAN 802.11ac(80M) 5.6G Body Back side_CH 122_0mm_Tx2

Communication System: WLAN 5G; Frequency: 5610 MHz; Duty Cycle: 1: 0.99
Medium parameters used: $f = 5610$ MHz; $\sigma = 5.627$ S/m; $\epsilon_r = 49.62$; $\rho = 1000$ kg/m³
Phantom section: Flat Section
Ambient temperature: 22.7°C; Liquid temperature: 21.8°C

DASY5 Configuration:

- Probe: EX3DV4 - SN7466; ConvF(4.22, 4.22, 4.22); Calibrated: 2019/2/4
- Sensor-Surface: 2mm (Mechanical Surface Detection)
- Electronics: DAE4 Sn1336; Calibrated: 2019/8/27
- Phantom: ELI
- DASY52 52.10.1(1476); SEMCAD X 14.6.11(7439)

Area Scan (61x111x1): Interpolated grid: dx=10 mm, dy=10 mm
Maximum value of SAR (interpolated) = 1.59 W/kg

Zoom Scan (7x7x12)/Cube 0: Measurement grid: dx=4mm, dy=4mm, dz=2mm
Reference Value = 5.538 V/m; Power Drift = 0.03 dB
Peak SAR (extrapolated) = 2.19 W/kg
SAR(1 g) = 0.953 W/kg; SAR(10 g) = 0.431 W/kg
Maximum value of SAR (measured) = 1.93 W/kg

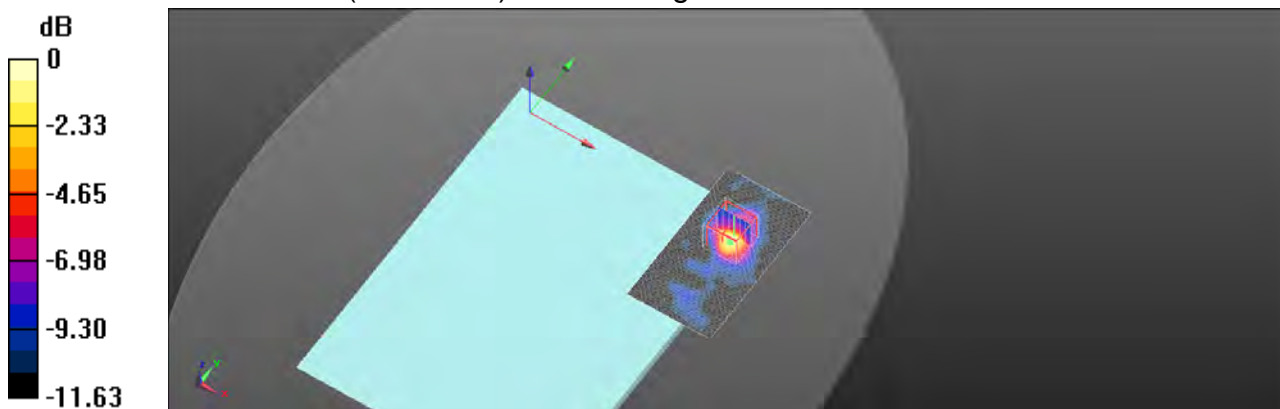

0 dB = 1.93 W/kg = 2.85 dBW/kg

Unless otherwise stated the results shown in this test report refer only to the sample(s) tested and such sample(s) are retained for 90 days only.
除非另有說明，此報告結果僅對測試之樣品負責，同時此樣品僅保留90天。本報告未經本公司書面許可，不可部份複製。

This document is issued by the Company subject to its General Conditions of Service printed overleaf, available on request or accessible at www.sgs.com/terms_and_conditions.htm and for electronic format documents, subject to Terms and Conditions for Electronic Documents at www.sgs.com/terms_e-document.htm. Attention is drawn to the limitation of liability, indemnification and jurisdiction issues defined therein. Any holder of this document is advised that information contained hereon reflects the Company's findings at the time of its intervention only and within the limits of Client's instructions, if any. The Company's sole responsibility is to its Client and this document does not exonerate parties to a transaction from exercising all their rights and obligations under the transaction documents. This document cannot be reproduced except in full, without prior written approval of the Company. Any unauthorized alteration, forgery or falsification of the content or appearance of this document is unlawful and offenders may be prosecuted to the fullest extent of the law.

Date: 2019/11/18

WLAN 802.11ac(160M) 5.6G Body Back side CH 114 0mm Tx2

Communication System: WLAN 5G; Frequency: 5570 MHz; Duty Cycle: 1: 0.985
Medium parameters used: $f = 5570$ MHz; $\sigma = 5.577$ S/m; $\epsilon_r = 49.653$; $\rho = 1000$ kg/m³
Phantom section: Flat Section
Ambient temperature: 22.7°C; Liquid temperature: 21.8°C

DASY5 Configuration:

- Probe: EX3DV4 - SN7466; ConvF(4.22, 4.22, 4.22); Calibrated: 2019/2/4
- Sensor-Surface: 2mm (Mechanical Surface Detection)
- Electronics: DAE4 Sn1336; Calibrated: 2019/8/27
- Phantom: ELI
- DASY52 52.10.1(1476); SEMCAD X 14.6.11(7439)

Area Scan (61x101x1): Interpolated grid: dx=10 mm, dy=10 mm
Maximum value of SAR (interpolated) = 1.66 W/kg

Zoom Scan (7x7x12)/Cube 0: Measurement grid: dx=4mm, dy=4mm, dz=2mm
Reference Value = 4.200 V/m; Power Drift = 0.01 dB
Peak SAR (extrapolated) = 2.23 W/kg
SAR(1 g) = 0.921 W/kg; SAR(10 g) = 0.393 W/kg
Maximum value of SAR (measured) = 1.62 W/kg

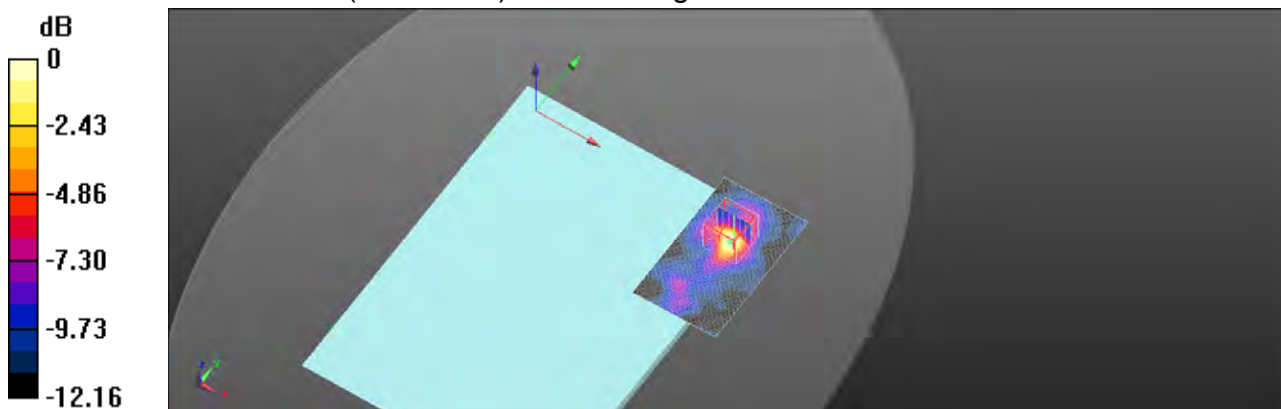

0 dB = 1.62 W/kg = 2.11 dBW/kg

Unless otherwise stated the results shown in this test report refer only to the sample(s) tested and such sample(s) are retained for 90 days only.
除非另有說明，此報告結果僅對測試之樣品負責，同時此樣品僅保留90天。本報告未經本公司書面許可，不可部份複製。

This document is issued by the Company subject to its General Conditions of Service printed overleaf, available on request or accessible at www.sgs.com/terms_and_conditions.htm and for electronic format documents, subject to Terms and Conditions for Electronic Documents at www.sgs.com/terms_e-document.htm. Attention is drawn to the limitation of liability, indemnification and jurisdiction issues defined therein. Any holder of this document is advised that information contained hereon reflects the Company's findings at the time of its intervention only and within the limits of Client's instructions, if any. The Company's sole responsibility is to its Client and this document does not exonerate parties to a transaction from exercising all their rights and obligations under the transaction documents. This document cannot be reproduced except in full, without prior written approval of the Company. Any unauthorized alteration, forgery or falsification of the content or appearance of this document is unlawful and offenders may be prosecuted to the fullest extent of the law.

Date: 2019/11/19

WLAN 802.11ac(80M) 5.8G Body Back side CH 155_0mm Tx2

Communication System: WLAN 5G; Frequency: 5775 MHz; Duty Cycle: 1: 0.99
Medium parameters used: $f = 5775$ MHz; $\sigma = 5.806$ S/m; $\epsilon_r = 49.537$; $\rho = 1000$ kg/m³
Phantom section: Flat Section
Ambient temperature: 22.1°C; Liquid temperature: 21.3°C

DASY5 Configuration:

- Probe: EX3DV4 - SN7466; ConvF(4.38, 4.38, 4.38); Calibrated: 2019/2/4
- Sensor-Surface: 2mm (Mechanical Surface Detection)
- Electronics: DAE4 Sn1336; Calibrated: 2019/8/27
- Phantom: ELI
- DASY52 52.10.1(1476); SEMCAD X 14.6.11(7439)

Area Scan (61x101x1): Interpolated grid: dx=10 mm, dy=10 mm

Maximum value of SAR (interpolated) = 1.28 W/kg

Zoom Scan (7x7x12)/Cube 0: Measurement grid: dx=4mm, dy=4mm, dz=2mm

Reference Value = 4.793 V/m; Power Drift = 0.04 dB

Peak SAR (extrapolated) = 1.92 W/kg

SAR(1 g) = 0.730 W/kg; SAR(10 g) = 0.347 W/kg

Maximum value of SAR (measured) = 1.31 W/kg

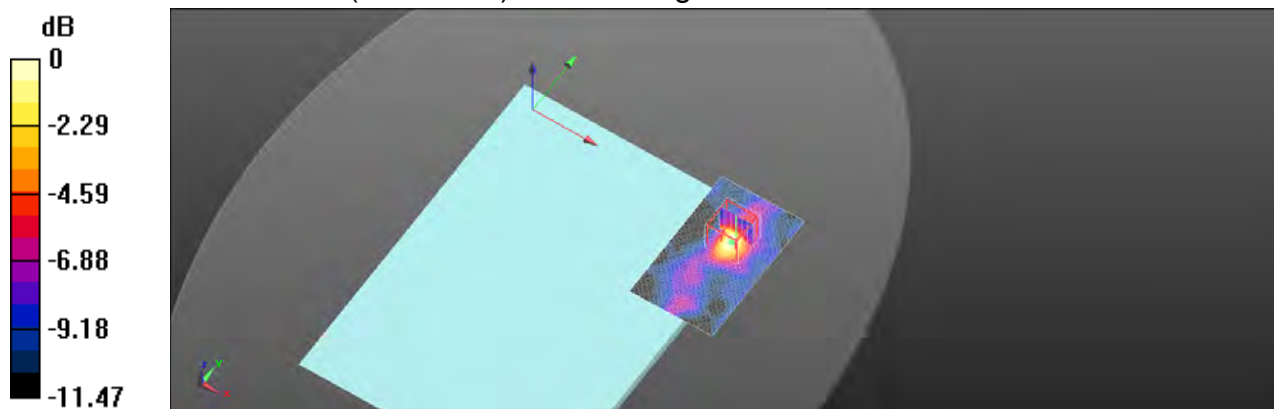

0 dB = 1.31 W/kg = 1.18 dBW/kg

Unless otherwise stated the results shown in this test report refer only to the sample(s) tested and such sample(s) are retained for 90 days only.

除非另有說明，此報告結果僅對測試之樣品負責，同時此樣品僅保留90天。本報告未經本公司書面許可，不可部份複製。

This document is issued by the Company subject to its General Conditions of Service printed overleaf, available on request or accessible at www.sgs.com/terms_and_conditions.htm and for electronic format documents, subject to Terms and Conditions for Electronic Documents at www.sgs.com/terms_e-document.htm. Attention is drawn to the limitation of liability, indemnification and jurisdiction issues defined therein. Any holder of this document is advised that information contained hereon reflects the Company's findings at the time of its intervention only and within the limits of Client's instructions, if any. The Company's sole responsibility is to its Client and this document does not exonerate parties to a transaction from exercising all their rights and obligations under the transaction documents. This document cannot be reproduced except in full, without prior written approval of the Company. Any unauthorized alteration, forgery or falsification of the content or appearance of this document is unlawful and offenders may be prosecuted to the fullest extent of the law.

6. SAR System Performance Verification

Date: 2019/11/4

Dipole 750 MHz_SN:1078

Communication System: CW; Frequency: 750 MHz; Duty Cycle: 1:1
Medium parameters used: $f = 750 \text{ MHz}$; $\sigma = 0.941 \text{ S/m}$; $\epsilon_r = 56.359$; $\rho = 1000 \text{ kg/m}^3$
Phantom section: Flat Section
Ambient temperature: 22.2°C ; Liquid temperature: 21.8°C

DASY5 Configuration:

- Probe: EX3DV4 - SN7466; ConvF(10.49, 10.49, 10.49); Calibrated: 2019/2/4
- Sensor-Surface: 2mm (Mechanical Surface Detection)
- Electronics: DAE4 Sn1336; Calibrated: 2019/8/27
- Phantom: ELI
- DASY52 52.10.1(1476); SEMCAD X 14.6.11(7439)

Area Scan (51x121x1): Interpolated grid: $dx=15 \text{ mm}$, $dy=15 \text{ mm}$

Maximum value of SAR (interpolated) = 2.63 W/kg

Zoom Scan (7x7x7)/Cube 0: Measurement grid: $dx=5\text{mm}$, $dy=5\text{mm}$, $dz=5\text{mm}$

Reference Value = 56.51 V/m ; Power Drift = -0.01 dB

Peak SAR (extrapolated) = 3.08 W/kg

SAR(1 g) = 2.14 W/kg ; SAR(10 g) = 1.45 W/kg

Maximum value of SAR (measured) = 2.65 W/kg

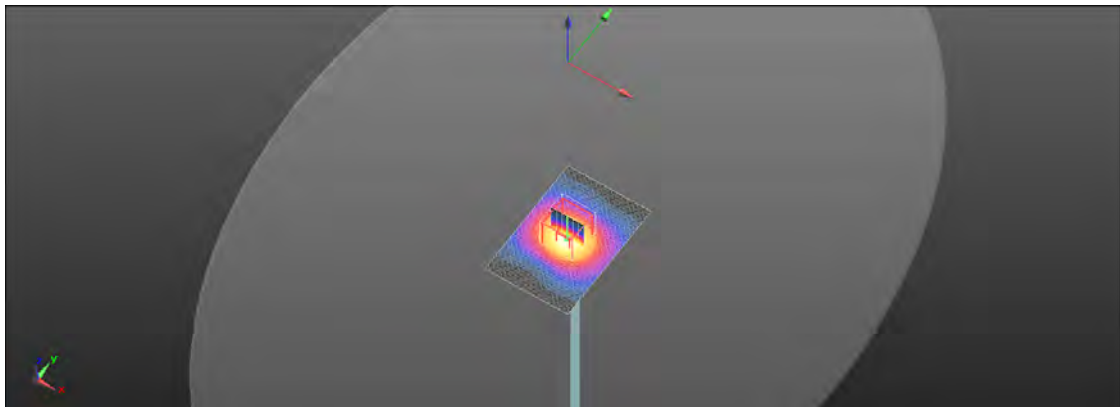
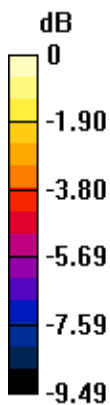

0 dB = $2.65 \text{ W/kg} = 4.24 \text{ dBW/kg}$

Unless otherwise stated the results shown in this test report refer only to the sample(s) tested and such sample(s) are retained for 90 days only.
除非另有說明，此報告結果僅對測試之樣品負責，同時此樣品僅保留90天。本報告未經本公司書面許可，不可部份複製。

This document is issued by the Company subject to its General Conditions of Service printed overleaf, available on request or accessible at www.sgs.com/terms_and_conditions.htm and for electronic format documents, subject to Terms and Conditions for Electronic Documents at www.sgs.com/terms_e-document.htm. Attention is drawn to the limitation of liability, indemnification and jurisdiction issues defined therein. Any holder of this document is advised that information contained hereon reflects the Company's findings at the time of its intervention only and within the limits of Client's instructions, if any. The Company's sole responsibility is to its Client and this document does not exonerate parties to a transaction from exercising all their rights and obligations under the transaction documents. This document cannot be reproduced except in full, without prior written approval of the Company. Any unauthorized alteration, forgery or falsification of the content or appearance of this document is unlawful and offenders may be prosecuted to the fullest extent of the law.

Date: 2019/11/5

Dipole 835 MHz_SN:4d092

Communication System: CW; Frequency: 835 MHz; Duty Cycle: 1:1
Medium parameters used: $f = 835 \text{ MHz}$; $\sigma = 0.951 \text{ S/m}$; $\epsilon_r = 55.462$; $\rho = 1000 \text{ kg/m}^3$
Phantom section: Flat Section
Ambient temperature: 22.1°C ; Liquid temperature: 21.8°C

DASY5 Configuration:

- Probe: EX3DV4 - SN7466; ConvF(10.04, 10.04, 10.04); Calibrated: 2019/2/4
- Sensor-Surface: 2mm (Mechanical Surface Detection)
- Electronics: DAE4 Sn1336; Calibrated: 2019/8/27
- Phantom: ELI
- DASY52 52.10.1(1476); SEMCAD X 14.6.11(7439)

Area Scan (61x121x1): Interpolated grid: $dx=15 \text{ mm}$, $dy=15 \text{ mm}$
Maximum value of SAR (interpolated) = 3.35 W/kg

Zoom Scan (7x7x7)/Cube 0: Measurement grid: $dx=5\text{mm}$, $dy=5\text{mm}$, $dz=5\text{mm}$
Reference Value = 60.29 V/m ; Power Drift = -0.02 dB
Peak SAR (extrapolated) = 4.06 W/kg
SAR(1 g) = 2.54 W/kg ; SAR(10 g) = 1.59 W/kg
Maximum value of SAR (measured) = 3.33 W/kg

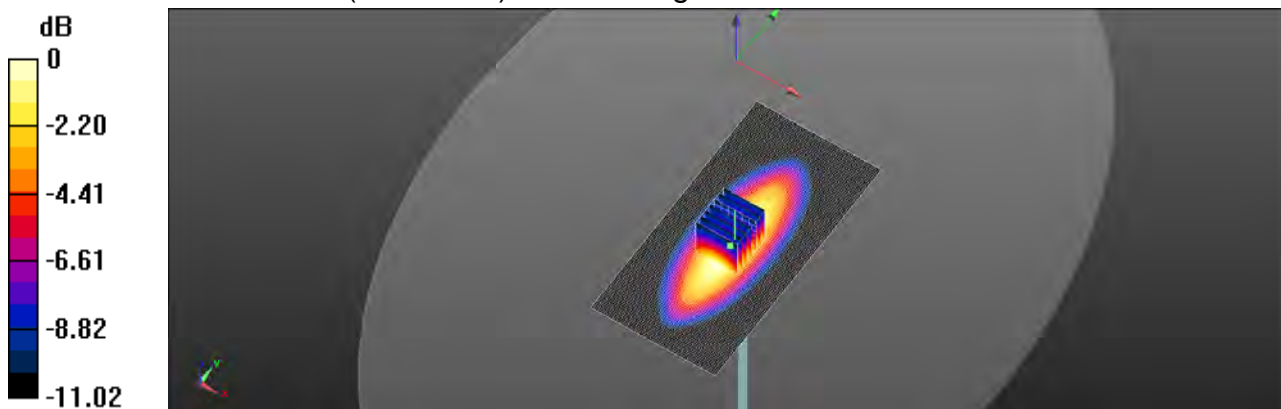

0 dB = 3.33 W/kg = 5.23 dBW/kg

Unless otherwise stated the results shown in this test report refer only to the sample(s) tested and such sample(s) are retained for 90 days only.
除非另有說明，此報告結果僅對測試之樣品負責，同時此樣品僅保留90天。本報告未經本公司書面許可，不可部份複製。

This document is issued by the Company subject to its General Conditions of Service printed overleaf, available on request or accessible at www.sgs.com/terms_and_conditions.htm and for electronic format documents, subject to Terms and Conditions for Electronic Documents at www.sgs.com/terms_e-document.htm. Attention is drawn to the limitation of liability, indemnification and jurisdiction issues defined therein. Any holder of this document is advised that information contained hereon reflects the Company's findings at the time of its intervention only and within the limits of Client's instructions, if any. The Company's sole responsibility is to its Client and this document does not exonerate parties to a transaction from exercising all their rights and obligations under the transaction documents. This document cannot be reproduced except in full, without prior written approval of the Company. Any unauthorized alteration, forgery or falsification of the content or appearance of this document is unlawful and offenders may be prosecuted to the fullest extent of the law.

Date: 2019/11/6

Dipole 1750 MHz_SN:1023

Communication System: CW; Frequency: 1750 MHz; Duty Cycle: 1:1
Medium parameters used: $f = 1750$ MHz; $\sigma = 1.518$ S/m; $\epsilon_r = 54.188$; $\rho = 1000$ kg/m³
Phantom section: Flat Section
Ambient temperature: 22.3°C; Liquid temperature: 21.8°C

DASY5 Configuration:

- Probe: EX3DV4 - SN7466; ConvF(8.48, 8.48, 8.48); Calibrated: 2019/2/4
- Sensor-Surface: 2mm (Mechanical Surface Detection)
- Electronics: DAE4 Sn1336; Calibrated: 2019/8/27
- Phantom: ELI
- DASY52 52.10.1(1476); SEMCAD X 14.6.11(7439)

Area Scan (51x61x1): Interpolated grid: dx=15 mm, dy=15 mm

Maximum value of SAR (interpolated) = 13.0 W/kg

Zoom Scan (7x7x7)/Cube 0: Measurement grid: dx=5mm, dy=5mm, dz=5mm

Reference Value = 92.93 V/m; Power Drift = 0.03 dB

Peak SAR (extrapolated) = 16.3 W/kg

SAR(1 g) = 9.12 W/kg; SAR(10 g) = 4.98 W/kg

Maximum value of SAR (measured) = 12.6 W/kg

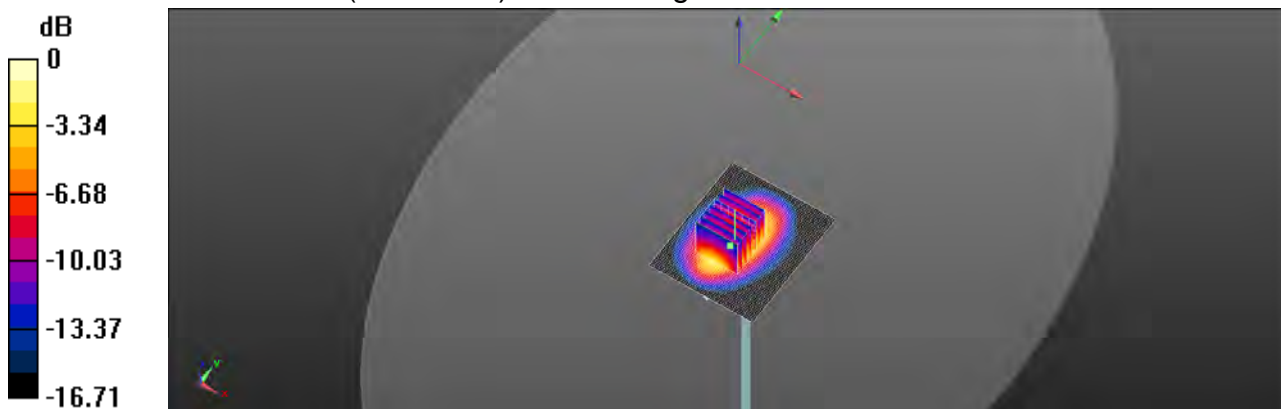

0 dB = 12.6 W/kg = 11.02 dBW/kg

Unless otherwise stated the results shown in this test report refer only to the sample(s) tested and such sample(s) are retained for 90 days only.
除非另有說明，此報告結果僅對測試之樣品負責，同時此樣品僅保留90天。本報告未經本公司書面許可，不可部份複製。

This document is issued by the Company subject to its General Conditions of Service printed overleaf, available on request or accessible at www.sgs.com/terms_and_conditions.htm and for electronic format documents, subject to Terms and Conditions for Electronic Documents at www.sgs.com/terms_e-document.htm. Attention is drawn to the limitation of liability, indemnification and jurisdiction issues defined therein. Any holder of this document is advised that information contained hereon reflects the Company's findings at the time of its intervention only and within the limits of Client's instructions, if any. The Company's sole responsibility is to its Client and this document does not exonerate parties to a transaction from exercising all their rights and obligations under the transaction documents. This document cannot be reproduced except in full, without prior written approval of the Company. Any unauthorized alteration, forgery or falsification of the content or appearance of this document is unlawful and offenders may be prosecuted to the fullest extent of the law.

Date: 2019/11/7

Dipole 1900 MHz_SN:5d142

Communication System: CW; Frequency: 1900 MHz; Duty Cycle: 1:1

Medium parameters used: $f = 1900$ MHz; $\sigma = 1.537$ S/m; $\epsilon_r = 54.115$; $\rho = 1000$ kg/m³

Phantom section: Flat Section

Ambient temperature: 22.1°C; Liquid temperature: 21.9°C

DASY5 Configuration:

- Probe: EX3DV4 - SN7466; ConvF(8.04, 8.04, 8.04); Calibrated: 2019/2/4
- Sensor-Surface: 2mm (Mechanical Surface Detection)
- Electronics: DAE4 Sn1336; Calibrated: 2019/8/27
- Phantom: ELI
- DASY52 52.10.1(1476); SEMCAD X 14.6.11(7439)

Area Scan (51x61x1): Interpolated grid: dx=15 mm, dy=15 mm

Maximum value of SAR (interpolated) = 14.1 W/kg

Zoom Scan (7x7x7)/Cube 0: Measurement grid: dx=5mm, dy=5mm, dz=5mm

Reference Value = 95.62 V/m; Power Drift = 0.03 dB

Peak SAR (extrapolated) = 16.5 W/kg

SAR(1 g) = 9.81 W/kg; SAR(10 g) = 5.21 W/kg

Maximum value of SAR (measured) = 13.7 W/kg

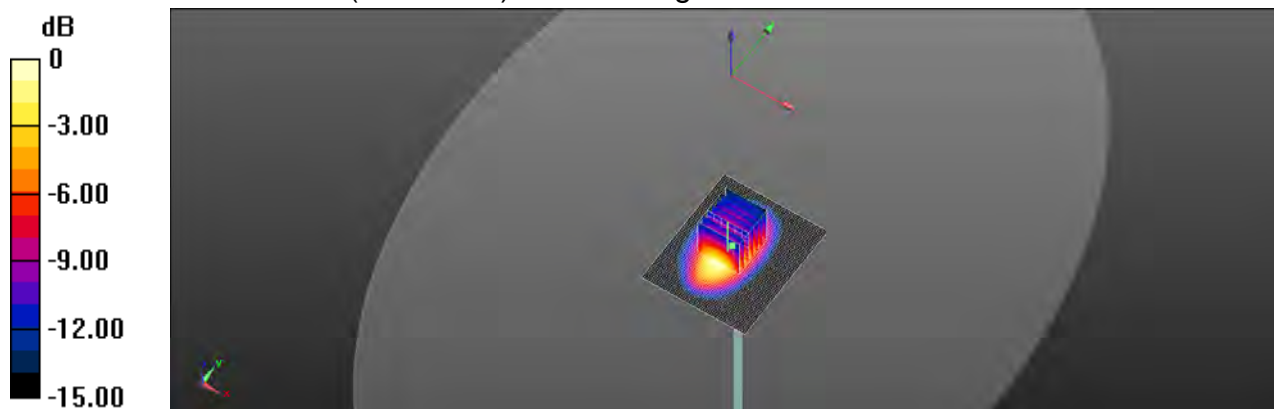

0 dB = 13.7 W/kg = 11.37 dBW/kg

Unless otherwise stated the results shown in this test report refer only to the sample(s) tested and such sample(s) are retained for 90 days only.
除非另有說明，此報告結果僅對測試之樣品負責，同時此樣品僅保留90天。本報告未經本公司書面許可，不可部份複製。

This document is issued by the Company subject to its General Conditions of Service printed overleaf, available on request or accessible at www.sgs.com/terms_and_conditions.htm and for electronic format documents, subject to Terms and Conditions for Electronic Documents at www.sgs.com/terms_e-document.htm. Attention is drawn to the limitation of liability, indemnification and jurisdiction issues defined therein. Any holder of this document is advised that information contained hereon reflects the Company's findings at the time of its intervention only and within the limits of Client's instructions, if any. The Company's sole responsibility is to its Client and this document does not exonerate parties to a transaction from exercising all their rights and obligations under the transaction documents. This document cannot be reproduced except in full, without prior written approval of the Company. Any unauthorized alteration, forgery or falsification of the content or appearance of this document is unlawful and offenders may be prosecuted to the fullest extent of the law.

Date: 2019/11/8

Dipole 2300 MHz_SN:1092

Communication System: CW; Frequency: 2300 MHz; Duty Cycle: 1:1
Medium parameters used: $f = 2300$ MHz; $\sigma = 1.759$ S/m; $\epsilon_r = 54.089$; $\rho = 1000$ kg/m³
Phantom section: Flat Section
Ambient temperature: 22.4°C; Liquid temperature: 21.8°C

DASY5 Configuration:

- Probe: EX3DV4 - SN7466; ConvF(7.84, 7.84, 7.84); Calibrated: 2019/2/4
- Sensor-Surface: 2mm (Mechanical Surface Detection)
- Electronics: DAE4 Sn1336; Calibrated: 2019/8/27
- Phantom: ELI
- DASY52 52.10.1(1476); SEMCAD X 14.6.11(7439)

Area Scan (61x131x1): Interpolated grid: dx=12 mm, dy=12 mm
Maximum value of SAR (interpolated) = 19.5 W/kg

Zoom Scan (7x7x7)/Cube 0: Measurement grid: dx=5mm, dy=5mm, dz=5mm
Reference Value = 102.8 V/m; Power Drift = -0.04 dB
Peak SAR (extrapolated) = 24.9 W/kg
SAR(1 g) = 12.4 W/kg; SAR(10 g) = 5.87 W/kg
Maximum value of SAR (measured) = 18.7 W/kg

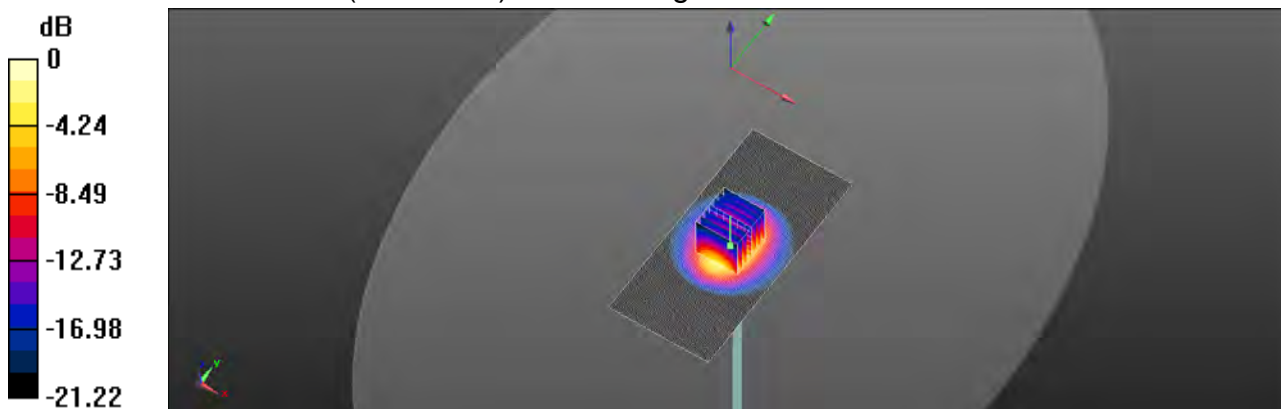

0 dB = 18.7 W/kg = 12.71 dBW/kg

Unless otherwise stated the results shown in this test report refer only to the sample(s) tested and such sample(s) are retained for 90 days only.
除非另有說明，此報告結果僅對測試之樣品負責，同時此樣品僅保留90天。本報告未經本公司書面許可，不可部份複製。

This document is issued by the Company subject to its General Conditions of Service printed overleaf, available on request or accessible at www.sgs.com/terms_and_conditions.htm and for electronic format documents, subject to Terms and Conditions for Electronic Documents at www.sgs.com/terms_e-document.htm. Attention is drawn to the limitation of liability, indemnification and jurisdiction issues defined therein. Any holder of this document is advised that information contained hereon reflects the Company's findings at the time of its intervention only and within the limits of Client's instructions, if any. The Company's sole responsibility is to its Client and this document does not exonerate parties to a transaction from exercising all their rights and obligations under the transaction documents. This document cannot be reproduced except in full, without prior written approval of the Company. Any unauthorized alteration, forgery or falsification of the content or appearance of this document is unlawful and offenders may be prosecuted to the fullest extent of the law.

Date: 2019/11/9

Dipole 2450 MHz_SN:869

Communication System: CW; Frequency: 2450 MHz; Duty Cycle: 1:1
Medium parameters used: $f = 2450$ MHz; $\sigma = 1.896$ S/m; $\epsilon_r = 52.845$; $\rho = 1000$ kg/m³
Phantom section: Flat Section
Ambient temperature: 22.1°C; Liquid temperature: 21.1°C

DASY5 Configuration:

- Probe: EX3DV4 - SN7466; ConvF(7.71, 7.71, 7.71); Calibrated: 2019/2/4
- Sensor-Surface: 2mm (Mechanical Surface Detection)
- Electronics: DAE4 Sn1336; Calibrated: 2019/8/27
- Phantom: ELI
- DASY52 52.10.1(1476); SEMCAD X 14.6.11(7439)

Area Scan (61x91x1): Interpolated grid: dx=12 mm, dy=12 mm

Maximum value of SAR (interpolated) = 19.8 W/kg

Zoom Scan (7x7x7)/Cube 0: Measurement grid: dx=5mm, dy=5mm, dz=5mm

Reference Value = 95.80 V/m; Power Drift = -0.04 dB

Peak SAR (extrapolated) = 25.4 W/kg

SAR(1 g) = 12.5 W/kg; SAR(10 g) = 6.18 W/kg

Maximum value of SAR (measured) = 19.0 W/kg

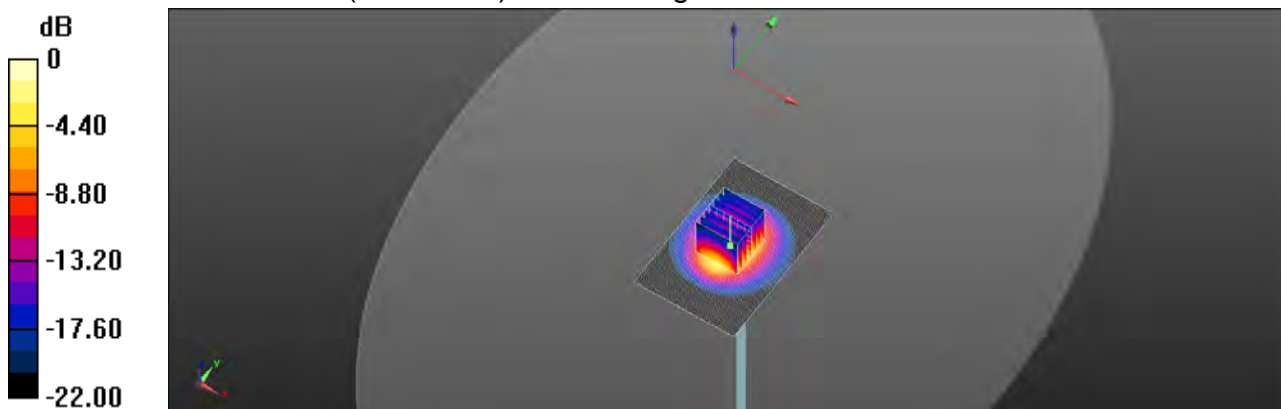

0 dB = 19.0 W/kg = 12.80 dBW/kg

Unless otherwise stated the results shown in this test report refer only to the sample(s) tested and such sample(s) are retained for 90 days only.

除非另有說明，此報告結果僅對測試之樣品負責，同時此樣品僅保留90天。本報告未經本公司書面許可，不可部份複製。

This document is issued by the Company subject to its General Conditions of Service printed overleaf, available on request or accessible at www.sgs.com/terms_and_conditions.htm and for electronic format documents, subject to Terms and Conditions for Electronic Documents at www.sgs.com/terms_e-document.htm. Attention is drawn to the limitation of liability, indemnification and jurisdiction issues defined therein. Any holder of this document is advised that information contained hereon reflects the Company's findings at the time of its intervention only and within the limits of Client's instructions, if any. The Company's sole responsibility is to its Client and this document does not exonerate parties to a transaction from exercising all their rights and obligations under the transaction documents. This document cannot be reproduced except in full, without prior written approval of the Company. Any unauthorized alteration, forgery or falsification of the content or appearance of this document is unlawful and offenders may be prosecuted to the fullest extent of the law.

Date: 2020/1/9

Dipole 2450 MHz_SN:896

Communication System: CW; Frequency: 2450 MHz; Duty Cycle: 1:1
Medium parameters used: $f = 2450$ MHz; $\sigma = 1.933$ S/m; $\epsilon_r = 53.322$; $\rho = 1000$ kg/m³
Phantom section: Flat Section
Ambient temperature: 22.2°C; Liquid temperature: 21.7°C

DASY5 Configuration:

- Probe: EX3DV4 - SN7466; ConvF(7.71, 7.71, 7.71); Calibrated: 2019/2/4
- Sensor-Surface: 2mm (Mechanical Surface Detection)
- Electronics: DAE4 Sn877; Calibrated: 2019/3/22
- Phantom: ELI
- DASY52 52.10.1(1476); SEMCAD X 14.6.11(7439)

Area Scan (61x91x1): Interpolated grid: dx=12 mm, dy=12 mm

Maximum value of SAR (interpolated) = 14.9 W/kg

Zoom Scan (7x7x7)/Cube 0: Measurement grid: dx=5mm, dy=5mm, dz=5mm

Reference Value = 83.65 V/m; Power Drift = -0.01 dB

Peak SAR (extrapolated) = 19.0 W/kg

SAR(1 g) = 13.4 W/kg; SAR(10 g) = 6.18 W/kg

Maximum value of SAR (measured) = 14.4 W/kg

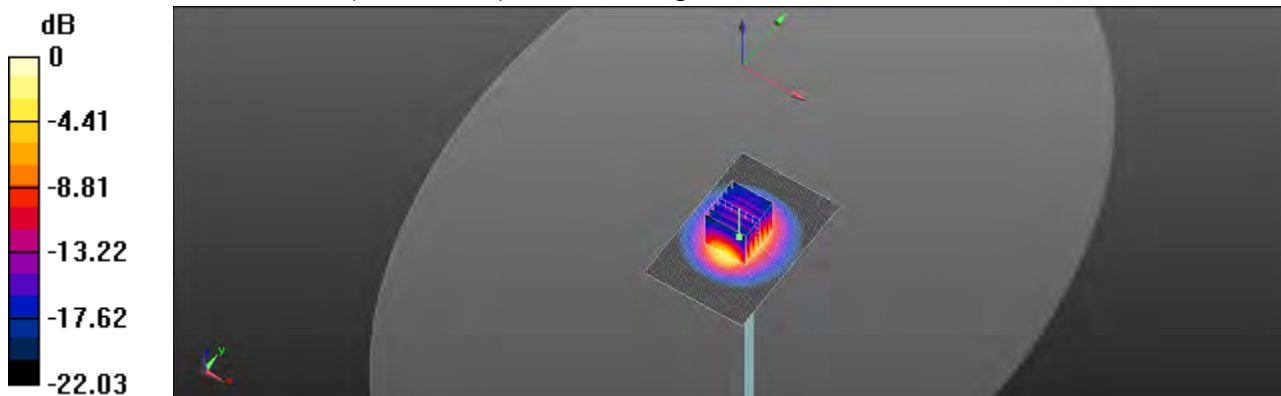

0 dB = 14.4 W/kg = 11.57 dBW/kg

Unless otherwise stated the results shown in this test report refer only to the sample(s) tested and such sample(s) are retained for 90 days only.

除非另有說明，此報告結果僅對測試之樣品負責，同時此樣品僅保留90天。本報告未經本公司書面許可，不可部份複製。

This document is issued by the Company subject to its General Conditions of Service printed overleaf, available on request or accessible at www.sgs.com/terms_and_conditions.htm and for electronic format documents, subject to Terms and Conditions for Electronic Documents at www.sgs.com/terms_e-document.htm. Attention is drawn to the limitation of liability, indemnification and jurisdiction issues defined therein. Any holder of this document is advised that information contained hereon reflects the Company's findings at the time of its intervention only and within the limits of Client's instructions, if any. The Company's sole responsibility is to its Client and this document does not exonerate parties to a transaction from exercising all their rights and obligations under the transaction documents. This document cannot be reproduced except in full, without prior written approval of the Company. Any unauthorized alteration, forgery or falsification of the content or appearance of this document is unlawful and offenders may be prosecuted to the fullest extent of the law.

Date: 2019/11/10

Dipole 2600 MHz_SN:1058

Communication System: CW; Frequency: 2600 MHz; Duty Cycle: 1:1
Medium parameters used: $f = 2600$ MHz; $\sigma = 2.204$ S/m; $\epsilon_r = 51.911$; $\rho = 1000$ kg/m³
Phantom section: Flat Section
Ambient temperature: 22.5°C; Liquid temperature: 21.8°C

DASY5 Configuration:

- Probe: EX3DV4 - SN7466; ConvF(7.47, 7.47, 7.47); Calibrated: 2019/2/4
- Sensor-Surface: 2mm (Mechanical Surface Detection)
- Electronics: DAE4 Sn1336; Calibrated: 2019/8/27
- Phantom: ELI
- DASY52 52.10.1(1476); SEMCAD X 14.6.11(7439)

Area Scan (71x91x1): Interpolated grid: dx=12 mm, dy=12 mm

Maximum value of SAR (interpolated) = 23.4 W/kg

Zoom Scan (7x7x7)/Cube 0: Measurement grid: dx=5mm, dy=5mm, dz=5mm

Reference Value = 100.1 V/m; Power Drift = 0.05 dB

Peak SAR (extrapolated) = 31.3 W/kg

SAR(1 g) = 14.1 W/kg; SAR(10 g) = 6.31 W/kg

Maximum value of SAR (measured) = 22.3 W/kg

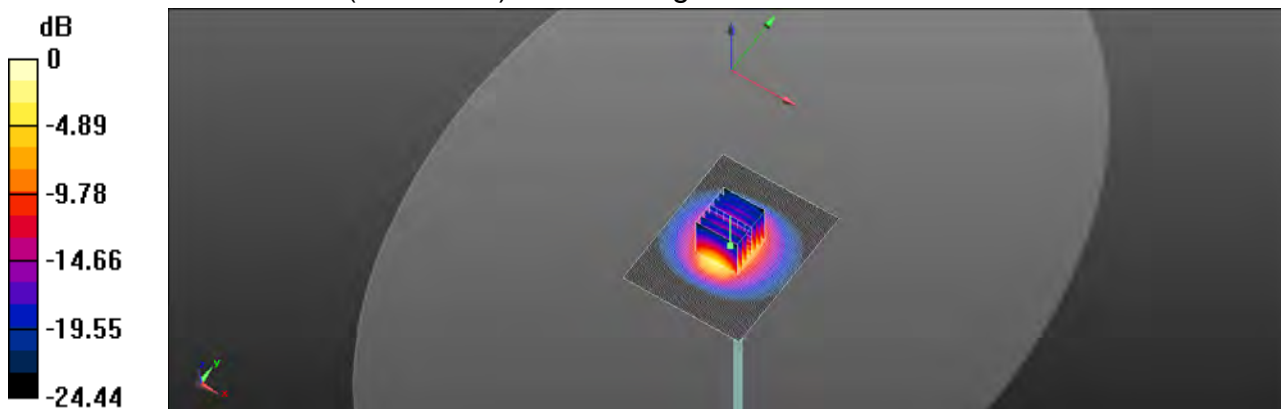

0 dB = 22.3 W/kg = 13.48 dBW/kg

Unless otherwise stated the results shown in this test report refer only to the sample(s) tested and such sample(s) are retained for 90 days only.

除非另有說明，此報告結果僅對測試之樣品負責，同時此樣品僅保留90天。本報告未經本公司書面許可，不可部份複製。

This document is issued by the Company subject to its General Conditions of Service printed overleaf, available on request or accessible at www.sgs.com/terms_and_conditions.htm and for electronic format documents, subject to Terms and Conditions for Electronic Documents at www.sgs.com/terms_e-document.htm. Attention is drawn to the limitation of liability, indemnification and jurisdiction issues defined therein. Any holder of this document is advised that information contained hereon reflects the Company's findings at the time of its intervention only and within the limits of Client's instructions, if any. The Company's sole responsibility is to its Client and this document does not exonerate parties to a transaction from exercising all their rights and obligations under the transaction documents. This document cannot be reproduced except in full, without prior written approval of the Company. Any unauthorized alteration, forgery or falsification of the content or appearance of this document is unlawful and offenders may be prosecuted to the fullest extent of the law.

Date: 2019/11/11

Dipole 5200 MHz_SN:1040

Communication System: CW; Frequency: 5200 MHz; Duty Cycle: 1:1
Medium parameters used: $f = 5200$ MHz; $\sigma = 5.18$ S/m; $\epsilon_r = 49.854$; $\rho = 1000$ kg/m³
Phantom section: Flat Section
Ambient temperature: 22.1°C; Liquid temperature: 21.2°C

DASY5 Configuration:

- Probe: EX3DV4 - SN7466; ConvF(4.95, 4.95, 4.95); Calibrated: 2019/2/4
- Sensor-Surface: 2mm (Mechanical Surface Detection)
- Electronics: DAE4 Sn1336; Calibrated: 2019/8/27
- Phantom: ELI
- DASY52 52.10.1(1476); SEMCAD X 14.6.11(7439)

Area Scan (51x51x1): Interpolated grid: dx=10 mm, dy=10 mm

Maximum value of SAR (interpolated) = 15.4 W/kg

Zoom Scan (7x7x12)/Cube 0: Measurement grid: dx=4mm, dy=4mm, dz=2mm

Reference Value = 57.91 V/m; Power Drift = 0.03 dB

Peak SAR (extrapolated) = 31.8 W/kg

SAR(1 g) = 7.37 W/kg; SAR(10 g) = 2.02 W/kg

Maximum value of SAR (measured) = 16.2 W/kg



0 dB = 16.2 W/kg = 12.10 dBW/kg

Unless otherwise stated the results shown in this test report refer only to the sample(s) tested and such sample(s) are retained for 90 days only.

除非另有說明，此報告結果僅對測試之樣品負責，同時此樣品僅保留90天。本報告未經本公司書面許可，不可部份複製。

This document is issued by the Company subject to its General Conditions of Service printed overleaf, available on request or accessible at www.sgs.com/terms_and_conditions.htm and for electronic format documents, subject to Terms and Conditions for Electronic Documents at www.sgs.com/terms_e-document.htm. Attention is drawn to the limitation of liability, indemnification and jurisdiction issues defined therein. Any holder of this document is advised that information contained hereon reflects the Company's findings at the time of its intervention only and within the limits of Client's instructions, if any. The Company's sole responsibility is to its Client and this document does not exonerate parties to a transaction from exercising all their rights and obligations under the transaction documents. This document cannot be reproduced except in full, without prior written approval of the Company. Any unauthorized alteration, forgery or falsification of the content or appearance of this document is unlawful and offenders may be prosecuted to the fullest extent of the law.

Date: 2019/11/12

Dipole 5300 MHz_SN:1040

Communication System: CW; Frequency: 5300 MHz; Duty Cycle: 1:1
Medium parameters used: $f = 5300$ MHz; $\sigma = 5.277$ S/m; $\epsilon_r = 49.799$; $\rho = 1000$ kg/m³
Phantom section: Flat Section
Ambient temperature: 22.6°C; Liquid temperature: 21.8°C

DASY5 Configuration:

- Probe: EX3DV4 - SN7466; ConvF(4.8, 4.8, 4.8); Calibrated: 2019/2/4
- Sensor-Surface: 2mm (Mechanical Surface Detection)
- Electronics: DAE4 Sn1336; Calibrated: 2019/8/27
- Phantom: ELI
- DASY52 52.10.1(1476); SEMCAD X 14.6.11(7439)

Area Scan (61x91x1): Interpolated grid: dx=10 mm, dy=10 mm

Maximum value of SAR (interpolated) = 16.4 W/kg

Zoom Scan (7x7x12)/Cube 0: Measurement grid: dx=4mm, dy=4mm, dz=2mm

Reference Value = 54.93 V/m; Power Drift = -0.13 dB

Peak SAR (extrapolated) = 31.1 W/kg

SAR(1 g) = 7.44 W/kg; SAR(10 g) = 2.09 W/kg

Maximum value of SAR (measured) = 16.2 W/kg

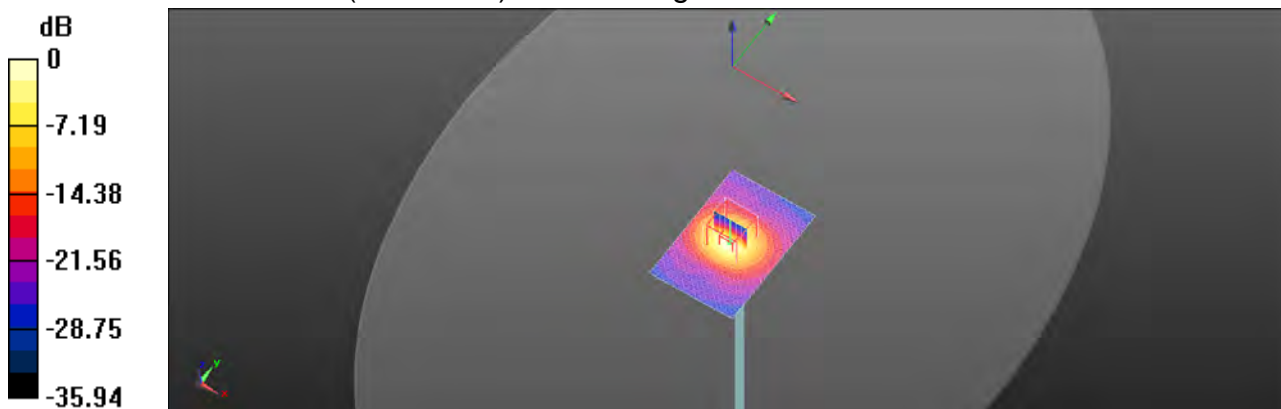

0 dB = 16.2 W/kg = 12.09 dBW/kg

Unless otherwise stated the results shown in this test report refer only to the sample(s) tested and such sample(s) are retained for 90 days only.
除非另有說明，此報告結果僅對測試之樣品負責，同時此樣品僅保留90天。本報告未經本公司書面許可，不可部份複製。

This document is issued by the Company subject to its General Conditions of Service printed overleaf, available on request or accessible at www.sgs.com/terms_and_conditions.htm and for electronic format documents, subject to Terms and Conditions for Electronic Documents at www.sgs.com/terms_e-document.htm. Attention is drawn to the limitation of liability, indemnification and jurisdiction issues defined therein. Any holder of this document is advised that information contained hereon reflects the Company's findings at the time of its intervention only and within the limits of Client's instructions, if any. The Company's sole responsibility is to its Client and this document does not exonerate parties to a transaction from exercising all their rights and obligations under the transaction documents. This document cannot be reproduced except in full, without prior written approval of the Company. Any unauthorized alteration, forgery or falsification of the content or appearance of this document is unlawful and offenders may be prosecuted to the fullest extent of the law.

Date: 2019/11/13

Dipole 5600 MHz_SN:1040

Communication System: CW; Frequency: 5600 MHz; Duty Cycle: 1:1
Medium parameters used: $f = 5600$ MHz; $\sigma = 5.844$ S/m; $\epsilon_r = 49.174$; $\rho = 1000$ kg/m³
Phantom section: Flat Section
Ambient temperature: 22.1°C; Liquid temperature: 21.3°C

DASY5 Configuration:

- Probe: EX3DV4 - SN7466; ConvF(4.22, 4.22, 4.22); Calibrated: 2019/2/4
- Sensor-Surface: 2mm (Mechanical Surface Detection)
- Electronics: DAE4 Sn1336; Calibrated: 2019/8/27
- Phantom: ELI
- DASY52 52.10.1(1476); SEMCAD X 14.6.11(7439)

Area Scan (61x91x1): Interpolated grid: dx=10 mm, dy=10 mm

Maximum value of SAR (interpolated) = 17.1 W/kg

Zoom Scan (7x7x12)/Cube 0: Measurement grid: dx=4mm, dy=4mm, dz=2mm

Reference Value = 56.06 V/m; Power Drift = -0.05 dB

Peak SAR (extrapolated) = 33.4 W/kg

SAR(1 g) = 7.92 W/kg; SAR(10 g) = 2.25 W/kg

Maximum value of SAR (measured) = 17.1 W/kg

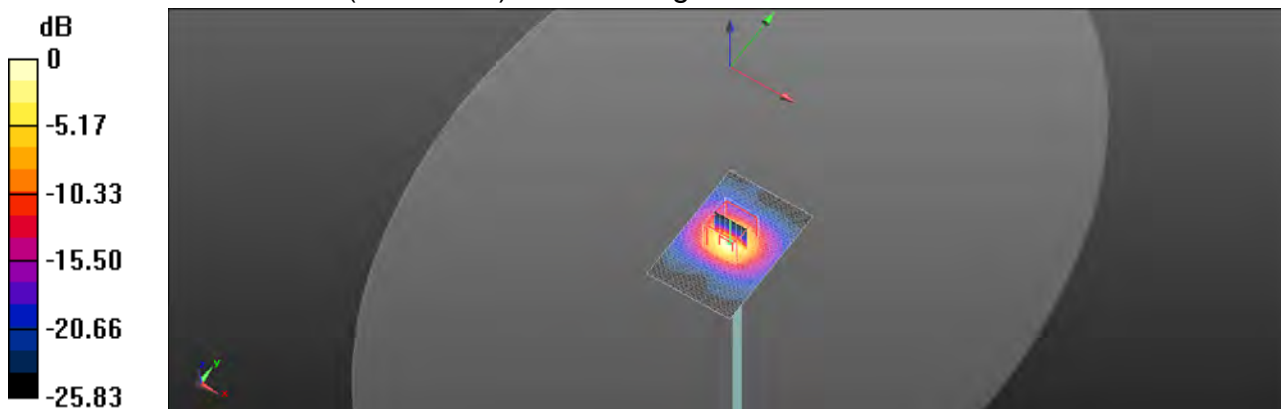

0 dB = 17.1 W/kg = 12.33 dBW/kg

Unless otherwise stated the results shown in this test report refer only to the sample(s) tested and such sample(s) are retained for 90 days only.

除非另有說明，此報告結果僅對測試之樣品負責，同時此樣品僅保留90天。本報告未經本公司書面許可，不可部份複製。

This document is issued by the Company subject to its General Conditions of Service printed overleaf, available on request or accessible at www.sgs.com/terms_and_conditions.htm and for electronic format documents, subject to Terms and Conditions for Electronic Documents at www.sgs.com/terms_e-document.htm. Attention is drawn to the limitation of liability, indemnification and jurisdiction issues defined therein. Any holder of this document is advised that information contained hereon reflects the Company's findings at the time of its intervention only and within the limits of Client's instructions, if any. The Company's sole responsibility is to its Client and this document does not exonerate parties to a transaction from exercising all their rights and obligations under the transaction documents. This document cannot be reproduced except in full, without prior written approval of the Company. Any unauthorized alteration, forgery or falsification of the content or appearance of this document is unlawful and offenders may be prosecuted to the fullest extent of the law.

Date: 2019/11/14

Dipole 5800 MHz_SN:1040

Communication System: CW; Frequency: 5800 MHz; Duty Cycle: 1:1
Medium parameters used: $f = 5800$ MHz; $\sigma = 5.995$ S/m; $\epsilon_r = 48.021$; $\rho = 1000$ kg/m³
Phantom section: Flat Section
Ambient temperature: 22.7°C; Liquid temperature: 21.8°C

DASY5 Configuration:

- Probe: EX3DV4 - SN7466; ConvF(4.38, 4.38, 4.38); Calibrated: 2019/2/4
- Sensor-Surface: 2mm (Mechanical Surface Detection)
- Electronics: DAE4 Sn1336; Calibrated: 2019/8/27
- Phantom: ELI
- DASY52 52.10.1(1476); SEMCAD X 14.6.11(7439)

Area Scan (61x91x1): Interpolated grid: dx=10 mm, dy=10 mm

Maximum value of SAR (interpolated) = 17.2 W/kg

Zoom Scan (7x7x12)/Cube 0: Measurement grid: dx=4mm, dy=4mm, dz=2mm

Reference Value = 56.88 V/m; Power Drift = -0.04 dB

Peak SAR (extrapolated) = 31.2 W/kg

SAR(1 g) = 7.47 W/kg; SAR(10 g) = 2.06 W/kg

Maximum value of SAR (measured) = 15.9 W/kg

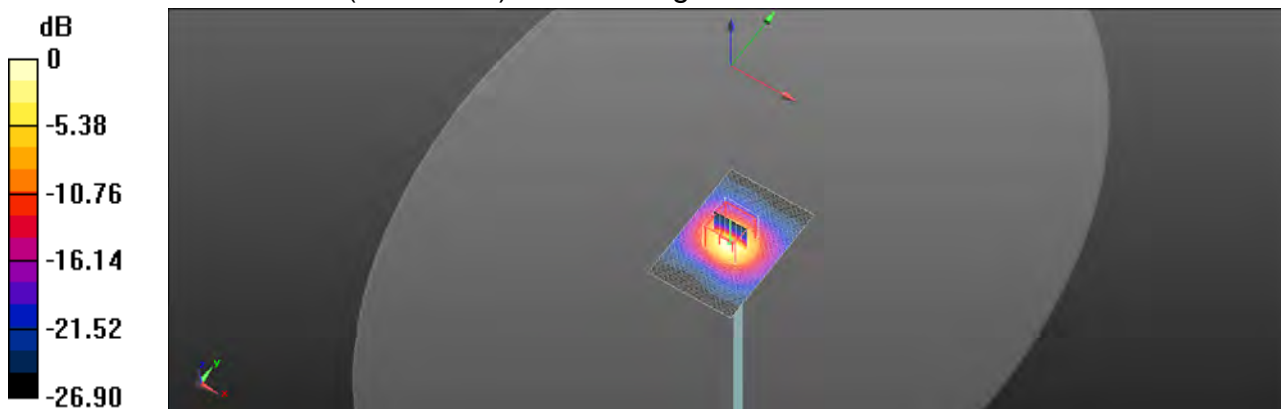

0 dB = 15.9 W/kg = 12.01 dBW/kg

Unless otherwise stated the results shown in this test report refer only to the sample(s) tested and such sample(s) are retained for 90 days only.
除非另有說明，此報告結果僅對測試之樣品負責，同時此樣品僅保留90天。本報告未經本公司書面許可，不可部份複製。

This document is issued by the Company subject to its General Conditions of Service printed overleaf, available on request or accessible at www.sgs.com/terms_and_conditions.htm and for electronic format documents, subject to Terms and Conditions for Electronic Documents at www.sgs.com/terms_e-document.htm. Attention is drawn to the limitation of liability, indemnification and jurisdiction issues defined therein. Any holder of this document is advised that information contained hereon reflects the Company's findings at the time of its intervention only and within the limits of Client's instructions, if any. The Company's sole responsibility is to its Client and this document does not exonerate parties to a transaction from exercising all their rights and obligations under the transaction documents. This document cannot be reproduced except in full, without prior written approval of the Company. Any unauthorized alteration, forgery or falsification of the content or appearance of this document is unlawful and offenders may be prosecuted to the fullest extent of the law.

Date: 2019/11/15

Dipole 2450 MHz_SN:869

Communication System: CW; Frequency: 2450 MHz; Duty Cycle: 1:1
Medium parameters used: $f = 2450$ MHz; $\sigma = 1.931$ S/m; $\epsilon_r = 53.508$; $\rho = 1000$ kg/m³
Phantom section: Flat Section
Ambient temperature: 22.1°C; Liquid temperature: 21.2°C

DASY5 Configuration:

- Probe: EX3DV4 - SN7466; ConvF(7.71, 7.71, 7.71); Calibrated: 2019/2/4
- Sensor-Surface: 2mm (Mechanical Surface Detection)
- Electronics: DAE4 Sn1336; Calibrated: 2019/8/27
- Phantom: ELI
- DASY52 52.10.1(1476); SEMCAD X 14.6.11(7439)

Area Scan (61x131x1): Interpolated grid: dx=12 mm, dy=12 mm
Maximum value of SAR (interpolated) = 20.3 W/kg

Zoom Scan (7x7x7)/Cube 0: Measurement grid: dx=5mm, dy=5mm, dz=5mm
Reference Value = 98.39 V/m; Power Drift = 0.03 dB
Peak SAR (extrapolated) = 26.6 W/kg
SAR(1 g) = 13.5 W/kg; SAR(10 g) = 6.21 W/kg
Maximum value of SAR (measured) = 19.4 W/kg

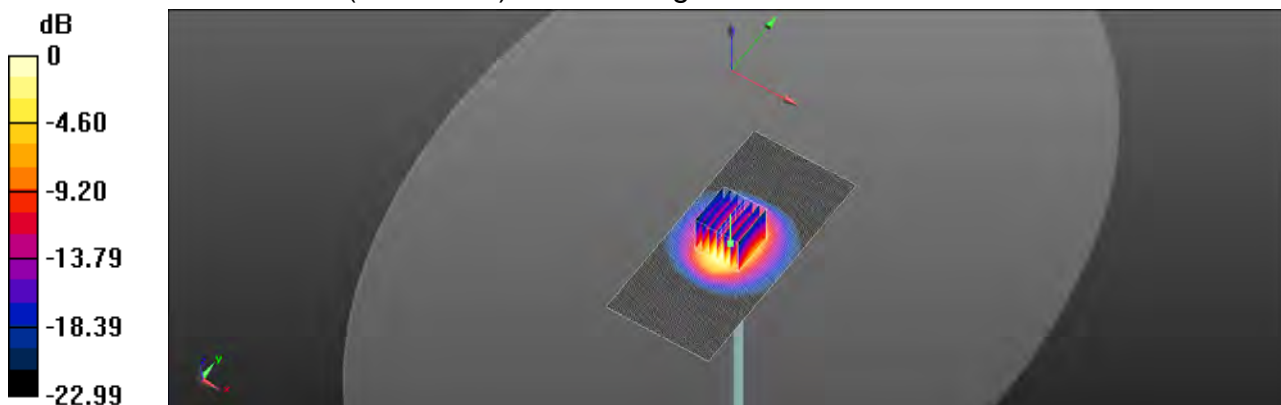

0 dB = 19.4 W/kg = 12.87 dBW/kg

Unless otherwise stated the results shown in this test report refer only to the sample(s) tested and such sample(s) are retained for 90 days only.
除非另有說明，此報告結果僅對測試之樣品負責，同時此樣品僅保留90天。本報告未經本公司書面許可，不可部份複製。

This document is issued by the Company subject to its General Conditions of Service printed overleaf, available on request or accessible at www.sgs.com/terms_and_conditions.htm and for electronic format documents, subject to Terms and Conditions for Electronic Documents at www.sgs.com/terms_e-document.htm. Attention is drawn to the limitation of liability, indemnification and jurisdiction issues defined therein. Any holder of this document is advised that information contained hereon reflects the Company's findings at the time of its intervention only and within the limits of Client's instructions, if any. The Company's sole responsibility is to its Client and this document does not exonerate parties to a transaction from exercising all their rights and obligations under the transaction documents. This document cannot be reproduced except in full, without prior written approval of the Company. Any unauthorized alteration, forgery or falsification of the content or appearance of this document is unlawful and offenders may be prosecuted to the fullest extent of the law.

Date: 2019/11/16

Dipole 5200 MHz_SN:1040

Communication System: CW; Frequency: 5200 MHz; Duty Cycle: 1:1
Medium parameters used: $f = 5200$ MHz; $\sigma = 5.242$ S/m; $\epsilon_r = 49.922$; $\rho = 1000$ kg/m³
Phantom section: Flat Section
Ambient temperature: 22.6°C; Liquid temperature: 21.8°C

DASY5 Configuration:

- Probe: EX3DV4 - SN7466; ConvF(4.95, 4.95, 4.95); Calibrated: 2019/2/4
- Sensor-Surface: 2mm (Mechanical Surface Detection)
- Electronics: DAE4 Sn1336; Calibrated: 2019/8/27
- Phantom: ELI
- DASY52 52.10.1(1476); SEMCAD X 14.6.11(7439)

Area Scan (61x91x1): Interpolated grid: dx=10 mm, dy=10 mm

Maximum value of SAR (interpolated) = 15.1 W/kg

Zoom Scan (7x7x12)/Cube 0: Measurement grid: dx=4mm, dy=4mm, dz=2mm

Reference Value = 57.37 V/m; Power Drift = -0.07 dB

Peak SAR (extrapolated) = 30.7 W/kg

SAR(1 g) = 7.36 W/kg; SAR(10 g) = 2.09 W/kg

Maximum value of SAR (measured) = 15.7 W/kg

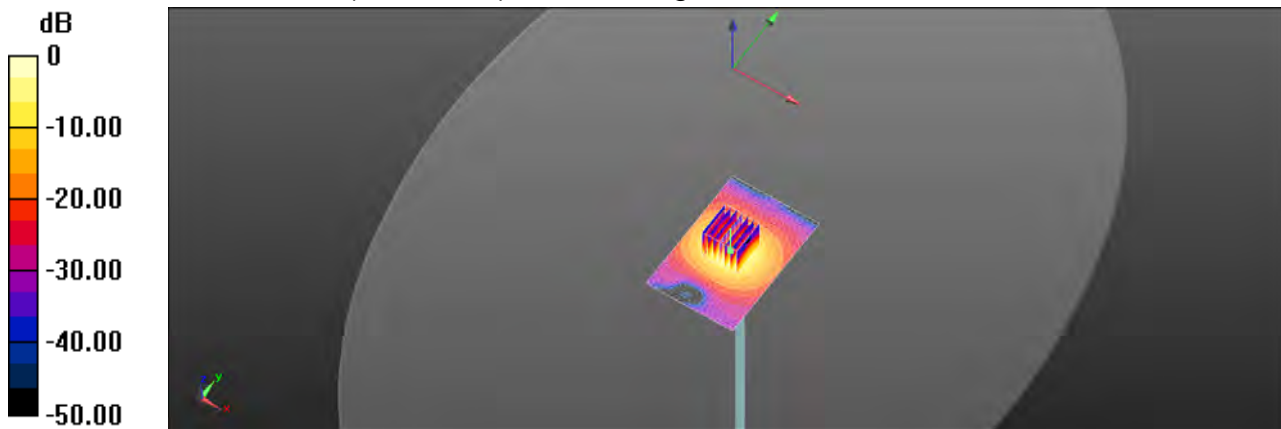

0 dB = 15.7 W/kg = 11.97 dBW/kg

Unless otherwise stated the results shown in this test report refer only to the sample(s) tested and such sample(s) are retained for 90 days only.

除非另有說明，此報告結果僅對測試之樣品負責，同時此樣品僅保留90天。本報告未經本公司書面許可，不可部份複製。

This document is issued by the Company subject to its General Conditions of Service printed overleaf, available on request or accessible at www.sgs.com/terms_and_conditions.htm and for electronic format documents, subject to Terms and Conditions for Electronic Documents at www.sgs.com/terms_e-document.htm. Attention is drawn to the limitation of liability, indemnification and jurisdiction issues defined therein. Any holder of this document is advised that information contained hereon reflects the Company's findings at the time of its intervention only and within the limits of Client's instructions, if any. The Company's sole responsibility is to its Client and this document does not exonerate parties to a transaction from exercising all their rights and obligations under the transaction documents. This document cannot be reproduced except in full, without prior written approval of the Company. Any unauthorized alteration, forgery or falsification of the content or appearance of this document is unlawful and offenders may be prosecuted to the fullest extent of the law.

Date: 2019/11/17

Dipole 5300 MHz_SN:1040

Communication System: CW; Frequency: 5300 MHz; Duty Cycle: 1:1
Medium parameters used: $f = 5300$ MHz; $\sigma = 5.313$ S/m; $\epsilon_r = 49.87$; $\rho = 1000$ kg/m³
Phantom section: Flat Section
Ambient temperature: 22.1°C; Liquid temperature: 21.5°C

DASY5 Configuration:

- Probe: EX3DV4 - SN7466; ConvF(4.8, 4.8, 4.8); Calibrated: 2019/2/4
- Sensor-Surface: 2mm (Mechanical Surface Detection)
- Electronics: DAE4 Sn1336; Calibrated: 2019/8/27
- Phantom: ELI
- DASY52 52.10.1(1476); SEMCAD X 14.6.11(7439)

Area Scan (61x81x1): Interpolated grid: dx=10 mm, dy=10 mm

Maximum value of SAR (interpolated) = 15.4 W/kg

Zoom Scan (7x7x12)/Cube 0: Measurement grid: dx=4mm, dy=4mm, dz=2mm

Reference Value = 59.04 V/m; Power Drift = -0.05 dB

Peak SAR (extrapolated) = 30.9 W/kg

SAR(1 g) = 7.27 W/kg; SAR(10 g) = 2.03 W/kg

Maximum value of SAR (measured) = 15.4 W/kg

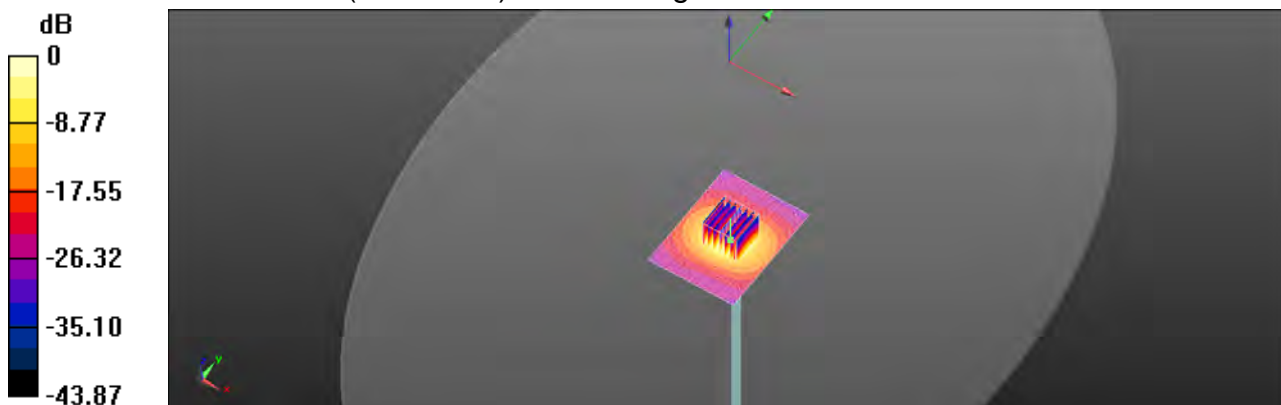

0 dB = 15.4 W/kg = 11.88 dBW/kg

Unless otherwise stated the results shown in this test report refer only to the sample(s) tested and such sample(s) are retained for 90 days only.

除非另有說明，此報告結果僅對測試之樣品負責，同時此樣品僅保留90天。本報告未經本公司書面許可，不可部份複製。

This document is issued by the Company subject to its General Conditions of Service printed overleaf, available on request or accessible at www.sgs.com/terms_and_conditions.htm and for electronic format documents, subject to Terms and Conditions for Electronic Documents at www.sgs.com/terms_e-document.htm. Attention is drawn to the limitation of liability, indemnification and jurisdiction issues defined therein. Any holder of this document is advised that information contained hereon reflects the Company's findings at the time of its intervention only and within the limits of Client's instructions, if any. The Company's sole responsibility is to its Client and this document does not exonerate parties to a transaction from exercising all their rights and obligations under the transaction documents. This document cannot be reproduced except in full, without prior written approval of the Company. Any unauthorized alteration, forgery or falsification of the content or appearance of this document is unlawful and offenders may be prosecuted to the fullest extent of the law.

Date: 2019/11/18

Dipole 5600 MHz_SN:1040

Communication System: CW; Frequency: 5600 MHz; Duty Cycle: 1:1
Medium parameters used: $f = 5600$ MHz; $\sigma = 5.618$ S/m; $\epsilon_r = 49.635$; $\rho = 1000$ kg/m³
Phantom section: Flat Section
Ambient temperature: 22.7°C; Liquid temperature: 21.8°C

DASY5 Configuration:

- Probe: EX3DV4 - SN7466; ConvF(4.22, 4.22, 4.22); Calibrated: 2019/2/4
- Sensor-Surface: 2mm (Mechanical Surface Detection)
- Electronics: DAE4 Sn1336; Calibrated: 2019/8/27
- Phantom: ELI
- DASY52 52.10.1(1476); SEMCAD X 14.6.11(7439)

Area Scan (61x81x1): Interpolated grid: dx=10 mm, dy=10 mm

Maximum value of SAR (interpolated) = 16.5 W/kg

Zoom Scan (7x7x12)/Cube 0: Measurement grid: dx=4mm, dy=4mm, dz=2mm

Reference Value = 59.31 V/m; Power Drift = 0.06 dB

Peak SAR (extrapolated) = 33.4 W/kg

SAR(1 g) = 7.91 W/kg; SAR(10 g) = 2.21 W/kg

Maximum value of SAR (measured) = 16.5 W/kg

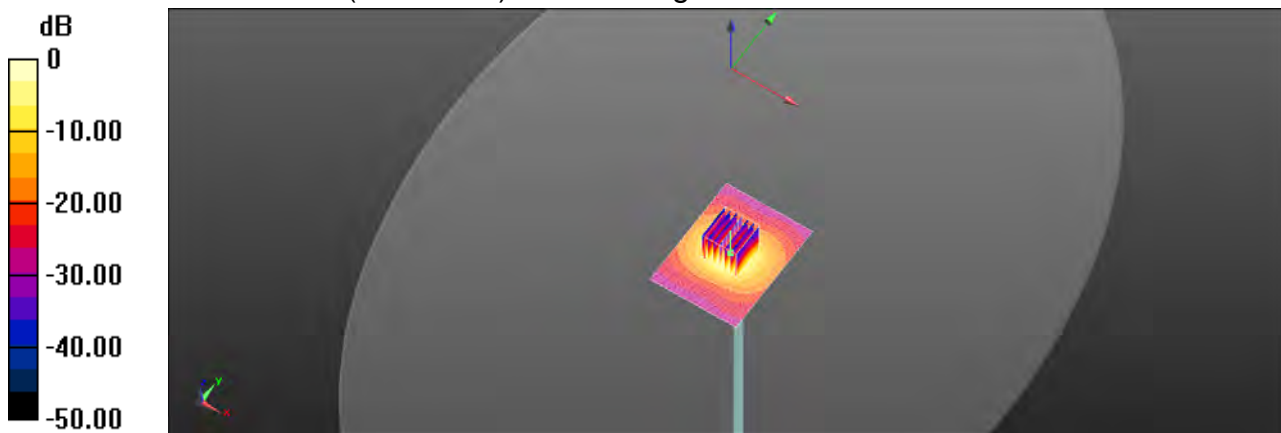

0 dB = 16.5 W/kg = 12.17 dBW/kg

Unless otherwise stated the results shown in this test report refer only to the sample(s) tested and such sample(s) are retained for 90 days only.
除非另有說明，此報告結果僅對測試之樣品負責，同時此樣品僅保留90天。本報告未經本公司書面許可，不可部份複製。

This document is issued by the Company subject to its General Conditions of Service printed overleaf, available on request or accessible at www.sgs.com/terms_and_conditions.htm and for electronic format documents, subject to Terms and Conditions for Electronic Documents at www.sgs.com/terms_e-document.htm. Attention is drawn to the limitation of liability, indemnification and jurisdiction issues defined therein. Any holder of this document is advised that information contained hereon reflects the Company's findings at the time of its intervention only and within the limits of Client's instructions, if any. The Company's sole responsibility is to its Client and this document does not exonerate parties to a transaction from exercising all their rights and obligations under the transaction documents. This document cannot be reproduced except in full, without prior written approval of the Company. Any unauthorized alteration, forgery or falsification of the content or appearance of this document is unlawful and offenders may be prosecuted to the fullest extent of the law.

Date: 2019/11/19

Dipole 5800 MHz_SN:1040

Communication System: CW; Frequency: 5800 MHz; Duty Cycle: 1:1
Medium parameters used: $f = 5800$ MHz; $\sigma = 5.833$ S/m; $\epsilon_r = 49.482$; $\rho = 1000$ kg/m³
Phantom section: Flat Section
Ambient temperature: 22.1°C; Liquid temperature: 21.3°C

DASY5 Configuration:

- Probe: EX3DV4 - SN7466; ConvF(4.38, 4.38, 4.38); Calibrated: 2019/2/4
- Sensor-Surface: 2mm (Mechanical Surface Detection)
- Electronics: DAE4 Sn1336; Calibrated: 2019/8/27
- Phantom: ELI
- DASY52 52.10.1(1476); SEMCAD X 14.6.11(7439)

Area Scan (61x81x1): Interpolated grid: dx=10 mm, dy=10 mm

Maximum value of SAR (interpolated) = 15.7 W/kg

Zoom Scan (7x7x12)/Cube 0: Measurement grid: dx=4mm, dy=4mm, dz=2mm

Reference Value = 56.64 V/m; Power Drift = 0.02 dB

Peak SAR (extrapolated) = 33.1 W/kg

SAR(1 g) = 7.46 W/kg; SAR(10 g) = 2.05 W/kg

Maximum value of SAR (measured) = 15.6 W/kg

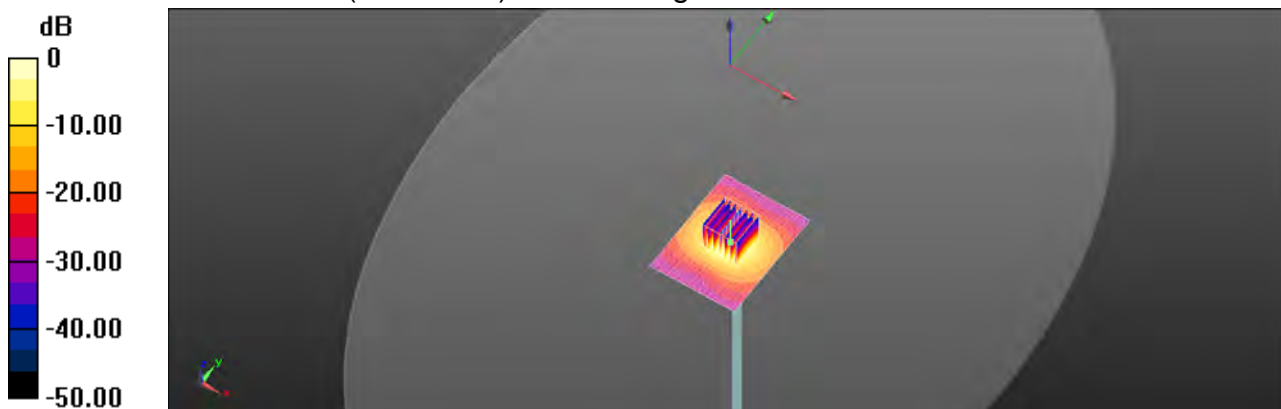

0 dB = 15.6 W/kg = 11.94 dBW/kg

Unless otherwise stated the results shown in this test report refer only to the sample(s) tested and such sample(s) are retained for 90 days only.
除非另有說明，此報告結果僅對測試之樣品負責，同時此樣品僅保留90天。本報告未經本公司書面許可，不可部份複製。

This document is issued by the Company subject to its General Conditions of Service printed overleaf, available on request or accessible at www.sgs.com/terms_and_conditions.htm and for electronic format documents, subject to Terms and Conditions for Electronic Documents at www.sgs.com/terms_e-document.htm. Attention is drawn to the limitation of liability, indemnification and jurisdiction issues defined therein. Any holder of this document is advised that information contained hereon reflects the Company's findings at the time of its intervention only and within the limits of Client's instructions, if any. The Company's sole responsibility is to its Client and this document does not exonerate parties to a transaction from exercising all their rights and obligations under the transaction documents. This document cannot be reproduced except in full, without prior written approval of the Company. Any unauthorized alteration, forgery or falsification of the content or appearance of this document is unlawful and offenders may be prosecuted to the fullest extent of the law.

Date: 2020/1/9

Dipole 5800 MHz_SN:1040

Communication System: CW; Frequency: 5800 MHz; Duty Cycle: 1:1
Medium parameters used: $f = 5800$ MHz; $\sigma = 5.844$ S/m; $\epsilon_r = 49.246$; $\rho = 1000$ kg/m³
Phantom section: Flat Section
Ambient temperature: 22.3°C; Liquid temperature: 21.8°C

DASY5 Configuration:

- Probe: EX3DV4 - SN7466; ConvF(4.38, 4.38, 4.38); Calibrated: 2019/2/4
- Sensor-Surface: 2mm (Mechanical Surface Detection)
- Electronics: DAE4 Sn877; Calibrated: 2019/3/22
- Phantom: ELI
- DASY52 52.10.1(1476); SEMCAD X 14.6.11(7439)

Area Scan (61x91x1): Interpolated grid: dx=10 mm, dy=10 mm

Maximum value of SAR (interpolated) = 14.9 W/kg

Zoom Scan (7x7x12)/Cube 0: Measurement grid: dx=4mm, dy=4mm, dz=2mm

Reference Value = 52.34 V/m; Power Drift = -0.01 dB

Peak SAR (extrapolated) = 28.7 W/kg

SAR(1 g) = 7.43 W/kg; SAR(10 g) = 2.01 W/kg

Maximum value of SAR (measured) = 13.7 W/kg

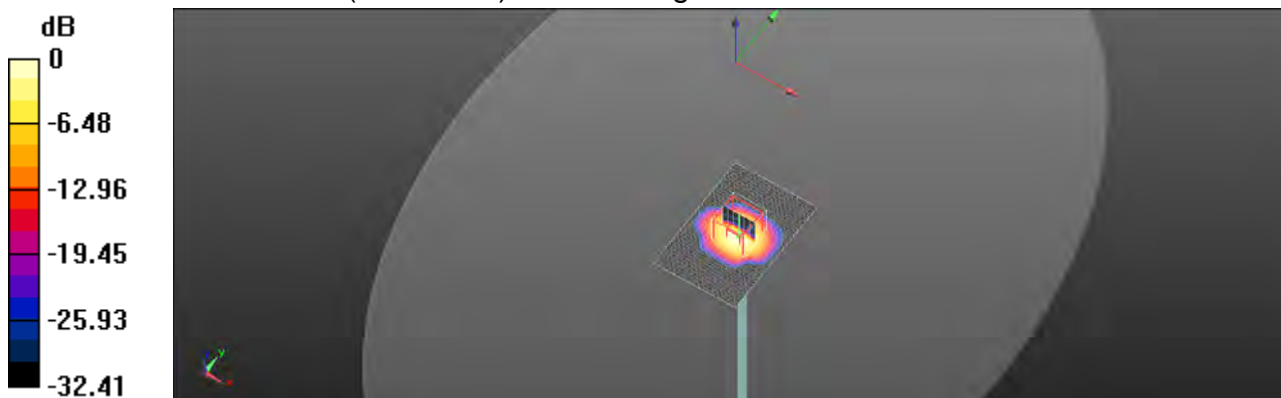

0 dB = 13.7 W/kg = 11.36 dBW/kg

Unless otherwise stated the results shown in this test report refer only to the sample(s) tested and such sample(s) are retained for 90 days only.
除非另有說明，此報告結果僅對測試之樣品負責，同時此樣品僅保留90天。本報告未經本公司書面許可，不可部份複製。

This document is issued by the Company subject to its General Conditions of Service printed overleaf, available on request or accessible at www.sgs.com/terms_and_conditions.htm and for electronic format documents, subject to Terms and Conditions for Electronic Documents at www.sgs.com/terms_e-document.htm. Attention is drawn to the limitation of liability, indemnification and jurisdiction issues defined therein. Any holder of this document is advised that information contained hereon reflects the Company's findings at the time of its intervention only and within the limits of Client's instructions, if any. The Company's sole responsibility is to its Client and this document does not exonerate parties to a transaction from exercising all their rights and obligations under the transaction documents. This document cannot be reproduced except in full, without prior written approval of the Company. Any unauthorized alteration, forgery or falsification of the content or appearance of this document is unlawful and offenders may be prosecuted to the fullest extent of the law.

7. Uncertainty Budget

Measurement Uncertainty evaluation template for DUT SAR test (3-6G)

A	c	D	e		f	g	$h=c * f / e$	$i=c * g / e$	k
Source of Uncertainty	Tolerance/ Uncertainty	Probability Distributio	Div	Div Value	ci (1g)	ci (10g)	Standard uncertainty	Standard uncertainty	v_i , or V_{eff}
Measurement system									
Probe calibration	6.55%	N	1	1	1	1	6.55%	6.55%	∞
<i>Isotropy, Axial</i>	3.50%	R	$\sqrt{3}$	1.732	1	1	2.02%	2.02%	∞
<i>Isotropy, Hemispherical</i>	9.60%	R	$\sqrt{3}$	1.732	1	1	5.54%	5.54%	∞
Modulation Response	2.40%	R	$\sqrt{3}$	1.732	1	1	1.40%	1.40%	∞
Boundary Effect	1.00%	R	$\sqrt{3}$	1.732	1	1	0.58%	0.58%	∞
Linearity	4.70%	R	$\sqrt{3}$	1.732	1	1	2.71%	2.71%	∞
Detection Limits	1.00%	R	$\sqrt{3}$	1.732	1	1	0.58%	0.58%	∞
Readout Electronics	0.30%	N	1	1	1	1	0.30%	0.30%	∞
Response time	0.80%	R	$\sqrt{3}$	1.732	1	1	0.46%	0.46%	∞
Integration Time	2.60%	R	$\sqrt{3}$	1.732	1	1	1.50%	1.50%	∞
Measurement drift (class A evaluation)									
RF ambient condition - noise	3.00%	R	$\sqrt{3}$	1.732	1	1	1.73%	1.73%	∞
RF ambient conditions - reflections	3.00%	R	$\sqrt{3}$	1.732	1	1	1.73%	1.73%	∞
Probe positioner Mechanical restrictions	0.40%	R	$\sqrt{3}$	1.732	1	1	0.23%	0.23%	∞
Probe Positioning with respect to phantom shell	2.90%	R	$\sqrt{3}$	1.732	1	1	1.67%	1.67%	∞
Post-processing	1.00%	R	$\sqrt{3}$	1.732	1	1	0.58%	0.58%	∞
Max SAR Eval	1.00%	R	$\sqrt{3}$	1.732	1	1	0.58%	0.58%	∞
Test Sample related									
Test sample positioning	2.90%	N	1	1	1	1	2.90%	2.90%	M-1
Device Holder Uncertainty	3.60%	N	1	1	1	1	3.60%	3.60%	M-1
Drift of output power	5.00%	R	$\sqrt{3}$	1.732	1	1	2.89%	2.89%	∞
Phantom and Setup									
Phantom Uncertainty	4.00%	R	$\sqrt{3}$	1.732	1	1	2.31%	2.31%	∞
Liquid permittivity (mea.)	2.72%	N	1	1	0.64	0.43	1.74%	1.17%	M
Liquid Conductivity (mea.)	2.83%	N	1	1	0.6	0.49	1.70%	1.39%	M
Combined standard uncertainty		RSS					11.97%	11.85%	
Expant uncertainty (95% confidence interval), K=2							23.93%	23.69%	

Unless otherwise stated the results shown in this test report refer only to the sample(s) tested and such sample(s) are retained for 90 days only.

除非另有說明，此報告結果僅對測試之樣品負責，同時此樣品僅保留90天。本報告未經本公司書面許可，不可部份複製。

 This document is issued by the Company subject to its General Conditions of Service printed overleaf, available on request or accessible at www.sgs.com/terms_and_conditions.htm and for electronic format documents, subject to Terms and Conditions for Electronic Documents at www.sgs.com/terms_e-document.htm. Attention is drawn to the limitation of liability, indemnification and jurisdiction issues defined therein. Any holder of this document is advised that information contained hereon reflects the Company's findings at the time of its intervention only and within the limits of Client's instructions, if any. The Company's sole responsibility is to its Client and this document does not exonerate parties to a transaction from exercising all their rights and obligations under the transaction documents. This document cannot be reproduced except in full, without prior written approval of the Company. Any unauthorized alteration, forgery or falsification of the content or appearance of this document is unlawful and offenders may be prosecuted to the fullest extent of the law.

Measurement Uncertainty evaluation template for DUT SAR test (0.3-3G)

A	c	D	e		f	g	$h=c * f / e$	$i=c * g / e$	k
Source of Uncertainty	Tolerance/ Uncertainty	Probability Distributio	Div	Div Value	ci (1g)	ci (10g)	Standard uncertainty	Standard uncertainty	vi, or Veff
Measurement system									
Probe calibration	6.00%	N	1	1	1	1	6.00%	6.00%	∞
<i>Isotropy, Axial</i>	3.50%	R	$\sqrt{3}$	1.732	1	1	2.02%	2.02%	∞
<i>Isotropy, Hemispherical</i>	9.60%	R	$\sqrt{3}$	1.732	1	1	5.54%	5.54%	∞
Modulation Response	2.40%	R	$\sqrt{3}$	1.732	1	1	1.40%	1.40%	∞
Boundary Effect	1.00%	R	$\sqrt{3}$	1.732	1	1	0.58%	0.58%	∞
Linearity	4.70%	R	$\sqrt{3}$	1.732	1	1	2.71%	2.71%	∞
Detection Limits	1.00%	R	$\sqrt{3}$	1.732	1	1	0.58%	0.58%	∞
Readout Electronics	0.30%	N	1	1	1	1	0.30%	0.30%	∞
Response time	0.80%	R	$\sqrt{3}$	1.732	1	1	0.46%	0.46%	∞
Integration Time	2.60%	R	$\sqrt{3}$	1.732	1	1	1.50%	1.50%	∞
Measurement drift (class A evaluation)	1.75%	R	$\sqrt{3}$	1.732	1	1	1.01%	1.01%	∞
RF ambient condition - noise	3.00%	R	$\sqrt{3}$	1.732	1	1	1.73%	1.73%	∞
RF ambient conditions - reflections	3.00%	R	$\sqrt{3}$	1.732	1	1	1.73%	1.73%	∞
Probe positioner Mechanical restrictions	0.40%	R	$\sqrt{3}$	1.732	1	1	0.23%	0.23%	∞
Probe Positioning with respect to phantom shell	2.90%	R	$\sqrt{3}$	1.732	1	1	1.67%	1.67%	∞
Post-processing	1.00%	R	$\sqrt{3}$	1.732	1	1	0.58%	0.58%	∞
Max SAR Eval	1.00%	R	$\sqrt{3}$	1.732	1	1	0.58%	0.58%	∞
Test Sample related									
Test sample positioning	2.90%	N	1	1	1	1	2.90%	2.90%	M-1
Device Holder Uncertainty	3.60%	N	1	1	1	1	3.60%	3.60%	M-1
Drift of output power	5.00%	R	$\sqrt{3}$	1.732	1	1	2.89%	2.89%	∞
Phantom and Setup									
Phantom Uncertainty	4.00%	R	$\sqrt{3}$	1.732	1	1	2.31%	2.31%	∞
Liquid permittivity (mea.)	2.51%	N	1	1	0.64	0.43	1.61%	1.08%	M
Liquid Conductivity (mea.)	2.85%	N	1	1	0.6	0.49	1.71%	1.40%	M
Combined standard uncertainty		RSS					11.66%	11.54%	
Expant uncertainty (95% confidence interval), K=2							23.31%	23.09%	

Unless otherwise stated the results shown in this test report refer only to the sample(s) tested and such sample(s) are retained for 90 days only.

除非另有說明，此報告結果僅對測試之樣品負責，同時此樣品僅保留90天。本報告未經本公司書面許可，不可部份複製。

This document is issued by the Company subject to its General Conditions of Service printed overleaf, available on request or accessible at www.sgs.com/terms_and_conditions.htm and for electronic format documents, subject to Terms and Conditions for Electronic Documents at www.sgs.com/terms_e-document.htm. Attention is drawn to the limitation of liability, indemnification and jurisdiction issues defined therein. Any holder of this document is advised that information contained hereon reflects the Company's findings at the time of its intervention only and within the limits of Client's instructions, if any. The Company's sole responsibility is to its Client and this document does not exonerate parties to a transaction from exercising all their rights and obligations under the transaction documents. This document cannot be reproduced except in full, without prior written approval of the Company. Any unauthorized alteration, forgery or falsification of the content or appearance of this document is unlawful and offenders may be prosecuted to the fullest extent of the law.

Appendixes

Refer to separated files for the following appendixes.

E5201990011 SAR_Appendix A Photographs

E5201990011 SAR_Appendix B DAE & Probe Cal. Certificate

E5201990011 SAR_Appendix C Phantom Description & Dipole Cal. Certificate

- End of report -

Unless otherwise stated the results shown in this test report refer only to the sample(s) tested and such sample(s) are retained for 90 days only.
除非另有說明，此報告結果僅對測試之樣品負責，同時此樣品僅保留90天。本報告未經本公司書面許可，不可部份複製。

This document is issued by the Company subject to its General Conditions of Service printed overleaf, available on request or accessible at www.sgs.com/terms_and_conditions.htm and for electronic format documents, subject to Terms and Conditions for Electronic Documents at www.sgs.com/terms_e-document.htm. Attention is drawn to the limitation of liability, indemnification and jurisdiction issues defined therein. Any holder of this document is advised that information contained hereon reflects the Company's findings at the time of its intervention only and within the limits of Client's instructions, if any. The Company's sole responsibility is to its Client and this document does not exonerate parties to a transaction from exercising all their rights and obligations under the transaction documents. This document cannot be reproduced except in full, without prior written approval of the Company. Any unauthorized alteration, forgery or falsification of the content or appearance of this document is unlawful and offenders may be prosecuted to the fullest extent of the law.